



RF TEST REPORT

Applicant Quectel Wireless Solutions Co., Ltd.
FCC ID XMR201707BG96
Product Quectel BG96
Brand Quectel
Model BG96
Report No. R2003A0151-R6
Issue Date August 18, 2020

TA Technology (Shanghai) Co., Ltd. tested the above equipment in accordance with the requirements in **FCC CFR47 Part 2 (2019)/ FCC CFR47 Part 27C (2019)**. The test results show that the equipment tested is capable of demonstrating compliance with the requirements as documented in this report.

Performed by: Peng Tao

Approved by: Kai Xu

TA Technology (Shanghai) Co., Ltd.

No.145, Jintang Rd, Tangzhen Industry Park, Pudong Shanghai, China

TEL: +86-021-50791141/2/3

FAX: +86-021-50791141/2/3-8000

Table of Contents

1	Test Laboratory.....	4
1.1	Notes of the Test Report.....	4
1.2	Test facility.....	4
1.3	Testing Location.....	5
2	General Description of Equipment under Test.....	6
2.1	Applied Standards.....	7
3	Test Configuration.....	8
4	Test Information.....	10
4.1	RF Power Output.....	10
4.2	Effective Isotropic Radiated Power.....	13
4.3	Occupied Bandwidth.....	20
4.4	Band Edge Compliance.....	36
4.5	Peak-to-Average Power Ratio (PAPR).....	55
4.6	Frequency Stability.....	58
4.7	Spurious Emissions at Antenna Terminals.....	65
4.8	Radiates Spurious Emission.....	81
5	Main Test Instruments.....	102

Summary of Measurement Results

Number	Test Case	Clause in FCC rules	Verdict
1	RF power output	2.1046	Refer to the Original
2	Effective Isotropic Radiated power	27.50(d)(4) /27.50(b)(10) /27.50(c)(10)	Refer to the Original
3	Occupied Bandwidth	2.1049	Refer to the Original
4	Band Edge Compliance	27.53(h) /27.53(g)	Only test LTE Band
5	Peak-to-Average Power Ratio	27.50(d)/KDB971168 D01(5.7)	Refer to the Original
6	Frequency Stability	2.1055 / 27.54	Refer to the Original
7	Spurious Emissions at Antenna Terminals	2.1051 /27.53(h)/27.53(g)/27.53(f)	Refer to the Original
8	Radiates Spurious Emission	2.1053 /27.53(h)/27.53(g)/27.53(f)	Refer to the Original
Date of Testing: June 24, 2017~ July 3, 2017 and August10, 2020 ~ August12, 2020			
Note: PASS: The EUT complies with the essential requirements in the standard. FAIL: The EUT does not comply with the essential requirements in the standard.			

BG96 (Report No.: R2003A0151-R6) is a variant model of BG96 (Report No.: RXA1706-0199RF03R1). Test values partial duplicated from original for variant. There is only tested Band Edge Compliance of LTE Band for variant in this report. The detailed product change description please refers to the Statement letter_BG96.

1 Test Laboratory

1.1 Notes of the Test Report

This report shall not be reproduced in full or partial, without the written approval of **TA technology (shanghai) co., Ltd.** The results documented in this report apply only to the tested sample, under the conditions and modes of operation as described herein .Measurement Uncertainties were not taken into account and are published for informational purposes only. This report is written to support regulatory compliance of the applicable standards stated above. This report must not be used by the client to claim product certification, approval, or endorsement by any government agencies.

1.2 Test facility

FCC (recognition number is 428261)

TA Technology (Shanghai) Co., Ltd. has been listed on the US Federal Communications Commission list of test facilities recognized to perform electromagnetic emissions measurements.

A2LA (Certificate Number: 3857.01)

TA Technology (Shanghai) Co., Ltd. has been listed by American Association for Laboratory Accreditation to perform electromagnetic emission measurement.

1.3 Testing Location

Company: TA Technology (Shanghai) Co., Ltd.
Address: No.145, Jintang Rd, Tangzhen Industry Park, Pudong Shanghai, China
City: Shanghai
Post code: 201201
Country: P. R. China
Contact: Xu Kai
Telephone: +86-021-50791141/2/3
Fax: +86-021-50791141/2/3-8000
Website: <http://www.ta-shanghai.com>
E-mail: xukai@ta-shanghai.com

2 General Description of Equipment under Test

Client Information

Applicant	Quectel Wireless Solutions Co., Ltd.
Applicant address	7th Floor, Hongye Building, No. 1801 Hongmei Road, Xuhui District, Shanghai, China
Manufacturer	Quectel Wireless Solutions Co., Ltd.
Manufacturer address	7th Floor, Hongye Building, No. 1801 Hongmei Road, Xuhui District, Shanghai, China

General information

EUT Description			
Model:	BG96		
IMEI:	864508030012063		
Hardware Version:	R1.0		
Software Version:	BG96MAR02A09M1G		
Power Supply:	External power supply		
Antenna Type:	The EUT don't have standard Antenna, The Antenna used for testing in this report is the after-market accessory (Dipole Antenna)		
Test Mode(s):	LTE Band 4; LTE Band 12, LTE Band 13;		
Test Modulation	QPSK 16QAM;		
LTE Category	M1		
Maximum E.I.R.P./ E.R.P.	LTE Band 4: 29.98dBm LTE Band 12:27.92dBm LTE Band 13: 27.70dBm		
Rated Power Supply Voltage:	3.8V		
Extreme Voltage:	Minimum: 3.3V Maximum: 4.3V		
Extreme Temperature:	Lowest: -40°C Highest: +85°C		
Frequency Range(s)	Mode	Tx (MHz)	Rx (MHz)
	LTE Band 4	1710 ~1755	2110~2155
	LTE Band 12	699 ~ 716	729 ~ 746
	LTE Band 13	777 ~ 787	746 ~ 756
Note: 1. The information of the EUT is declared by the manufacturer.			

2.1 Applied Standards

According to the specifications of the manufacturer, it must comply with the requirements of the following standards:

Test standards:

FCC CFR47 Part 27C (2019)

ANSI C63.26 (2015)

Reference standard:

FCC CFR47 Part 2 (2019)

KDB 971168 D01 Power Meas License Digital Systems v03r01

3 Test Configuration

Radiated measurements are performed by rotating the EUT in three different orthogonal test planes. EUT lie-down stand-up position (X, Y axis), lie-down position (Z axis),. Receiver antenna polarization (horizontal and vertical), the worst emission was found in position (Z axis, vertical polarization) and the worst case was recorded.

All mode and data rates and positions and RB size and modulations were investigated. Subsequently, only the worst case emissions are reported.

The following testing in LTE is set based on the maximum RF Output Power.

The following testing in different Bandwidth is set to detail in the following table:

Test modes are chosen to be reported as the worst case configuration below for LTE Band 4/12/13:

Test items	Modes	Bandwidth (MHz)						Modulation		RB			Test Channel		
		1.4	3	5	10	15	20	QPSK	16QAM	1	50%	100%	L	M	H
RF power output	LTE 4	O	O	O	O	O	O	O	O	O	O	O	O	O	O
	LTE 12	O	O	O	O	-	-	O	O	O	O	O	O	O	O
	LTE 13	-	-	O	O	-	-	O	O	O	O	O	O	O	O
Effective Isotropic Radiated power	LTE 4	O	O	O	O	O	O	O	O	-	-	O	O	O	O
	LTE 12	O	O	O	O	-	-	O	O	-	-	O	O	O	O
	LTE 13	-	-	O	O	-	-	O	O	-	-	O	O	O	O
Occupied Bandwidth	LTE 4	O	O	O	O	O	O	O	O	-	-	O	O	O	O
	LTE 12	O	O	O	O	-	-	O	O	-	-	O	O	O	O
	LTE 13	-	-	O	O	-	-	O	O	-	-	O	O	O	O
Band Edge Compliance	LTE 4	O	O	O	O	O	O	O	O	O	-	O	O	-	O
	LTE 12	O	O	O	O	-	-	O	O	O	-	O	O	-	O
	LTE 13	-	-	O	O	-	-	O	O	O	-	O	O	-	O
Peak-to-Average Power Ratio	LTE 4	O	O	O	O	O	O	O	O	-	-	O	O	O	O
	LTE 12	O	O	O	O	-	-	O	O	-	-	O	O	O	O
	LTE 13	-	-	O	O	-	-	O	O	-	-	O	O	O	O
Frequency Stability	LTE 4	O	O	O	O	O	O	O	O	-	-	O	-	O	-
	LTE 12	O	O	O	O	-	-	O	O	-	-	O	-	O	-
	LTE 13	-	-	O	O	-	-	O	O	-	-	O	-	O	-
Spurious Emissions at Antenna Terminals	LTE 4	O	O	O	O	O	O	O	-	O	-	-	O	O	O
	LTE 12	O	O	O	O	-	-	O	-	O	-	-	O	O	O
	LTE 13	-	-	O	O	-	-	O	-	O	-	-	O	O	O



Radiates Spurious Emission	LTE 4	O	O	O	O	O	O	O	-	O	-	-	O	O	O
	LTE 12	O	O	O	O	-	-	O	-	O	-	-	O	O	O
	LTE 13	-	-	O	O	-	-	O	-	O	-	-	O	O	O
Note	<p>1. The mark "O" means that this configuration is chosen for testing.</p> <p>2. The mark "-" means that this configuration is not testing.</p>														

4 Test Information

4.1 RF Power Output

Ambient condition

Temperature	Relative humidity	Pressure
23°C ~25°C	45%~50%	101.5kPa

Methods of Measurement

During the process of the testing, The EUT is controlled by the Base Station Simulator to ensure max power transmission and proper modulation.

Test Setup

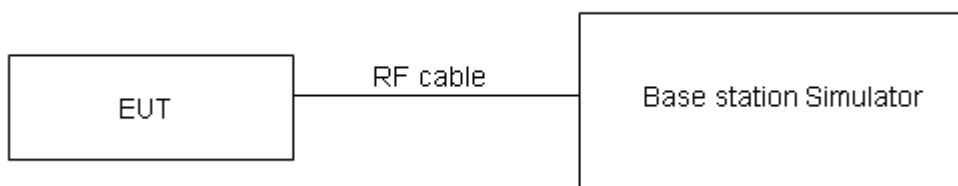

The loss between RF output port of the EUT and the input port of the tester has been taken into consideration.

Limits

No specific RF power output requirements in part 2.1046.

Measurement Uncertainty

The assessed measurement uncertainty to ensure 95% confidence level for the normal distribution is with the coverage factor $k = 2$, $U=0.4$ dB.

Test Results

Mode	Bandwidth	Channel/ Frequency(MHz)	Index	RB# RBstart	Conducted Power (dBm)	
					QPSK	16QAM
Band4	1.4MHz	19957/1710.7	0	1#0	22.38	21.94
			0	6#0	22.13	22.06
		20175/1732.5	0	1#0	22.31	22.02
			0	6#0	22.09	22.03
		20393/1754.3	0	1#5	22.37	22.13
			0	6#0	22.23	22.21
	3MHz	19965/1711.5	0	1#0	22.40	21.97
			0	6#0	22.16	22.09
		20175/1732.5	0	1#0	22.35	22.04
			0	6#0	22.13	22.07
		20385/1753.5	1	1#5	22.40	22.16
			1	6#0	22.26	22.24
	5MHz	19975/1712.5	3	1#0	22.37	21.94
			0	6#0	22.14	22.07
		20175/1732.5	0	1#0	22.33	22.00
			0	6#0	22.12	22.03
		20375/1752.5	0	1#5	22.36	22.13
			3	6#0	22.24	22.19
	10MHz	20000/1715	3	1#0	22.39	21.96
			0	4#0	22.22	22.10
		20175/1732.5	0	1#0	22.34	22.03
			0	4#0	22.14	22.08
		20350/1750	4	1#5	22.39	22.15
			7	4#2	22.28	22.23
	15MHz	20025/1717.5	3	1#0	22.38	21.91
			0	6#0	22.20	22.07
		20175/1732.5	0	1#0	22.30	22.01
			0	6#0	22.10	22.03
		20325/1747.5	8	1#5	22.37	22.13
			11	6#0	22.23	22.19
20MHz	20050/1720	3	1#0	22.35	21.89	
		0	6#0	22.17	22.05	
	20175/1732.5	0	1#0	22.26	21.97	
		0	6#0	22.05	21.99	
	20300/1745	12	1#5	22.34	22.08	
		15	6#0	22.19	22.16	

Mode	Bandwidth	Channel/ Frequency(MHz)	Index	RB# RBstart	Conducted Power (dBm)	
					QPSK	16QAM
Band12	1.4MHz	23017/699.7	0	1#0	22.74	23.23
			0	6#0	22.48	22.71
		23095/707.5	0	1#0	23.12	22.81
			0	6#0	22.66	22.90
		23173/715.3	0	1#5	23.37	23.02
			0	6#0	22.64	22.79
	3MHz	23025/700.5	0	1#0	22.76	23.25
			0	6#0	22.56	22.74
		23095/707.5	0	1#0	23.13	22.84
			0	6#0	22.68	22.95
		23165/714.5	1	1#5	23.40	23.04
			1	6#0	22.68	22.83
	5MHz	23035/701.5	3	1#0	22.75	23.20
			0	6#0	22.54	22.71
		23095/707.5	0	1#0	23.09	22.82
			0	6#0	22.64	22.90
		23155/713.5	0	1#5	23.38	23.02
			3	6#0	22.63	22.79
	10MHz	23060/704	3	1#0	22.72	23.18
			0	4#0	22.51	22.69
		23095/707.5	0	1#0	23.05	22.78
			0	4#0	22.59	22.86
		23130/711	4	1#5	23.35	22.97
			7	4#2	22.59	22.76

Mode	Bandwidth	Channel/ Frequency(MHz)	Index	RB# RBstart	Conducted Power (dBm)	
					QPSK	16QAM
Band13	5MHz	23205/779.5	3	1#0	23.10	23.81
			0	6#0	22.80	21.84
		23230/782	0	1#0	23.32	23.14
			0	6#0	22.68	22.19
		23255/784.5	0	1#5	23.11	23.72
			3	6#0	22.67	21.93
	10MHz	23230/782	0	1#0	23.07	23.70
			0	4#0	22.77	22.95

4.2 Effective Isotropic Radiated Power

Ambient condition

Temperature	Relative humidity	Pressure
23°C ~25°C	45%~50%	101.5kPa

Methods of Measurement

- The testing follows ANSI C63.26 (2015)Section5.5.2.3.
- Above 30MHz: The EUT is placed on a turntable 0.8 meters above the ground in the chamber, 3 meter away from the antenna. The maximal emission value is acquired by adjusting the antenna height, polarisation and turntable azimuth. Normally, the height range of antenna is 1 m to 4 m, the azimuth range of turntable is 0° to 360°,and the receive antenna has two polarizations Vertical (V) and Horizontal (H).Above 1GHz:(Note: the FCC’s permission to use 1.5m as an alternative per TCBC Conf call of Dec. 2, 2014.)The EUT is placed on a turntable 1.5 meters above the ground in the chamber, 3 meter away from the antenna. The maximal emission value is acquired by adjusting the antenna height, polarisation and turntable azimuth. Normally, the height range of antenna is 1 m to 4 m, the azimuth range of turntable is 0° to 360°, and the receive antenna has two polarizations Vertical (V) and Horizontal (H).
- A log-periodic antenna or double-ridged waveguide horn antenna shall be substituted in place of the EUT. The log-periodic antenna will be driven by a signal generator and the level will be adjusted till the same power value on the spectrum analyzer or receiver. The level of the spurious emissions can be calculated through the level of the signal generator, cable loss, the gain of the substitution antenna and the reading of the spectrum analyzer or receiver.
- The EUT is then put into continuously transmitting mode at its maximum power level during the test. Set Test Receiver or Spectrum RBW=1MHz,VBW=3MHz, And the maximum value of the receiver should be recorded as (Pr).
- The EUT shall be replaced by a substitution antenna. In the chamber, an substitution antenna for the frequency band of interest is placed at the reference point of the chamber. An RF Signal source for the frequency band of interest is connected to the substitution antenna with a cable that has been constructed to not interfere with the radiation pattern of the antenna. A power (PMea) is applied to the input of the substitution antenna, and adjust the level of the signal generator output until the value of the receiver reach the previously recorded (Pr). The power of signal source (PMea) is recorded. The test should be performed by rotating the test item and adjusting the receiving antenna polarization.
- A amplifier should be connected to the Signal Source output port. And the cable should be connect between the Amplifier and the Substitution Antenna. The cable loss (Pcl) ,the Substitution Antenna Gain(Ga) and the Amplifier Gain (PAG) should be recorded after test.
- The measurement results are obtained as described below:

$$\text{Power(EIRP)} = \text{PMea} - \text{PAG} - \text{Pcl} + \text{Ga}$$
The measurement results are amend as described below:

$$\text{Power(EIRP)} = \text{PMea} - \text{Pcl} + \text{Ga}$$
- This value is EIRP since the measurement is calibrated using an antenna of known gain (2.15 dBi) and known input power.ERP can be calculated from EIRP by subtracting the gain of the dipole, $\text{ERP} = \text{EIRP} - 2.15\text{dBi}$.

Test setup

30MHz~~~ 1GHz

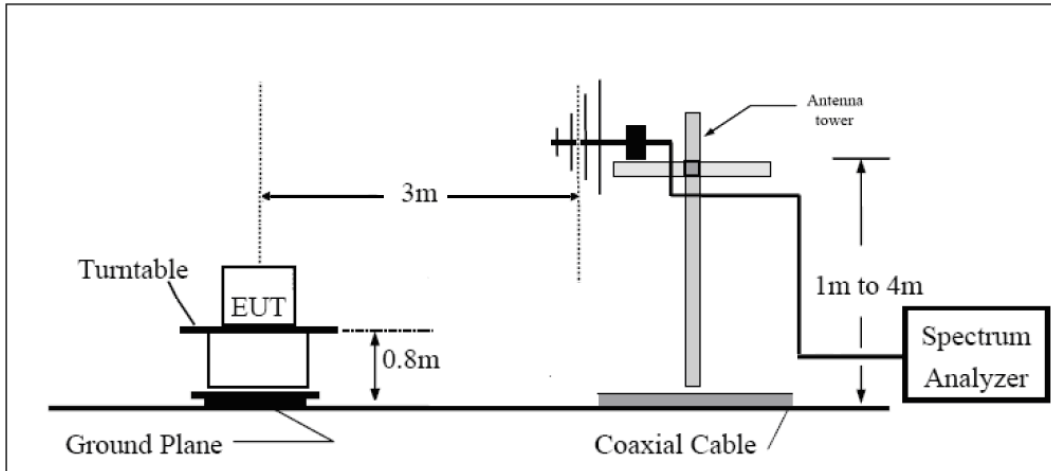

Above 1GHz

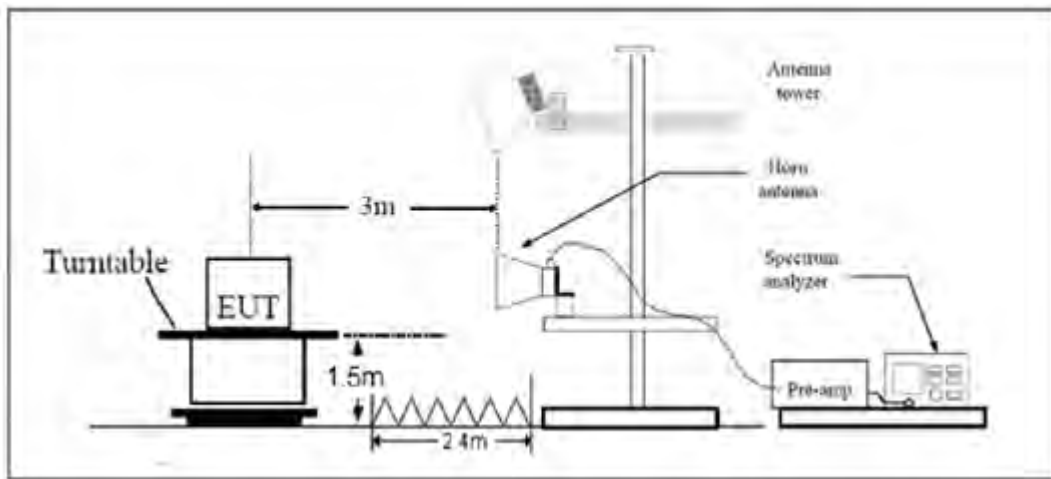

Note: Area side:2.4mX3.6m

Limits

Rule Part 27.50(b) (10) specifies that “Portable stations (hand-held devices) transmitting in the 746-757 MHz, 776-788 MHz, and 805-806 MHz bands are limited to 3 watts ERP”

Rule Part 27.50(c) (10) specifies that “Portable stations (hand-held devices) in the 600 MHz uplink band and the 698-746 MHz band, and fixed and mobile stations in the 600 MHz uplink band are limited to 3 watts ERP”

Rule Part 27.50(d) (4) specifies that “Fixed, mobile and portable (hand-held) stations operating in the 1710–1755 MHz band are limited to 1 watt EIRP”

Part 27.50(b)(10)Limit (ERP)	≤ 3 W (34.77 dBm)
Part 27.50(c)(10)Limit (ERP)	≤ 3 W (34.77 dBm)
Part 27.50(d)(4)Limit (EIRP)	≤ 1 W (30 dBm)

Measurement Uncertainty

The assessed measurement uncertainty to ensure 95% confidence level for the normal distribution is with the coverage factor $k = 2$, $U = 1.19$ dB

Test Results

LTE Band 4								
Bandwidth	Frequency (MHz)	Ant Pot (H/V)	Rt (dBm)	Rs (dBm)	Ps (dBm)	Gs (dBi)	EIRP (dBm)	Conclusion
1.4MHz (QPSK)	1710.7	H	-26.70	-54.30	0.00	1.44	29.04	Pass
	1732.5	H	-26.63	-54.32	0.00	1.57	29.25	Pass
	1754.3	H	-26.30	-54.10	0.00	1.72	29.52	Pass
	1710.7	V	-28.67	-54.35	0.00	1.44	27.12	Pass
	1732.5	V	-29.08	-54.41	0.00	1.57	26.90	Pass
	1754.3	V	-29.95	-54.52	0.00	1.72	26.29	Pass
1.4MHz (16QAM)	1710.7	H	-26.02	-54.30	0.00	1.44	29.72	Pass
	1732.5	H	-25.94	-54.32	0.00	1.57	29.94	Pass
	1754.3	H	-26.61	-54.10	0.00	1.72	29.21	Pass
	1710.7	V	-28.98	-54.35	0.00	1.44	26.81	Pass
	1732.5	V	-29.38	-54.41	0.00	1.57	26.60	Pass
	1754.3	V	-30.25	-54.52	0.00	1.72	25.99	Pass
3MHz (QPSK)	1711.5	H	-26.52	-54.33	0.00	1.44	29.25	Pass
	1732.5	H	-25.90	-54.32	0.00	1.57	29.98	Pass
	1753.5	H	-26.51	-54.11	0.00	1.72	29.32	Pass
	1711.5	V	-28.89	-54.35	0.00	1.44	26.90	Pass
	1732.5	V	-29.30	-54.41	0.00	1.57	26.68	Pass
	1753.5	V	-29.82	-54.48	0.00	1.72	26.38	Pass
3MHz (16QAM)	1711.5	H	-25.82	-54.33	0.00	1.44	29.95	Pass
	1732.5	H	-26.22	-54.32	0.00	1.57	29.66	Pass
	1753.5	H	-26.82	-54.11	0.00	1.72	29.01	Pass
	1711.5	V	-29.19	-54.35	0.00	1.44	26.60	Pass
	1732.5	V	-29.63	-54.41	0.00	1.57	26.35	Pass
	1753.5	V	-30.15	-54.48	0.00	1.72	26.05	Pass
5MHz (QPSK)	1712.5	H	-26.05	-54.34	0.00	1.44	29.73	Pass
	1732.5	H	-26.70	-54.32	0.00	1.57	29.18	Pass
	1752.5	H	-26.55	-54.13	0.00	1.72	29.29	Pass
	1712.5	V	-29.08	-54.38	0.00	1.44	26.74	Pass
	1732.5	V	-29.47	-54.41	0.00	1.57	26.51	Pass
	1752.5	V	-29.74	-54.47	0.00	1.72	26.45	Pass
5MHz (16QAM)	1712.5	H	-26.37	-54.34	0.00	1.44	29.41	Pass
	1732.5	H	-26.33	-54.32	0.00	1.57	29.55	Pass
	1752.5	H	-26.84	-54.13	0.00	1.72	29.00	Pass
	1712.5	V	-29.40	-54.38	0.00	1.44	26.42	Pass
	1732.5	V	-29.77	-54.41	0.00	1.57	26.21	Pass
	1752.5	V	-30.04	-54.47	0.00	1.72	26.15	Pass
10MHz (QPSK)	1715	H	-26.72	-54.33	0.00	1.44	29.05	Pass
	1732.5	H	-26.64	-54.32	0.00	1.57	29.24	Pass
	1750	H	-26.31	-54.12	0.00	1.66	29.47	Pass



	1715	V	-29.72	-54.32	0.00	1.44	26.04	Pass
	1732.5	V	-30.17	-54.41	0.00	1.57	25.81	Pass
	1750	V	-30.45	-54.52	0.00	1.66	25.73	Pass
10MHz (16QAM)	1715	H	-27.07	-54.33	0.00	1.44	28.70	Pass
	1732.5	H	-26.96	-54.32	0.00	1.57	28.92	Pass
	1750	H	-26.63	-54.12	0.00	1.66	29.15	Pass
	1715	V	-30.04	-54.32	0.00	1.44	25.72	Pass
	1732.5	V	-30.48	-54.41	0.00	1.57	25.50	Pass
	1750	V	-30.77	-54.52	0.00	1.66	25.41	Pass
15MHz (QPSK)	1717.5	H	-28.55	-54.35	0.00	1.49	27.28	Pass
	1732.5	H	-28.08	-54.32	0.00	1.57	27.80	Pass
	1747.5	H	-27.90	-54.17	0.00	1.66	27.93	Pass
	1717.5	V	-28.97	-54.39	0.00	1.49	26.91	Pass
	1732.5	V	-29.69	-54.41	0.00	1.57	26.29	Pass
	1747.5	V	-29.66	-54.51	0.00	1.66	26.51	Pass
15MHz (16QAM)	1717.5	H	-28.86	-54.35	0.00	1.49	26.97	Pass
	1732.5	H	-28.38	-54.32	0.00	1.57	27.50	Pass
	1747.5	H	-28.21	-54.17	0.00	1.66	27.62	Pass
	1717.5	V	-29.28	-54.39	0.00	1.49	26.60	Pass
	1732.5	V	-30.00	-54.41	0.00	1.57	25.98	Pass
	1747.5	V	-29.97	-54.51	0.00	1.66	26.20	Pass
20MHz (QPSK)	1720	H	-29.21	-54.37	0.00	1.49	26.65	Pass
	1732.5	H	-28.93	-54.32	0.00	1.57	26.95	Pass
	1745	H	-29.80	-54.23	0.00	1.63	26.06	Pass
	1720	V	-30.22	-54.44	0.00	1.49	25.71	Pass
	1732.5	V	-30.37	-54.41	0.00	1.57	25.61	Pass
	1745	V	-30.72	-54.59	0.00	1.63	25.50	Pass
20MHz (16QAM)	1720	H	-29.54	-54.37	0.00	1.49	26.32	Pass
	1732.5	H	-29.25	-54.32	0.00	1.57	26.63	Pass
	1745	H	-30.11	-54.23	0.00	1.63	25.75	Pass
	1720	V	-30.53	-54.44	0.00	1.49	25.40	Pass
	1732.5	V	-30.69	-54.41	0.00	1.57	25.29	Pass
	1745	V	-31.02	-54.59	0.00	1.63	25.20	Pass

LTE Band 12								
bandwidth	Frequency (MHz)	Ant Pot (H/V)	Rt (dBm)	Rs (dBm)	Ps (dBm)	Gs (dBi)	ERP (dBm)	Conclusion
1.4MHz (QPSK)	699.7	H	-25.65	-49.12	0.00	2.04	25.51	Pass
	707.5	H	-25.33	-49.39	0.00	2.03	26.10	Pass
	715.3	H	-23.83	-49.76	0.00	1.99	27.92	Pass
	699.7	V	-23.87	-48.91	0.00	2.04	27.09	Pass
	707.5	V	-23.44	-49.12	0.00	2.03	27.71	Pass



	715.3	V	-23.74	-49.43	0.00	1.99	27.69	Pass
1.4MHz (16QAM)	699.7	H	-25.98	-49.12	0.00	2.04	25.18	Pass
	707.5	H	-25.63	-49.39	0.00	2.03	25.80	Pass
	715.3	H	-24.15	-49.76	0.00	1.99	27.60	Pass
	699.7	V	-24.18	-48.91	0.00	2.04	26.78	Pass
	707.5	V	-23.75	-49.12	0.00	2.03	27.40	Pass
	715.3	V	-24.08	-49.43	0.00	1.99	27.35	Pass
	3MHz (QPSK)	700.5	H	-25.69	-49.15	0.00	2.04	25.50
707.5		H	-24.64	-49.39	0.00	2.03	26.79	Pass
714.5		H	-23.94	-49.73	0.00	2.00	27.79	Pass
700.5		V	-23.15	-48.94	0.00	2.04	27.83	Pass
707.5		V	-23.44	-49.12	0.00	2.03	27.71	Pass
714.5		V	-23.70	-49.37	0.00	2.00	27.67	Pass
3MHz (16QAM)	700.5	H	-26.02	-49.15	0.00	2.04	25.17	Pass
	707.5	H	-24.98	-49.39	0.00	2.03	26.45	Pass
	714.5	H	-24.26	-49.73	0.00	2.00	27.47	Pass
	700.5	V	-23.48	-48.94	0.00	2.04	27.50	Pass
	707.5	V	-23.74	-49.12	0.00	2.03	27.41	Pass
	714.5	V	-24.01	-49.37	0.00	2.00	27.36	Pass
5MHz (QPSK)	701.5	H	-25.86	-49.17	0.00	2.04	25.36	Pass
	707.5	H	-25.11	-49.39	0.00	2.03	26.32	Pass
	713.5	H	-24.42	-49.72	0.00	2.01	27.30	Pass
	701.5	V	-23.32	-48.95	0.00	2.04	27.67	Pass
	707.5	V	-23.73	-49.12	0.00	2.03	27.42	Pass
	713.5	V	-23.96	-49.35	0.00	2.01	27.40	Pass
5MHz (16QAM)	701.5	H	-26.15	-49.17	0.00	2.04	25.07	Pass
	707.5	H	-25.43	-49.39	0.00	2.03	26.00	Pass
	713.5	H	-24.74	-49.72	0.00	2.01	26.98	Pass
	701.5	V	-23.64	-48.95	0.00	2.04	27.35	Pass
	707.5	V	-24.05	-49.12	0.00	2.03	27.10	Pass
	713.5	V	-24.28	-49.35	0.00	2.01	27.08	Pass
10MHz (QPSK)	704	H	-26.59	-49.25	0.00	2.04	24.70	Pass
	707.5	H	-25.99	-49.39	0.00	2.03	25.44	Pass
	711	H	-25.70	-49.65	0.00	2.02	25.97	Pass
	704	V	-24.14	-49.00	0.00	2.04	26.90	Pass
	707.5	V	-24.12	-49.12	0.00	2.03	27.03	Pass
	711	V	-24.67	-49.33	0.00	2.02	26.67	Pass
10MHz (16QAM)	704	H	-26.89	-49.25	0.00	2.04	24.40	Pass
	707.5	H	-26.33	-49.39	0.00	2.03	25.10	Pass
	711	H	-26.01	-49.65	0.00	2.02	25.66	Pass
	704	V	-24.44	-49.00	0.00	2.04	26.60	Pass
	707.5	V	-24.43	-49.12	0.00	2.03	26.72	Pass
	711	V	-24.98	-49.33	0.00	2.02	26.36	Pass

LTE Band 13								
Bandwidth	Frequency (MHz)	Ant Pot (H/V)	Rt (dBm)	Rs (dBm)	Ps (dBm)	Gs (dBi)	ERP (dBm)	Conclusion
5MHz (QPSK)	779.5	H	-24.21	-49.85	0.00	2.06	27.70	Pass
	782	H	-24.78	-50.19	0.00	2.05	27.47	Pass
	784.5	H	-24.99	-50.45	0.00	2.04	27.50	Pass
	779.5	V	-26.41	-49.80	0.00	2.06	25.45	Pass
	782	V	-27.01	-49.92	0.00	2.05	24.96	Pass
	784.5	V	-27.01	-50.13	0.00	2.04	25.15	Pass
5MHz (16QAM)	779.5	H	-24.72	-50.05	0.00	2.06	27.39	Pass
	782	H	-25.09	-50.19	0.00	2.05	27.16	Pass
	784.5	H	-25.32	-50.45	0.00	2.04	27.17	Pass
	779.5	V	-26.71	-49.80	0.00	2.06	25.15	Pass
	782	V	-27.31	-49.92	0.00	2.05	24.66	Pass
	784.5	V	-27.31	-50.13	0.00	2.04	24.85	Pass
10MHz (QPSK)	782	H	-25.97	-50.75	0.00	2.07	26.86	Pass
	782	V	-27.79	-50.10	0.00	2.02	24.33	Pass
10MHz (16QAM)	782	H	-25.71	-50.22	0.00	2.04	26.55	Pass
	782	V	-28.50	-50.43	0.00	2.07	24.00	Pass

Note:1. EIRP= E.R.P+2.15

4.3 Occupied Bandwidth

Ambient condition

Temperature	Relative humidity	Pressure
23°C ~25°C	45%~50%	101.5kPa

Method of Measurement

The EUT was connected to Spectrum Analyzer and Base Station Simulator via power Splitter. The occupied bandwidth is measured using spectrum analyzer.

RBW is set to 51 kHz, VBW is set to 160 kHz for LTE Band 4/12/13 .

99% power and -26dBc occupied bandwidths are recorded. Spectrum analyzer plots are included on the following pages.

Test Setup

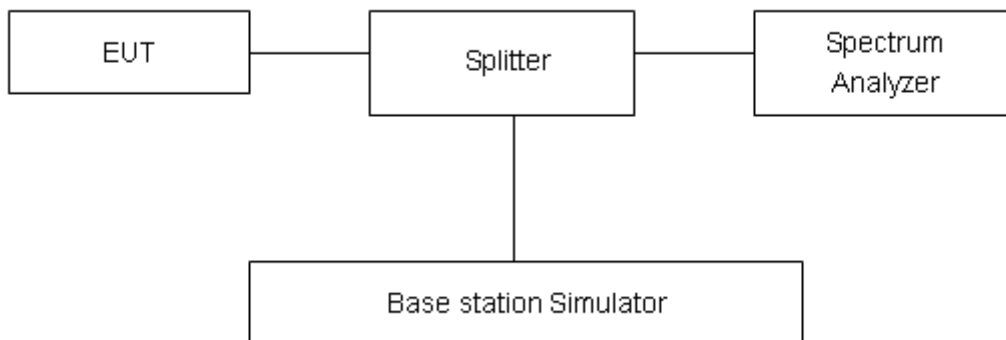

Limits

No specific occupied bandwidth requirements in part 2.1049.

Measurement Uncertainty

The assessed measurement uncertainty to ensure 95% confidence level for the normal distribution is with the coverage factor $k = 2$, $U=624\text{Hz}$.

Test Result

LTE Band 4						
RB	Modulation	Bandwidth (MHz)	Channel	Frequency (MHz)	99% Power Bandwidth(MHz)	-26dBc Bandwidth(MHz)
100%	QPSK	1.4	19957	1710.7	1.108	1.329
			20175	1732.5	1.118	1.345
			20393	1754.3	1.111	1.366
		3	19965	1711.5	1.150	1.643
			20175	1732.5	1.150	1.655
			20385	1753.5	1.135	1.471
		5	19975	1712.5	1.151	1.499
			20175	1732.5	1.130	1.472
			20375	1752.5	1.154	2.015
		10	20000	1715	1.179	1.769
			20175	1732.5	1.184	1.796
			20350	1750	1.188	1.932
		15	20025	1717.5	1.194	1.915
			20175	1732.5	1.196	1.894
			20325	1747.5	1.194	1.935
		20	20050	1720	1.192	1.816
			20175	1732.5	1.208	1.782
			20300	1745	1.207	1.806
	16QAM	1.4	19957	1710.7	0.948	1.312
			20175	1732.5	0.939	1.215
			20393	1754.3	0.937	1.206
		3	19965	1711.5	0.974	1.322
			20175	1732.5	0.981	1.337
			20385	1753.5	0.981	1.313
		5	19975	1712.5	0.983	1.357
			20175	1732.5	1.016	1.496
			20375	1752.5	0.996	1.410
		10	20000	1715	1.014	1.550
			20175	1732.5	1.066	1.795
			20350	1750	1.050	1.707
15		20025	1717.5	1.088	2.074	
		20175	1732.5	1.058	1.889	
		20325	1747.5	1.066	1.900	
20		20050	1720	1.081	1.945	
		20175	1732.5	1.113	1.862	
		20300	1745	1.098	1.880	

LTE Band 12						
RB	Modulation	Bandwidth (MHz)	Channel	Frequency (MHz)	99% Power Bandwidth(MHz)	-26dBc Bandwidth(MHz)
100%	QPSK	1.4	23017	699.7	1.105	1.317
			23095	707.5	1.108	1.332
			23173	715.3	1.108	1.322
		3	23025	700.5	1.152	1.653
			23095	707.5	1.153	1.660
			23165	714.5	1.151	1.549
		5	23035	701.5	1.143	1.875
			23095	707.5	1.145	1.506
			23155	713.5	1.127	1.496
		10	23060	704	1.190	1.756
			23095	707.5	1.205	1.738
			23130	711	1.178	1.893
	16QAM	1.4	23017	699.7	0.950	1.191
			23095	707.5	0.939	1.195
			23173	715.3	0.948	1.203
		3	23025	700.5	0.983	1.331
			23095	707.5	0.985	1.343
			23165	714.5	0.971	1.348
		5	23035	701.5	0.991	1.376
			23095	707.5	0.976	1.423
			23155	713.5	1.004	1.494
10		23060	704	1.029	1.528	
		23095	707.5	1.084	1.731	
		23130	711	1.072	1.762	



LTE Band 13						
RB	Modulation	Bandwidth (MHz)	Channel	Frequency (MHz)	99% Power Bandwidth(kHz)	-26dBc Bandwidth(kHz)
100%	QPSK	5	23205	779.5	1.144	1.828
			23230	782	1.149	1.481
			23255	784.5	1.123	1.482
		10	23230	782	1.191	1.731
			23230	782	1.178	1.721
			23230	782	1.193	1.722
	16QAM	5	23205	779.5	0.990	1.438
			23230	782	0.977	1.356
			23255	784.5	1.005	1.497
		10	23230	782	1.035	1.504
			23230	782	1.033	1.537
			23230	782	1.051	1.613

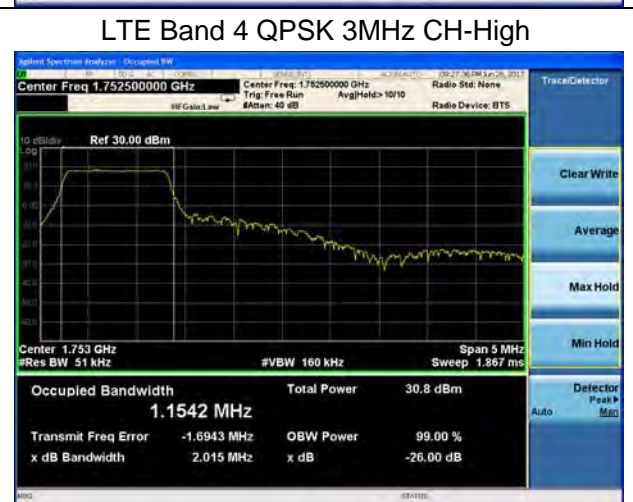
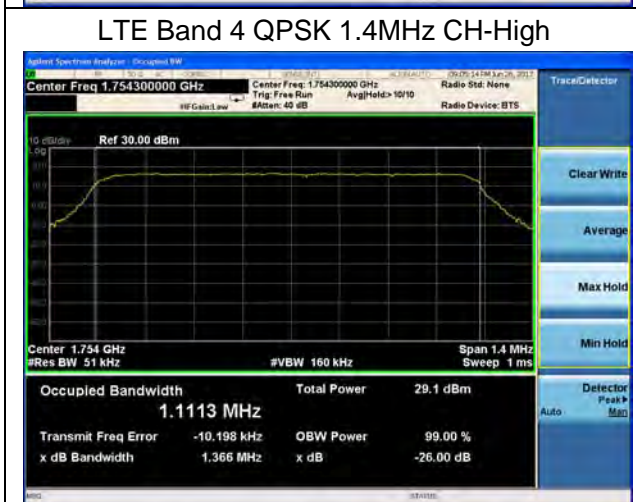
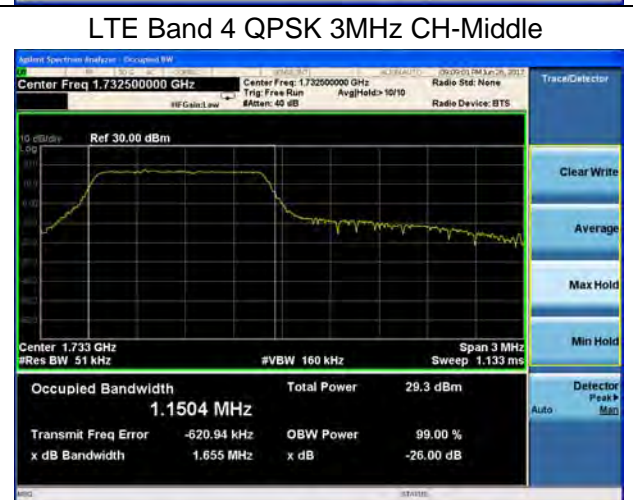
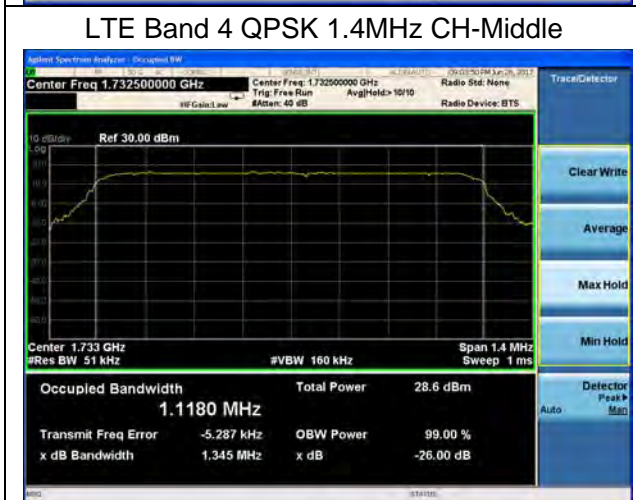
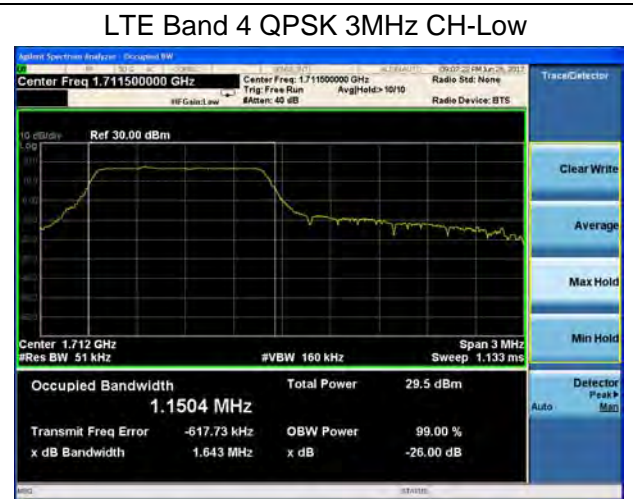
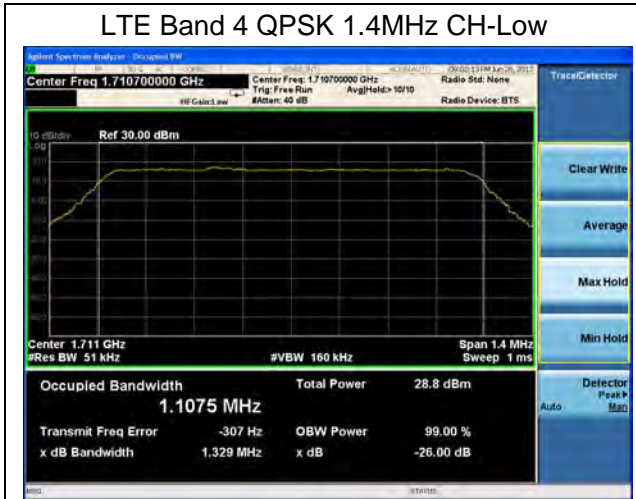



LTE Band 4 QPSK 5MHz CH-Low



LTE Band 4 QPSK 10MHz CH-Low

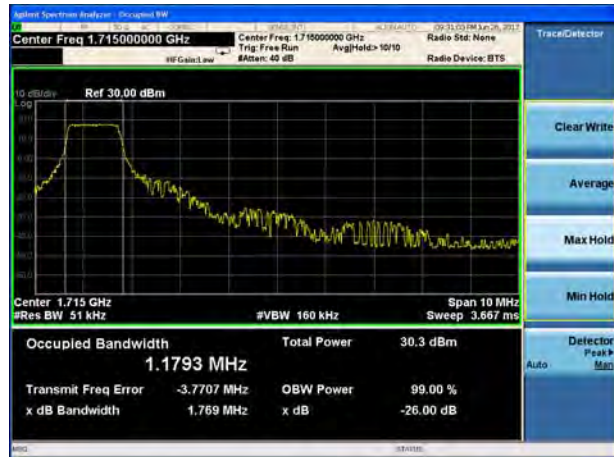

LTE Band 4 QPSK 5MHz CH-Middle



LTE Band 4 QPSK 10MHz CH-Middle



LTE Band 4 QPSK 5MHz CH-High



LTE Band 4 QPSK 10MHz CH-High





LTE Band 4 16QAM 1.4MHz CH-Low



LTE Band 4 16QAM 3MHz CH-Low



LTE Band 4 16QAM 1.4MHz CH-Middle



LTE Band 4 16QAM 3MHz CH-Middle



LTE Band 4 16QAM 1.4MHz CH-High



LTE Band 4 16QAM 3MHz CH-High



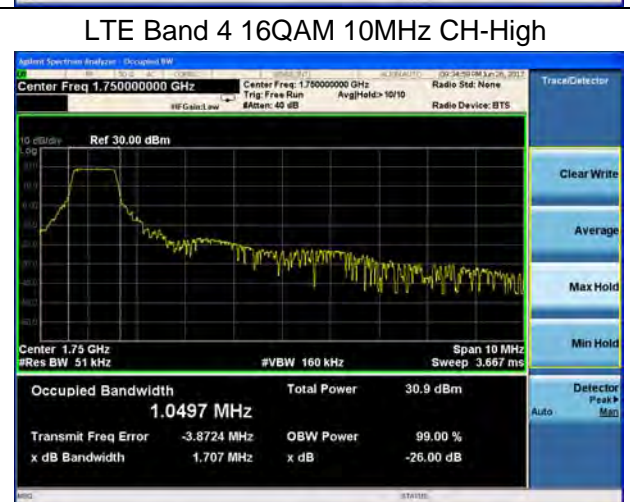
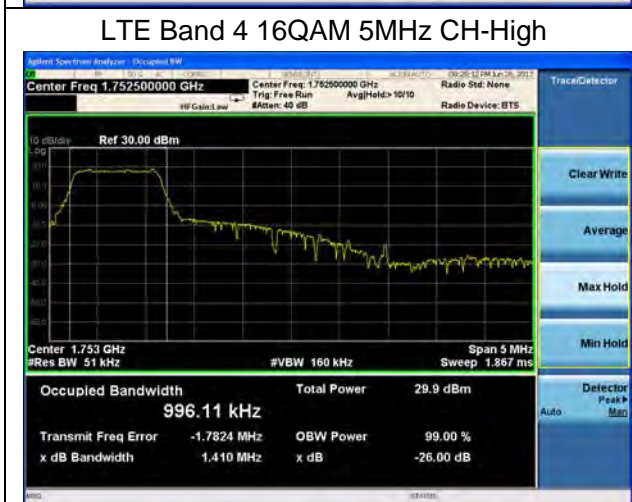
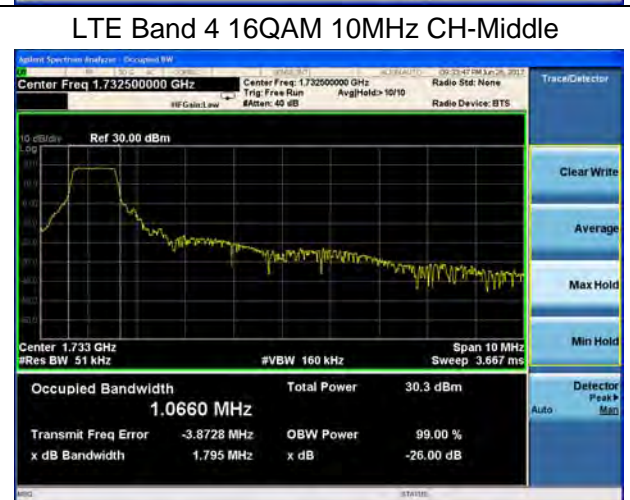
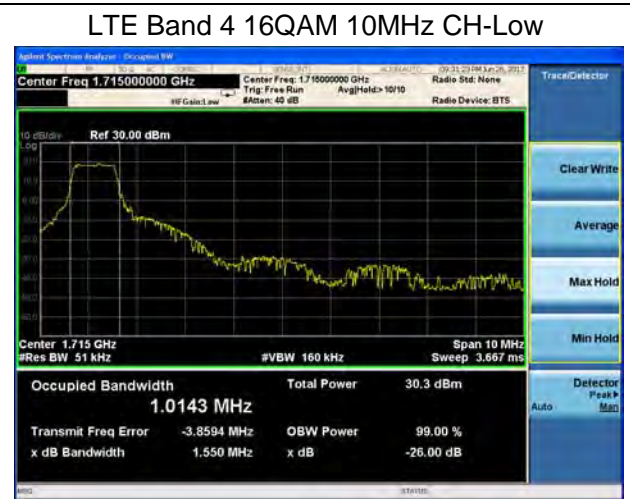
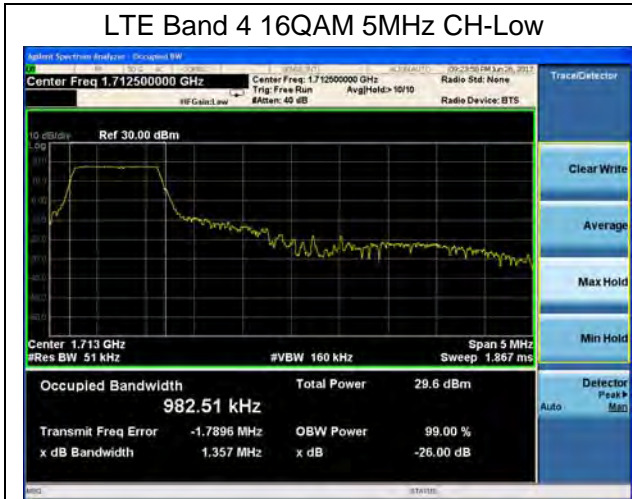

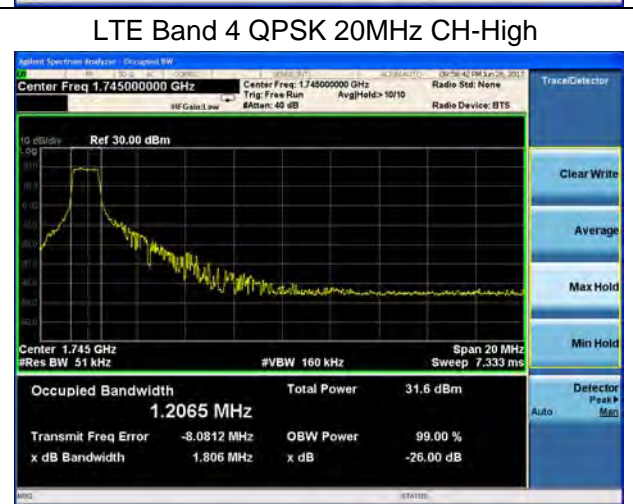
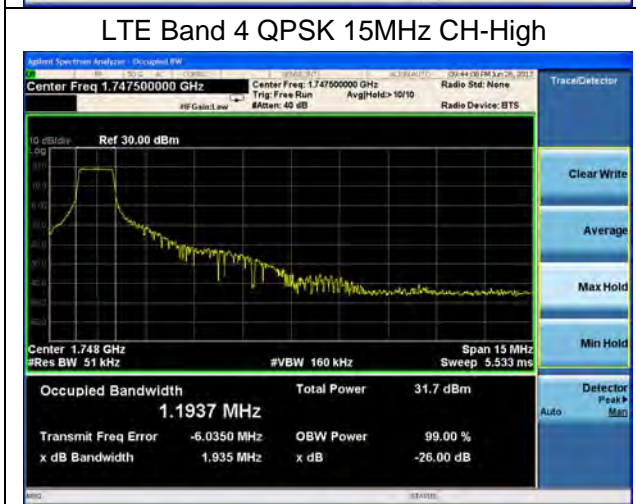
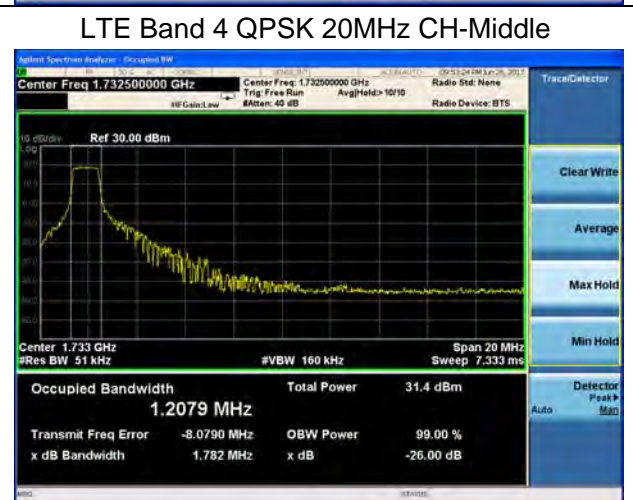
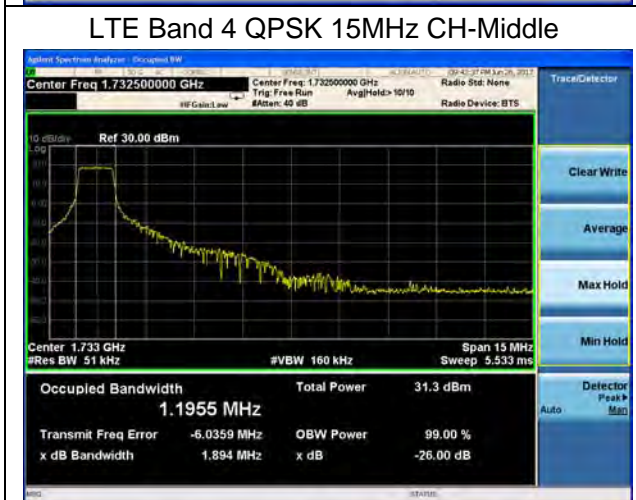
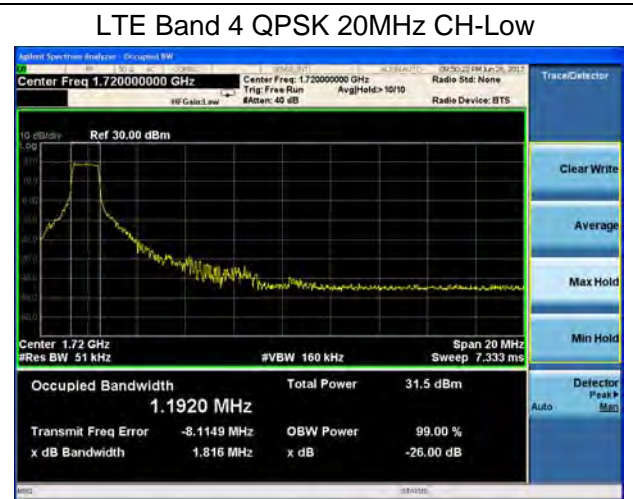
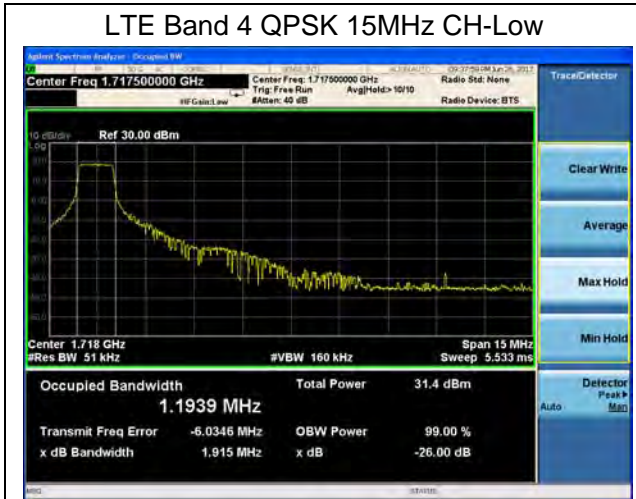



LTE Band 4 16QAM 15MHz CH-Low



LTE Band 4 16QAM 20MHz CH-Low

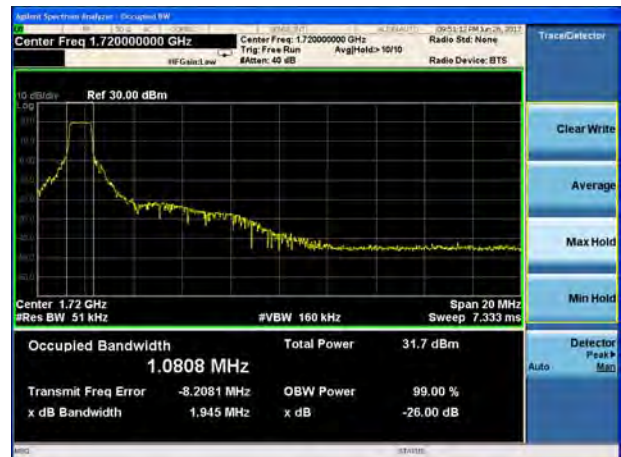

LTE Band 4 16QAM 15MHz CH-Middle

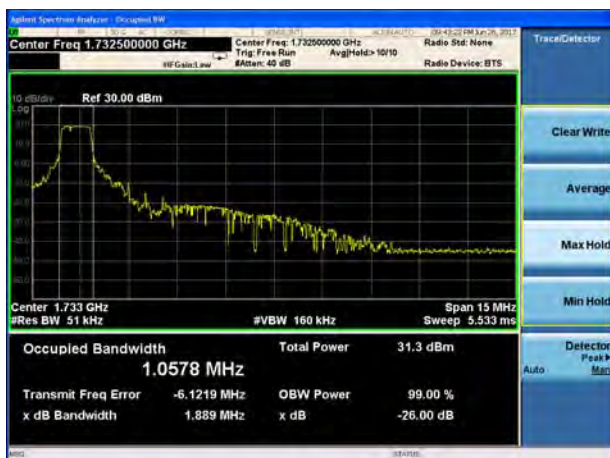

LTE Band 4 16QAM 20MHz CH-Middle



LTE Band 4 16QAM 15MHz CH-High

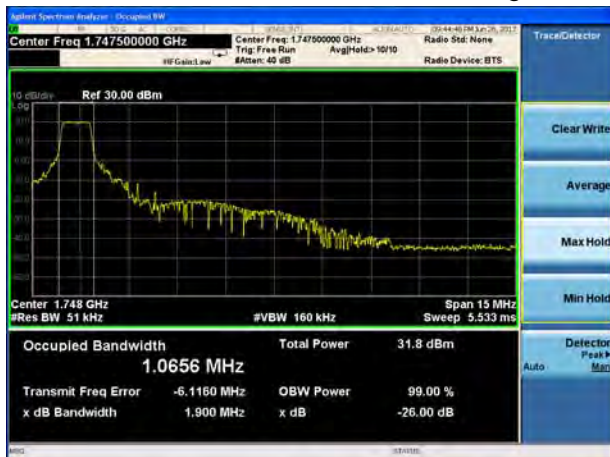

LTE Band 4 16QAM 20MHz CH-High





LTE Band 12 QPSK 1.4MHz CH-Low



LTE Band 12 QPSK 3MHz CH-Low



LTE Band 12 QPSK 1.4MHz CH-Middle

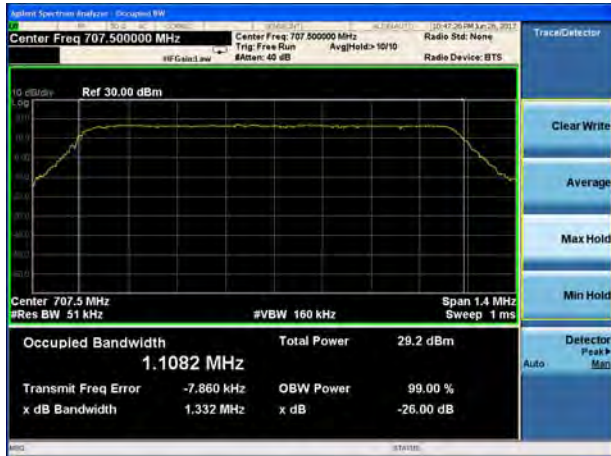

LTE Band 12 QPSK 3MHz CH-Middle



LTE Band 12 QPSK 1.4MHz CH-High



LTE Band 12 QPSK 3MHz CH-High



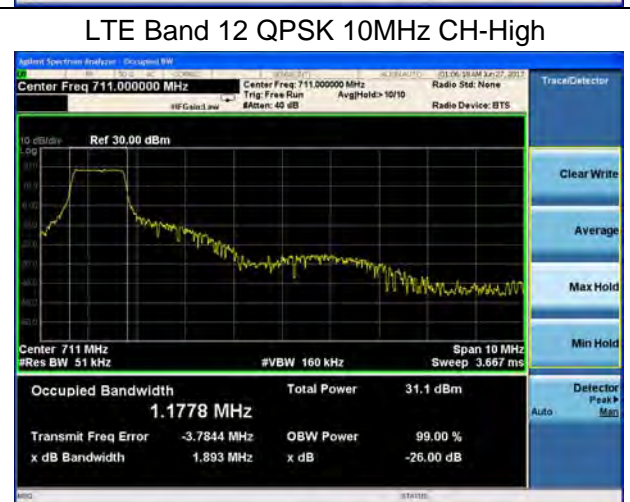
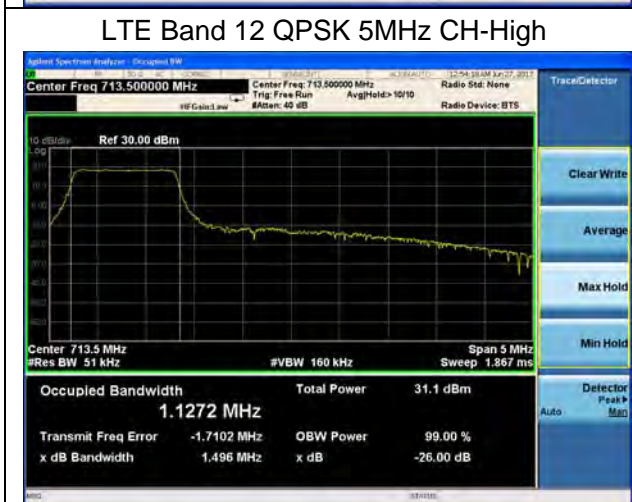
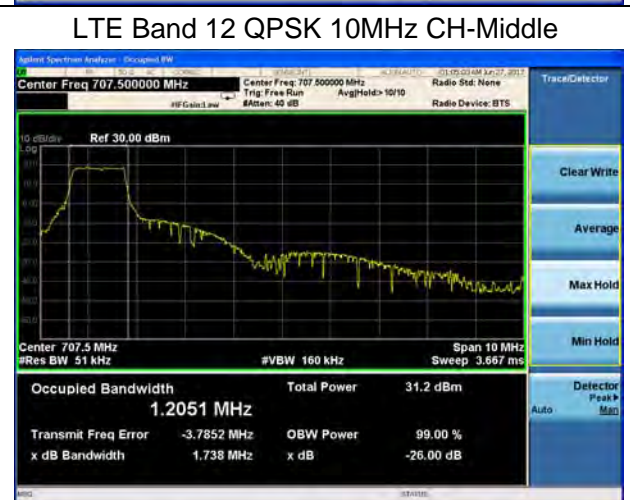
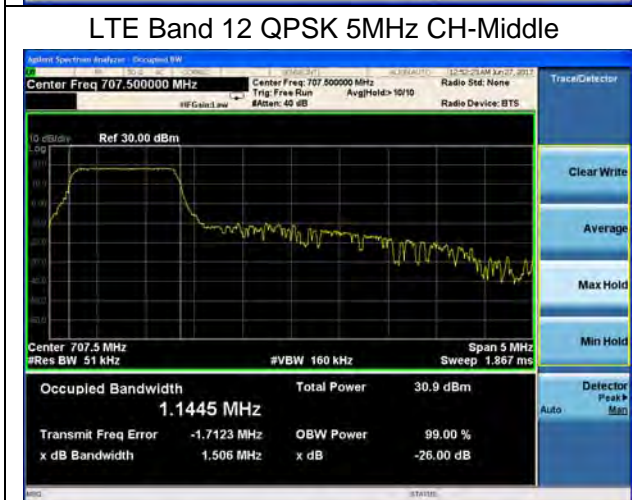
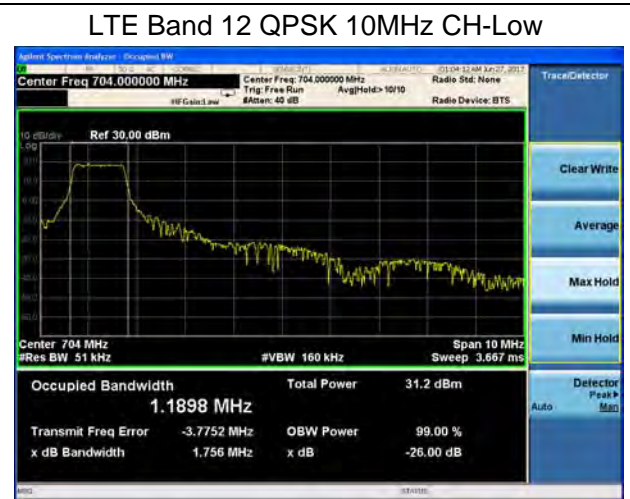
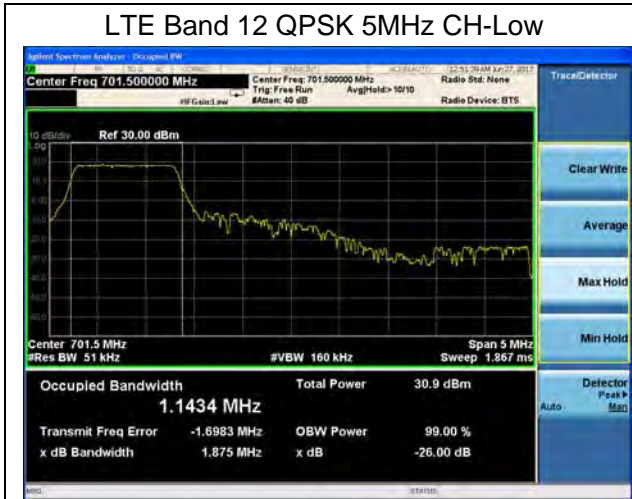

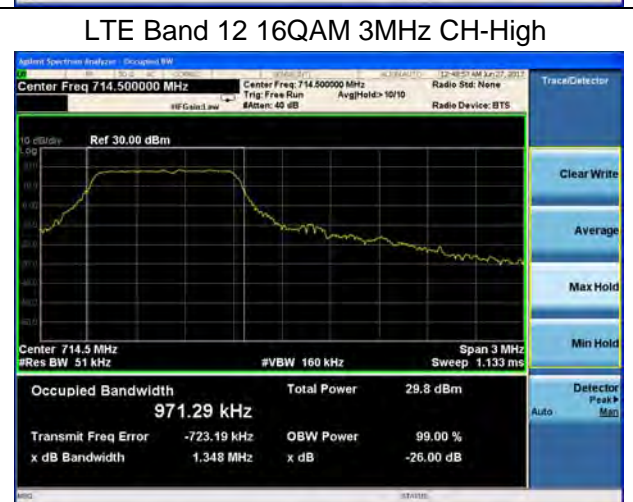
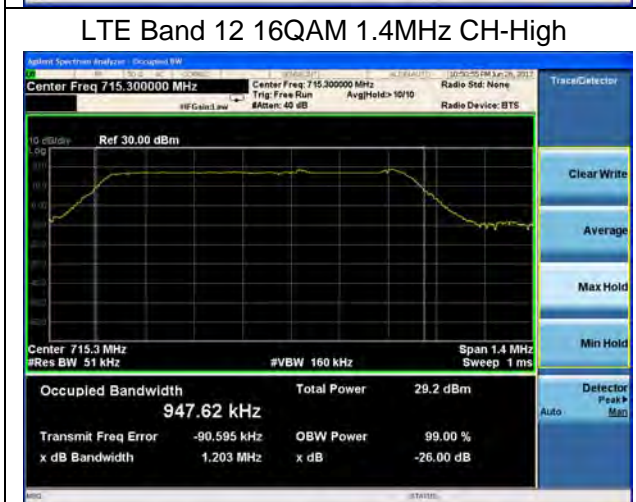
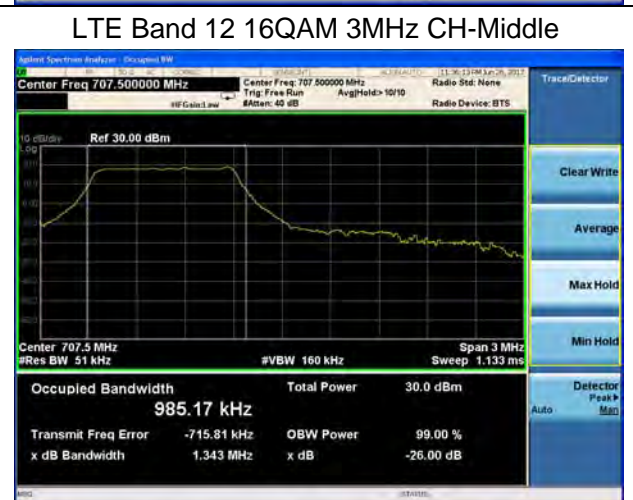
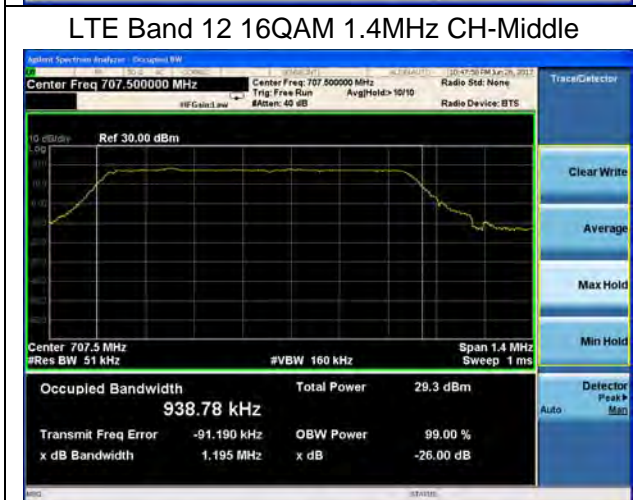
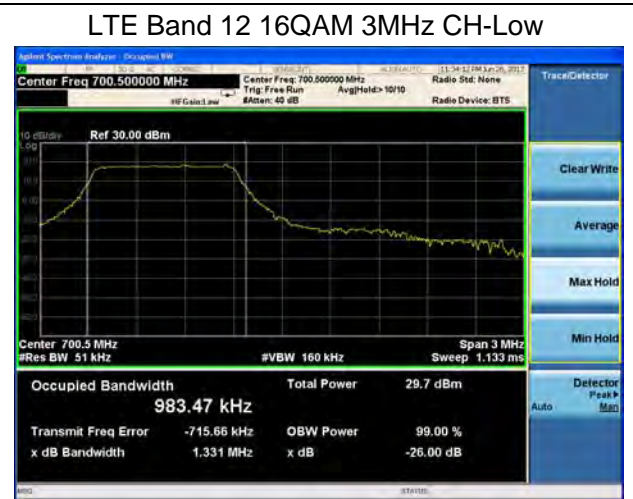



LTE Band 12 16QAM 5MHz CH-Low



LTE Band 12 16QAM 10MHz CH-Low



LTE Band 12 16QAM 5MHz CH-Middle



LTE Band 12 16QAM 10MHz CH-Middle



LTE Band 12 16QAM 5MHz CH-High



LTE Band 12 16QAM 10MHz CH-High





LTE Band 13 QPSK 5MHz CH-Low



LTE Band 13 QPSK 5MHz CH-Middle



LTE Band 13 QPSK 5MHz CH-High



LTE Band 13 QPSK 10MHz CH-Middle



LTE Band 13 16QAM 5MHz CH-Low

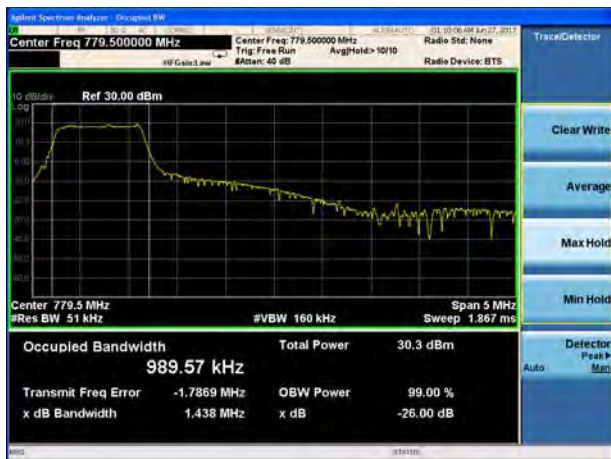

LTE Band 13 16QAM 5MHz CH-Middle





LTE Band 13 16QAM 5MHz CH-High

LTE Band 13 16QAM 10MHz CH-Middle

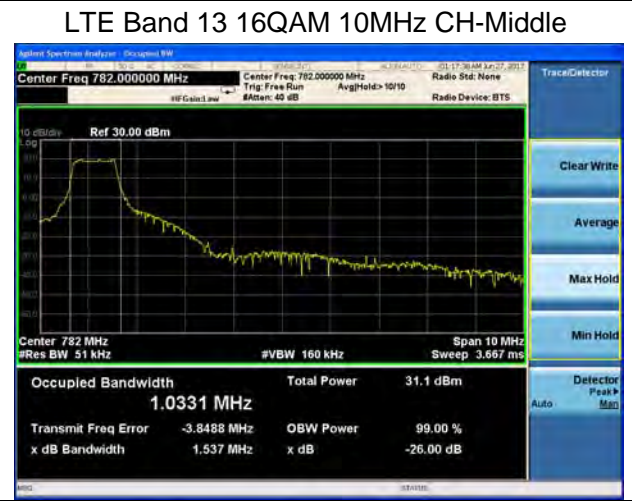
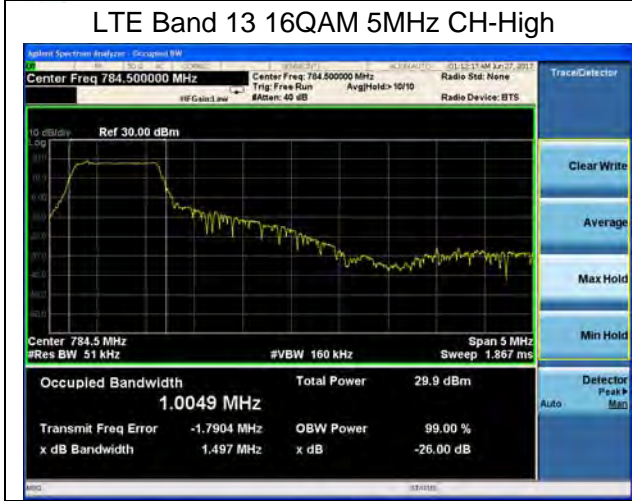

4.4 Band Edge Compliance

Ambient condition

Temperature	Relative humidity	Pressure
23°C ~25°C	45%~50%	101.5kPa

Method of Measurement

The EUT was connected to Spectrum Analyzer and Base Station Simulator via power Splitter. The band edge of the lowest and highest channels were measured.

The testing follows KDB 971168 D01 v03r01 Section 6.0

The EUT was connected to spectrum analyzer and system simulator via a power divider.

The band edges of low and high channels for the highest RF powers were measured.

RBW is set to 51 kHz, VBW is set to 160 kHz for LTE Band 4/12.

RBW is set to 200 kHz, VBW is set to 3x RBW for LTE Band 13 (777MHz~788MHz).

RBW is set to 100 kHz, VBW is set to 3x RBW for LTE Band 13 (788MHz~793MHz).

on spectrum analyzer.

Set spectrum analyzer with RMS detector.

The RF fundamental frequency should be excluded against the limit line in the operating frequency band.

Checked that all the results comply with the emission limit line.

Test Setup

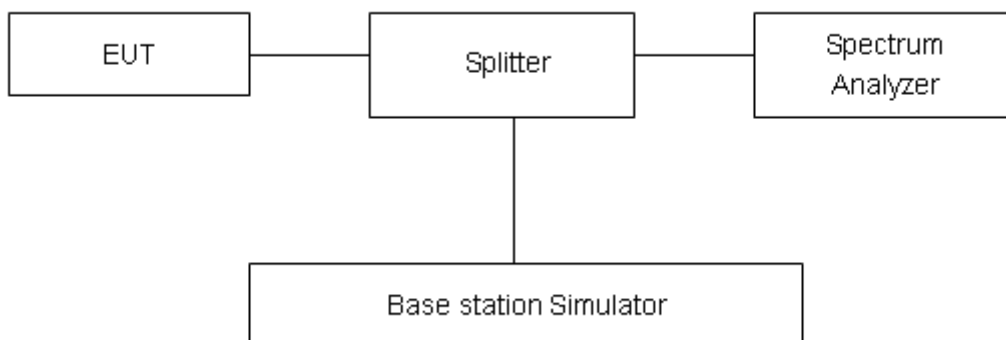

Limits

Rule Part 27.53(h) specifies that “ for operations in the 1695-1710 MHz, 1710-1755 MHz, 1755-1780 MHz, 1915-1920 MHz, 1995-2000 MHz, 2000-2020 MHz, 2110-2155 MHz, 2155-2180 MHz, and 2180-2200 bands, the power of any emission outside a licensee's frequency block shall be attenuated below the transmitter power (P) in watts by at least $43 + 10 \log_{10} (P)$ dB”

Rule Part 27.53(g) For operations in the 600 MHz band and the 698-746 MHz band, the power of any emission outside a licensee's frequency band(s) of operation shall be attenuated below the transmitter power (P) within the licensed band(s) of operation, measured in watts, by at least $43 + 10 \log (P)$ dB. Compliance with this provision is based on the use of measurement instrumentation employing a resolution bandwidth of 100 kilohertz or greater. However, in the 100 kilohertz bands immediately outside and adjacent to a licensee's frequency block, a resolution bandwidth of at least 30 kHz may be employed.

Rule Part 27.53(m) (4)/ specifies that “for BRS and EBS stations. For mobile digital stations, the attenuation factor shall be not less than $40 + 10 \log (P)$ dB on all frequencies between the channel edge and 5 megahertz from the channel edge, $43 + 10 \log (P)$ dB on all frequencies between 5 megahertz and X megahertz from the channel edge, and $55 + 10 \log (P)$ dB on all frequencies more than X megahertz from the channel edge, where X is the greater of 6 megahertz or the actual emission bandwidth as defined in paragraph (m)(4) of this section. In addition, the attenuation factor shall not be less that $43 + 10 \log (P)$ dB on all frequencies between 2490.5 MHz and 2496 MHz and $55 + 10 \log (P)$ dB at or below 2490.5 MHz. Mobile Satellite Service licensees operating on frequencies below 2495 MHz may also submit a documented interference complaint against BRS licensees operating on channel BRS Channel 1 on the same terms and conditions as adjacent channel BRS or EBS licensees.

Example:

The limit line is derived from $43 + 10 \log (P)$ dB below the transmitter power P(Watts)
= P(W)- [43 + 10log(P)] (dB)
= [30 + 10log (P)] (dBm) - [43 + 10log(P)] (dB) = -13dBm.

Rule Part 27.53(f) For operations in the 746-758 MHz, 775-788 MHz, and 805-806 MHz bands, emissions in the band 1559-1610 MHz shall be limited to -70 dBW/MHz equivalent isotropically radiated power (EIRP) for wideband signals, and -80 dBW EIRP for discrete emissions of less than 700 Hz bandwidth. For the purpose of equipment authorization, a transmitter shall be tested with an antenna that is representative of the type that will be used with the equipment in normal operation.

Rule Part 27.53 (c) For operations in the 746-758 MHz band and the 776-788 MHz band, the power of any emission outside the licensee's frequency band(s) of operation shall be attenuated below the transmitter power (P) within the licensed band(s) of operation, measured in watts, in accordance with the following:

- (1) On any frequency outside the 746-758 MHz band, the power of any emission shall be attenuated outside the band below the transmitter power (P) by at least $43 + 10 \log (P)$ dB;
- (2) On any frequency outside the 776-788 MHz band, the power of any emission shall be attenuated outside the band below the transmitter power (P) by at least $43 + 10 \log (P)$ dB;



- (3) On all frequencies between 763-775 MHz and 793-805 MHz, by a factor not less than $76 + 10 \log$ (P) dB in a 6.25 kHz band segment, for base and fixed stations;
- (4) On all frequencies between 763-775 MHz and 793-805 MHz, by a factor not less than $65 + 10 \log$ (P) dB in a 6.25 kHz band segment, for mobile and portable stations;
- (5) Compliance with the provisions of paragraphs (c)(1) and (c)(2) of this section is based on the use of measurement instrumentation employing a resolution bandwidth of 100 kHz or greater. However, in the 100 kHz bands immediately outside and adjacent to the frequency block, a resolution bandwidth of at least 30 kHz may be employed;

Measurement Uncertainty

The assessed measurement uncertainty to ensure 95% confidence level for the normal distribution is with the coverage factor $k = 1.96$, $U=0.684$ dB.

Test Result

All the test traces in the plots shows the test results clearly.

Variant

LTE Band 4 QPSK 1.4MHz CH-Low, 1 RB



LTE Band 4 QPSK 1.4MHz CH-High, 1 RB



LTE Band 4 QPSK 1.4MHz CH-Low, 100%RB



LTE Band 4 QPSK 1.4MHz CH-High, 100%RB



LTE Band 4 QPSK 3MHz CH-Low, 1 RB

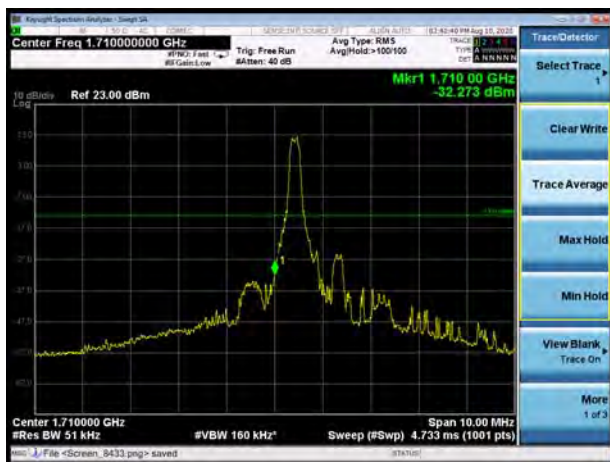

LTE Band 4 QPSK 3MHz CH-High, 1 RB





LTE Band 4 QPSK 3MHz CH-Low, 100%RB



LTE Band 4 QPSK 3MHz CH-High, 100%RB

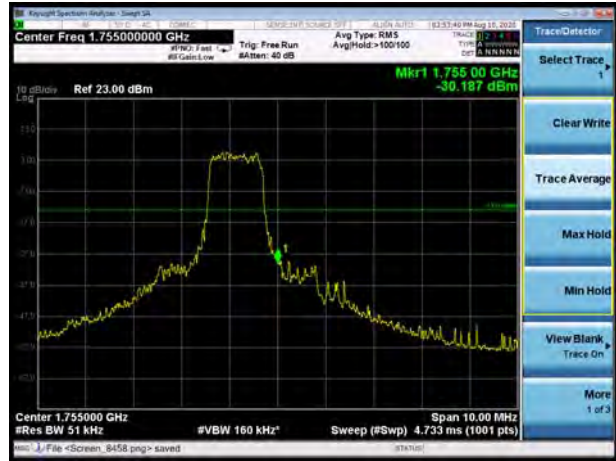

LTE Band 4 QPSK 5MHz CH-Low, 1 RB



LTE Band 4 QPSK 5MHz CH-High, 1 RB

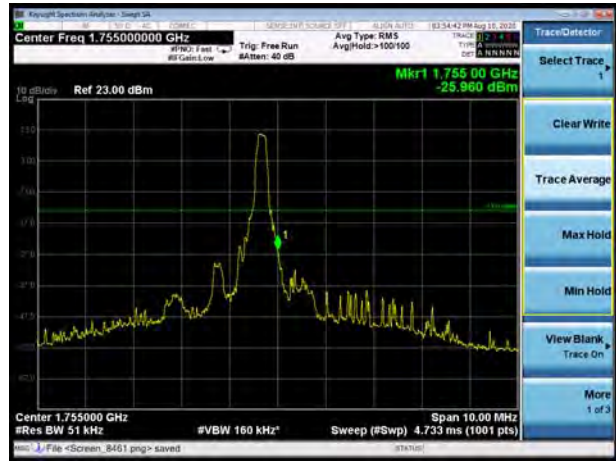

LTE Band 4 QPSK 5MHz CH-Low, 100%RB

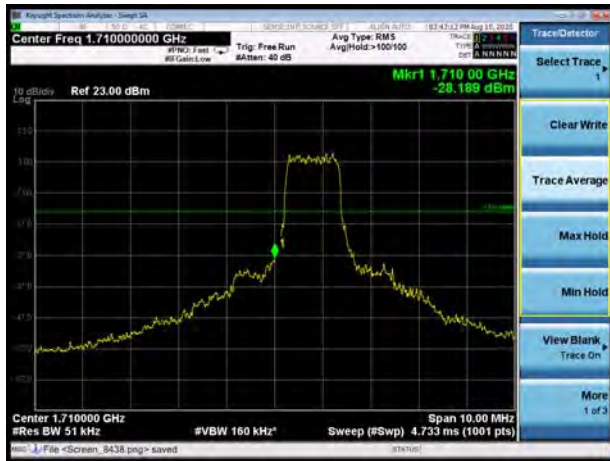

LTE Band 4 QPSK 5MHz CH-High, 100%RB

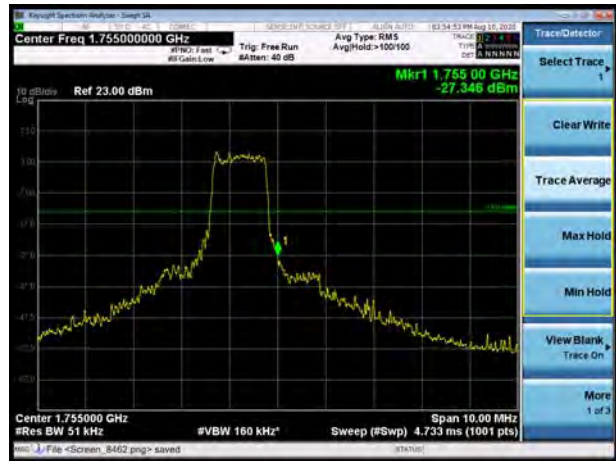

LTE Band 4 QPSK 10MHz CH-Low, 1 RB

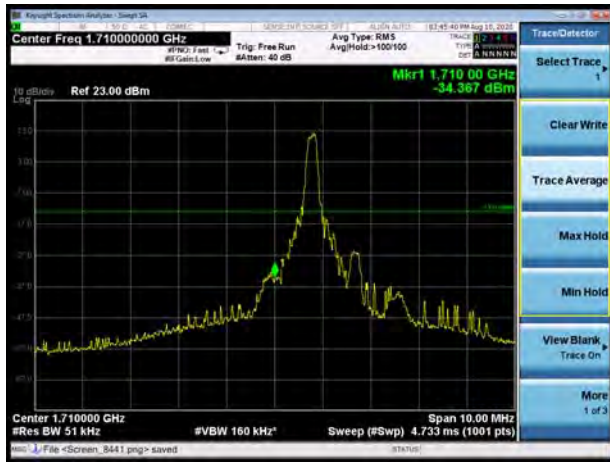

LTE Band 4 QPSK 10MHz CH-High, 1 RB

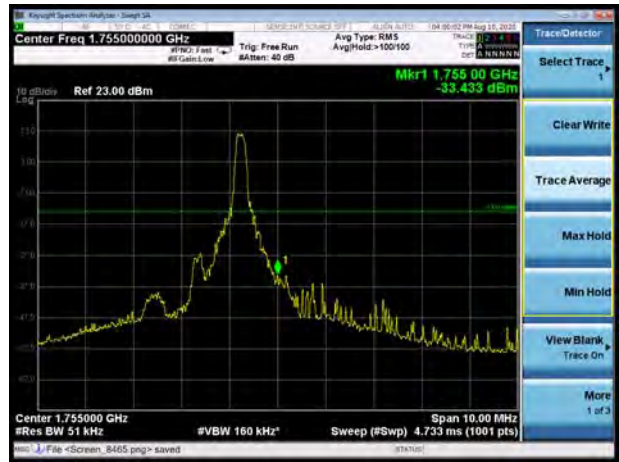

LTE Band 4 QPSK 10MHz CH-Low, 100%RB



LTE Band 4 QPSK 10MHz CH-High, 100%RB



LTE Band 4 QPSK 15MHz CH-Low, 1 RB

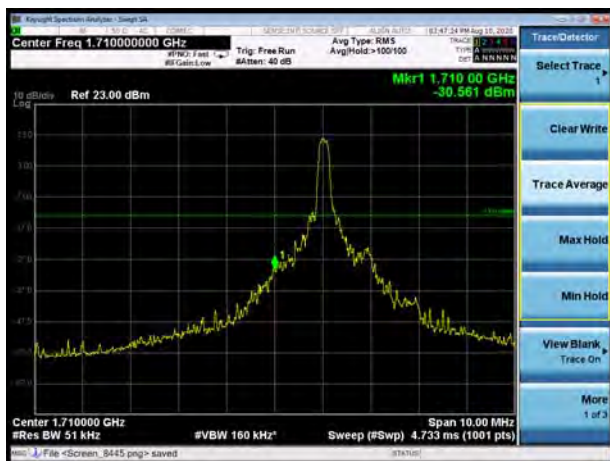

LTE Band 4 QPSK 15MHz CH-High, 1 RB

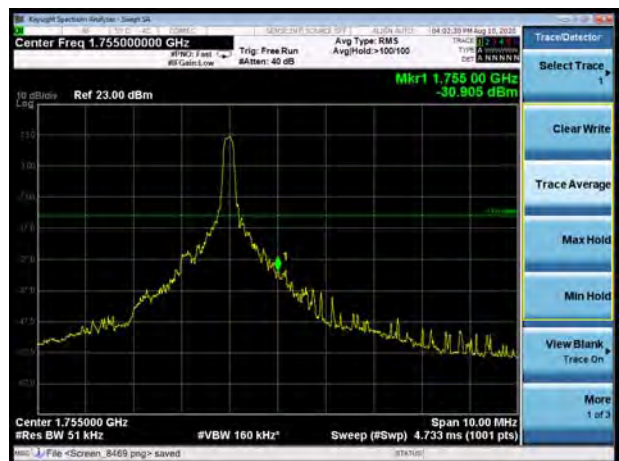

LTE Band 4 QPSK 15MHz CH-Low, 100%RB

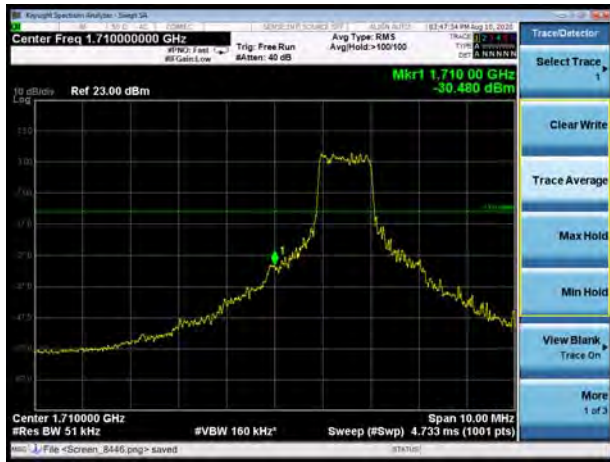

LTE Band 4 QPSK 15MHz CH-High, 100%RB

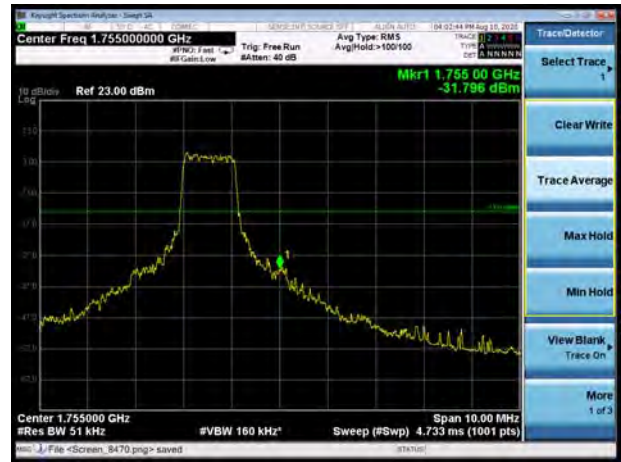

LTE Band 4 QPSK 20MHz CH-Low, 1 RB

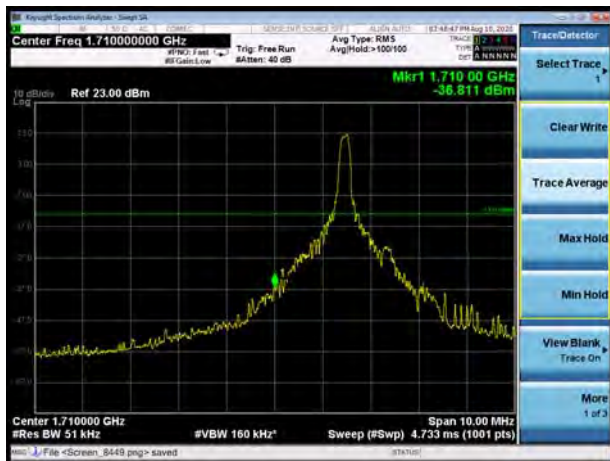

LTE Band 4 QPSK 20MHz CH-High, 1 RB

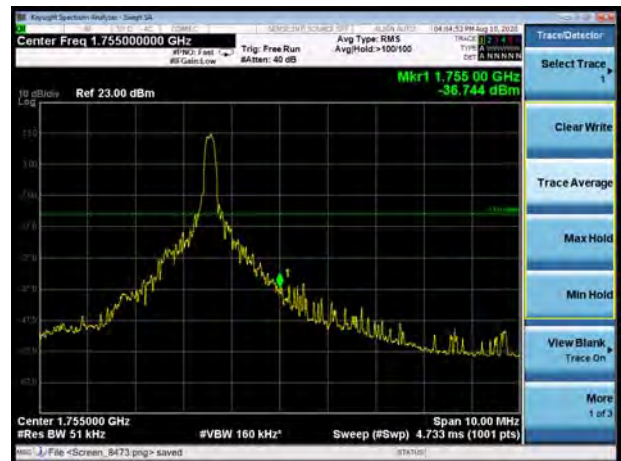

LTE Band 4 QPSK 20MHz CH-Low, 100%RB

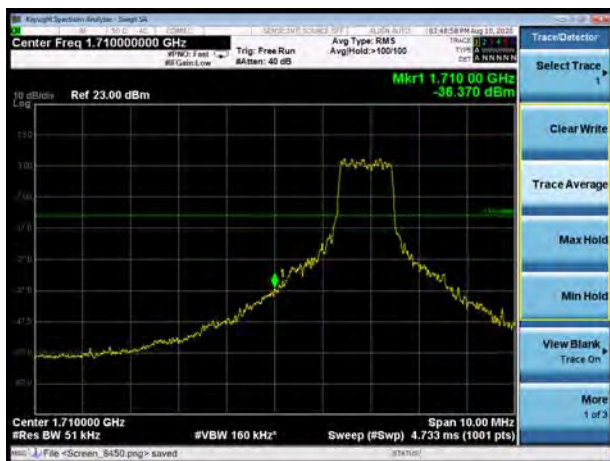

LTE Band 4 QPSK 20MHz CH-High, 100%RB

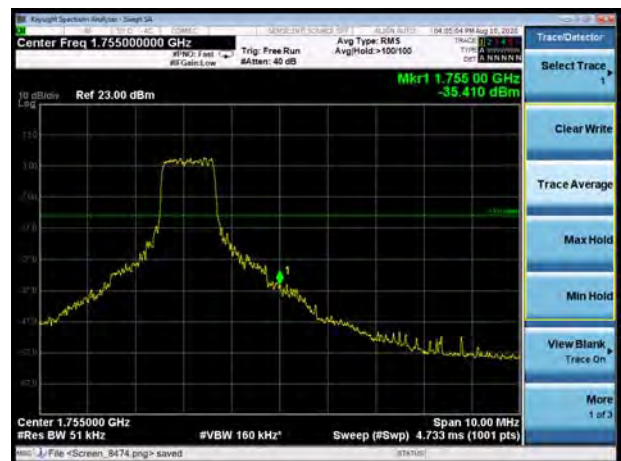

LTE Band 4 16QAM 1.4MHz CH-Low, 1 RB



LTE Band 4 16QAM 1.4MHz CH-High, 1 RB



LTE Band 4 16QAM 1.4MHz CH-Low, 100%RB

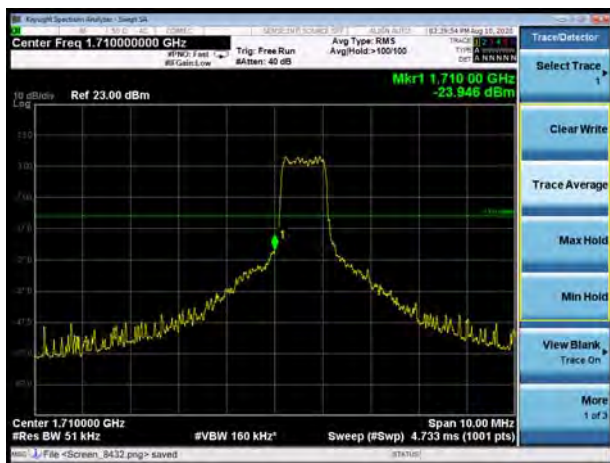

LTE Band 4 16QAM 1.4MHz CH-High, 100%RB

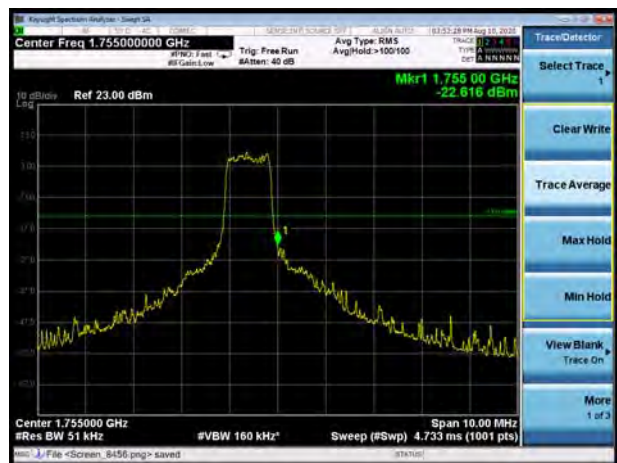

LTE Band 4 16QAM 3MHz CH-Low, 1 RB



LTE Band 4 16QAM 3MHz CH-High, 1 RB



LTE Band 4 16QAM 3MHz CH-Low, 100%RB

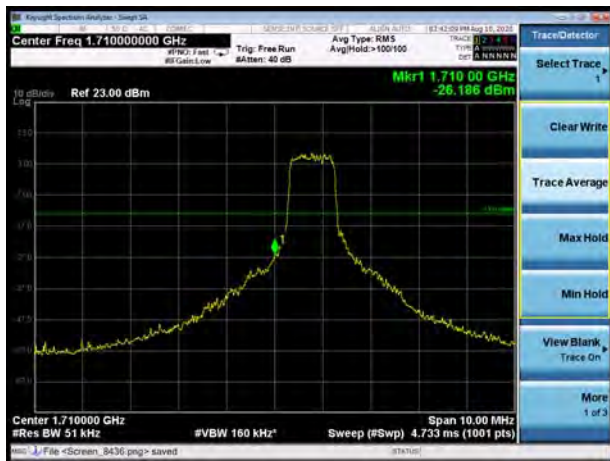

LTE Band 4 16QAM 3MHz CH-High, 100%RB



LTE Band 4 16QAM 5MHz CH-Low, 1 RB



LTE Band 4 16QAM 5MHz CH-High, 1 RB



LTE Band 4 16QAM 5MHz CH-Low, 100%RB



LTE Band 4 16QAM 5MHz CH-High, 100%RB

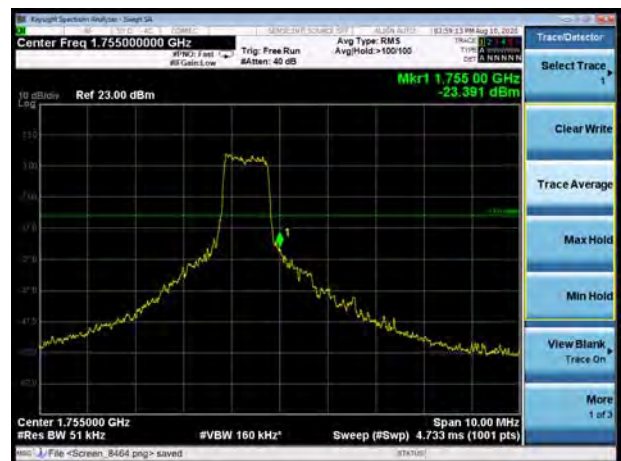

LTE Band 4 16QAM 10MHz CH-Low, 1 RB



LTE Band 4 16QAM 10MHz CH-High, 1 RB



LTE Band 4 16QAM 10MHz CH-Low, 100%RB



LTE Band 4 16QAM 10MHz CH-High, 100%RB

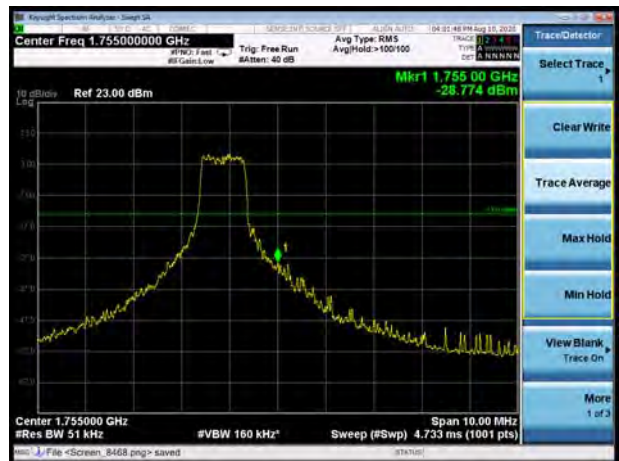

LTE Band 4 16QAM 15MHz CH-Low, 1 RB

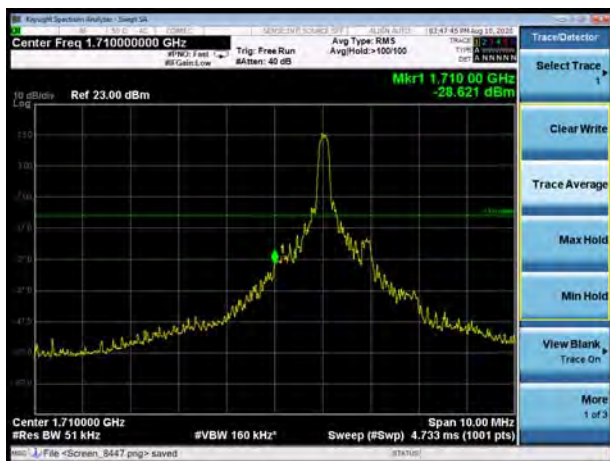

LTE Band 4 16QAM 15MHz CH-High, 1 RB

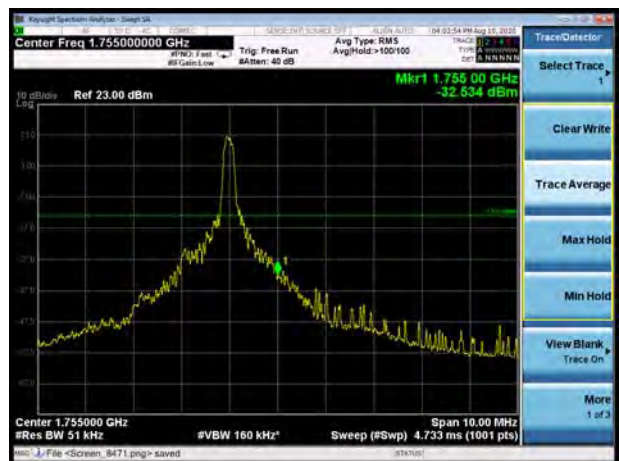

LTE Band 4 16QAM 15MHz CH-Low, 100%RB

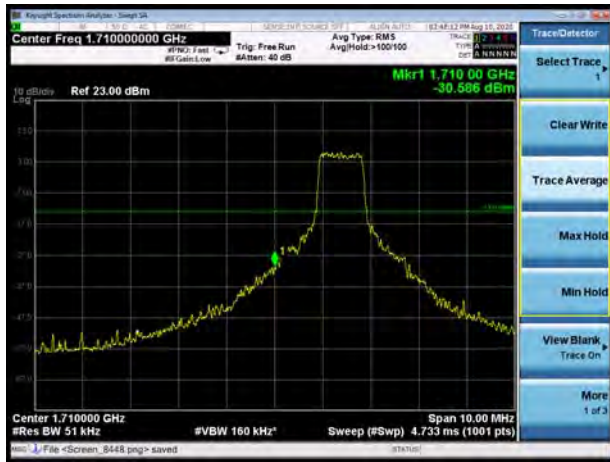

LTE Band 4 16QAM 15MHz CH-High, 100%RB



LTE Band 4 16QAM 20MHz CH-Low, 1 RB

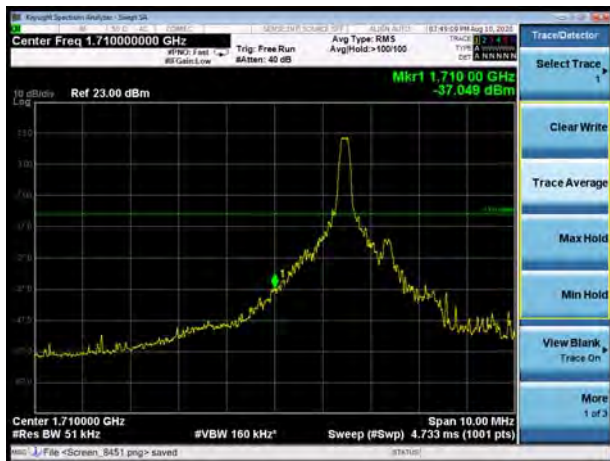

LTE Band 4 16QAM 20MHz CH-High, 1 RB

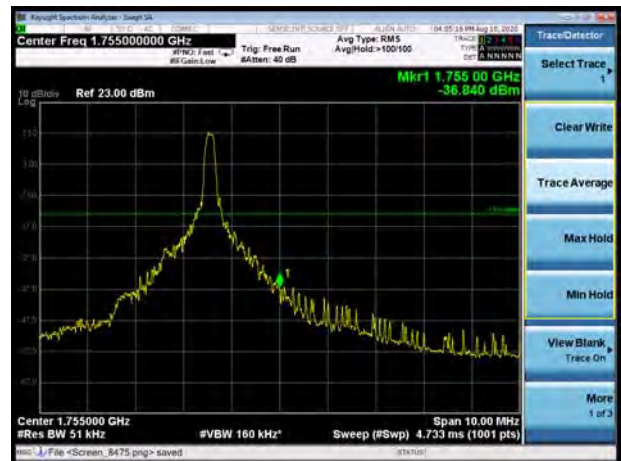

LTE Band 4 16QAM 20MHz CH-Low, 100%RB

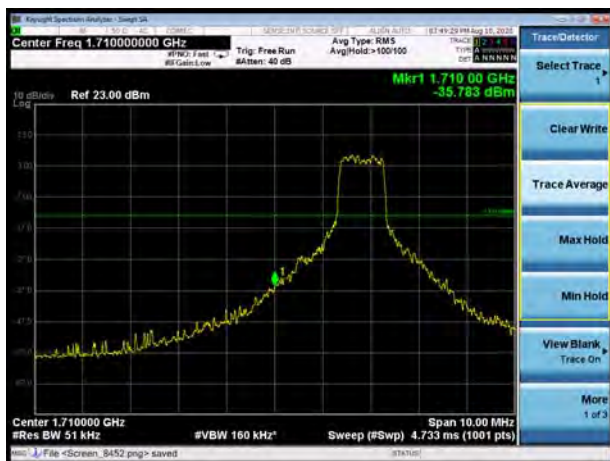

LTE Band 4 16QAM 20MHz CH-High, 100%RB

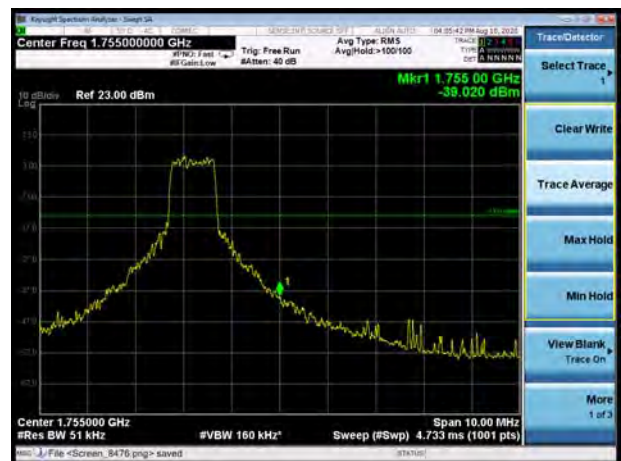

LTE Band 12 QPSK 1.4MHz CH-Low, 1 RB

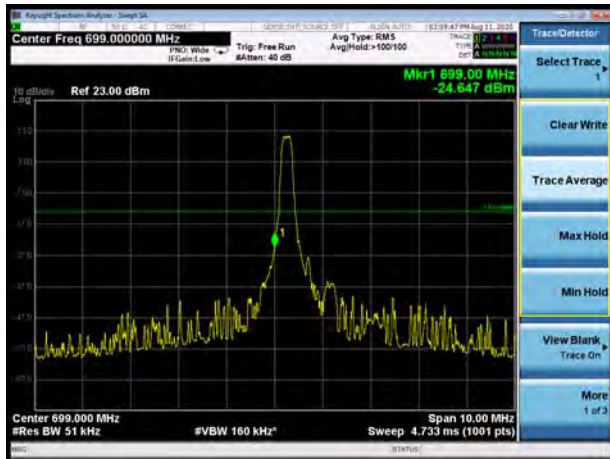

LTE Band 12 QPSK 1.4MHz CH-High, 1 RB

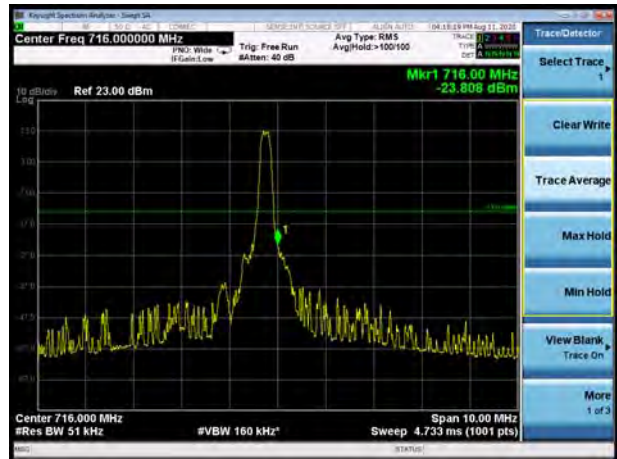

LTE Band 12 QPSK 1.4MHz CH-Low, 100%RB

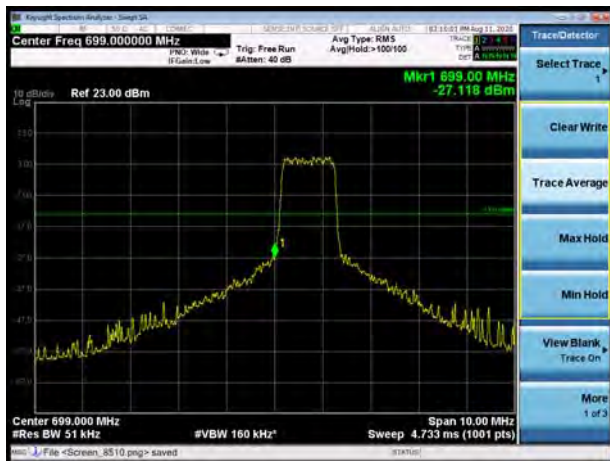

LTE Band 12 QPSK 1.4MHz CH-High, 100%RB



LTE Band 12 QPSK 3MHz CH-Low, 1 RB

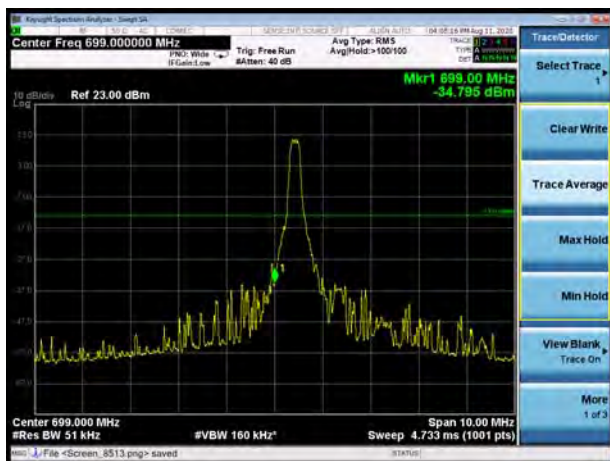

LTE Band 12 QPSK 3MHz CH-High, 1 RB



LTE Band 12 QPSK 3MHz CH-Low, 100%RB



LTE Band 12 QPSK 3MHz CH-High, 100%RB

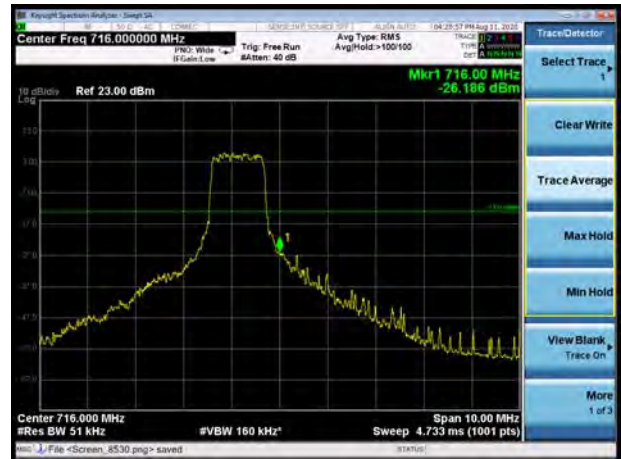

LTE Band 12 QPSK 5MHz CH-Low, 1 RB

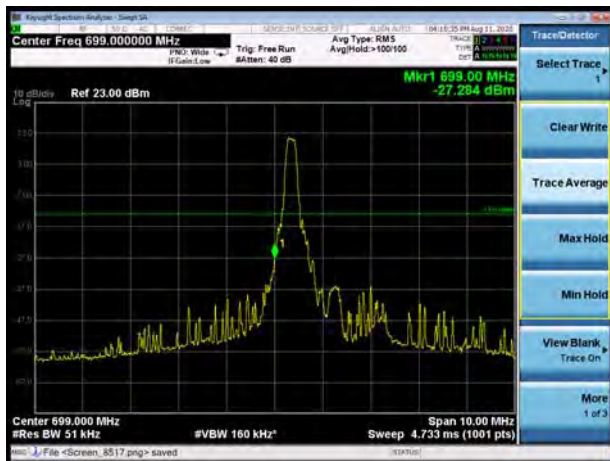

LTE Band 12 QPSK 5MHz CH-High, 1 RB

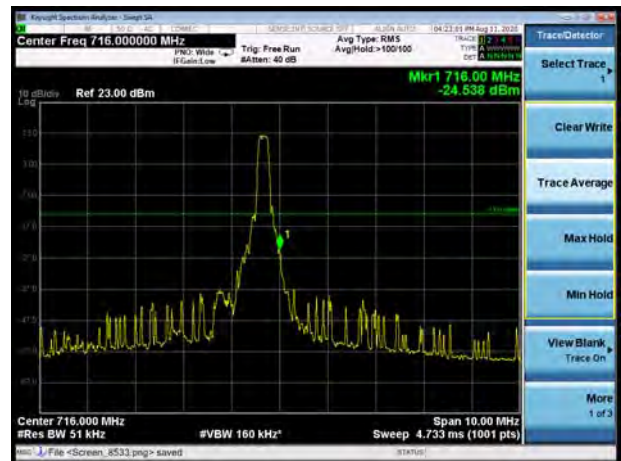

LTE Band 12 QPSK 5MHz CH-Low, 100%RB

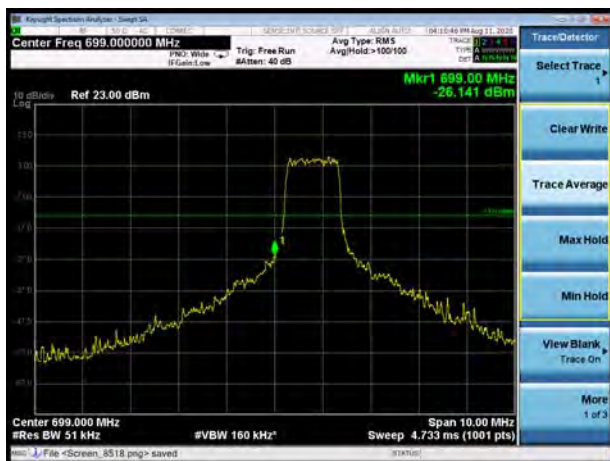

LTE Band 12 QPSK 5MHz CH-High, 100%RB

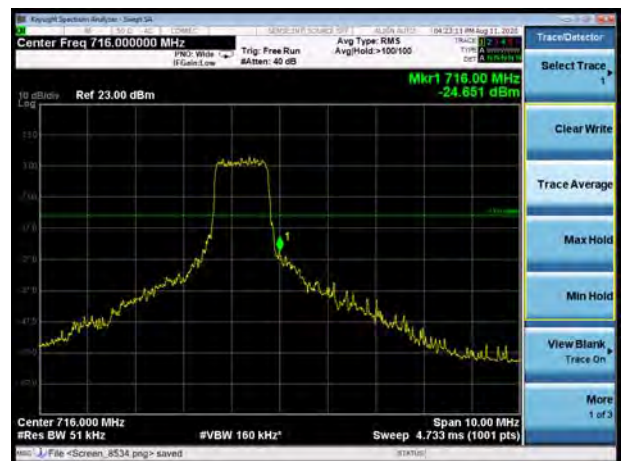

LTE Band 12 QPSK 10MHz CH-Low, 1 RB

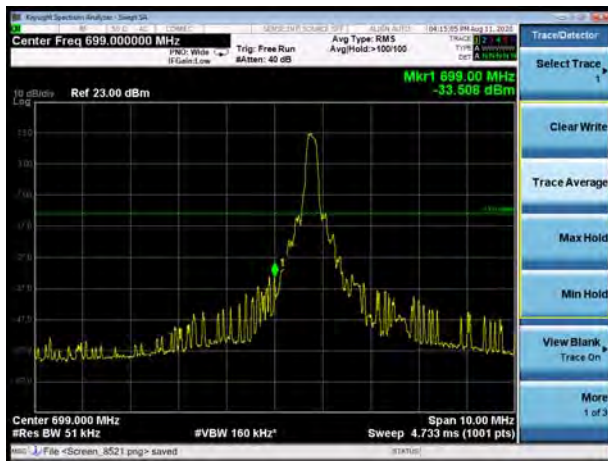

LTE Band 12 QPSK 10MHz CH-High, 1 RB

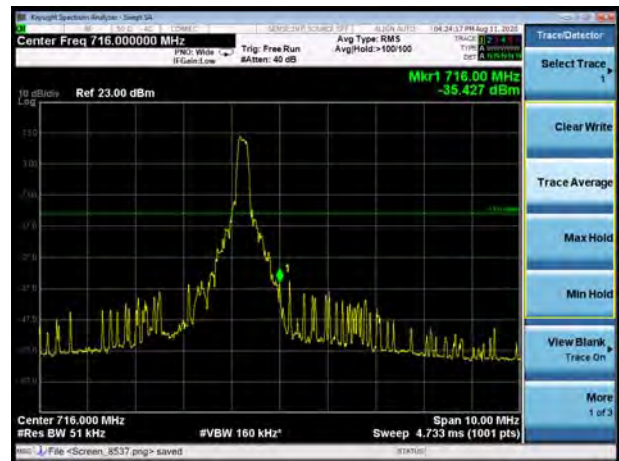

LTE Band 12 QPSK 10MHz CH-Low, 100%RB

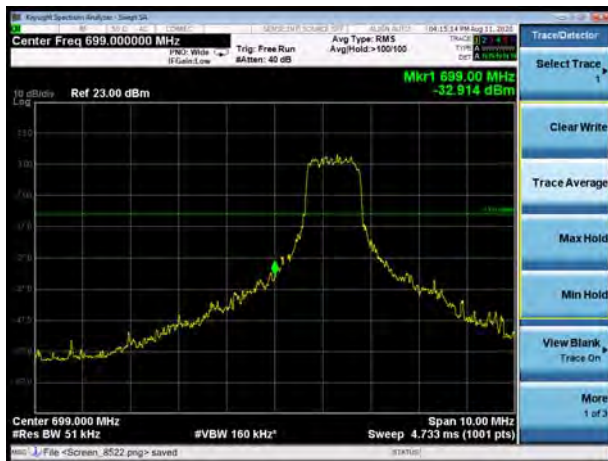

LTE Band 12 QPSK 10MHz CH-High, 100%RB



LTE Band 12 16QAM 1.4MHz CH-Low, 1 RB

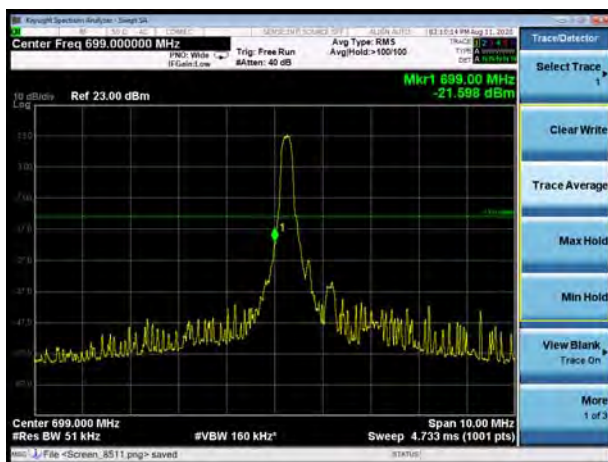

LTE Band 12 16QAM 1.4MHz CH-High, 1 RB

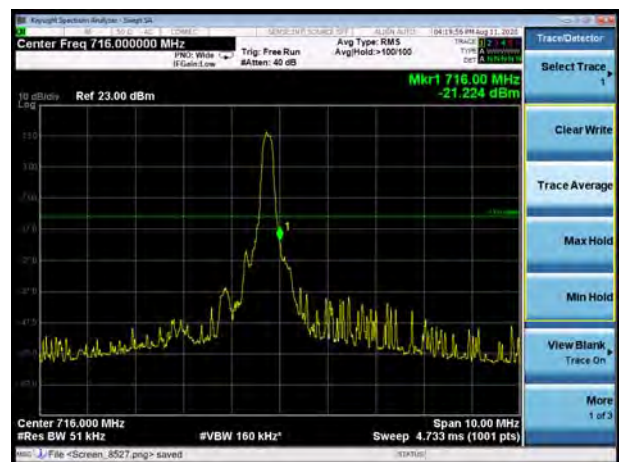

LTE Band 12 16QAM 1.4MHz CH-Low, 100%RB

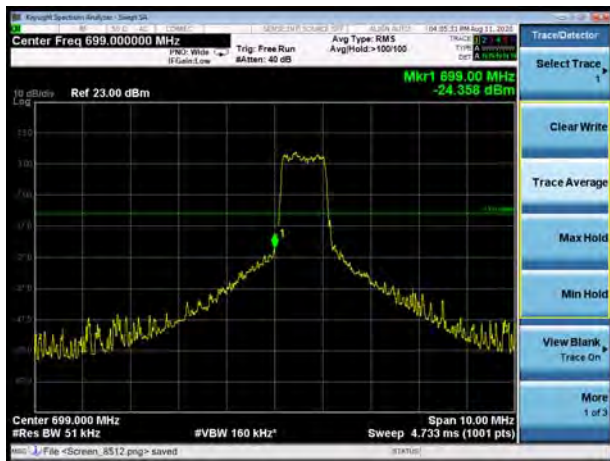

LTE Band 12 16QAM 1.4MHz CH-High, 100%RB

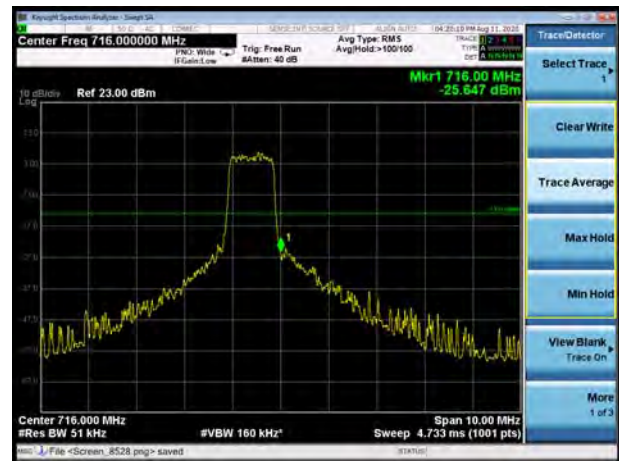

LTE Band 12 16QAM 3MHz CH-Low, 1 RB



LTE Band 12 16QAM 3MHz CH-High, 1 RB

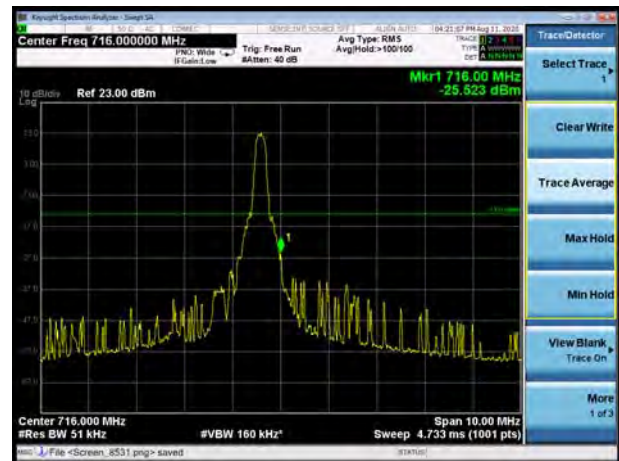

LTE Band 12 16QAM 3MHz CH-Low, 100%RB

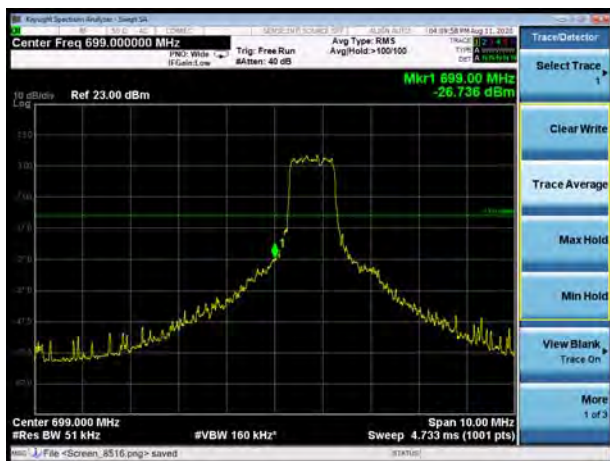

LTE Band 12 16QAM 3MHz CH-High, 100%RB

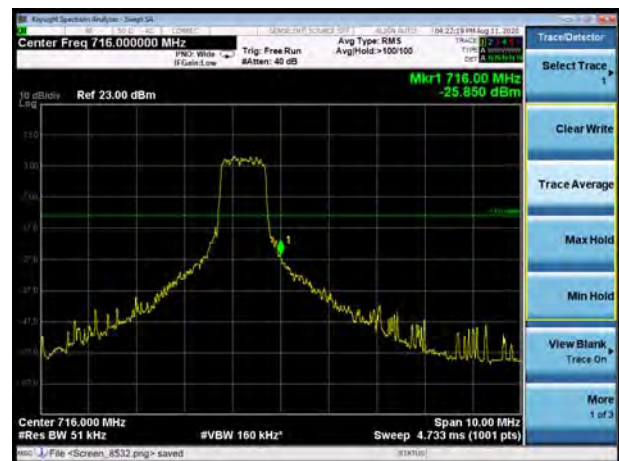

LTE Band 12 16QAM 5MHz CH-Low, 1 RB

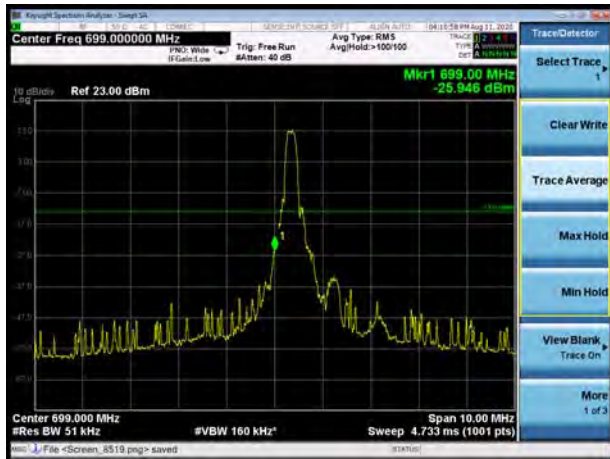

LTE Band 12 16QAM 5MHz CH-High, 1 RB

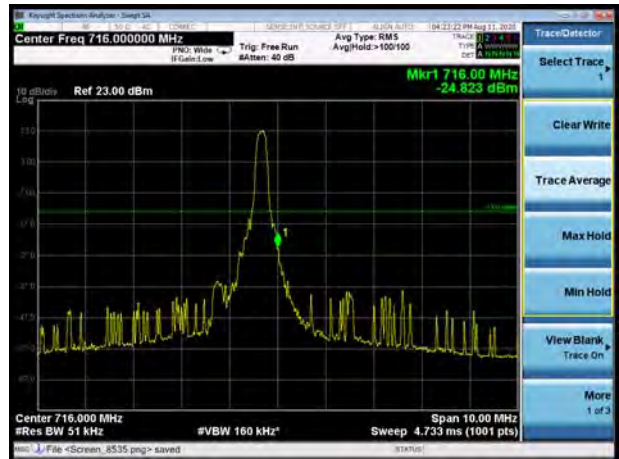

LTE Band 12 16QAM 5MHz CH-Low, 100%RB

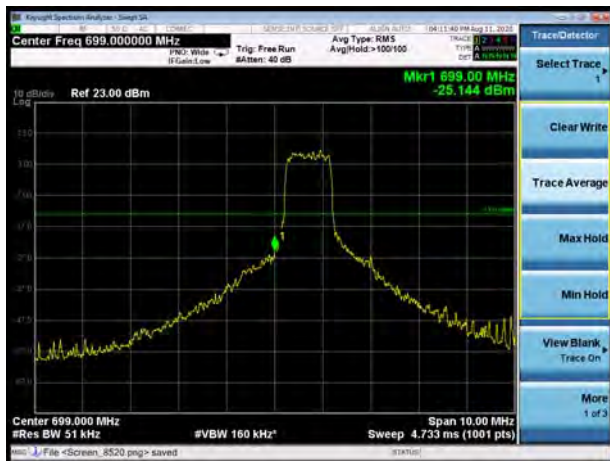

LTE Band 12 16QAM 5MHz CH-High, 100%RB

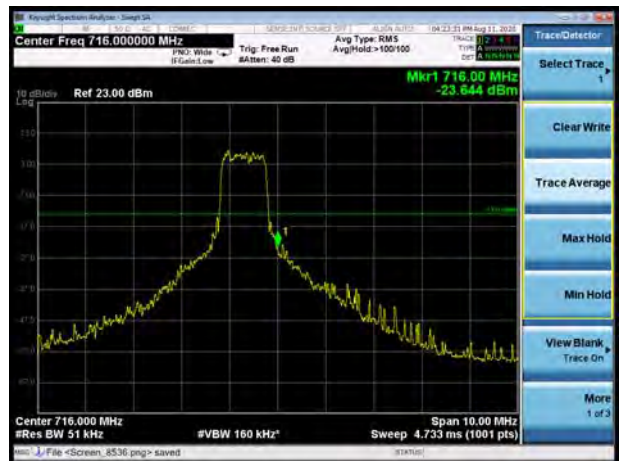

LTE Band 12 16QAM 10MHz CH-Low, 1 RB

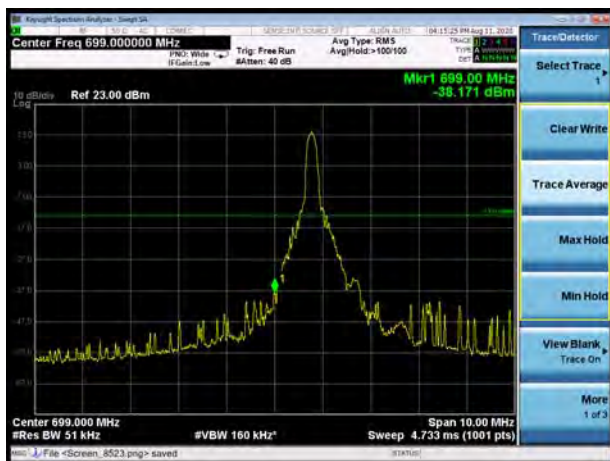

LTE Band 12 16QAM 10MHz CH-High, 1 RB

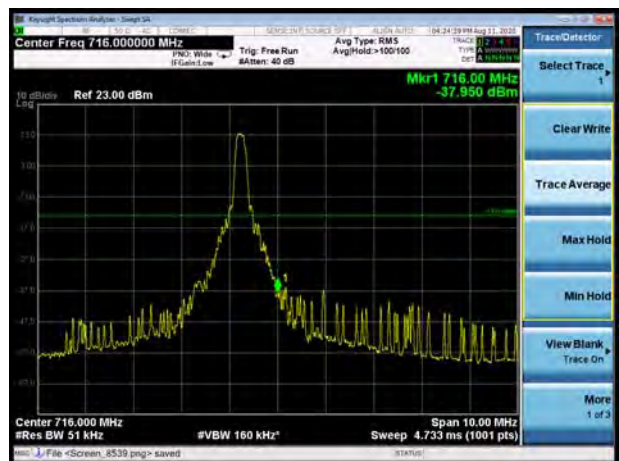



LTE Band 12 16QAM 10MHz CH-Low, 100%RB

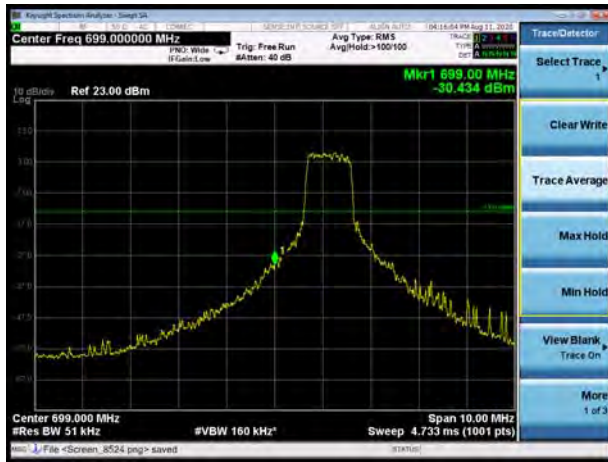

LTE Band 12 16QAM 10MHz CH-High, 100%RB

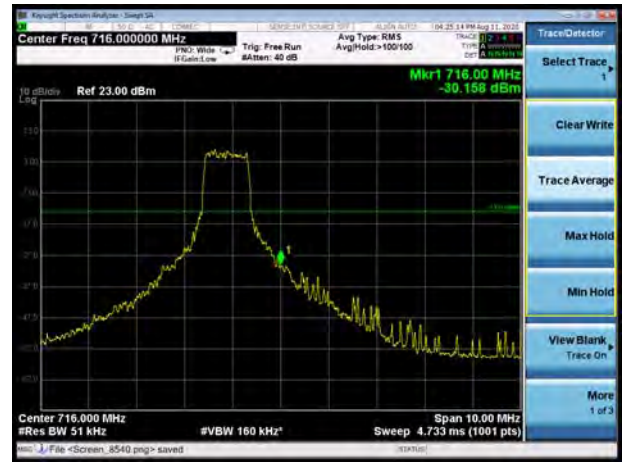

LTE Band 13 QPSK 5MHz CH-Low, 1 RB



LTE Band 13 QPSK 5MHz CH-High, 1 RB



LTE Band 13 QPSK 5MHz CH-Low, 100%RB



LTE Band 13 QPSK 5MHz CH-High, 100%RB



LTE Band 13 QPSK 10MHz CH-Low, 1 RB



LTE Band 13 QPSK 10MHz CH-High, 1 RB



LTE Band 13 QPSK 10MHz CH-Low, 100%RB



LTE Band 13 QPSK 10MHz CH-High, 100%RB



LTE Band 13 16QAM 5MHz CH-Low, 1RB



LTE Band 13 16QAM 5MHz CH-High, 1RB



LTE Band 13 16QAM 5MHz CH- Low, 100%RB



LTE Band 13 16QAM 5MHz CH-High, 100%RB



LTE Band 13 16QAM 10MHz CH-Low, 1RB



LTE Band 13 16QAM 10MHz CH-High, 1RB



LTE Band 13 16QAM 10MHz CH- Low, 100%RB



LTE Band 13 16QAM 10MHz CH-High, 100%RB



4.5 Peak-to-Average Power Ratio (PAPR)

Ambient condition

Temperature	Relative humidity	Pressure
23°C ~25°C	45%~50%	101.5kPa

Methods of Measurement

Measure the total peak power and record as PPk. And measure the total average power and record as PAvg. Both the peak and average power levels must be expressed in the same logarithmic units (e.g., dBm). Determine the PAPR from:

$$\text{PAPR (dB)} = \text{PPk (dBm)} - \text{PAvg (dBm)}.$$

Test Setup

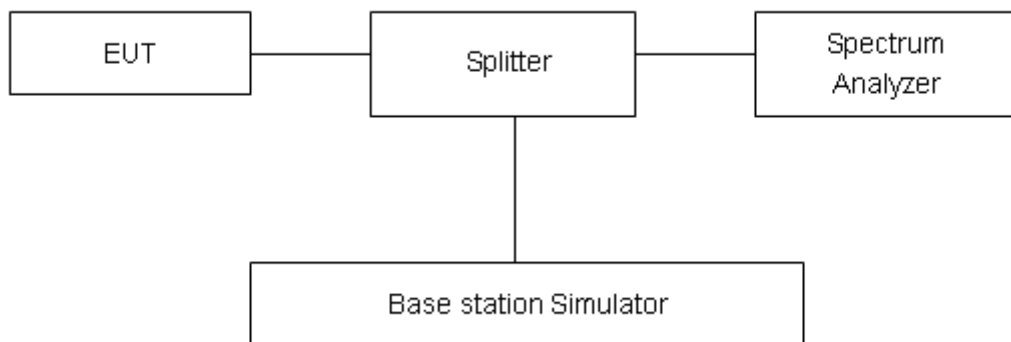

Limits

Rule Part 27.50(d)(5) Equipment employed must be authorized in accordance with the provisions of 24.51. Power measurements for transmissions by stations authorized under this section may be made either in accordance with a Commission-approved average power technique or in compliance with paragraph (d)(6) of this section. In measuring transmissions in this band using an average power technique, the peak-to-average ratio (PAR) of the transmission may not exceed 13 dB.

Measurement Uncertainty

The assessed measurement uncertainty to ensure 95% confidence level for the normal distribution is with the coverage factor $k = 2$, $U = 0.4$ dB.

Test Results

LTE Band 4								
Modulation	Bandwidth (MHz)	Channel	Frequency (MHz)	Peak (dBm)	Avg (dBm)	PAPR (dB)	Limit (dB)	Conclusion
QPSK	1.4	19957	1710.7	31.96	22.13	9.83	≤13	PASS
		20175	1732.5	33.37	22.09	11.28	≤13	PASS
		20393	1754.3	33.44	22.23	11.21	≤13	PASS
	3	19965	1711.5	31.88	22.16	9.72	≤13	PASS
		20175	1732.5	33.56	22.13	11.43	≤13	PASS
		20385	1753.5	32.09	22.26	9.83	≤13	PASS
	5	19975	1712.5	31.94	22.14	9.80	≤13	PASS
		20175	1732.5	32.06	22.12	9.94	≤13	PASS
		20375	1752.5	31.86	22.24	9.62	≤13	PASS
	10	20000	1715	31.79	22.22	9.57	≤13	PASS
		20175	1732.5	31.69	22.14	9.55	≤13	PASS
		20350	1750	31.89	22.28	9.61	≤13	PASS
	15	20025	1717.5	30.24	22.20	8.04	≤13	PASS
		20175	1732.5	30.77	22.10	8.67	≤13	PASS
		20325	1747.5	30.54	22.23	8.31	≤13	PASS
20	20050	1720	30.75	22.17	8.58	≤13	PASS	
	20175	1732.5	30.92	22.05	8.87	≤13	PASS	
	20300	1745	31.12	22.19	8.93	≤13	PASS	
16QAM	1.4	19957	1710.7	32.53	22.06	10.47	≤13	PASS
		20175	1732.5	34.13	22.03	12.10	≤13	PASS
		20393	1754.3	34.20	22.21	11.99	≤13	PASS
	3	19965	1711.5	32.51	22.09	10.42	≤13	PASS
		20175	1732.5	33.94	22.07	11.87	≤13	PASS
		20385	1753.5	32.81	22.24	10.57	≤13	PASS
	5	19975	1712.5	32.31	22.07	10.24	≤13	PASS
		20175	1732.5	32.62	22.03	10.59	≤13	PASS
		20375	1752.5	32.71	22.19	10.52	≤13	PASS
	10	20000	1715	31.15	22.10	9.05	≤13	PASS
		20175	1732.5	32.14	22.08	10.06	≤13	PASS
		20350	1750	31.87	22.23	9.64	≤13	PASS
	15	20025	1717.5	30.96	22.07	8.89	≤13	PASS
		20175	1732.5	30.68	22.03	8.65	≤13	PASS
		20325	1747.5	31.66	22.19	9.47	≤13	PASS
20	20050	1720	30.59	22.05	8.54	≤13	PASS	
	20175	1732.5	31.17	21.99	9.18	≤13	PASS	
	20300	1745	30.98	22.16	8.82	≤13	PASS	

LTE Band 12								
Modulation	Bandwidth (MHz)	Channel	Frequency (MHz)	Peak (dBm)	Avg (dBm)	PAPR (dB)	Limit (dB)	Conclusion
QPSK	1.4	23017	699.7	32.45	22.48	9.97	≤13	PASS
		23095	707.5	32.63	22.66	9.97	≤13	PASS
		23173	715.3	32.75	22.64	10.11	≤13	PASS
	3	23025	700.5	32.77	22.56	10.21	≤13	PASS
		23095	707.5	32.56	22.68	9.88	≤13	PASS
		23165	714.5	34.26	22.68	11.58	≤13	PASS
	5	23035	701.5	32.64	22.54	10.10	≤13	PASS
		23095	707.5	32.27	22.64	9.63	≤13	PASS
		23155	713.5	32.24	22.63	9.61	≤13	PASS
	10	23060	704	31.83	22.51	9.32	≤13	PASS
		23095	707.5	31.88	22.59	9.29	≤13	PASS
		23130	711	31.69	22.59	9.10	≤13	PASS
16QAM	1.4	23017	699.7	33.33	22.71	10.62	≤13	PASS
		23095	707.5	34.21	22.90	11.31	≤13	PASS
		23173	715.3	33.52	22.79	10.73	≤13	PASS
	3	23025	700.5	33.37	22.74	10.63	≤13	PASS
		23095	707.5	33.51	22.95	10.56	≤13	PASS
		23165	714.5	34.84	22.83	12.01	≤13	PASS
	5	23035	701.5	32.95	22.71	10.24	≤13	PASS
		23095	707.5	33.75	22.90	10.85	≤13	PASS
		23155	713.5	33.08	22.79	10.29	≤13	PASS
	10	23060	704	32.98	22.69	10.29	≤13	PASS
		23095	707.5	32.03	22.86	9.17	≤13	PASS
		23130	711	32.54	22.76	9.78	≤13	PASS

LTE Band 13								
Modulation	Bandwidth (MHz)	Channel	Frequency (MHz)	Peak (dBm)	Avg (dBm)	PAPR (dB)	Limit (dB)	Conclusion
QPSK	5	23205	779.5	32.47	22.80	9.67	≤13	PASS
		23230	782	32.64	22.68	9.96	≤13	PASS
		23255	784.5	33.47	22.67	10.80	≤13	PASS
	10	23230	782	32.46	22.77	9.69	≤13	PASS
16QAM	5	23205	779.5	31.94	21.84	10.10	≤13	PASS
		23230	782	32.23	22.19	10.04	≤13	PASS
		23255	784.5	32.85	21.93	10.92	≤13	PASS
	10	23230	782	32.68	22.95	9.73	≤13	PASS

4.6 Frequency Stability

Ambient condition

Temperature	Relative humidity	Pressure
23°C ~25°C	45%~50%	101.5kPa

Method of Measurement

1. Frequency Stability (Temperature Variation)

The temperature inside the climate chamber is varied from -40°C to +85°C in 10°C step size.

(1) With all power removed, the temperature was decreased to -10°C and permitted to stabilize for three hours.

(2) Measure the carrier frequency with the test equipment in a “call mode”. These measurements should be made within 1 minute of powering up the mobile station, to prevent significant self warming.

(3) Repeat the above measurements at 10°C increments from -40°C to +85°C. Allow at least 1.5 hours at each temperature, un-powered, before making measurements.

2. Frequency Stability (Voltage Variation)

The frequency stability shall be measured with variation of primary supply voltage as follows:

(1) Vary primary supply voltage from 85 to 115 percent of the nominal value for other than hand carried battery equipment.

(2) For hand carried, battery powered equipment, reduce primary supply voltage to the battery-operating end point which shall be specified by the manufacturer.

This transceiver is specified to operate with an input voltage of between 3.3 V and 4.3 V, with a nominal voltage of 3.8V.

Test setup

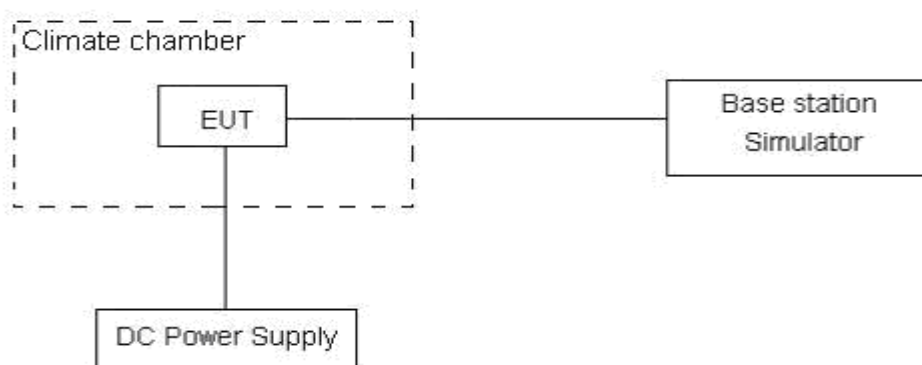

Limits

No specific frequency stability requirements in part 27.54

Measurement Uncertainty

The assessed measurement uncertainty to ensure 99.75% confidence level for the normal distribution is with the coverage factor $k = 3$, $U = 0.01$ ppm.

Test Result

Bandwidth	Test status	LTE Band 4 Channel 20175 Test Results (ppm)	
		QPSK	16QAM
1.4MHz	-40°C/Normal Voltage	-0.00444	-0.01766
	-30°C/Normal Voltage	-0.00386	-0.01513
	-20°C/Normal Voltage	-0.00514	-0.02027
	-10°C/Normal Voltage	-0.00174	-0.01773
	0°C/Normal Voltage	-0.00164	-0.01986
	10°C/Normal Voltage	-0.00239	-0.00601
	20°C/Normal Voltage	0.00020	-0.00454
	30°C/Normal Voltage	-0.00166	-0.00570
	40°C/Normal Voltage	-0.00035	-0.00673
	50°C/Normal Voltage	0.00115	-0.01853
	60°C/Normal Voltage	-0.00061	-0.00405
	70°C/Normal Voltage	-0.00411	-0.01242
	80°C/Normal Voltage	-0.00212	-0.02252
	85°C/Normal Voltage	-0.00124	-0.00496
	20°C/Min Voltage	-0.00300	-0.00576
	20°C/Max Voltage	-0.00315	-0.00454
3MHz	-40°C/Normal Voltage	-0.00127	-0.00275
	-30°C/Normal Voltage	-0.00184	-0.00448
	-20°C/Normal Voltage	0.00117	0.01527
	-10°C/Normal Voltage	0.00008	0.01465
	0°C/Normal Voltage	-0.00119	-0.00583
	10°C/Normal Voltage	-0.00255	-0.01694
	20°C/Normal Voltage	-0.00071	-0.00506
	30°C/Normal Voltage	-0.00063	-0.00412
	40°C/Normal Voltage	-0.00178	-0.00533
	50°C/Normal Voltage	-0.00078	-0.00294
	60°C/Normal Voltage	-0.00163	-0.01732
	70°C/Normal Voltage	-0.00091	0.01451
	80°C/Normal Voltage	-0.00111	-0.00443
	85°C/Normal Voltage	0.00137	-0.00253
	20°C/Min Voltage	0.00068	-0.00301
	20°C/Max Voltage	-0.00234	-0.00293
5MHz	-40°C/Normal Voltage	0.00119	-0.00739
	-30°C/Normal Voltage	0.00248	-0.00478
	-20°C/Normal Voltage	0.00018	-0.00477
	-10°C/Normal Voltage	-0.00357	0.00540



	0°C/Normal Voltage	0.00002	-0.00554
	10°C/Normal Voltage	0.00259	-0.00377
	20°C/Normal Voltage	-0.00129	-0.00622
	30°C/Normal Voltage	-0.00012	-0.00676
	40°C/Normal Voltage	0.00036	0.00380
	50°C/Normal Voltage	-0.00119	-0.00579
	60°C/Normal Voltage	-0.00008	-0.00890
	70°C/Normal Voltage	-0.00115	-0.00618
	80°C/Normal Voltage	-0.00023	-0.00478
	85°C/Normal Voltage	-0.00179	-0.00302
	20°C/Min Voltage	-0.00188	0.00584
	20°C/Max Voltage	-0.00266	0.00141
10MHz	-40°C/Normal Voltage	0.00069	0.00372
	-30°C/Normal Voltage	0.00066	0.00297
	-20°C/Normal Voltage	-0.00119	0.01093
	-10°C/Normal Voltage	-0.00178	0.00982
	0°C/Normal Voltage	0.00127	0.00394
	10°C/Normal Voltage	0.00330	0.00301
	20°C/Normal Voltage	0.00152	0.01114
	30°C/Normal Voltage	0.00156	0.00070
	40°C/Normal Voltage	0.00224	0.01124
	50°C/Normal Voltage	0.00122	0.00386
	60°C/Normal Voltage	-0.00124	0.00870
	70°C/Normal Voltage	-0.00087	0.01063
	80°C/Normal Voltage	-0.00141	0.00606
	85°C/Normal Voltage	-0.00106	0.00305
	20°C/Min Voltage	-0.00190	0.00424
20°C/Max Voltage	-0.00160	0.01408	
15MHz	-40°C/Normal Voltage	0.00057	-0.00057
	-30°C/Normal Voltage	-0.00003	0.00023
	-20°C/Normal Voltage	0.00023	0.00077
	-10°C/Normal Voltage	-0.00110	-0.00147
	0°C/Normal Voltage	0.00182	-0.00067
	10°C/Normal Voltage	-0.00091	0.00086
	20°C/Normal Voltage	0.00169	-0.00042
	30°C/Normal Voltage	0.00042	-0.00301
	40°C/Normal Voltage	-0.00143	-0.00330
	50°C/Normal Voltage	0.00126	-0.00059
	60°C/Normal Voltage	0.00121	-0.00017
	70°C/Normal Voltage	-0.00056	-0.00046



	80°C/Normal Voltage	0.00105	0.00106
	85°C/Normal Voltage	0.00025	-0.00055
	20°C/Min Voltage	-0.00002	-0.00061
	20°C/Max Voltage	0.00123	-0.00216
20MHz	-40°C/Normal Voltage	-0.00081	-0.02835
	-30°C/Normal Voltage	-0.00053	-0.02789
	-20°C/Normal Voltage	-0.00130	-0.02891
	-10°C/Normal Voltage	0.00002	-0.02948
	0°C/Normal Voltage	-0.00100	-0.02863
	10°C/Normal Voltage	0.00290	-0.02879
	20°C/Normal Voltage	-0.00079	-0.02917
	30°C/Normal Voltage	-0.00088	-0.03142
	40°C/Normal Voltage	-0.00241	-0.03015
	50°C/Normal Voltage	0.00066	-0.02809
	60°C/Normal Voltage	0.00032	-0.02992
	70°C/Normal Voltage	-0.00111	-0.02986
	80°C/Normal Voltage	0.00077	-0.02887
	85°C/Normal Voltage	-0.00151	-0.03063
	20°C/Min Voltage	-0.00136	-0.02918
	20°C/Max Voltage	0.00297	-0.02678

Bandwidth	Test status	LTE Band 12Channel 23095 Test Results (ppm)	
		QPSK	16QAM
1.4M	-40°C/Normal Voltage	-0.00582	-0.00338
	-30°C/Normal Voltage	-0.00315	-0.01134
	-20°C/Normal Voltage	-0.00743	-0.00290
	-10°C/Normal Voltage	-0.01025	-0.00325
	0°C/Normal Voltage	-0.00144	-0.00519
	10°C/Normal Voltage	-0.00079	-0.00345
	20°C/Normal Voltage	-0.00287	-0.00647
	30°C/Normal Voltage	-0.00308	-0.00445
	40°C/Normal Voltage	-0.00445	-0.00366
	50°C/Normal Voltage	-0.00411	0.00037
	60°C/Normal Voltage	-0.00223	0.00114
	70°C/Normal Voltage	-0.00192	0.00225
	80°C/Normal Voltage	-0.00257	-0.00076
	85°C/Normal Voltage	-0.00143	-0.00016
	20°C/Min Voltage	0.00037	0.00018
	20°C/Max Voltage	-0.00075	-0.00814
3M	-40°C/Normal Voltage	-0.00160	-0.02580
	-30°C/Normal Voltage	-0.00225	-0.02440
	-20°C/Normal Voltage	-0.00334	-0.02595
	-10°C/Normal Voltage	-0.00411	-0.02786
	0°C/Normal Voltage	-0.00343	-0.02806
	10°C/Normal Voltage	-0.00035	-0.02717
	20°C/Normal Voltage	-0.00117	-0.03013
	30°C/Normal Voltage	-0.00107	-0.02297
	40°C/Normal Voltage	-0.00177	-0.02185
	50°C/Normal Voltage	0.00148	-0.03153
	60°C/Normal Voltage	-0.00040	-0.02669
	70°C/Normal Voltage	0.00119	-0.02451
	80°C/Normal Voltage	-0.00037	-0.02336
	85°C/Normal Voltage	-0.00083	-0.02500
	20°C/Min Voltage	-0.00392	-0.02601
	20°C/Max Voltage	-0.00034	-0.02301
5MHz	-40°C/Normal Voltage	-0.00300	-0.03608
	-30°C/Normal Voltage	-0.00358	-0.03801
	-20°C/Normal Voltage	-0.00165	-0.04188
	-10°C/Normal Voltage	-0.00182	-0.03238
	0°C/Normal Voltage	-0.00225	-0.02841



	10°C/Normal Voltage	-0.00376	-0.04006
	20°C/Normal Voltage	-0.00023	-0.02157
	30°C/Normal Voltage	-0.00059	-0.01495
	40°C/Normal Voltage	-0.00177	-0.01673
	50°C/Normal Voltage	-0.00110	-0.02314
	60°C/Normal Voltage	-0.00414	-0.02293
	70°C/Normal Voltage	0.00170	-0.02475
	80°C/Normal Voltage	0.00024	-0.01739
	85°C/Normal Voltage	-0.00040	-0.02205
	20°C/Min Voltage	0.00365	-0.03228
	20°C/Max Voltage	-0.00274	-0.03902
10MHz	-40°C/Normal Voltage	-0.00411	0.00379
	-30°C/Normal Voltage	-0.00327	0.00582
	-20°C/Normal Voltage	-0.00362	-0.00310
	-10°C/Normal Voltage	-0.00174	-0.00280
	0°C/Normal Voltage	-0.00083	-0.00351
	10°C/Normal Voltage	-0.00202	0.00114
	20°C/Normal Voltage	-0.00194	0.00220
	30°C/Normal Voltage	-0.00016	-0.00488
	40°C/Normal Voltage	-0.00100	-0.00423
	50°C/Normal Voltage	-0.00232	0.00377
	60°C/Normal Voltage	-0.00271	-0.00411
	70°C/Normal Voltage	-0.00400	-0.00150
	80°C/Normal Voltage	0.00120	0.00522
	85°C/Normal Voltage	-0.00137	0.00083
	20°C/Min Voltage	0.00259	-0.00408
20°C/Max Voltage	-0.00250	0.00533	

Bandwidth	Test status	LTE Band 13 Channel 23230 Test Results (ppm)	
		QPSK	16QAM
5MHz	-40°C/Normal Voltage	0.00022	-0.02604
	-30°C/Normal Voltage	-0.00203	-0.02249
	-20°C/Normal Voltage	-0.00272	-0.00797
	-10°C/Normal Voltage	-0.00165	0.03445
	0°C/Normal Voltage	-0.00018	0.03297
	10°C/Normal Voltage	-0.00093	-0.02716
	20°C/Normal Voltage	-0.00330	-0.03679
	30°C/Normal Voltage	-0.00271	-0.00685
	40°C/Normal Voltage	-0.00263	-0.00830
	50°C/Normal Voltage	-0.00049	-0.01060
	60°C/Normal Voltage	-0.00203	-0.01101
	70°C/Normal Voltage	0.00084	-0.01442
	80°C/Normal Voltage	0.00040	-0.02146
	85°C/Normal Voltage	-0.00301	-0.02216
	20°C/Min Voltage	-0.00225	-0.02006
	20°C/Max Voltage	-0.00334	-0.02955
10MHz	-40°C/Normal Voltage	-0.00396	-0.01558
	-30°C/Normal Voltage	-0.00301	-0.01306
	-20°C/Normal Voltage	-0.00224	-0.01606
	-10°C/Normal Voltage	-0.00465	-0.01453
	0°C/Normal Voltage	-0.00260	-0.01353
	10°C/Normal Voltage	-0.00377	-0.01633
	20°C/Normal Voltage	0.00173	-0.01482
	30°C/Normal Voltage	0.00276	-0.01651
	40°C/Normal Voltage	-0.00032	-0.01604
	50°C/Normal Voltage	-0.00161	-0.01311
	60°C/Normal Voltage	-0.00087	-0.01611
	70°C/Normal Voltage	-0.00093	-0.01573
	80°C/Normal Voltage	0.00185	-0.01488
	85°C/Normal Voltage	0.00023	-0.01517
	20°C/Min Voltage	-0.00132	-0.01306
	20°C/Max Voltage	-0.00390	-0.01573

4.7 Spurious Emissions at Antenna Terminals

Ambient condition

Temperature	Relative humidity	Pressure
23°C ~25°C	45%~50%	101.5kPa

Method of Measurement

The EUT was connected to Spectrum Analyzer and Base Station Simulator via power Splitter. The measurement is carried out using a spectrum analyzer. The spectrum analyzer scans from 30MHz to the 10th harmonic of the carrier. The peak detector is used. Set RBW 1MHz and VBW 3MHz, Sweep is set to ATUO.

Of those disturbances below (limit – 20 dB), the mark is not required for the EUT.

Test setup

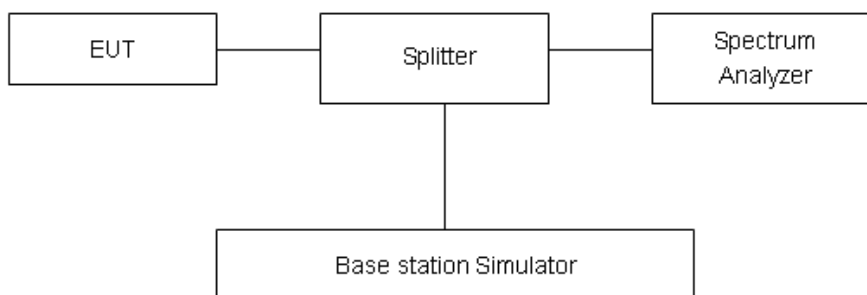

Limits

LTE -4 Rule Part 27.53(h) specifies that “for operations in the 1695-1710 MHz, 1710-1755 MHz, 1755-1780 MHz, 1915-1920 MHz, 1995-2000 MHz, 2000-2020 MHz, 2110-2155 MHz, 2155-2180 MHz, and 2180-2200 bands, the power of any emission outside a licensee's frequency block shall be attenuated below the transmitter power (P) in watts by at least $43 + 10 \log_{10}(P)$ dB..”

LTE -12 Rule Part 27.53 (g) For operations in the 600 MHz band and the 698-746 MHz band, the power of any emission outside a licensee's frequency band(s) of operation shall be attenuated below the transmitter power (P) within the licensed band(s) of operation, measured in watts, by at least $43 + 10 \log(P)$ dB. Compliance with this provision is based on the use of measurement instrumentation employing a resolution bandwidth of 100 kilohertz or greater. However, in the 100 kilohertz bands immediately outside and adjacent to a licensee's frequency block, a resolution bandwidth of at least 30 kHz may be employed.

LTE -13 Rule Part 27.53(f) For operations in the 746-758 MHz, 775-788 MHz, and 805-806 MHz bands, emissions in the band 1559-1610 MHz shall be limited to -70 dBW/MHz equivalent isotropically radiated power (EIRP) for wideband signals, and -80 dBW EIRP for discrete emissions of less than 700 Hz bandwidth. For the purpose of equipment authorization, a transmitter shall be



tested with an antenna that is representative of the type that will be used with the equipment in normal operation.

LTE B4/12 Limit

Limit	-13 dBm
-------	---------

LTE B13 Limit

Limitout of the band 1559-1610 MHz	-13 dBm
Limitin the band 1559-1610 MHz	-40 dBm

Measurement Uncertainty

The assessed measurement uncertainty to ensure 99.75% confidence level for the normal distribution is with the coverage factor $k = 1.96$.

Frequency	Uncertainty
100kHz-2GHz	0.684 dB
2GHz-12.75GHz	1.407 dB



Test Result: PASS

LTE Band 41.4MHz CH-Low30MHz~3GHz

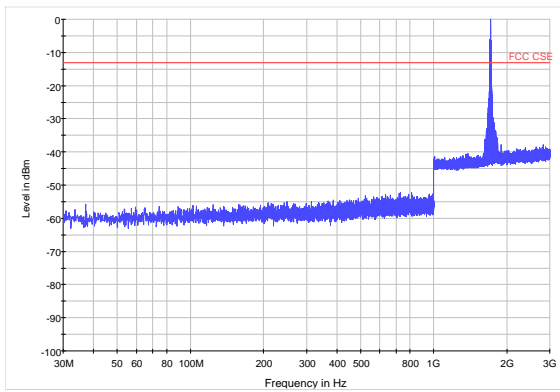

LTE Band 4 1.4MHz CH-Low3GHz~18GHz

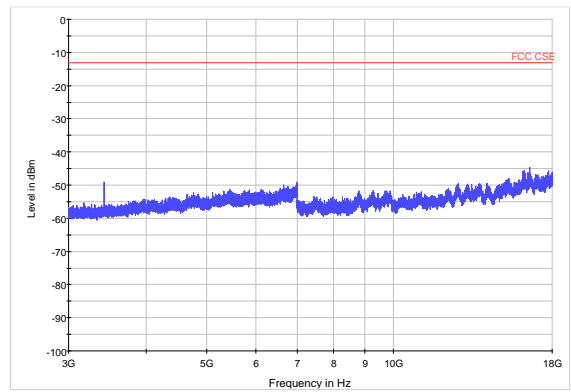

LTE Band 4 1.4MHz CH-Middle30MHz~3GHz

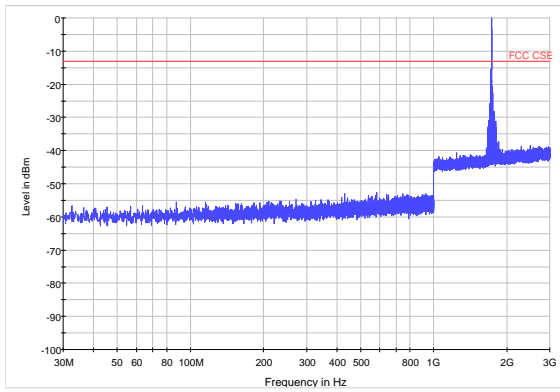

LTE Band 4 1.4MHz CH-Middle3GHz~18GHz

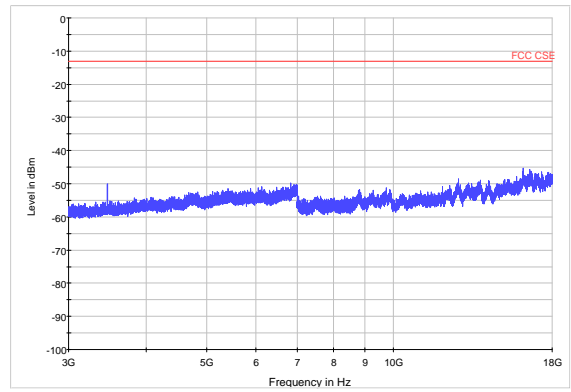

LTE Band 4 1.4MHz CH-High 30MHz~3GHz

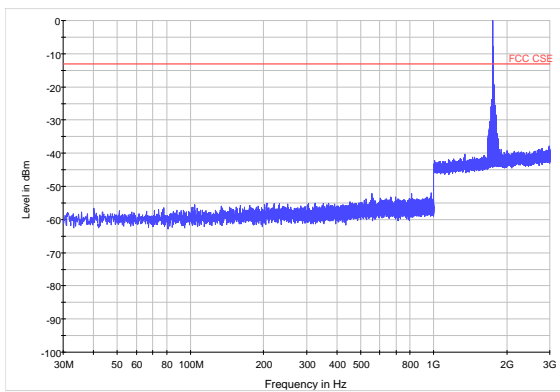

LTE Band 4 1.4MHz CH-High 3GHz~18GHz

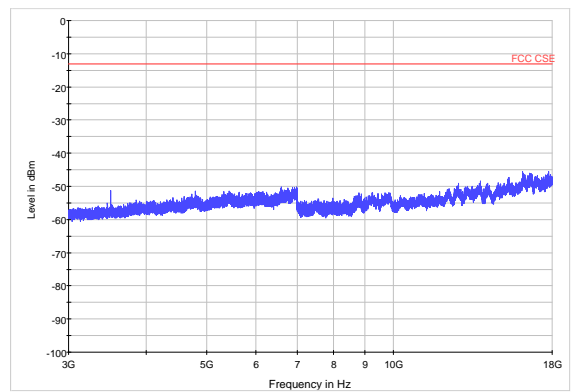



LTE Band 4 3MHzCH-Low 30MHz~3GHz

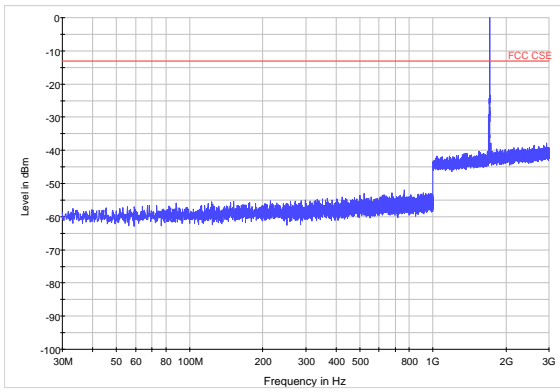

LTE Band 4 3MHzCH-Low 3GHz~18GHz

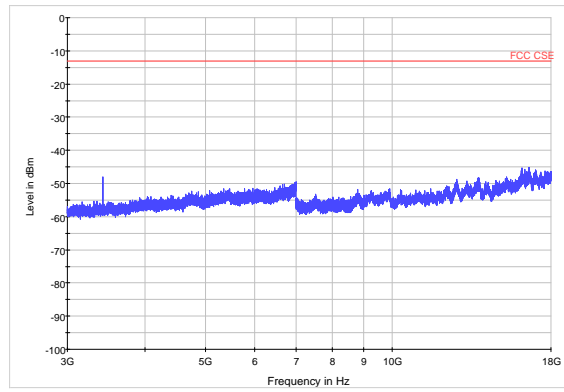

LTE Band 4 3MHzCH-Middle 30MHz~3GHz

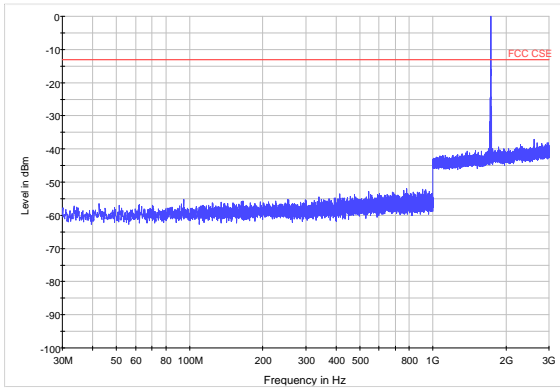

LTE Band 4 3MHzCH-Middle 3GHz~18GHz

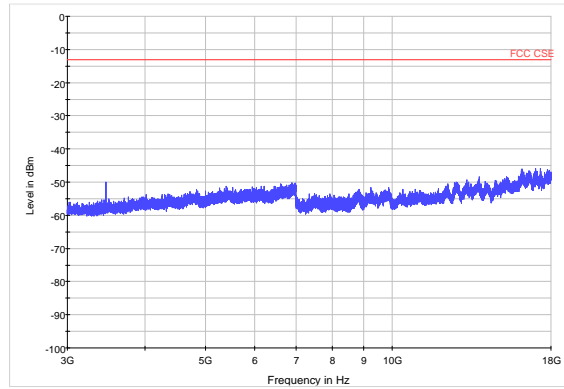

LTE Band 4 3MHzCH-High 30MHz~3GHz

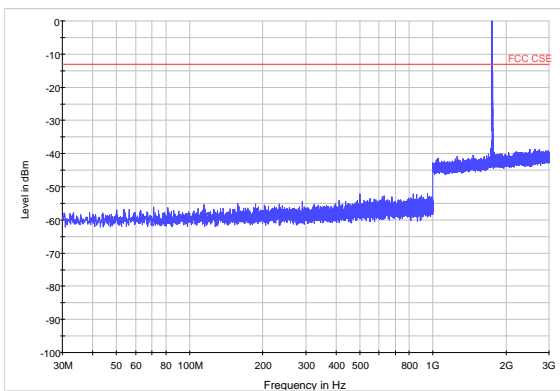

LTE Band 4 3MHzCH-High 3GHz~18GHz

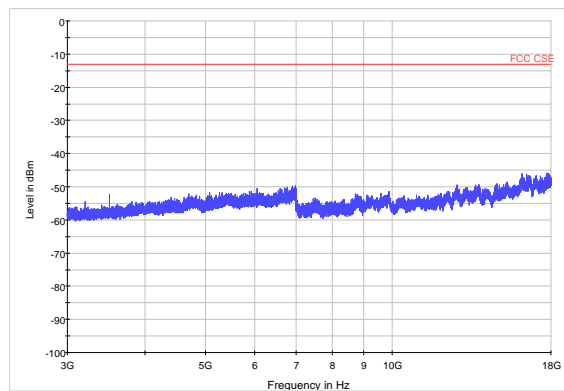



LTE Band 4 5MHz CH-Low 30MHz~3GHz

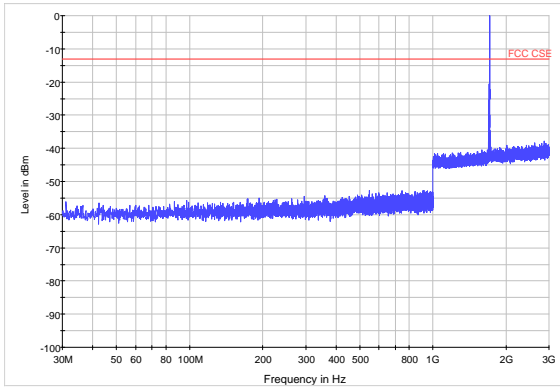

LTE Band 4 5MHz CH-Low 3GHz~18GHz

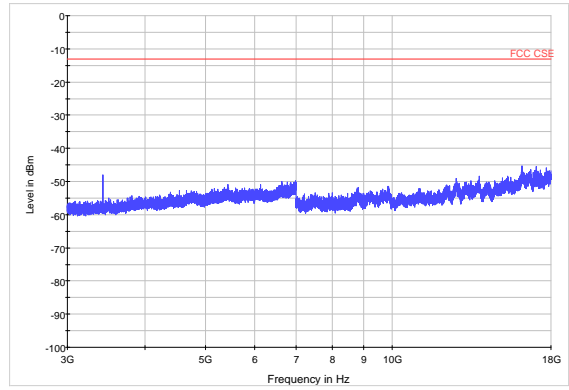

LTE Band 4 5MHz CH-Middle 30MHz~3GHz

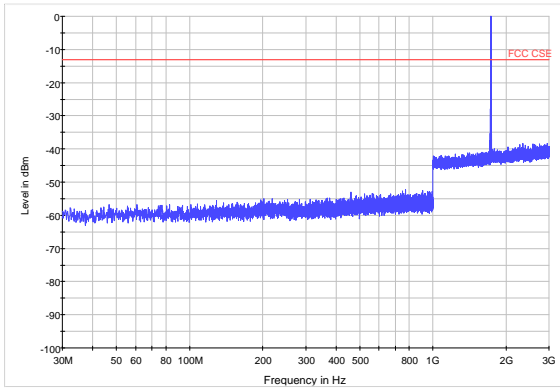

LTE Band 4 5MHz CH-Middle 3GHz~18GHz

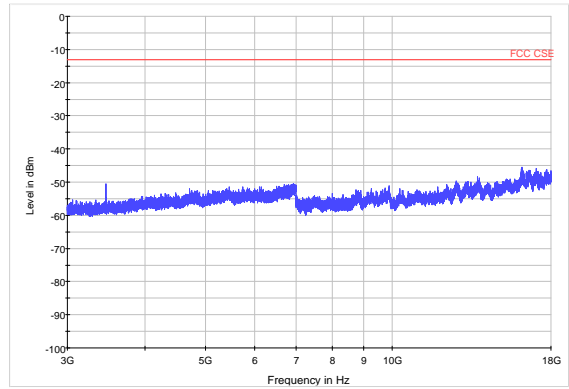

LTE Band 4 5MHz CH-High 30MHz~3GHz

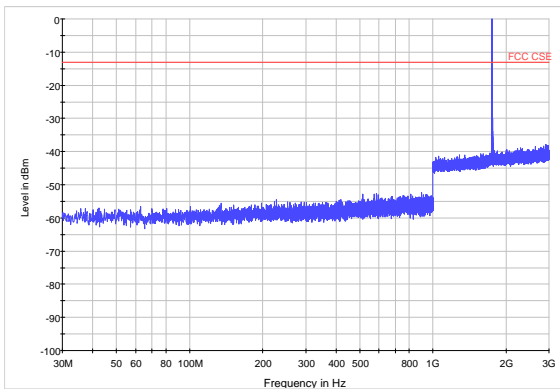

LTE Band 4 5MHz CH-High 3GHz~18GHz

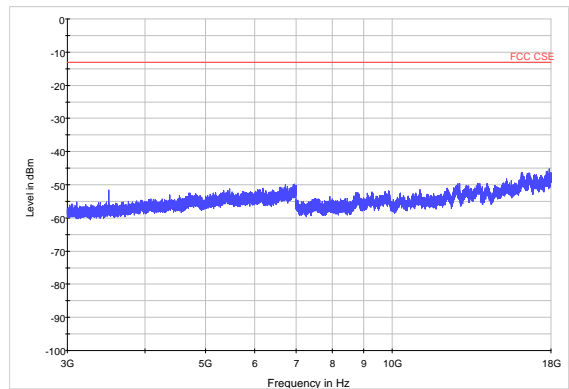



LTE Band 4 10MHz CH-Low 30MHz~3GHz

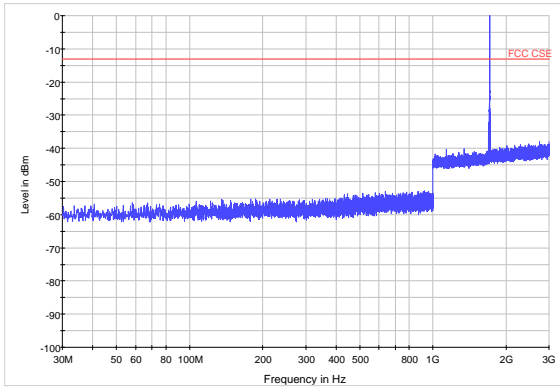

LTE Band 4 10MHz CH-Low 3GHz~18GHz

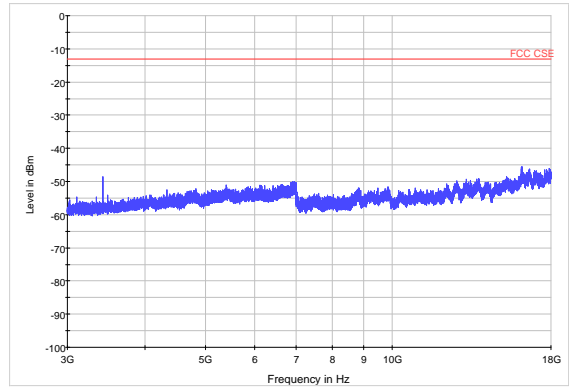

LTE Band 4 10MHz CH-Middle 30MHz~3GHz

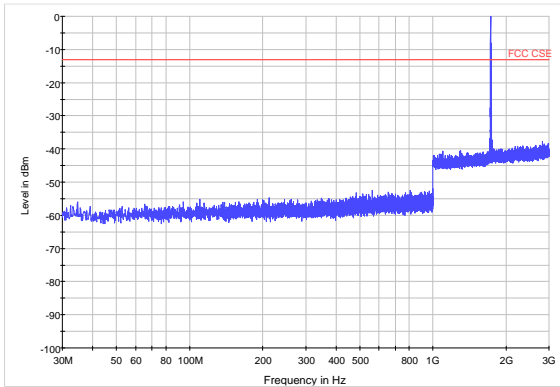

LTE Band 4 10MHz CH-Middle 3GHz~18GHz

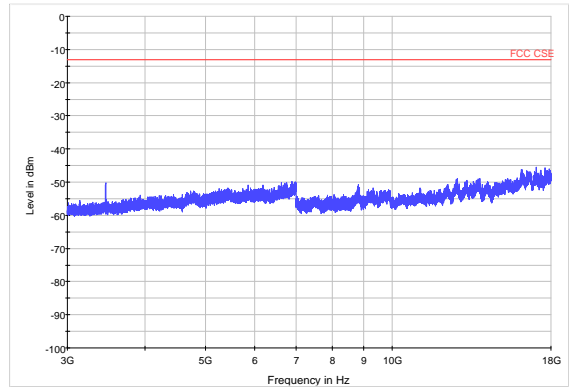

LTE Band 4 10MHz CH-High 30MHz~3GHz

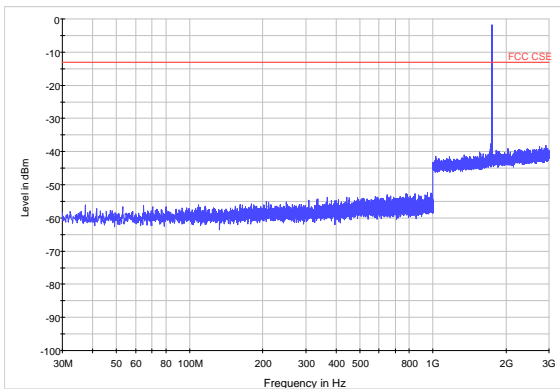

LTE Band 4 10MHz CH-High 3GHz~18GHz

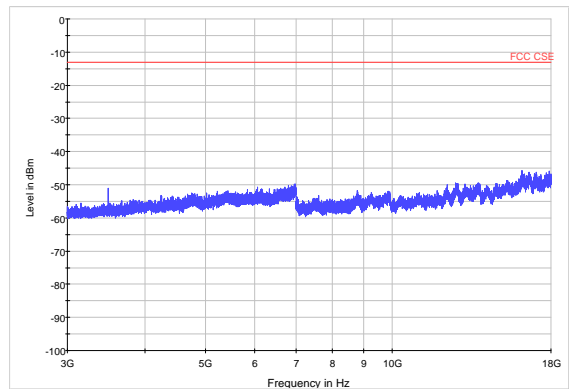



LTE Band 415MHz CH-Low30MHz~3GHz

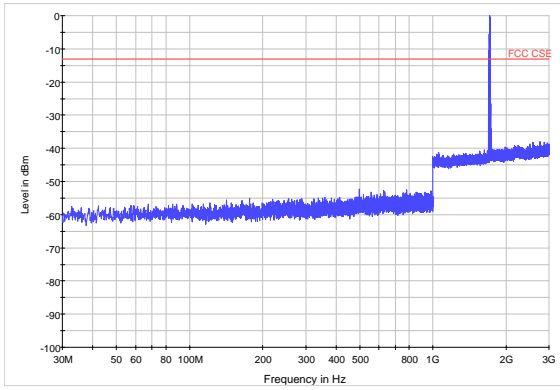

LTE Band 415MHz CH-Low3GHz~18GHz

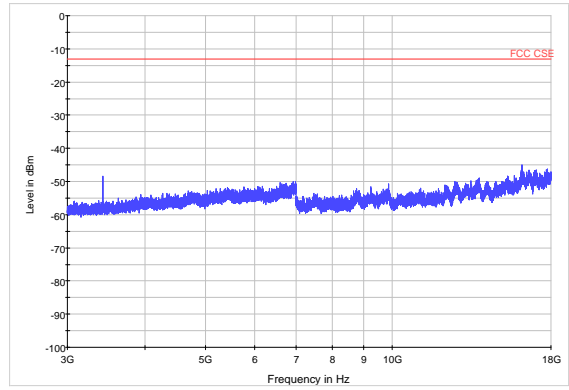

LTE Band 4 15MHz CH-Middle 30MHz~3GHz

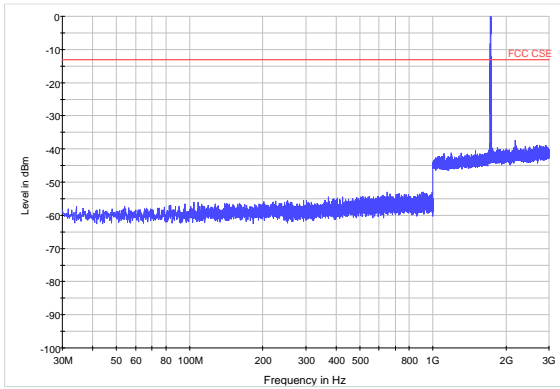

LTE Band 4 15MHz CH-Middle 3GHz~18GHz

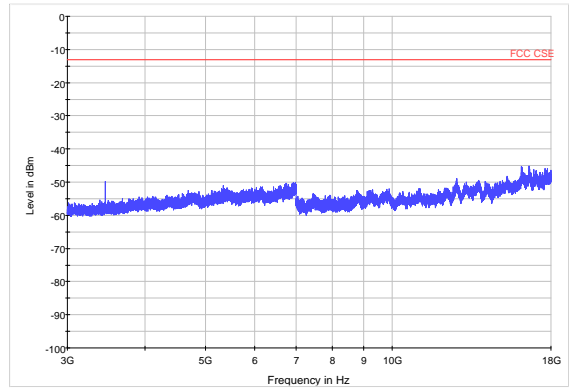

LTE Band 4 15MHz CH-High 30MHz~3GHz

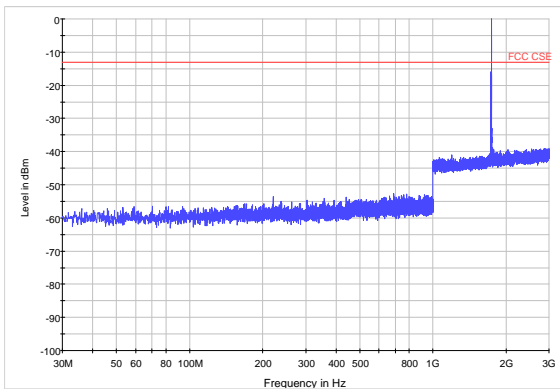

LTE Band 4 15MHz CH-High 3GHz~18GHz

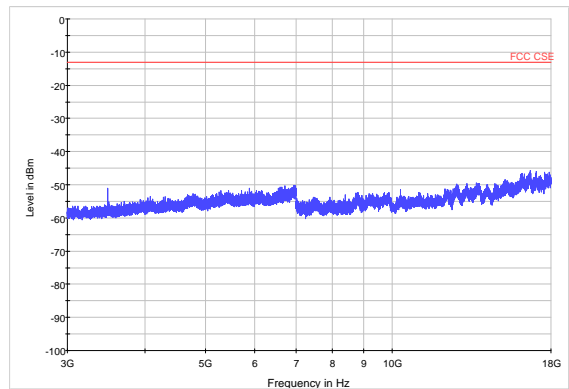



LTE Band 4 20MHz CH-Low30MHz~3GHz

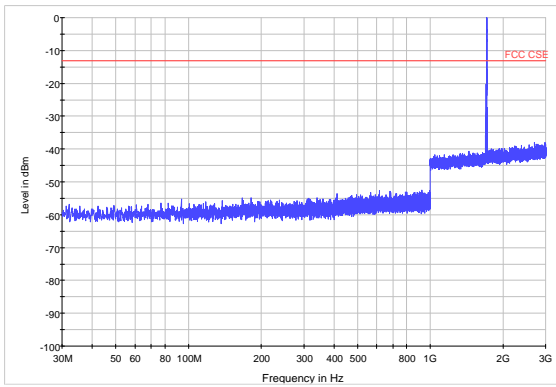

LTE Band 4 20MHz CH-Low3GHz~18GHz

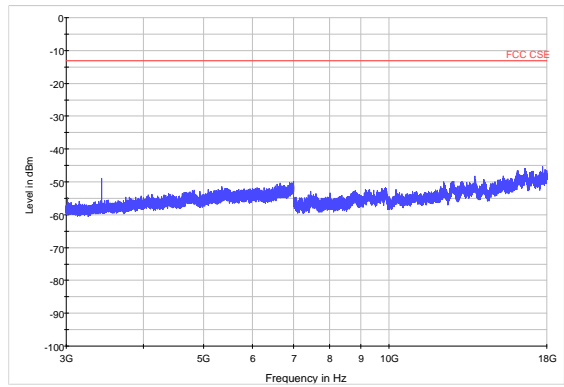

LTE Band 4 20MHz CH-Middle 30MHz~3GHz

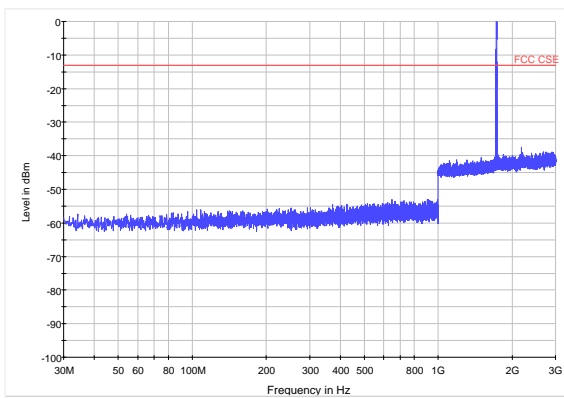

LTE Band 4 20MHz CH-Middle 3GHz~18GHz

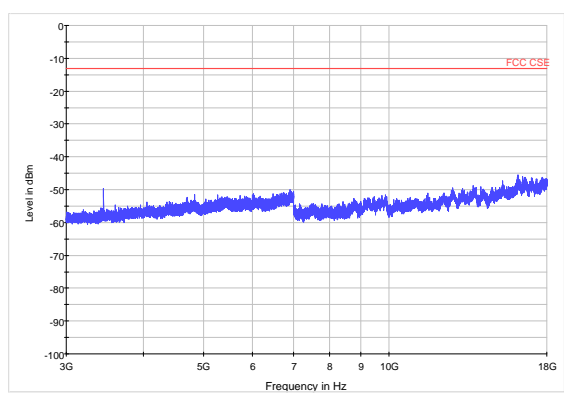

LTE Band 4 20MHz CH-High30MHz~3GHz

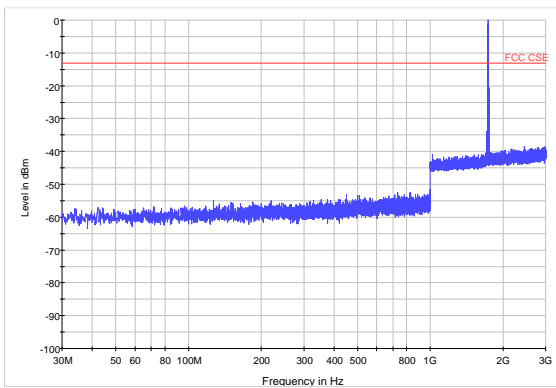

LTE Band 4 20MHz CH-High 3GHz~18GHz

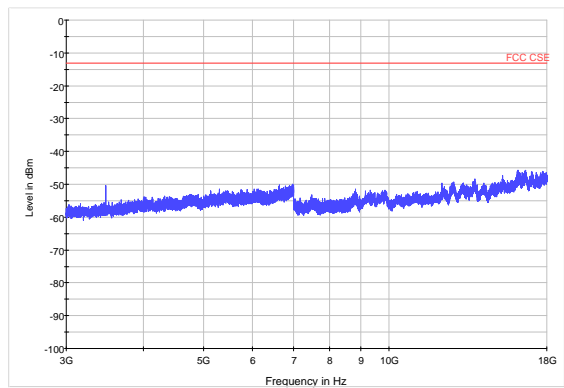



LTE Band 12 1.4MHz CH-Low30MHz~1GHz

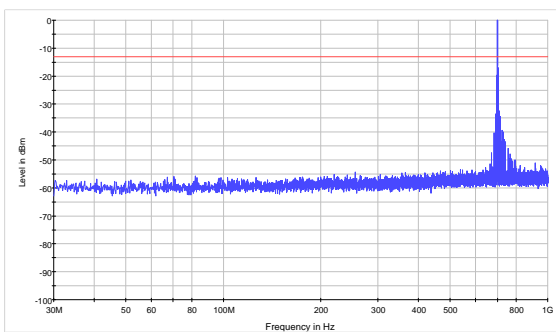

LTE Band 121.4MHzCH-Middle 30MHz~1GHz

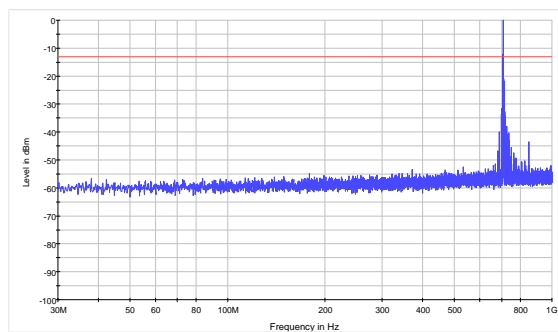

LTE Band 12 1.4MHz CH-Low1GHz~3GHz

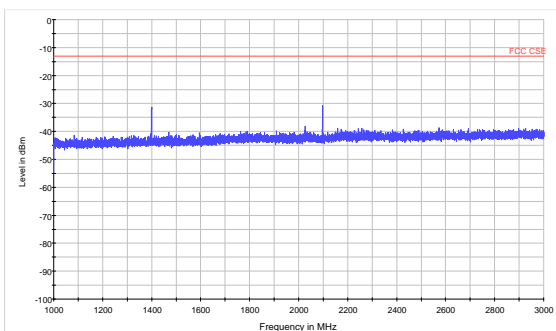

LTE Band 121.4MHzCH-Middle 1GHz~3GHz

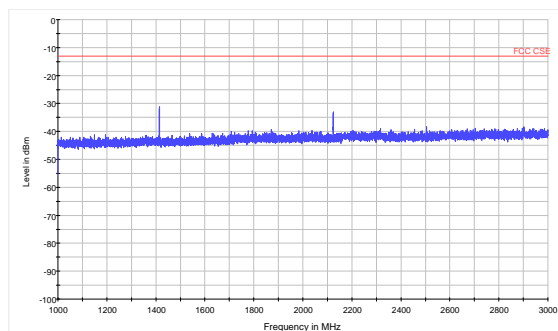

LTE Band 12 1.4MHz CH-Low3GHz~8GHz

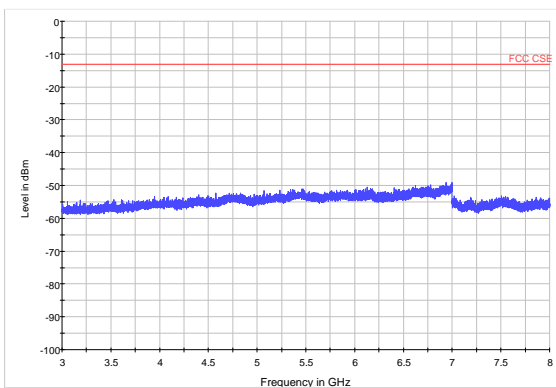

LTE Band 121.4MHzCH-Middle3GHz~8GHz

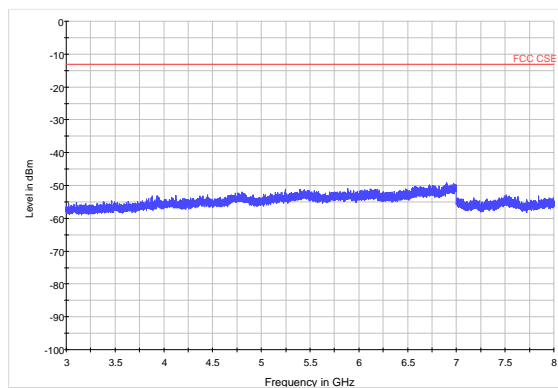



LTE Band 12 1.4MHz CH-High30MHz~1GHz

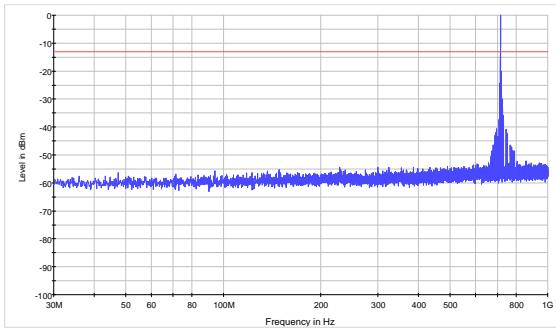

LTE Band 12 3MHz CH-Low30MHz~1GHz

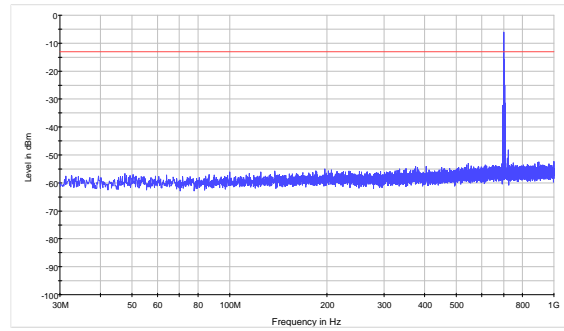

LTE Band 12 1.4MHz CH-High1GHz~3GHz

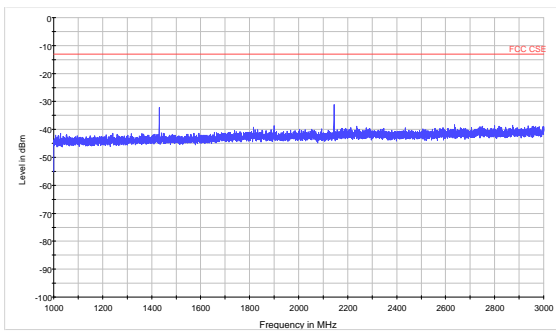

LTE Band 12 3MHz CH-Low1GHz~3GHz

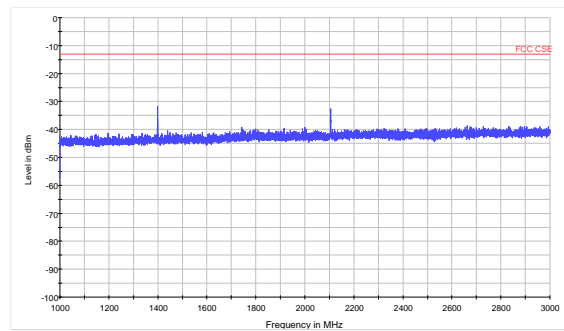

LTE Band 12 1.4MHz CH-High3GHz~8GHz

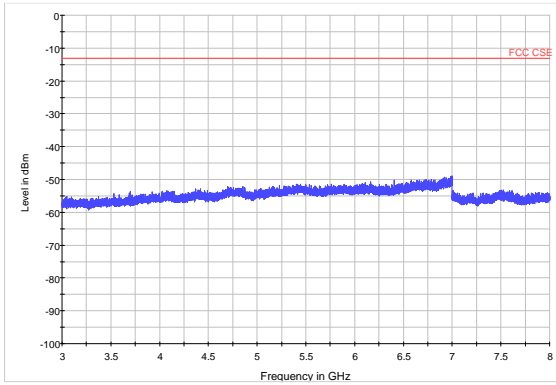

LTE Band 12 3MHz CH-Low3GHz~8GHz

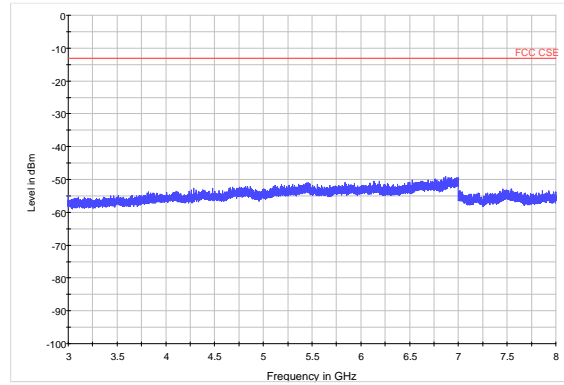



LTE Band 123MHzCH-Middle 30MHz~1GHz

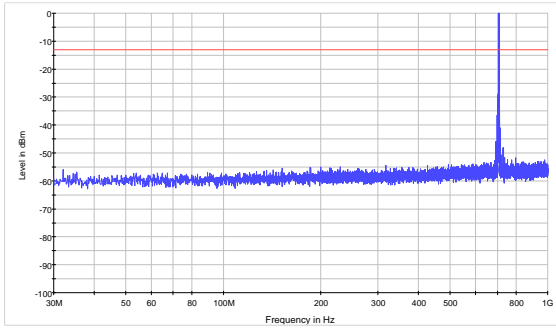

LTE Band 123MHz CH-High30MHz~1GHz

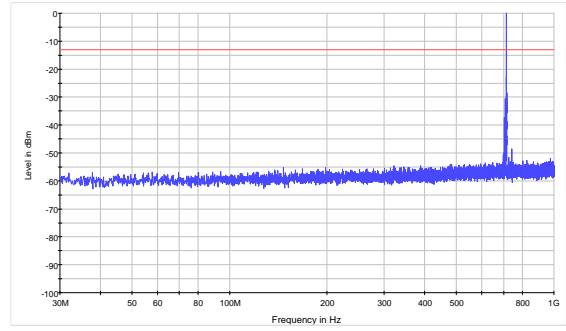

LTE Band 123MHzCH-Middle 1GHz~3GHz

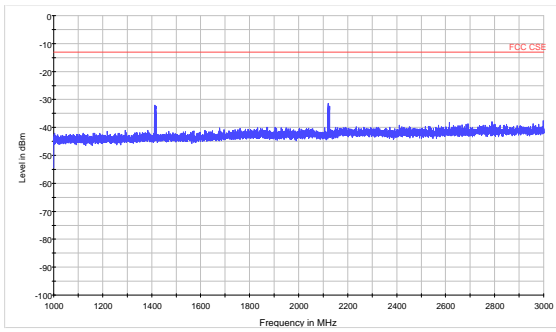

LTE Band 12 3MHz CH-High1GHz~3GHz

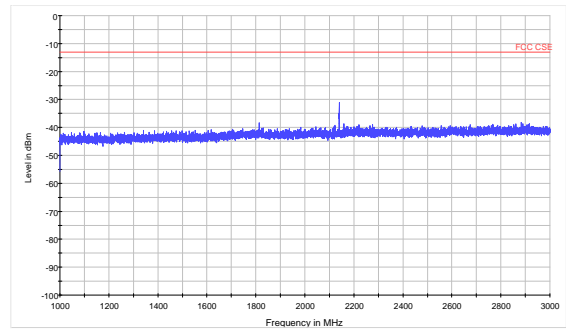

LTE Band 123MHzCH-Middle3GHz~8GHz

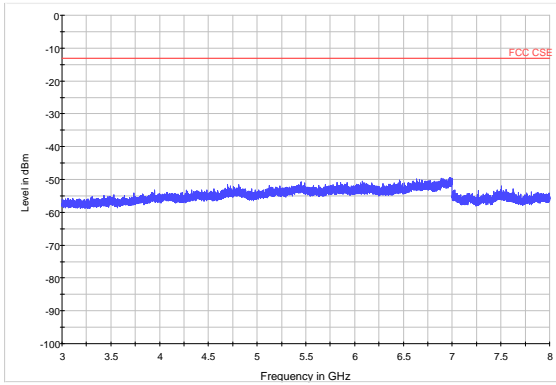

LTE Band 12 3MHz CH-High3GHz~8GHz

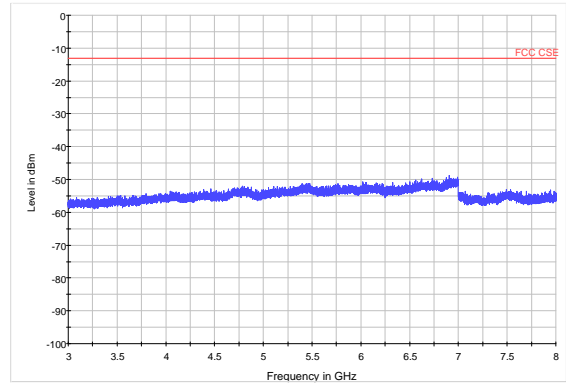



LTE Band 125MHzCH-Low30MHz~1GHz

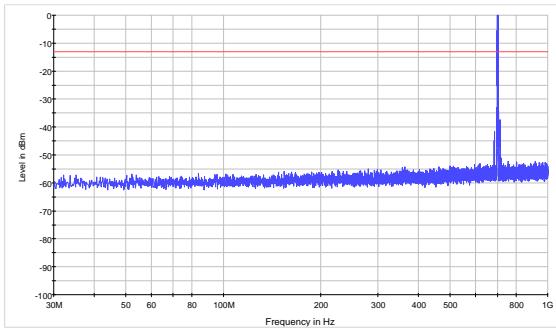

LTE Band 125MHzCH-Middle 30MHz~1GHz

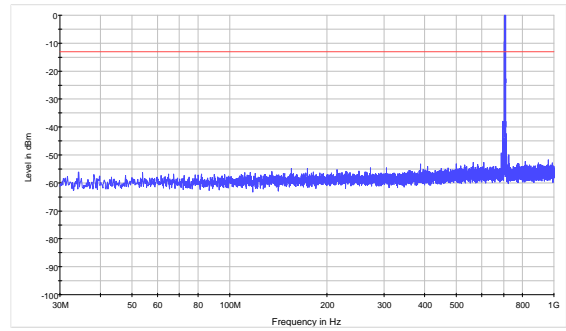

LTE Band 125MHzCH-Low1GHz~3GHz

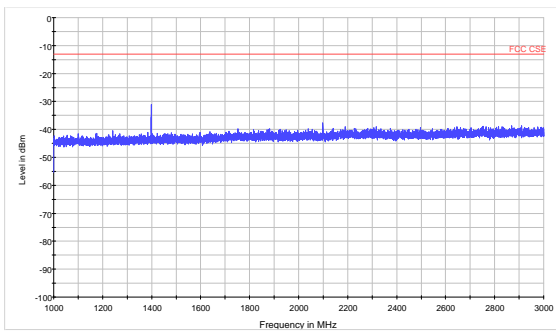

LTE Band 125MHzCH-Middle 1GHz~3GHz

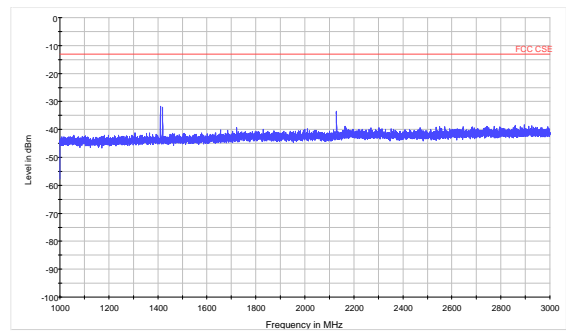

LTE Band 125MHzCH-Low3GHz~8GHz

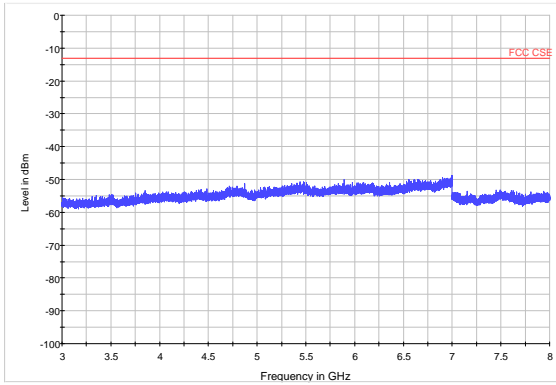

LTE Band 125MHzCH-Middle3GHz~8GHz

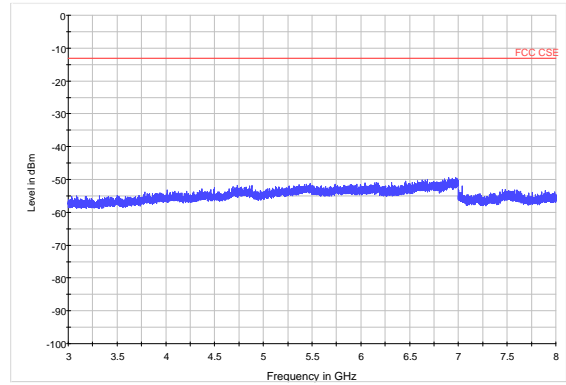



LTE Band 125MHzCH-High30MHz~1GHz

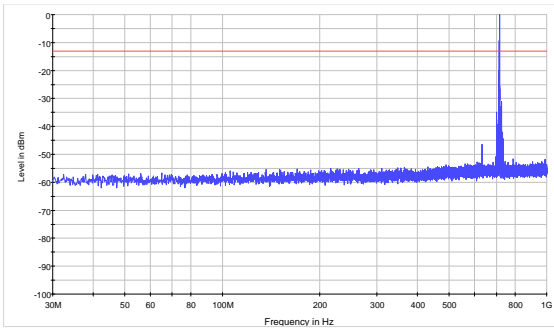

LTE Band 1210MHzCH-Low 30MHz~1GHz

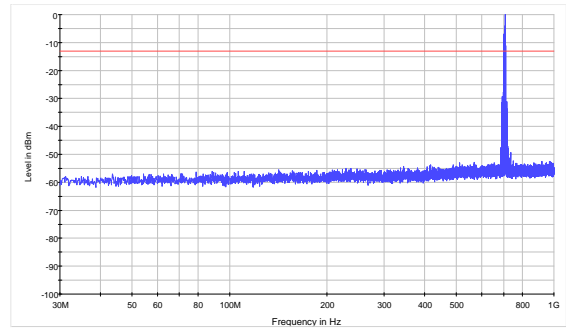

LTE Band 125MHzCH-High 1GHz~3GHz

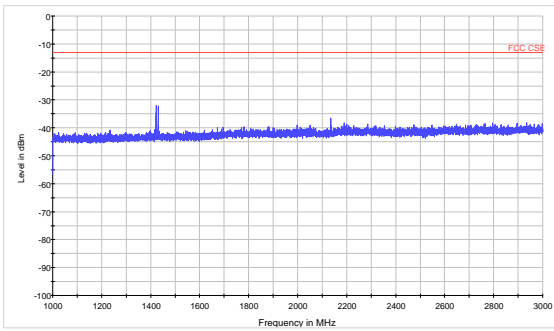

LTE Band 1210MHzCH-Low 1GHz~3GHz

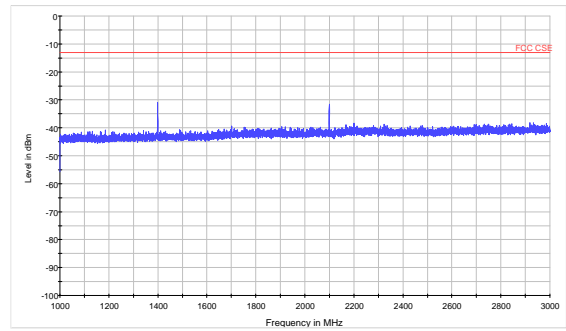

LTE Band 125MHzCH-High3GHz~8GHz

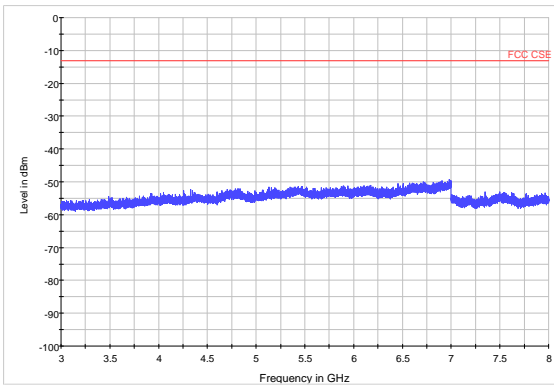

LTE Band 1210MHzCH-Low3GHz~8GHz

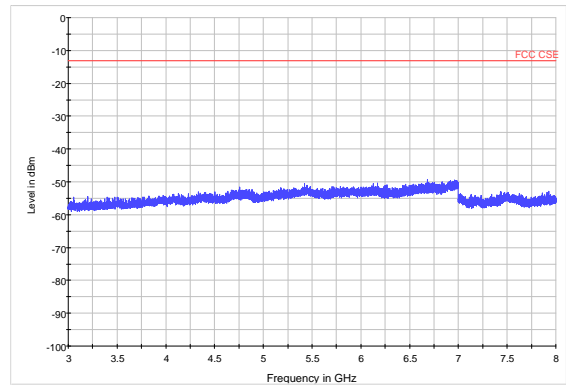



LTE Band 1210MHzCH-Middle 30MHz~1GHz

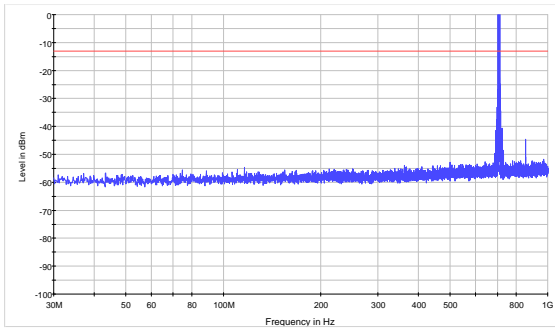

LTE Band 1210MHzCH-High 30MHz~1GHz

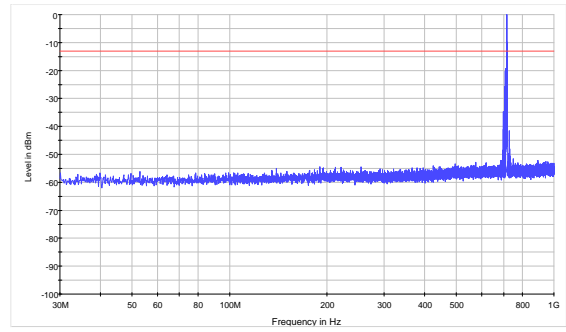

LTE Band 1210MHzCH-Middle 1GHz~3GHz

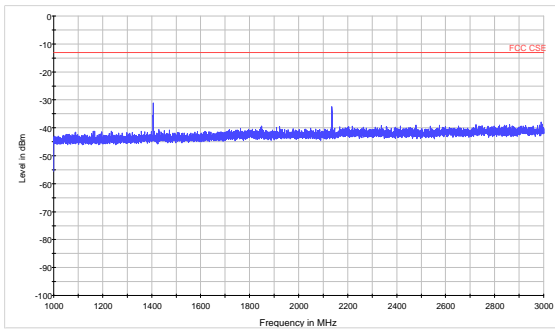

LTE Band 1210MHzCH-High 1GHz~3GHz

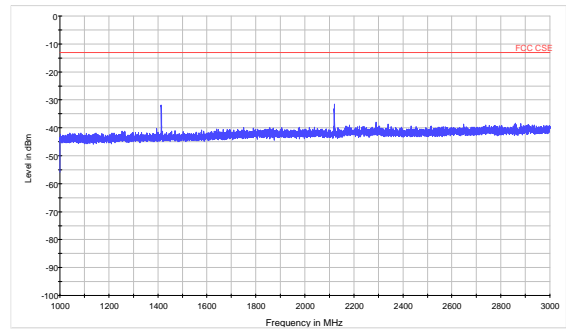

LTE Band 1210MHzCH-Middle 3GHz~8GHz

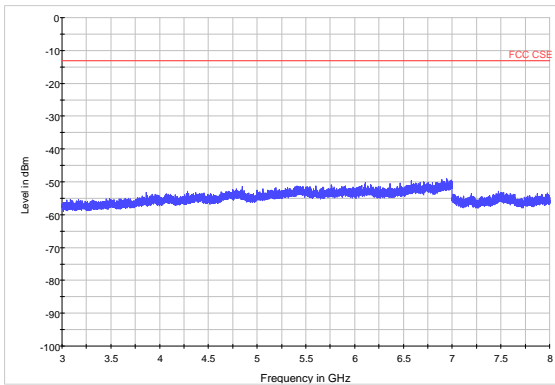

LTE Band 1210MHzCH-High 3GHz~8GHz

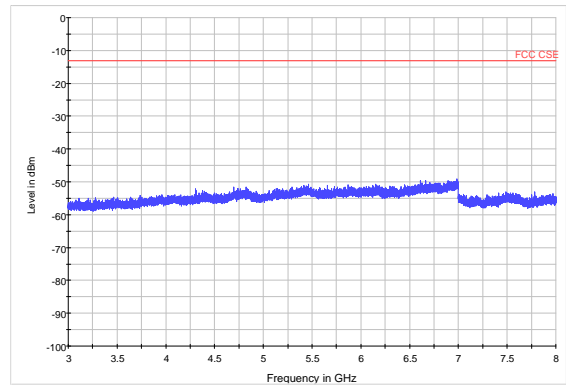



LTE Band 135MHz CH-Low 30MHz~3GHz

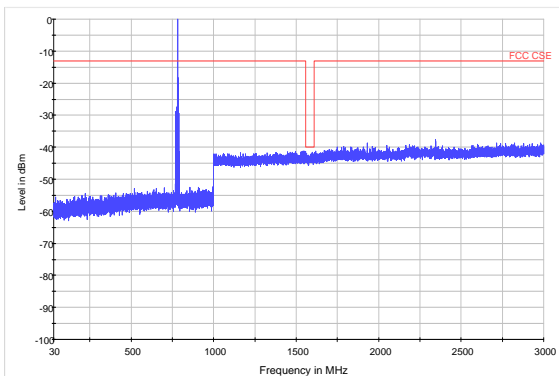

LTE Band 135MHz CH-Low 3GHz~8GHz

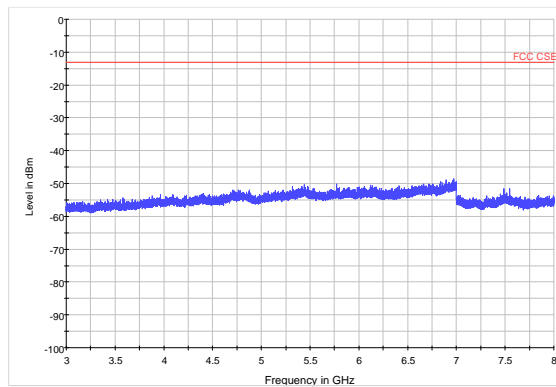

LTE Band 135MHz CH-Middle 30MHz~3GHz

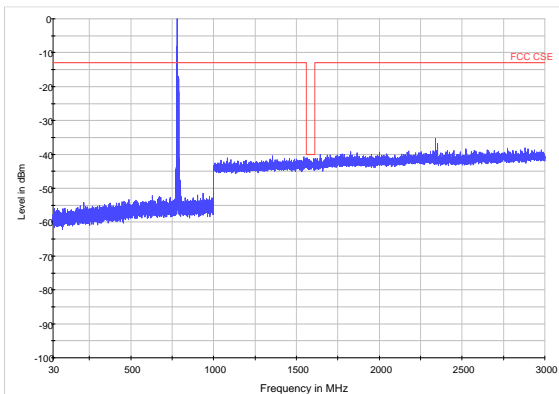

LTE Band 135MHz CH-Middle 3GHz~8GHz

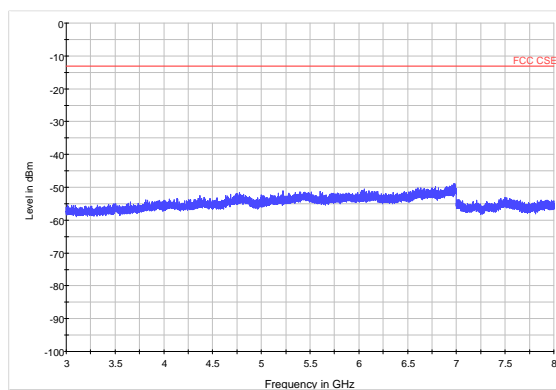

LTE Band 135MHz CH-High 30MHz~3GHz

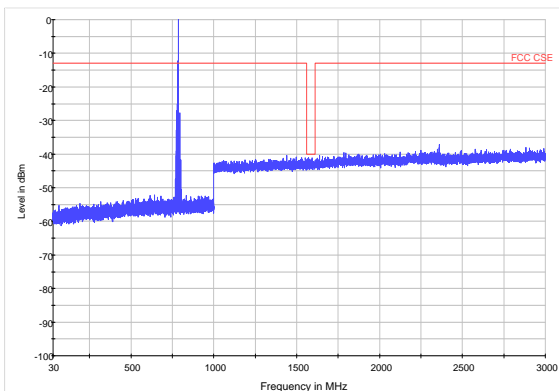

LTE Band 135MHz CH-High 3GHz~8GHz

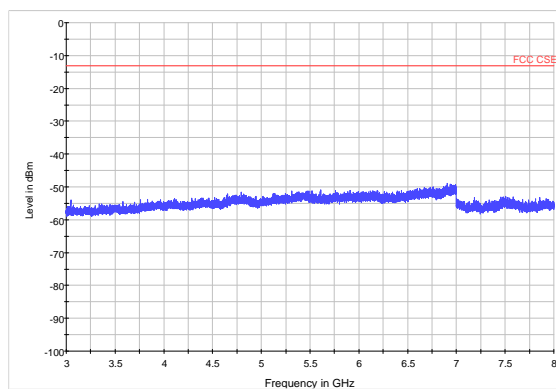



LTE Band 1310MHz CH-Low 30MHz~3GHz

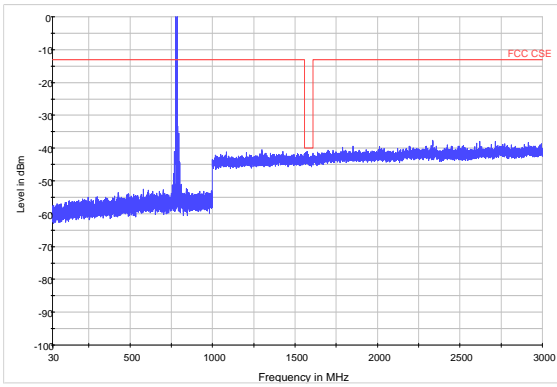

LTE Band 1310MHz CH-Low 3GHz~8GHz

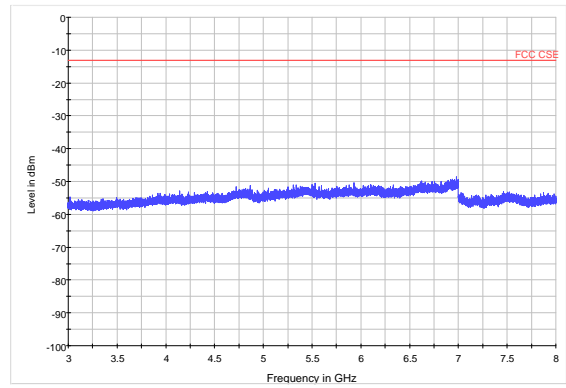

LTE Band 1310MHz CH-Middle 30MHz~3GHz

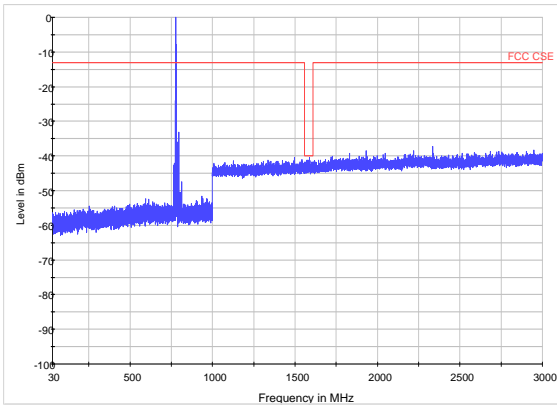

LTE Band 1310MHz CH-Middle 3GHz~8GHz

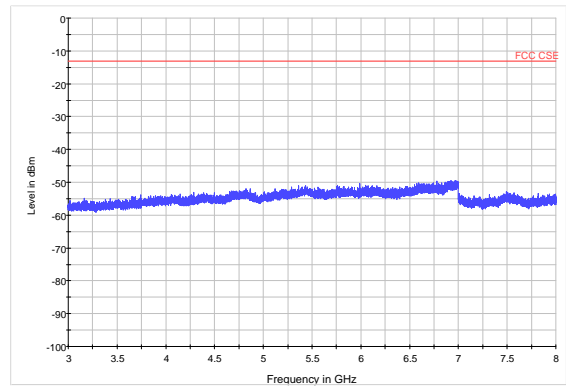

LTE Band 1310MHz CH-High 30MHz~3GHz

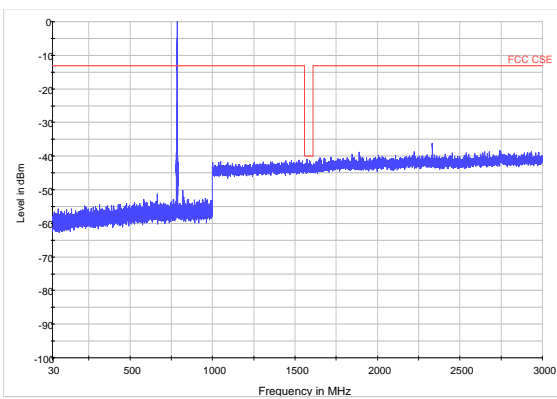

LTE Band 1310MHz CH-High 3GHz~8GHz

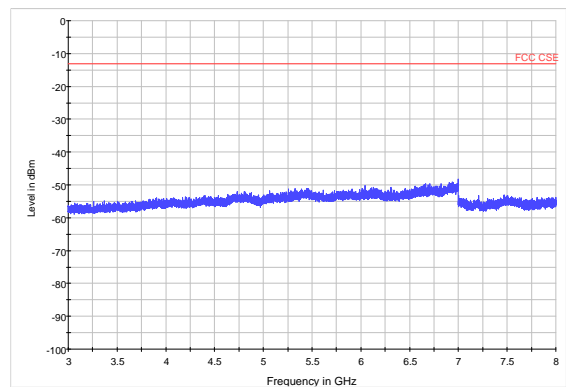

4.8 Radiates Spurious Emission

Ambient condition

Temperature	Relative humidity	Pressure
23°C ~25°C	45%~50%	101.5kPa

Method of Measurement

- The testing follows ANSI C63.26 (2015)Section5.5.2.3.
- Above 30MHz: The EUT is placed on a turntable 0.8 meters above the ground in the chamber, 3 meter away from the antenna. The maximal emission value is acquired by adjusting the antenna height, polarisation and turntable azimuth. Normally, the height range of antenna is 1 m to 4 m, the azimuth range of turntable is 0° to 360°,and the receive antenna has two polarizations Vertical (V) and Horizontal (H).Above 1GHz:(Note: the FCC's permission to use 1.5m as an alternative per TCBC Conf call of Dec. 2, 2014.)The EUT is placed on a turntable 1.5 meters above the ground in the chamber, 3 meter away from the antenna. The maximal emission value is acquired by adjusting the antenna height, polarisation and turntable azimuth. Normally, the height range of antenna is 1 m to 4 m, the azimuth range of turntable is 0° to 360°, and the receive antenna has two polarizations Vertical (V) and Horizontal (H).
- A log-periodic antenna or double-ridged waveguide horn antenna shall be substituted in place of the EUT. The log-periodic antenna will be driven by a signal generator and the level will be adjusted till the same power value on the spectrum analyzer or receiver. The level of the spurious emissions can be calculated through the level of the signal generator, cable loss, the gain of the substitution antenna and the reading of the spectrum analyzer or receiver.
- The EUT is then put into continuously transmitting mode at its maximum power level during the test. Set Test Receiver or Spectrum RBW=1MHz,VBW=3MHz, And the maximum value of the receiver should be recorded as (Pr).
- The EUT shall be replaced by a substitution antenna. In the chamber, an substitution antenna for the frequency band of interest is placed at the reference point of the chamber. An RF Signal source for the frequency band of interest is connected to the substitution antenna with a cable that has been constructed to not interfere with the radiation pattern of the antenna. A power (PMea) is applied to the input of the substitution antenna, and adjust the level of the signal generator output until the value of the receiver reach the previously recorded (Pr). The power of signal source (PMea) is recorded. The test should be performed by rotating the test item and adjusting the receiving antenna polarization.
- A amplifier should be connected to the Signal Source output port. And the cable should be connect between the Amplifier and the Substitution Antenna. The cable loss (Pcl) ,the Substitution Antenna Gain(Ga) and the Amplifier Gain (PAG) should be recorded after test.
- The measurement results are obtained as described below:

$$\text{Power(EIRP)} = \text{PMea} - \text{PAG} - \text{Pcl} + \text{Ga}$$
The measurement results are amend as described below:

$$\text{Power(EIRP)} = \text{PMea} - \text{Pcl} + \text{Ga}$$
- This value is EIRP since the measurement is calibrated using an antenna of known gain (2.15 dBi) and known input power.ERP can be calculated from EIRP by subtracting the gain of the dipole, $\text{ERP} = \text{EIRP} - 2.15\text{dBi}$.

Test setup

30MHz~~~ 1GHz

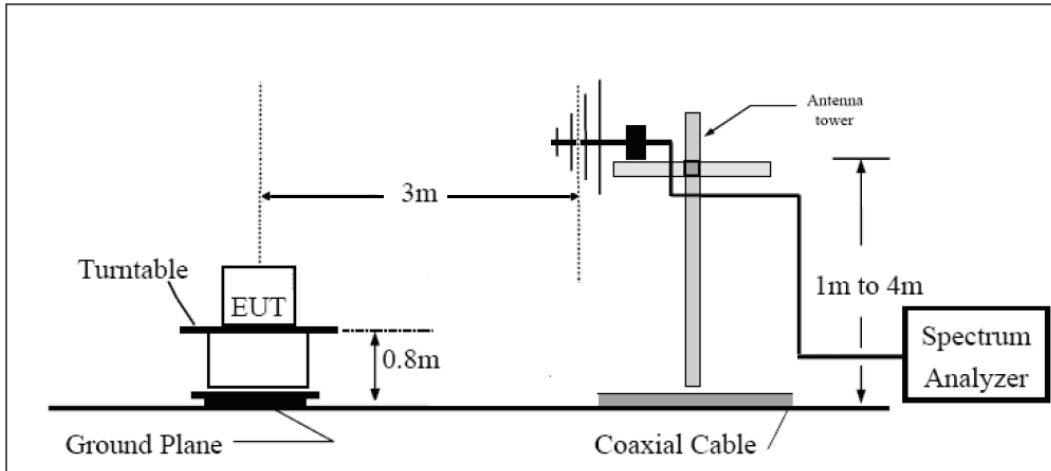

Above 1GHz

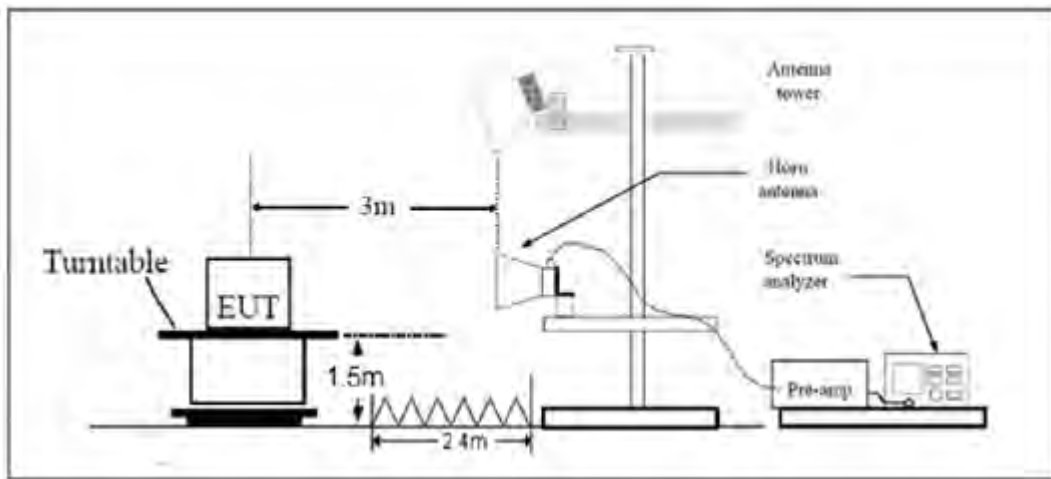

Note: Area side:2.4mX3.6m

Radiated measurements are performed by rotating the EUT in three different orthogonal test planes. EUT lie-down stand-up position (X, Y axis), lie-down position (Z axis),. Receiver antenna polarization (horizontal and vertical), the worst emission was found in position (Z axis, vertical polarization) and the worst case was recorded.

Limits

LTE -4 Rule Part 27.53(h) specifies that “for operations in the 1695-1710 MHz, 1710-1755 MHz, 1755-1780 MHz, 1915-1920 MHz, 1995-2000 MHz, 2000-2020 MHz, 2110-2155 MHz, 2155-2180 MHz, and 2180-2200 bands, the power of any emission outside a licensee's frequency block shall be attenuated below the transmitter power (P) in watts by at least $43 + 10 \log_{10} (P)$ dB..”

LTE -12 Rule Part 27.53 (g) For operations in the 600 MHz band and the 698-746 MHz band, the power of any emission outside a licensee's frequency band(s) of operation shall be attenuated below the transmitter power (P) within the licensed band(s) of operation, measured in watts, by at least $43 +$



10 log (P) dB. Compliance with this provision is based on the use of measurement instrumentation employing a resolution bandwidth of 100 kilohertz or greater. However, in the 100 kilohertz bands immediately outside and adjacent to a licensee's frequency block, a resolution bandwidth of at least 30 kHz may be employed.

LTE -13 Rule Part 27.53(f) For operations in the 746-758 MHz, 775-788 MHz, and 805-806 MHz bands, emissions in the band 1559-1610 MHz shall be limited to -70 dBW/MHz equivalent isotropically radiated power (EIRP) for wideband signals, and -80 dBW EIRP for discrete emissions of less than 700 Hz bandwidth. For the purpose of equipment authorization, a transmitter shall be tested with an antenna that is representative of the type that will be used with the equipment in normal operation.

LTE B4/12 Limit

Limit	-13 dBm
-------	---------

LTE B13 Limit

Limit out of the band 1559-1610 MHz	-13 dBm
Limit in the band 1559-1610 MHz	-40 dBm

Measurement Uncertainty

The assessed measurement uncertainty to ensure 95% confidence level for the normal distribution is with the coverage factor $k = \pm 1.96$, $U = \pm 3.55$ dB.

Test Result

LTE Band 4 QPSK 1.4MHz CH-Low, RB 1

Harmonic	Frequency (MHz)	SG (dBm)	Cable Loss (dB)	Gain (dBi)	Antenna Polarization	ERP Level (dBm)	Limit (dBm)	Margin (dB)	Azimuth (deg)
2	3421.4	-56.35	2.6	10.15	Vertical	-48.8	-13	35.8	45
3	5132.1	-51.85	2.4	11.35	Vertical	-42.9	-13	29.9	0
4	6842.8	-49.65	4.5	10.85	Vertical	-43.3	-13	30.3	135
5	8553.5	-47.15	5.1	11.35	Vertical	-40.9	-13	27.9	225
6	10264.2	-45.55	5.3	11.95	Vertical	-38.9	-13	25.9	135
7	11974.9	-45.85	5.5	13.55	Vertical	-37.8	-13	24.8	45
8	13685.6	-42.85	6.3	13.75	Vertical	-35.4	-13	22.4	90
9	15396.3	-43.35	6.7	13.85	Vertical	-36.2	-13	23.2	225
10	17107.0	-43.05	6.8	14.25	Vertical	-35.6	-13	22.6	45

Note: 1.The other Spurious RF Radiated emissions level is no more than noise floor.

2. The worst emission was found in the antenna is vertical position.

LTE Band 4 QPSK 1.4MHz CH-Middle, RB 1

Harmonic	Frequency (MHz)	SG (dBm)	Cable Loss (dB)	Gain (dBi)	Antenna Polarization	ERP Level (dBm)	Limit (dBm)	Margin (dB)	Azimuth (deg)
2	3465.0	-54.85	2.6	10.75	Vertical	-46.7	-13	33.7	135
3	5197.5	-49.65	2.4	11.05	Vertical	-41.0	-13	28.0	45
4	6930.0	-49.45	4.5	11.15	Vertical	-42.8	-13	29.8	90
5	8662.5	-48.55	5.1	11.35	Vertical	-42.3	-13	29.3	225
6	10395.0	-44.35	5.3	11.95	Vertical	-37.7	-13	24.7	45
7	12127.5	-45.95	5.5	13.55	Vertical	-37.9	-13	24.9	90
8	13860.0	-41.75	6.3	13.75	Vertical	-34.3	-13	21.3	135
9	15592.5	-45.65	6.7	13.85	Vertical	-38.5	-13	25.5	135
10	17325.0	-41.95	6.8	14.25	Vertical	-34.5	-13	21.5	90

Note: 1.The other Spurious RF Radiated emissions level is no more than noise floor.

2. The worst emission was found in the antenna is vertical position.



LTE Band 4 QPSK 1.4MHz CH-High, RB 1

Harmonic	Frequency (MHz)	SG (dBm)	Cable Loss (dB)	Gain (dBi)	Antenna Polarization	ERP Level (dBm)	Limit (dBm)	Margin (dB)	Azimuth (deg)
2	3508.6	-53.15	2.6	10.15	Vertical	-45.6	-13	32.6	45
3	5262.9	-56.65	2.4	11.05	Vertical	-48.0	-13	35.0	45
4	7017.2	-49.75	4.5	11.15	Vertical	-43.1	-13	30.1	135
5	8771.5	-47.05	5.1	11.35	Vertical	-40.8	-13	27.8	45
6	10525.8	-45.05	5.3	11.95	Vertical	-38.4	-13	25.4	90
7	12280.1	-45.25	5.5	13.55	Vertical	-37.2	-13	24.2	135
8	14034.4	-42.15	6.3	13.75	Vertical	-34.7	-13	21.7	45
9	15788.7	-44.55	6.7	13.85	Vertical	-37.4	-13	24.4	90
10	17543.0	-42.45	6.8	14.25	Vertical	-35.0	-13	22.0	225

Note: 1.The other Spurious RF Radiated emissions level is no more than noise floor.

2. The worst emission was found in the antenna is vertical position.

LTE Band 4 QPSK 3MHz CH-Low, RB 1

Harmonic	Frequency (MHz)	SG (dBm)	Cable Loss (dB)	Gain (dBi)	Antenna Polarization	ERP Level (dBm)	Limit (dBm)	Margin (dB)	Azimuth (deg)
2	3423.0	-59.35	2.6	10.15	Vertical	-51.8	-13	38.8	180
3	5134.5	-47.45	2.4	11.35	Vertical	-38.5	-13	25.5	225
4	6846.0	-50.65	4.5	10.85	Vertical	-44.3	-13	31.3	135
5	8557.5	-48.45	5.1	11.35	Vertical	-42.2	-13	29.2	225
6	10269.0	-45.35	5.3	11.95	Vertical	-38.7	-13	25.7	90
7	11980.5	-46.15	5.5	13.55	Vertical	-38.1	-13	25.1	90
8	13692.0	-42.65	6.3	13.75	Vertical	-35.2	-13	22.2	45
9	15403.5	-45.35	6.7	13.85	Vertical	-38.2	-13	25.2	180
10	17115.0	-43.05	6.8	14.25	Vertical	-35.6	-13	22.6	45

Note: 1.The other Spurious RF Radiated emissions level is no more than noise floor.

2. The worst emission was found in the antenna is vertical position.



LTE Band 4 QPSK 3MHz CH-Middle, RB 1

Harmonic	Frequency (MHz)	SG (dBm)	Cable Loss (dB)	Gain (dBi)	Antenna Polarization	ERP Level (dBm)	Limit (dBm)	Margin (dB)	Azimuth (deg)
2	3465.0	-54.25	2.6	10.75	Vertical	-46.1	-13	33.1	0
3	5197.5	-48.95	2.4	11.05	Vertical	-40.3	-13	27.3	135
4	6930.0	-48.75	4.5	11.15	Vertical	-42.1	-13	29.1	225
5	8662.5	-46.55	5.1	11.35	Vertical	-40.3	-13	27.3	315
6	10395.0	-45.25	5.3	11.95	Vertical	-38.6	-13	25.6	270
7	12127.5	-44.75	5.5	13.55	Vertical	-36.7	-13	23.7	225
8	13860.0	-41.95	6.3	13.75	Vertical	-34.5	-13	21.5	135
9	15592.5	-44.95	6.7	13.85	Vertical	-37.8	-13	24.8	225
10	17325.0	-41.65	6.8	14.25	Vertical	-34.2	-13	21.2	0

Note: 1.The other Spurious RF Radiated emissions level is no more than noise floor.

2. The worst emission was found in the antenna is vertical position.

LTE Band 4 QPSK 3MHz CH-High, RB 1

Harmonic	Frequency (MHz)	SG (dBm)	Cable Loss (dB)	Gain (dBi)	Antenna Polarization	ERP Level (dBm)	Limit (dBm)	Margin (dB)	Azimuth (deg)
2	3507.0	-54.85	2.6	10.15	Vertical	-47.3	-13	34.3	135
3	5260.5	-47.15	2.4	11.05	Vertical	-38.5	-13	25.5	225
4	7014.0	-50.25	4.5	11.15	Vertical	-43.6	-13	30.6	315
5	8767.5	-45.95	5.1	11.35	Vertical	-39.7	-13	26.7	270
6	10521.0	-44.35	5.3	11.95	Vertical	-37.7	-13	24.7	225
7	12274.5	-46.55	5.5	13.55	Vertical	-38.5	-13	25.5	135
8	14028.0	-42.35	6.3	13.75	Vertical	-34.9	-13	21.9	225
9	15781.5	-44.75	6.7	13.85	Vertical	-37.6	-13	24.6	90
10	17535.0	-42.15	6.8	14.25	Vertical	-34.7	-13	21.7	90

Note: 1.The other Spurious RF Radiated emissions level is no more than noise floor.

2. The worst emission was found in the antenna is vertical position.



LTE Band 4 QPSK 5MHz CH-Low, RB 1

Harmonic	Frequency (MHz)	SG (dBm)	Cable Loss (dB)	Gain (dBi)	Antenna Polarization	ERP Level (dBm)	Limit (dBm)	Margin (dB)	Azimuth (deg)
2	3425.0	-57.85	2.6	10.15	Vertical	-50.3	-13	37.3	45
3	5137.5	-57.75	2.4	11.35	Vertical	-48.8	-13	35.8	180
4	6850.0	-47.95	4.5	10.85	Vertical	-41.6	-13	28.6	225
5	8562.5	-47.05	5.1	11.35	Vertical	-40.8	-13	27.8	135
6	10275.0	-45.15	5.3	11.95	Vertical	-38.5	-13	25.5	225
7	11987.5	-45.65	5.5	13.55	Vertical	-37.6	-13	24.6	90
8	13700.0	-44.75	6.3	13.75	Vertical	-37.3	-13	24.3	90
9	15412.5	-45.25	6.7	13.85	Vertical	-38.1	-13	25.1	45
10	17125.0	-42.75	6.8	14.25	Vertical	-35.3	-13	22.3	180

Note: 1.The other Spurious RF Radiated emissions level is no more than noise floor.

2. The worst emission was found in the antenna is vertical position.

LTE Band 4 QPSK 5MHz CH-Middle, RB 1

Harmonic	Frequency (MHz)	SG (dBm)	Cable Loss (dB)	Gain (dBi)	Antenna Polarization	ERP Level (dBm)	Limit (dBm)	Margin (dB)	Azimuth (deg)
2	3465.0	-55.05	2.6	10.75	Vertical	-46.9	-13	33.9	45
3	5197.5	-57.45	2.4	11.05	Vertical	-48.8	-13	35.8	0
4	6930.0	-49.45	4.5	11.15	Vertical	-42.8	-13	29.8	135
5	8662.5	-48.65	5.1	11.35	Vertical	-42.4	-13	29.4	225
6	10395.0	-44.75	5.3	11.95	Vertical	-38.1	-13	25.1	315
7	12127.5	-47.25	5.5	13.55	Vertical	-39.2	-13	26.2	270
8	13860.0	-41.65	6.3	13.75	Vertical	-34.2	-13	21.2	225
9	15592.5	-44.35	6.7	13.85	Vertical	-37.2	-13	24.2	135
10	17325.0	-41.35	6.8	14.25	Vertical	-33.9	-13	20.9	225

Note: 1.The other Spurious RF Radiated emissions level is no more than noise floor.

2. The worst emission was found in the antenna is vertical position.



LTE Band 4 QPSK 5MHz CH-High, RB 1

Harmonic	Frequency (MHz)	SG (dBm)	Cable Loss (dB)	Gain (dBi)	Antenna Polarization	ERP Level (dBm)	Limit (dBm)	Margin (dB)	Azimuth (deg)
2	3505.0	-53.65	2.6	10.15	Vertical	-46.1	-13	33.1	0
3	5257.5	-56.95	2.4	11.05	Vertical	-48.3	-13	35.3	135
4	7010.0	-49.75	4.5	11.15	Vertical	-43.1	-13	30.1	225
5	8762.5	-46.85	5.1	11.35	Vertical	-40.6	-13	27.6	315
6	10515.0	-44.75	5.3	11.95	Vertical	-38.1	-13	25.1	270
7	12267.5	-46.55	5.5	13.55	Vertical	-38.5	-13	25.5	225
8	14020.0	-41.35	6.3	13.75	Vertical	-33.9	-13	20.9	135
9	15772.5	-44.15	6.7	13.85	Vertical	-37.0	-13	24.0	225
10	17525.0	-43.85	6.8	14.25	Vertical	-36.4	-13	23.4	90

Note: 1.The other Spurious RF Radiated emissions level is no more than noise floor.

2. The worst emission was found in the antenna is vertical position.

LTE Band 4 QPSK 10MHz CH-Low, RB 1

Harmonic	Frequency (MHz)	SG (dBm)	Cable Loss (dB)	Gain (dBi)	Antenna Polarization	ERP Level (dBm)	Limit (dBm)	Margin (dB)	Azimuth (deg)
2	3430.0	-56.15	2.6	10.15	Vertical	-48.6	-13	35.6	90
3	5145.0	-51.65	2.4	11.35	Vertical	-42.7	-13	29.7	45
4	6860.0	-49.25	4.5	10.85	Vertical	-42.9	-13	29.9	180
5	8575.0	-46.95	5.1	11.35	Vertical	-40.7	-13	27.7	225
6	10290.0	-44.55	5.3	11.95	Vertical	-37.9	-13	24.9	135
7	12005.0	-44.45	5.5	13.55	Vertical	-36.4	-13	23.4	225
8	13720.0	-43.15	6.3	13.75	Vertical	-35.7	-13	22.7	90
9	15435.0	-44.65	6.7	13.85	Vertical	-37.5	-13	24.5	90
10	17150.0	-42.65	6.8	14.25	Vertical	-35.2	-13	22.2	45

Note: 1.The other Spurious RF Radiated emissions level is no more than noise floor.

2. The worst emission was found in the antenna is vertical position.



LTE Band 4 QPSK 10MHz CH-Middle, RB 1

Harmonic	Frequency (MHz)	SG (dBm)	Cable Loss (dB)	Gain (dBi)	Antenna Polarization	ERP Level (dBm)	Limit (dBm)	Margin (dB)	Azimuth (deg)
2	3465.0	-54.95	2.6	10.75	Vertical	-46.8	-13	33.8	180
3	5197.5	-57.25	2.4	11.05	Vertical	-48.6	-13	35.6	45
4	6930.0	-50.05	4.5	11.15	Vertical	-43.4	-13	30.4	0
5	8662.5	-46.35	5.1	11.35	Vertical	-40.1	-13	27.1	135
6	10395.0	-44.85	5.3	11.95	Vertical	-38.2	-13	25.2	225
7	12127.5	-45.55	5.5	13.55	Vertical	-37.5	-13	24.5	315
8	13860.0	-42.45	6.3	13.75	Vertical	-35.0	-13	22.0	270
9	15592.5	-43.85	6.7	13.85	Vertical	-36.7	-13	23.7	225
10	17325.0	-41.45	6.8	14.25	Vertical	-34.0	-13	21.0	135

Note: 1.The other Spurious RF Radiated emissions level is no more than noise floor.

2. The worst emission was found in the antenna is vertical position.

LTE Band 4 QPSK 10MHz CH-High, RB 1

Harmonic	Frequency (MHz)	SG (dBm)	Cable Loss (dB)	Gain (dBi)	Antenna Polarization	ERP Level (dBm)	Limit (dBm)	Margin (dB)	Azimuth (deg)
2	3500.0	-53.65	2.6	10.15	Vertical	-46.1	-13	33.1	225
3	5250.0	-57.35	2.4	11.05	Vertical	-48.7	-13	35.7	315
4	7000.0	-49.95	4.5	11.15	Vertical	-43.3	-13	30.3	270
5	8750.0	-47.15	5.1	11.35	Vertical	-40.9	-13	27.9	225
6	10500.0	-44.35	5.3	11.95	Vertical	-37.7	-13	24.7	135
7	12250.0	-45.65	5.5	13.55	Vertical	-37.6	-13	24.6	225
8	14000.0	-42.15	6.3	13.75	Vertical	-34.7	-13	21.7	315
9	15750.0	-44.75	6.7	13.85	Vertical	-37.6	-13	24.6	270
10	17500.0	-42.45	6.8	14.25	Vertical	-35.0	-13	22.0	225

Note: 1.The other Spurious RF Radiated emissions level is no more than noise floor.

2. The worst emission was found in the antenna is vertical position.

LTE Band 4 QPSK 15MHz CH Low, RB 1

Harmonic	Frequency (MHz)	SG (dBm)	Cable Loss (dB)	Gain (dBi)	Antenna Polarization	ERP Level (dBm)	Limit (dBm)	Margin (dB)	Azimuth (deg)
2	3435.0	-58.45	2.6	10.15	Vertical	-50.9	-13	37.9	135
3	5152.5	-51.15	2.4	11.35	Vertical	-42.2	-13	29.2	225
4	6870.0	-49.45	4.5	10.85	Vertical	-43.1	-13	30.1	90
5	8587.5	-46.45	5.1	11.35	Vertical	-40.2	-13	27.2	90
6	10305.0	-46.95	5.3	11.95	Vertical	-40.3	-13	27.3	45
7	12022.5	-45.65	5.5	13.55	Vertical	-37.6	-13	24.6	180
8	13740.0	-43.75	6.3	13.75	Vertical	-36.3	-13	23.3	225
9	15457.5	-44.65	6.7	13.85	Vertical	-37.5	-13	24.5	135
10	17175.0	-41.65	6.8	14.25	Vertical	-34.2	-13	21.2	225

Note: 1.The other Spurious RF Radiated emissions level is no more than noise floor.

2. The worst emission was found in the antenna is vertical position.

LTE Band 4 QPSK 15MHz CH-Middle, RB 1

Harmonic	Frequency (MHz)	SG (dBm)	Cable Loss (dB)	Gain (dBi)	Antenna Polarization	ERP Level (dBm)	Limit (dBm)	Margin (dB)	Azimuth (deg)
2	3465.0	-55.85	2.6	10.75	Vertical	-47.7	-13	34.7	90
3	5197.5	-57.45	2.4	11.05	Vertical	-48.8	-13	35.8	90
4	6930.0	-50.45	4.5	11.15	Vertical	-43.8	-13	30.8	45
5	8662.5	-47.85	5.1	11.35	Vertical	-41.6	-13	28.6	180
6	10395.0	-43.95	5.3	11.95	Vertical	-37.3	-13	24.3	270
7	12127.5	-45.75	5.5	13.55	Vertical	-37.7	-13	24.7	225
8	13860.0	-41.75	6.3	13.75	Vertical	-34.3	-13	21.3	135
9	15592.5	-45.65	6.7	13.85	Vertical	-38.5	-13	25.5	225
10	17325.0	-42.05	6.8	14.25	Vertical	-34.6	-13	21.6	315

Note: 1.The other Spurious RF Radiated emissions level is no more than noise floor.

2. The worst emission was found in the antenna is vertical position.



LTE Band 4 QPSK 15MHz CH-High, RB 1

Harmonic	Frequency (MHz)	SG (dBm)	Cable Loss (dB)	Gain (dBi)	Antenna Polarization	ERP Level (dBm)	Limit (dBm)	Margin (dB)	Azimuth (deg)
2	3495.0	-53.55	2.6	10.15	Vertical	-46.0	-13	33.0	270
3	5242.5	-57.65	2.4	11.05	Vertical	-49.0	-13	36.0	225
4	6990.0	-49.85	4.5	11.15	Vertical	-43.2	-13	30.2	135
5	8737.5	-47.05	5.1	11.35	Vertical	-40.8	-13	27.8	225
6	10485.0	-44.25	5.3	11.95	Vertical	-37.6	-13	24.6	90
7	12232.5	-45.25	5.5	13.55	Vertical	-37.2	-13	24.2	45
8	13980.0	-41.05	6.3	13.75	Vertical	-33.6	-13	20.6	180
9	15727.5	-46.15	6.7	13.85	Vertical	-39.0	-13	26.0	45
10	17475.0	-42.65	6.8	14.25	Vertical	-35.2	-13	22.2	0

Note: 1.The other Spurious RF Radiated emissions level is no more than noise floor.

2. The worst emission was found in the antenna is vertical position.

LTE Band 4 QPSK 20MHz CH-Low, RB 1

Harmonic	Frequency (MHz)	SG (dBm)	Cable Loss (dB)	Gain (dBi)	Antenna Polarization	ERP Level (dBm)	Limit (dBm)	Margin (dB)	Azimuth (deg)
2	3440.0	-59.05	2.6	10.15	Vertical	-51.5	-13	38.5	135
3	5160.0	-58.15	2.4	11.35	Vertical	-49.2	-13	36.2	225
4	6880.0	-51.25	4.5	10.85	Vertical	-44.9	-13	31.9	315
5	8600.0	-47.05	5.1	11.35	Vertical	-40.8	-13	27.8	270
6	10320.0	-45.95	5.3	11.95	Vertical	-39.3	-13	26.3	225
7	12040.0	-47.75	5.5	13.55	Vertical	-39.7	-13	26.7	135
8	13760.0	-41.95	6.3	13.75	Vertical	-34.5	-13	21.5	225
9	15480.0	-47.05	6.7	13.85	Vertical	-39.9	-13	26.9	135
10	17200.0	-44.75	6.8	14.25	Vertical	-37.3	-13	24.3	225

Note: 1.The other Spurious RF Radiated emissions level is no more than noise floor.

2. The worst emission was found in the antenna is vertical position.

LTE Band 4 QPSK 20MHz CH-Middle, RB 1

Harmonic	Frequency (MHz)	SG (dBm)	Cable Loss (dB)	Gain (dBi)	Antenna Polarization	ERP Level (dBm)	Limit (dBm)	Margin (dB)	Azimuth (deg)
2	3465.0	-58.95	2.6	10.75	Vertical	-50.8	-13	37.8	315
3	5197.5	-52.75	2.4	11.05	Vertical	-44.1	-13	31.1	270
4	6930.0	-50.15	4.5	11.15	Vertical	-43.5	-13	30.5	225
5	8662.5	-46.55	5.1	11.35	Vertical	-40.3	-13	27.3	135
6	10395.0	-45.25	5.3	11.95	Vertical	-38.6	-13	25.6	225
7	12127.5	-44.95	5.5	13.55	Vertical	-36.9	-13	23.9	90
8	13860.0	-42.45	6.3	13.75	Vertical	-35.0	-13	22.0	90
9	15592.5	-44.95	6.7	13.85	Vertical	-37.8	-13	24.8	45
10	17325.0	-42.85	6.8	14.25	Vertical	-35.4	-13	22.4	180

Note: 1.The other Spurious RF Radiated emissions level is no more than noise floor.

2. The worst emission was found in the antenna is vertical position.

LTE Band 4 QPSK 20MHz CH-High, RB 1

Harmonic	Frequency (MHz)	SG (dBm)	Cable Loss (dB)	Gain (dBi)	Antenna Polarization	ERP Level (dBm)	Limit (dBm)	Margin (dB)	Azimuth (deg)
2	3490.0	-54.35	2.6	10.15	Vertical	-46.8	-13	33.8	225
3	5235.0	-48.85	2.4	11.05	Vertical	-40.2	-13	27.2	135
4	6980.0	-49.55	4.5	11.15	Vertical	-42.9	-13	29.9	225
5	8725.0	-47.05	5.1	11.35	Vertical	-40.8	-13	27.8	90
6	10470.0	-45.35	5.3	11.95	Vertical	-38.7	-13	25.7	90
7	12215.0	-45.65	5.5	13.55	Vertical	-37.6	-13	24.6	45
8	13960.0	-44.45	6.3	13.75	Vertical	-37.0	-13	24.0	180
9	15705.0	-45.25	6.7	13.85	Vertical	-38.1	-13	25.1	45
10	17450.0	-43.65	6.8	14.25	Vertical	-36.2	-13	23.2	45

Note: 1.The other Spurious RF Radiated emissions level is no more than noise floor.

2. The worst emission was found in the antenna is vertical position.

LTE Band 12 QPSK 1.4MHz CH-Low, RB 1

Harmonic	Frequency (MHz)	SG (dBm)	Cable Loss (dB)	Gain (dBi)	Antenna Polarization	ERP Level (dBm)	Limit (dBm)	Margin (dB)	Azimuth (deg)
2	1399.40	-52.45	2.00	10.15	Vertical	-44.3	-13	31.3	225
3	2099.10	-58.65	2.50	11.35	Vertical	-49.8	-13	36.8	315
4	2798.80	-56.15	4.20	10.85	Vertical	-49.5	-13	36.5	135
5	3498.50	-56.05	5.20	11.35	Vertical	-49.9	-13	36.9	225
6	4198.20	-54.55	5.50	11.95	Vertical	-48.1	-13	35.1	90
7	4897.90	-52.95	5.70	13.55	Vertical	-45.1	-13	32.1	135
8	5597.60	-52.05	6.30	13.75	Vertical	-44.6	-13	31.6	45
9	6297.30	-50.55	6.80	13.85	Vertical	-43.5	-13	30.5	225
10	6997.00	-49.05	6.90	14.25	Vertical	-41.7	-13	28.7	135

- Note: 1.The other Spurious RF Radiated emissions level is no more than noise floor.
 2. The worst emission was found in the antenna is vertical position.

LTE Band 12 QPSK 1.4MHz CH-Middle, RB 1

Harmonic	Frequency (MHz)	SG (dBm)	Cable Loss (dB)	Gain (dBi)	Antenna Polarization	ERP Level (dBm)	Limit (dBm)	Margin (dB)	Azimuth (deg)
2	1415.00	-57.75	2.00	10.75	Vertical	-49.0	-13	36.0	45
3	2122.50	-59.04	2.51	11.05	Vertical	-50.5	-13	37.5	90
4	2830.00	-56.45	4.20	11.15	Vertical	-49.5	-13	36.5	225
5	3537.50	-56.45	5.20	11.15	Vertical	-50.5	-13	37.5	45
6	4245.00	-54.55	5.50	11.95	Vertical	-48.1	-13	35.1	135
7	4952.50	-52.15	5.70	13.55	Vertical	-44.3	-13	31.3	135
8	5660.00	-52.65	6.30	13.75	Vertical	-45.2	-13	32.2	225
9	6367.50	-50.25	6.80	13.85	Vertical	-43.2	-13	30.2	90
10	7075.00	-49.35	6.90	14.25	Vertical	-42.0	-13	29.0	90

- Note: 1.The other Spurious RF Radiated emissions level is no more than noise floor.
 2. The worst emission was found in the antenna is vertical position.

LTE Band 12 QPSK 1.4MHz CH-High, RB 1

Harmonic	Frequency (MHz)	SG (dBm)	Cable Loss (dB)	Gain (dBi)	Antenna Polarization	ERP Level (dBm)	Limit (dBm)	Margin (dB)	Azimuth (deg)
2	1430.60	-60.65	2.00	10.15	Vertical	-52.5	-13	39.5	225
3	2145.90	-56.14	2.51	11.05	Vertical	-47.6	-13	34.6	45
4	2861.20	-57.25	4.20	11.15	Vertical	-50.3	-13	37.3	90
5	3576.50	-56.05	5.20	11.15	Vertical	-50.1	-13	37.1	135
6	4291.80	-54.85	5.50	11.95	Vertical	-48.4	-13	35.4	135
7	5007.10	-52.15	5.70	13.55	Vertical	-44.3	-13	31.3	90
8	5722.40	-52.35	6.30	13.75	Vertical	-44.9	-13	31.9	135
9	6437.70	-50.55	6.80	13.85	Vertical	-43.5	-13	30.5	90
10	7153.00	-49.45	6.90	14.25	Vertical	-42.1	-13	29.1	45

Note: 1.The other Spurious RF Radiated emissions level is no more than noise floor.

2. The worst emission was found in the antenna is vertical position.

LTE Band 12 QPSK 3MHz CH-Low, RB 1

Harmonic	Frequency (MHz)	SG (dBm)	Cable Loss (dB)	Gain (dBi)	Antenna Polarization	ERP Level (dBm)	Limit (dBm)	Margin (dB)	Azimuth (deg)
2	1401.00	-55.95	2.00	10.15	Vertical	-47.8	-13	34.8	135
3	2101.50	-58.34	2.51	11.35	Vertical	-49.5	-13	36.5	225
4	2802.00	-56.25	4.20	10.85	Vertical	-49.6	-13	36.6	90
5	3502.50	-56.55	5.20	11.35	Vertical	-50.4	-13	37.4	90
6	4203.00	-54.85	5.50	11.95	Vertical	-48.4	-13	35.4	45
7	4903.50	-52.95	5.70	13.55	Vertical	-45.1	-13	32.1	180
8	5604.00	-52.85	6.30	13.75	Vertical	-45.4	-13	32.4	225
9	6304.50	-50.35	6.80	13.85	Vertical	-43.3	-13	30.3	135
10	7005.00	-49.15	6.90	14.25	Vertical	-41.8	-13	28.8	225

Note: 1.The other Spurious RF Radiated emissions level is no more than noise floor.

2. The worst emission was found in the antenna is vertical position.

LTE Band 12 QPSK 3MHz CH-Middle, RB 1

Harmonic	Frequency (MHz)	SG (dBm)	Cable Loss (dB)	Gain (dBi)	Antenna Polarization	ERP Level (dBm)	Limit (dBm)	Margin (dB)	Azimuth (deg)
2	1415.00	-57.85	2.00	10.75	Vertical	-49.1	-13	36.1	90
3	2122.50	-58.64	2.51	11.05	Vertical	-50.1	-13	37.1	90
4	2830.00	-57.35	4.20	11.15	Vertical	-50.4	-13	37.4	45
5	3537.50	-56.35	5.20	11.15	Vertical	-50.4	-13	37.4	180
6	4245.00	-55.15	5.50	11.95	Vertical	-48.7	-13	35.7	45
7	4952.50	-52.35	5.70	13.55	Vertical	-44.5	-13	31.5	0
8	5660.00	-52.55	6.30	13.75	Vertical	-45.1	-13	32.1	135
9	6367.50	-50.95	6.80	13.85	Vertical	-43.9	-13	30.9	225
10	7075.00	-48.75	6.90	14.25	Vertical	-41.4	-13	28.4	90

- Note: 1.The other Spurious RF Radiated emissions level is no more than noise floor.
 2. The worst emission was found in the antenna is vertical position.

LTE Band 12 QPSK 3MHz CH-High, RB 1

Harmonic	Frequency (MHz)	SG (dBm)	Cable Loss (dB)	Gain (dBi)	Antenna Polarization	ERP Level (dBm)	Limit (dBm)	Margin (dB)	Azimuth (deg)
2	1429.00	-59.25	2.00	10.15	Vertical	-51.1	-13	38.1	45
3	2143.50	-57.24	2.51	11.05	Vertical	-48.7	-13	35.7	180
4	2858.00	-57.05	4.20	11.15	Vertical	-50.1	-13	37.1	225
5	3572.50	-55.85	5.20	11.15	Vertical	-49.9	-13	36.9	135
6	4287.00	-54.75	5.50	11.95	Vertical	-48.3	-13	35.3	225
7	5001.50	-52.55	5.70	13.55	Vertical	-44.7	-13	31.7	90
8	5716.00	-51.95	6.30	13.75	Vertical	-44.5	-13	31.5	90
9	6430.50	-50.45	6.80	13.85	Vertical	-43.4	-13	30.4	45
10	7145.00	-49.05	6.90	14.25	Vertical	-41.7	-13	28.7	180

- Note: 1.The other Spurious RF Radiated emissions level is no more than noise floor.
 2. The worst emission was found in the antenna is vertical position.

LTE Band 12 QPSK 5MHz CH-Low, RB 1

Harmonic	Frequency (MHz)	SG (dBm)	Cable Loss (dB)	Gain (dBi)	Antenna Polarization	ERP Level (dBm)	Limit (dBm)	Margin (dB)	Azimuth (deg)
2	1403.00	-51.85	2.00	10.15	Vertical	-43.7	-13	30.7	45
3	2104.50	-59.15	2.50	11.35	Vertical	-50.3	-13	37.3	0
4	2806.00	-56.85	4.20	10.85	Vertical	-50.2	-13	37.2	135
5	3507.50	-56.45	5.20	11.35	Vertical	-50.3	-13	37.3	45
6	4209.00	-55.35	5.50	11.95	Vertical	-48.9	-13	35.9	90
7	4910.50	-52.15	5.70	13.55	Vertical	-44.3	-13	31.3	45
8	5612.00	-52.55	6.30	13.75	Vertical	-45.1	-13	32.1	180
9	6313.50	-50.65	6.80	13.85	Vertical	-43.6	-13	30.6	315
10	7015.00	-49.05	6.90	14.25	Vertical	-41.7	-13	28.7	135

Note: 1.The other Spurious RF Radiated emissions level is no more than noise floor.

2. The worst emission was found in the antenna is vertical position.

LTE Band 12 QPSK 5MHz CH-Middle, RB 1

Harmonic	Frequency (MHz)	SG (dBm)	Cable Loss (dB)	Gain (dBi)	Antenna Polarization	ERP Level (dBm)	Limit (dBm)	Margin (dB)	Azimuth (deg)
2	1415.00	-57.15	2.00	10.75	Vertical	-48.4	-13	35.4	225
3	2122.50	-58.24	2.51	11.05	Vertical	-49.7	-13	36.7	90
4	2830.00	-56.25	4.20	11.15	Vertical	-49.3	-13	36.3	180
5	3537.50	-55.75	5.20	11.15	Vertical	-49.8	-13	36.8	45
6	4245.00	-55.35	5.50	11.95	Vertical	-48.9	-13	35.9	180
7	4952.50	-52.25	5.70	13.55	Vertical	-44.4	-13	31.4	45
8	5660.00	-52.65	6.30	13.75	Vertical	-45.2	-13	32.2	0
9	6367.50	-50.25	6.80	13.85	Vertical	-43.2	-13	30.2	135
10	7075.00	-49.05	6.90	14.25	Vertical	-41.7	-13	28.7	225

Note: 1.The other Spurious RF Radiated emissions level is no more than noise floor.

2. The worst emission was found in the antenna is vertical position.

LTE Band 12 QPSK 5MHz CH-High, RB 1

Harmonic	Frequency (MHz)	SG (dBm)	Cable Loss (dB)	Gain (dBi)	Antenna Polarization	ERP Level (dBm)	Limit (dBm)	Margin (dB)	Azimuth (deg)
2	1427.00	-57.85	2.00	10.15	Vertical	-49.7	-13	36.7	90
3	2140.50	-57.34	2.51	11.05	Vertical	-48.8	-13	35.8	225
4	2854.00	-55.65	4.20	11.15	Vertical	-48.7	-13	35.7	180
5	3567.50	-56.15	5.20	11.15	Vertical	-50.2	-13	37.2	270
6	4281.00	-54.55	5.50	11.95	Vertical	-48.1	-13	35.1	135
7	4994.50	-52.95	5.70	13.55	Vertical	-45.1	-13	32.1	225
8	5708.00	-52.35	6.30	13.75	Vertical	-44.9	-13	31.9	135
9	6421.50	-50.65	6.80	13.85	Vertical	-43.6	-13	30.6	90
10	7135.00	-49.15	6.90	14.25	Vertical	-41.8	-13	28.8	45

Note: 1.The other Spurious RF Radiated emissions level is no more than noise floor.

2. The worst emission was found in the antenna is vertical position.

LTE Band 12 QPSK 10MHz CH-Low, RB 1

Harmonic	Frequency (MHz)	SG (dBm)	Cable Loss (dB)	Gain (dBi)	Antenna Polarization	ERP Level (dBm)	Limit (dBm)	Margin (dB)	Azimuth (deg)
2	1408.00	-52.25	2.00	10.15	Vertical	-44.1	-13	31.1	180
3	2112.00	-58.94	2.51	11.35	Vertical	-50.1	-13	37.1	45
4	2816.00	-57.05	4.20	10.85	Vertical	-50.4	-13	37.4	0
5	3520.00	-55.75	5.20	11.35	Vertical	-49.6	-13	36.6	135
6	4224.00	-54.35	5.50	11.95	Vertical	-47.9	-13	34.9	225
7	4928.00	-53.95	5.70	13.55	Vertical	-46.1	-13	33.1	90
8	5632.00	-52.55	6.30	13.75	Vertical	-45.1	-13	32.1	45
9	6336.00	-51.55	6.80	13.85	Vertical	-44.5	-13	31.5	180
10	7040.00	-48.55	6.90	14.25	Vertical	-41.2	-13	28.2	225

Note: 1.The other Spurious RF Radiated emissions level is no more than noise floor.

2. The worst emission was found in the antenna is vertical position.

LTE Band 12 QPSK 10MHz CH-Middle, RB 1

Harmonic	Frequency (MHz)	SG (dBm)	Cable Loss (dB)	Gain (dBi)	Antenna Polarization	ERP Level (dBm)	Limit (dBm)	Margin (dB)	Azimuth (deg)
2	1415.00	-56.35	2.00	10.75	Vertical	-47.6	-13	34.6	135
3	2122.50	-57.84	2.51	11.05	Vertical	-49.3	-13	36.3	225
4	2830.00	-57.65	4.20	11.15	Vertical	-50.7	-13	37.7	90
5	3537.50	-55.25	5.20	11.15	Vertical	-49.3	-13	36.3	90
6	4245.00	-53.35	5.50	11.95	Vertical	-46.9	-13	33.9	45
7	4952.50	-54.25	5.70	13.55	Vertical	-46.4	-13	33.4	180
8	5660.00	-52.95	6.30	13.75	Vertical	-45.5	-13	32.5	45
9	6367.50	-50.55	6.80	13.85	Vertical	-43.5	-13	30.5	0
10	7075.00	-49.15	6.90	14.25	Vertical	-41.8	-13	28.8	135

Note: 1.The other Spurious RF Radiated emissions level is no more than noise floor.

2. The worst emission was found in the antenna is vertical position.

LTE Band 12 QPSK 10MHz CH-High, RB 1

Harmonic	Frequency (MHz)	SG (dBm)	Cable Loss (dB)	Gain (dBi)	Antenna Polarization	ERP Level (dBm)	Limit (dBm)	Margin (dB)	Azimuth (deg)
2	1422.00	-57.15	2.00	10.15	Vertical	-49.0	-13	36.0	225
3	2133.00	-58.04	2.51	11.05	Vertical	-49.5	-13	36.5	90
4	2844.00	-58.55	4.20	11.15	Vertical	-51.6	-13	38.6	45
5	3555.00	-55.05	5.20	11.15	Vertical	-49.1	-13	36.1	180
6	4266.00	-53.05	5.50	11.95	Vertical	-46.6	-13	33.6	225
7	4977.00	-53.95	5.70	13.55	Vertical	-46.1	-13	33.1	135
8	5688.00	-52.55	6.30	13.75	Vertical	-45.1	-13	32.1	225
9	6399.00	-50.35	6.80	13.85	Vertical	-43.3	-13	30.3	90
10	7110.00	-48.85	6.90	14.25	Vertical	-41.5	-13	28.5	90

Note: 1.The other Spurious RF Radiated emissions level is no more than noise floor.

2. The worst emission was found in the antenna is vertical position.

LTE Band 13 QPSK 5MHz CH-Low, RB 1

Harmonic	Frequency (MHz)	SG (dBm)	Cable Loss (dB)	Gain (dBi)	Antenna Polarization	ERP Level (dBm)	Limit (dBm)	Margin (dB)	Azimuth (deg)
2	1559.0	-61.25	2.00	10.15	Vertical	-53.1	-40	13.1	180
3	2338.5	-52.75	2.50	11.35	Vertical	-43.9	-13	30.9	270
4	3118.0	-57.45	4.20	10.85	Vertical	-50.8	-13	37.8	135
5	3897.5	-55.05	5.20	11.35	Vertical	-48.9	-13	35.9	225
6	4677.0	-53.35	5.50	11.95	Vertical	-46.9	-13	33.9	135
7	5456.5	-52.85	5.70	13.55	Vertical	-45.0	-13	32.0	90
8	6236.0	-52.35	6.30	13.75	Vertical	-44.9	-13	31.9	45
9	7015.5	-50.75	6.80	13.85	Vertical	-43.7	-13	30.7	180
10	7795.0	-48.25	6.90	14.25	Vertical	-40.9	-13	27.9	45

- Note: 1. The other Spurious RF Radiated emissions level is no more than noise floor.
 2. The worst emission was found in the antenna is vertical position.

LTE Band 13 QPSK 5MHz CH-Middle, RB 1

Harmonic	Frequency (MHz)	SG (dBm)	Cable Loss (dB)	Gain (dBi)	Antenna Polarization	ERP Level (dBm)	Limit (dBm)	Margin (dB)	Azimuth (deg)
2	1564.0	-61.45	2.00	10.75	Vertical	-52.7	-40	12.7	0
3	2346.0	-52.14	2.51	11.05	Vertical	-43.6	-13	30.6	135
4	3128.0	-56.75	4.20	11.15	Vertical	-49.8	-13	36.8	225
5	3910.0	-54.35	5.20	11.15	Vertical	-48.4	-13	35.4	90
6	4692.0	-53.45	5.50	11.95	Vertical	-47.0	-13	34.0	45
7	5474.0	-52.75	5.70	13.55	Vertical	-44.9	-13	31.9	180
8	6256.0	-52.15	6.30	13.75	Vertical	-44.7	-13	31.7	45
9	7038.0	-50.45	6.80	13.85	Vertical	-43.4	-13	30.4	0
10	7820.0	-47.25	6.90	14.25	Vertical	-39.9	-13	26.9	135

- Note: 1. The other Spurious RF Radiated emissions level is no more than noise floor.
 2. The worst emission was found in the antenna is vertical position.

LTE Band 13 QPSK 5MHz CH-High, RB 1

Harmonic	Frequency (MHz)	SG (dBm)	Cable Loss (dB)	Gain (dBi)	Antenna Polarization	ERP Level (dBm)	Limit (dBm)	Margin (dB)	Azimuth (deg)
2	1569.0	-62.45	2.00	10.15	Vertical	-54.3	-40	14.3	225
3	2353.5	-52.14	2.51	11.05	Vertical	-43.6	-13	30.6	315
4	3138.0	-56.15	4.20	11.15	Vertical	-49.2	-13	36.2	270
5	3922.5	-53.95	5.20	11.15	Vertical	-48.0	-13	35.0	225
6	4707.0	-53.35	5.50	11.95	Vertical	-46.9	-13	33.9	135
7	5491.5	-52.75	5.70	13.55	Vertical	-44.9	-13	31.9	225
8	6276.0	-51.85	6.30	13.75	Vertical	-44.4	-13	31.4	90
9	7060.5	-50.15	6.80	13.85	Vertical	-43.1	-13	30.1	90
10	7845.0	-47.05	6.90	14.25	Vertical	-39.7	-13	26.7	45

Note: 1.The other Spurious RF Radiated emissions level is no more than noise floor.

2. The worst emission was found in the antenna is vertical position.

LTE Band 13 QPSK 10MHz CH-Low, RB 1

Harmonic	Frequency (MHz)	SG (dBm)	Cable Loss (dB)	Gain (dBi)	Antenna Polarization	ERP Level (dBm)	Limit (dBm)	Margin (dB)	Azimuth (deg)
2	1564.0	-62.25	2.00	10.15	Vertical	-54.1	-40	14.1	180
3	2346.0	-52.94	2.51	11.35	Vertical	-44.1	-13	31.1	225
4	3128.0	-56.15	4.20	10.85	Vertical	-49.5	-13	36.5	135
5	3910.0	-54.65	5.20	11.35	Vertical	-48.5	-13	35.5	225
6	4692.0	-54.25	5.50	11.95	Vertical	-47.8	-13	34.8	90
7	5474.0	-53.55	5.70	13.55	Vertical	-45.7	-13	32.7	90
8	6256.0	-52.25	6.30	13.75	Vertical	-44.8	-13	31.8	45
9	7038.0	-49.45	6.80	13.85	Vertical	-42.4	-13	29.4	180
10	7820.0	-48.05	6.90	14.25	Vertical	-40.7	-13	27.7	45

Note: 1.The other Spurious RF Radiated emissions level is no more than noise floor.

2. The worst emission was found in the antenna is vertical position.

LTE Band 13 QPSK 10MHz CH-Middle, RB 1

Harmonic	Frequency (MHz)	SG (dBm)	Cable Loss (dB)	Gain (dBi)	Antenna Polarization	ERP Level (dBm)	Limit (dBm)	Margin (dB)	Azimuth (deg)
2	1564.0	-63.05	2.00	10.75	Vertical	-54.3	-40	14.3	0
3	2346.0	-52.64	2.51	11.05	Vertical	-44.1	-13	31.1	135
4	3128.0	-56.25	4.20	11.15	Vertical	-49.3	-13	36.3	225
5	3910.0	-54.75	5.20	11.15	Vertical	-48.8	-13	35.8	315
6	4692.0	-54.05	5.50	11.95	Vertical	-47.6	-13	34.6	270
7	5474.0	-53.25	5.70	13.55	Vertical	-45.4	-13	32.4	90
8	6256.0	-52.25	6.30	13.75	Vertical	-44.8	-13	31.8	45
9	7038.0	-49.75	6.80	13.85	Vertical	-42.7	-13	29.7	180
10	7820.0	-47.75	6.90	14.25	Vertical	-40.4	-13	27.4	45

Note: 1.The other Spurious RF Radiated emissions level is no more than noise floor.

2. The worst emission was found in the antenna is vertical position.

LTE Band 13 QPSK 10MHz CH-High, RB 1

Harmonic	Frequency (MHz)	SG (dBm)	Cable Loss (dB)	Gain (dBi)	Antenna Polarization	ERP Level (dBm)	Limit (dBm)	Margin (dB)	Azimuth (deg)
2	1564.0	-62.45	2.00	10.15	Vertical	-54.3	-40	14.3	0
3	2346.0	-52.44	2.51	11.05	Vertical	-43.9	-13	30.9	135
4	3128.0	-56.65	4.20	11.15	Vertical	-49.7	-13	36.7	225
5	3910.0	-54.25	5.20	11.15	Vertical	-48.3	-13	35.3	315
6	4692.0	-53.95	5.50	11.95	Vertical	-47.5	-13	34.5	270
7	5474.0	-53.55	5.70	13.55	Vertical	-45.7	-13	32.7	225
8	6256.0	-52.05	6.30	13.75	Vertical	-44.6	-13	31.6	135
9	7038.0	-49.25	6.80	13.85	Vertical	-42.2	-13	29.2	225
10	7820.0	-48.15	6.90	14.25	Vertical	-40.8	-13	27.8	90

Note: 1.The other Spurious RF Radiated emissions level is no more than noise floor.

2. The worst emission was found in the antenna is vertical position.

5 Main Test Instruments

Date of Testing: June 24, 2017~ July 3, 2017

Name	Manufacturer	Type	Serial Number	Calibration Date	Expiration Time
Base Station Simulator	R&S	CMW500	150415	2017-05-14	2018-05-13
Power Splitter	Hua Xiang	SHX-GF2-2-13	10120101	2017-05-14	2018-05-13
Universal Radio Communication Tester	Agilent	E5515C	MY48367192	2017-05-14	2018-05-13
Spectrum Analyzer	Agilent	N9010A	MY47191109	2017-05-14	2018-05-13
Signal Analyzer	R&S	FSV30	100815	2016-12-16	2017-12-15
Signal generator	R&S	SMB 100A	102594	2017-05-14	2018-05-13
EMI Test Receiver	R&S	ESCI	100948	2017-05-20	2018-05-19
Trilog Antenna	SCHWARZBECK	VUBL 9163	9163-201	2014-12-06	2017-12-05
Horn Antenna	R&S	HF907	100126	2014-12-06	2017-12-05
Horn Antenna	ETS-Lindgren	3160-09	00102643	2015-01-30	2018-01-29
Climatic Chamber	Re Ce	PT-30B	20101891	2015-07-18	2018-07-17
RF Cable	Agilent	SMA 15cm	0001	2017-02-06	2017-08-05
Preamplifier	R&S	SCU18	102327	2017-06-18	2018-06-17

*****END OF REPORT *****



Date of Testing: August10, 2020 ~ August12, 2020

Name	Manufacturer	Type	Serial Number	Calibration Date	Expiration Date
Base Station Simulator	R&S	CMW500	113824	2020-05-18	2021-05-17
Power Splitter	Hua Xiang	SHX-GF2-2-13	10120101	/	/
Spectrum Analyzer	Key sight	N9010A	MY50210259	2020-05-18	2021-05-17
Signal Analyzer	R&S	FSV30	100815	2019-12-15	2020-12-14
Loop Antenna	SCHWARZBECK	FMZB1519	1519-047	2017-09-26	2020-09-25
Trilog Antenna	SCHWARZBECK	VUBL 9163	9163-201	2017-11-18	2020-11-17
Horn Antenna	R&S	HF907	102723	2018-08-11	2021-08-10
Horn Antenna	ETS-Lindgren	3160-09	00102643	2018-06-20	2021-06-19
Signal generator	R&S	SMB 100A	102594	2020-05-18	2021-05-17
Climatic Chamber	ESPEC	SU-242	93000506	2017-12-17	2020-12-16
Preamplifier	R&S	SCU18	102327	2020-05-18	2021-05-17
MOB COMMS DC SUPPLY	Keysight	66319D	MY43004105	2020-05-18	2021-05-17
RF Cable	Agilent	SMA 15cm	0001	2020-06-12	2020-12-11
Software	R&S	EMC32	9.26.0	/	/