



FCC RADIO TEST REPORT

FCC ID : 2AUWW-HALOWA1B
Equipment : Halo Collar
Brand Name : Halo
Model Name : Halo Three
Applicant : Protect Animals with Satellites, LLC
5465 Legacy Dr., Suite 650, Plano, Texas
75024, United States
Manufacturer : RoyalTek Company Ltd.,
8F, No.40, Wenhua 2nd Rd., Guishan Dist.,
Taoyuan City 333010, Taiwan(R.O.C.)
Standard : FCC 47 CFR Part 2, 22(H), 24(E), 27

The product was received on Sep. 02, 2022 and testing was performed from Oct. 15, 2022 to Nov. 17, 2022. We, Sporton International Inc. EMC & Wireless Communications Laboratory, would like to declare that the tested sample has been evaluated in accordance with the test procedures given in ANSI / TIA-603-E and has been in compliance with the applicable technical standards.

The test results in this report apply exclusively to the tested model / sample. Without written approval from Sporton International Inc. EMC & Wireless Communications Laboratory, the test report shall not be reproduced except in full.

Louis Wu

Approved by: Louis Wu

Sporton International Inc. EMC & Wireless Communications Laboratory

No. 52, Huaya 1st Rd., Guishan Dist., Taoyuan City 333, Taiwan (R.O.C.)



Table of Contents

History of this test report..... 3

Summary of Test Result..... 4

1 General Description 6

 1.1 Product Feature of Equipment Under Test..... 6

 1.2 Modification of EUT 6

 1.3 Testing Location 7

 1.4 Applicable Standards..... 7

2 Test Configuration of Equipment Under Test 8

 2.1 Test Mode..... 8

 2.2 Connection Diagram of Test System..... 10

 2.3 Support Unit used in test configuration and system 10

 2.4 Measurement Results Explanation Example..... 10

 2.5 Frequency List of Low/Middle/High Channels 11

3 Conducted Test Items..... 13

 3.1 Measuring Instruments 13

 3.2 Conducted Output Power and ERP/EIRP 14

 3.3 Peak-to-Average Ratio 15

 3.4 Occupied Bandwidth..... 16

 3.5 Conducted Band Edge 17

 3.6 Conducted Spurious Emission 19

 3.7 Frequency Stability 20

4 Radiated Test Items 21

 4.1 Measuring Instruments 21

 4.2 Radiated Spurious Emission Measurement 23

5 List of Measuring Equipment..... 24

6 Uncertainty of Evaluation..... 25

Appendix A. Test Results of Conducted Test

Appendix B. Test Results of Radiated Test

Appendix C. Test Setup Photographs



History of this test report

Report No.	Version	Description	Issue Date
FG901415-05	01	Initial issue of report	Mar. 07, 2023



Summary of Test Result

Report Clause	Ref Std. Clause	Test Items	Result (PASS/FAIL)	Remark
3.2	§2.1046	Conducted Output Power	Reporting only	-
	§22.913 (a)(5)	Effective Radiated Power (Band 5)	Pass	
	§27.50 (b)(10) §27.50 (c)(10)	Effective Radiated Power (Band 12) (Band 13)		
	§24.232 (c)	Equivalent Isotropic Radiated Power (Band 2)		
	§27.50 (d)(4)	Equivalent Isotropic Radiated Power (Band 4)		
3.3	§24.232 (d) §27.50 (d)(5)	Peak-to-Average Ratio	Pass	-
3.4	§2.1049	Occupied Bandwidth	Reporting only	-
3.5	§2.1051 §22.917 (a) §24.238 (a) §27.53 (c)(2)(4) §27.53 (g) §27.53 (h)	Conducted Band Edge Measurement (Band 2) (Band 4) (Band 5) (Band 12) (Band 13)	Pass	-
3.6	§2.1051 §22.917 (a) §24.238 (a) §27.53 (c)(2) §27.53 (g) §27.53 (h)	Conducted Spurious Emission (Band 2) (Band 4) (Band 5) (Band 12) (Band 13)	Pass	-
3.7	§2.1055 §22.355 §24.235 §27.54	Frequency Stability Temperature & Voltage	Pass	-



Report Clause	Ref Std. Clause	Test Items	Result (PASS/FAIL)	Remark
4.2	§2.1053 §22.917 (a) §24.238 (a) §27.53 (c)(2) §27.53 (f) §27.53 (g) §27.53 (h)	Radiated Spurious Emission (Band 2) (Band 4) (Band 5) (Band 12) (Band 13)	Pass	18.11 dB under the limit at 1568.000 MHz

Declaration of Conformity:

1. The test results (PASS/FAIL) with all measurement uncertainty excluded are presented in accordance with the regulation limits or requirements declared by manufacturers.
It's means measurement values may risk exceeding the limit of regulation standards, if measurement uncertainty is include in test results.
2. The measurement uncertainty please refer to report "Uncertainty of Evaluation".

Comments and Explanations:

The product specifications of the EUT presented in the report are declared by the manufacturer who shall take full responsibility for the authenticity.

Reviewed by: Avis Chuang

Report Producer: Ruby Zou



1 General Description

1.1 Product Feature of Equipment Under Test

LTE M1, Bluetooth-LE, Wi-Fi 2.4GHz 802.11b/g/n, and GNSS.

Product Feature	
Antenna Type	WWAN: Loop Antenna WLAN: Chip Antenna Bluetooth-LE: Chip Antenna BDS / Galileo / GPS / Glonass : linear polarization Antenna
Antenna Gain	LTE Band 2: -1.60 dBi LTE Band 4: -0.63 dBi LTE Band 5: -3.30 dBi LTE Band 12: -6.25 dBi LTE Band 13: -1.34 dBi

Remark: The EUT's information above is declared by manufacturer. Please refer to Comments and Explanations in report summary.

1.2 Modification of EUT

No modifications made to the EUT during the testing.



1.3 Testing Location

Test Site	Sporton International Inc. EMC & Wireless Communications Laboratory	
Test Site Location	No.52, Huaya 1st Rd., Guishan Dist., Taoyuan City 333, Taiwan (R.O.C.) TEL: +886-3-327-3456 FAX: +886-3-328-4978	
Test Site No.	Sporton Site No.	
	TH03-HY	03CH07-HY
Test Engineer	Bryant Liu	Stan Hsieh and Ken Wu
Temperature (°C)	22.1~23.2	24.8~25.6
Relative Humidity (%)	52~56	60.6~63.1

Note: The test site complies with ANSI C63.4 2014 requirement.

FCC Designation No.: TW1190

1.4 Applicable Standards

According to the specifications of the manufacturer, the EUT must comply with the requirements of the following standards:

- ♦ ANSI C63.26-2015
- ♦ ANSI / TIA-603-E
- ♦ FCC 47 CFR Part 2, 22(H), 24(E), 27
- ♦ FCC KDB 971168 D01 Power Meas. License Digital Systems v03r01
- ♦ FCC KDB 412172 D01 Determining ERP and EIRP v01r01
- ♦ FCC KDB 414788 D01 Radiated Test Site v01r01.

Remark:

1. All the test items were validated and recorded in accordance with the standards without any modification during the testing.
2. This EUT has also been tested and complied with the requirements of FCC Part 15, Subpart B, recorded in a separate test report.
3. The TAF code is not including all the FCC KDB listed without accreditation.



2 Test Configuration of Equipment Under Test

2.1 Test Mode

Antenna port conducted and radiated test items listed below are performed according to KDB 971168 D01 Power Meas. License Digital Systems v03r01 with maximum output power.

For radiated measurement, the measured emission level of the EUT was maximized by rotating the EUT on a turntable, adjusting the orientation of the EUT and EUT antenna in three orthogonal axis (X: flat, Y: portrait, Z: landscape), and adjusting the measurement antenna orientation, following C63.26 exploratory test procedures and only the worst case emissions were reported in this report.

Test Items	Band	Bandwidth (MHz)						Modulation		RB #			Test Channel		
		1.4	3	5	10	15	20	QPSK	16QAM	1	Half	Full	L	M	H
Max. Output Power	2	v	-	-	-	-	-	v	v	v	v	v	v	v	v
	4	v	-	-	-	-	-	v	v	v	v	v	v	v	v
	5	v	-	-	-	-	-	v	v	v	v	v	v	v	v
	12	v	-	-	-	-	-	v	v	v	v	v	v	v	v
	13	-	-	v	-	-	-	v	v	v	v	v	v	v	v
Peak-to-Average Ratio	2	v	-	-	-	-	-	v	v			v		v	
	4	v	-	-	-	-	-	v	v			v		v	
	5	v	-	-	-	-	-	v	v			v		v	
	12	v	-	-	-	-	-	v	v			v		v	
	13	-	-	v	-	-	-	v	v			v		v	
26dB and 99% Bandwidth	2	v	-	-	-	-	-	v	v			v		v	
	4	v	-	-	-	-	-	v	v			v		v	
	5	v	-	-	-	-	-	v	v			v		v	
	12	v	-	-	-	-	-	v	v			v		v	
	13	-	-	v	-	-	-	v	v			v		v	
Conducted Band Edge	2	v	-	-	-	-	-	v	v	v		v	v		v
	4	v	-	-	-	-	-	v	v	v		v	v		v
	5	v	-	-	-	-	-	v	v	v		v	v		v
	12	v	-	-	-	-	-	v	v	v		v	v		v
	13	-	-	v	-	-	-	v	v	v		v	v		v



Test Items	Band	Bandwidth (MHz)						Modulation		RB #			Test Channel		
		1.4	3	5	10	15	20	QPSK	16QAM	1	Half	Full	L	M	H
Conducted Spurious Emission	2	v	-	-	-	-	-	v		v			v	v	v
	4	v	-	-	-	-	-	v		v			v	v	v
	5	v	-	-	-	-	-	v		v			v	v	v
	12	v	-	-	-	-	-	v		v			v	v	v
	13	-	-	v	-	-	-	v		v			v	v	v
Frequency Stability	2	v	-	-	-	-	-	v				v		v	
	4	v	-	-	-	-	-	v				v		v	
	5	v	-	-	-	-	-	v				v		v	
	12	v	-	-	-	-	-	v				v		v	
	13	-	-	v	-	-	-	v				v		v	
E.R.P / E.I.R.P	2	v	-	-	-	-	-	v	v	Max. Power					
	4	v	-	-	-	-	-	v	v						
	5	v	-	-	-	-	-	v	v						
	12	v	-	-	-	-	-	v	v						
	13	-	-	v	-	-	-	v	v						
Radiated Spurious Emission	2	Worst Case										v	v	v	
	4	Worst Case										v	v	v	
	5	Worst Case										v	v	v	
	12	Worst Case										v	v	v	
	13	Worst Case										v	v	v	
Remark	1. The mark "v" means that this configuration is chosen for testing 2. The mark "-" means that this bandwidth is not supported. 3. The device is investigated from 30MHz to 10 times of fundamental signal for radiated spurious emission test under different RB size/offset and modulations in exploratory test. Subsequently, only the worst case emissions are reported. 4. It is only support narrow band index 0 for LTE Band 13.														

2.2 Connection Diagram of Test System

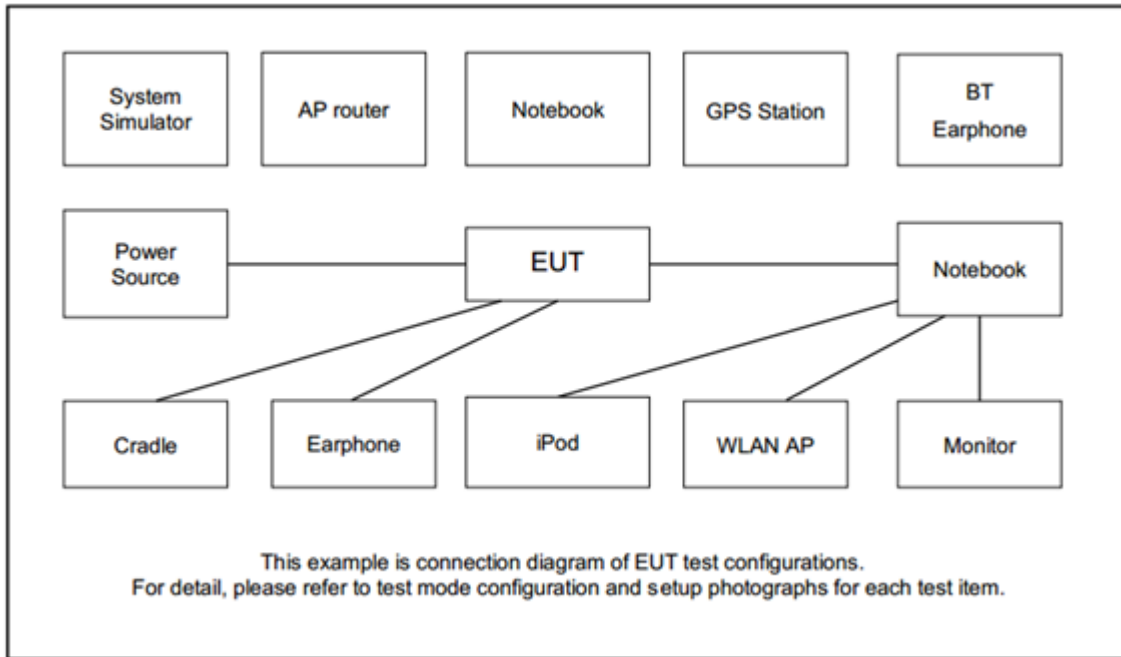

2.3 Support Unit used in test configuration and system

Item	Equipment	Brand Name	Model No.	FCC ID	Data Cable	Power Cord
1.	System Simulator	Anritsu	MT8821C	N/A	N/A	Unshielded, 1.8 m
2.	Adapter	SONY	EP800	FCC Doc	N/A	N/A

2.4 Measurement Results Explanation Example

For all conducted test items:

The offset level is set in the spectrum analyzer to compensate the RF cable loss and attenuator factor between EUT conducted output port and spectrum analyzer. With the offset compensation, the spectrum analyzer reading level is exactly the EUT RF output level.

The spectrum analyzer offset is derived from RF cable loss and attenuator factor.

Offset = RF cable loss + attenuator factor.

Following shows an offset computation example with cable loss 4.2 dB and 10dB attenuator.

Example :

$$\begin{aligned} \text{Offset(dB)} &= \text{RF cable loss(dB)} + \text{attenuator factor(dB)}. \\ &= 4.2 + 10 = 14.2 \text{ (dB)} \end{aligned}$$



2.5 Frequency List of Low/Middle/High Channels

LTE Band 2 Channel and Frequency List				
BW [MHz]	Channel/Frequency(MHz)	Lowest	Middle	Highest
20	Channel	18700	18900	19100
	Frequency	1860	1880	1900
15	Channel	18675	18900	19125
	Frequency	1857.5	1880	1902.5
10	Channel	18650	18900	19150
	Frequency	1855	1880	1905
5	Channel	18625	18900	19175
	Frequency	1852.5	1880	1907.5
3	Channel	18615	18900	19185
	Frequency	1851.5	1880	1908.5
1.4	Channel	18607	18900	19193
	Frequency	1850.7	1880	1909.3

LTE Band 4 Channel and Frequency List				
BW [MHz]	Channel/Frequency(MHz)	Lowest	Middle	Highest
20	Channel	20050	20175	20300
	Frequency	1720	1732.5	1745
15	Channel	20025	20175	20325
	Frequency	1717.5	1732.5	1747.5
10	Channel	20000	20175	20350
	Frequency	1715	1732.5	1750
5	Channel	19975	20175	20375
	Frequency	1712.5	1732.5	1752.5
3	Channel	19965	20175	20385
	Frequency	1711.5	1732.5	1753.5
1.4	Channel	19957	20175	20393
	Frequency	1710.7	1732.5	1754.3



LTE Band 5 Channel and Frequency List				
BW [MHz]	Channel/Frequency(MHz)	Lowest	Middle	Highest
10	Channel	20450	20525	20600
	Frequency	829	836.5	844
5	Channel	20425	20525	20625
	Frequency	826.5	836.5	846.5
3	Channel	20415	20525	20635
	Frequency	825.5	836.5	847.5
1.4	Channel	20407	20525	20643
	Frequency	824.7	836.5	848.3

LTE Band 12 Channel and Frequency List				
BW [MHz]	Channel/Frequency(MHz)	Lowest	Middle	Highest
10	Channel	23060	23095	23130
	Frequency	704	707.5	711
5	Channel	23035	23095	23155
	Frequency	701.5	707.5	713.5
3	Channel	23025	23095	23165
	Frequency	700.5	707.5	714.5
1.4	Channel	23017	23095	23173
	Frequency	699.7	707.5	715.3

LTE Band 13 Channel and Frequency List				
BW [MHz]	Channel/Frequency(MHz)	Lowest	Middle	Highest
5	Channel	23205	23230	23255
	Frequency	779.5	782	784.5

3 Conducted Test Items

3.1 Measuring Instruments

See list of measuring instruments of this test report.

3.1.1 Test Setup

3.1.2 Conducted Output Power

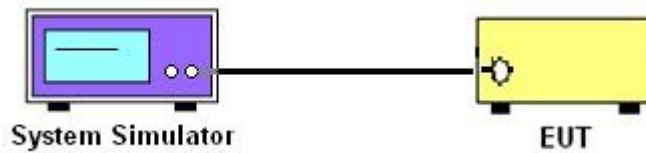

3.1.3 Peak-to-Average Ratio, Occupied Bandwidth ,Conducted Band-Edge and Conducted Spurious Emission

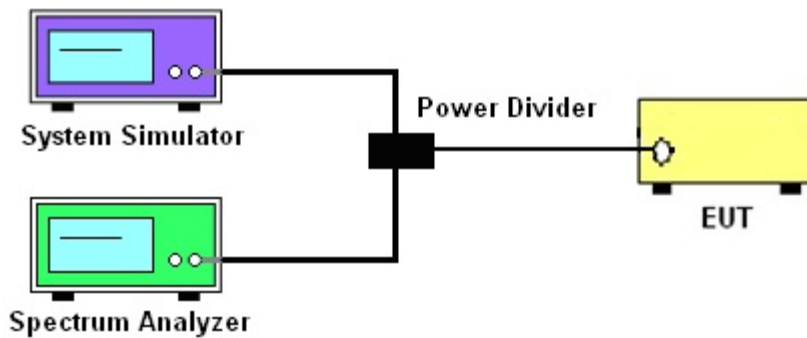

3.1.4 Frequency Stability

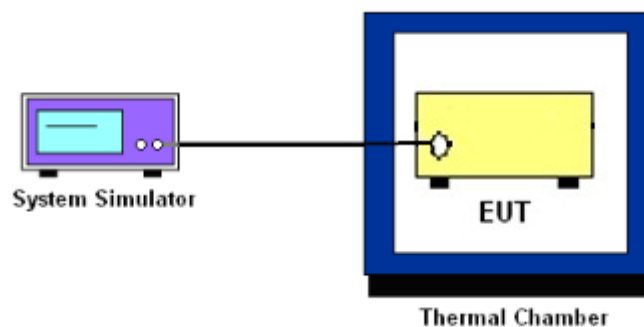

3.1.5 Test Result of Conducted Test

Please refer to Appendix A.



3.2 Conducted Output Power and ERP/EIRP

3.2.1 Description of the Conducted Output Power Measurement and ERP/EIRP Measurement

A system simulator was used to establish communication with the EUT. Its parameters were set to force the EUT transmitting at maximum output power. The measured power in the radio frequency on the transmitter output terminals shall be reported.

The ERP of mobile transmitters must not exceed 7 Watts for LTE Band 5

The ERP of mobile transmitters must not exceed 3 Watts for LTE Band 12 and Band 13

The EIRP of mobile transmitters must not exceed 2 Watts for LTE Band 2

The EIRP of mobile transmitters must not exceed 1 Watts for LTE Band 4

According to KDB 412172 D01 Power Approach,

$EIRP = P_T + G_T - L_C$, $ERP = EIRP - 2.15$, where

P_T = transmitter output power in dBm

G_T = gain of the transmitting antenna in dBi

L_C = signal attenuation in the connecting cable between the transmitter and antenna in dB

3.2.2 Test Procedures

1. The transmitter output port was connected to the system simulator.
2. Set EUT at maximum power through the system simulator.
3. Select lowest, middle, and highest channels for each band and different modulation.
4. Measure and record the power level from the system simulator.



3.3 Peak-to-Average Ratio

3.3.1 Description of the PAR Measurement

Power Complementary Cumulative Distribution Function (CCDF) curves provide a means for characterizing the power peaks of a digitally modulated signal on a statistical basis. A CCDF curve depicts the probability of the peak signal amplitude exceeding the average power level. Most contemporary measurement instrumentation include the capability to produce CCDF curves for an input signal provided that the instrument's resolution bandwidth can be set wide enough to accommodate the entire input signal bandwidth. In measuring transmissions in this band using an average power technique, the peak-to-average ratio (PAR) of the transmission may not exceed 13 dB.

3.3.2 Test Procedures

The testing follows ANSI C63.26-2015 Section 5.2.6

1. The EUT was connected to spectrum and system simulator via a power divider.
2. Set the CCDF (Complementary Cumulative Distribution Function) option in spectrum analyzer.
3. The highest RF powers were measured and recorded the maximum PAPR level associated with a probability of 0.1 %.
4. Record the deviation as Peak to Average Ratio.



3.4 Occupied Bandwidth

3.4.1 Description of Occupied Bandwidth Measurement

The occupied bandwidth is the width of a frequency band such that, below the lower and above the upper frequency limits, the mean powers emitted are each equal to a specified percentage 0.5% of the total mean transmitted power.

The 26 dB emission bandwidth is defined as the frequency range between two points, one above and one below the carrier frequency, at which the spectral density of the emission is attenuated 26 dB below the maximum in-band spectral density of the modulated signal. Spectral density (power per unit bandwidth) is to be measured with a detector of resolution bandwidth equal to approximately 1.0% of the emission bandwidth.

3.4.2 Test Procedures

The testing follows ANSI C63.26-2015 Section 5.4.3 (26dB) and Section 5.4.4 (99OB)

1. The EUT was connected to spectrum analyzer and system simulator via a power divider.
2. The spectrum analyzer center frequency is set to the nominal EUT channel center frequency. The span range for the spectrum analyzer shall be between two and five times the anticipated OBW.
3. The nominal resolution bandwidth (RBW) shall be in the range of 1 to 5 % of the anticipated OBW, and the VBW shall be at least 3 times the RBW.
4. Set the detection mode to peak, and the trace mode to max hold.
5. Determine the reference value: Set the EUT to transmit a modulated signal. Allow the trace to stabilize. Set the spectrum analyzer marker to the highest level of the displayed trace.
(this is the reference value)
6. Determine the “-26 dB down amplitude” as equal to (Reference Value – X).
7. Place two markers, one at the lowest and the other at the highest frequency of the envelope of the spectral display such that each marker is at or slightly below the “-X dB down amplitude” determined in step 6. If a marker is below this “-X dB down amplitude” value it shall be placed as close as possible to this value. The OBW is the positive frequency difference between the two markers.
8. Use the 99 % power bandwidth function of the spectrum analyzer and report the measured bandwidth.



3.5 Conducted Band Edge

3.5.1 Description of Conducted Band Edge Measurement

22.917(a)

For operations in the 824 – 849 MHz band, the FCC limit is $43 + 10\log_{10}(P[\text{Watts}])$ dB below the transmitter power $P(\text{Watts})$ in a 100kHz bandwidth. However, in the 1MHz bands immediately outside and adjacent to the licensee's frequency block, a resolution bandwidth of at least one percent of the emission bandwidth of the fundamental emission of the transmitter may be employed.

24.238 (a)

For operations in the 1850-1910 and 1930-1990 MHz band, the FCC limit is $43 + 10\log_{10}(P[\text{Watts}])$ dB below the transmitter power $P(\text{Watts})$ in a 1MHz bandwidth. However, in the 1 MHz bands immediately outside and adjacent to the frequency block a resolution bandwidth of at least one percent of the emission bandwidth of the fundamental emission of the transmitter may be employed.

27.53 (c)

For operations in the 776-788 MHz band, the FCC limit is $43 + 10\log_{10}(P[\text{Watts}])$ dB below the transmitter power $P(\text{Watts})$ in a 100 kHz bandwidth. However, in the 100 kHz bands immediately outside and adjacent to the frequency block, a resolution bandwidth of at least 30 kHz may be employed. In addition, the power of any unwanted emissions in any 6.25 kHz bandwidth for all frequencies between 763-775 MHz and 793-806 MHz shall be attenuated below the transmitter power, P (dBW), by at least $65 + 10 \log_{10} p(\text{watts})$, dB, for mobile and portable equipment.

27.53 (g)

For operations in the 600MHz band and 698-746 MHz band, the FCC limit is $43 + 10\log_{10}(P[\text{Watts}])$ dB below the transmitter power $P(\text{Watts})$ in a 100 kHz bandwidth. However, in the 100 kilohertz bands immediately outside and adjacent to a licensee's frequency block, a resolution bandwidth of at least 30 kHz may be employed.

27.53 (h)

For operations in the 1710 – 1755 MHz band, 1755-1780 MHz, the FCC limit is $43 + 10\log_{10}(P[\text{Watts}])$ dB below the transmitter power $P(\text{Watts})$ in a 1 MHz bandwidth. However, in the 1MHz bands immediately outside and adjacent to the licensee's frequency block, a resolution bandwidth of at least one percent of the emission bandwidth of the fundamental emission of the transmitter may be employed.



3.5.2 Test Procedures

The testing follows FCC KDB 971168 D01 v03r01 Section 6.1.

1. The EUT was connected to spectrum analyzer and system simulator via a power divider.
2. The band edges of low and high channels for the highest RF powers were measured.
3. Set RBW \geq 1% EBW in the 1MHz band immediately outside and adjacent to the band edge.
4. Beyond the 1 MHz band from the band edge, RBW=1MHz was used.
5. Set spectrum analyzer with RMS detector.
6. The RF fundamental frequency should be excluded against the limit line in the operating frequency band.
7. Checked that all the results comply with the emission limit line.

The limit line is derived from $43 + 10\log(P)$ dB below the transmitter power P(Watts)



3.6 Conducted Spurious Emission

3.6.1 Description of Conducted Spurious Emission Measurement

The power of any emission outside of the authorized operating frequency ranges must be lower than the transmitter power (P) by a factor of at least $43 + 10 \log (P)$ dB.

It is measured by means of a calibrated spectrum analyzer and scanned from 30 MHz up to a frequency including its 10th harmonic.

3.6.2 Test Procedures

The testing follows FCC KDB 971168 D01 v03r01 Section 6.1.

1. The EUT was connected to spectrum analyzer and system simulator via a power divider.
2. The RF output of EUT was connected to the spectrum analyzer by RF cable and attenuator.
The path loss was compensated to the results for each measurement.
3. The middle channel for the highest RF power within the transmitting frequency was measured.
4. The conducted spurious emission for the whole frequency range was taken.
5. Make the measurement with the spectrum analyzer's RBW = 1MHz, VBW = 3MHz.
6. Set spectrum analyzer with RMS detector.
7. Taking the record of maximum spurious emission.
8. The RF fundamental frequency should be excluded against the limit line in the operating frequency band.
9. The limit line is derived from $43 + 10\log(P)$ dB below the transmitter power P(Watts)



3.7 Frequency Stability

3.7.1 Description of Frequency Stability Measurement

22.355

The frequency stability shall be measured by variation of ambient temperature and variation of primary supply voltage to ensure that the fundamental emission stays within the authorized frequency block. The frequency stability of the transmitter shall be maintained within $\pm 0.00025\%$ ($\pm 2.5\text{ppm}$) of the center frequency.

24.235 & 27.54

The frequency stability shall be sufficient to ensure that the fundamental emission stays within the authorized frequency block.

3.7.2 Test Procedures for Temperature Variation

The testing follows FCC KDB 971168 D01 v03r01 Section 9.0.

1. The EUT was set up in the thermal chamber and connected with the system simulator.
2. With power OFF, the temperature was decreased to -30°C and the EUT was stabilized before testing. Power was applied and the maximum change in frequency was recorded within one minute.
3. With power OFF, the temperature was raised in 10°C step up to 50°C . The EUT was stabilized at each step for at least half an hour. Power was applied and the maximum frequency change was recorded within one minute.

3.7.3 Test Procedures for Voltage Variation

The testing follows FCC KDB 971168 D01 v03r01 Section 9.0.

1. The EUT was placed in a temperature chamber at $20\pm 5^{\circ}\text{C}$ and connected with the system simulator.
2. The power supply voltage to the EUT was varied from 85% to 115% of the nominal value measured at the input to the EUT.
3. The variation in frequency was measured for the worst case.

4 Radiated Test Items

4.1 Measuring Instruments

See list of measuring instruments of this test report.

4.1.1 Test Setup

For radiated test below 30MHz

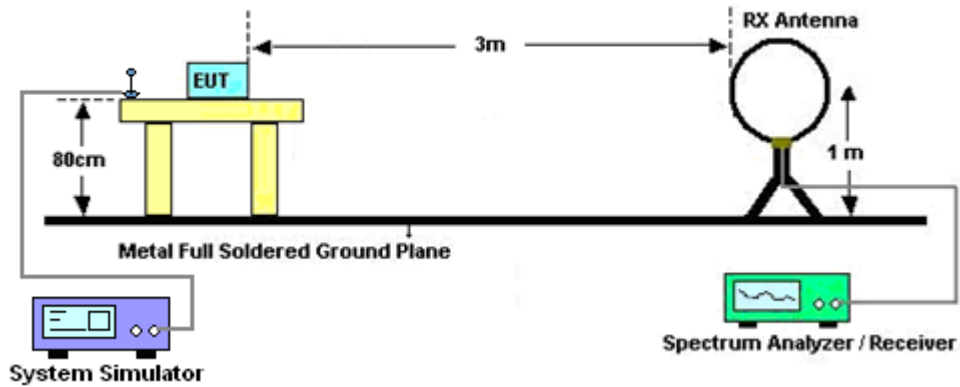

For radiated test from 30MHz to 1GHz

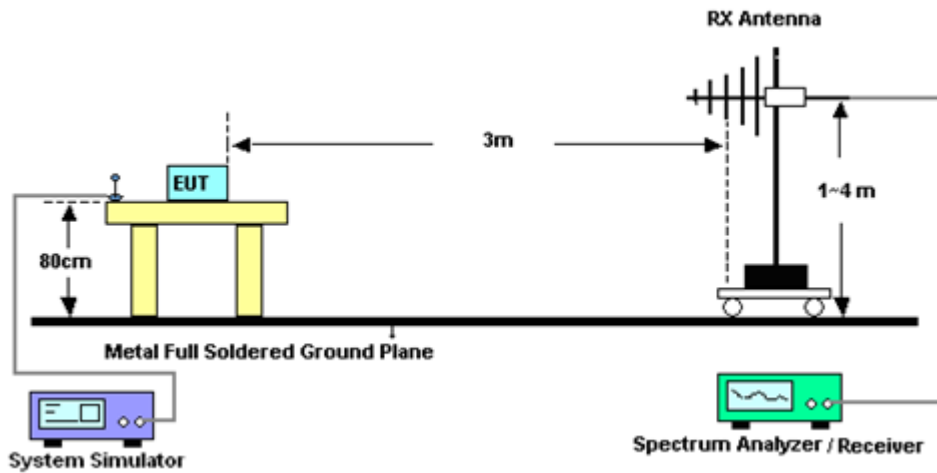

For radiated test from 1GHz to 18GHz

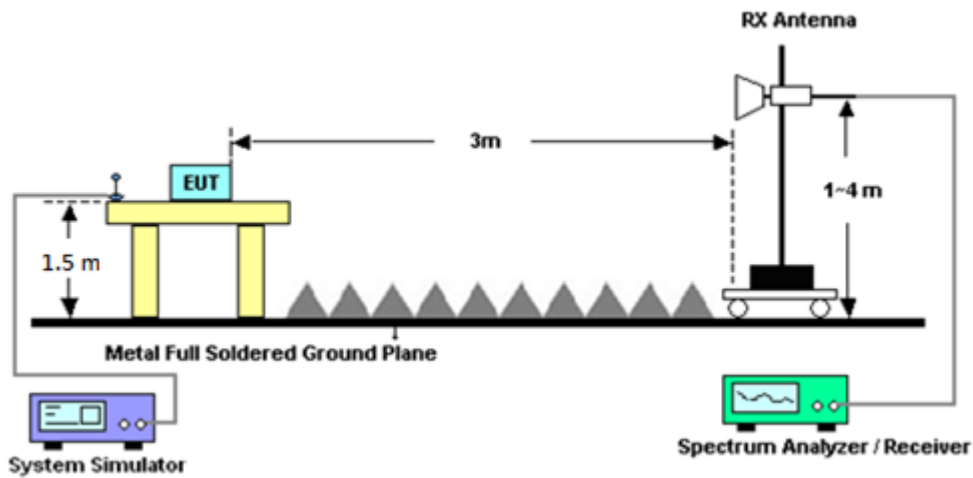

For radiated test above 18GHz

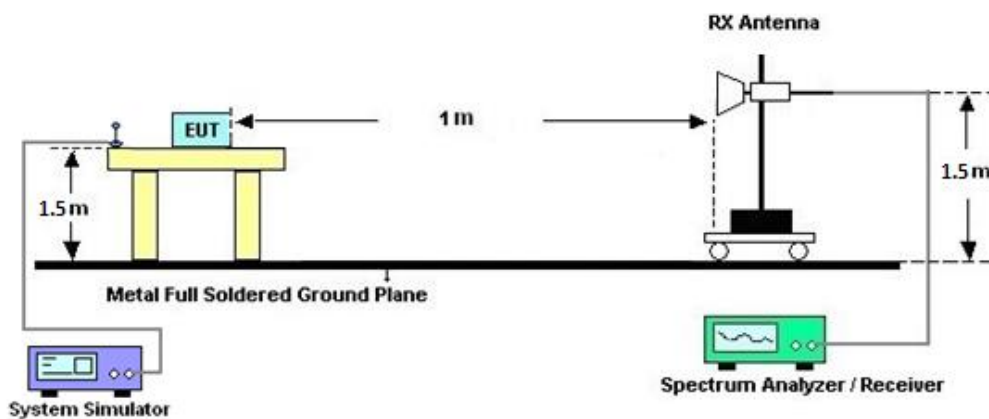

4.1.2 Test Result of Radiated Test

Please refer to Appendix B.

Note:

The low frequency, which started from 9 kHz to 30MHz, was pre-scanned and the result which was 20dB lower than the limit line was not reported.

There is adequate comparison measurement of both open-field test site and alternative test site - semi-Anechoic chamber according to 414788 D01 Radiated Test Site v01r01, and the result came out very similar.



4.2 Radiated Spurious Emission Measurement

4.2.1 Description of Radiated Spurious Emission Measurement

The radiated spurious emission was measured by substitution method according to ANSI / TIA-603-E. The power of any emission outside of the authorized operating frequency ranges must be attenuated below the transmitter power (P) by a factor of at least $43 + 10 \log (P)$ dB.

For LTE Band 13

For operations in the 746-758 MHz, 775-788 MHz, and 805-806 MHz bands, emissions in the band 1559-1610 MHz shall be limited to -70 dBW/MHz equivalent isotropically radiated power (EIRP) for wideband signals, and -80 dBW EIRP for discrete emissions of less than 700 Hz bandwidth.

The spectrum is scanned from 30 MHz up to a frequency including its 10th harmonic.

4.2.2 Test Procedures

The testing follows FCC KDB 971168 D01 v03r01 Section 7 and ANSI / TIA-603-E Section 2.2.12.

1. The EUT was placed on a turntable with 0.8 meter for frequency below 1GHz and 1.5 meter for frequency above 1GHz respectively above ground.
2. The EUT was set 3 meters from the receiving antenna, which was mounted on the antenna tower.
3. The table was rotated 360 degrees to determine the position of the highest spurious emission.
4. The height of the receiving antenna is varied between one meter and four meters to search the maximum spurious emission for both horizontal and vertical polarizations.
5. Make the measurement with the spectrum analyzer's RBW = 1MHz, VBW = 3MHz, taking the record of maximum spurious emission.
6. A horn antenna was substituted in place of the EUT and was driven by a signal generator.
7. Tune the output power of signal generator to the same emission level with EUT maximum spurious emission.
8. Taking the record of output power at antenna port.
9. Repeat step 7 to step 8 for another polarization.
10. The RF fundamental frequency should be excluded against the limit line in the operating frequency band.

The limit line is derived from $43 + 10\log(P)$ dB below the transmitter power P(Watts)

$EIRP$ (dBm) = S.G. Power – Tx Cable Loss + Tx Antenna Gain

ERP (dBm) = $EIRP - 2.15$



5 List of Measuring Equipment

Instrument	Brand Name	Model No.	Serial No.	Characteristics	Calibration Date	Test Date	Due Date	Remark
Radio Communication Analyzer	Anritsu	MT8821C	6262025353	LTE FDD/TDD LTE-2CC DLCA/ULCA	Oct. 13, 2022	Oct. 25, 2022~ Nov. 17, 2022	Oct. 12, 2023	Conducted (TH03-HY)
Spectrum Analyzer	Rohde & Schwarz	FSV40	101908	10Hz~40GHz	Sep. 27, 2022	Oct. 25, 2022~ Nov. 17, 2022	Sep. 26, 2023	Conducted (TH03-HY)
Thermal Chamber	ESPEC	SH-641	92013720	-40°C ~90°C	Sep. 07, 2022	Oct. 25, 2022~ Nov. 17, 2022	Sep. 06, 2023	Conducted (TH03-HY)
DC Power Supply	GW Instek	GPP-2323	GES906037	0V~64V ; 0A~6A	Jan. 06, 2022	Oct. 25, 2022~ Nov. 17, 2022	Jan. 05, 2023	Conducted (TH03-HY)
Coupler	Warison	20dB 25W SMA Directional Coupler	#B	1-18GHz	Jan. 07, 2022	Oct. 25, 2022~ Nov. 17, 2022	Jan. 06, 2023	Conducted (TH03-HY)
Bilog Antenna	TESEQ	CBL 6111D & 00800N1D01N-06	35419 & 03	30MHz~1GHz	Apr. 24, 2022	Oct. 15, 2022~ Oct. 16, 2022	Apr. 23, 2023	Radiation (03CH07-HY)
Double Ridge Horn Antenna	ESCO	3117	00075962	1GHz ~ 18GHz	Dec. 03, 2021	Oct. 15, 2022~ Oct. 16, 2022	Dec. 02, 2022	Radiation (03CH07-HY)
Preamplifier	COM-POWER	PA-103A	161241	10MHz~1GHz	Oct. 03, 2022	Oct. 15, 2022~ Oct. 16, 2022	Oct. 02, 2023	Radiation (03CH07-HY)
Preamplifier	Agilent	8449B	3008A02362	1GHz~26.5GHz	Oct. 03, 2022	Oct. 15, 2022~ Oct. 16, 2022	Oct. 02, 2023	Radiation (03CH07-HY)
Preamplifier	EMEC	EM18G40G	0600789	18-40GHz	Jul. 21, 2022	Oct. 15, 2022~ Oct. 16, 2022	Jul. 20, 2023	Radiation (03CH07-HY)
Spectrum Analyzer	Agilent	N9030A	MY52350276	3Hz~44GHz	Jul. 22, 2022	Oct. 15, 2022~ Oct. 16, 2022	Jul. 21, 2023	Radiation (03CH07-HY)
RF Cable	HUBER + SUHNER	SUCOFLEX 104	MY15682/4	30MHz to 18GHz	Feb. 23, 2022	Oct. 15, 2022~ Oct. 16, 2022	Feb. 22, 2023	Radiation (03CH07-HY)
RF Cable	HUBER + SUHNER	SUCOFLEX 104	MY24971/4	9kHz to 18GHz	Feb. 23, 2022	Oct. 15, 2022~ Oct. 16, 2022	Feb. 22, 2023	Radiation (03CH07-HY)
RF Cable	HUBER + SUHNER	SUCOFLEX 104	MY28655/4	9kHz to 18GHz	Feb. 23, 2022	Oct. 15, 2022~ Oct. 16, 2022	Feb. 22, 2023	Radiation (03CH07-HY)
RF Cable	HUBER + SUHNER	SUCOFLEX 102	MY2858/2	18GHz~40GHz	Feb. 23, 2022	Oct. 15, 2022~ Oct. 16, 2022	Feb. 22, 2023	Radiation (03CH07-HY)
Controller	EMEC	EM1000	N/A	Control Ant Mast	N/A	Oct. 15, 2022~ Oct. 16, 2022	N/A	Radiation (03CH07-HY)
Controller	MF	MF-7802	N/A	Control Turn table	N/A	Oct. 15, 2022~ Oct. 16, 2022	N/A	Radiation (03CH07-HY)
Antenna Mast	EMEC	AM-BS-4500E	N/A	Boresight mast 1M~4M	N/A	Oct. 15, 2022~ Oct. 16, 2022	N/A	Radiation (03CH07-HY)
Turn Table	ChainTek	Chaintek 3000	N/A	0~360 Degree	N/A	Oct. 15, 2022~ Oct. 16, 2022	N/A	Radiation (03CH07-HY)
Software	Audix	E3	N/A	N/A	N/A	Oct. 15, 2022~ Oct. 16, 2022	N/A	Radiation (03CH07-HY)
USB Data Logger	TECPEL	TR-32	HE17XB2495	N/A	Mar. 07, 2022	Oct. 15, 2022~ Oct. 16, 2022	Mar. 06, 2023	Radiation (03CH07-HY)
Horn Antenna	ETS-Lindgren	3117	00143261	1GHz~18GHz	Feb. 11, 2022	Oct. 15, 2022~ Oct. 16, 2022	Feb. 10, 2023	Radiation (03CH07-HY)
SHF-EHF Horn Antenna	SCHWARZBECK	BBHA 9170	BBHA9170251	18GHz~40GHz	Nov. 30, 2021	Oct. 15, 2022~ Oct. 16, 2022	Nov. 29, 2022	Radiation (03CH07-HY)
Signal Generator	Anritsu	MG3710A	6261943042	2G / 3G / LTE / 5G FR1	May 23, 2022	Oct. 15, 2022~ Oct. 16, 2022	May 22, 2023	Radiation (03CH07-HY)



6 Uncertainty of Evaluation

Uncertainty of Radiated Emission Measurement (30 MHz ~ 1000 MHz)

Measuring Uncertainty for a Level of Confidence of 95% ($U = 2Uc(y)$)	3.25 dB
---	---------

Uncertainty of Radiated Emission Measurement (1 GHz ~ 18 GHz)

Measuring Uncertainty for a Level of Confidence of 95% ($U = 2Uc(y)$)	3.50 dB
---	---------

Uncertainty of Radiated Emission Measurement (18 GHz ~ 40 GHz)

Measuring Uncertainty for a Level of Confidence of 95% ($U = 2Uc(y)$)	4.08 dB
---	---------



Appendix A. Test Results of Conducted Test

Conducted Output Power(Average power & ERP/EIRP)

LTE Band 2 Maximum Average Power [dBm] (GT - LC = -1.6 dB)								
BW [MHz]	RB Size	RB Offset	Mod	Lowest	Middle	Highest	EIRP (dBm)	EIRP (W)
1.4	1	0	QPSK	22.23	22.25	22.76	21.45	0.1396
1.4	1	5		22.63	22.31	23.05		
1.4	6	0		22.27	22.03	22.79		
1.4	1	0	16-QAM	21.62	21.58	22.34	21.22	0.1324
1.4	1	5		22.10	21.92	22.54		
1.4	5	0		22.39	22.16	22.82		
Limit	EIRP < 2W			Result			Pass	

LTE Band 4 Maximum Average Power [dBm] (GT - LC = -0.63 dB)								
BW [MHz]	RB Size	RB Offset	Mod	Lowest	Middle	Highest	EIRP (dBm)	EIRP (W)
1.4	1	0	QPSK	22.41	22.13	22.04	22.09	0.1618
1.4	1	5		22.72	22.49	22.49		
1.4	6	0		22.42	22.16	22.11		
1.4	1	0	16-QAM	22.10	22.11	22.20	22.03	0.1596
1.4	1	5		22.16	22.16	22.13		
1.4	5	0		22.66	22.45	21.76		
Limit	EIRP < 1W			Result			Pass	

LTE Band 5 Maximum Average Power [dBm] (GT - LC = -3.3 dB)								
BW [MHz]	RB Size	RB Offset	Mod	Lowest	Middle	Highest	ERP (dBm)	ERP (W)
1.4	1	0	QPSK	22.44	22.31	22.51	17.06	0.0508
1.4	1	5		22.47	22.43	22.46		
1.4	6	0		22.34	22.24	22.27		
1.4	1	0	16-QAM	22.09	21.72	22.01	17.05	0.0507
1.4	1	5		22.17	22.05	22.02		
1.4	5	0		22.50	22.45	22.48		
Limit	ERP < 7W			Result			Pass	



LTE Band 12 Maximum Average Power [dBm] (GT - LC = -6.25 dB)								
BW [MHz]	RB Size	RB Offset	Mod	Lowest	Middle	Highest	ERP (dBm)	ERP (W)
1.4	1	0	QPSK	23.74	23.45	23.45	15.56	0.0360
1.4	1	5		23.96	23.52	23.62		
1.4	6	0		22.67	22.41	22.40		
1.4	1	0	16-QAM	23.38	23.16	23.15	15.35	0.0343
1.4	1	5		23.62	23.21	23.02		
1.4	5	0		23.75	23.63	23.51		
Limit	ERP < 3W			Result			Pass	

LTE Band 13 Maximum Average Power [dBm] (GT - LC = -1.34 dB)								
BW [MHz]	RB Size	RB Offset	Mod	Lowest	Middle	Highest	ERP (dBm)	ERP (W)
5	1	0	QPSK	22.75	22.60	22.83	19.48	0.0887
5	1	5		22.97	22.78	22.95		
5	6	0		22.68	22.61	22.72		
5	1	0	16-QAM	22.34	22.14	22.30	19.43	0.0877
5	1	5		22.46	22.41	22.62		
5	5	0		22.92	22.84	22.85		
Limit	ERP < 3W			Result			Pass	



LTE Band 2

Peak-to-Average Ratio

Mode	LTE Band 2 / 1.4MHz				
Mod.	QPSK	16QAM	64QAM	256QAM	Limit: 13dB
RB Size	Full RB	Full RB	Full RB	Full RB	Result
Middle CH	7.42	7.36	-	-	PASS

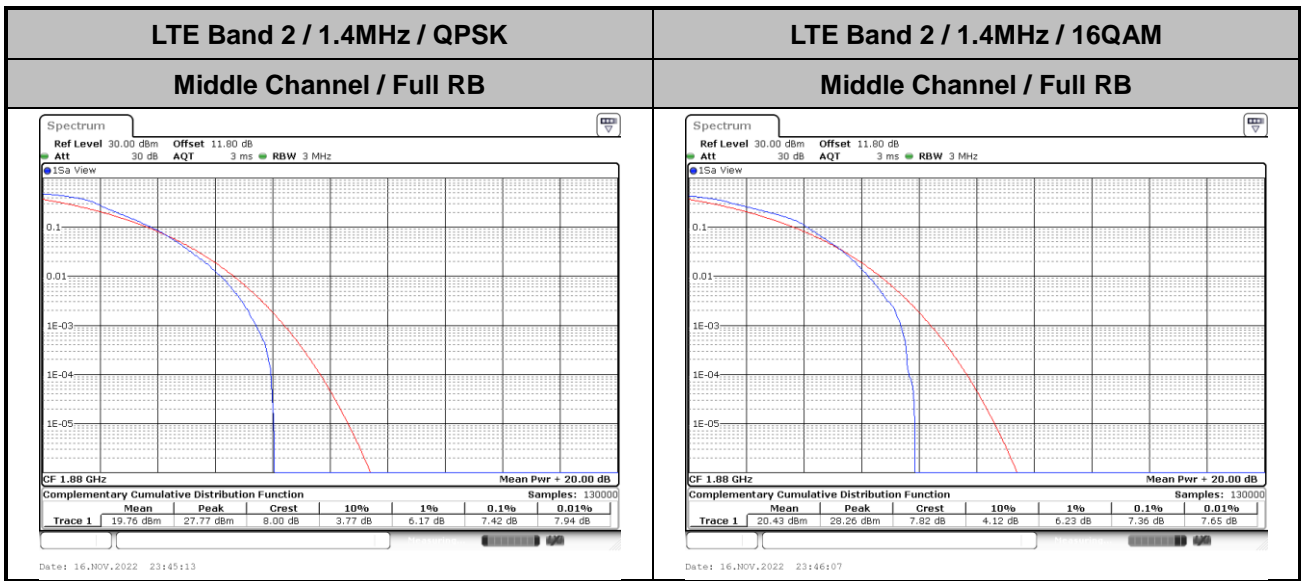



26dB Bandwidth

Mode	LTE Band 2 : 26dB BW(MHz)											
	1.4MHz		3MHz		5MHz		10MHz		15MHz		20MHz	
Mod.	QPSK	16QAM	QPSK	16QAM	QPSK	16QAM	QPSK	16QAM	QPSK	16QAM	QPSK	16QAM
Middle CH	1.32	1.16	-	-	-	-	-	-	-	-	-	-

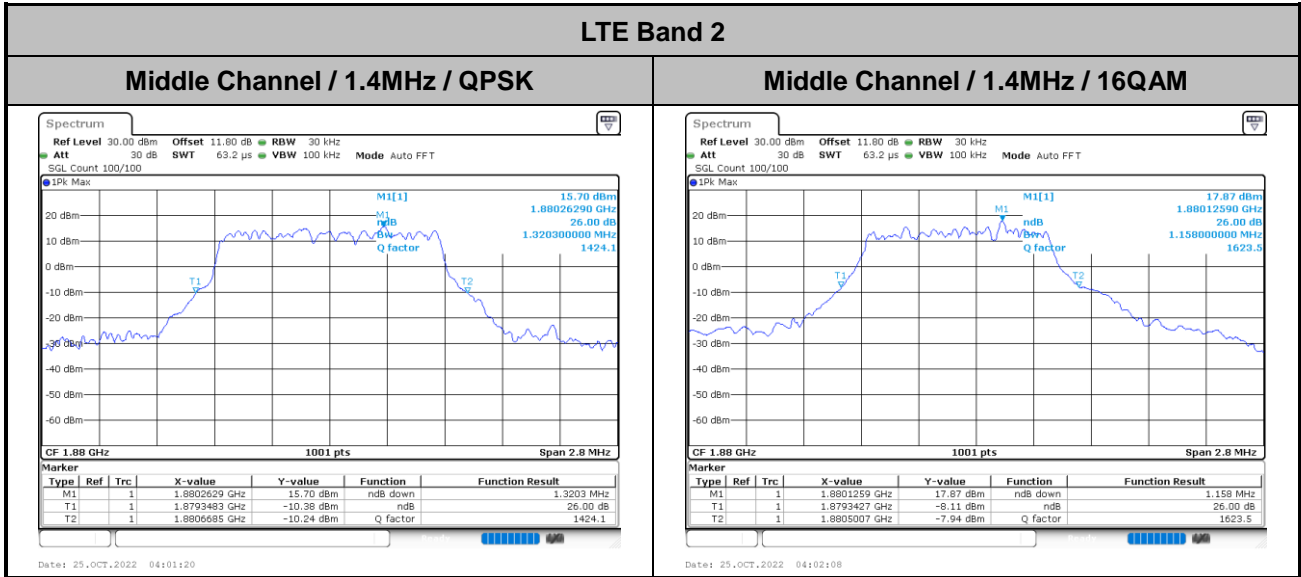



Occupied Bandwidth

Mode	LTE Band 2 : 99%OBW(MHz)											
	1.4MHz		3MHz		5MHz		10MHz		15MHz		20MHz	
Mod.	QPSK	16QAM	QPSK	16QAM	QPSK	16QAM	QPSK	16QAM	QPSK	16QAM	QPSK	16QAM
Middle CH	1.10	0.93	-	-	-	-	-	-	-	-	-	-

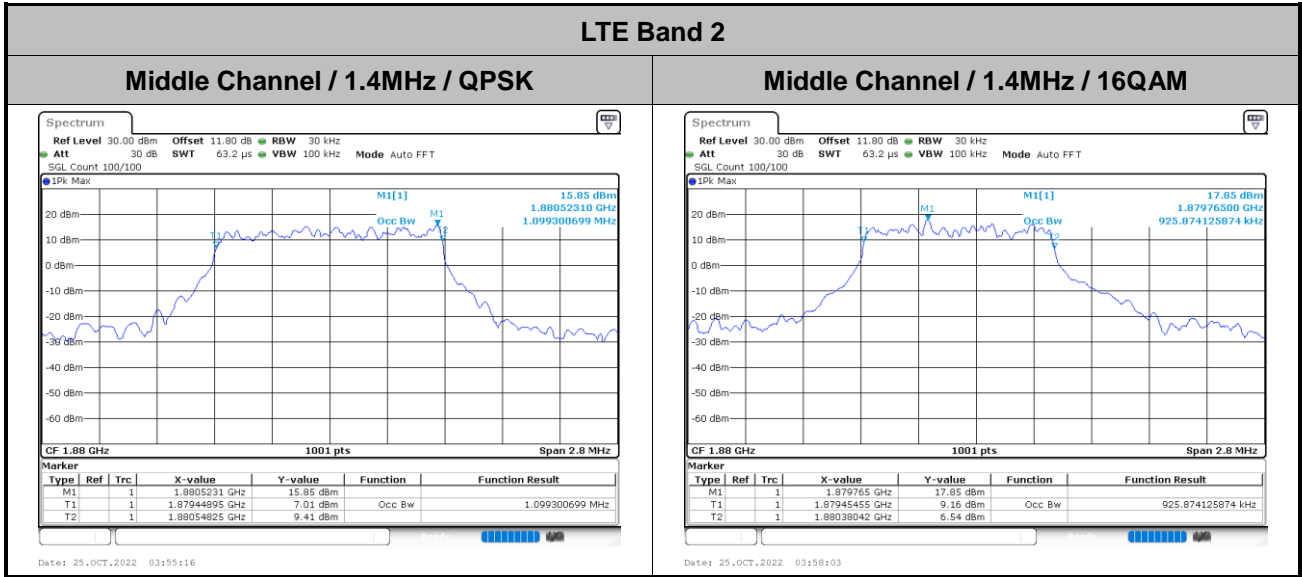



Conducted Band Edge

LTE Band 2 / 1.4MHz / QPSK

Lowest Band Edge / 1RB

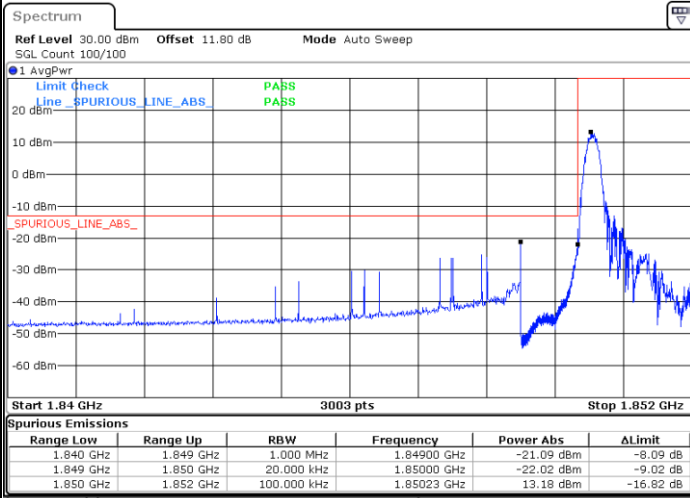

Date: 25.OCT.2022 04:04:35

Highest Band Edge / 1RB

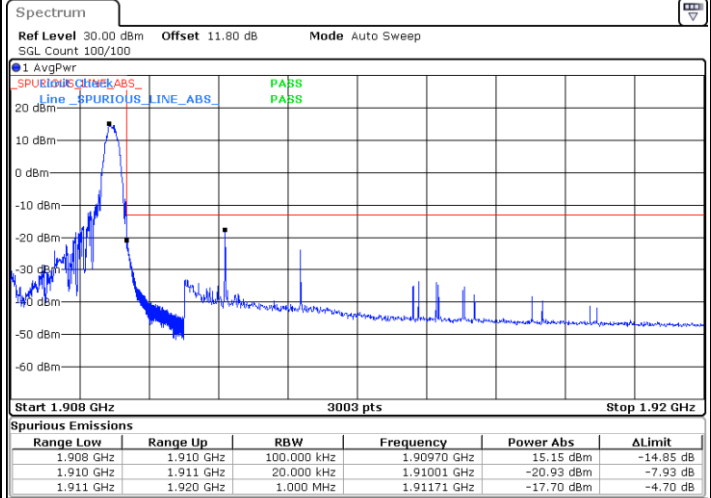

Date: 25.OCT.2022 04:14:37

Lowest Band Edge / Full RB

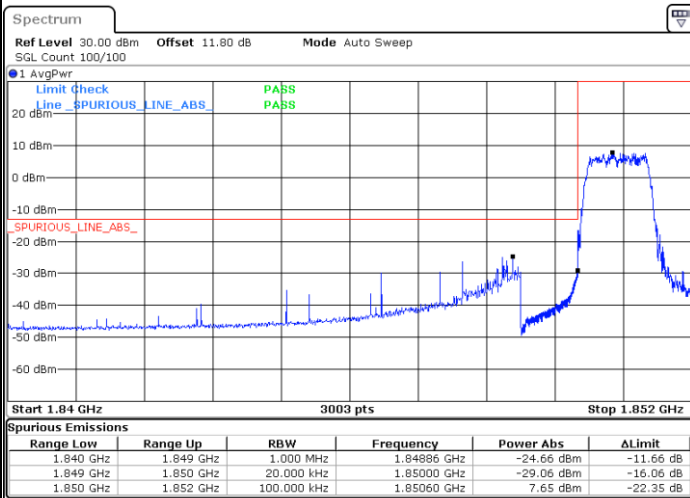

Date: 25.OCT.2022 04:06:49

Highest Band Edge / Full RB

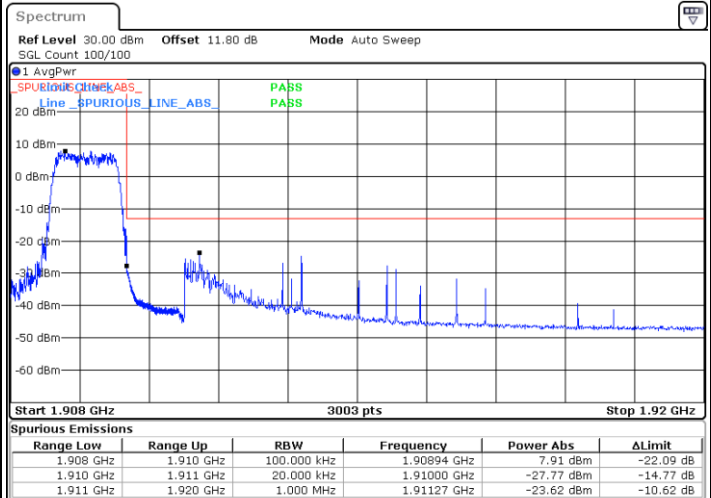

Date: 25.OCT.2022 04:16:08



LTE Band 2 / 1.4MHz / 16QAM

Lowest Band Edge / 1 RB

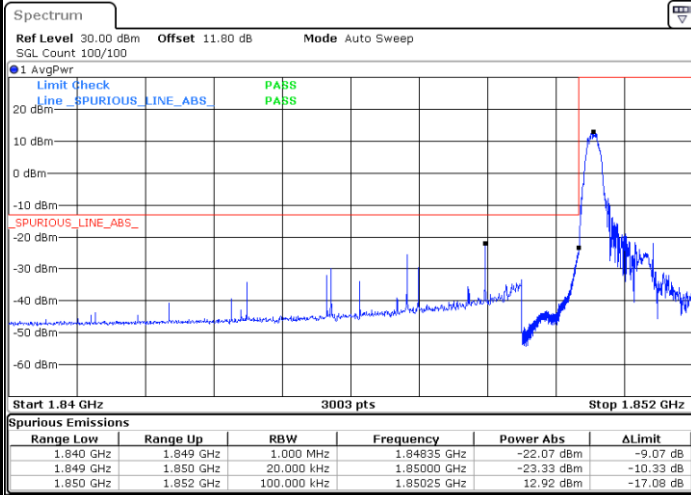

Date: 25.OCT.2022 04:20:41

Highest Band Edge / 1 RB

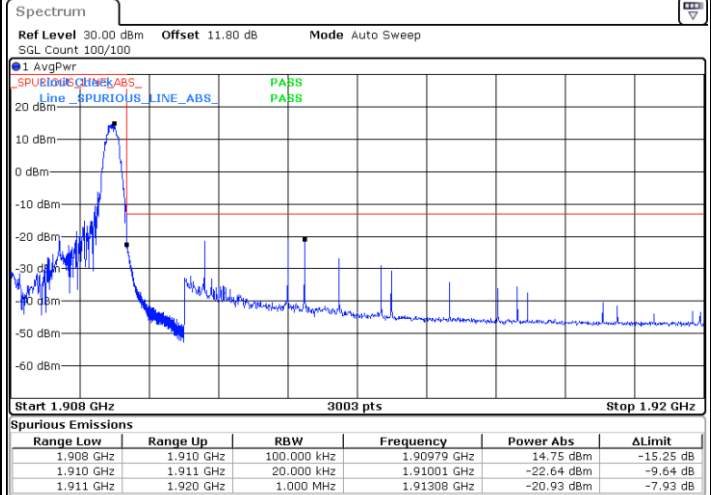

Date: 25.OCT.2022 04:26:54

Lowest Band Edge / Full RB

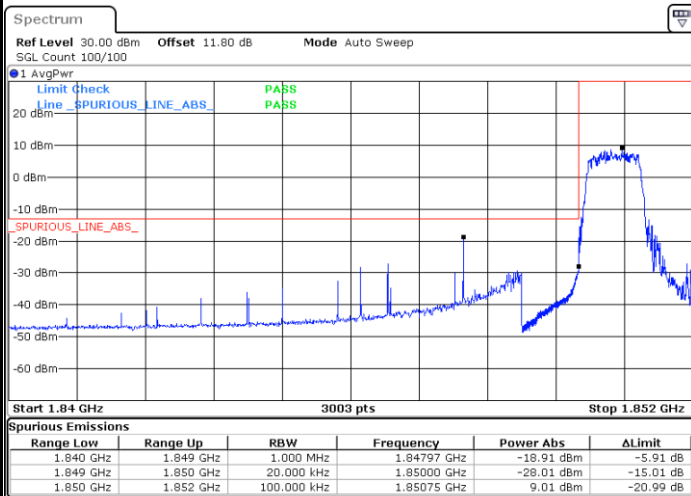

Date: 25.OCT.2022 04:24:27

Highest Band Edge / Full RB

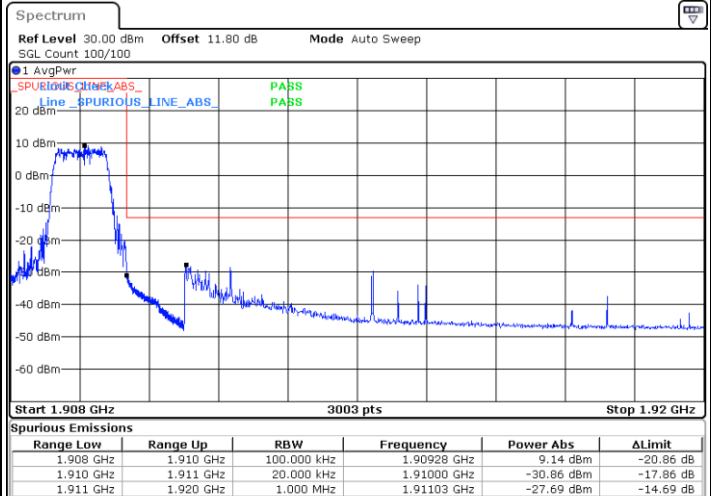

Date: 25.OCT.2022 04:28:39



Conducted Spurious Emission

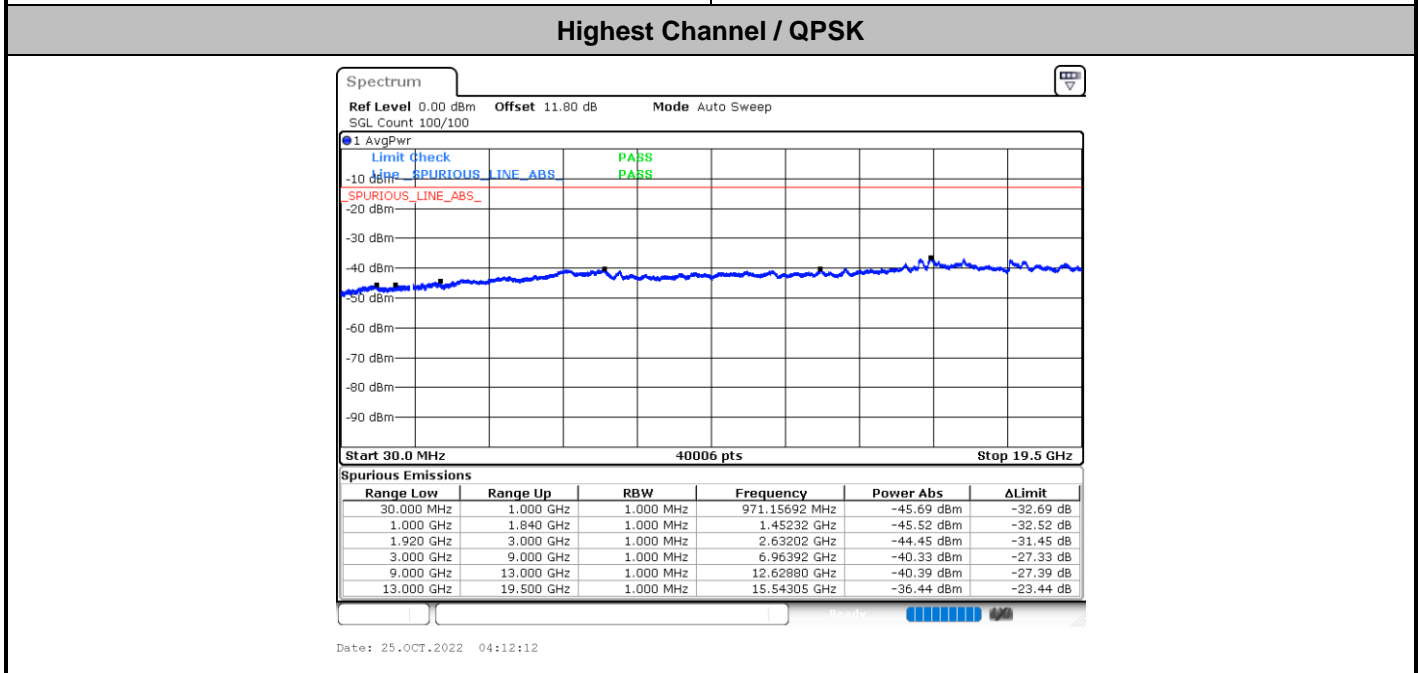
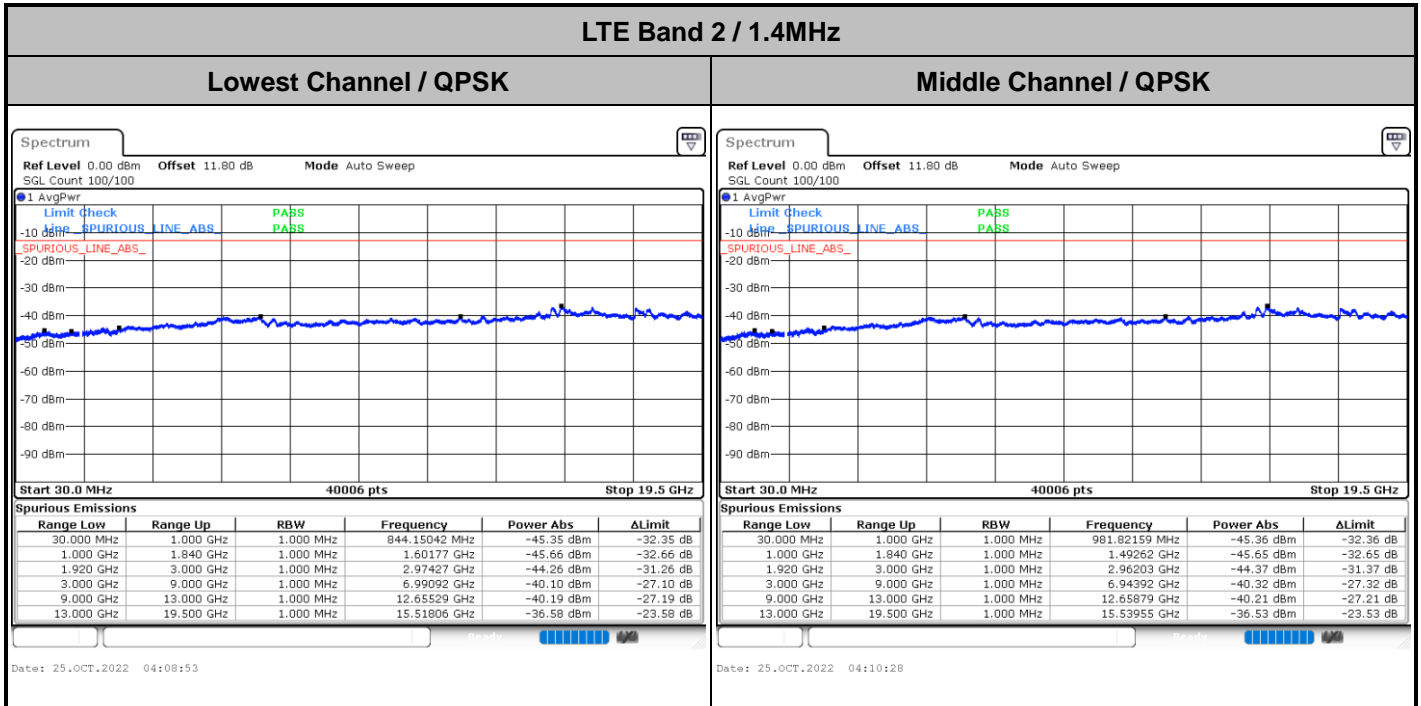



Frequency Stability

Test Conditions		LTE Band 2 (QPSK) / Middle Channel	Limit
Temperature (°C)	Voltage (Volt)	BW 1.4MHz	Note 2.
		Deviation (ppm)	Result
50	Normal Voltage	0.0083	PASS
40	Normal Voltage	0.0070	
30	Normal Voltage	0.0071	
20(Ref.)	Normal Voltage	0.0000	
10	Normal Voltage	0.0083	
0	Normal Voltage	0.0073	
-10	Normal Voltage	0.0089	
-20	Normal Voltage	0.0063	
-30	Normal Voltage	0.0006	
20	Maximum Voltage	0.0077	
20	Normal Voltage	0.0000	
20	Battery End Point	0.0064	

Note:

1. Normal Voltage = 5.0 V. ; Battery End Point (BEP) = 4.75 V. ; Maximum Voltage = 5.25 V.
2. The frequency fundamental emissions stay within the authorized frequency block.



LTE Band 4

Peak-to-Average Ratio

Mode	LTE Band 4 / 1.4MHz				
Mod.	QPSK	16QAM	64QAM	256QAM	Limit: 13dB
RB Size	Full RB	Full RB	Full RB	Full RB	Result
Middle CH	6.43	6.78	-	-	PASS

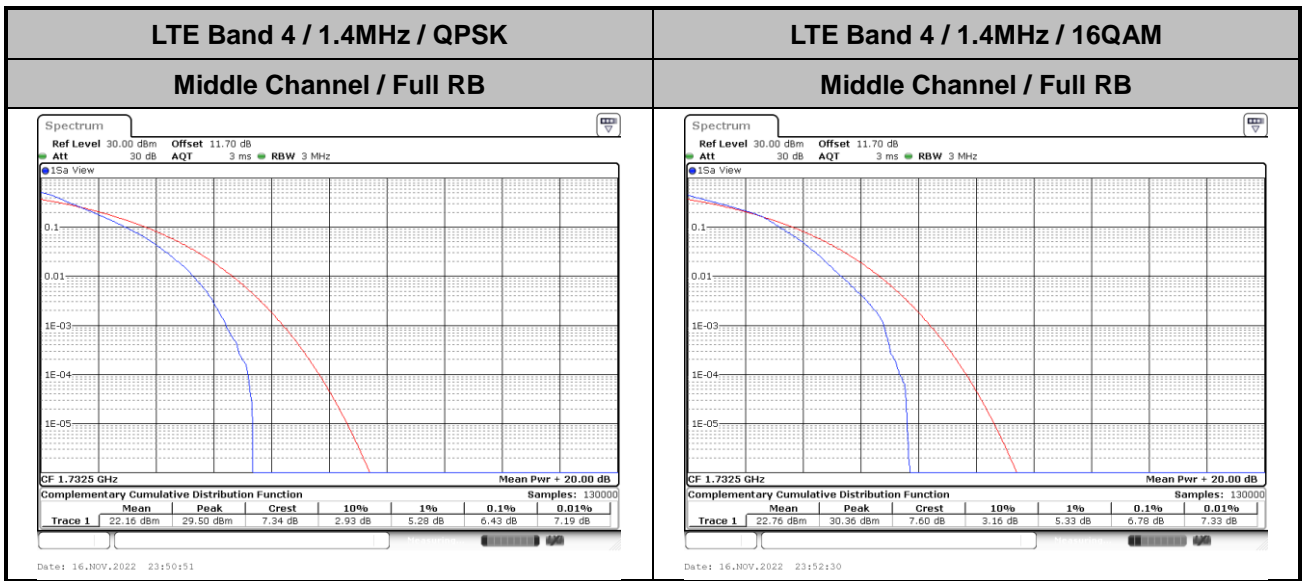



26dB Bandwidth

Mode	LTE Band 4 : 26dB BW(MHz)											
	1.4MHz		3MHz		5MHz		10MHz		15MHz		20MHz	
Mod.	QPSK	16QAM	QPSK	16QAM	QPSK	16QAM	QPSK	16QAM	QPSK	16QAM	QPSK	16QAM
Middle CH	1.37	1.02	-	-	-	-	-	-	-	-	-	-

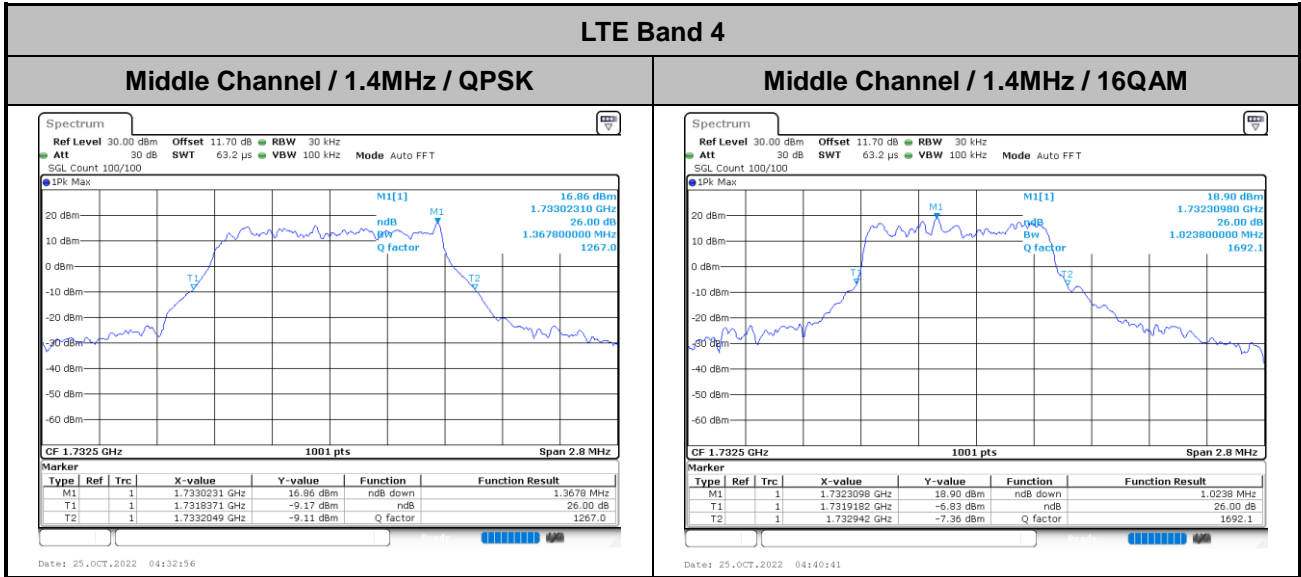



Occupied Bandwidth

Mode	LTE Band 4 : 99%OBW(MHz)											
	1.4MHz		3MHz		5MHz		10MHz		15MHz		20MHz	
Mod.	QPSK	16QAM	QPSK	16QAM	QPSK	16QAM	QPSK	16QAM	QPSK	16QAM	QPSK	16QAM
Middle CH	1.11	0.92	-	-	-	-	-	-	-	-	-	-

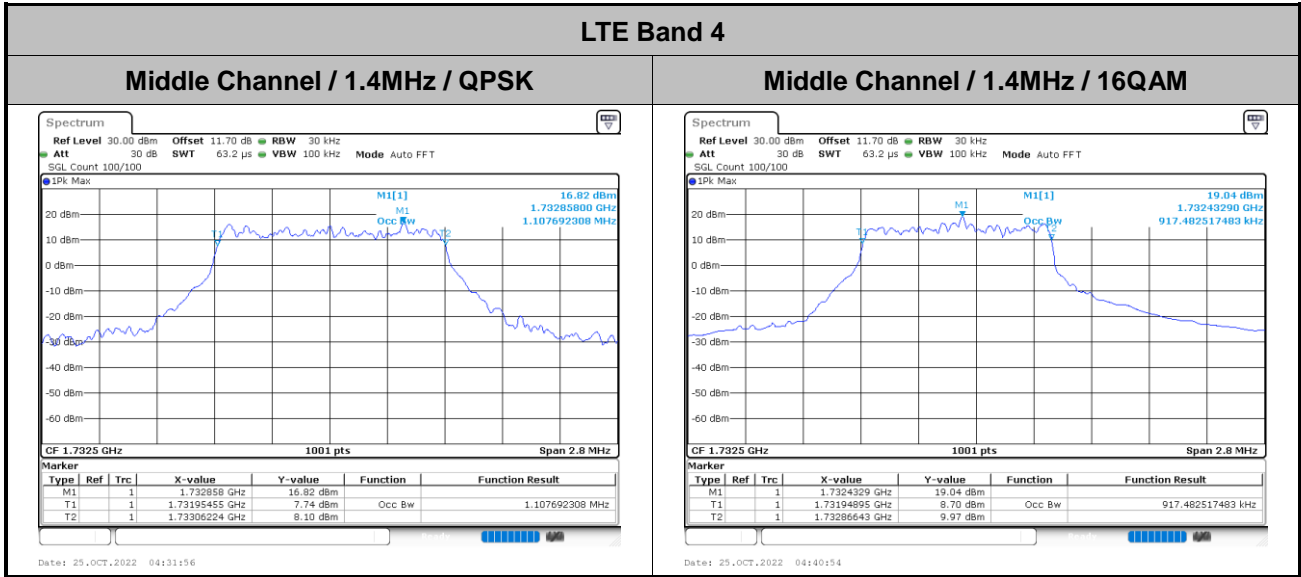



Conducted Band Edge

LTE Band 4 / 1.4MHz / QPSK

Lowest Band Edge / 1RB

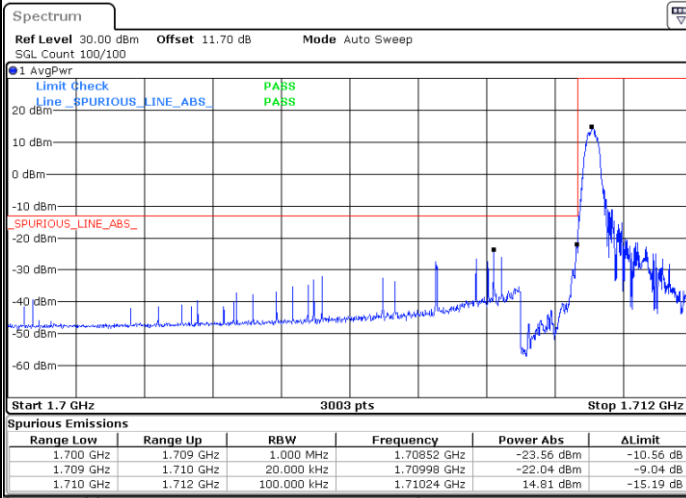

Date: 26.OCT.2022 04:38:14

Highest Band Edge / 1RB

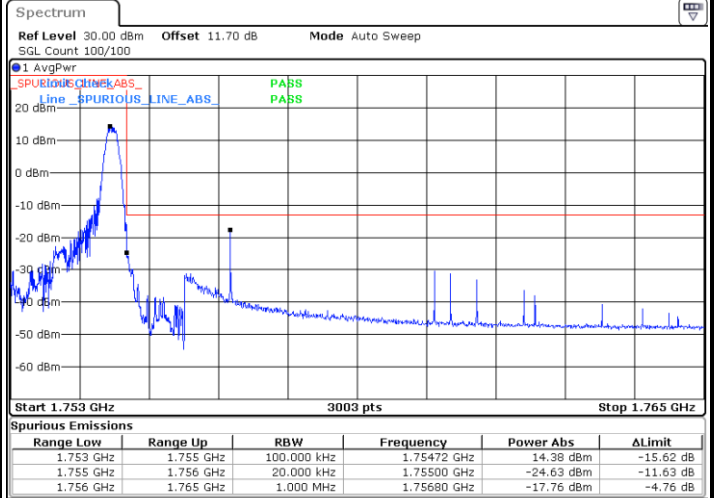

Date: 26.OCT.2022 04:53:59

Lowest Band Edge / Full RB

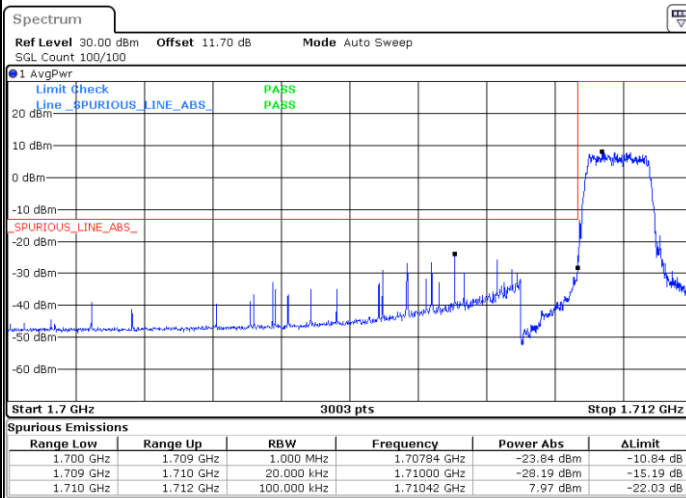

Date: 26.OCT.2022 04:37:13

Highest Band Edge / Full RB

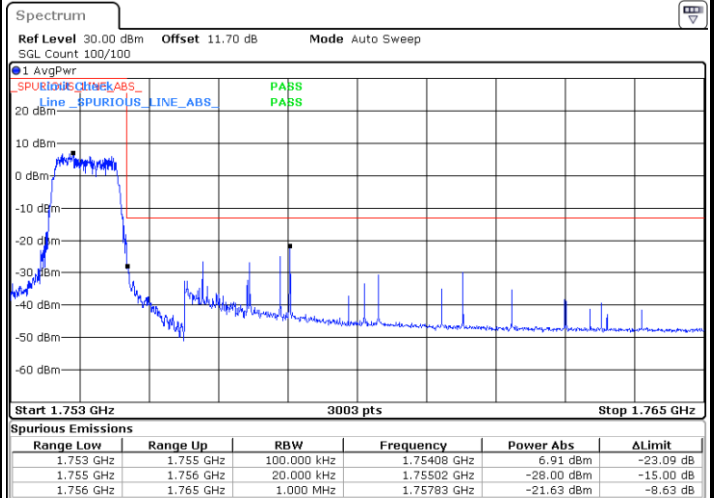

Date: 26.OCT.2022 04:52:30



LTE Band 4 / 1.4MHz / 16QAM

Lowest Band Edge / 1 RB

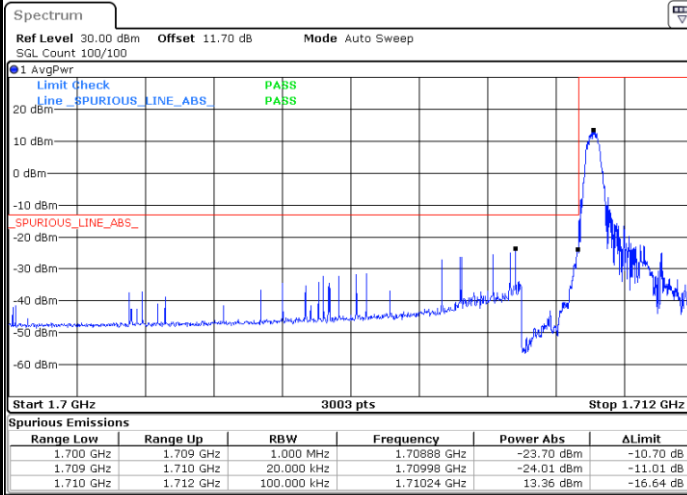

Date: 26.OCT.2022 04:38:46

Highest Band Edge / 1 RB

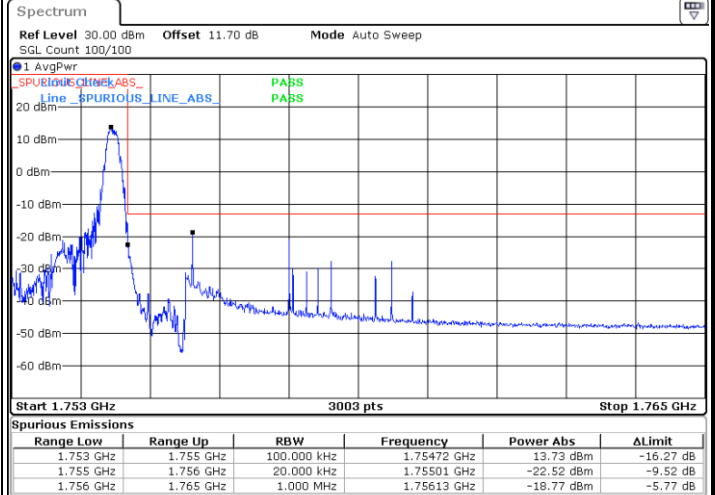

Date: 26.OCT.2022 04:56:04

Lowest Band Edge / Full RB

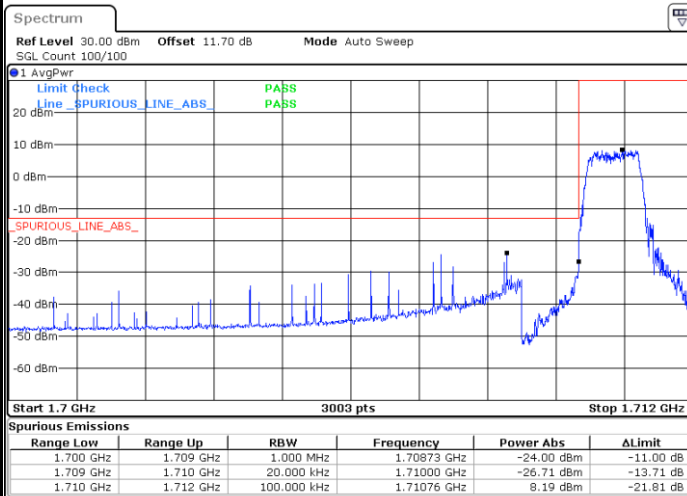

Date: 26.OCT.2022 04:40:12

Highest Band Edge / Full RB



Date: 26.OCT.2022 04:57:22



Conducted Spurious Emission

LTE Band 4 / 1.4MHz

Lowest Channel / QPSK

Middle Channel / QPSK

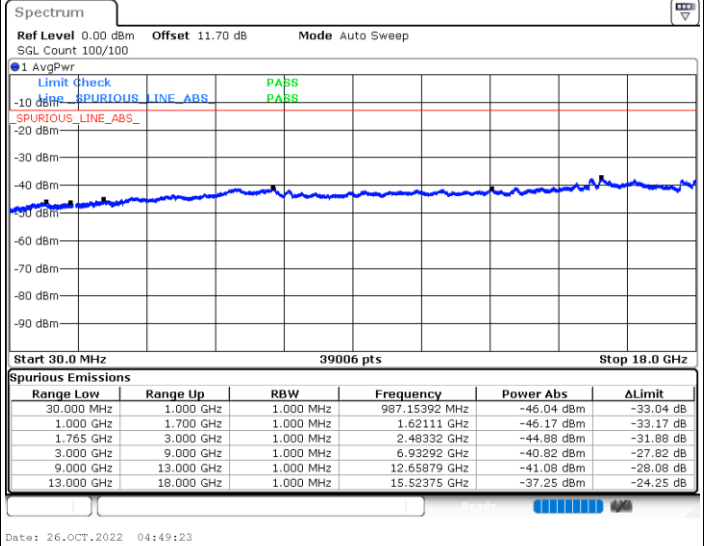
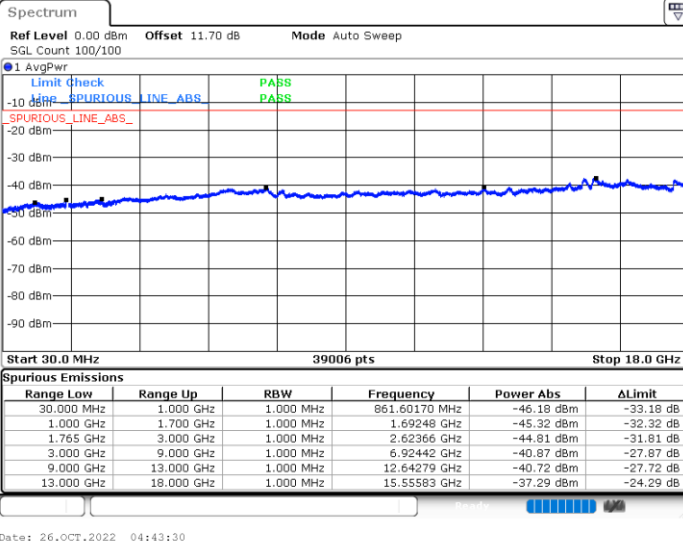

Highest Channel / QPSK

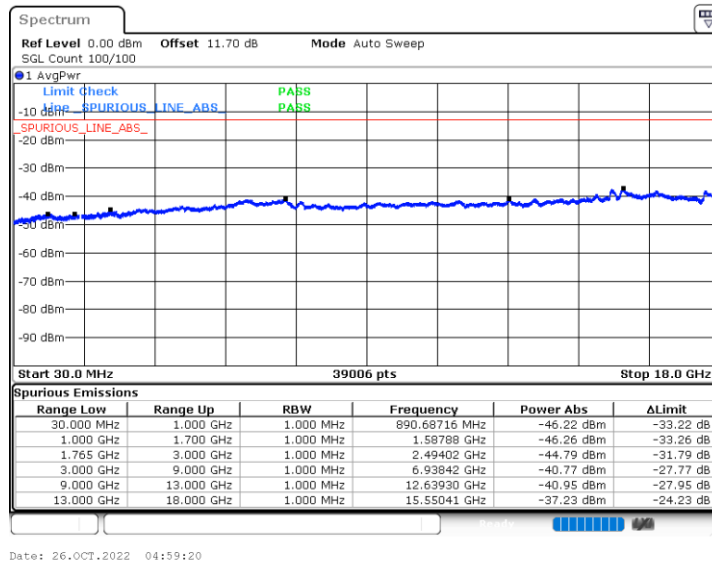



Frequency Stability

Test Conditions		LTE Band 4 (QPSK) / Middle Channel	Limit
Temperature (°C)	Voltage (Volt)	BW 1.4MHz	Note 2.
		Deviation (ppm)	Result
50	Normal Voltage	0.0110	PASS
40	Normal Voltage	0.0094	
30	Normal Voltage	0.0026	
20(Ref.)	Normal Voltage	0.0000	
10	Normal Voltage	0.0110	
0	Normal Voltage	0.0103	
-10	Normal Voltage	0.0012	
-20	Normal Voltage	0.0031	
-30	Normal Voltage	0.0044	
20	Maximum Voltage	0.0045	
20	Normal Voltage	0.0000	
20	Battery End Point	0.0078	

Note:

- 1. Normal Voltage = 5.0 V. ; Battery End Point (BEP) = 4.75 V. ; Maximum Voltage = 5.25 V.
- 2. The frequency fundamental emissions stay within the authorized frequency block.



LTE Band 5

Peak-to-Average Ratio

Mode	LTE Band 5 / 1.4MHz				
Mod.	QPSK	16QAM	64QAM	256QAM	Limit: 13dB
RB Size	Full RB	Full RB	Full RB	Full RB	Result
Middle CH	8.00	6.99	-	-	PASS

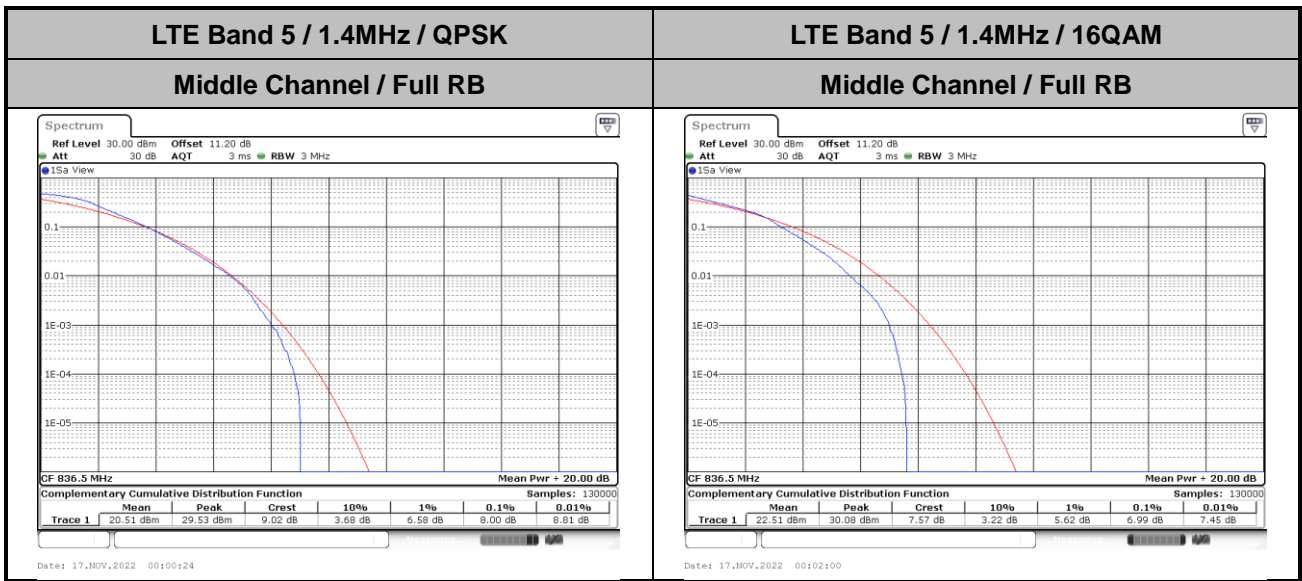



26dB Bandwidth

Mode	LTE Band 5 : 26dB BW(MHz)											
BW	1.4MHz		3MHz		5MHz		10MHz		15MHz		20MHz	
Mod.	QPSK	16QAM	QPSK	16QAM	QPSK	16QAM	QPSK	16QAM	QPSK	16QAM	QPSK	16QAM
Middle CH	1.32	1.20	-	-	-	-	-	-	-	-	-	-

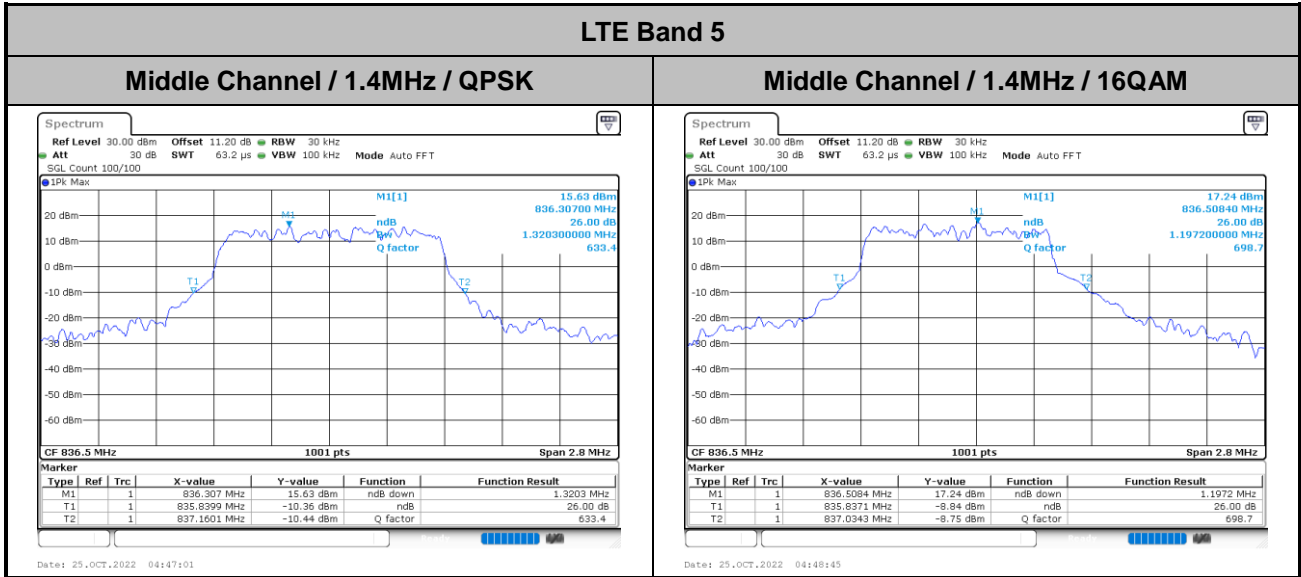



Occupied Bandwidth

Mode	LTE Band 5 : 99%OBW(MHz)											
	1.4MHz		3MHz		5MHz		10MHz		15MHz		20MHz	
Mod.	QPSK	16QAM	QPSK	16QAM	QPSK	16QAM	QPSK	16QAM	QPSK	16QAM	QPSK	16QAM
Middle CH	1.08	0.93	-	-	-	-	-	-	-	-	-	-

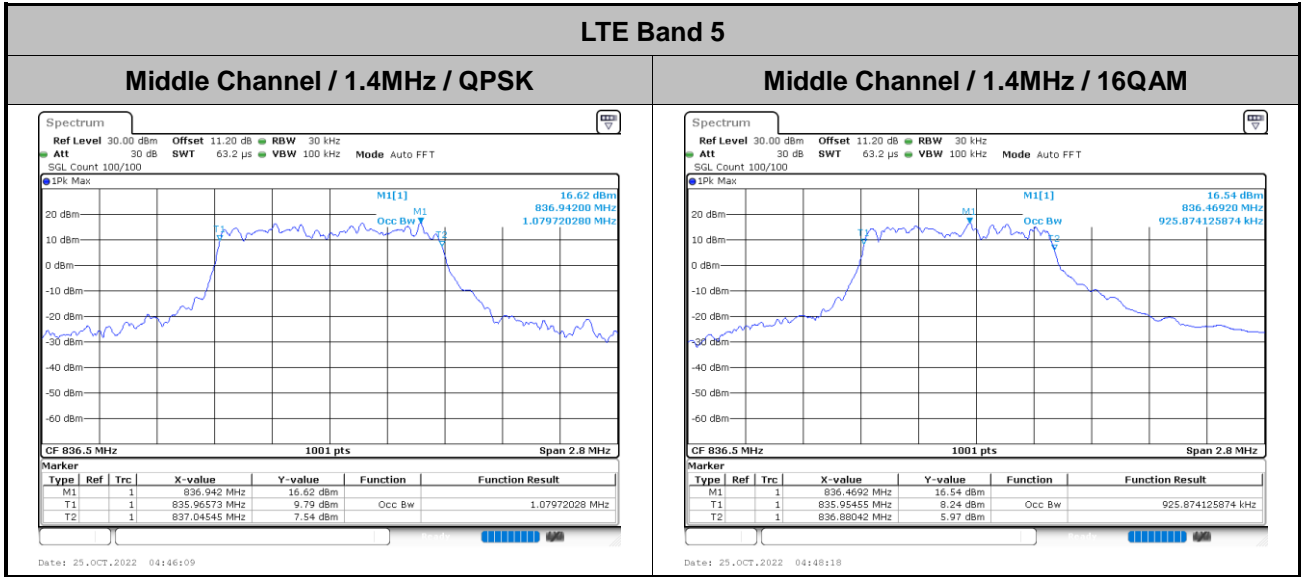



Conducted Band Edge

LTE Band 5 / 1.4MHz / QPSK

Lowest Band Edge / 1RB



Date: 26.OCT.2022 05:05:22

Highest Band Edge / 1RB

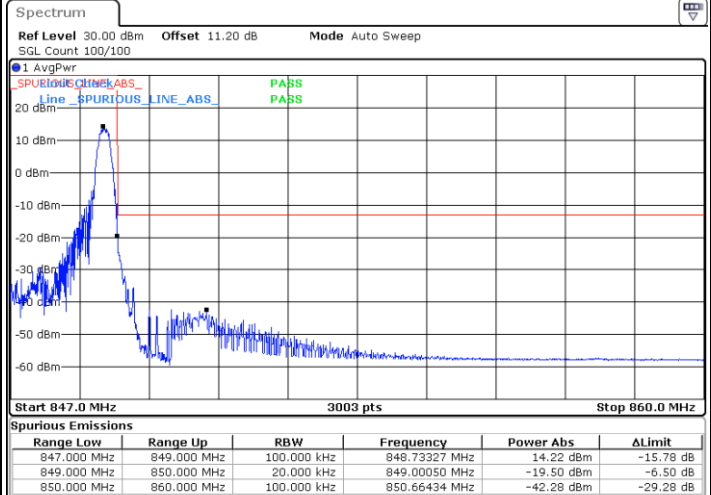

Date: 26.OCT.2022 05:17:08

Lowest Band Edge / Full RB

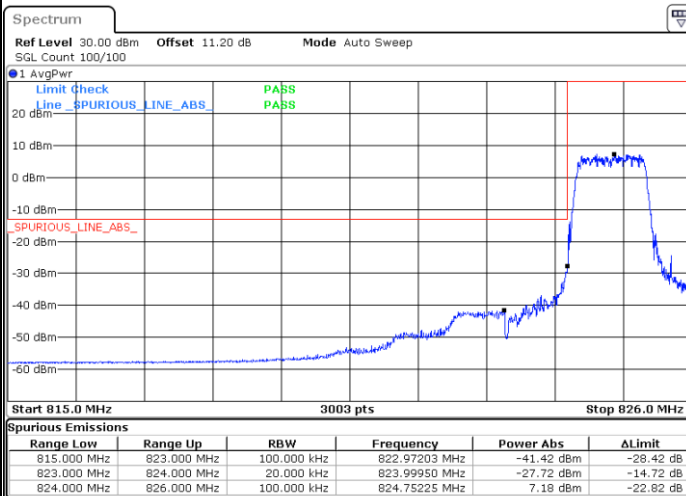

Date: 26.OCT.2022 05:03:39

Highest Band Edge / Full RB

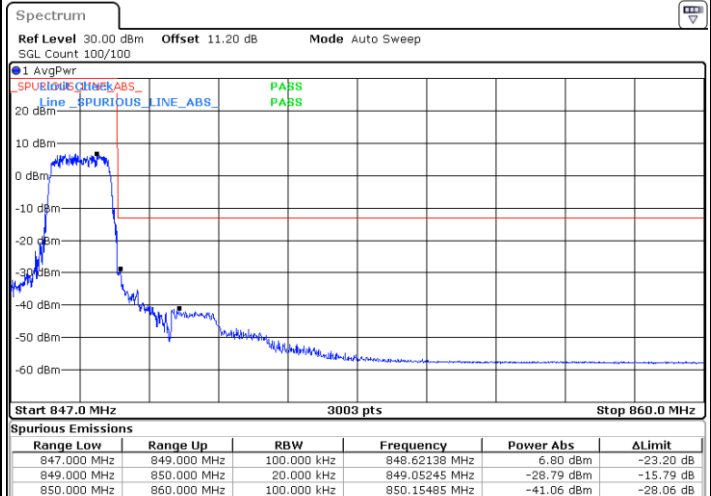

Date: 26.OCT.2022 05:15:38



LTE Band 5 / 1.4MHz / 16QAM

Lowest Band Edge / 1 RB

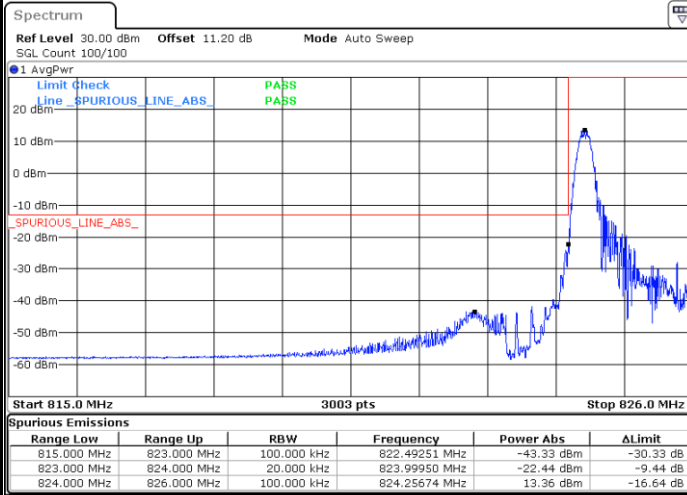

Date: 26.OCT.2022 05:10:40

Highest Band Edge / 1 RB

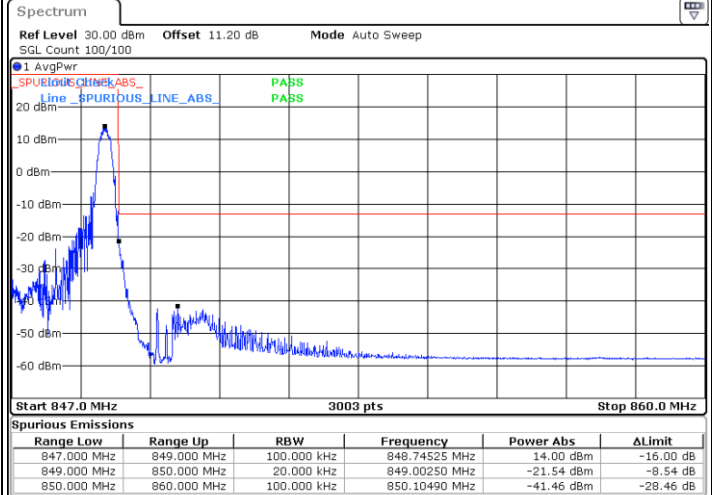

Date: 26.OCT.2022 05:19:27

Lowest Band Edge / Full RB

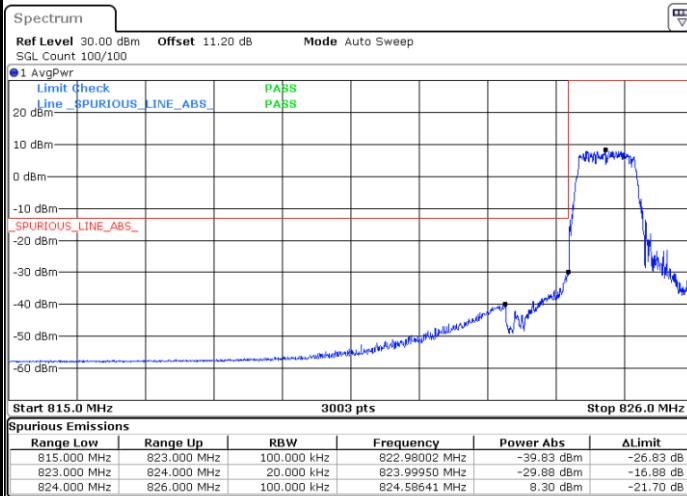

Date: 26.OCT.2022 05:11:52

Highest Band Edge / Full RB

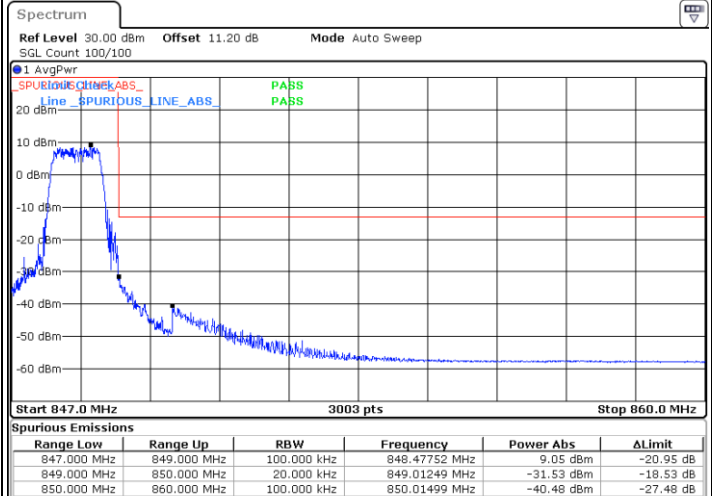

Date: 26.OCT.2022 05:20:37



Conducted Spurious Emission

LTE Band 5 / 1.4MHz

Lowest Channel / QPSK

Middle Channel / QPSK

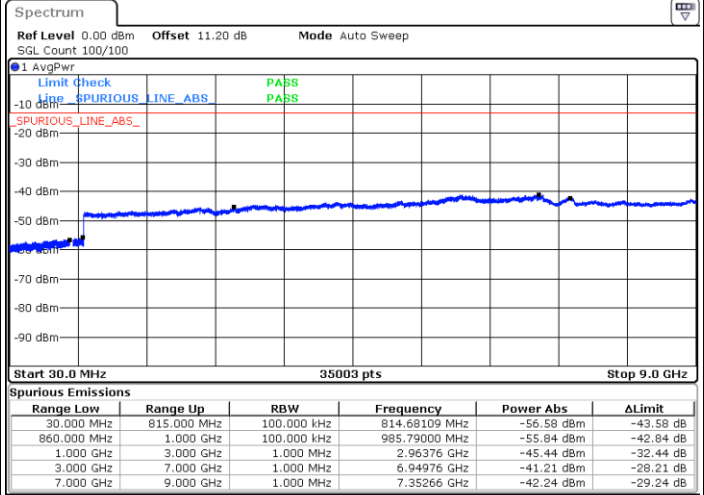
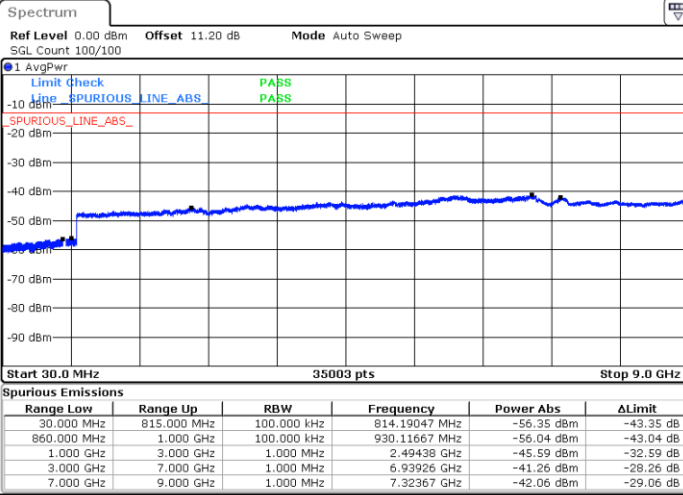

Date: 26.OCT.2022 05:09:14

Date: 26.OCT.2022 05:13:39

Highest Channel / QPSK

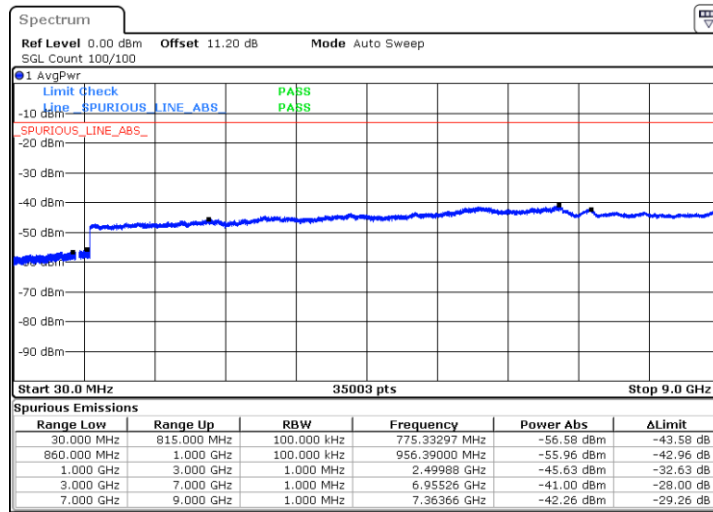

Date: 26.OCT.2022 05:22:27



Frequency Stability

Test Conditions		LTE Band 5 (QPSK) / Middle Channel	Limit
Temperature (°C)	Voltage (Volt)	BW 1.4MHz	Note 2.
		Deviation (ppm)	Result
50	Normal Voltage	0.0061	PASS
40	Normal Voltage	0.0198	
30	Normal Voltage	0.0022	
20(Ref.)	Normal Voltage	0.0000	
10	Normal Voltage	0.0061	
0	Normal Voltage	0.0014	
-10	Normal Voltage	0.0177	
-20	Normal Voltage	0.0134	
-30	Normal Voltage	0.0002	
20	Maximum Voltage	0.0158	
20	Normal Voltage	0.0000	
20	Battery End Point	0.0001	

Note:

- 1. Normal Voltage = 5.0 V. ; Battery End Point (BEP) = 4.75 V. ; Maximum Voltage = 5.25 V.
- 2. The frequency fundamental emissions stay within the authorized frequency block.



LTE Band 12

Peak-to-Average Ratio

Mode	LTE Band 12 / 1.4MHz				
Mod.	QPSK	16QAM	64QAM	256QAM	Limit: 13dB
RB Size	Full RB	Full RB	Full RB	Full RB	Result
Middle CH	7.88	7.88	-	-	PASS

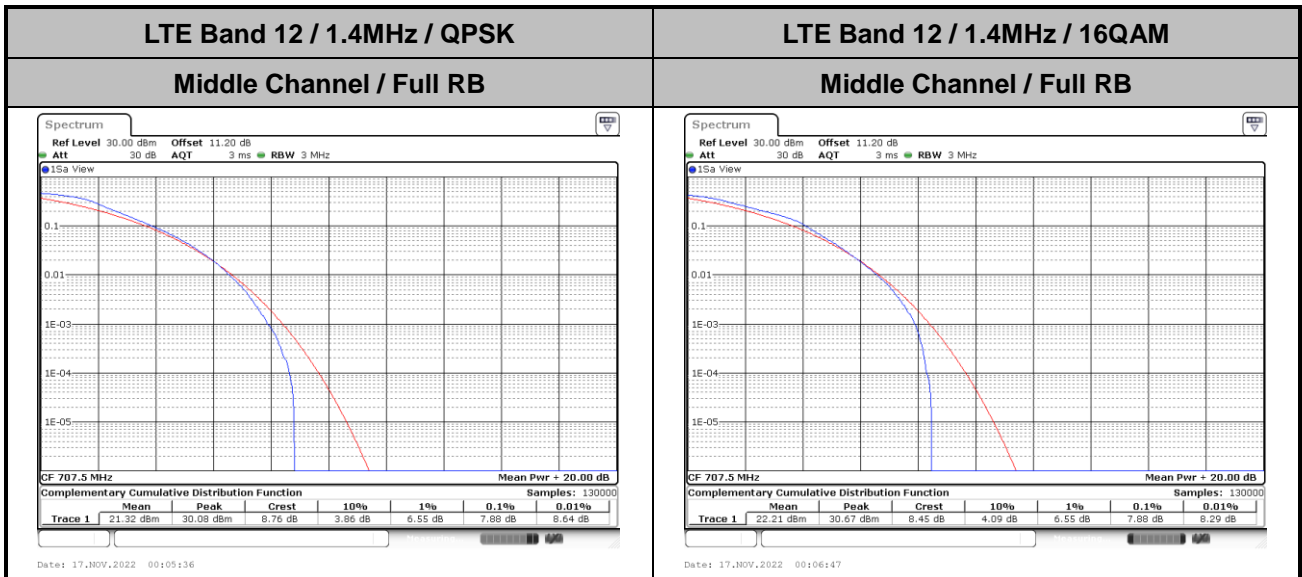



26dB Bandwidth

Mode	LTE Band 12 : 26dB BW(MHz)											
	1.4MHz		3MHz		5MHz		10MHz		15MHz		20MHz	
Mod.	QPSK	16QAM	QPSK	16QAM	QPSK	16QAM	QPSK	16QAM	QPSK	16QAM	QPSK	16QAM
Middle CH	1.33	1.24	-	-	-	-	-	-	-	-	-	-

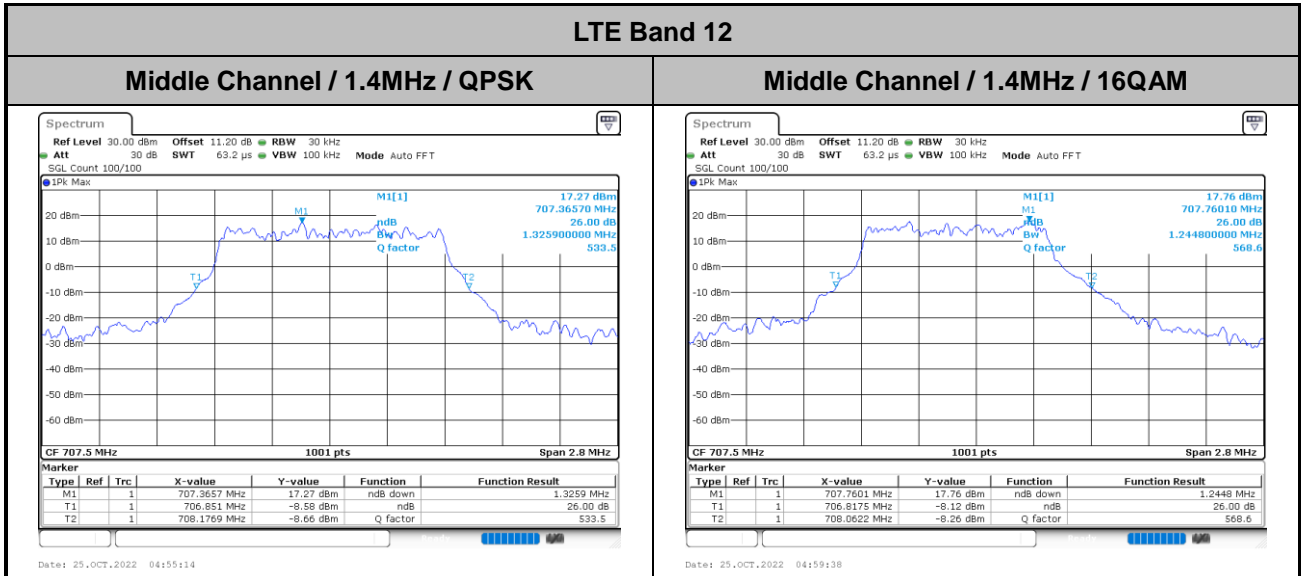



Occupied Bandwidth

Mode	LTE Band 12 : 99%OBW(MHz)											
	1.4MHz		3MHz		5MHz		10MHz		15MHz		20MHz	
Mod.	QPSK	16QAM	QPSK	16QAM	QPSK	16QAM	QPSK	16QAM	QPSK	16QAM	QPSK	16QAM
Middle CH	1.10	0.95	-	-	-	-	-	-	-	-	-	-

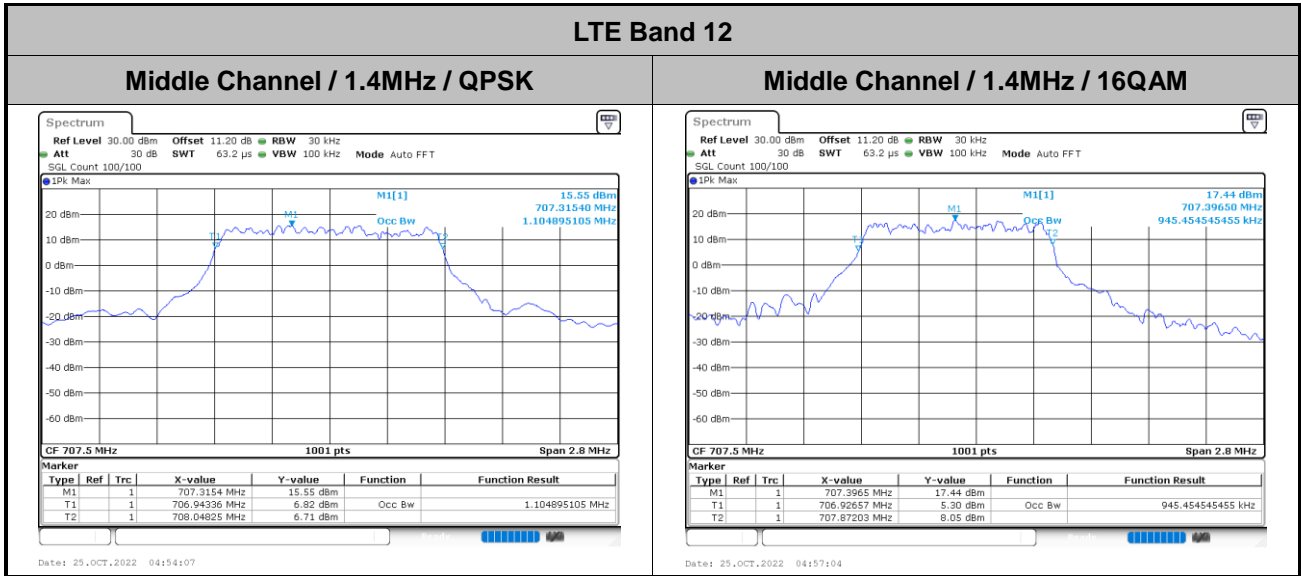



Conducted Band Edge

LTE Band 12 / 1.4MHz / QPSK

Lowest Band Edge / 1RB

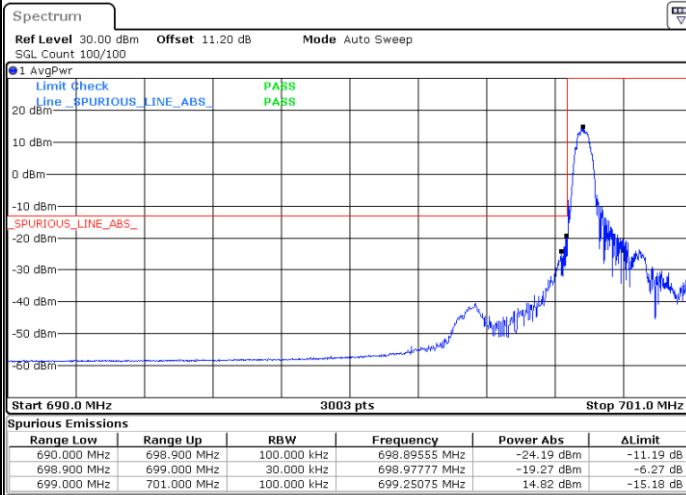

Date: 26.OCT.2022 05:30:46

Highest Band Edge / 1RB

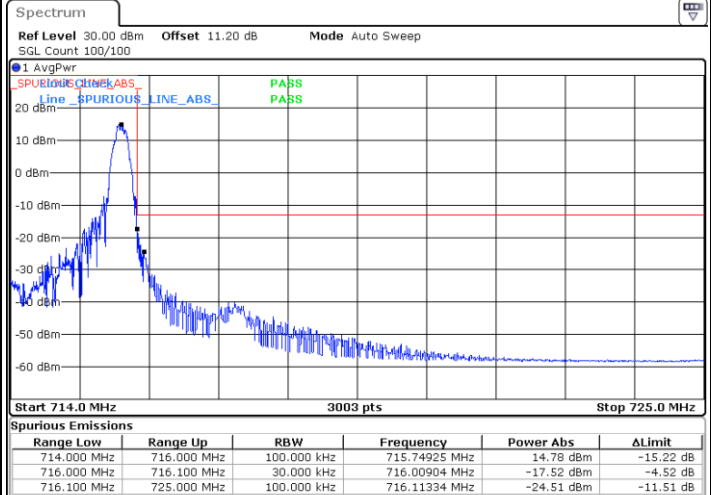

Date: 26.OCT.2022 05:39:10

Lowest Band Edge / Full RB

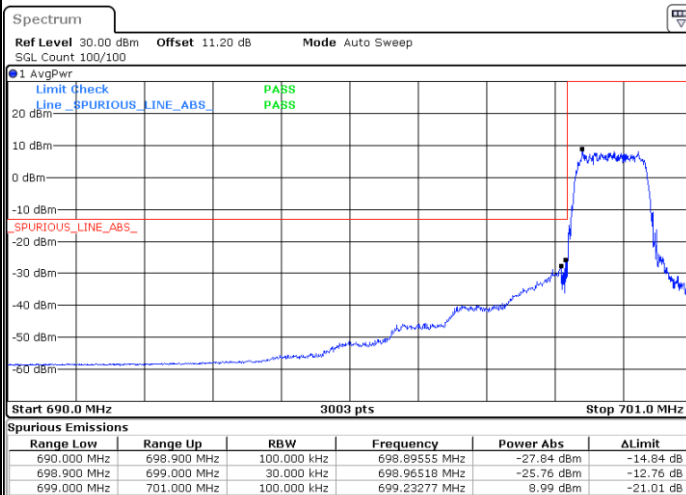

Date: 26.OCT.2022 05:28:26

Highest Band Edge / Full RB



Date: 26.OCT.2022 05:37:05



LTE Band 12 / 1.4MHz / 16QAM

Lowest Band Edge / 1 RB

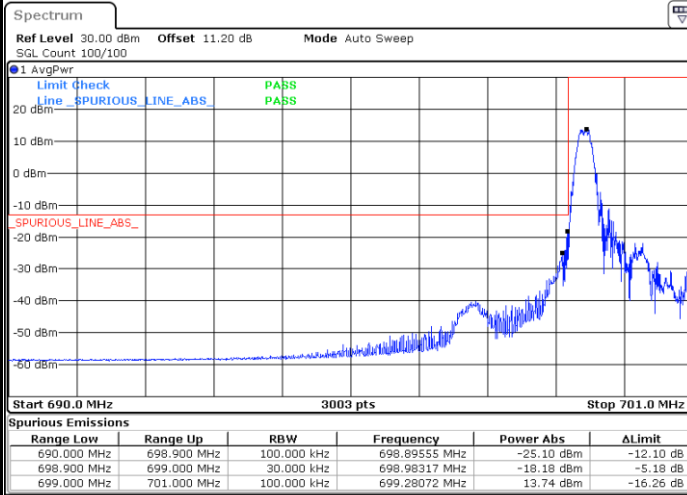

Date: 26.OCT.2022 05:33:06

Highest Band Edge / 1 RB

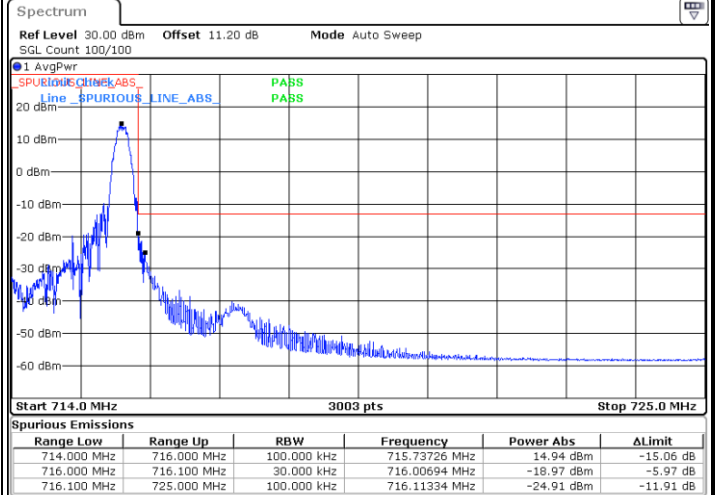

Date: 26.OCT.2022 05:40:30

Lowest Band Edge / Full RB

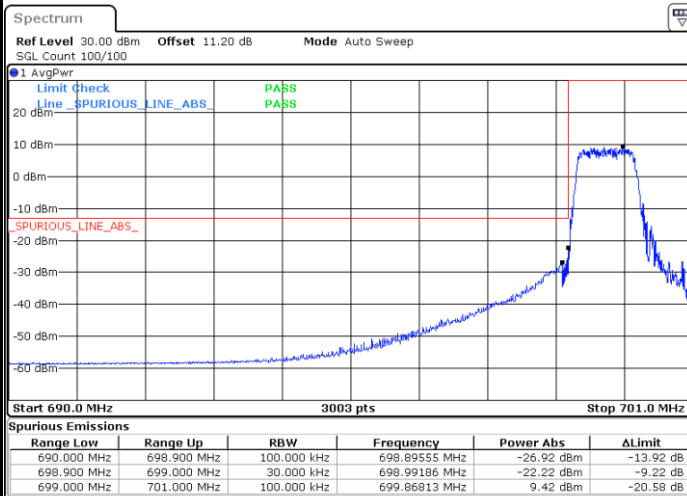

Date: 26.OCT.2022 05:33:57

Highest Band Edge / Full RB

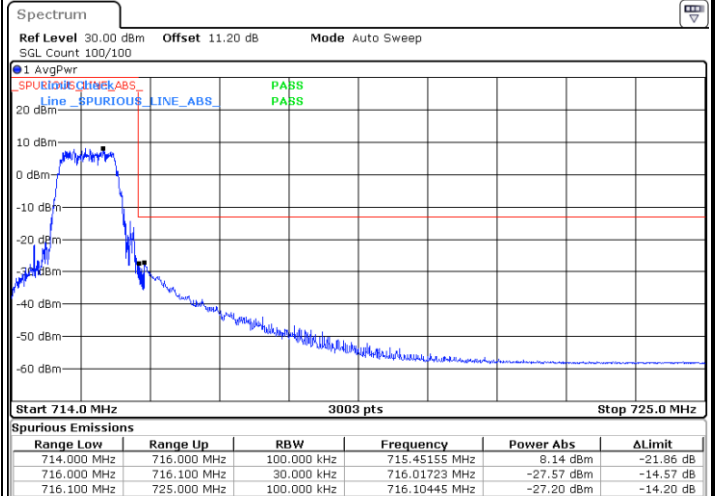

Date: 26.OCT.2022 05:41:17



Conducted Spurious Emission

LTE Band 12 / 1.4MHz

Lowest Channel / QPSK

Middle Channel / QPSK

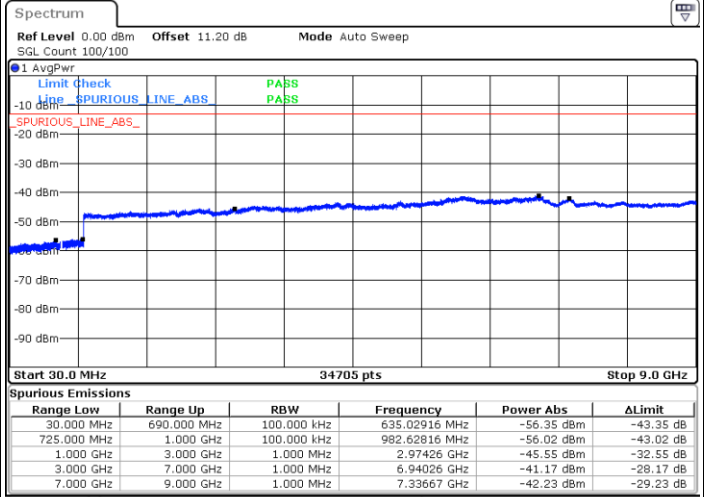
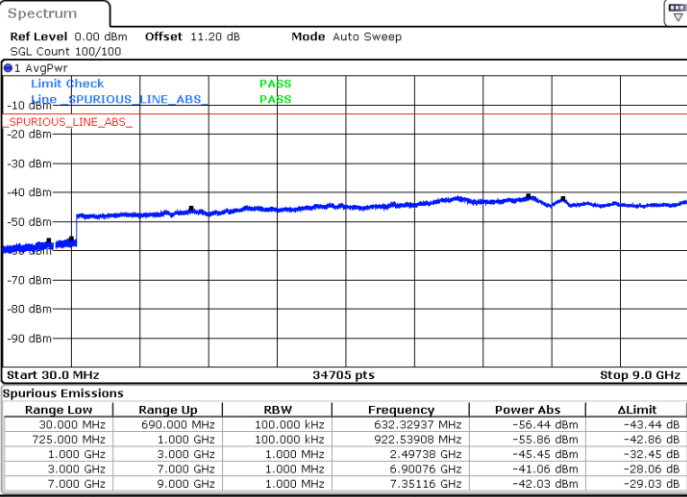

Date: 26.OCT.2022 05:32:00

Date: 26.OCT.2022 05:35:44

Highest Channel / QPSK

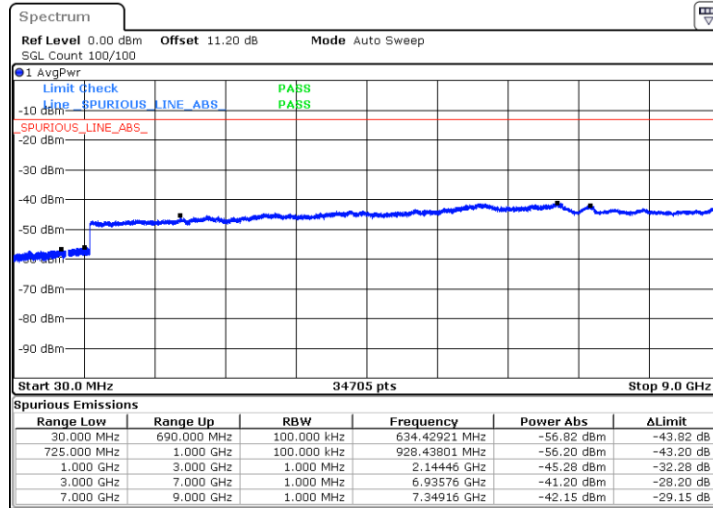

Date: 26.OCT.2022 05:42:59



Frequency Stability

Test Conditions		LTE Band 12 (QPSK) / Middle Channel	Limit
Temperature (°C)	Voltage (Volt)	BW 1.4MHz	Note 2.
		Deviation (ppm)	Result
50	Normal Voltage	0.0007	PASS
40	Normal Voltage	0.0216	
30	Normal Voltage	0.0229	
20(Ref.)	Normal Voltage	0.0000	
10	Normal Voltage	0.0007	
0	Normal Voltage	0.0181	
-10	Normal Voltage	0.0191	
-20	Normal Voltage	0.0229	
-30	Normal Voltage	0.0199	
20	Maximum Voltage	0.0033	
20	Normal Voltage	0.0000	
20	Battery End Point	0.0037	

Note:

1. Normal Voltage = 5.0 V. ; Battery End Point (BEP) = 4.75 V. ; Maximum Voltage = 5.25 V.
2. The frequency fundamental emissions stay within the authorized frequency block.



LTE Band 13

Peak-to-Average Ratio

Mode	LTE Band 13 / 5MHz				
Mod.	QPSK	16QAM	64QAM	256QAM	Limit: 13dB
RB Size	Full RB	Full RB	Full RB	Full RB	Result
Middle CH	6.64	7.42	-	-	PASS

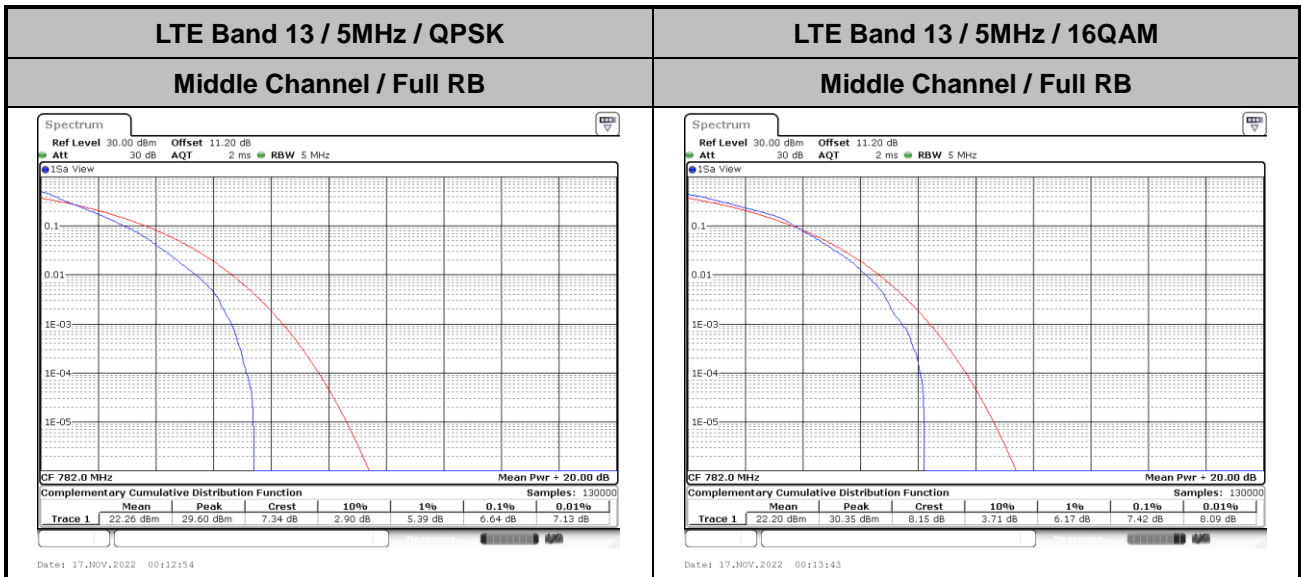



26dB Bandwidth

Mode	LTE Band 13 : 26dB BW(MHz)											
	1.4MHz		3MHz		5MHz		10MHz		15MHz		20MHz	
Mod.	QPSK	16QAM	QPSK	16QAM	QPSK	16QAM	QPSK	16QAM	QPSK	16QAM	QPSK	16QAM
Middle CH	-	-	-	-	1.30	1.15	-	-	-	-	-	-

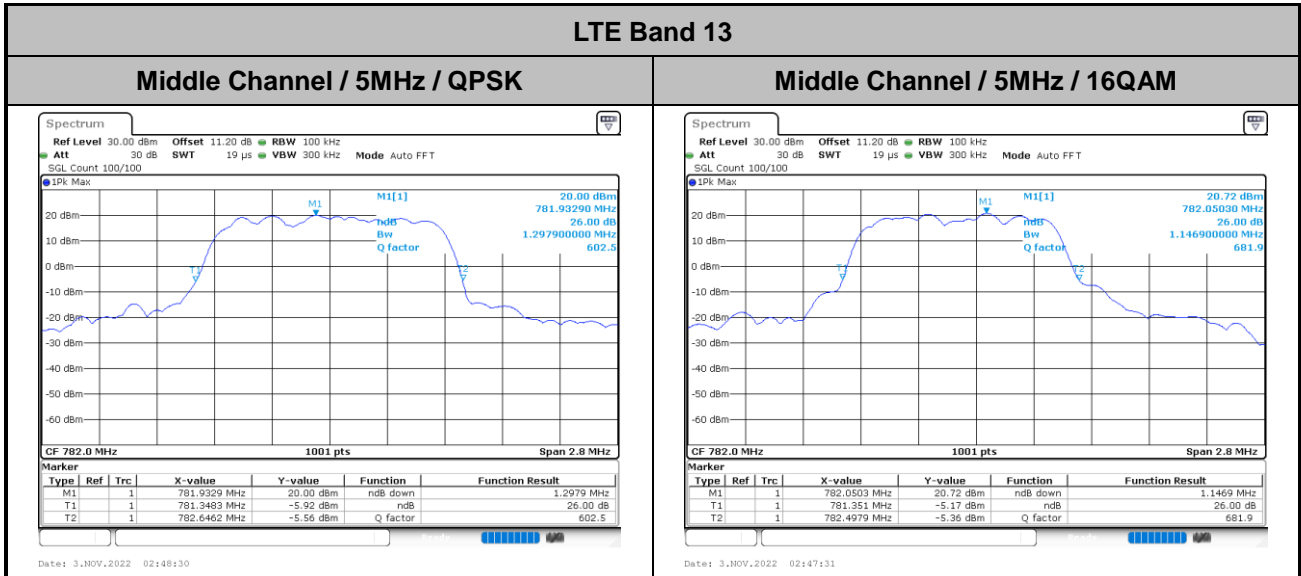



Occupied Bandwidth

Mode	LTE Band 13 : 99%OBW(MHz)											
	1.4MHz		3MHz		5MHz		10MHz		15MHz		20MHz	
Mod.	QPSK	16QAM	QPSK	16QAM	QPSK	16QAM	QPSK	16QAM	QPSK	16QAM	QPSK	16QAM
Middle CH	-	-	-	-	1.14	0.98	-	-	-	-	-	-

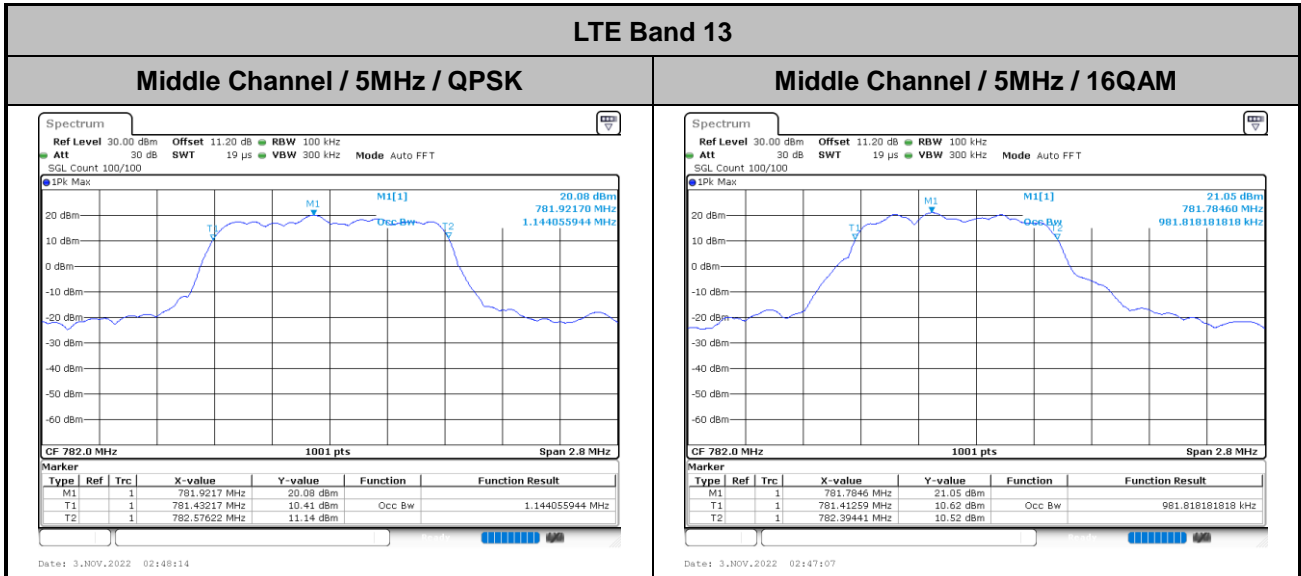



Conducted Band Edge

LTE Band 13 / 5MHz / QPSK

Lowest Band Edge / 1 RB

Highest Band Edge / 1 RB

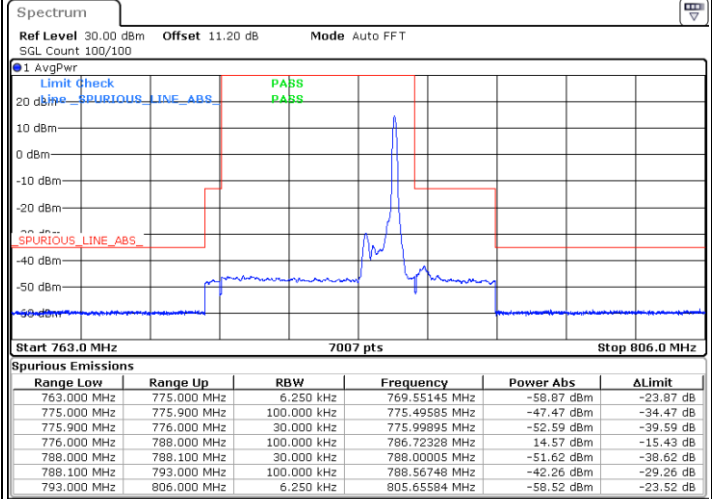
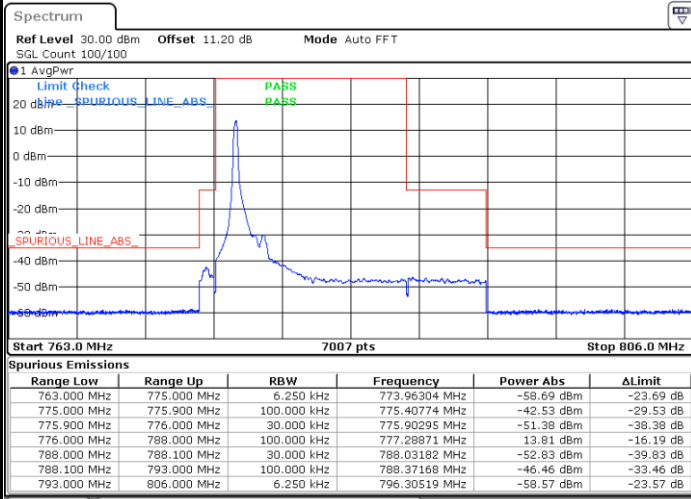

Date: 3.NOV.2022 02:54:19

Date: 3.NOV.2022 03:01:22

Lowest Band Edge / Full RB

Highest Band Edge / Full RB

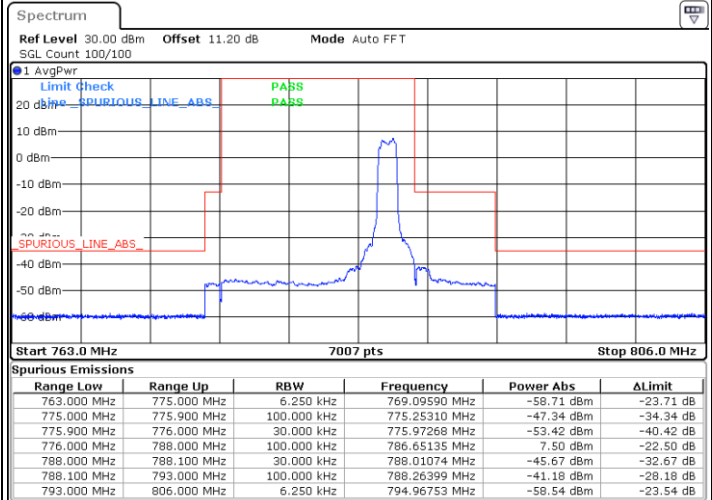
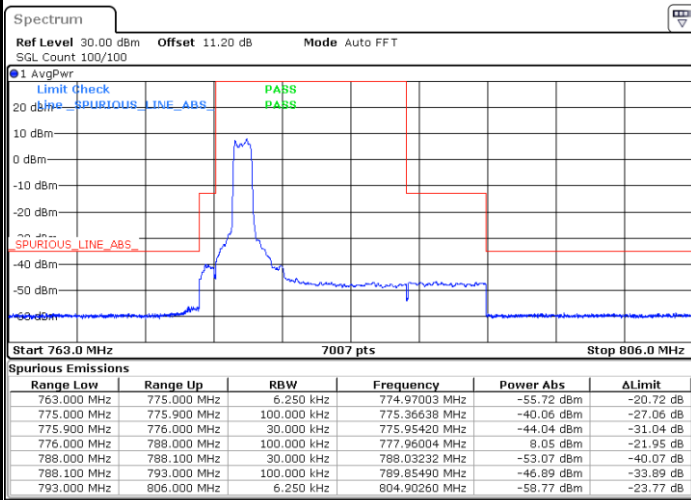

Date: 3.NOV.2022 02:57:25

Date: 3.NOV.2022 03:03:16



LTE Band 13 / 5MHz / 16QAM

Lowest Band Edge / 1 RB

Highest Band Edge / 1 RB

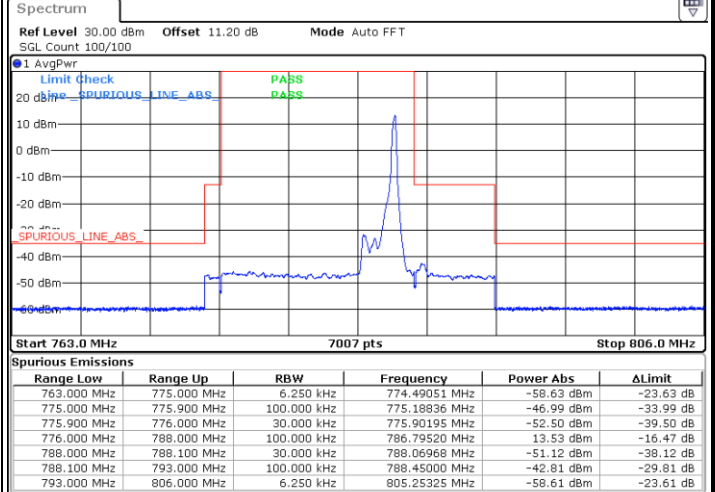
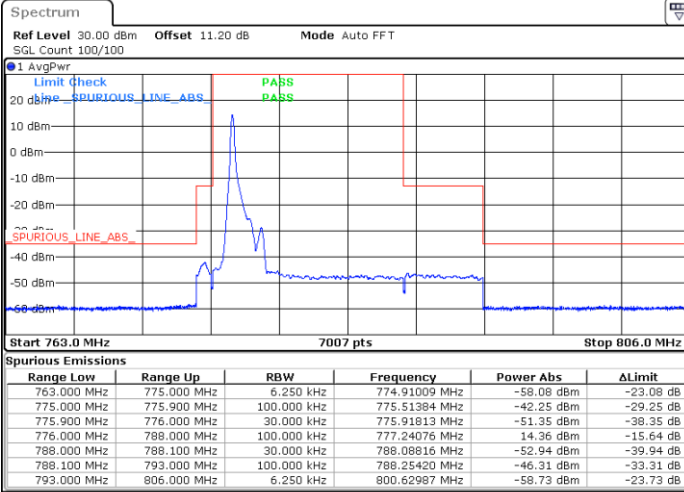

Date: 3.NOV.2022 02:58:25

Date: 3.NOV.2022 03:00:50

Lowest Band Edge / Full RB

Highest Band Edge / Full RB

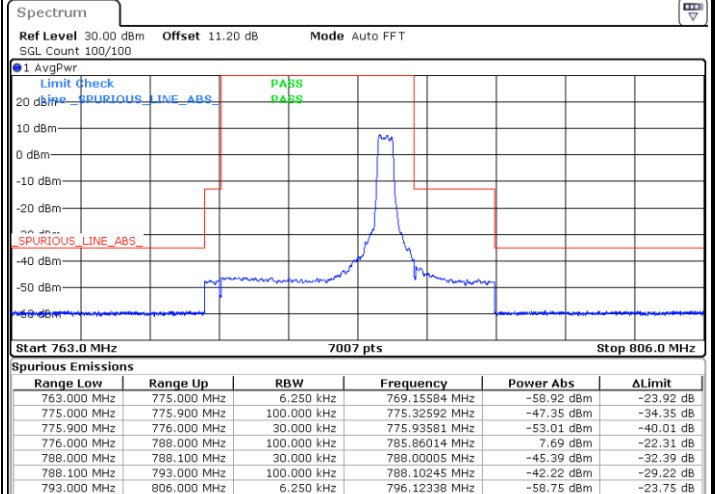
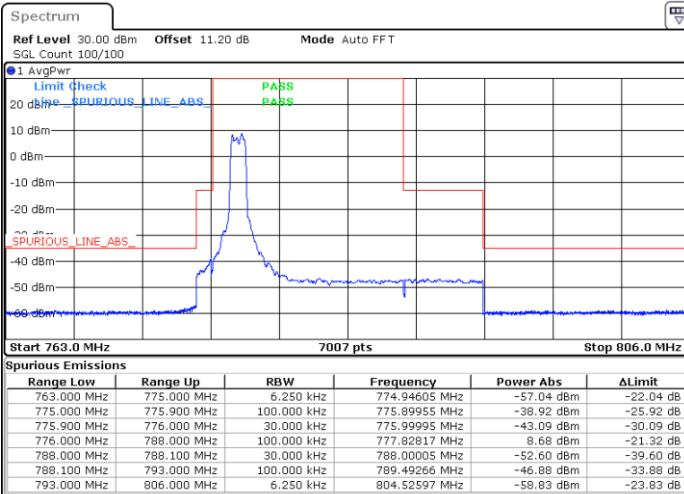

Date: 3.NOV.2022 02:57:59

Date: 3.NOV.2022 02:59:22



Conducted Spurious Emission

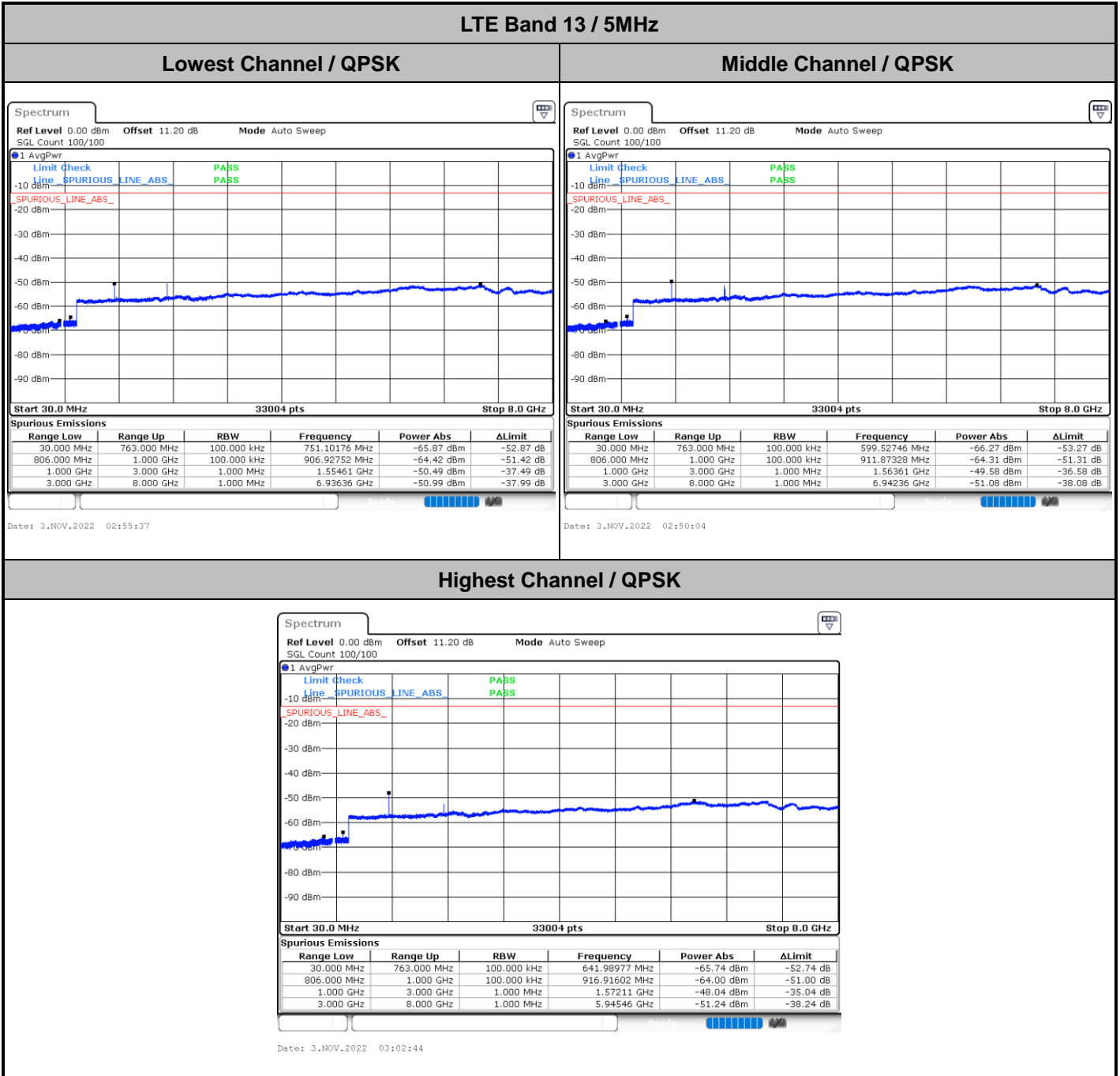



Frequency Stability

Test Conditions		LTE Band 13 (QPSK) / Middle Channel	Limit
Temperature (°C)	Voltage (Volt)	BW 5MHz	Note 2.
		Deviation (ppm)	Result
50	Normal Voltage	0.0072	PASS
40	Normal Voltage	0.0056	
30	Normal Voltage	0.0168	
20(Ref.)	Normal Voltage	0.0000	
10	Normal Voltage	0.0027	
0	Normal Voltage	0.0169	
-10	Normal Voltage	0.0083	
-20	Normal Voltage	0.0064	
-30	Normal Voltage	0.0189	
20	Maximum Voltage	0.0169	
20	Normal Voltage	0.0000	
20	Battery End Point	0.0068	

Note:

1. Normal Voltage = 5.0 V. ; Battery End Point (BEP) = 4.75 V. ; Maximum Voltage = 5.25 V.
2. The frequency fundamental emissions stay within the authorized frequency block.



Appendix B. Test Results of Radiated Test

LTE Band 2

LTE Band 2 / 1.4MHz / QPSK									
Channel	Frequency (MHz)	EIRP (dBm)	Limit (dBm)	Margin (dB)	SPA Reading (dBm)	S.G. Power (dBm)	TX Cable loss (dB)	TX Antenna Gain (dBi)	Polarization (H/V)
Lowest	3702	-47.63	-13	-34.63	-67.88	-54.2	1.67	8.24	H
	5550	-49.83	-13	-36.83	-74.87	-56.9	2.65	9.72	H
	12948	-46.52	-13	-33.52	-82.61	-56.54	2.92	12.94	H
									H
									H
	3702	-50.93	-13	-37.93	-71.59	-57.5	1.67	8.24	V
	5550	-50.43	-13	-37.43	-75.61	-57.5	2.65	9.72	V
	12948	-43.53	-13	-30.53	-79.17	-53.55	2.92	12.94	V
									V
									V
Middle	3762	-44.57	-13	-31.57	-64.9	-51.2	1.69	8.31	H
	5640	-52.25	-13	-39.25	-77.22	-59.3	2.71	9.76	H
	7818	-52.19	-13	-39.19	-78.98	-61.85	2.33	11.99	H
	11278.5	-48.40	-13	-35.40	-82.05	-58.1	2.68	12.39	H
	13158	-46.05	-13	-33.05	-82.59	-56.3	2.97	13.22	H
									H
									H
	3762	-49.17	-13	-36.17	-69.82	-55.8	1.69	8.31	V
	5640	-49.15	-13	-36.15	-74.3	-56.2	2.71	9.76	V
	7518	-51.81	-13	-38.81	-78.92	-61.2	2.42	11.81	V
	11278.5	-45.85	-13	-32.85	-79.85	-55.55	2.68	12.39	V
	13158	-42.59	-13	-29.59	-78.51	-52.84	2.97	13.22	V
									V
								V	



Highest	3816	-45.82	-13	-32.82	-66.53	-52.5	1.70	8.38	H
	5724	-52.76	-13	-39.76	-78.05	-59.8	2.75	9.79	H
	9546	-47.93	-13	-34.93	-78.91	-57.8	2.60	12.47	H
	11457	-42.57	-13	-29.57	-76.16	-52.2	2.68	12.32	H
	13357.5	-44.62	-13	-31.62	-80.89	-55.1	3.02	13.50	H
									H
									H
	3816	-49.52	-13	-36.52	-69.84	-56.2	1.70	8.38	V
	5724	-53.06	-13	-40.06	-78.22	-60.1	2.75	9.79	V
	9546	-48.23	-13	-35.23	-79.46	-58.1	2.60	12.47	V
	11457	-44.67	-13	-31.67	-79.06	-54.3	2.68	12.32	V
	13357.5	-44.32	-13	-31.32	-80.67	-54.8	3.02	13.50	V
									V
									V

Remark: Spurious emissions within 30-1000MHz were found more than 20dB below limit line.



LTE Band 4

LTE Band 4 / 1.4MHz / QPSK										
Channel	Frequency (MHz)	EIRP (dBm)	Limit (dBm)	Margin (dB)	SPA Reading (dBm)	S.G. Power (dBm)	TX Cable loss (dB)	TX Antenna Gain (dBi)	Polarization (H/V)	
Lowest	3420	-50.93	-13	-37.93	-71.33	-57	1.58	7.65	H	
	5130	-54.91	-13	-41.91	-78.77	-62.2	2.41	9.70	H	
	8550	-51.37	-13	-38.37	-80.51	-61.5	2.39	12.52	H	
	11971.5	-42.18	-13	-29.18	-75.59	-51.8	2.68	12.30	H	
	13683	-44.72	-13	-31.72	-81.57	-55.5	3.10	13.88	H	
										H
										H
	3420	-44.83	-13	-31.83	-65.41	-50.9	1.58	7.65	V	
	5130	-49.01	-13	-36.01	-72.82	-56.3	2.41	9.70	V	
	8550	-48.72	-13	-35.72	-77.98	-58.85	2.39	12.52	V	
	11971.5	-39.68	-13	-26.68	-72.62	-49.3	2.68	12.30	V	
	13683	-42.82	-13	-29.82	-79.67	-53.6	3.10	13.88	V	
										V
										V
Middle	3462	-48.96	-13	-35.96	-69.35	-55.2	1.59	7.83	H	
	5196	-55.65	-13	-42.65	-79.31	-62.9	2.45	9.70	H	
	8658	-51.55	-13	-38.55	-80.64	-61.7	2.41	12.56	H	
	12129	-43.58	-13	-30.58	-77.2	-53.2	2.71	12.33	H	
	13861.5	-43.99	-13	-30.99	-81.27	-54.9	3.15	14.06	H	
										H
										H
	3462	-44.16	-13	-31.16	-64.66	-50.4	1.59	7.83	V	
	5196	-51.05	-13	-38.05	-74.7	-58.3	2.45	9.70	V	
	8658	-49.95	-13	-36.95	-78.97	-60.1	2.41	12.56	V	
	12129	-39.48	-13	-26.48	-72.18	-49.1	2.71	12.33	V	
	13861.5	-42.19	-13	-29.19	-79.55	-53.1	3.15	14.06	V	
										V
										V



Highest	3510	-48.70	-13	-35.70	-69.48	-55.1	1.61	8.01	H
	5262	-54.99	-13	-41.99	-79.22	-62.2	2.49	9.70	H
	12276	-42.29	-13	-29.29	-76.37	-51.9	2.75	12.36	H
									H
									H
	3510	-44.00	-13	-31.00	-64.62	-50.4	1.61	8.01	V
	5262	-48.69	-13	-35.69	-72.72	-55.9	2.49	9.70	V
	12276	-38.49	-13	-25.49	-71.73	-48.1	2.75	12.36	V
									V
									V

Remark: Spurious emissions within 30-1000MHz were found more than 20dB below limit line.



LTE Band 12

LTE Band 12 / 1.4MHz / QPSK									
Channel	Frequency (MHz)	ERP (dBm)	Limit (dBm)	Margin (dB)	SPA Reading (dBm)	S.G. Power (dBm)	TX Cable loss (dB)	TX Antenna Gain (dBi)	Polarization (H/V)
Lowest	1400	-62.17	-13	-49.17	-72.17	-63.83	0.87	4.68	H
	2096	-50.81	-13	-37.81	-66.33	-51.68	1.16	4.19	H
	2800	-57.51	-13	-44.51	-75.18	-59.62	1.38	5.64	H
									H
									H
	1400	-62.12	-13	-49.12	-72.81	-63.78	0.87	4.68	V
	2096	-46.46	-13	-33.46	-62.13	-47.33	1.16	4.19	V
	2800	-58.42	-13	-45.42	-76.82	-60.53	1.38	5.64	V
									V
									V
Middle	1416	-60.36	-13	-47.36	-70.52	-62.11	0.87	4.78	H
	2120	-52.41	-13	-39.41	-67.83	-53.35	1.17	4.26	H
	2824	-59.06	-13	-46.06	-76.76	-61.18	1.39	5.66	H
									H
									H
	1416	-62.18	-13	-49.18	-72.80	-63.93	0.87	4.78	V
	2120	-47.44	-13	-34.44	-63.24	-48.38	1.17	4.26	V
	2824	-58.72	-13	-45.72	-77.14	-60.84	1.39	5.66	V
									V
									V



Highest	1432	-60.61	-13	-47.61	-70.78	-62.46	0.88	4.88	H
	2144	-53.96	-13	-40.96	-69.52	-54.96	1.18	4.33	H
	2856	-59.75	-13	-46.75	-77.27	-61.88	1.40	5.68	H
									H
									H
	1432	-62.97	-13	-49.97	-73.68	-64.82	0.88	4.88	V
	2144	-49.18	-13	-36.18	-65.09	-50.18	1.18	4.33	V
	2856	-58.74	-13	-45.74	-77.28	-60.87	1.40	5.68	V
									V
									V

Remark: Spurious emissions within 30-1000MHz were found more than 20dB below limit line.



LTE Band 13

LTE Band 13 / 5MHz / QPSK									
Channel	Frequency (MHz)	ERP (dBm)	Limit (dBm)	Margin (dB)	SPA Reading (dBm)	S.G. Power (dBm)	TX Cable loss (dB)	TX Antenna Gain (dBi)	Polarization (H/V)
Lowest	1552	-63.24	-13	-50.24	-74.26	-65.31	0.94	5.15	H
	2336	-56.39	-13	-43.39	-73.05	-57.91	1.24	4.91	H
	3112	-58.66	-13	-45.66	-77.21	-61.32	1.48	6.29	H
	3888	-57.63	-13	-44.63	-78.19	-62.22	1.73	8.47	H
									H
									H
									H
	1552	-60.08	-13	-47.08	-71.44	-62.15	0.94	5.15	V
	2336	-59.57	-13	-46.57	-76.67	-61.09	1.24	4.91	V
	3112	-58.42	-13	-45.42	-77.62	-61.08	1.48	6.29	V
	3888	-58.36	-13	-45.36	-78.99	-62.95	1.73	8.47	V
									V
									V
									V
Middle	1560	-63.48	-42.15	-21.33	-74.55	-65.52	0.94	5.13	H
	2344	-56.74	-13	-43.74	-73.37	-58.28	1.24	4.93	H
	3128	-59.04	-13	-46.04	-77.59	-61.77	1.49	6.36	H
	3912	-56.56	-13	-43.56	-77.16	-61.17	1.73	8.49	H
									H
									H
									H
	1568	-60.26	-42.15	-18.11	-71.79	-62.28	0.94	5.11	V
	2344	-58.81	-13	-45.81	-76.01	-60.35	1.24	4.93	V
	3128	-58.28	-13	-45.28	-77.51	-61.01	1.49	6.36	V
	3912	-57.02	-13	-44.02	-77.71	-61.63	1.73	8.49	V
									V
									V
									V



Highest	1568	-61.57	-42.15	-19.42	-72.60	-63.59	0.94	5.11	H
	2360	-57.39	-13	-44.39	-74.18	-58.97	1.25	4.98	H
	3144	-58.85	-13	-45.85	-77.47	-61.64	1.49	6.43	H
	3928	-52.42	-13	-39.42	-72.91	-57.05	1.74	8.51	H
									H
									H
									H
	1568	-60.71	-42.15	-18.56	-72.26	-62.73	0.94	5.11	V
	2360	-58.08	-13	-45.08	-75.43	-59.66	1.25	4.98	V
	3144	-58.23	-13	-45.23	-77.50	-61.02	1.49	6.43	V
	3928	-55.74	-13	-42.74	-76.42	-60.37	1.74	8.51	V
									V
									V
									V

Remark: Spurious emissions within 30-1000MHz were found more than 20dB below limit line.



LTE Band 5

LTE Band 5 / 1.4MHz / QPSK									
Channel	Frequency (MHz)	ERP (dBm)	Limit (dBm)	Margin (dB)	SPA Reading (dBm)	S.G. Power (dBm)	TX Cable loss (dB)	TX Antenna Gain (dBi)	Polarization (H/V)
Lowest	1648	-56.84	-13	-43.84	-68.04	-58.6	0.98	4.89	H
	2472	-58.22	-13	-45.22	-75.08	-60.1	1.28	5.32	H
	3296	-57.49	-13	-44.49	-76.52	-60.9	1.54	7.10	H
									H
									H
									H
	1648	-56.14	-13	-43.14	-68.17	-57.9	0.98	4.89	V
	2472	-58.42	-13	-45.42	-75.76	-60.3	1.28	5.32	V
	3296	-57.19	-13	-44.19	-76.47	-60.6	1.54	7.10	V
									V
									V
									V
Middle	1672	-56.92	-13	-43.92	-68.5	-58.60	0.99	4.82	H
	2512	-59.53	-13	-46.53	-76.47	-61.5	1.29	5.41	H
	3346	-57.03	-13	-44.03	-76.28	-60.65	1.56	7.32	H
									H
									H
									H
	1672	-54.03	-13	-41.03	-66.42	-55.71	0.99	4.82	V
	2512	-58.18	-13	-45.18	-75.68	-60.15	1.29	5.41	V
	3346	-57.28	-13	-44.28	-76.67	-60.9	1.56	7.32	V
									V
									V
									V



Highest	1696	-58.15	-13	-45.15	-70.01	-59.75	1.00	4.75	H
	2544	-59.27	-13	-46.27	-76.24	-61.25	1.30	5.44	H
	3392	-57.00	-13	-44.00	-76.83	-60.8	1.57	7.52	H
									H
									H
									H
	1696	-58.00	-13	-45.00	-70.2	-59.6	1.00	4.75	V
	2544	-58.76	-13	-45.76	-76.05	-60.74	1.30	5.44	V
	3392	-57.20	-13	-44.20	-76.54	-61	1.57	7.52	V
									V
									V
									V

Remark: Spurious emissions within 30-1000MHz were found more than 20dB below limit line.