

# Wireless smart home system manual

## 一、Wireless smart home system structure chart

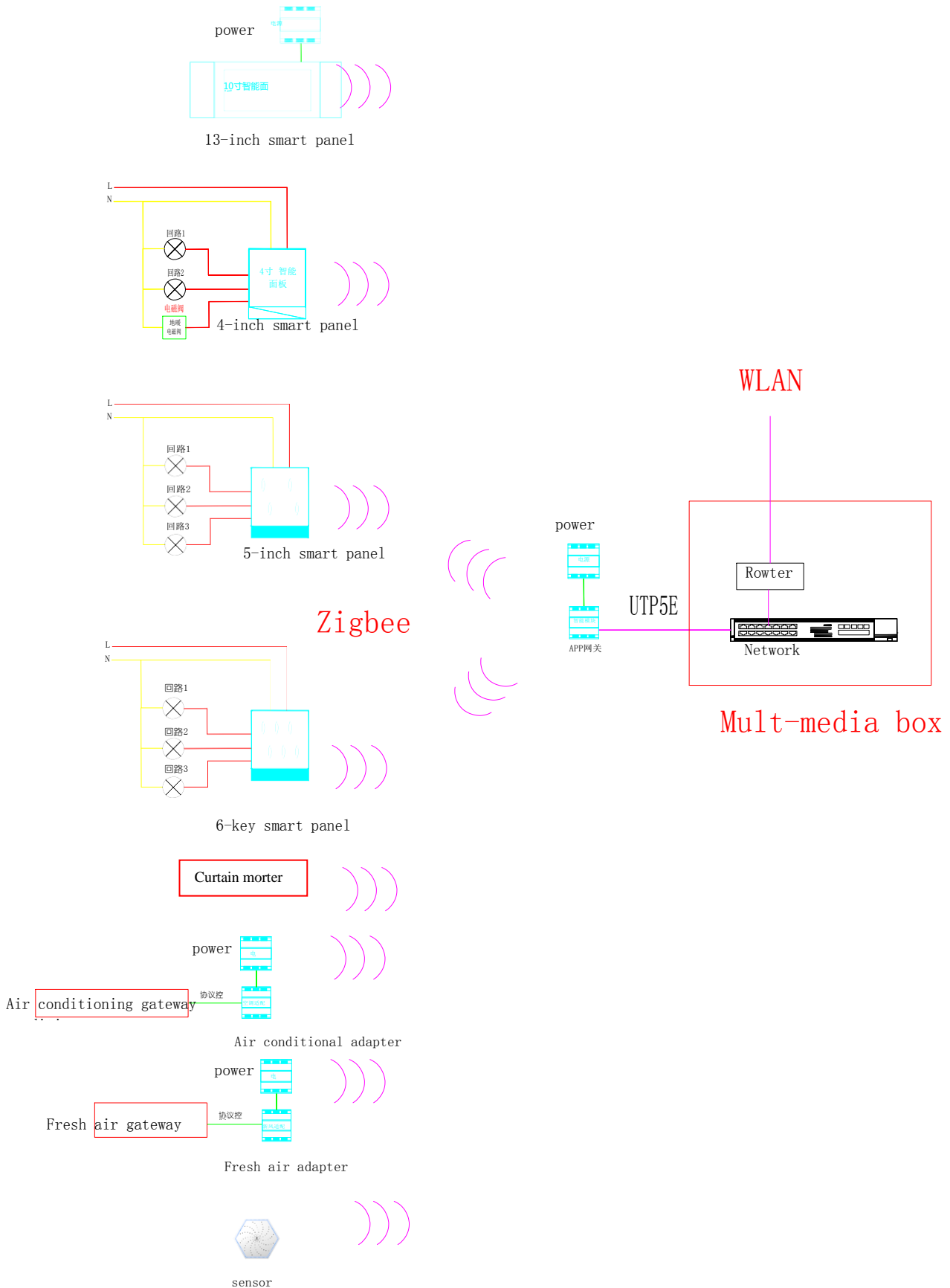

## 二、Wireless smart home system wiring instructions

### (一) Digital Building Unit Door Machine

#### 1、Product appearance



LW-Z13-MDQ-DF

#### 2、Interface specification

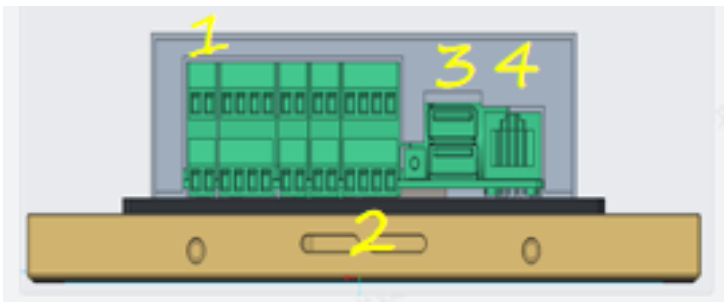

Terminal 1: power port : From left to right: GND ,power(12V) .

Terminal 2: Dry contact output port: From left to right: NO,COM,NC,COM.

Terminal 3: USB port.

Terminal 4: Ethernet Port.

#### 3、Technical parameters:

working voltage	12V	Working Power	≤ 12W
Working humidity	20%~90%	Working temperature	-20~50°C
Load power	loop1≤ 660W loop2≤ 220W loop3≤ 220W loop4≤ 220W	Wireless protocol	WIFI、Bluetooth
Screen	13.3-inch color LED screen	camera	Binocular width dynamic 2 million pixels
Screen definition	1920*1080	Touch way	Capacitive touch screen
CPU	SMD450,8core basic frequency 1.8G	FLASH	16G
picture format	JPEG、BMP	Language support	Support multi-language

## (二) smart panel (13.3-inch display)

### 1、Product appearance



LW-X13-H0W-T-Z

### 2、Interface specification

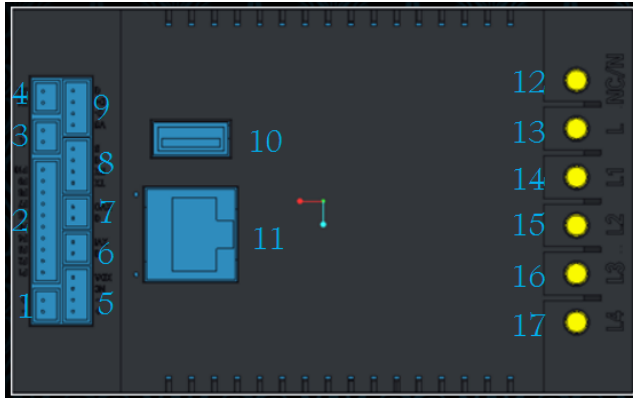

Terminal 1: power port : From left to right: GND ,power(12V) .

Terminal 2: security port : From left to right: F1~F10 ,Output alarm sensor.

Terminal 3:RS485 port : From left to right:485A ,485B

Terminal 4: Dry contact output port : From left to right: K1 ,K2, for Calling the elevator

Terminal 5:Doorbell bus interface: From left to right: 12V ,GND,NC,DATA.

Terminal 6:From left to right:GND,XVI, Connect the visual doorbell video output interface.

Terminal 7:From left to right:GND, XVO, Connect the next smart screen video input connection mouth

Terminal 8: Usb interface : From left to right:5V ,-D,+D,GND

Terminal 9:Program entry : From left to right:5V ,-D,+D,GND, Connect USB port of computer

Terminal 10: Ethernet interface : Connecting LAN Switches, Used for TCP/IP communication

3、 Technical parameters

working voltage	12V	Working Power	≤ 10W
Working humidity	20%~90%	Working temperature	-20~50°C
Load power	loop1≤ 660W loop2≤ 220W loop3≤ 220W loop4≤ 220W	Wireless protocol	Zigbee
Screen	13.3-inch color LED screen	WiReless Frequency	2.4GHz ISM
Screen definition	1920*1080	Touch way	Capacitive touch screen
CPU	SMD450,8-core , basic frequency 1.8G	FLASH	16G
picture format	JPEG、BMP	Language support	Support multi-language

### (三) smart panel (4-inch display)

#### 1、Product appearance



LW-Z4-MDQ-PR-Z

#### 2、Interface specification

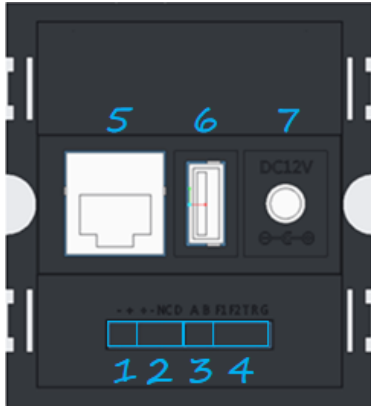

Terminal 1: power port : From left to right: GND ,power(12V) .

Terminal 2:Doorbell bus interface: From left to right: 12V ,GND,NC,DATA.

Terminal 3:RS485 port : From left to right:485A ,485B

Terminal 4: Security and serial debugging interface : From left to right: F1,F2 , TX, RX,GND Terminal 5: Ethernet interface : Connecting LAN Switches, For visual intercom data communication.

Terminal 6: Usb interface.

Terminal 7: DC power port , Standard 12V DC ports are reserved.

### 3、 Technical parameters

working voltage	AC220V/50HZ	Working Power	≤6W
Working humidity	20%~90%	Working temperature	-20~50℃
Load power	loop1≤ 660W loop2≤ 220W loop3≤ 220W	Wireless protocol	Zigbee
Screen	4-inch color LED screen	WiReless Frequency	2. 4GHz ISM
Screen definition	480*480	Touch way	Capacitive touch screen
CPU	SigmaStar A7 CPU basic frequency 1.2GHz	FLASH	512M
picture format	JPEG、 BMP	Language support	Support multi-language

#### (四) smart panel (5-inch display)

##### 1、 Product appearance



LW-Z5-MDQ-PR-Z

##### 2、 Interface specification

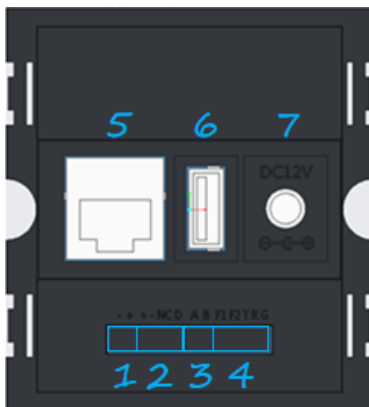

Terminal 1: power port : From left to right: GND ,power(12V) .

Terminal 2:Doorbell bus interface: From left to right: 12V ,GND,NC,DATA.

Terminal 3:RS485 port : From left to right:485A ,485B

Terminal 4: Security and serial debugging interface : From left to right: F1,F2 , TX, RX,GND Terminal 5: Ethernet interface : Connecting LAN Switches, For visual intercom data communication.

Terminal 6: Usb interface

Terminal 7: DC power port , Standard 12V DC ports are reserved

##### 3、 Technical parameters

working voltage	AC220V/50HZ	Working Power	≤ 6W
Working humidity	20%~95%	Working temperature	-20~50°C
Load power	loop1≤ 660W loop2≤ 660W loop3≤ 660W	Wireless protocol	Zigbee
Screen	5-inch color LED screen	WiReless Frequency	2.4GHz ISM
Screen definition	480*854	Touch way	Capacitive touch screen
CPU	SigmaStar A7 CPU basic frequency 1.2GHz	FLASH	512M
picture format	JPEG、BMP	Language support	Support multi-language

### (五) Intelligent Key Control Panel (4 key )

#### 1、Product appearance



LW-ZN4-MDQ-PR-Z

#### 2、Interface specification

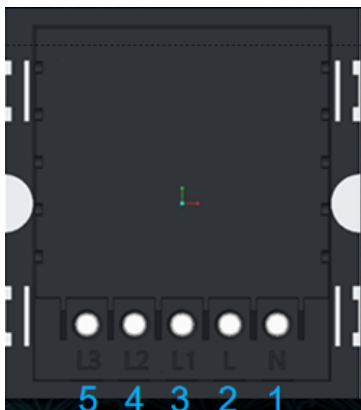



Terminal 1: N Connect ac 220V neutral wire.  
 Terminal 2:L Connect ac 220V live wire.  
 Terminal 3: L1 Loop 1 ,output terminal,3A Load.  
 Terminal 4: L1 Loop 2, output terminal,3A Load.  
 Terminal 5: L1 Loop 3, output terminal,3A Load.

### 3、 Technical parameters

working voltage	AC220V/50HZ	Working Power	≤ 3.6W
Working humidity	20%~90%	Working temperature	-20~50°C
Load power	loop1≤ 660W loop2≤ 220W loop3≤ 220W	Wireless protocol	Zigbee
Touch way	4-key touch	WiReless Frequency	2.4GHz ISM
CPU	STM Cortex-M0	CPU frequency	72MHZ

## (六) Intelligent Key Control Panel (6 key )

### 1、 Product appearance



LW-ZN6-MDQ-PR-Z

### 2、 Interface specification

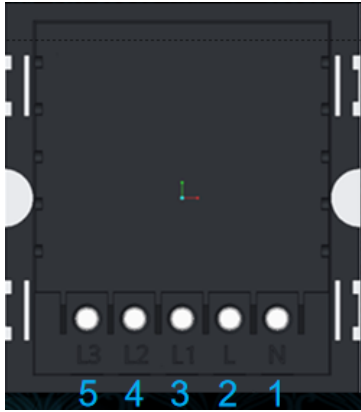

Terminal 1: N Connect ac 220V neutral wire.  
 Terminal 2:L Connect ac 220V live wire.  
 Terminal 3: L1 Loop 1 ,output terminal,3A Load.  
 Terminal 4: L1 Loop 2, output terminal,3A Load.  
 Terminal 5: L1 Loop 3, output terminal,3A Load.

### 3、 Technical parameters

working voltage	AC220V/50HZ	Working Power	≤ 3.6W
Working humidity	20%~90%	Working temperature	-20~50°C
Load power	loop1≤ 660W loop2≤ 220W loop3≤ 220W	Wireless protocol	Zigbee
Touch way	6-key touch	WiReless Frequency	2.4GHz ISM
CPU	STM Cortex-M0	CPU frequency	72MHZ

## ( 七 ) APP wireless gateway

### 1、 Product appearance



### 2、 APP Wireless gateway interface description

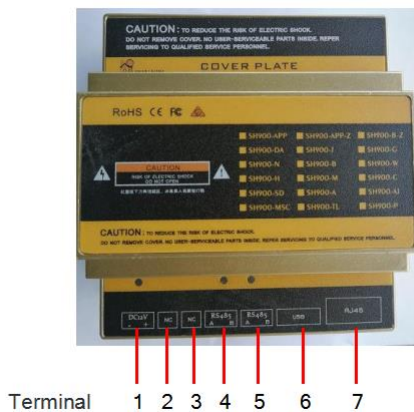

key parameter : power  $\leq$  2.5W, input voltage=12V

announcements : The reserved ports , Please don't connection

Terminal 1 : DC power input port , From left to right ( GND , +12V)

Terminal 2 : NC, Air terminal

Terminal 3 : NC, Air terminal

Terminal 4 : The reserved ports , Ban wiring

Terminal 5 : RS48 communication port,From left to right ( 485A,485B)

Terminal 6 : USB port , Used to update the application。

Terminal 7 : RJ45 port , Connect to port RJ45, the indoor wireless router , Realize mobile phone APP control smart home system.

### 3、 Technical parameters:

working voltage: 12V

Working Power: $\leq\leq$ 2.5W

Working humidity:0~95% ;

Working temperature : -10~50°C ;

Cable agreement : RS485、 TCP/IP

Wireless Protocol : Zigbee ;

Wireless Frequency : 2.4GHz ISM ;

CPU : ARM Cortex-A7 ;

CPU basic frequency : 1.2GHz ;

Memory: 64MB.

( 八 ) power supply

### 1、 Product appearance



## 1、 Power interface description

Ver1.0

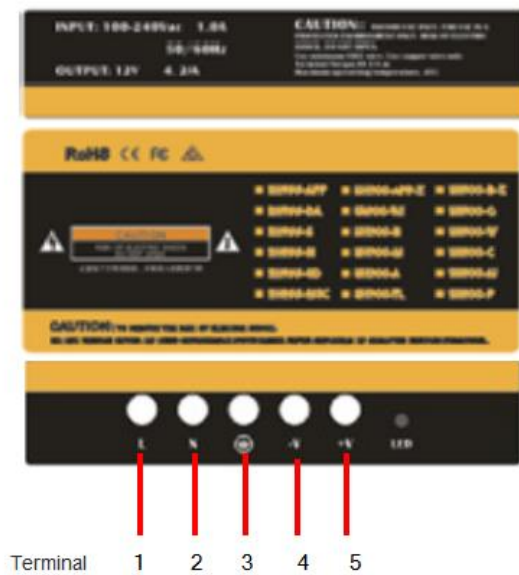

Description of parameters : input voltage 220V 50/60HZ; output voltage DC=12V, output current=4.2A

Terminal 1: 220V AC live wire input terminal ;

Terminal 2 : 220V AC zero wire input terminal ;

Terminal 3 : 220V AC protective input terminal ;

Terminal 4 : DC power output terminal ( GND ) ;

Terminal 5 : DC power output terminal ( +12V ) .

## 4、 Technical parameters:

input voltage : AC 220V/50HZ ;

incoming current :  $\leq 0.56A$  ;

output voltage : DC 12V ;

output current :  $\leq 4.2A$  ;

Working humidity: 0~95% ;

Working temperature : -10~50°C。

### 三、Function description of wireless smart home system

- (1) Realize light loop on/off, dimming and scene control;
- (2) Realize curtain system open, close, stop control;
- (3) Realize air conditioner on/off control, temperature setting, air volume and mode selection;
- (4) Realize ventilation on/off control and mode selection;
- (5) Realize floor heating on/off control and temperature setting;
- (6) Realize background music on/off control, play/pause control, volume adjustment, multichannel audio input selection;
- (7) Realize TV on/off control, channel selection, volume adjustment and mode selection, DVD on/off control, play control and volume adjustment, amplifier on/off control, volume adjustment, mode selection and multichannel audio input selection;
- (8) Integrated LCD touch screen, key pressing function can be configured and switched among different operating interfaces.

### 四、Statement

- 1、 All leads should avoid lapping with strong current, causing short circuit or interfering with the system;
- 2、 The connection should be firmly connected to avoid the system instability caused by poor connection;
- 3、 Installation location to facilitate user operation;
- 4、 Installation position should be far away from TV, DVD, computer and other strong radiation electrical equipment;
- 5、 LCD screen, touch button and panel avoid direct contact with hard objects;
- 6、 Avoid strong vibration, collision, percussion, resulting in internal precision components and shell damage;
- 7、 Avoid installation in direct sunlight position;
- 8、 Non-professional installation and maintenance personnel shall not dismantle the machine for debugging;
- 9、 Pay attention to waterproof lest water into the system and cause short circuit damage;
- 10、 Be careful not to talk for too long to avoid the delay of normal use of other users。

## RED Statement

WiFi	
Operation Frequency:	2412~2472MHz
Maximum Power:	≤20dBm(E.I.R.P.)
Zigbee	
Operation Frequency:	2405~2480MHz
Maximum Power:	≤20dBm(E.I.R.P.)

1. This product complies with RF specifications when it's used at 20cm form your body.
2. This product can be used across EU member states.



## FCC Statement

This equipment has been tested and found to comply with the limits for a Class B digital device, pursuant to Part 15 of the FCC Rules. These limits are designed to provide reasonable protection against harmful interference in a residential installation. This equipment generates uses and can radiate radio frequency energy and, if not installed and used in accordance with the instructions, may cause harmful interference to radio communications. However, there is no guarantee that interference will not occur in a particular installation. If this equipment does cause harmful interference to radio or television reception, which can be determined by turning the equipment off and on, the user is encouraged to try to correct the interference by one or more of the following measures:

- Reorient or relocate the receiving antenna.
- Increase the separation between the equipment and receiver.
- Connect the equipment into an outlet on a circuit different from that to which the receiver is connected.
- Consult the dealer or an experienced radio/TV technician for help.

### § 15.19 Labeling requirements.

This device complies with part 15 of the FCC Rules. Operation is subject to the following two conditions: (1) This device may not cause harmful interference, and (2) this device must accept any interference received, including interference that may cause undesired operation.

### § 15.21 Information to user.

Any Changes or modifications not expressly approved by the party responsible for compliance could void the user's authority to operate the equipment.

This product complies with RF specifications when it's used at 20cm form your body.