



SAR REFERENCE DIPOLE CALIBRATION REPORT

Ref: ACR.53.29.24.BES.A

Software	OPENSAR V5
Phantom	SN 13/09 SAM68
Probe	3523-EPGO-429
Liquid	Head Liquid Values: eps' : 42.1 sigma : 1.83
Distance between dipole center and liquid	10.0 mm
Area scan resolution	dx=8mm/dy=8mm
Zoon Scan Resolution	dx=5mm/dy=5mm/dz=5mm
Frequency	2450 MHz
Input power	20 dBm
Liquid Temperature	20 +/- 1 °C
Lab Temperature	20 +/- 1 °C
Lab Humidity	30-70 %

Frequency	1g SAR (W/kg)			10g SAR (W/kg)		
	Measured	Measured normalized to 1W	Target normalized to 1W	Measured	Measured normalized to 1W	Target normalized to 1W
2450 MHz	5.00	50.05	52.40	2.38	23.80	24.00

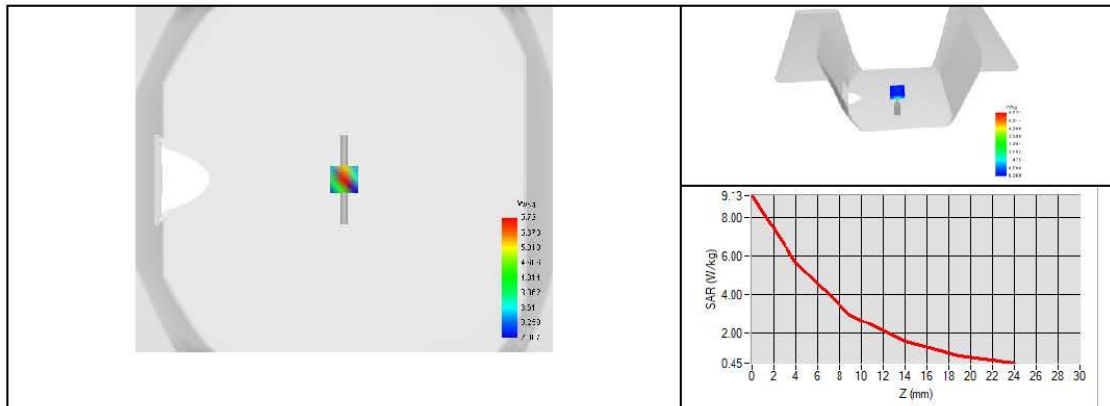



SAR REFERENCE DIPOLE CALIBRATION REPORT

Ref: ACR.53.29.24.BES.A

7 LIST OF EQUIPMENT

Equipment Summary Sheet				
Equipment Description	Manufacturer / Model	Identification No.	Current Calibration Date	Next Calibration Date
SAM Phantom	MVG	SN 13/09 SAM68	Validated. No cal required.	Validated. No cal required.
COMOSAR Test Bench	Version 3	NA	Validated. No cal required.	Validated. No cal required.
Network Analyzer	Rohde & Schwarz ZVM	100203	08/2021	08/2024
Network Analyzer – Calibration kit	Rohde & Schwarz ZV-Z235	101223	07/2022	07/2025
Calipers	Mitutoyo	SN 0009732	11/2022	11/2025
Reference Probe	MVG	3523-EPGO-429	11/2023	11/2024
Multimeter	Keithley 2000	4013982	02/2023	02/2026
Signal Generator	Rohde & Schwarz SMB	106589	03/2022	03/2025
Amplifier	MVG	MODU-023-C-0002	Characterized prior to test. No cal required.	Characterized prior to test. No cal required.
Power Meter	NI-USB 5680	170100013	06/2021	06/2024
Power Meter	Keysight U2000A	SN: MY62340002	10/2022	10/2025
Directional Coupler	Krytar 158020	131467	Characterized prior to test. No cal required.	Characterized prior to test. No cal required.
Temperature / Humidity Sensor	Testo 184 H1	44225320	06/2021	06/2024



SAR Reference Waveguide Calibration Report

Ref : ACR.53.31.24.BES.A

**SHENZHEN NTEK TESTING TECHNOLOGY
CO., LTD.**

**BUILDING E, FENDA SCIENCE PARK, SANWEI
COMMUNITY, XIXIANG STREET, BAO'AN
DISTRICT, SHENZHEN GUANGDONG, CHINA MVG
COMOSAR REFERENCE WAVEGUIDE**

**FREQUENCY: 5000-6000 MHZ
SERIAL NO.: SN 13/14 WGA 33**

Calibrated at MVG

Z.I. de la pointe du diable

**Technopôle Brest Iroise – 295 avenue Alexis de Rochon
29280 PLOUZANE - FRANCE**

Calibration date: 02/21/2024



Accreditations #2-6789 and #2-6814
Scope available on www.cofrac.fr

The use of the Cofrac brand and the accreditation references is prohibited from any reproduction.



Summary:

This document presents the method and results from an accredited SAR reference waveguide calibration performed at MVG, using the COMOSAR test bench. The test results covered by accreditation are traceable to the International System of Units (SI).



SAR REFERENCE WAVEGUIDE CALIBRATION REPORT

Ref: ACR.53.31.24.BES.A

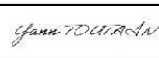
	<i>Name</i>	<i>Function</i>	<i>Date</i>	<i>Signature</i>
<i>Prepared by :</i>	Pedro Ruiz	Measurement Responsible	2/22/2024	
<i>Checked & approved by:</i>	Jérôme Luc	Technical Manager	2/22/2024	
<i>Authorized by:</i>	Yann Toutain	Laboratory Director	2/27/2024	

Yann Toutain ID  Signature numérique de Yann Toutain ID
Date : 2024.02.27 08:58:45 +01'00'

	<i>Customer Name</i>
<i>Distribution :</i>	SHENZHEN NTEK TESTING TECHNOLOGY CO., LTD.

<i>Issue</i>	<i>Name</i>	<i>Date</i>	<i>Modifications</i>
A	Pedro Ruiz	2/22/2024	Initial release



SAR REFERENCE WAVEGUIDE CALIBRATION REPORT

Ref: ACR.53.31.24.BES.A

TABLE OF CONTENTS

1	Introduction.....	4
2	Device Under Test.....	4
3	Product Description.....	4
3.1	General Information.....	4
4	Measurement Method.....	4
4.1	Mechanical Requirements.....	4
4.2	S11 parameter Requirements.....	4
4.3	SAR Requirements.....	5
5	Measurement Uncertainty.....	5
5.1	Mechanical dimensions.....	5
5.2	S11 Parameter.....	5
5.3	SAR.....	5
6	Calibration Results.....	5
6.1	Mechanical Dimensions.....	5
6.2	S11 parameter.....	6
6.3	SAR.....	6
7	List of Equipment.....	9



SAR REFERENCE WAVEGUIDE CALIBRATION REPORT

Ref: ACR.53.31.24.BES.A

1 INTRODUCTION

This document contains a summary of the requirements set forth by the IEC/IEEE 62209-1528 and FCC KDB865664 D01 standards for reference waveguides used for SAR measurement system validations and the measurements that were performed to verify that the product complies with the fore mentioned standards.

2 DEVICE UNDER TEST

Device Under Test	
Device Type	COMOSAR 5000-6000 MHz REFERENCE WAVEGUIDE
Manufacturer	MVG
Model	SWG5500
Serial Number	SN 13/14 WGA 33
Product Condition (new / used)	Used

3 PRODUCT DESCRIPTION

3.1 GENERAL INFORMATION

MVG’s COMOSAR Validation Waveguides are built in accordance to the IEC/IEEE 62209-1528 and FCC KDB865664 D01 standards.

4 MEASUREMENT METHOD

4.1 MECHANICAL REQUIREMENTS

The IEC/IEEE 62209-1528 and FCC KDB865664 D01 standards specify the mechanical components and dimensions of the validation dipoles, with the dimension’s frequency and phantom shell thickness dependent. The COMOSAR test bench employs a 2 mm phantom shell thickness therefore the dipoles sold for use with the COMOSAR test bench comply with the requirements set forth for a 2 mm phantom shell thickness. A direct method is used with a ISO17025 calibrated caliper.

4.2 S11 PARAMETER REQUIREMENTS

The dipole used for SAR system validation measurements and checks must have a S11 of -8 dB or better. The S11 measurement shall be performed against a liquid filled flat phantom, with the phantom constructed as outlined in the fore mentioned standards. A direct method is used with a network analyser and its calibration kit, both with a valid ISO17025 calibration.



SAR REFERENCE WAVEGUIDE CALIBRATION REPORT

Ref: ACR.53.31.24.BES.A

4.3 SAR REQUIREMENTS

The IEC/IEEE 62209-1528 and FCC KDB865664 D01 standards provide requirements for reference dipoles used for system validation measurements. The following measurements were performed to verify that the product complies with the fore-mentioned standards.

5 MEASUREMENT UNCERTAINTY

5.1 MECHANICAL DIMENSIONS

The estimated expanded uncertainty (k=2) in calibration for the dimension measurement in mm is +/- 0.20 mm with respect to measurement conditions.

5.2 S11 PARAMETER

The estimated expanded uncertainty (k=2) in calibration for the S11 parameter in linear is +/-0.08 with respect to measurement conditions.

5.3 SAR

The guidelines outlined in the IEC/IEEE 62209-1528 and FCC KDB865664 D01 standards were followed to generate the measurement uncertainty for validation measurements.

The estimated expanded uncertainty (k=2) in calibration for the 1g and 10g SAR measurement in W/kg is +/-19% with respect to measurement conditions.

6 CALIBRATION RESULTS

6.1 MECHANICAL DIMENSIONS

Frequency (MHz)	L (mm)		W (mm)		L _r (mm)		W _r (mm)	
	Required	Measured	Required	Measured	Required	Measured	Required	Measured
5800	40.39 ± 0.13	-	20.19 ± 0.13	-	81.03 ± 0.13	-	61.98 ± 0.13	-

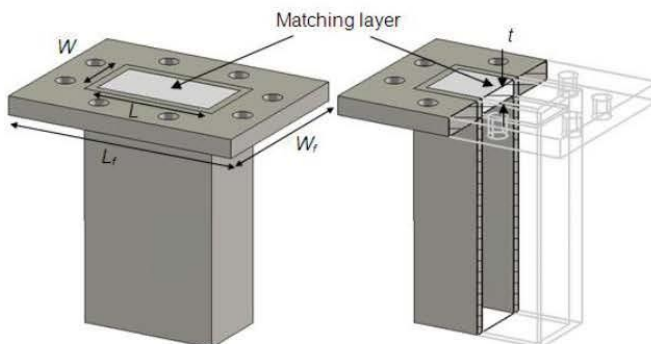

Figure 1: Validation Waveguide Dimensions



SAR REFERENCE WAVEGUIDE CALIBRATION REPORT

Ref: ACR.53.31.24.BES.A

6.2 S11 PARAMETER

6.2.1 S11 parameter In Head Liquid

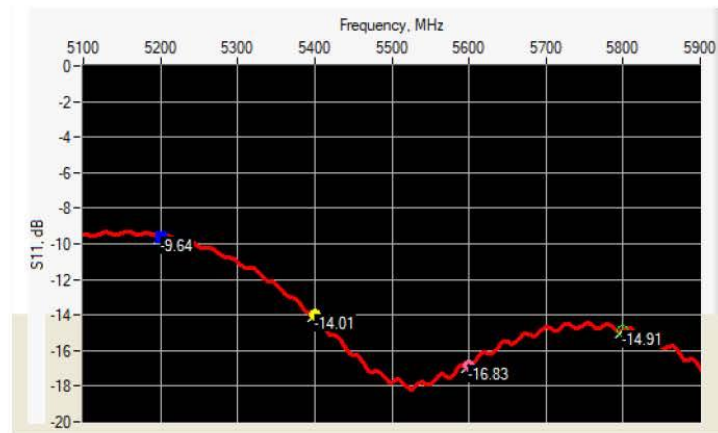

Frequency (MHz)	S11 parameter (dB)	Requirement (dB)	Impedance
5200	-9.64	-8	25.80 Ω - 6.58 jΩ
5400	-14.01	-8	51.53 Ω + 20.60 jΩ
5600	-16.83	-8	44.12 Ω - 12.35 jΩ
5800	-14.91	-8	38.53 Ω + 11.21 jΩ

6.3 SAR

The IEC/IEEE 62209-1528 and FCC KDB865664 D01 standards state that the system validation measurements must be performed using a reference waveguide meeting the fore mentioned return loss and mechanical dimension requirements. The validation measurement must be performed with the matching layer placed in the open end of the waveguide, with the waveguide and matching layer in direct contact with the phantom shell.

6.3.1 SAR With Head Liquid

At those frequencies, the target SAR value can not be generic. Hereunder is the target SAR value defined by MVG, within the uncertainty for the system validation. All SAR values are normalized to 1 W net power. In bracket, the measured SAR is given with the used input power.



SAR REFERENCE WAVEGUIDE CALIBRATION REPORT

Ref: ACR.53.31.24.BES.A

Software	OPENSAR V5
Phantom	SN 13/09 SAM68
Probe	3523-EPGO-429
Liquid	Head Liquid Values 5200 MHz: eps' :34.16 sigma : 4.42 Head Liquid Values 5400 MHz: eps' :33.63 sigma : 4.64 Head Liquid Values 5600 MHz: eps' :33.12 sigma : 4.87 Head Liquid Values 5800 MHz: eps' :32.57 sigma : 5.12
Distance between dipole waveguide and liquid	0 mm
Area scan resolution	dx=8mm/dy=8mm
Zoon Scan Resolution	dx=4mm/dy=4m/dz=2mm
Frequency	5200 MHz 5400 MHz 5600 MHz 5800 MHz
Input power	20 dBm
Liquid Temperature	20 +/- 1 °C
Lab Temperature	20 +/- 1 °C
Lab Humidity	30-70 %

Frequency (MHz)	1 g SAR (W/kg)			10 g SAR (W/kg)		
	Measured	Measured normalized to 1W	Target normalized to 1W	Measured	Measured normalized to 1W	Target normalized to 1W
5200	16.26	162.59	159.00	5.62	56.21	56.90
5400	15.98	159.81	166.40	5.50	55.00	58.43
5600	17.91	179.15	173.80	6.10	61.01	59.97
5800	18.22	182.20	181.20	6.13	61.32	61.50

SAR MEASUREMENT PLOTS @ 5200 MHz

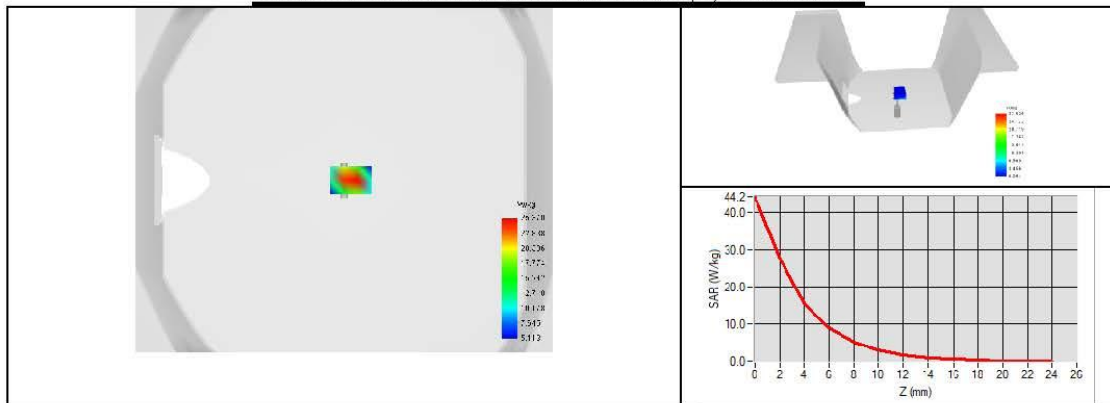



SAR REFERENCE WAVEGUIDE CALIBRATION REPORT

Ref: ACR.53.31.24.BES.A

SAR MEASUREMENT PLOTS @ 5400 MHz

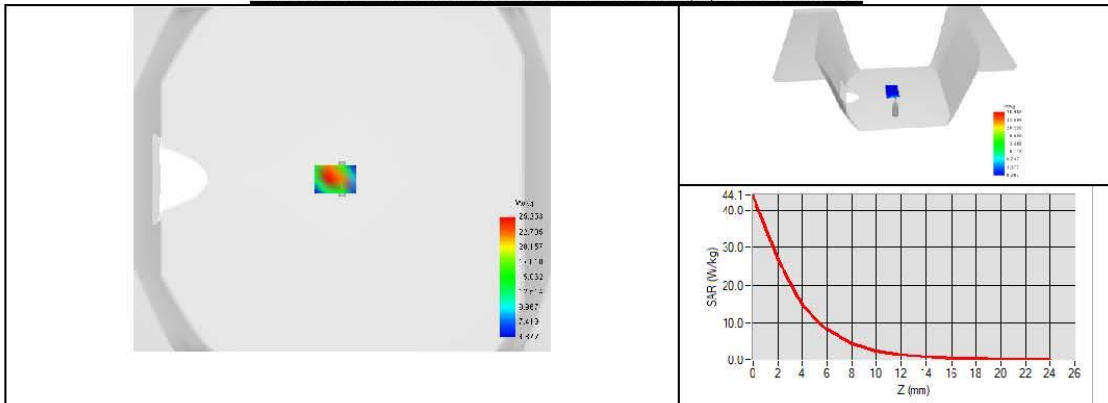

SAR MEASUREMENT PLOTS @ 5600 MHz

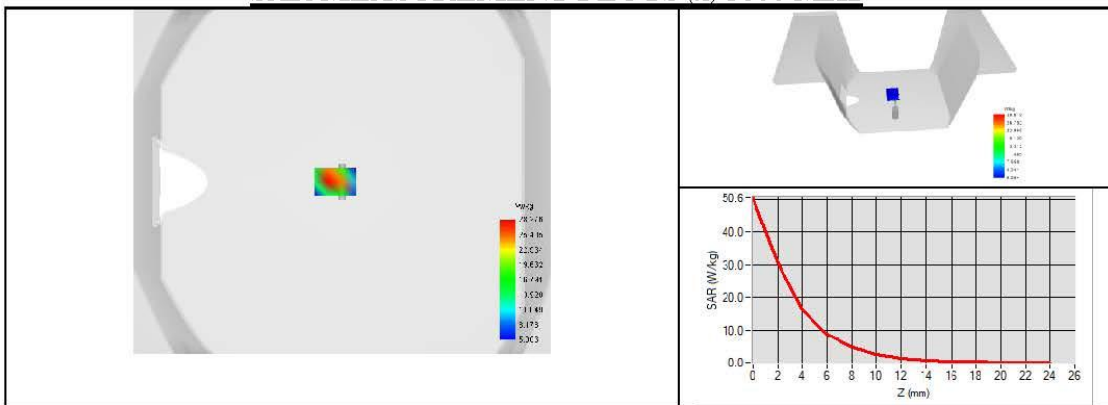

SAR MEASUREMENT PLOTS @ 5800 MHz

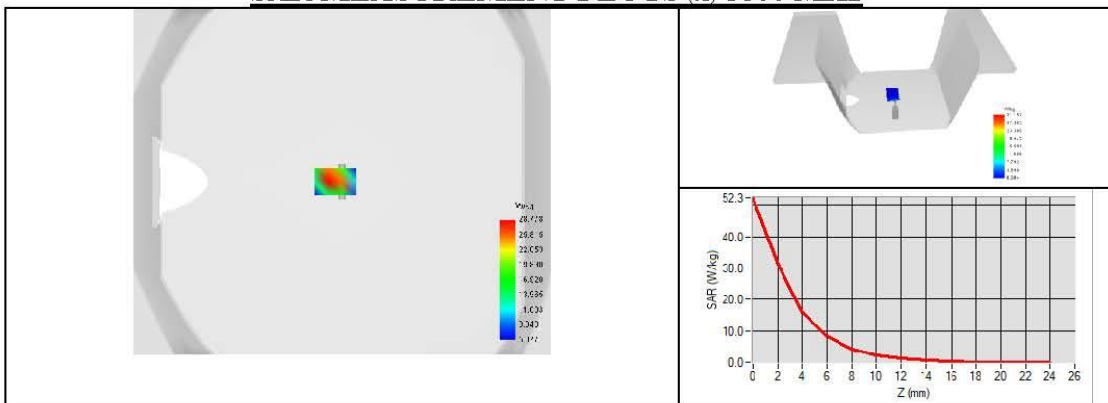



SAR REFERENCE WAVEGUIDE CALIBRATION REPORT

Ref: ACR.53.31.24.BES.A

7 LIST OF EQUIPMENT

Equipment Summary Sheet				
Equipment Description	Manufacturer / Model	Identification No.	Current Calibration Date	Next Calibration Date
SAM Phantom	MVG	SN 13/09 SAM68	Validated. No cal required.	Validated. No cal required.
COMOSAR Test Bench	Version 3	NA	Validated. No cal required.	Validated. No cal required.
Network Analyzer	Rohde & Schwarz ZVM	100203	08/2021	08/2024
Network Analyzer – Calibration kit	Rohde & Schwarz ZV-Z235	101223	07/2022	07/2025
Calipers	Mitutoyo	SN 0009732	11/2022	11/2025
Reference Probe	MVG	3623-EPGO-431	11/2023	11/2024
Multimeter	Keithley 2000	4013982	02/2023	02/2026
Signal Generator	Rohde & Schwarz SMB	106589	03/2022	03/2025
Amplifier	MVG	MODU-023-C-0002	Characterized prior to test. No cal required.	Characterized prior to test. No cal required.
Power Meter	NI-USB 5680	170100013	06/2021	06/2024
Power Meter	Keysight U2000A	SN: MY62340002	10/2022	10/2025
Directional Coupler	Krytar 158020	131467	Characterized prior to test. No cal required.	Characterized prior to test. No cal required.
Temperature / Humidity Sensor	Testo 184 H1	44225320	06/2021	06/2024

<Justification of the extended calibration>

If dipoles are verified in return loss (<-20dB, within 20% of prior calibration for below 3GHz, and <-8dB, within 20% of prior calibration for 5GHz to 6GHz), and in impedance (within 5 ohm of prior calibration), the annual calibration is not necessary and the calibration interval can be extended.

<Head 2450MHz>

S11 parameter (dB)	Delta (%)	Impedance	Delta(ohm)	Date of Measurement
-29.27	-	53.60	-	Feb. 21, 2024

The return loss is <-20dB, within 20% of prior calibration; the impedance is within 5 ohm of prior calibration. Therefore the verification result should support extended calibration.

<Head 5200MHz>

S11 parameter (dB)	Delta (%)	Impedance	Delta(ohm)	Date of Measurement
-9.64	-	25.80	-	Feb. 21, 2024

The return loss is <-8dB, within 20% of prior calibration; the impedance is within 5 ohm of prior calibration. Therefore the verification result should support extended calibration.

<Head 5800MHz>

S11 parameter (dB)	Delta (%)	Impedance	Delta(ohm)	Date of Measurement
-14.91	-	38.53	-	Feb. 21, 2024

The return loss is <-8dB, within 20% of prior calibration; the impedance is within 5 ohm of prior calibration. Therefore the verification result should support extended calibration.

END