

Control Panel Description

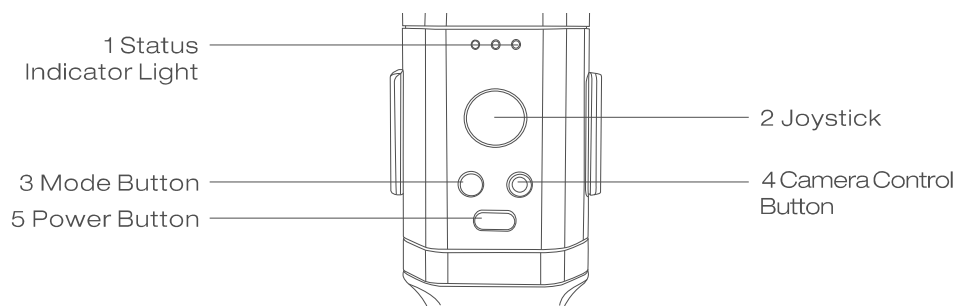

1. Status Indicator Light (Light 1, Light 2, Light 3)
When mode switches, Light 1 flashes indicating Pan Following Mode; Light 2 flashes indicating Following Mode; Light 3 flashes indicating Locking Mode.

2. Joystick
Four-way direction control of the camera/lens.

3. Mode Button
● The stabilizer enters Pan Following Mode (PF) by default each time when powered on. Switch into Following Mode (F) by single pressing on Mode Button. Single press Mode Button again to enter Locking Mode (L). Single press Mode Button under Locking Mode will return to the Pan Following Mode.
● Double press the Mode Button can make the stabilizer Tilt Axis Motor and Roll Axis Motor back to the starting position.
● Long press to quick enter the Locking Mode, release to restore the previous status.

4. Camera Control Button
● Halfway press to realize auto focus.
● Fully press to start or end video recording.
● Long press to take pictures.

5. Power Button
● Long press for 3 seconds to power on/off.
● Single press to view the battery level (one indicator light on means 30%~60% power, two indicator lights on means 60%~90% power, three indicator lights on means 90%~100% power).
When one indicator light flashes quickly means less than 30% power.
● Double press to enter or exit standby mode.
● Triple press to enter the Full-speed Following Mode.
● Quadruple press can switch the left/right control direction of the Joystick.

Combination use of buttons

Press and hold the Mode button with one hand, and double press the Power Button with another hand, when the lens is facing up, push the joystick left /right to enter the Inception mode. (360° rotation on Roll axis)

Please make sure the camera is well balanced, otherwise it can not move at a uniform speed.

Weifeng - Panasonic Camera Control Function Description (Need to switch to video mode)

Please refer to the Camera Setting Screen in APP Operation on page 27 to choose the right option for your camera.

1. Shutter release: Halfway press 4 "Camera Control Button" to realize auto focus and take single shots by long press.
2. Video recording: Fully press 4 "Camera Control Button" to start or end video recording.

Weifeng - Sony Camera Control Function Description (No need to switch to video mode)

Please refer to the Camera Setting Screen in APP Operation on page 27 to choose the right option for your camera.

1. Shutter release: Halfway press 4 "Camera Control Button" to realize auto focus and take single shots by long press.
2. Video recording: Fully press 4 "Camera Control Button" to start or end video recording.

1. For Sony and Panasonic mirrorless camera with EVF, Real-time Preview is not needed.
2. When mounting a Sony camera to the stabilizer, make sure to power on the stabilizer before the camera, otherwise the stabilizer may fail to control the camera.
3. When powering on the stabilizer, please hold the camera with one hand in case of malfunctioned rotation.
4. When powering on, avoid shaking of the stabilizer which may lead to start-up failure.
5. For a Canon camera, the button works the same way as Sony's.

MODE SWITCH

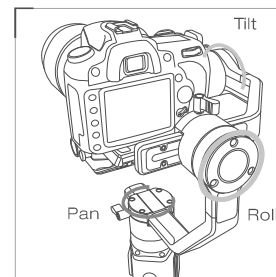
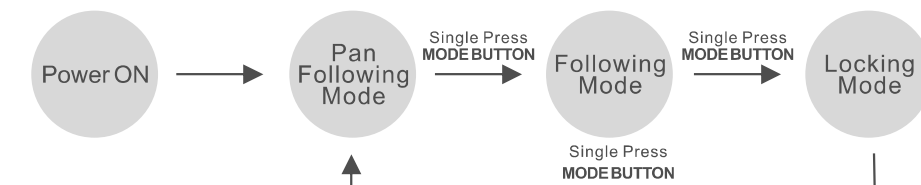

Pan Following Mode

The camera pans left/right following the movement of the stabilizer while the tilt and roll axes are locked. Push the joystick up/down allows manual control of the tilt axis. Push the joystick left/right allows manual control of the pan axis. The tilt axis can be manually positioned by default in this mode.

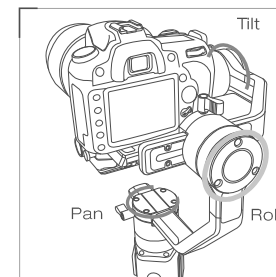

Following Mode

The camera pans and tilts following the movement of the stabilizer while the roll axis is locked. Push the joystick up/down and left/right allows manual control of the tilt axis and pan axis. Both axes can not be manually positioned in this mode.

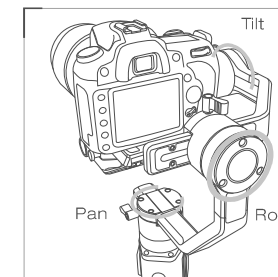

Locking Mode

This mode locks movement of all three axes to keep the camera fixed on a shooting direction. Push the joystick up/down and left/right allows manual control of the tilt axis and pan axis. Tilt and Pan axes can be manually positioned in this mode.

Manual positioning of camera

Under Pan Following Mode and Locking Mode, you can manually rotate the camera to a certain angle, then loosen your grip and the camera position will be fixed. Tilt axis angle can be manually adjusted under Pan Following Mode. Tilt axis angle and Pan axis angle can be manually adjusted under Locking Mode.

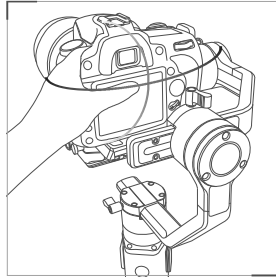

Bottom Up Mode Operation

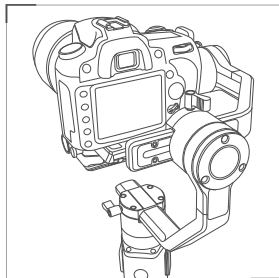

Top Down Mode

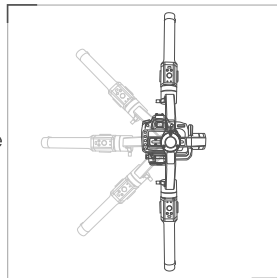

Bottom Up Mode

Please ensure balanced installation of the camera under top down mode and do not rotate or shake the handle while initiating the bottom up mode (as seen in graph).
Note: The size of the camera and its balance condition when mounted may affect the successful access to Bottom Up mode. For certain camera models, balance should be adjusted after access to Bottom Up mode.

APP Download and Installation

For iOS: Download the APP by searching "weifeng" in APP Store (iOS 9.0 above required).

For Android: Download the APP by searching "weifeng" in Google Play or from the "CONTACT US--APP Download" page on weifeng's official website www.weifengchina.com. (Android 5.0 above required).

"weifeng" icon below for reference.



The weifeng APP is subject to regular update without notice.

Connecting the Stabilizer to Smartphone

1. Power on the Stabilizer and turn on the Bluetooth in settings of your smartphone.
2. Tap Weifeng's APP icon to open and switch to Wi-710 screen, click on the bottom to connect the stabilizer.
3. The interface lists devices that can be searched nearby, choose the device starting with Wi-710. (the next four numbers is machine serial number, which can help you tell from other devices)

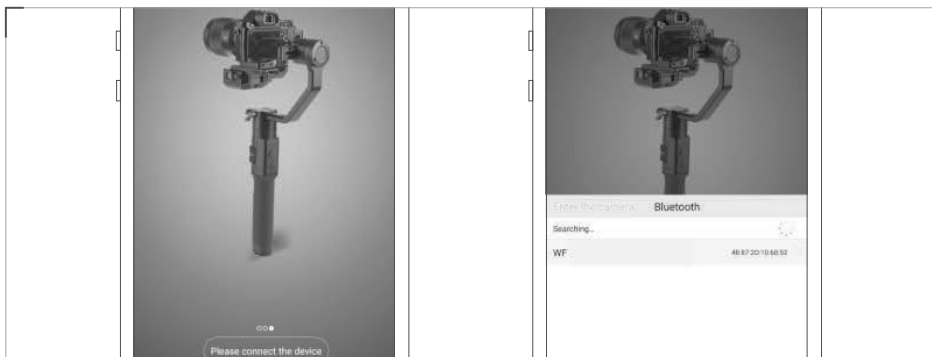

Control Screen

Stabilizer controls panel via Bluetooth.

Shortcut operation key introduction:

Bluetooth signal: view or reconnect the gimbal.

Yaw & Pitch: remote control the movement of yaw axis and pitch axis.

Roll: remote control of roll axis movement.

Photo/Video: switch between the stabilizer's photo and video modes.

Start: long press to activate the Gimbal.

Return center: the Gimbal can soon back to the starting position. (the Tilt Axis and Roll Axis return to the horizontal position, and the pan axis returns to the mechanical zero position)

Time-lapse: click to enter the Time-lapse screen quickly.

Standby: long press to enter the Standby Mode.



Setting Screen

Allows adjustment of various parameter settings of the stabilizer. Mainly camera brand selection and Gimbal setting

1.Camera Setting Screen: enable to select the camera model that needs to be connected. (see more on page 15-Weifeng Camera Control Cable Description)
The supported camera models and functions are in continuous development, try out to discover more at our official website.

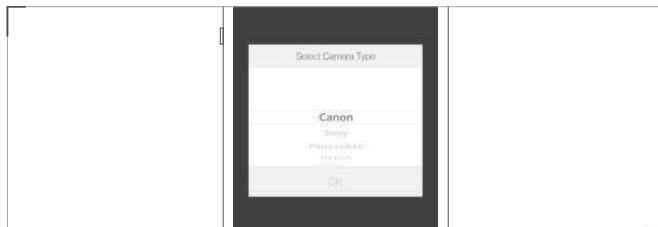

2.Gimbal Setting Screen: The Gimbal parameter can be adjusted by camera model (4 levels: Ultralow/Low/Medium/High)
On the premise of well mechanical balance and without shaking, the higher the better, factory default is Ultralow. The recommended parameters that are compatible with the camera models and lens will be updated later.

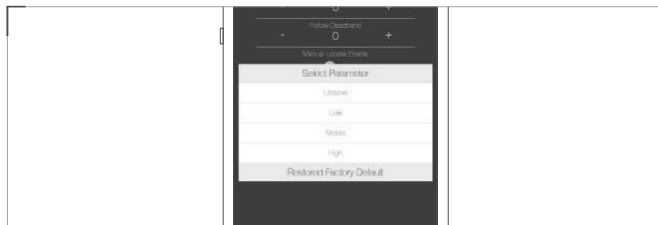

Setting Screen

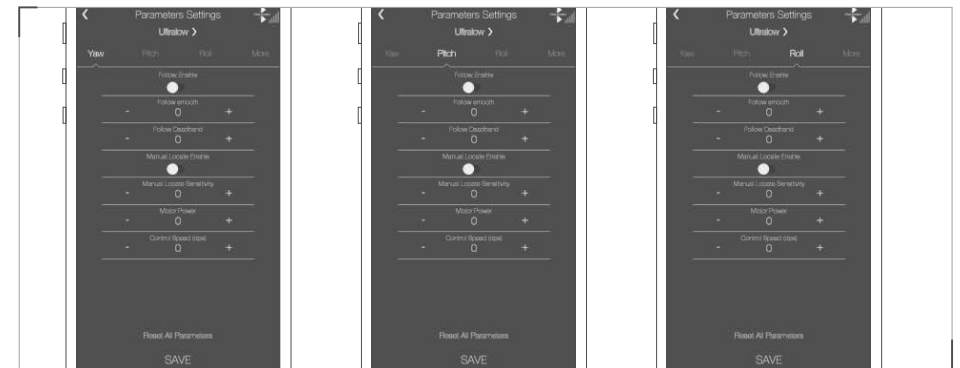

- 1.Ultralow:click to select the recommended parameters according to the camera weight and center of gravity.
- 2.Reset: reset all parameters including the tilt axis, pan axis, roll axis and Dreamy Rotation Mode.(Remember to save after reset)
- 3.Save: after adjusting the parameters, please make sure to click the save button to solidify the parameters into the gimbal.

The three axes in the middle of the Setting Screens can be adjusted separately. Here, take the pan axis parameter as an example.

- 1.Follow enable: a switch that controls the current axis following function, note the distinction with the three shortcut following modes(locking mode, pan following mode and following mode).
The following functions of the three axes can also be matched freely if you want more creative shooting.

Setting Screen

2. Follow smooth: (0~100)the larger the more sensitive it is.
3. Follow deadband: here refers the size of an area in the middle that does not respond to external actions under following mode. It is recommended to set about 5.
4. Manual locate enable: controls whether the current axis can be manually positioned.
5. Manual locate sensitivity: the larger the less sensitive, it is recommended to set about 5.(If it is too small, the external resistance under strong action may be mistaken for manual positioning, which may cause unnecessary trouble)
6. Motor power: (0~100)represents the output force of the current motor.
7. Control speed: this value sets the maximum speed that an external control can achieve. (Units: dps) (The external control here includes: the joystick on the stabilizer and APP virtual joystick)

Dreamy Rotation Mode(360° rotation on Roll axis)

Dreamy Rotation speed:This value is used to adjust the maximum speed controlled by the joystick under Dreamy Rotation Mode. (Units: dps)



Time-lapse screen

Time-lapse screen is as follow, and the updated version of time-lapse will be introduced later. (Includes camera control and multi - axis linkage with external focus control)



At present, the time-lapse mainly controls the tilt axis and pan axis.

1. Set the camera parameters according to the current environment.
2. Connect the camera to the stabilizer using the camera control cable. It is recommended to readjust the mechanical balance after proper connection.
3. Set the shutter interval , photo interval, frame rate and the total shooting time.
4. Select the shooting path: confirm a keyframe and click to add, after all key frames are selected, tap "preview" to confirm and click to start time-lapse photography.
5. The gimbal will stop at the last key frame position after shooting.

Time-lapse screen

6. The gimbal has two moving modes: sharp mode and smooth mode, that is the path form of gimbal movement.
7. Quit: stop the running of time-lapse photography.
8. Repeat: automatically load and repeat the last movement.

Calibration Screen

Calibration is required when deviations are found in the 3 axes and the leveling of the camera.

When do you need to calibrate the stabilizer?

Please calibrate the stabilizer when necessary to ensure normal use.

When	How
<ol style="list-style-type: none"> 1. Slight deviation is found in the tilt angle of the camera in level position after startup. 2. Slight deviation is found in the roll angle of the camera in level position after startup. 3. Frequent small angle correction is found when the camera is in level position while the stabilizer stays still. 4. Slight deviation is found in level position after the initialization of the stabilizer. 5. Stabilizer unused for a long time. 6. Too large temperature difference between operation environments. 	Gyro Acceleration

Initialization Method

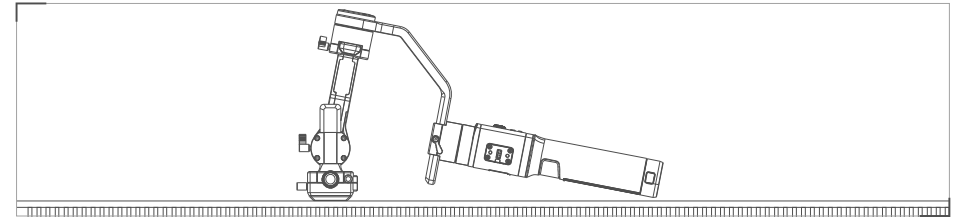

1. Correctly install the batteries.
2. Hold the camera mounting plate with one hand, long press the Power button to start up the stabilizer; Double press the Power button to enter the standby mode (holding the camera mounting plate through the whole process in case of start-up failure).
3. Complete the calibration procedure following onscreen illustrations. (Make sure the stabilizer is posed still on a flat surface).

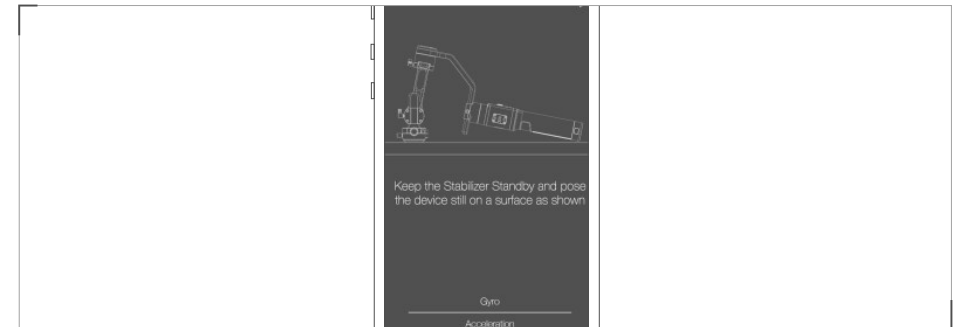

If the angle deviation still persists after the initialization, please try again following the procedure.

Firmware Upgrade

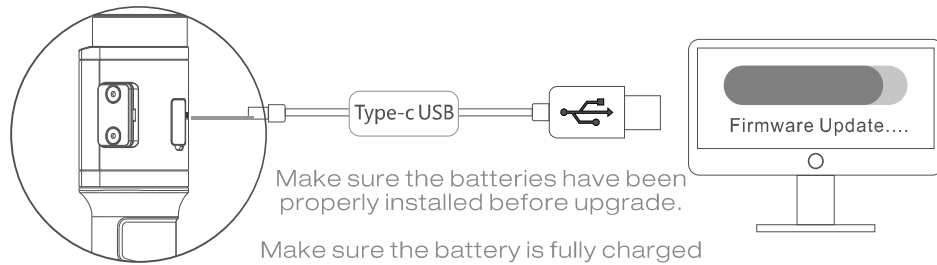

1. Press and hold the Mode Button, press the Power button with another hand to enter the Boot mode(the three indicator lights keep flashing synchronously).
2. Connect the stabilizer to your computer via Type-C USB cable, power on the computer, and the following screen appears.

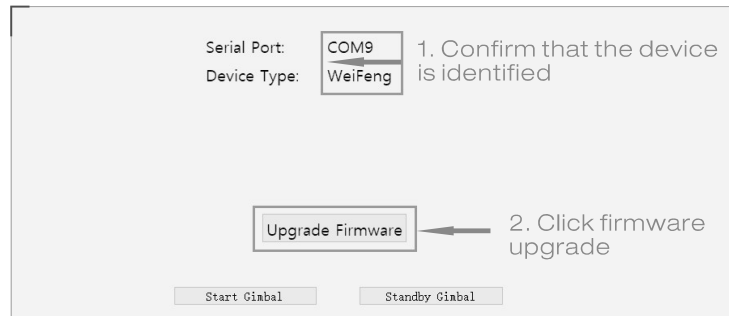

Firmware Upgrade

Enter the upgrade interface, as shown in the figure below, confirm that it is online (whether the Hardware version is displayed).

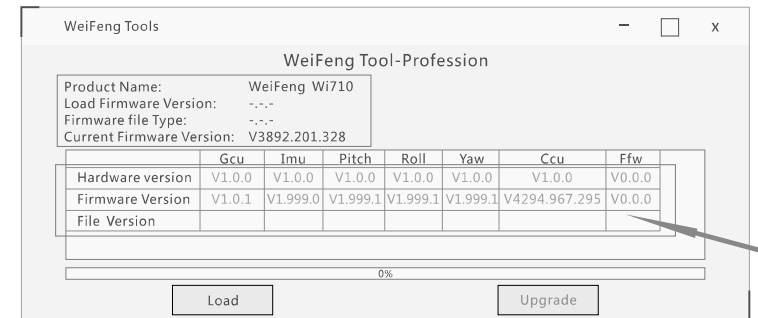

3. Load corresponding firmware(format:WT710 V1.0.0 user.wf)

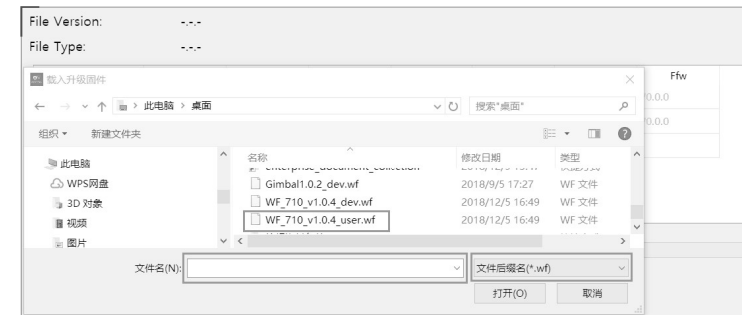

Firmware Upgrade

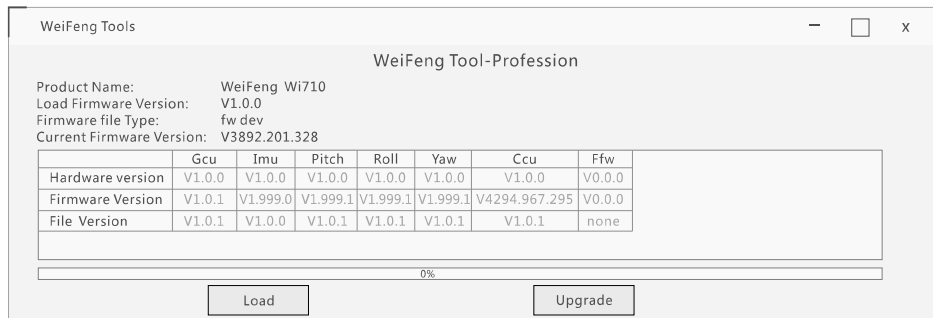

Click upgrade: upgrade progress will appear. After completion, close the software and restart the stabilizer

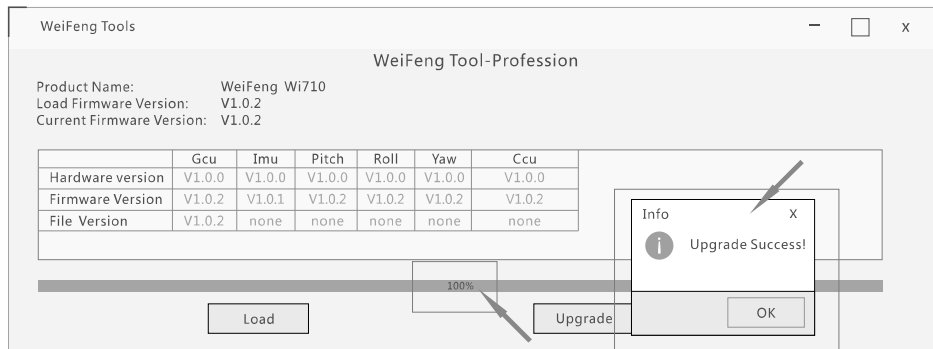

Product Specifications

	Min.	Standard	Max.	Remarks
Input Vol.	11.2V	14.8V	16.8V	
Operation Current	150mA		7600mA	
Operation Temperature	-10°C	+25°C	+45°C	
Operation Time	12h		18h	Static operation under proper balance
Charging Time		6h		Charging current 4x400mA Excluding batteries
Weight		1470g		
Tilt Angle Range		360°		Unlimited rotation
Roll Angle Range		360°		Unlimited rotation
Pan Angle Range		360°		Unlimited rotation
Following Deviation in Static State	±0.01°		±0.03°	
Following Deviation in Motion State	±0.05°		±0.1°	
Payload	500g		3600g	
Compatible Camera Sizes	The max. horizontal length from the point of camera gravity to the roll axis is 90mm, from the 1/4" threaded hole to tilt axis 90mm, and from gravity point to quick release plate 70mm.			
Product Dimension	192mmx79mmx460mm			

Warranty Card

Warranty period Statement:

1. Customers are entitled to replacement or free repair service in case of quality defects found in the product within 15 days upon receipt of the product.
2. Customers are entitled to free repair service for any product proven defective in material or workmanship that results in product failure during normal consumer usage and conditions within one year from the date of purchase.

This warranty does not apply to the following:

1. Products subjected to unauthorized repair, misuse, collision, neglect, mishandling, soaking, accident, and unauthorized alteration.
2. Products subjected to improper use or whose labels or security tags have been torn off or altered.
3. Products whose warranty has expired.
4. Products damaged due to force majeure, such as fire, flood, lightning.

To obtain the warranty service, please follow these steps:

1. If failure or any problem occurs to your product after purchase, please contact a local agent for assistance. If there is no local agent, you can always contact our customer service through email or website.
2. Your local agent or customer service will guide you through the whole service procedure regarding any product issue or problem you have encountered.
3. Weifeng reserves the right to reexamine damaged or returned products.

Customer Information

Customer Name	Contact No.
Address	

Sales Manager

Sales Date	Dealer
Dealer Contact No.	

#1 Maintenance Record

Service Date	Signature of Repairman
Cause of Problem	
Service Result: <input type="checkbox"/> Solved <input type="checkbox"/> Unsolved <input type="checkbox"/> Refunded/ Replaced	