

HPRT

Thermal Receipt Printer

TP808

User Manual

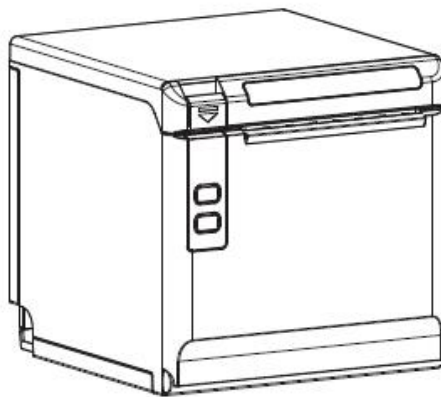

Manufacturer: Xiamen Hanin Electronic Technology Co., Ltd.

E-mail: support@hpert.com

Web: www.hpert.com

Content

Statement.....	1
Important Safety Instructions.....	2
1 OVERVIEW.....	4
1.1 Introductions.....	4
1.2 The Main Features.....	4
2 GETTING STARTED.....	5
2.1 Packing List.....	5
2.2 Appearance and Components.....	6
3 SPECIFICATION.....	7
3.1 Printer Specification.....	7
3.2 Printing Media Specification.....	9
3.2.1 Continuous Thermal Paper Specification.....	9
3.2.2 Notices.....	9
3.3 Printing and Cutting Position.....	10
3.3.1 Printing position.....	10
3.3.2 Cutting Position.....	10
4 INSTALLATION AND USAGE.....	11
4.1 Media Loading.....	11
4.1.1 Paper Confirmation.....	11
4.1.2 Paper Installation (Forward Paper-out Direction).....	11
4.2 LED Indication and Beeper.....	12
4.3 Power Connection.....	13
4.4 Interface Cable Connection.....	15
4.5 Cash Drawer Connection.....	15
4.6 Bluetooth/Wi-Fi Settings.....	15
4.6.1 Bluetooth Settings.....	15
4.6.2 Wi-Fi Settings.....	16
4.7 Print Test.....	16
4.7.1 Print Self-Test.....	16
4.7.2 Printing of Windows Driver Program.....	16
5 INTERFACES.....	17
5.1 USB.....	17
5.2 Serial Interface.....	18
5.3 Ethernet Interface.....	19
5.4 Cash Drawer Interface.....	20
5.5 Power Supply Interface.....	21
6 TROUBLESHOOTING.....	22
6.1 Printer Not Working.....	22
6.2 LED Indicator and Beeper.....	22
6.3 Troubles Occur During Printing.....	22
6.4 Problems Emerge During the Paper Cutting.....	23
6.5 Removing Jammed Paper.....	23
7 PRINTER CLEANING AND MAINTENANCE.....	24
7.1 Cleaning Head.....	24
7.2 Cleaning Sensors, Roller and/or Paper Path.....	24

8	DOWNLOAD SOFTWARES FROM HPRT WEBSITE.....	25
9	UTILITY TOOL FOR POS INSTRUCTION.....	26
9.1	Utility Tool Installation.....	26
9.2	Utility Tool Using.....	31
9.2.1	Add/Modify/Delete/Connection Printer.....	31
9.2.2	Functions.....	38
9.3	Firmware Update.....	81
10	WINDOWS DRIVER.....	83
10.1	Information.....	83
10.2	Operating System (OS) Environment.....	83
10.3	Windows Driver Preparation.....	83
10.4	Windows Driver Installation.....	84
10.5	Detailed Windows Driver Setting.....	88
10.5.1.	Printing Preferences.....	88
10.5.2.	Other Settings.....	122
10.6	Uninstall Windows Driver.....	125
10.7	Specification.....	127
APPENDIX.....		128
FCC-DECLARATION OF CONFORMITY.....		128
EC DECLARATION OF CONFORMITY.....		130

Statement

This manual content may be altered without permission, and Xiamen Hanin Electronic Technology Co., Ltd. reserves the rights to make changes without notice in technology, spare parts, hardware and software of the products. If more information is needed about the products, please contact Xiamen Hanin Electronic Technology Co., Ltd. Without any written permission from the company, any section of this manual is prohibited to be copied or transferred in any form.

Copyright

This manual is printed in 2022, the copyright belongs to Xiamen Hanin Electronic Technology Co., Ltd.

Printed in China

Version 1.0

Warnings



This must be complied with in order to avoid any damage to the human body and to the equipment.



This is showing the important information and tips for the printer operating.



Note:

Due to continuous update of product, please take in kind of real machine, such as accessories, programs etc.

Important Safety Instructions

1. Safety Warning



Warnings: The print head will become very hot during printing; avoid contact with the print head after printing has finished.



Warnings: Do not touch the printer head and connector in case static damage the printer head.

2. Instructions

Carefully read the installation and operating instructions provided with the printer before starting up your printer.

- 1) Place the printer on a flat and stable surface.
- 2) Leave enough space around printer for operation and maintenance.
- 3) Do not place the printer on or near a heat source.
- 4) Do not use the printer near water. Never spill liquid into the printer.
- 5) Do not expose the printer to high temperatures, direct sunlight or dust.
- 6) Protect the printer from shock, impact and vibration.
- 7) Be certain the power source is within the voltage rating and frequency listed for the printer.
- 8) Switch off the printer power supply when won't use it for a long time.
- 9) Do not place the power cord where it can be stepped on. If the power cord becomes damaged or frayed, replace it immediately.
- 10) To ensure the print quality and reliability, you are suggested to use the recommended paper or the same quality paper.
- 11) Please switch off the power supply when connect/disconnect all the ports or it will cause damage to the printer control circuit.
- 12) Never carry out maintenance or repair work yourself. Always contact a qualified service technician.
- 13) Keep this User Manual in a place which is easily accessible at all times.

3. Other Precautions

The copyright for this user manual and various other manuals is property of our company. Any copying or conversion into electronic form and saving of this material without the express written permission is strictly prohibited. Use of the information contained in this manual is not subject to any patent liability. This manual has been prepared with utmost care and attention to detail but may contain certain errors and/or omissions. Our company is not legally liable for any damages resulting from the use of the information in this manual. Our company and its affiliates are not legally liable (United States excluded) for any damages, loss, costs, and/or expenses that result from the breakdown, malfunction, and/or misuse of the product due to violation or neglect of the operation and maintenance information and instructions provided by our company, as well as from the unauthorized alteration, repair, and/or modification of the product by the user and/or third party. We are not legally liable for any damages and/or issues resulting from the use of options and/or parts that are not authentic or authorized products.

4. WEEE (Waste Electrical and Electric Equipment)

This information only applies to customers in the European Union, according to Directive 2012/19/EU OF THE EUROPEAN PARLIAMENT AND OF THE COUNCIL OF 04 July 2012 on waste electrical and electronic equipment, and to customers in countries in Europe, Middle East and Africa (EMEA) where they have implemented equivalent regulations.



For other countries, please contact your local government to investigate the possibility of recycling your product.



Note: The product needs to be reliably earthing after being powered on.

FCC ID : 2AUTE-TP808P



1 OVERVIEW

1.1 Introductions

TP808 is a thermal receipt printer, featured by high print quality, high print speed, high stability, etc. It can be used in commercial POS system, food industry and occasions which need real-time field print receipts.

TP808 can connect with other equipment through serial/USB/Ethernet/Wi-Fi/Bluetooth interfaces. And the printer drivers are available for the WINDOWS XP/WINDOWS 7/WINDOWS 8/WINDOWS 10/Linux operating system.

1.2 The Main Features

- 1) Low noise
- 2) High print speed
- 3) Easy paper loading
- 4) Support page mode printing
- 5) Compatible with various width paper
- 6) Cash drawer interface
- 7) Communication interfaces optional

2 GETTING STARTED

2.1 Packing List

After receiving your printer, please check for possible shipping damage:

1. Inspect the outside of both the box and the printer for possible damage.
2. Check whether you have received the following accessories together with the printer, if there are any items missing, please contact your local dealer.

■ Standard Accessories

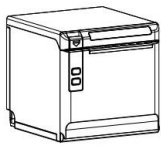

Printer

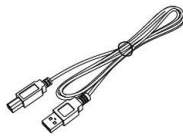

USB Cable

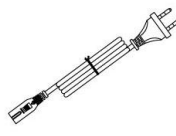

Power Cord



Power Adapter



Roll Paper



Quick Start Guide

■ Optional Accessories

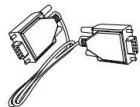

Serial Cable



Notes:

- 1) The power adapter and power cord vary by country or region.
- 2) Items in the package are dependent on the actual order.

2.2 Appearance and Components

■ Front

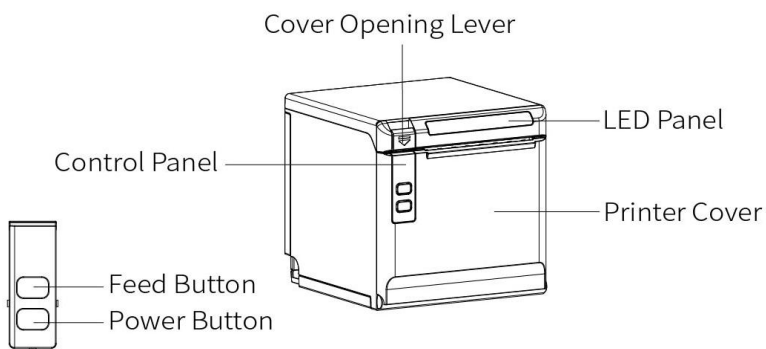

■ Inside

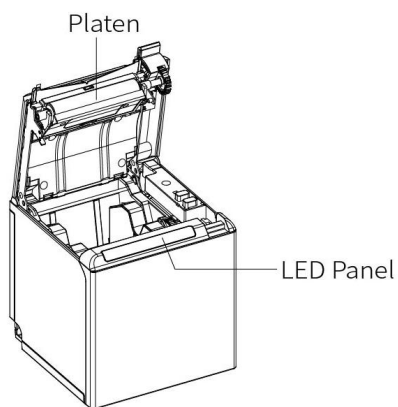

■ Rear

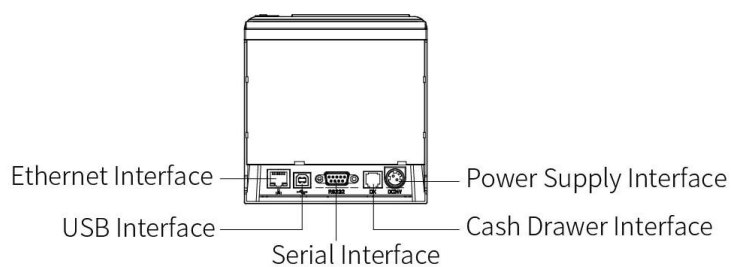

Note: Wi-Fi and Bluetooth interfaces are embedded in the printer.

3 SPECIFICATION

3.1 Printer Specification

Table3-1 General Specification

(1/2)

Item		Parameter
Printing Parameter	Printing Method	Direct thermal line printing
	Resolution	203DPI, 8dots/mm
	Printing Width	72mm
	Print Speed	Max. 260mm/s
	Interface	USB, Serial, Ethernet, Cash drawer, Wi-Fi, Bluetooth
	Print density	Adjustable from level 1 to level 4
Page Mode		Support
Memory	RAM	4Mbyte
	Flash	4Mbyte
Fonts	Chinese	GBK 24×24
	Alphanumeric	ASC II 9×17, 12×24.
	User-defined	Support
	Code page	Optional international character sets: PC437(std.Europe), Katakana, PC850(Multilingual), PC860(Portuguese), PC863(Canadian), PC865(Nordic), PC857(Turkish), PC737(Greek), ISO08859-7(Greek), WPC1252, PC866(Cyrillic #2), PC852(Latin 2), PC858(Euro), KU42(Thai), TIS11(Thai), TIS18(Thai), PC720(Arabic), WPC775(Baltic Rim), PC855(Cyrillic), PC862(Hebrew), PC864(Arabic), ISO8859-2(Latin2), ISO8859-15(Latin9), WPC1250(Latin 2), WPC1251(Cyrillic), WPC1253(Greek), WPC1254(Turkish), WPC1255(Hebrew), WPC1256(Arabic), WPC1257(Baltic Rim), WPC1258(Vietnamese), MIK(Cyrillic), PC755(Latin 2), Iran, Iran II, Latvian, ISO-8859-1(WestEur), ISO-8859-3(Latin 3), ISO-8859-4(Baltic), ISO-8859-5(Cyrillic), ISO-8859-6(Arabic), ISO-8859-8(Hebrew), ISO-8859-9(Turkish), PC856, PC3848(ABICOMP), MONGOLIAN, VISCII

Table3-1 General Specification(Continued)

(2/2)

Item		Parameter
Barcode	1D	UPC-A, UPC-E, EAN8, EAN13, CODE39, ITF, CODABAR, CODE128, CODE93
	2D	PDF417, QR code
Graphics		Support varied density bitmap and download bitmap printing Max size of each bitmap is 40K, the total size of bitmap is 256k.
Detection	Sensors	Paper out detection, Cover open detection
LED Indicator	Power LED	Blue
	Paper LED	Orange
	Error LED	Red
Power Supply	Input	AC100V-240V
	Output	DC24V, 2A
Paper	Paper type	Specified Thermal Paper
	Paper width	58 ⁺⁰ ₋₁ mm/80 ⁺⁰ ₋₁ mm
	Paper thickness	0.056 ~ 0.13mm
	Roll paper diameter	Max. OD φ83mm
	Paper load	Easy-loading structure of forward open cover or upward open cover
	Paper cut	Partial cut / full cut
Physical Spec.	Operating condition	0°C ~ 50°C, 20% ~ 85%RH
	Storage condition	-20°C ~ 70°C, 5% ~ 95%RH
	Dimensions	137.3(L)*132(W)*130.5(H)mm
	Weight	1.33kg
Command		ESC/POS
Software	Driver	Win7/Win8/Win10/Linux CUPS/OPOS/JavaPOS
	SDK	Android, iOS
Agency Approvals		FCC, CE

3.2 Printing Media Specification

3.2.1 Continuous Thermal Paper Specification

Paper Type : Specified Thermal Paper

Paper Width : 58^{+0}_{-1} mm / 80^{+0}_{-1} mm

Paper Outer Diameter : Max. 83 mm

Paper Thickness : 0.056 ~ 0.13m

Paper Type	Manufacturer
FD210,PD150R,PD160R	OJI Paper CO.,LTD.

3.2.2 Notices



Notes:

- 1) Please use the recommended thermal paper or same quality paper, otherwise it will influence the printing quality and decrease the thermal printer head life;
- 2) Don't stick the paper on the roll paper mandril;
- 3) If the thermal paper is polluted by chemical or oil, the thermal paper heat sensibility decreases, which will influence the printing quality;
- 4) Don't use finger nail or hard articles to touch the surface of thermal paper, otherwise it will cause color fading;
- 5) When the environment temperature is higher than 70°C, the thermal paper color will fade, so pay attention to the influence of temperature, humidity and sunlight.

3.3 Printing and Cutting Position

3.3.1 Printing position

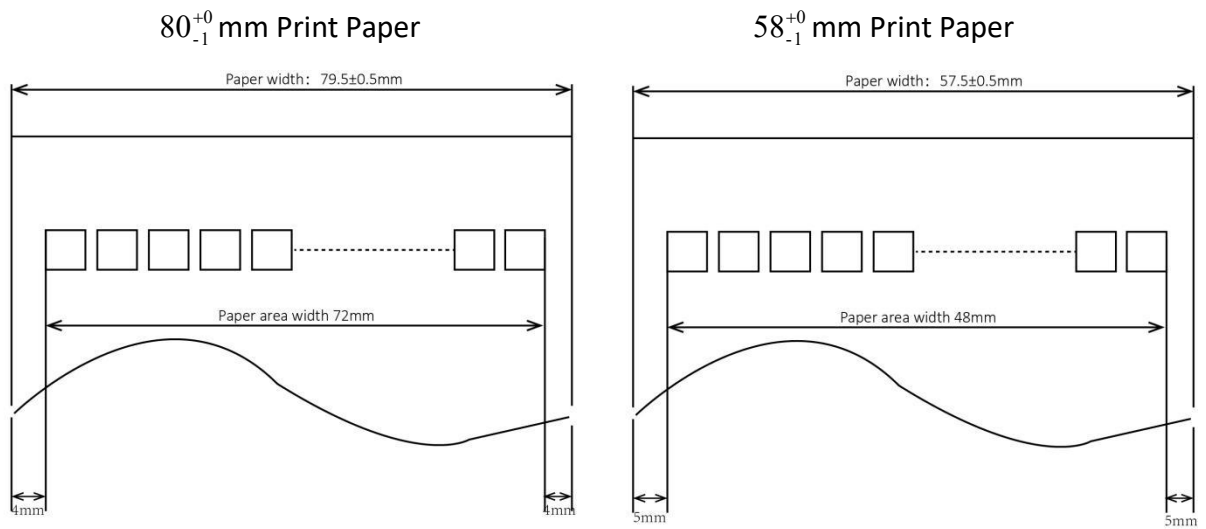

3.3.2 Cutting Position

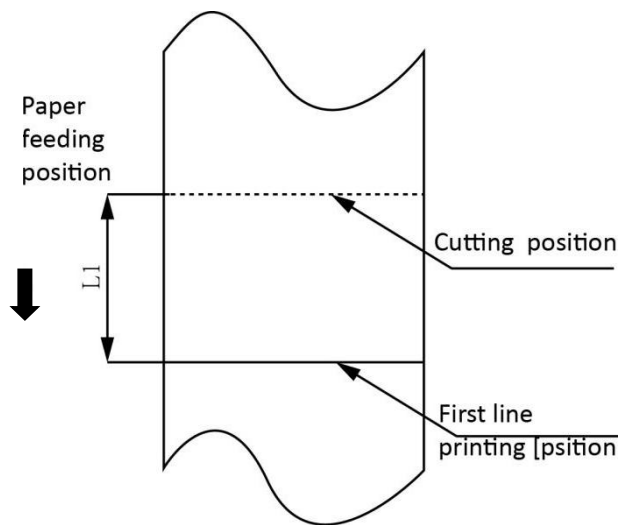

Type	Paper Cutting Position(L1)
TP808	11.6mm

4 INSTALLATION AND USAGE

4.1 Media Loading

4.1.1 Paper Confirmation

- 1) When using 80mm(width) roll paper, take down the paper guide of both sides.
- 2) When using 58mm(width) roll paper, insert the paper guide to each side.

Note: Roll paper should be placed in the middle.

4.1.2 Paper Installation (Forward Paper-out Direction)

- 1) Pull the cover opening lever to open the printer cover.

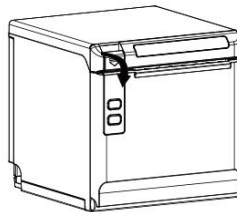

- 2) Load the roll paper in the correct direction as shown below.

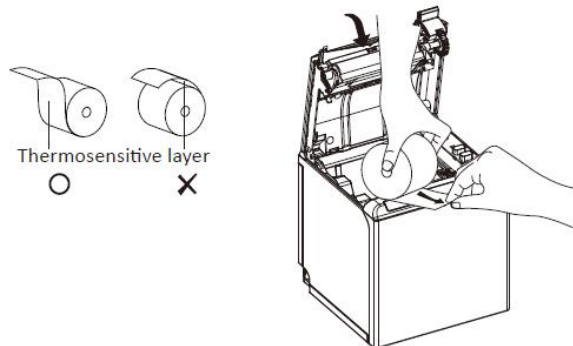

- 3) Pull out some roll paper, and close the printer cover.

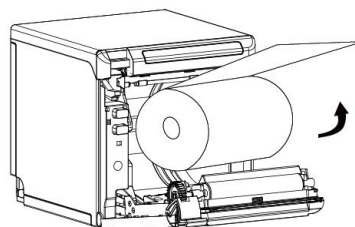

4) Tear the extra paper in the direction of printer.

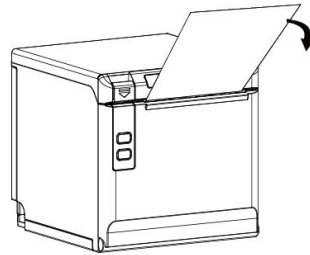

Notes:

- 1) According to the paper size to adjust the paper guide;
- 2) Make sure the paper inside is at tight status, or it will cause paper jam or other trouble.

4.2 LED Indication and Beeper

Function specification of indicated light and beeper.

Name	Status	Specification
POWER LED (Blue)	ON	The printer works well
	OFF	The printer does not work
ERROR LED (Red)	Flashing	The printer is in an error state
	OFF	The printer is in an normal state
PAPER LED (Orange)	ON	The printer is in paper end state
	OFF	The printer is in an normal state

Description	POWER LED	ERROR LED	PAPER LED	Beeper
Open the cover of printer	ON	ON	ON	"Beep, Beep—, Beep"
Full of paper	ON	OFF	OFF	Silent
No paper	ON	ON	ON	"Beep Beep Beep".
Cutter jam	ON	Flash	OFF	"Beep—, Beep—"



Notes:

The printer uses a thermistor to detect the temperature of the print head. If the temperature of print head is more than 65°C, printer will send a warning. If the temperature of print head is more than 80°C, printer will stop working until the temperature is less than 60°C.

4.3 Power Connection

- 1) Connect power adapter to printer;
- 2) Connect power adapter to power cord;
- 3) Plug the other side of power cord into the socket outlet.

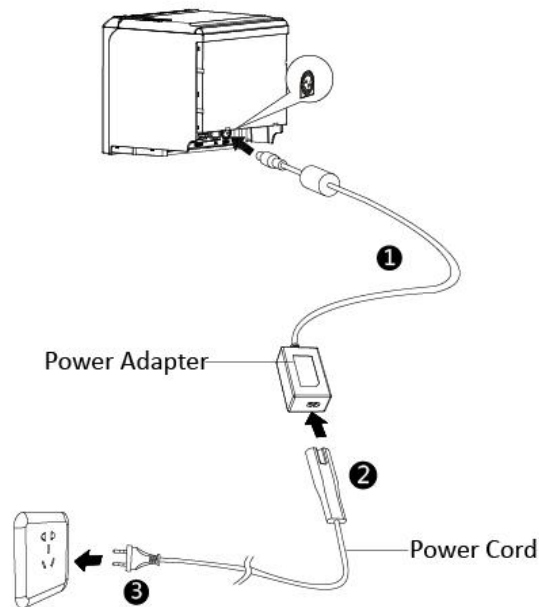

Pay attention about disconnecting or connecting the power adapter at right method, or it's easy to cause damage.

When pull out the adapter, please pinch the shell of power adapter and pull the switch up, when the switch is fully open, pull out the power adapter.

Don't pull the plug hard by squeezing at any other place of power adapter. Because it is difficult to pull it out and easy to damage the cable.

**Notes:**

- 1) Please only use the power adapter recommended by supplier or equivalent products;
- 2) When disconnecting the power adapter plug, hold plug connector housing, and avoid pulling the cable directly;
- 3) Avoid dragging the power adapter cable, otherwise it will damage the cables, causing fire and shock;
- 4) Avoid putting power adapter around a heating device, otherwise the cable may melt, causing fire and shock;
- 5) If you do not use the printer in a long time, disconnect the power supply of printer power adapter.

4.4 Interface Cable Connection

- 1) Make sure the printer's power switch is turned off;
- 2) Put the interface cable into the matched interface and fixed with screws (or spring) on the plug;
- 3) Connect the other end of the interface cable to the host.

4.5 Cash Drawer Connection

- 1) Make sure the printer's power switch is turned off;
- 2) Connect the cash drawer cable into the cash drawer interface on the rear side of the printer.



Warning:

Cash drawer interface can only be connected to a voltage of 24V cash drawer device (can't connect to the phone line, etc.)

4.6 Bluetooth/Wi-Fi Settings

4.6.1 Bluetooth Settings

Default name: BT Printer

Default password: 0000 or 1234

Please refer to the *Bluetooth Connection Manual* for details



QR code for *Bluetooth Connection Manual*

4.6.2 Wi-Fi Settings

Printer factory default Wi-Fi mode is AP mode with IP address “192.168.1.1” and SSID “POS_WIFI”. After the PC or mobile phone is connected with printer successfully, users can set the parameters through utility tool.

Please refer to the *Wi-Fi Operation Manual* for details



QR code for Wi-Fi Operation Manual

4.7 Print Test

4.7.1 Print Self-Test

The self-test checks the printer’s current settings, status and whether the printer has any problem.

- 1) Make sure the power is connected and paper is loaded properly.
- 2) Make sure the printer is off and top cover is closed properly.
- 3) Press the paper feed button and power button simultaneously to turn the printer on. The printer is ready to receive data as soon as it completes the self-test.

4.7.2 Printing of Windows Driver Program

- 1) Install the Windows Driver program. (Please refer to the *Windows Driver Manual*)
- 2) Please set the “Interface” as the type you use.
- 3) Use the Windows Driver Program to print out the “Print Test Page”.

5 INTERFACES

TP808 supports cash drawer interface and many other various communicate interfaces, such as Serial interface, USB interface, Ethernet interface, Wi-Fi and Bluetooth interfaces.

5.1 USB

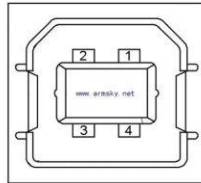

Figure 5-1

PIN	SIGNAL NAME
1	VBUS
2	D-
3	D+
4	GND

5.2 Serial Interface

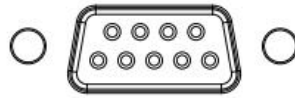
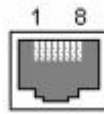

Figure 5-2

PIN	SIGNAL NAME
1	-
2	TXD
3	RXD
4	-
5	GND
6	RTS
7	CTS
8	RTS
9	-

5.3 Ethernet Interface



PIN NO.	Signal Name
1	TX+
2	TX-
3	RX+
4	-
5	-
6	RX-
7	-
8	-



Note: The printer is equipped with an Ethernet interface, and use the network connection router, switch and other network communication equipment which meet RJ45 interface standard. When connecting directly with PC, it is suggested that the cross network line in accordance with RJ45 interface standard should be adopted.

5.4 Cash Drawer Interface

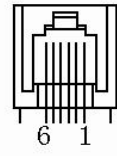

Figure 5-4

PIN NO.	Signal Name
1	FG
2	Drawer 1
3	DRSW
4	VDR
5	Drawer 2
6	GND

Electrical characteristics

- Driving voltage: DC 24 V
- Driving current: Maximum 0.8 A (In 510 ms)

Drawer check signal: “L” = 0 ~ 0.5 V “H” = 3 ~ 5 V

5.5 Power Supply Interface

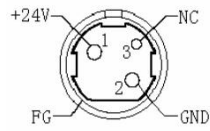

Figure 5-5

PIN No.	Signal Name
1	+24V
2	GND
3	N.C
SHELL	F.G

Printer end: Unetop DC-002 or other products of the same type.

User end: Unetop DP-002 or other products of the same type.

6 TROUBLESHOOTING

Your printer is very reliable, but occasionally problems may occur. This chapter provides information on some common problems you may encounter and how to solve them. If you encounter problems that you can not resolve, contact your dealer for assistance.

6.1 Printer Not Working

Problem Description	Probable Reason	Solution
LED does not light, printer is not working	Printer has no power	Connect printer to the power supply
	Printer is not on	Turn on the printer
	Circuit board is broken	Contact with the dealer

6.2 LED Indicator and Beeper

Problem Description	Probable Reason	Solution
Paper LED is always on	Paper near end	The roll paper is near end, the printer can work normally
Error LED is always on and beeper alarms	Printer cover is open	Close the printer cover
Paper LED and Error LED are always on and beeper alarms	Paper end	Reload the roll paper
Error LED blinks and beeper alarms	Thermal print head is overheated	Turn the printer off and resume when it cools
	Over-voltage	Print with specified voltage
	Low-voltage	Print with specified voltage

6.3 Troubles Occur During Printing

Problem Description	Probable Reason	Solution
Coloured stripe in the paper	Paper near end	Reload the roll paper
Blurred printing or spot	Incorrect roll paper loading	Check if the roll paper is installed
	Unqualified roll paper	Use recommended thermal roll paper
	Dirty thermal head or print roller	Clean the thermal head or print roller
	Low print density	Increase the print density level
Paper is not feeding normally	Paper jam	Open the printer cover, check the paper path and remove jammed paper
Vertical print words are missing	Dirty thermal head or print roller	Clean the thermal head or print roller
	Thermal head is damaged	Contact with your dealer for assistance



Note: Regarding the density of setting, please refer to "Utility Tool Manual".

6.4 Problems Emerge During the Paper Cutting

Problem Description	Probable Reason	Resolution
Cutter jam, the movable cutter cannot go back	Cutter abrasion, insufficient cutting	Replace the cutter
	Worn gear and worn wheel abrasion	Replace the worn gear and worn wheel
	Motor is burnt	Replace the motor
	Paper scraps	Clean the paper scraps on the transmission system
Insufficient cutting	Cutter edge abrasion, paper is too thick	Replace the cutter
Paper jam	Thermal printer head is over-heated	Reduce the density of printing
	Driving too fast	Reduce the printer speed to the limit of thermal printer head
	Wrong paper feeding position	Put the paper parallel with the paper mount and insert into the space between platen roller and the thermal printer head.



Note: The density of setting, please refer to "Utility Tool Manual"

6.5 Removing Jammed Paper



Warning: Do not touch the thermal print head because it becomes very hot after printing.

If the printer cover can be opened, operate it according to the next steps.

- 1) Turn off the printer and pull the deflector rod to open the print cover.
- 2) Remove jammed paper, reload the paper roll, and close the printer cover.

7 PRINTER CLEANING AND MAINTENANCE

Print quality might be degraded by dust, foreign substance, adhesive substance, or other polluted materials stuck on the printer head or inside the printer.

When printer is dirty, clean the print head as follows:

※ CAUTION

- Make sure to turn off the printer before cleaning.
- As the print head gets hot during printing, turn the printer off and wait approximately 2~3 minutes before starting cleaning.
- When cleaning the print head, take care not to touch the heated portion of the print head. Print head may be damaged by static electricity, etc.
- Avoid the print head being scratched and/or damaged in any way.

7.1 Cleaning Head

- 1) Open the Printer Cover and use the cleaning pen to clean the head in the direction from the center of the head to the edges.
- 2) After cleaning the head, do not use the printer until the alcohol used for cleaning evaporates completely (1~2 min) and the printer is absolutely dry.

7.2 Cleaning Sensors, Roller and/or Paper Path

- 1) Open the printer cover and then remove the paper.
- 2) Use dry cloth or cotton swab to remove any dust or foreign substance .
- 3) Soak the cloth or cotton swab in medical-use alcohol and use it to remove adhesive foreign substances or other polluted materials.
- 4) After cleaning the parts, do not use the printer until the alcohol evaporates completely (1~2 min) and the printer is completely dry.

※ Clean the parts whenever print quality or paper detection degraded.

8 DOWNLOAD SOFTWARES FROM HPRT WEBSITE

Under URL <http://www.hpert.com/Downloads.html>, take the following steps to download software from HPRT website:

- 1) Choose model name of product -> Choose type -> Choose system

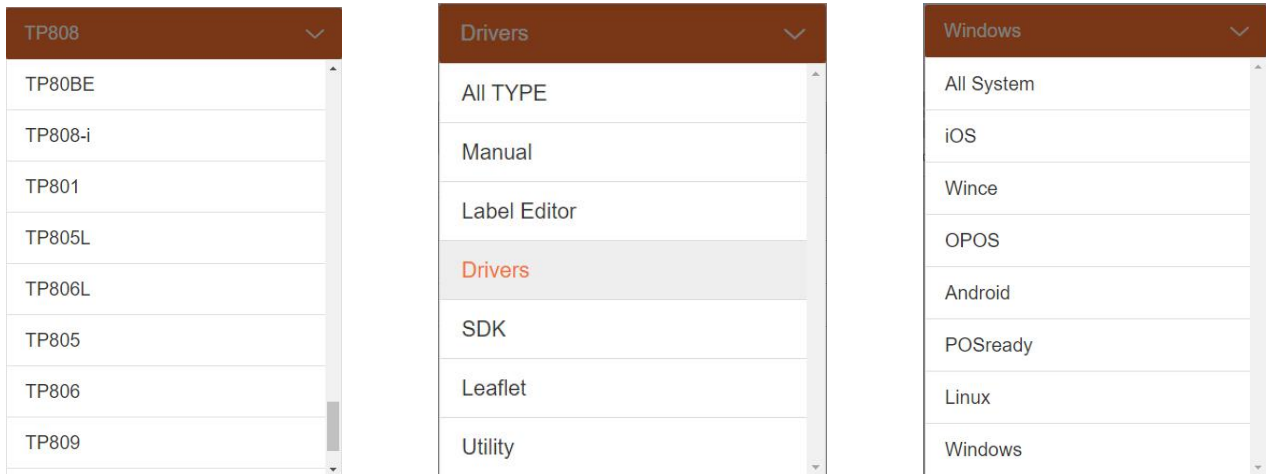

- 2) Click "download"

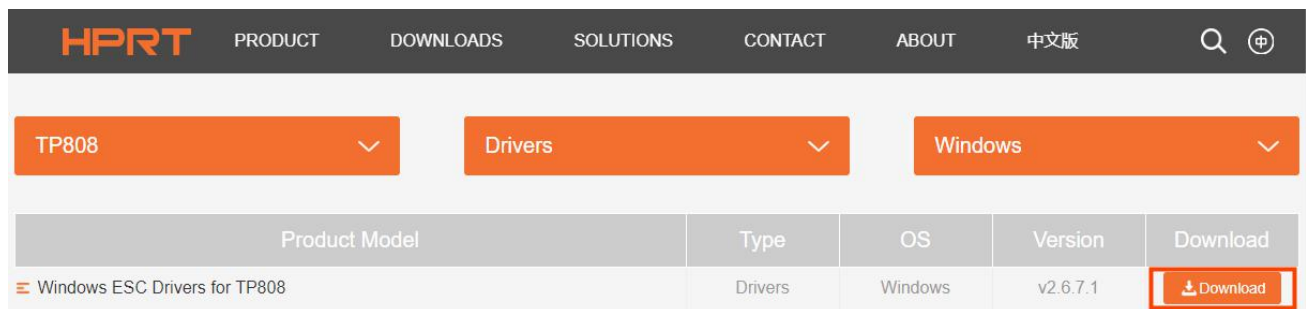

9 UTILITY TOOL FOR POS INSTRUCTION

Utility Tool is applicable to the following operating system:

- Microsoft Windows 10 (32 bit/64 bit)
- Microsoft Windows 8 (32 bit/64 bit)
- Microsoft Windows 7 SP1 (32 bit/64 bit)
- Microsoft Windows Vista SP2 (32 bit/64 bit)
- Microsoft Windows XP Professional SP3 (32 bit)
- Microsoft Windows Server 2012 (64 bit)
- Microsoft Windows Server 2008 R2

9.1 Utility Tool Installation

- 1) Open the installation package.
- 2) Choose "English" and click "OK".



3) Select destination location to install the HPRT Utility Tool. Click “Next”.

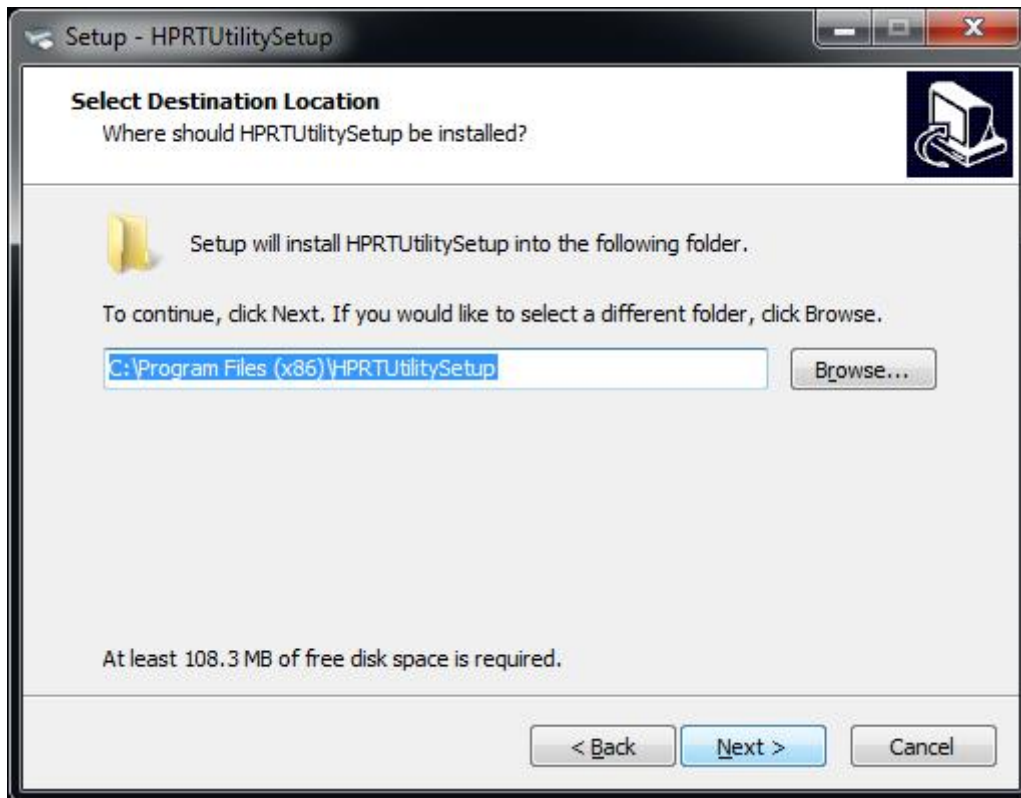

4) Select start menu folder. Click “Next”.

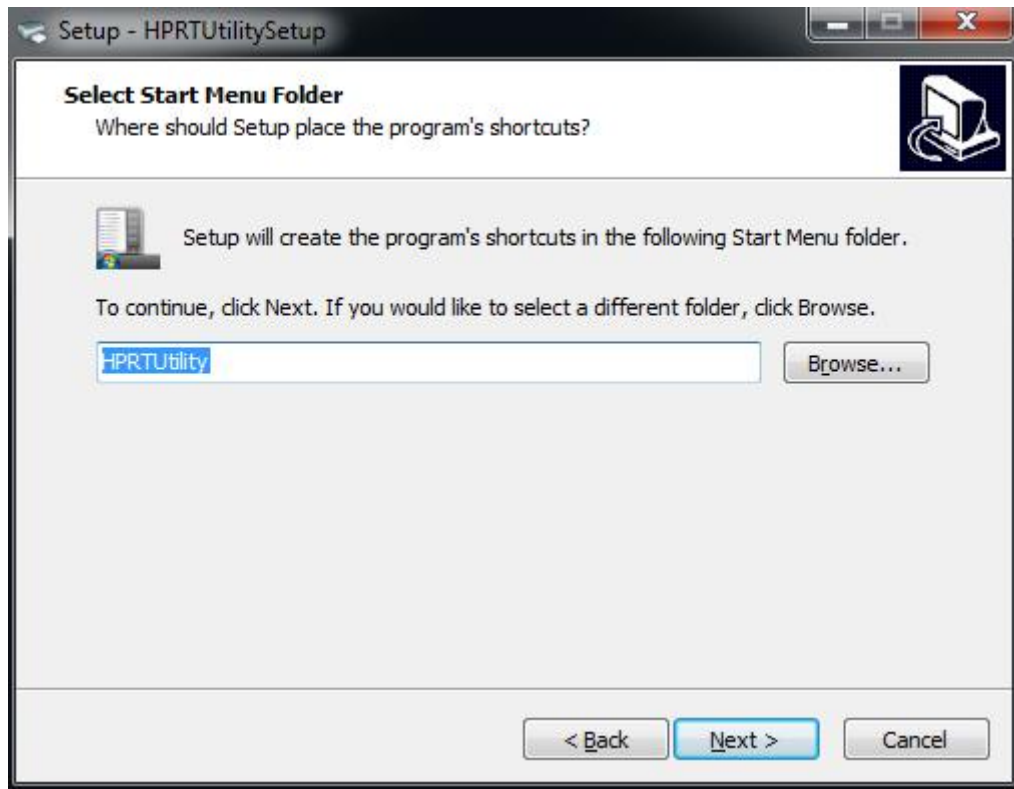

5)Click “Install”.

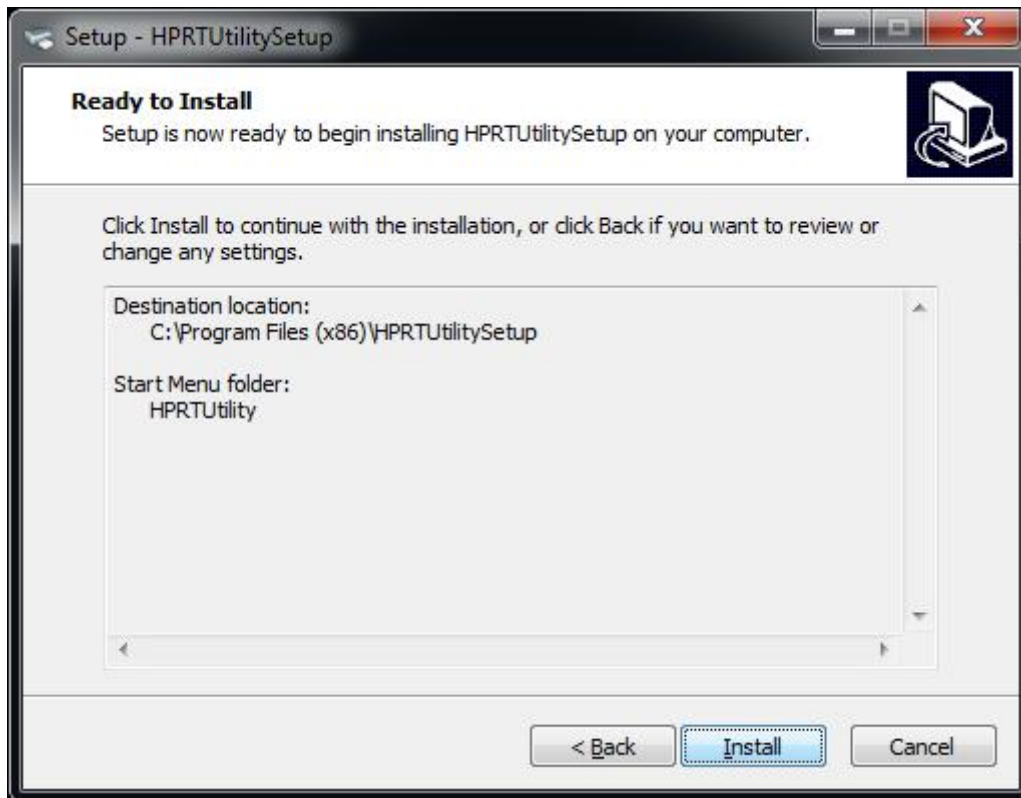

6) Click "Finish". HPRT Utility Tool is installed successfully.

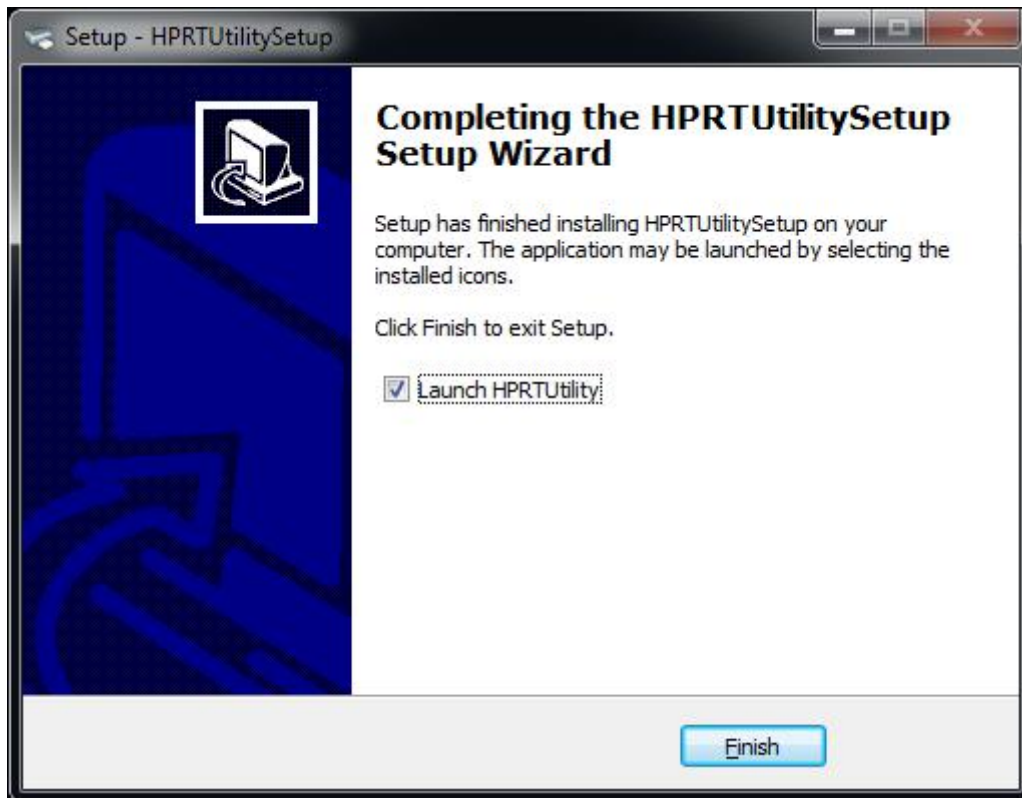

9.2 Utility Tool Using

9.2.1 Add/Modify/Delete/Connection Printer



Warning: In different operating system, screen has a little difference. Please operate it according to the tips. Take TP808 (Windows 7) for example.

- **Add printer**

1) Click “Add Printer”.

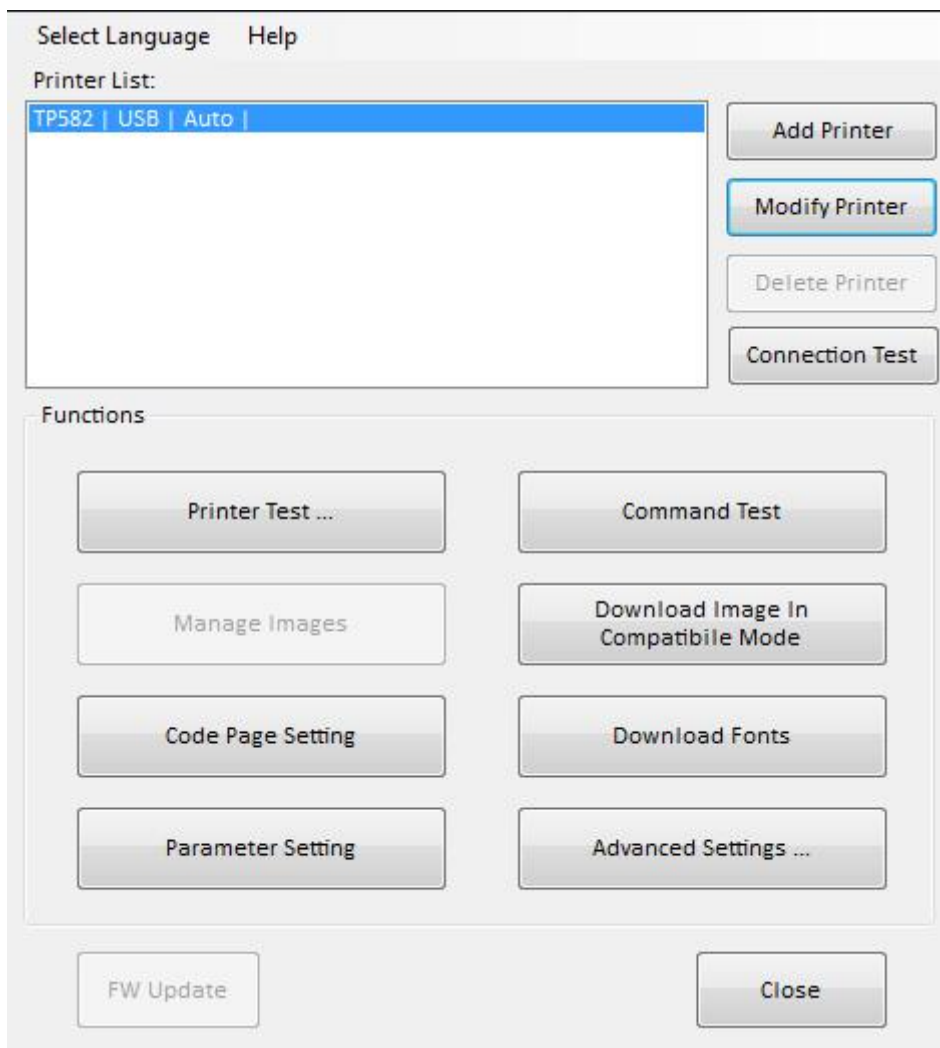

2) Choose the appropriate printer type and port. Then click “OK”. (Take TP808 for example)

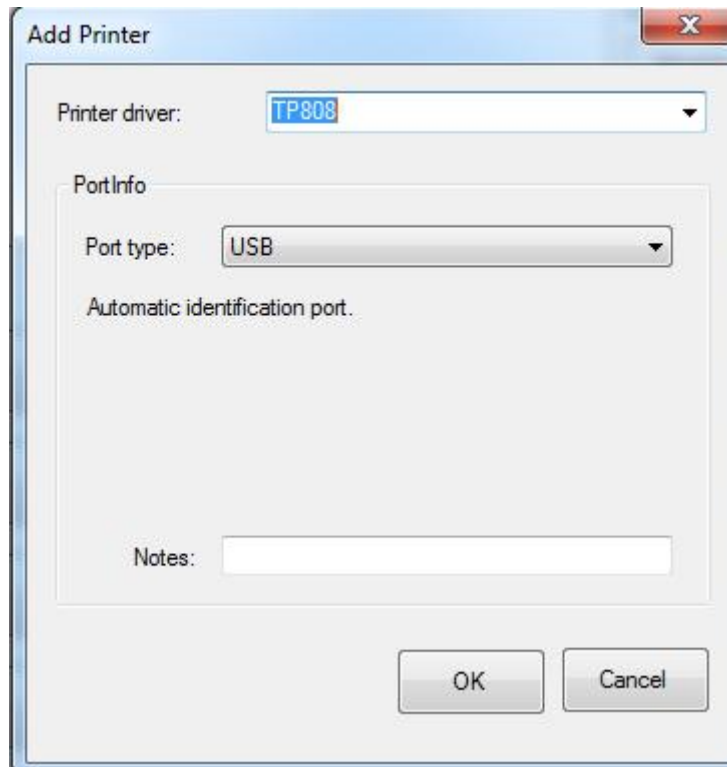

- **Modify printer**

1) Choose the printer you want to modify in the list. Click “Modify Printer”.

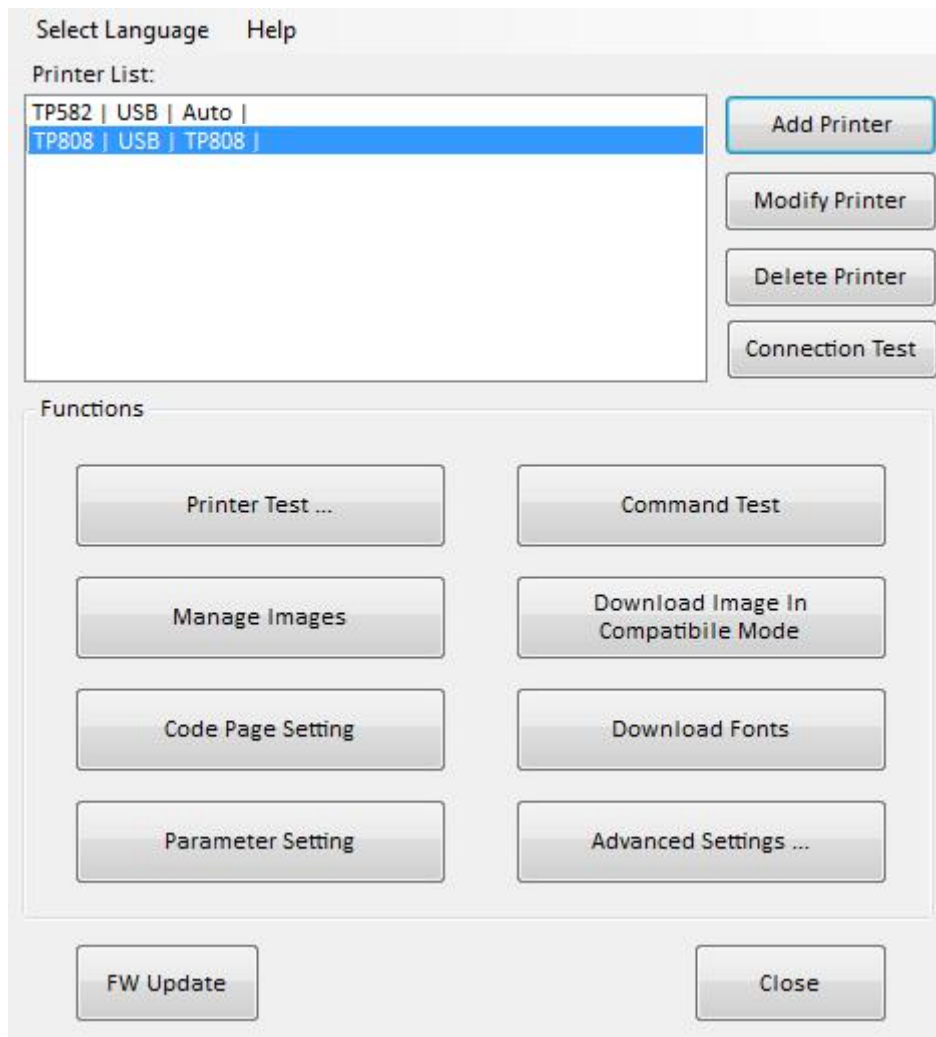

2) Choose the new printer and new port. Then click "OK".

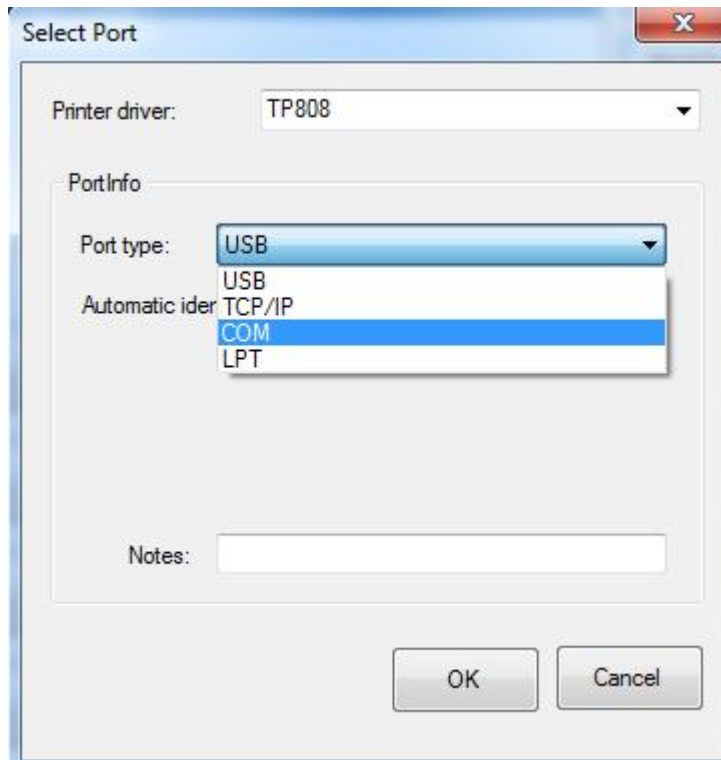

3) The new printer is added successfully.

- **Delete printer**

1) Choose the printer you want to delete in the list and click “Delete Printer”.

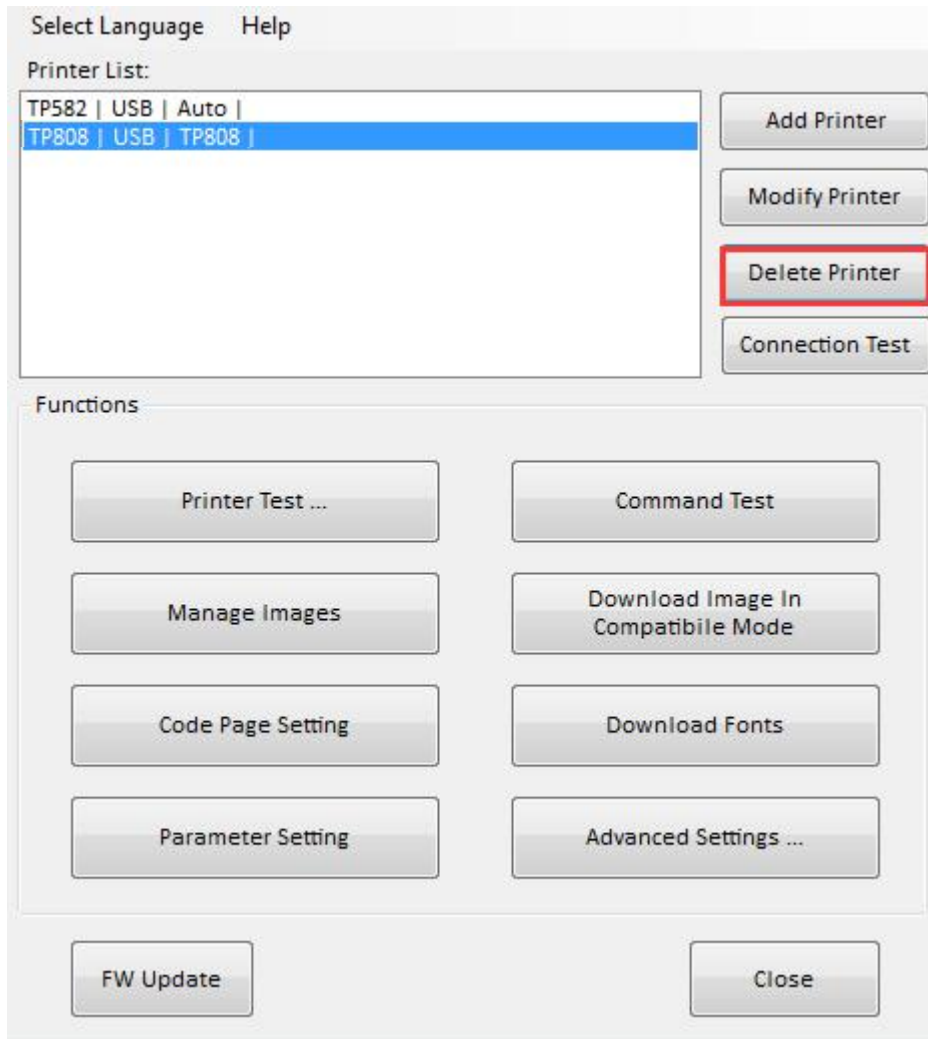

2) Click “Yes”, then the printer is deleted.

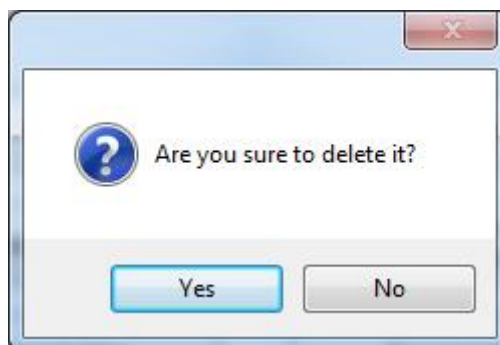

- **Connection Test**

Make sure printer is connected to computer and it is power on.

1) Choose the printer. Click “Connection Test”.

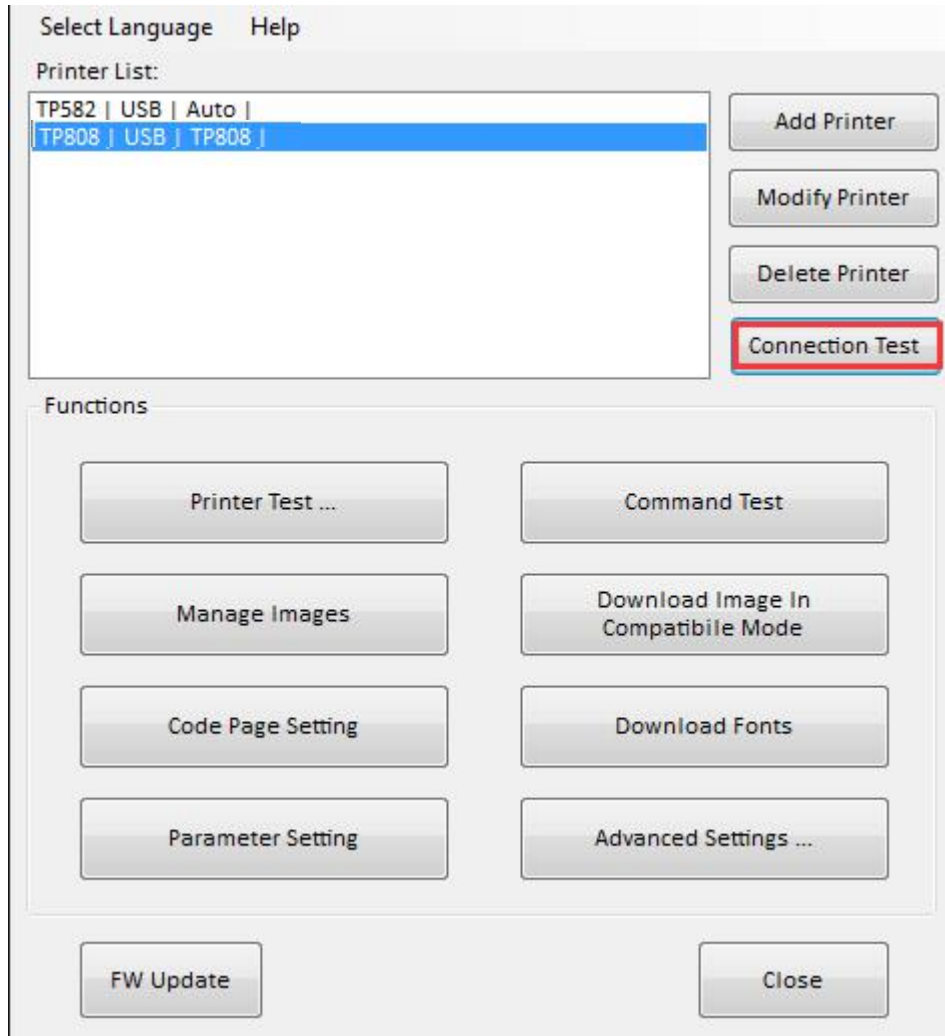

2) If the connection is successful, it will appear the following window. If the connection is unsuccessful, please connect the printer with computer.

**Note:**

- ❖ Make sure printer is connected to computer and power on.
- ❖ Make sure printer is loaded with paper.
- ❖ Before using the following function, carry out the “Connection Test” first.

9.2.2 Functions

Printer Test contains the following items:

- ▼ Printer Test
- ▼ Common Test
- ▼ Manage Images
- ▼ Download Image in Compatible Mode
- ▼ Code Page Setting
- ▼ Download Fonts
- ▼ Parameter Setting
- ▼ Advanced Settings

9.2.2.1 Printer Test

1) Self Test

Click “Self Test” to see if the printer will print properly.

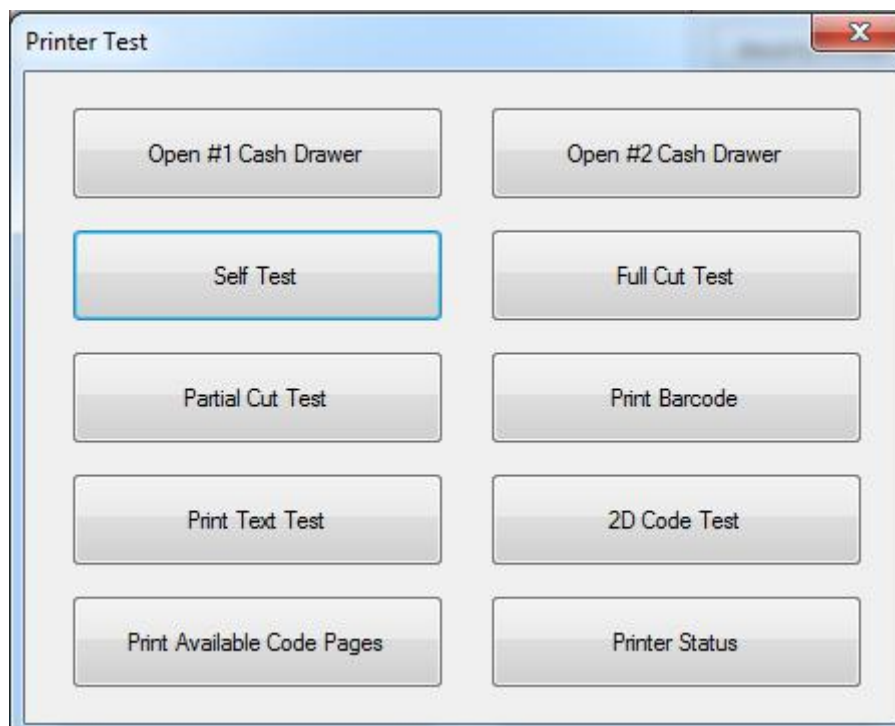

2) Full Cut Test

Click the “Full Cut Test” and the paper will be cut automatically. Cutting method is full-cutting. The paper would be falling down from the paper outlet after cutting.

3) Partial Cut Test

Click the cutter test and the paper will be cut automatically. Cutting method is partial cut (Partial cut: Not all cut off, leave a connection point between the two sheets of paper).

As shown in the figure:

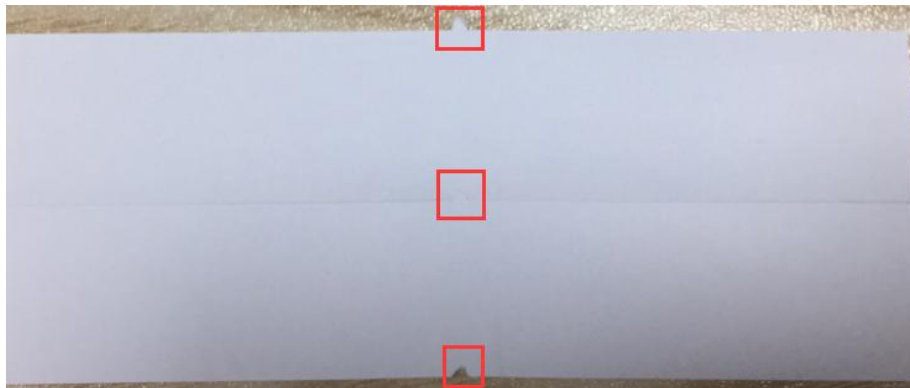

4) Print Text Test

Click "Print Text Test", input the text you want to print. When you click "Print", the printer starts printing text content. Such as: Print Text Test.

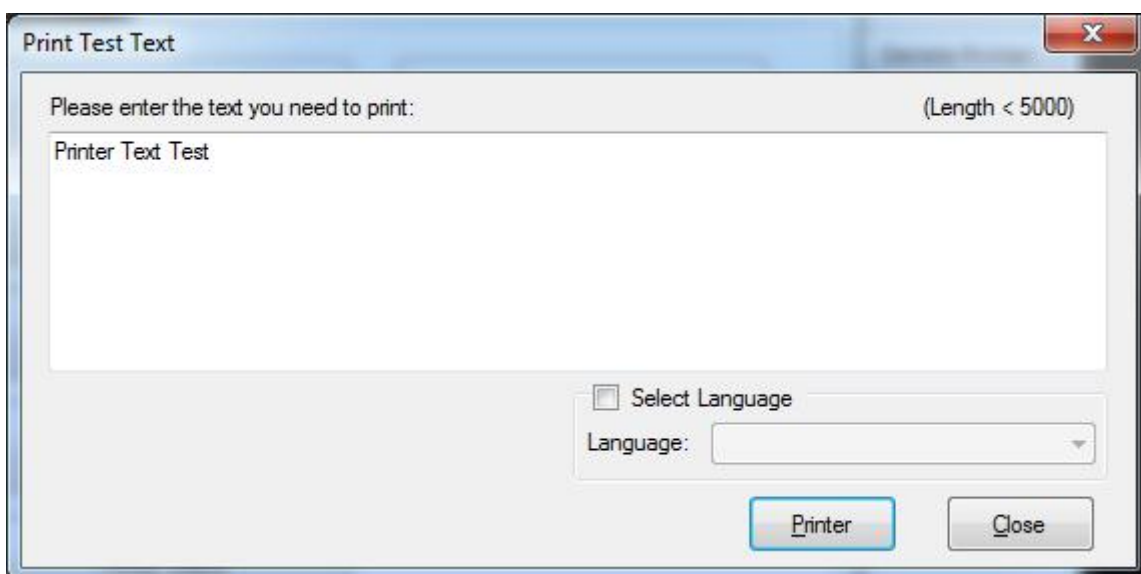

▲Note: The language option in the lower right corner is checked according to the input text. (For example: The input is Simplified Chinese, the language is checked for Simplified Chinese, the printer prints the input text according to the setting options, and if you check other languages, the printer does not print the text)

5) 2D Code

Click the QRCode mode.

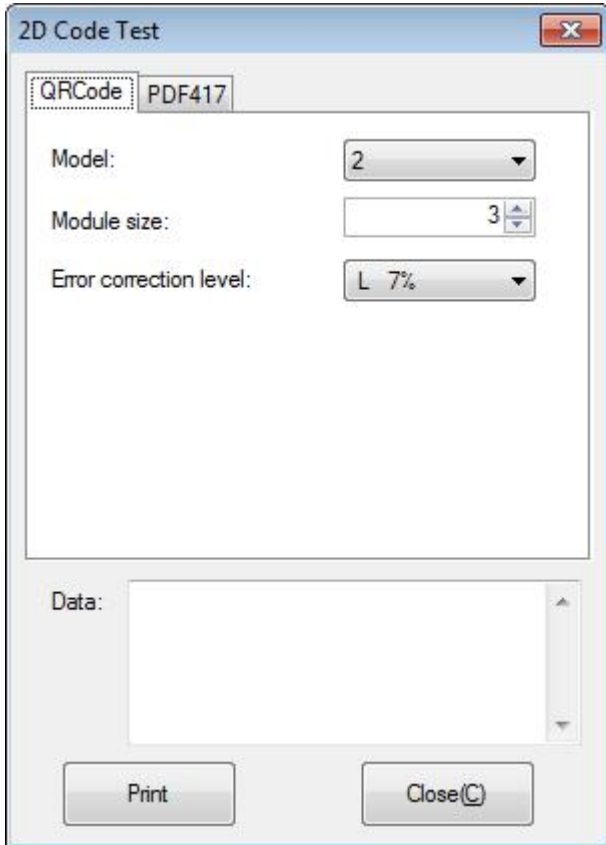

▲ Model: 1~2

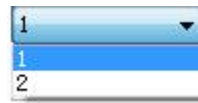

▲ Module size: 1~16

The larger the module value, the larger the printed QR code is, and the smaller the opposite.

▲ Error correction level: 7%~30%

The higher the error correction level, the more intensive the module graphics.

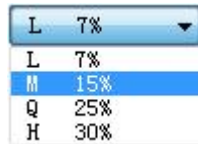

Click the PDF417 mode.

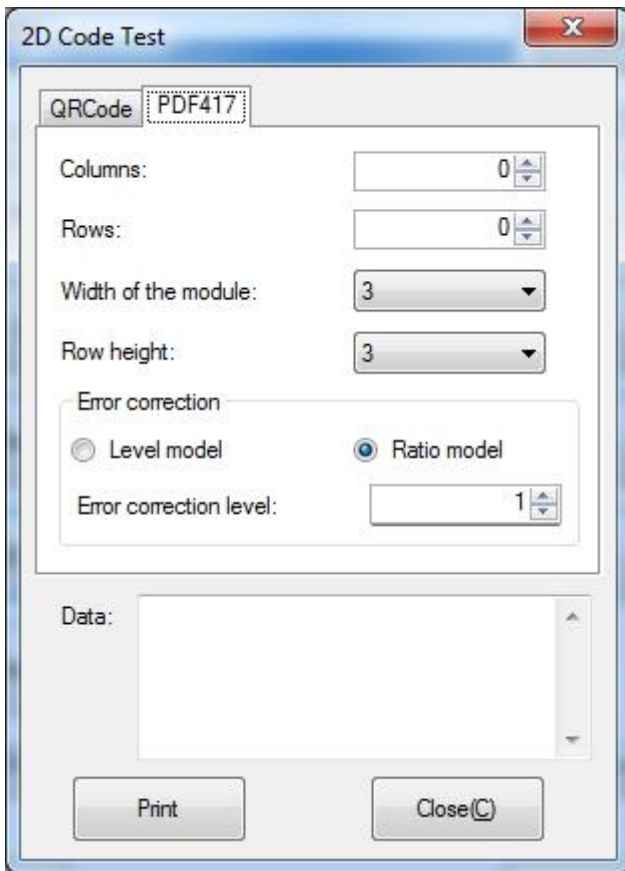

▲ Columns: 0~30

▲ Rows: 0~90

▲ Width of the module: 2~6

The larger the module value, the wider the width of the printed PDF417 barcode, and the smaller the opposite.



▲ Row height: 2~8

The larger the module value, the longer the printed PDF417 barcode, and the smaller the opposite.

▲ Error connection level

9.2.2.2 Command test

In the command test, you can send command to the printer. Input text or hexadecimal data. Select a file or enter a command in the input box.

1) There're two ways to load files. You can choose the way you want.

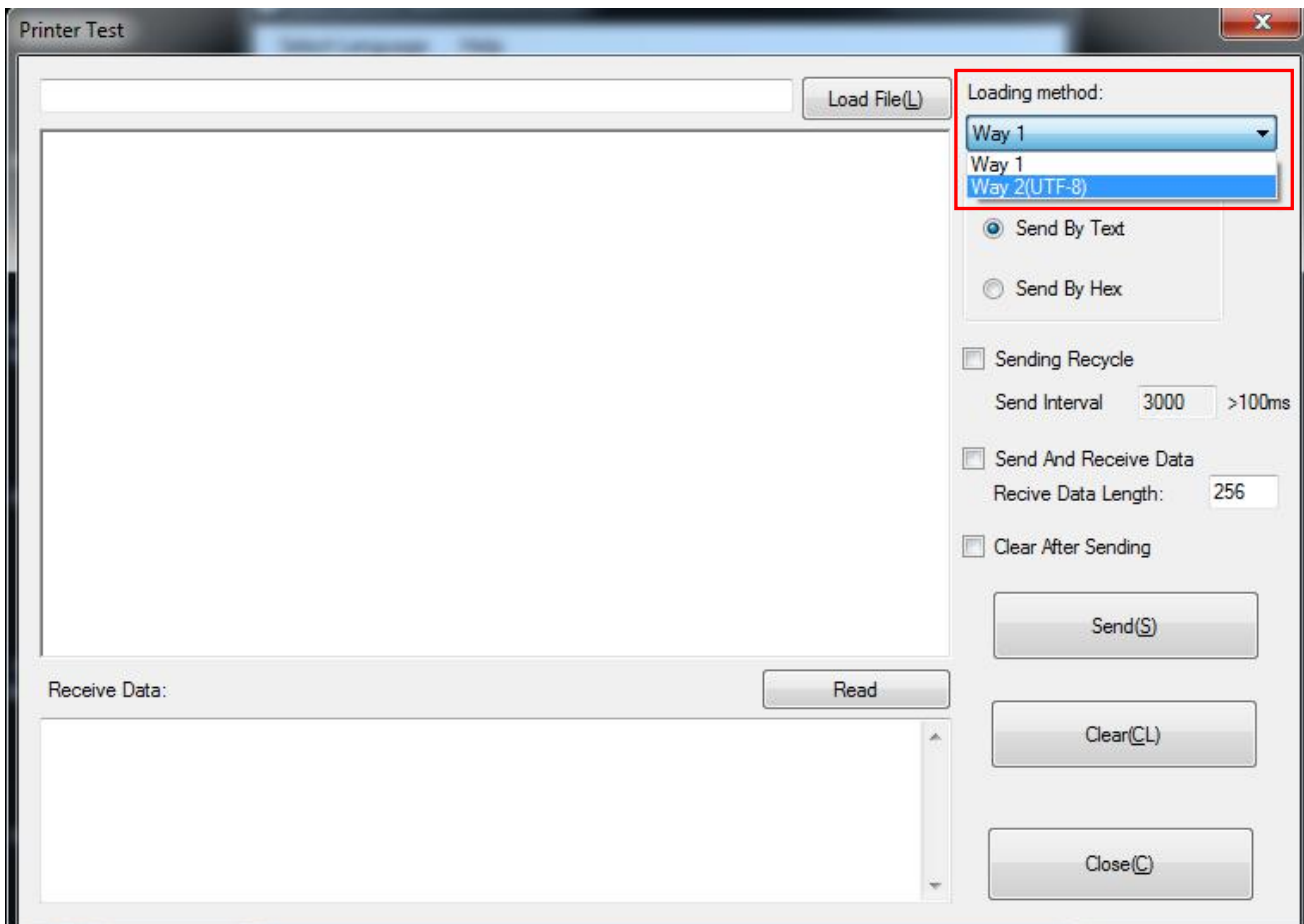

2) Click “Send by Text”, input text content.

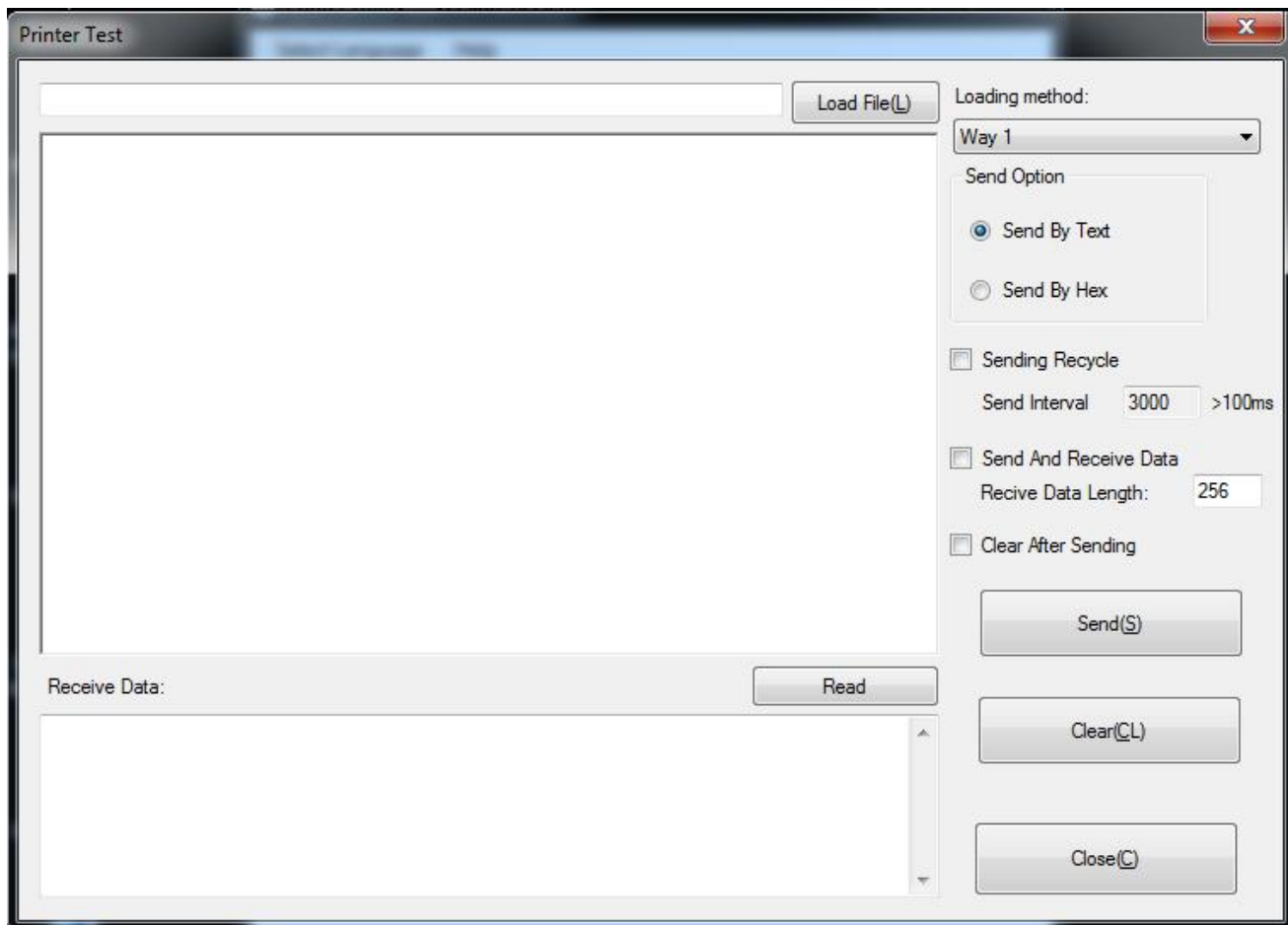

▲Sending Recycle:

When the interval is set to 3000ms (you can set the interval as needed), then click “Send”, the printer starts to recycle printing. Click “Stop” to stop the recycle printing.

Send Option

Send By Text

Send By Hex

Sending Recycle

Send Interval >100m

Send And Receive Data

Recv Data Length:

Clear After Sending

Send(S)

Clear(CL)

Close(C)

2) Click “Send by Hex”, input the content. (Convert text to HEX or send ESC command)

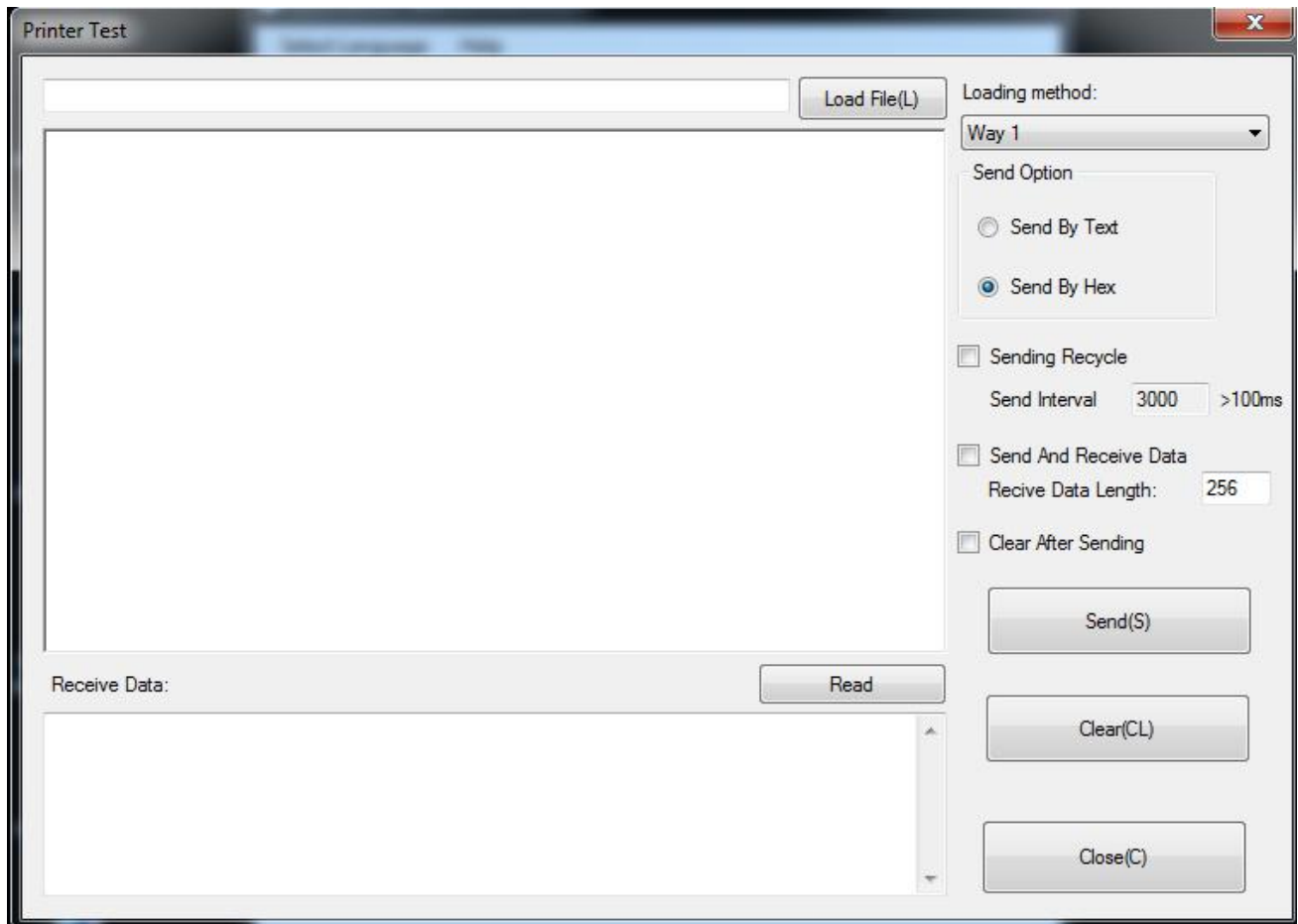

9.2.2.3 Manage Images

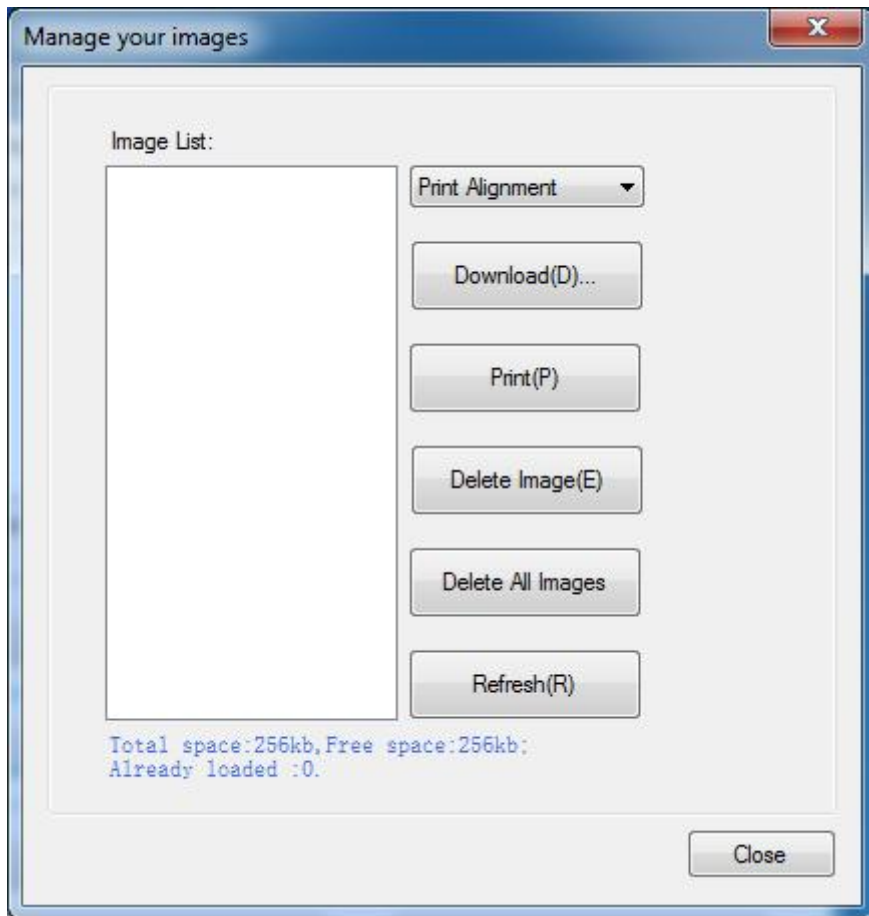

- Download image

Click "Download" to add the image, if you want to print the picture, set the print location before clicking "Download mode of G" to print the picture. (It is recommended to use a picture in BMP format)



- Select the print location, center, left, and right. (Such as, left print).

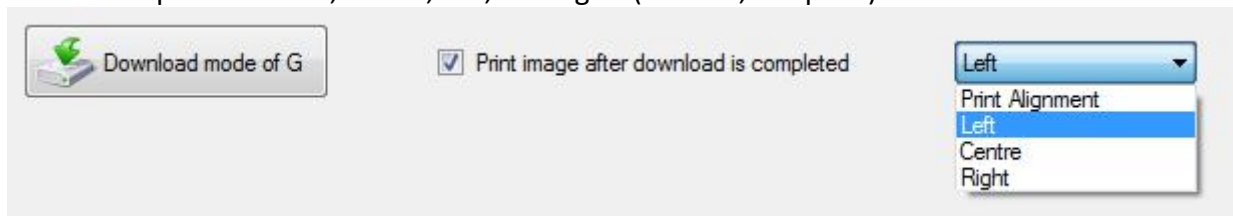

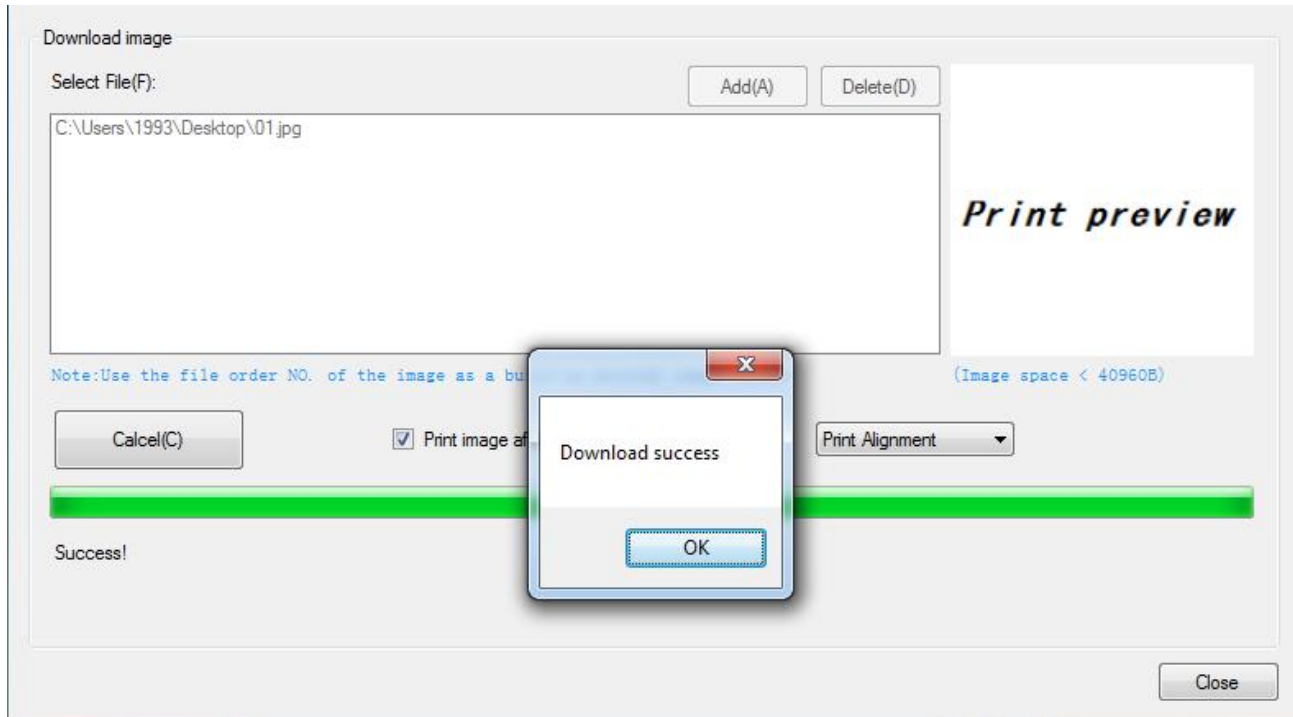

Note: Total memory for bitmap is 256K.

- Delete Image

Note: each time click "Download mode of G", an image list number will be generated.

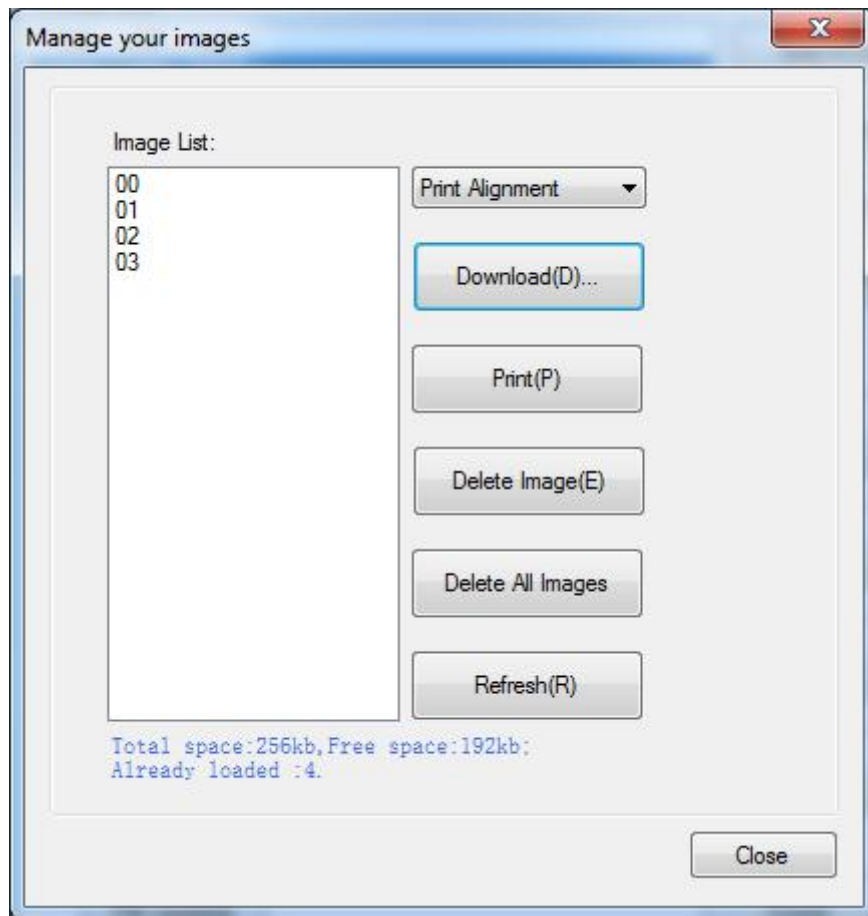

Click the image list, select "Delete selected image" will delete the image, click "Delete all Images", without clicking the list option to delete all the images in the list.

9.2.2.4 Code Page Setting

Select the code page from the list and click “Set”.

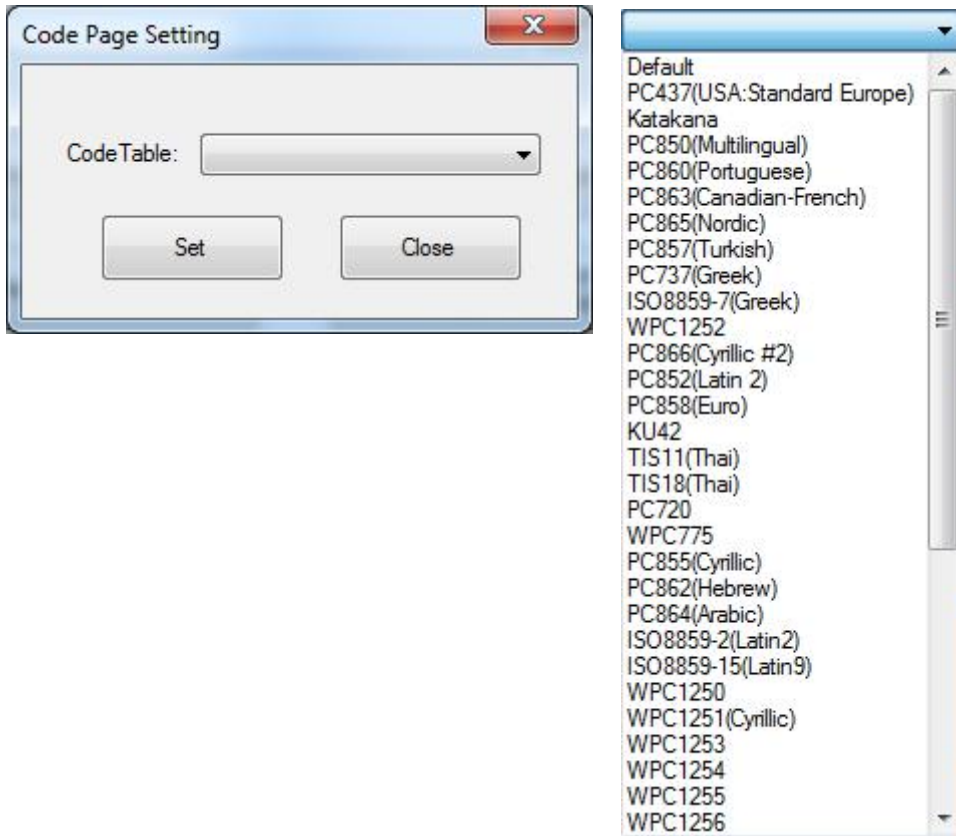

Note: This code page is only valid in multiple languages.

9.2.2.5 Download Fonts to Printer

Select the font from the existing file and click "Download".

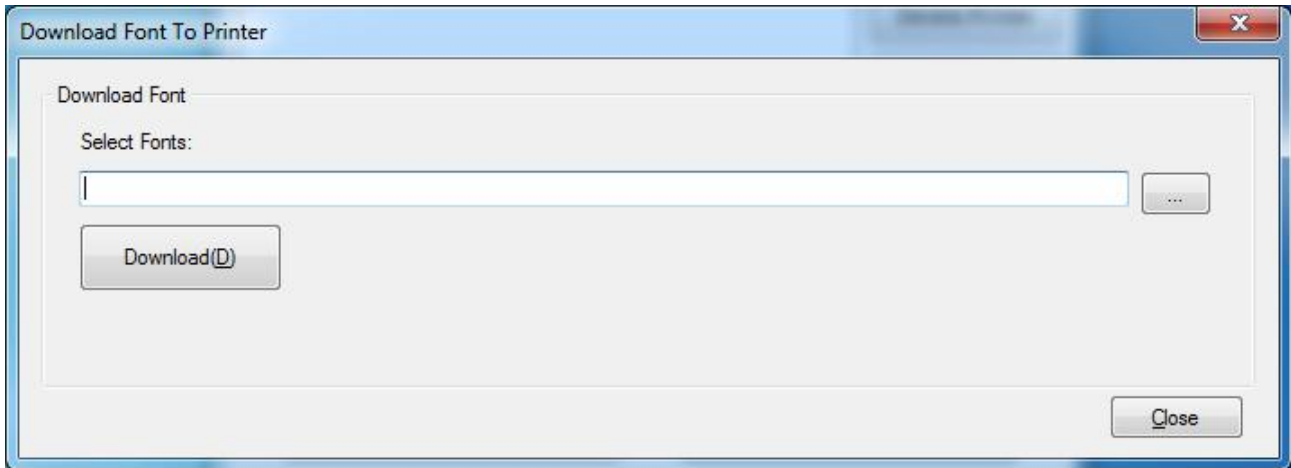

Note: After downloading the font successfully, you need to restart the printer to take effect.

9.2.2.6 Parameter Setting

You can set “Arabic Character Transform”, “Language Mode”, “Signal light flashing time” and “UTF-8 input mode”.

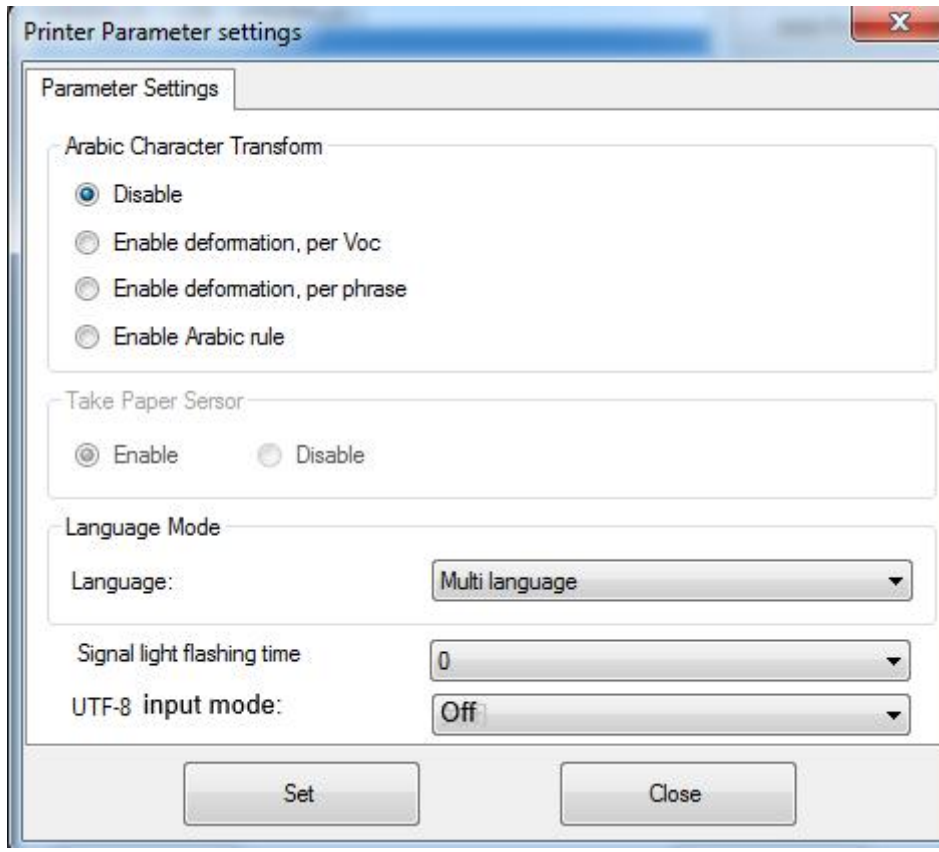

9.2.2.7 Advanced Setting

The advanced settings contain the following items.

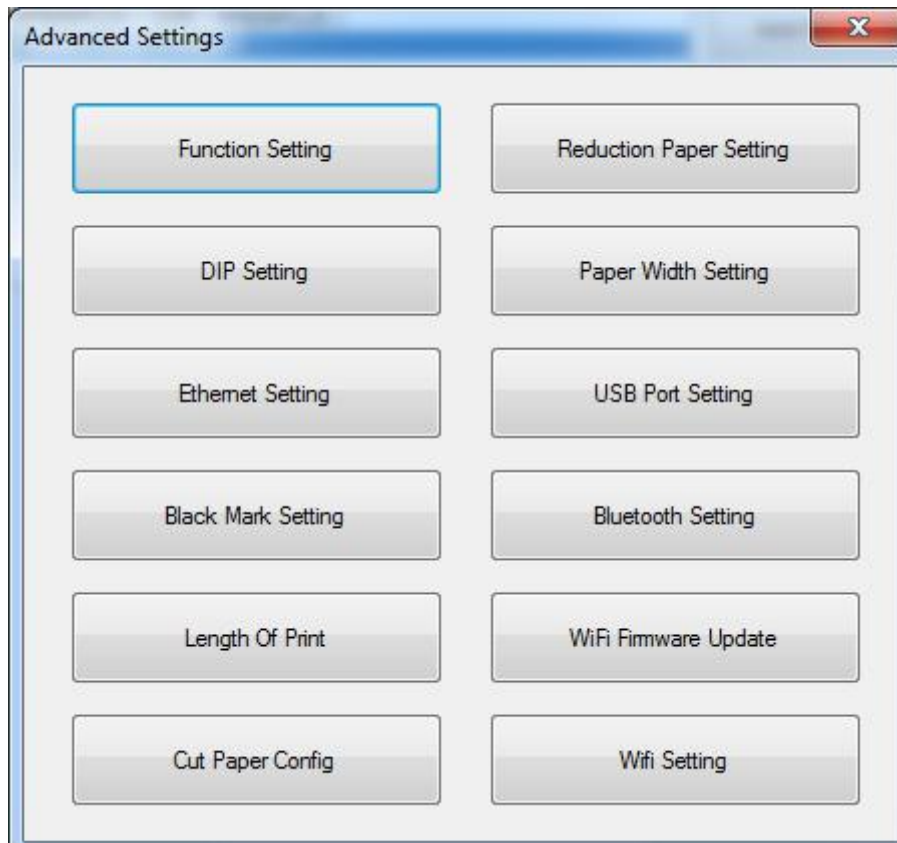

◆ **Function Setting**

AD Settings

Detect Paper AD Value: Read(R)

Set AD Valve Value: Write(W)

(AD Value + 300 or Default 2100)

Clear(C)

Long Beeping After Cutting

Disable

Use printer buzzer

Use printer buzzer and external buzzer Set

Printer Buzzer

Beeping times: (1-63)

Beeping time: (1-255) (100ms)

Beeping interval: (1-255) (100ms)

External Buzzer

Beeping Times: (1-63)

Buzzer Volume

Very Low Low Standard Loud Set

Power-on Model

Chinese Mode(Z) English Mode(U)

Paper Near-End Sensor Status

Enable Disable

Close(C)

● **AD Settings:**

- ① Detect Paper AD Value: click “Read” and you can see the default value is 1614 and cannot be input.
- ② Set AD threshold value: You can input the value, and the ideal value is the AD value plus 300, that’s 1914, and the default value is 2100.

● **Long Beeping After cutting:**

- ① **Disable:** there is no sound after cutting
- ② **Use printer buzzer (The beeping time, times and interval time can be set for what you want, such as 1 milliseconds, 2 milliseconds or 3 milliseconds, etc.):**

The following setting is set as an example:

When cutting one piece of paper each time, the printer will emit the “Beep” for one time, and the beeping time is two milliseconds and beeping interval is three milliseconds.



Note: 100ms=0.1s, 1s=1000ms

● **Buzzer Volume:**

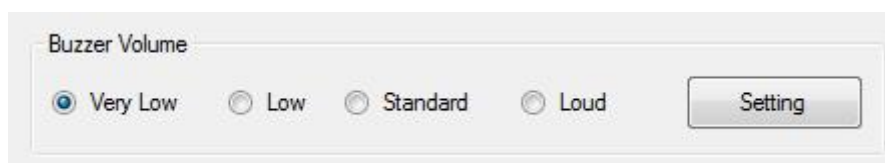

The “Very Low” is the minimum sound, and the “Loud” the maximum sound. You can select a volume level and click "Setting" to print (Default: "Standard" level).

◆ ***Reduction Print Setting***

Select the item and click "Settings".

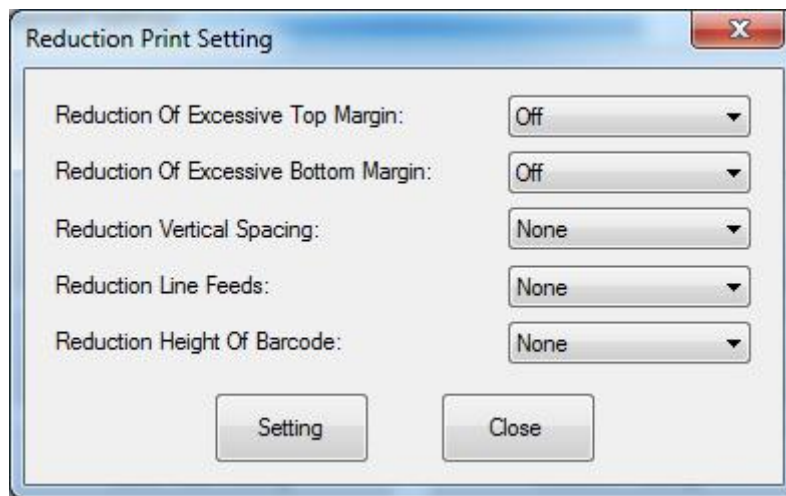

Choose the item and click "Setting".

① Reduction Of Excessive Top Margin:

When the printer is in the "off" state, the blank part at the top of the printed paper is larger than the blank part at the top of the paper printed in the "on" state.

② Reduction Of Excessive Bottom Margin:

When the printer is in the "off" state, the blank part of the bottom of the printed paper is larger than the blank part of the bottom of the paper printed in the "on" state.

③ Reduction Vertical Spacing: 25%~75%

The bigger the reduction vertical spacing, the narrower the interval between two lines of characters.

④ Reduction Line Feeds: 25%~75%

The higher the reduction line feeds, the narrower the interval between two lines of characters.

⑤ Reduction Height of Barcode: 25%~75%

The bigger the reduction height of barcode, the smaller the height of the barcode.

◆ **DIP Setting**

Click "Read" to get the printer parameters, click "Write" to send the modified parameters to the printer.

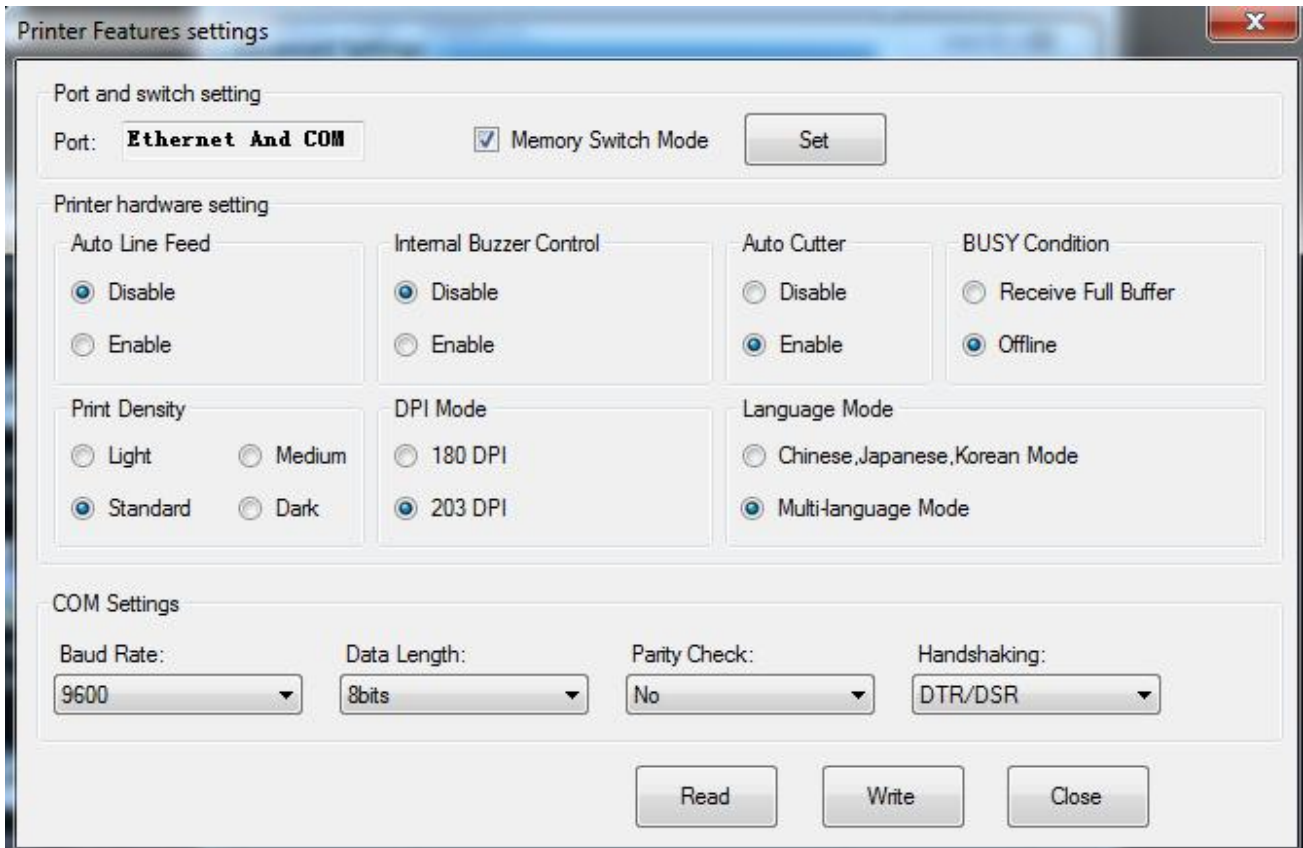

After the serial port parameter is set, click "Set".

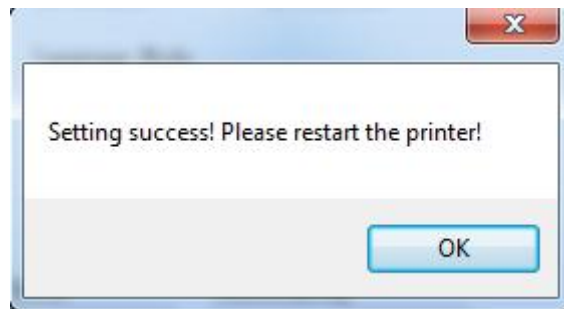
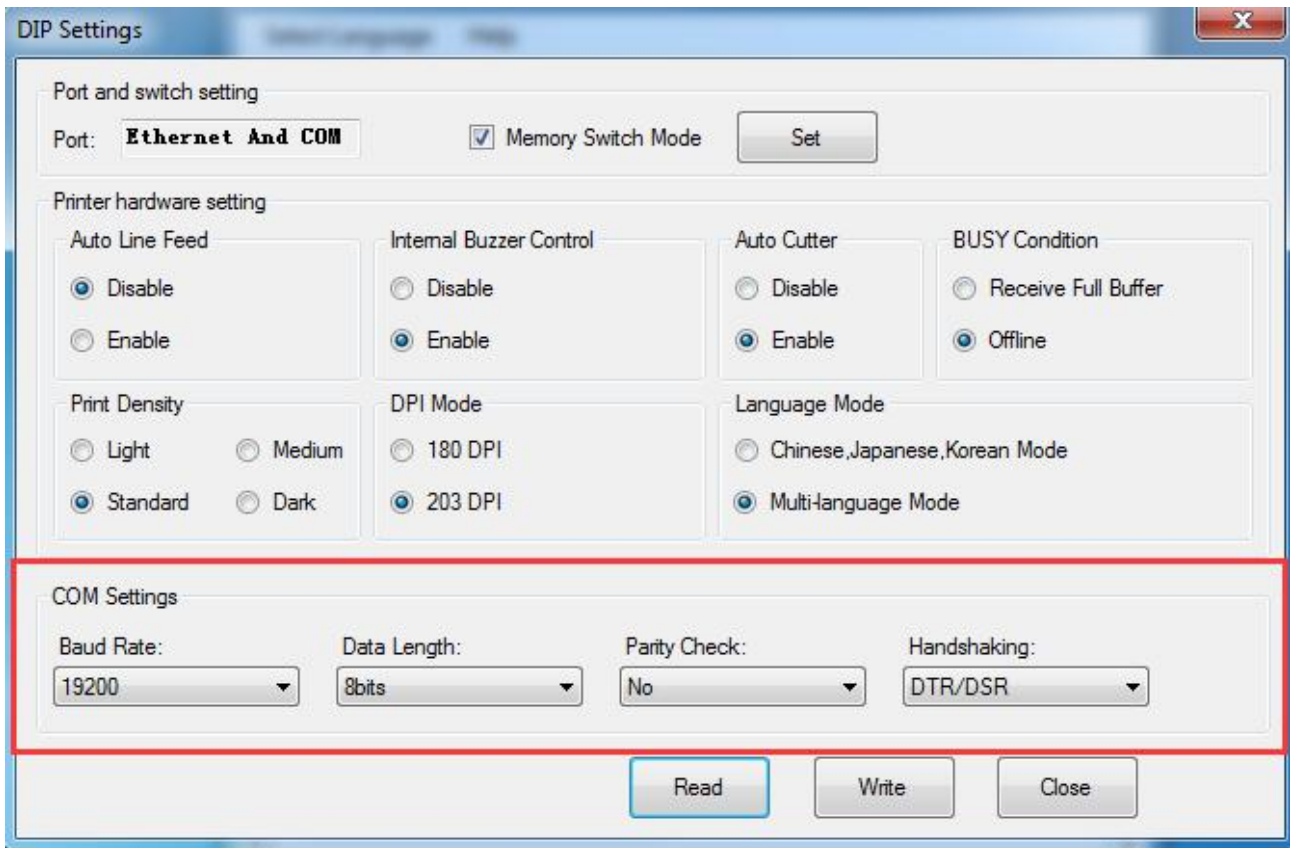

Note: When DIP setting is set in soft, the DIP switch in the bottom of printer is disable.

After setting the DIP successfully, you need to restart the printer before using it.

- **Printer hardware setting**

- 1) Print Density: Light, Medium, Standard, Dark (default "standard" level)
The print density value varies according to the paper material and it can be adjusted to suit your needs.
- 2) DIP Mode: 180/203DPI (default "203 DPI")
The printer supports both of these resolutions.
- 3) Language Mode:

Chinese, Japanese, Korean mode (default)

Multi-language mode

- **COM Setting**

- 1) Baud Rate: 2400, 4800, 9600, 19200, 38400, 57600, 115200
- 2) Data Length: 7bits, 8bits
- 3) Parity Check: No, EVEN, ODD
- 4) ADDC: DTR/DSR, XON/XOFF

Note: The value of the serial port parameter can be obtained according to the value of the Self-test page information:

E.g: Self-test page (Serial 115200, None, 8, 1, DTR/DSR)

Baud Rate: 115200

Parity Check: None

Data Length: 8bits

Stop Bits: 1

ADDC: DTR/DSR



Note: When the DIP setting is set in memory switch mode, the DIP switch at the bottom of the printer need to be disabled.

- **Modify the COM setting**

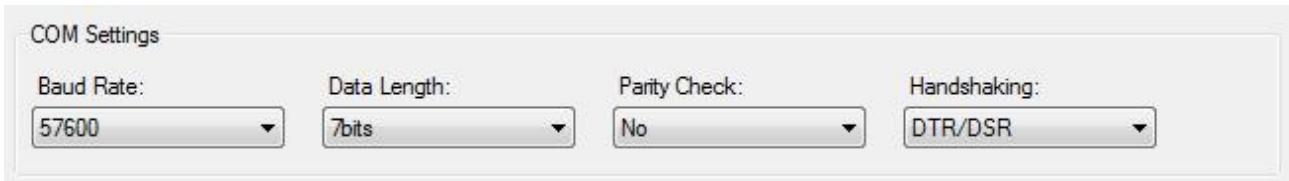

1) After setting the parameters as required, click "Write" and restart the printer.

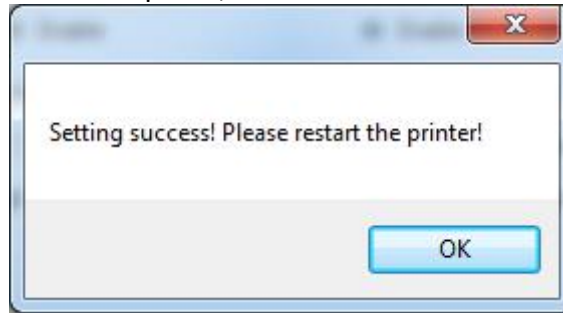

2) After restarting the printer, open the main menu screen of the tool and click "Modify Printer".

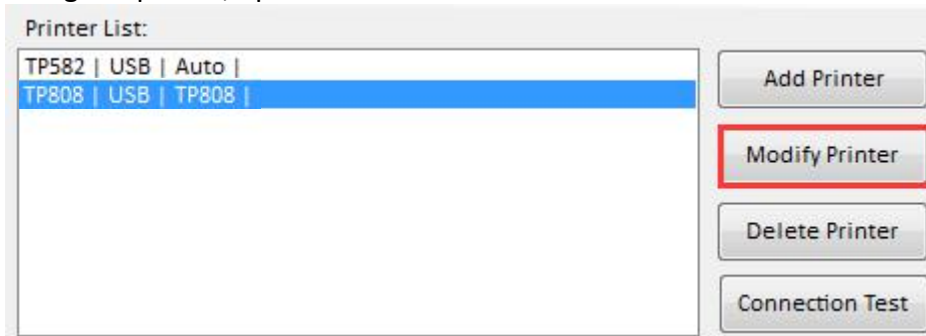

3) Select the port category "COM" and set the baud rate to the value "57600" as shown above, and parity "None". This port allows you to print after setup is complete.

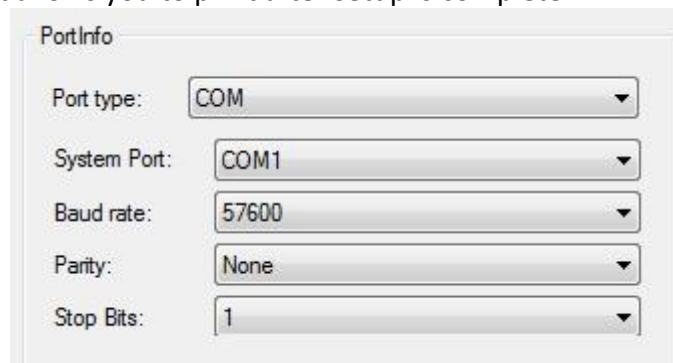

Note: When the DIP setting is set in memory switch mode, the DIP switch at the bottom of the printer need to be disabled.

◆ ***Paper Width Setting***

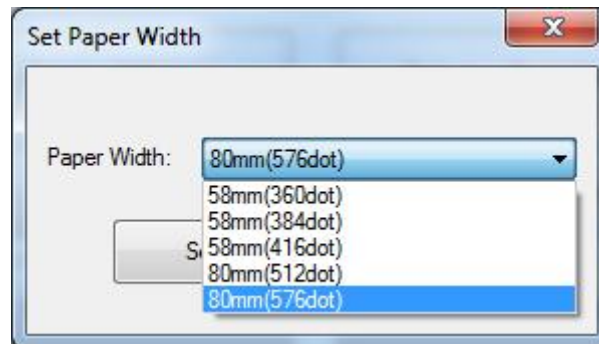

- 1) 58mm (360dot)
- 2) 58mm (384dot)
- 3) 58mm (416dot)
- 4) 80mm (512dot)
- 5) 80mm (576dot)

Note: Select the paper width above according to the paper print width.

◆ **Ethernet Setting**

Note: This setting is only available for models with Ethernet functionality.

This mode is divided into “Auto Assignment IP” and “Static IP Mode”, select one of the modes to connect as needed.

Note: IP addresses can be obtained from the Self-test page.

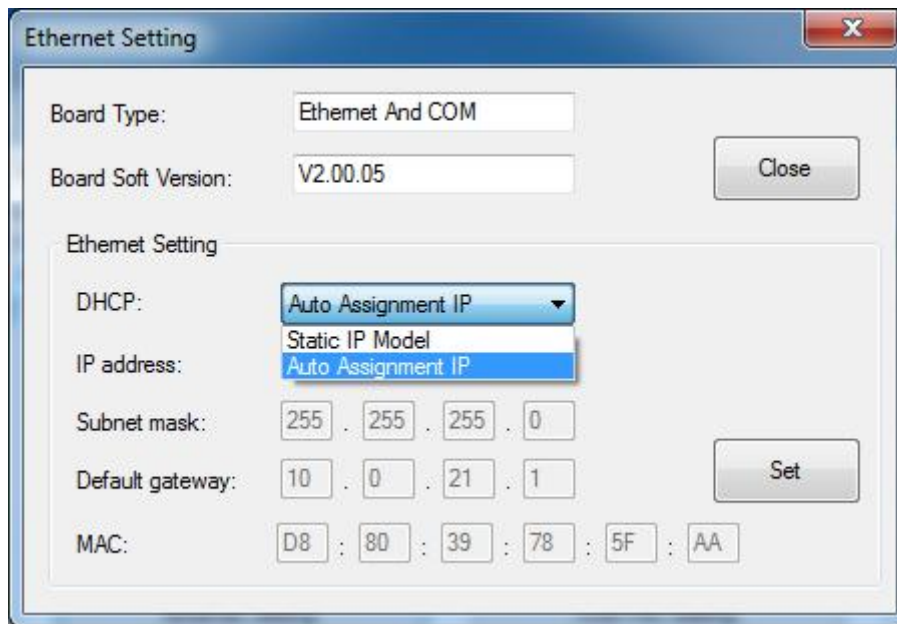

- Static IP Mode

- 1) Change the printer IP address so that the printer IP address (such as: 192.168.0.33) is the same segment as the host IP address (such as: 10.0.21.89).

Here is the illustration:

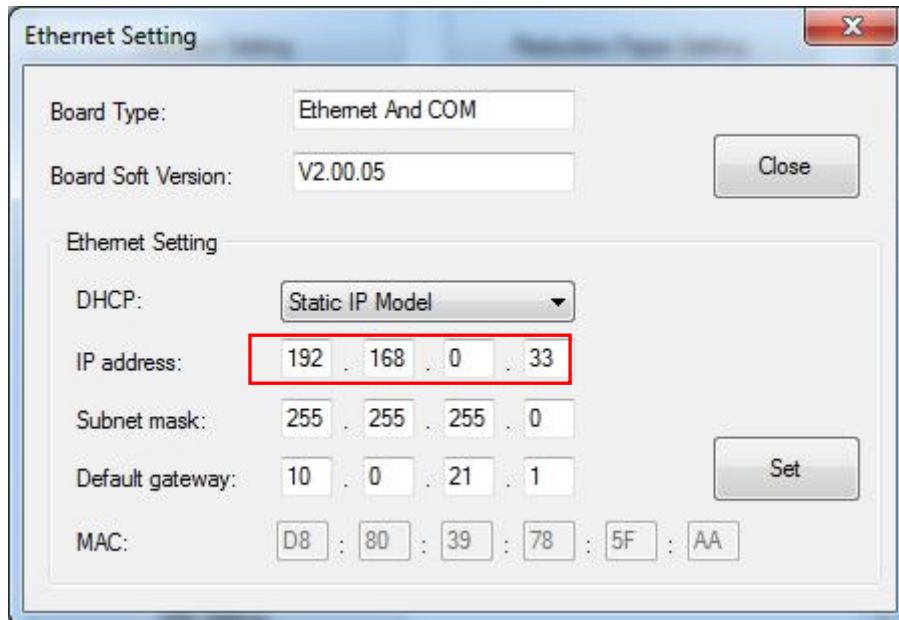

Figure ■ Printer IP Address

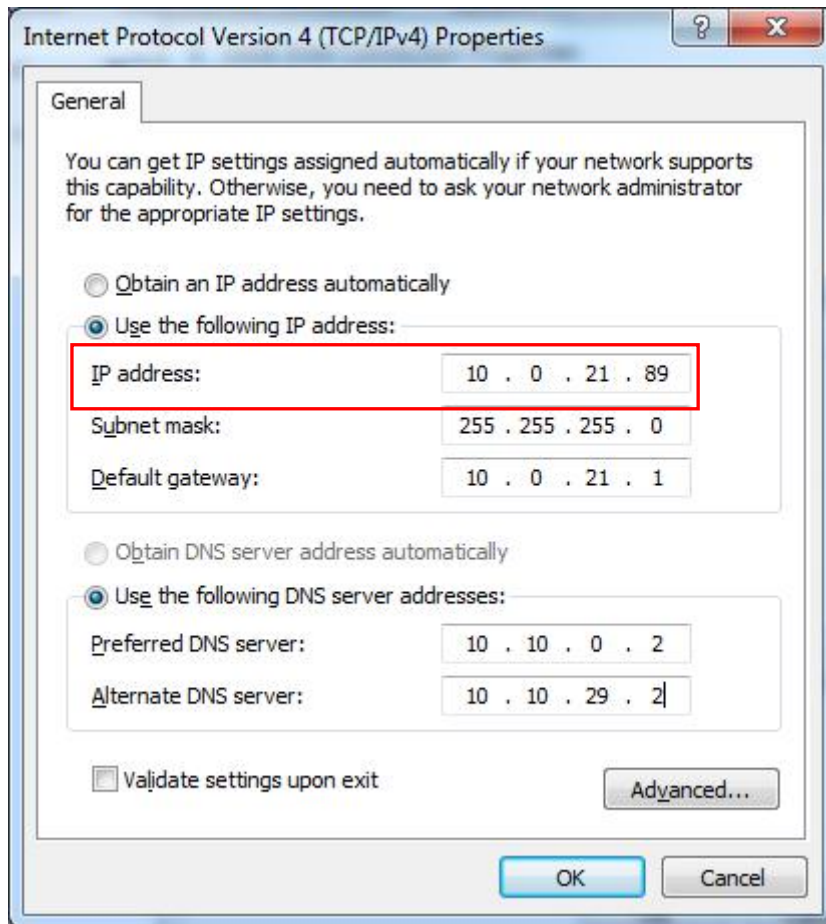

Figure ■ Host IP Address

2) Set the same network segment.

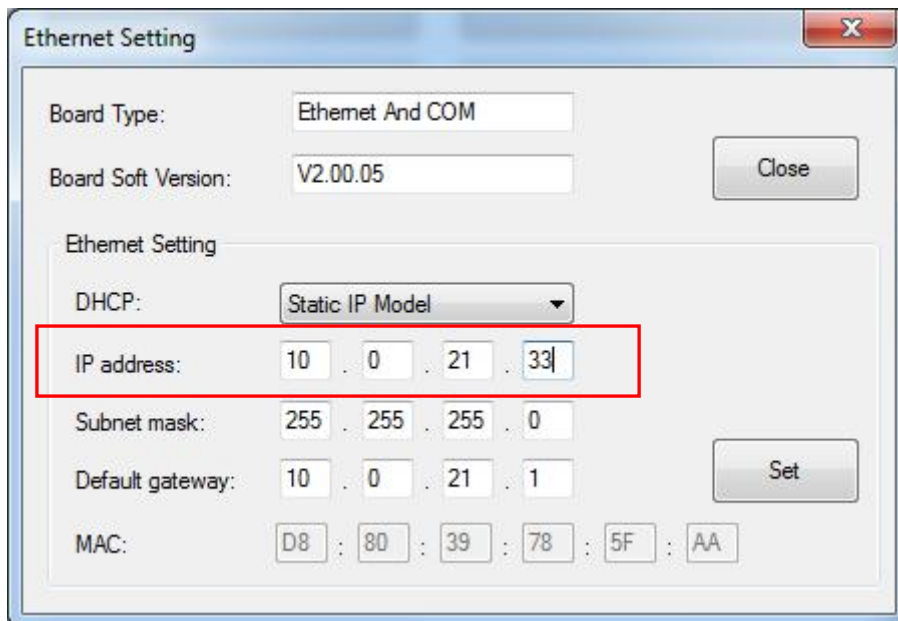

Figure ■ Printer IP Address

- Auto Assignment IP

This mode automatically assigns the IP address to the printer.

The screenshot shows a window titled "Ethernet Setting" with a close button (X) in the top right corner. The window contains the following fields and controls:

- Board Type: Ethernet And COM
- Board Soft Version: V2.00.05
- Close button
- Ethernet Setting section:
 - DHCP: Auto Assignment IP (dropdown menu)
 - IP address: 10 . 0 . 21 . 33
 - Subnet mask: 255 . 255 . 255 . 0
 - Default gateway: 10 . 0 . 21 . 1
 - MAC: D8 : 80 : 39 : 78 : 5F : AA
 - Set button

When the settings are complete, click "Write", then restart the printer.

◆ USB Port Setting

Click "Virtual serial port" setting and restart the printer.

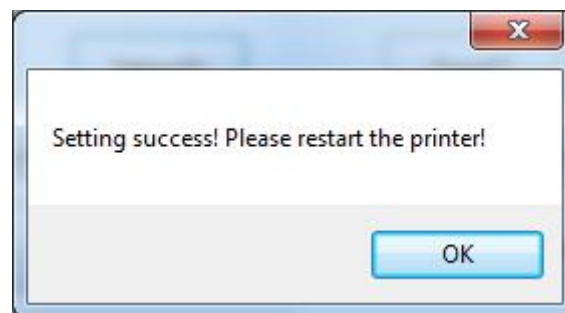

- **Check the Virtual Serial Port**

- 1) Right-click the computer and select "Manage".
- 2) Click "Device Manager" to view the virtual port. (such as: COM7)

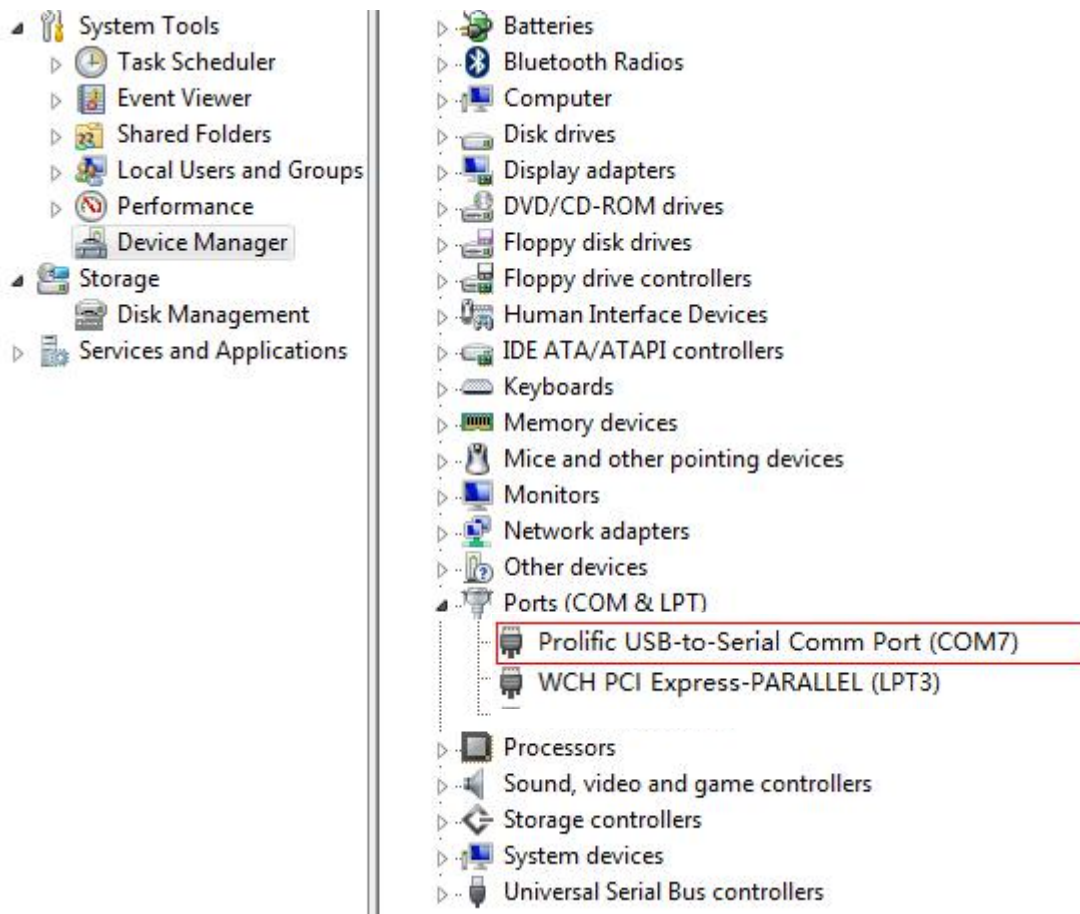

3) Return to the printer utility and click "Modify Printer".

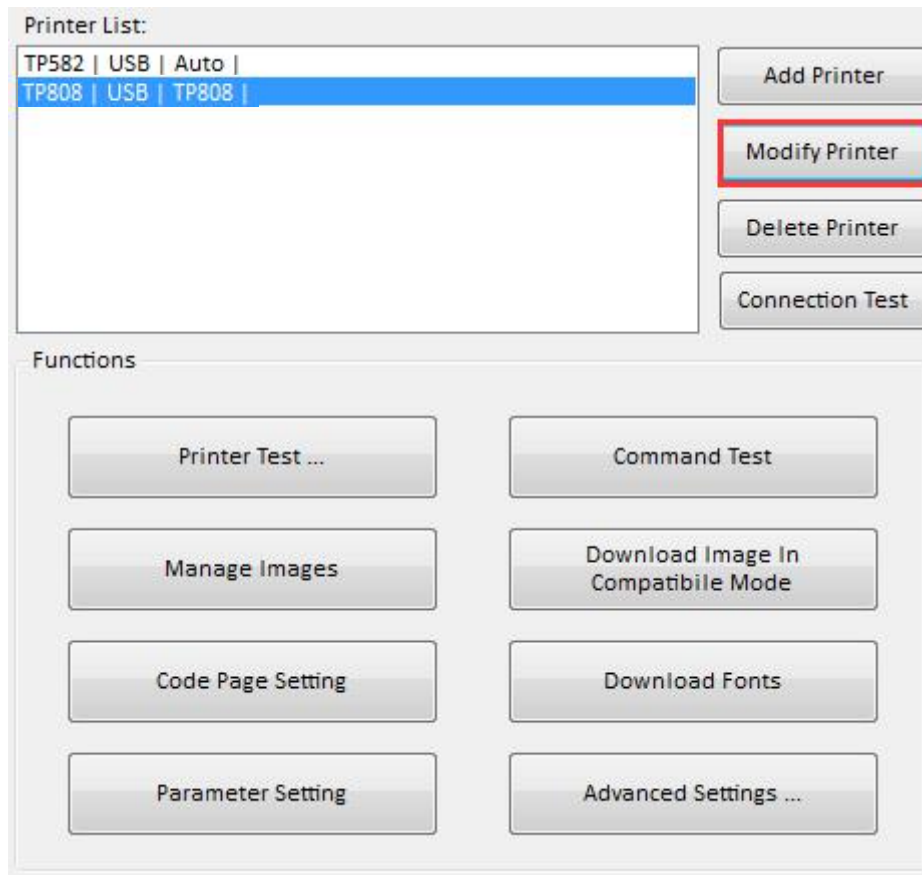

4) Change the port to "COM7".

PortInfo

Port type: COM

System Port: COM2

Baud rate: COM1
COM2

Parity: None

Stop Bits: 1

Notes:

PortInfo

Port type: COM

System Port: COM7

Baud rate: 19200

Parity: None

Stop Bits: 1

Notes:

◆ **Black Mark Setting**

When using black mark paper, the black mark can be set, and the printer will automatically locate the black mark position.

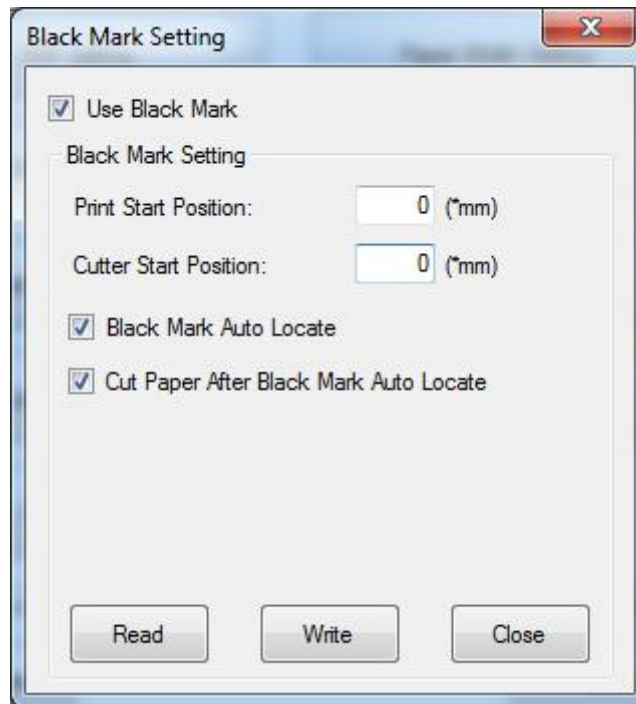

1) Print start position ($\geq -14\text{mm}$)

$\geq 14\text{mm}$: the start position of printing is at least 14mm from the bottom edge of the black mark paper.

2) Cutter start position ($\geq -25\text{mm}$)

$\geq -25\text{mm}$: the position of cutter is at least 25mm from the bottom edge of the black mark paper.

◆ **Bluetooth Setting**

Note: This setting is only available for models with Bluetooth functionality.

In the below window, type in the new Bluetooth name and password, then click “Set” and restart the printer to take it into effect.

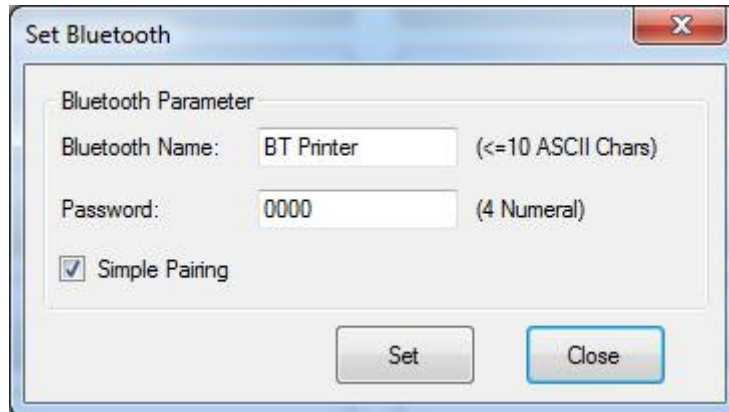

Note: when “Simple Pairing” is ticked, the password is not needed for Bluetooth connection. When “Simple Pairing” is not ticked, the password is needed for Bluetooth connection.

◆ **Length of Print**

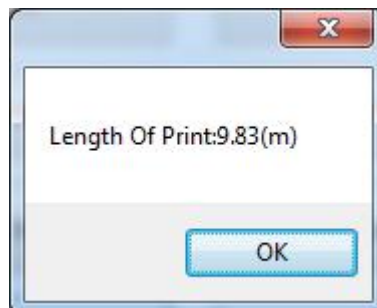

Click “Length of Print” to obtain the length of the paper that the printer has printed.

◆ **Wi-Fi Firmware Update**

1) Click “WiFi Firmware Update”.

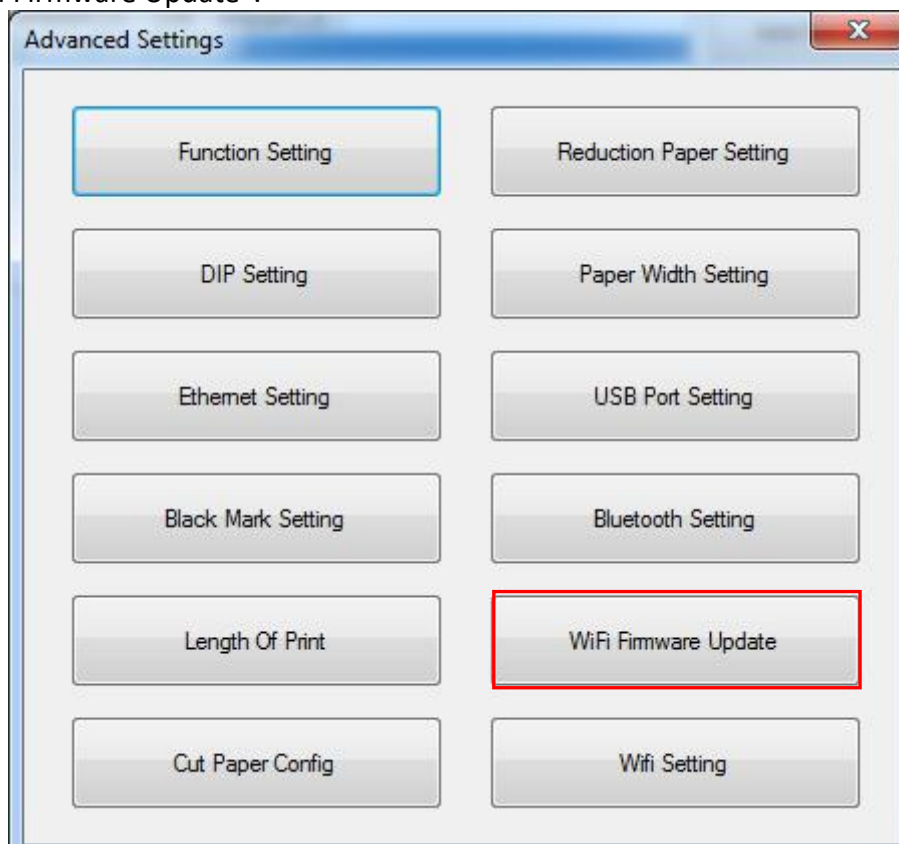

2) Click “...” to choose file and click “Update”.

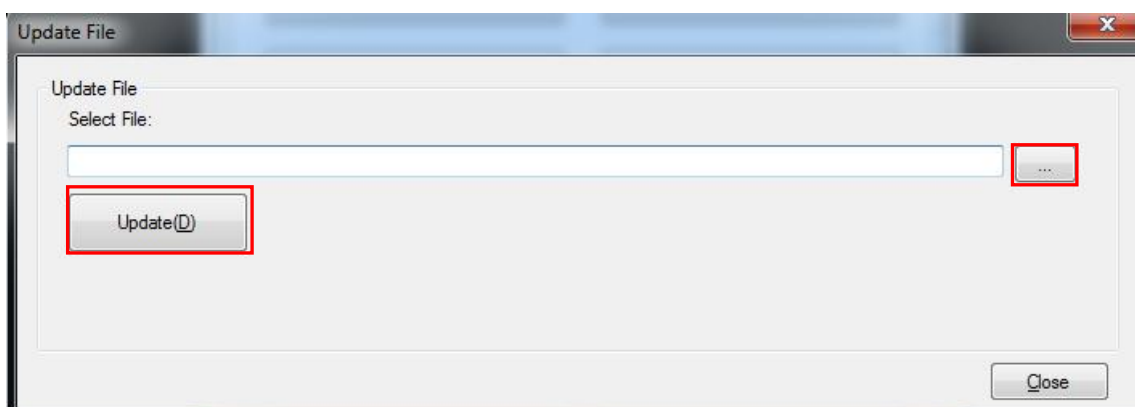

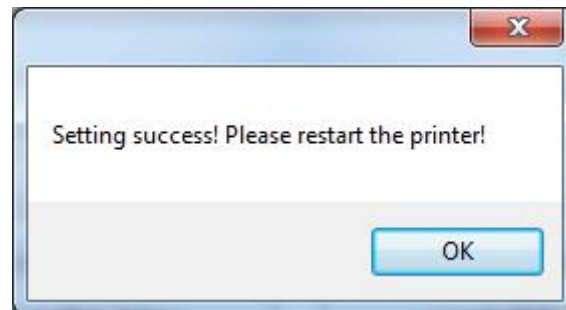
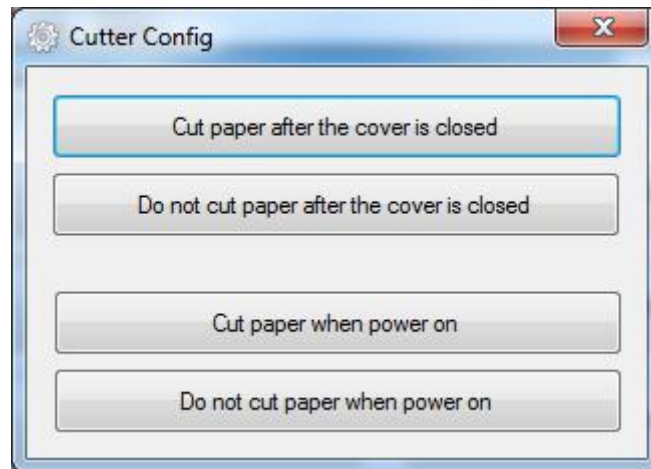
◆ Cut Pper Config

- 1) Cut paper after the cover is closed: the printer automatically cuts the paper after closing the cover.
- 2) Do not cut paper after the cover is closed: the printer does not automatically cut the paper after closing the cover.
- 3) Cut paper when power on: the printer automatically cut paper after the printer is power on.
- 4) Do not cut when power on: the printer does not automatically cut paper after the printer is power on.

◆ **Wi-Fi Setting**

Note: This setting is only available for models with Wi-Fi functionality.

The method to switch between Ethernet and Wi-Fi modes: In the power-on state, press and hold the paper feed button and the power button at the same time until the printer restarts. Then the printer will print out Ethernet or Wi-Fi information.



Note: Simultaneous use of Ethernet and Wi-Fi is not supported.

The following steps take TP808 (under WINDOWS 10) for example, and the setting is only available for those models with Wi-Fi function.

1. Click “Read” to obtain the current status of printer.



1. Wi-Fi Module supports AP mode and STA mode, and default as AP mode.

■ Under AP mode, printer will be used as a wireless network access point, computer or other mobile devices can connect to this Wi-Fi.

WIFI Config ✕

Module MAC:

Module Version:

Host Name:

Wifi Mode: ▾

SSID:

IP Address:

Password:

Show password

Read
Set

Restore Factory Setting

Module Version	Current Module Version
WiFi Mode	Supports “AP” mode and “STA” mode, and default as “AP” mode
SSID	Modifiable, default as “POS_WIFI”
IP Address	Modifiable, default as “192.168.1.1”

If it’s necessary to modify SSID and IP address, click “Set” after modifying, then restart the printer.

WIFI Config ✕

Module MAC: 88:83:5D:E4:DF:C4

Module Version: 4.0.8

Host Name: printer_sta

Wifi Mode: AP ▾

SSID: POS_WIFI

IP Address: 192.168.1.1

Password: *****

Show password

Read Set

Restore Factory Setting

■ When using the STA mode, take the printer as a terminal. The PC or mobile devices and printer need to be on the same LAN.

- Choose STA under Wi-Fi mode, the interface is shifted to the following screenshot:

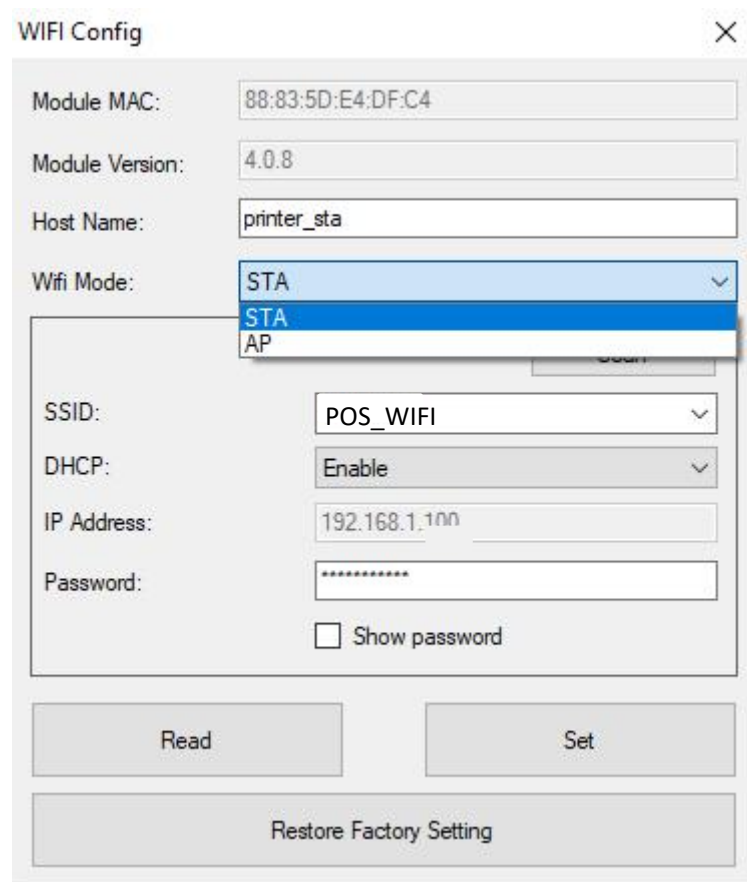

- Click “Scan”, choose a connectable “hot spot” from SSID options. type in the password of Wi-Fi that you want to connect to.
- Click “Set”. After it is set successfully, the printer would restart automatically.

SSID	The SSID name that is chosen after scanning “hot spot”
DHCP	Enable/Disable dynamic allocation of IP
IP Address	When DHCP is at Enable status, IP address will be allocated automatically, no need to do the setting; When DHCP is at Disable status, IP address must be set to the same LAN with the Wi-Fi that you connect to
Default gateway	When DHCP is at Enable status, default gateway will be allocated automatically, no need to do the setting; When DHCP is at Disable status, default gateway can be input
Subnet mask	When DHCP is at Enable status, subnet mask will be allocated automatically, no need to do the setting; When DHCP is at Disable status, subnet mask can be input

- After the printer is restarted, short press the power button 3 times, so that the current Wi-Fi parameter information can be printed.
- After completing the setting, connect the computer to the Wi-Fi that the printer connects to, click “Modify Printer”, choose “TCP/IP”, and set the IP address the same as the printer’s IP address, then click “OK”. **(Following Screenshot takes TP808 as an example)**

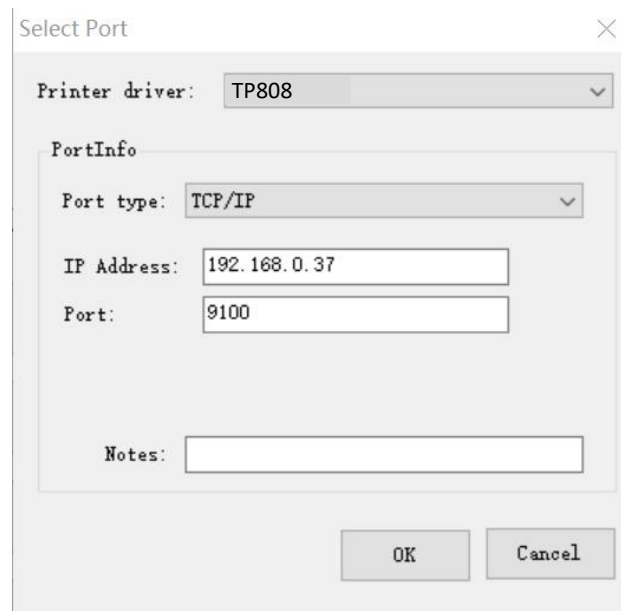
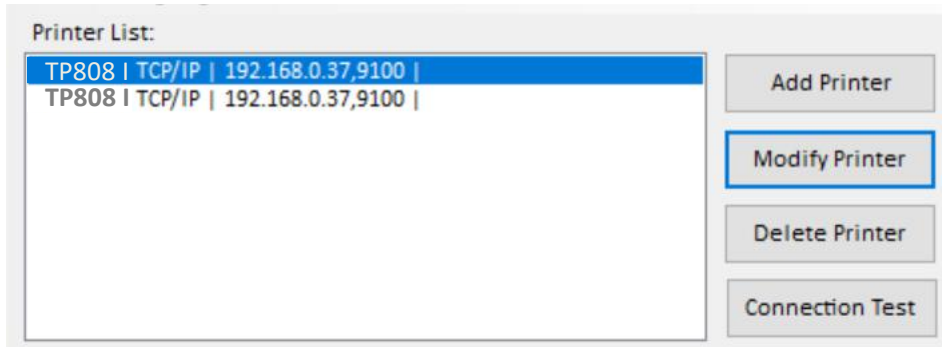

- Click “Connection Test” to check if the setting is successful.





Notes: When the printer is failed to connect with its master devices, please check if the settings are correct, and please check if the master devices and the printer are on the same network segment. When parameter setting error occurs, which leads to the failed connection, please reset the Wi-Fi parameter by the following way 1) or 2):

1) For TP808 (with built-in Wi-Fi module), shortly press the power button five times, so that the Wi-Fi parameter would be reset. The printer would restart automatically, so the reset is taken into effect.

2) For other models of POS printers (with external Wi-Fi module), shortly press the Function/Reset Button (at the interface board) for five times, and the Wi-Fi parameter would be reset. The printer would restart automatically, so the reset is taken into effect.

9.3 Firmware Update

1) Click “FW Update”.

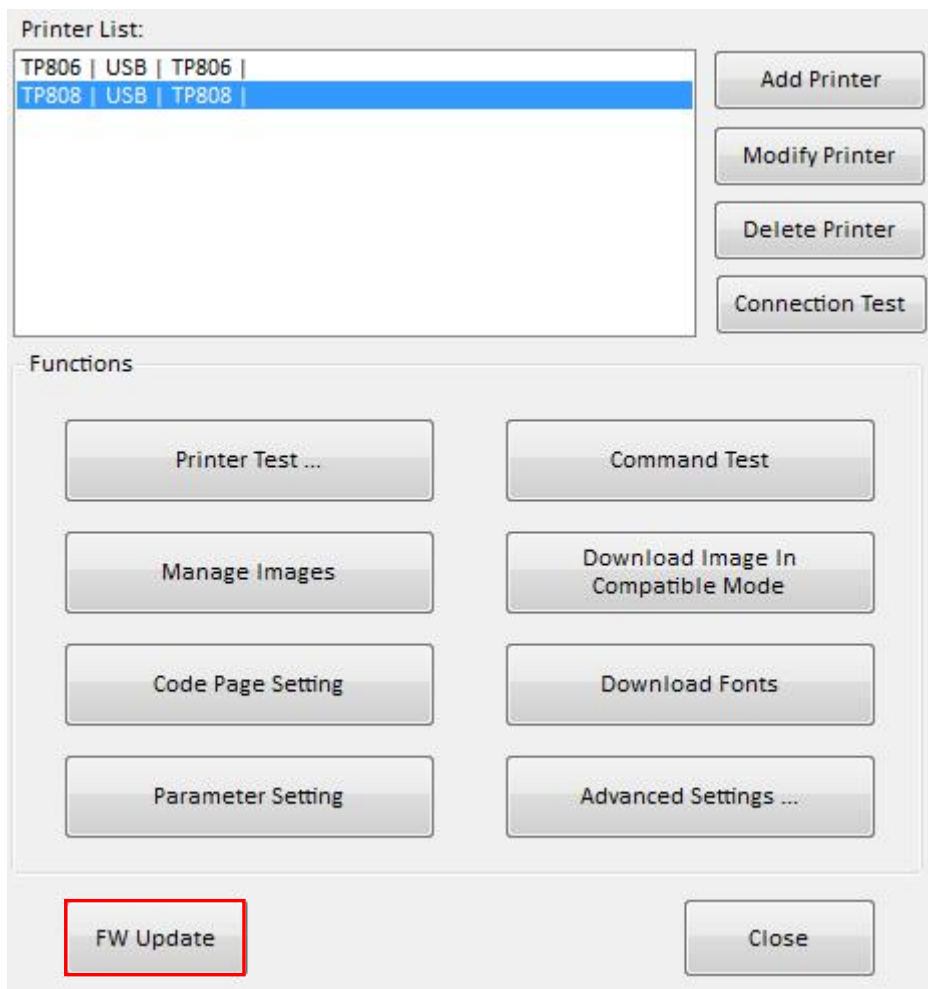

2) When the device appears "Printer", select the Dfu file.

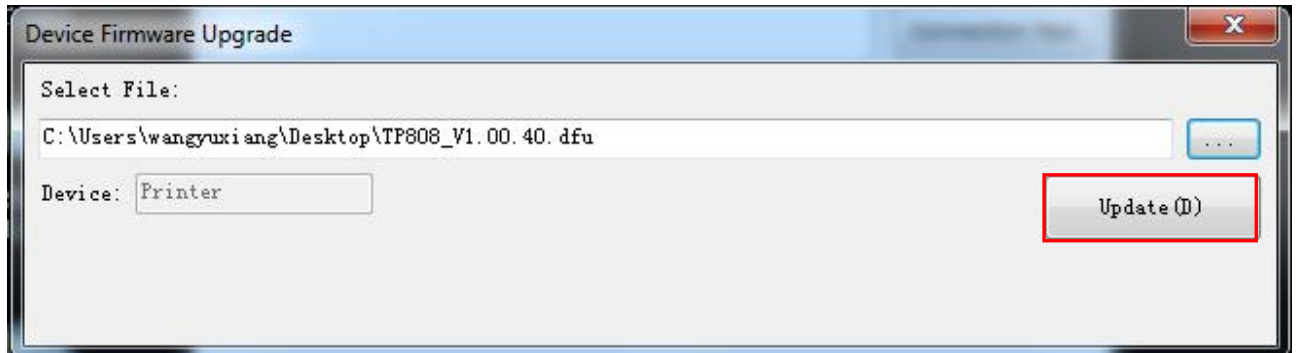

3) Click "Update".

4) Update success.

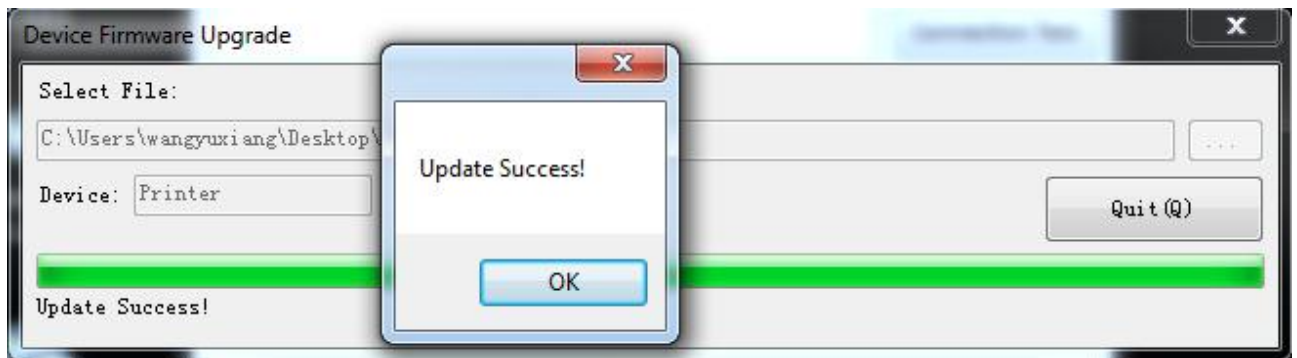

5) Restart the printer.

10 WINDOWS DRIVER

10.1 Information

This Windows Driver Installation Manual provides information on installation, detailed specifications, and usage of the printer's Windows Driver according to PC operating system (OS).

We maintain ongoing efforts to enhance and upgrade the functions and quality of all our products. As follows, product specifications and/or user manual content may be changed without prior notice.

10.2 Operating System (OS) Environment

The following operating systems are supported for usage.

- Microsoft Windows 10 (32 bit/64 bit)
- Microsoft Windows 8 (32 bit/64 bit)
- Microsoft Windows 7 SP1 (32 bit/64 bit)
- Microsoft Windows Vista SP2 (32 bit/64 bit)
- Microsoft Windows XP Professional SP3 (32 bit)
- Microsoft Windows Server 2012 (64 bit)
- Microsoft Windows Server 2008 R2

10.3 Windows Driver Preparation

The Windows Driver is included in the enclosed CD. If the order doesn't include the CD, please follow the link <http://www.hpert.com/Downloads.html> and find the product name you want (for example TP808), then you can download Windows Driver and other items.

The Windows Driver installation file name is HPRT_POS_Printer_Driver-v-X.X.X.X.exe

X.X.X.X indicates the version number, which is updated from time to time.

Eg. : HPRT_POS_Printer_Driver_v2.7.3.0.exe

10.4 Windows Driver Installation



Warning:

Under different operating system, the screen has slight difference. Please operate it according to the tips. Take TP808 (Windows 7) as example.

- (1) Double click Windows Driver.
- (2) Choose “I accept the agreement” and click
- (3) “Next”.

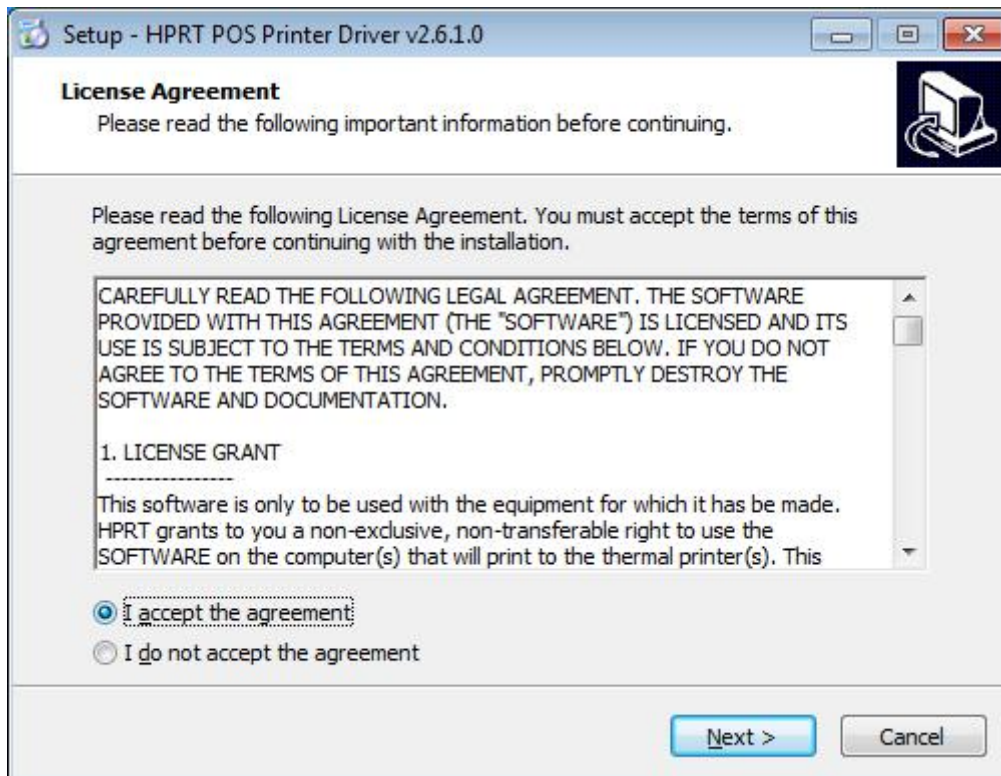

(4) Click "Next"

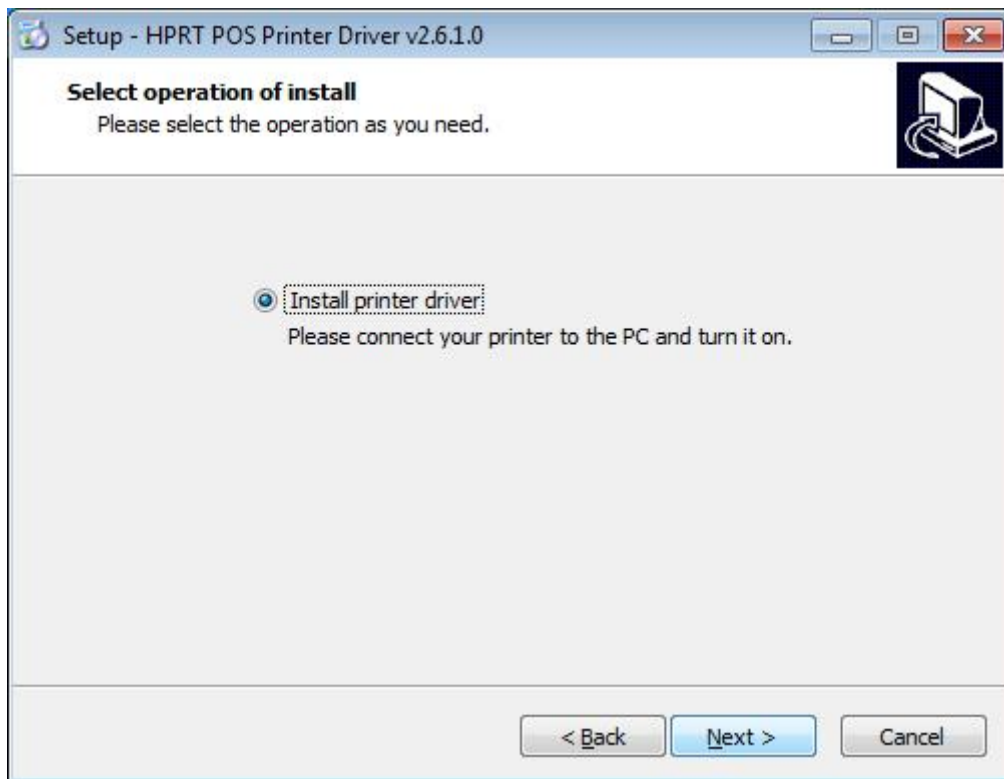

- (5) Choose the matched type and port (USBxxx is for USB port, COMx is for serial port, LPTx is for parallel port). Choose the type and port of driver, such as “COM1” as port. Click “Next”.

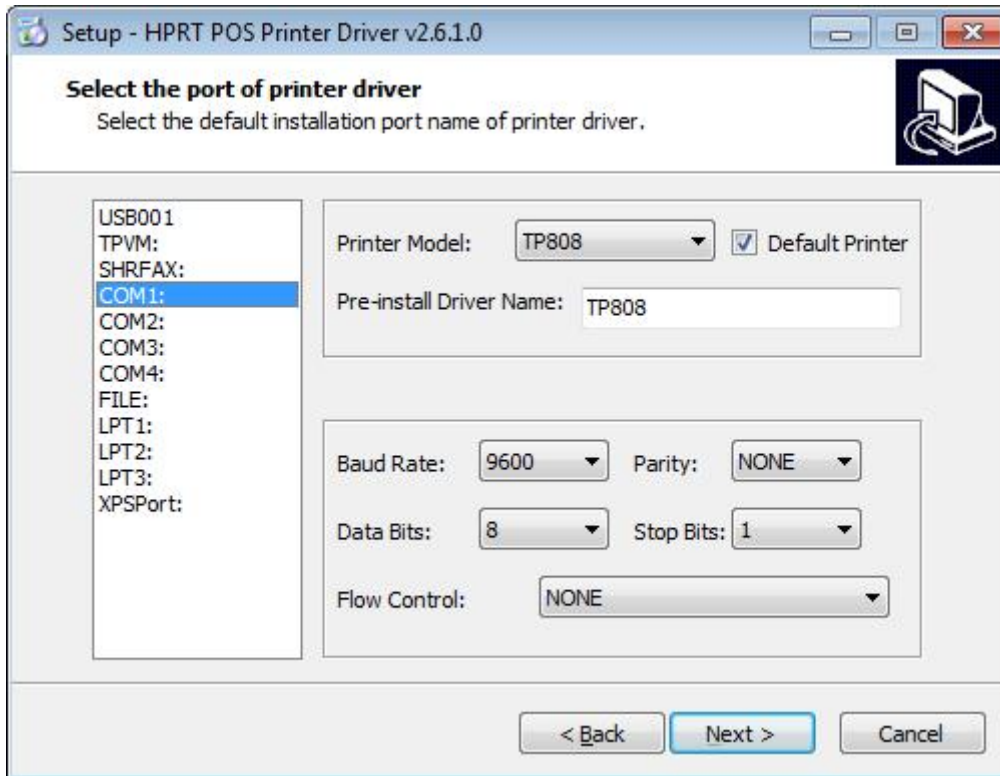

NOTE: If printer is already connected with computer by USB port, it only needs to click “Install”, then it will be installed automatically. Otherwise, proceed to the next step.

(6) Click "Finish". POS printer driver is installed successfully.

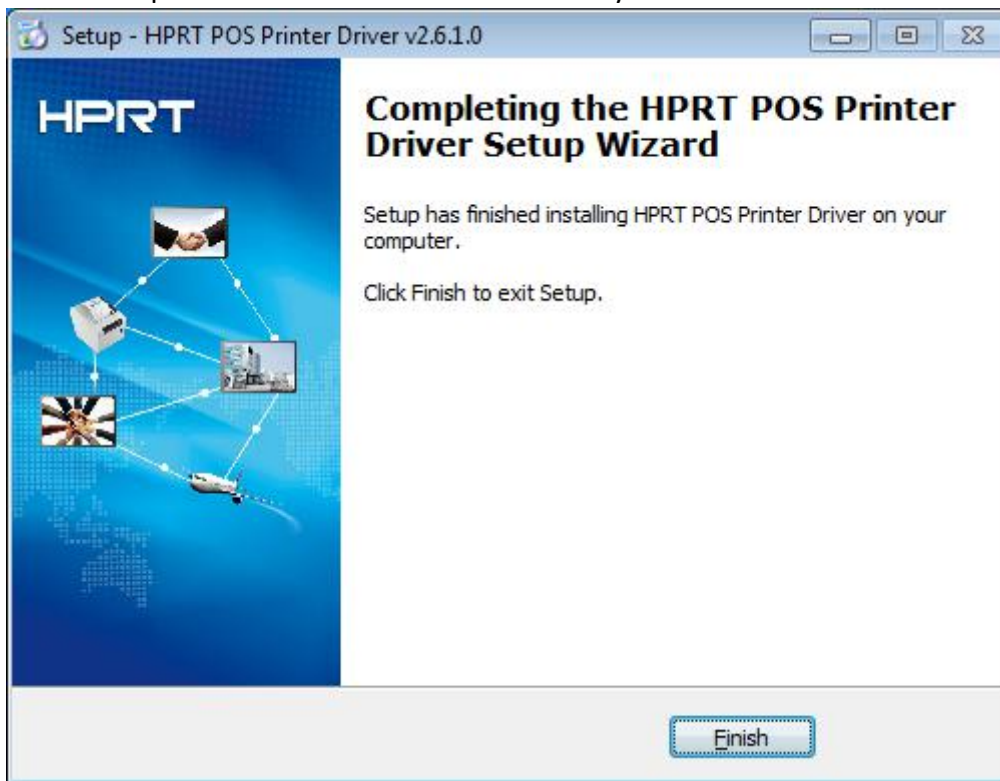

(7) After installation, the icon will be found in "Start" → "Devices and Printers".



NOTE: If you already installed the driver (No matter what kind of port), when you connect the printer with computer, it will create a USB port automatically.

10.5 Detailed Windows Driver Setting

10.5.1. Printing Preferences

1. Click "Start" → "Devices and Printers". Right click "TP808" and choose "Printing preferences".

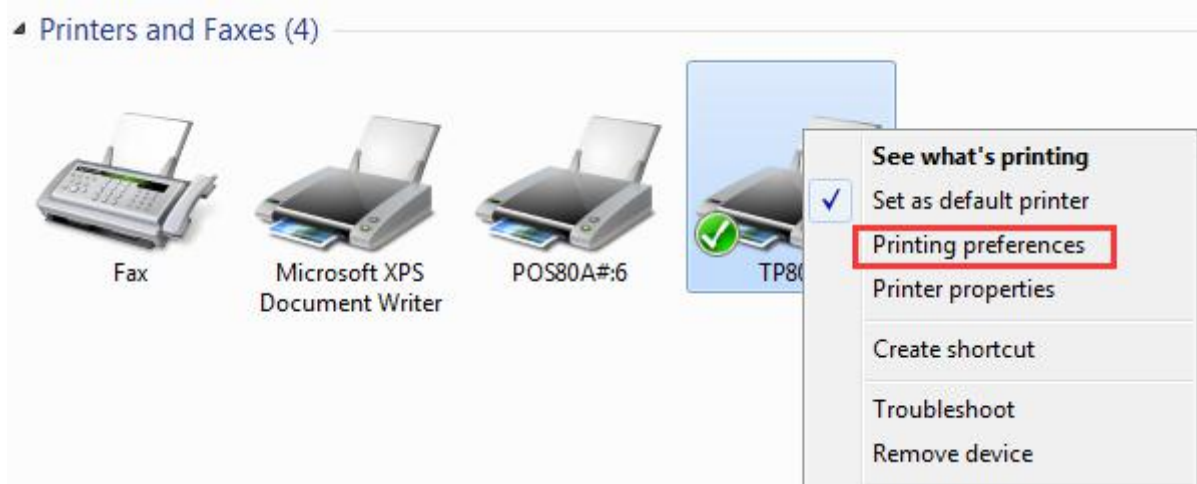

2. According to the different needs, choose “Paper”\“Offset”\“Rotate”\“Effect”\“Copies” in “Page”.

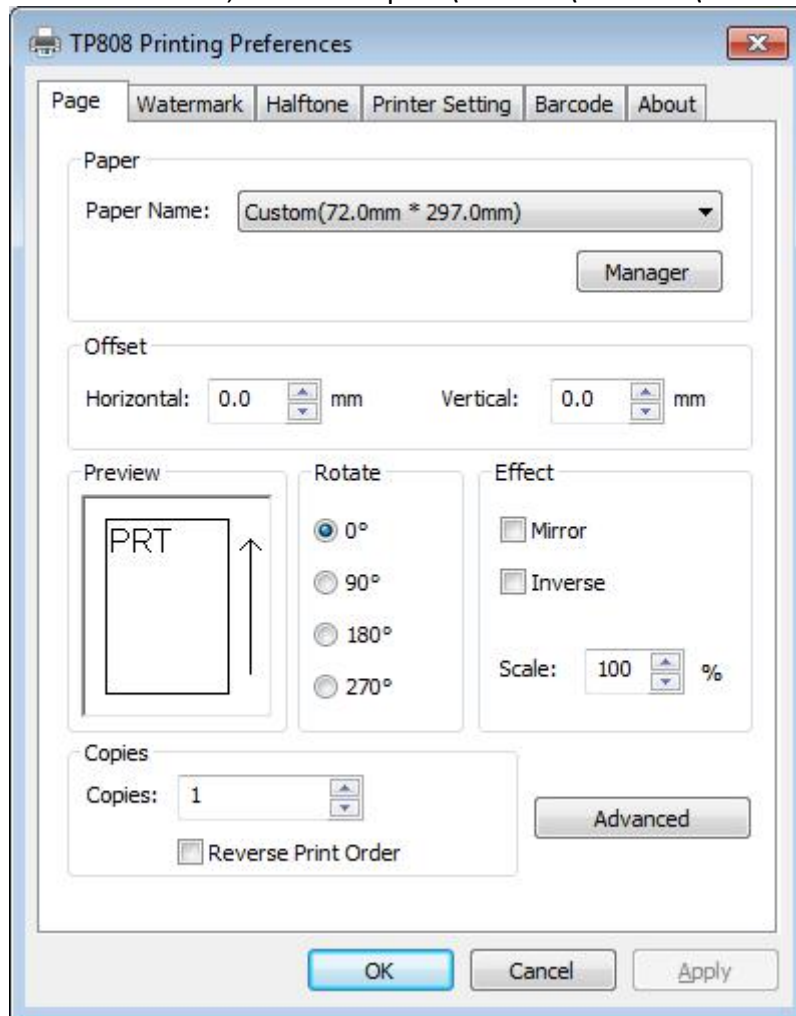

1) Paper

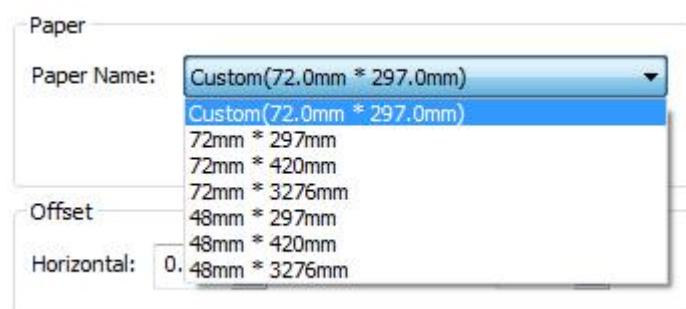

2) Offset



- Click “Manager”, add or delete paper.

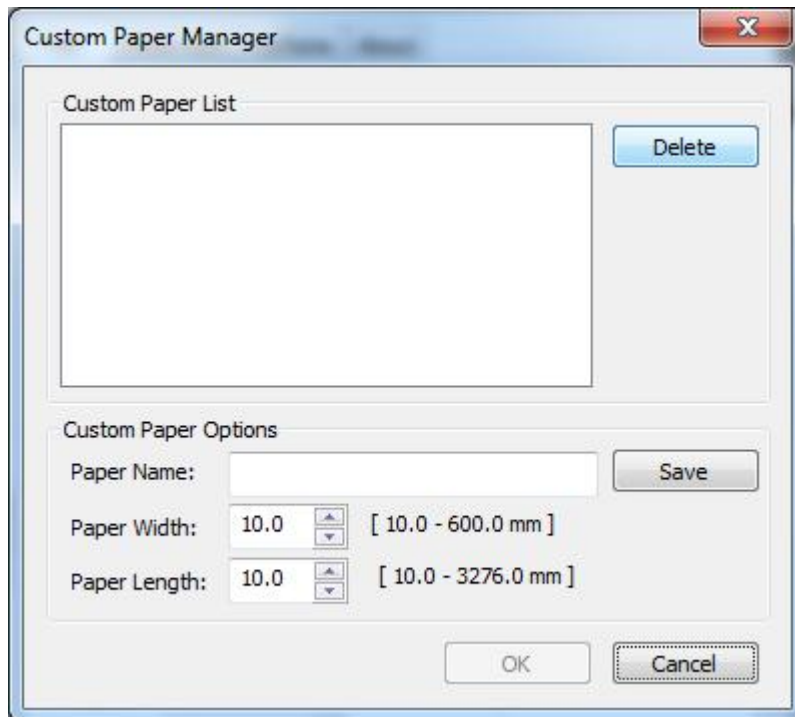

- Click “Advanced” to set “Save Paper”, “Cut Paper”, “Feed Paper”, “Cash Drawer”, “Custom Command”, “Logo”, “Buzzer”, “Code Page”.

1) Save Paper

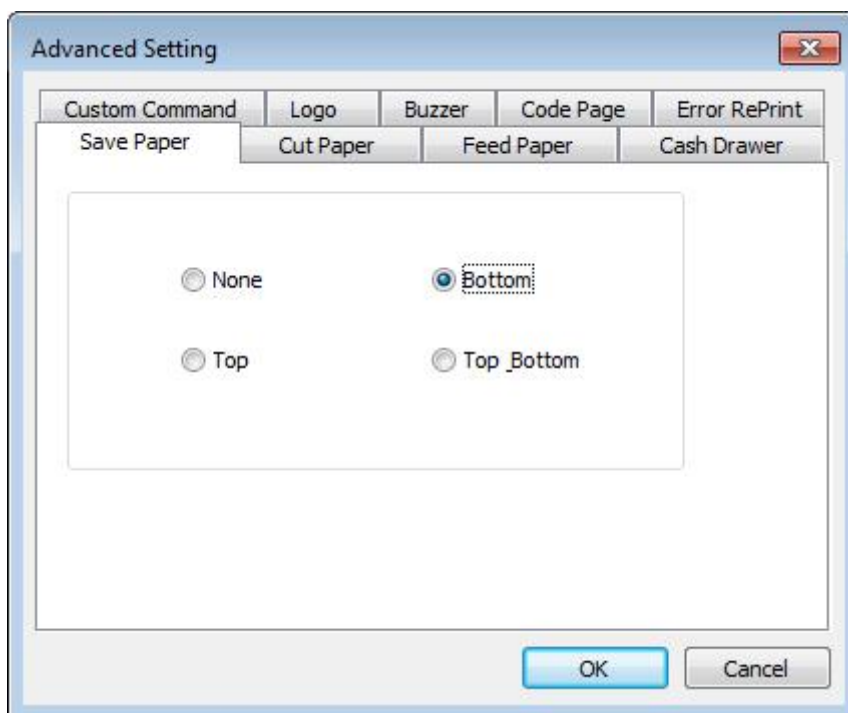

2) Cut Paper

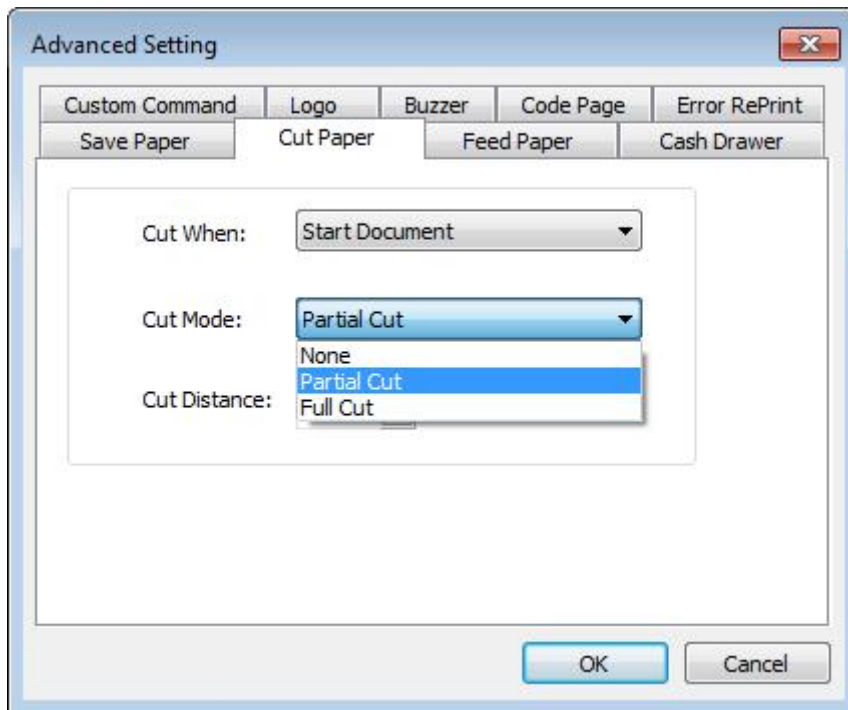
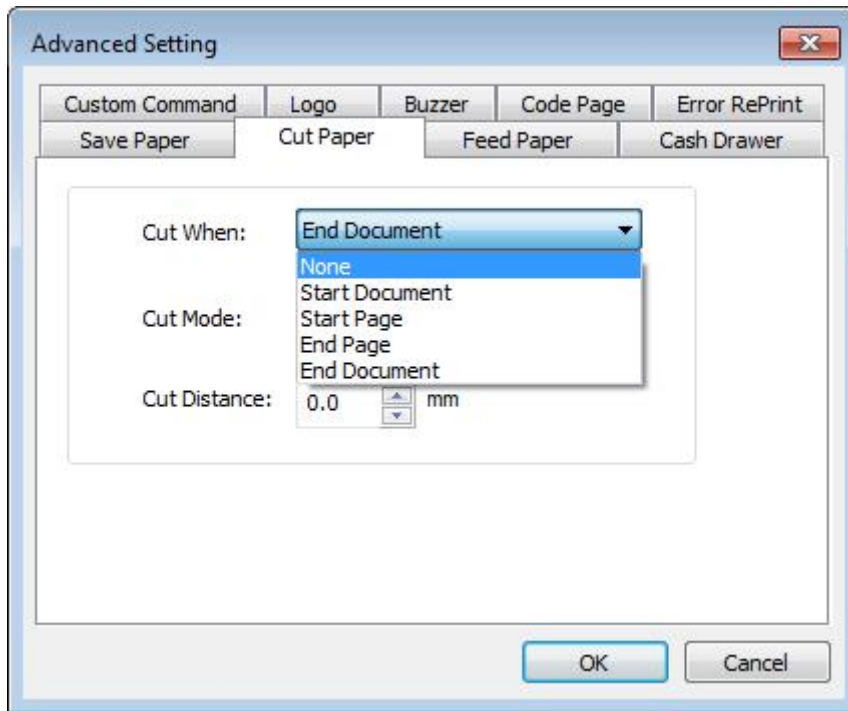

Cut Distance: 0/5/10/15/20mm (End Document)

3) Feed Paper

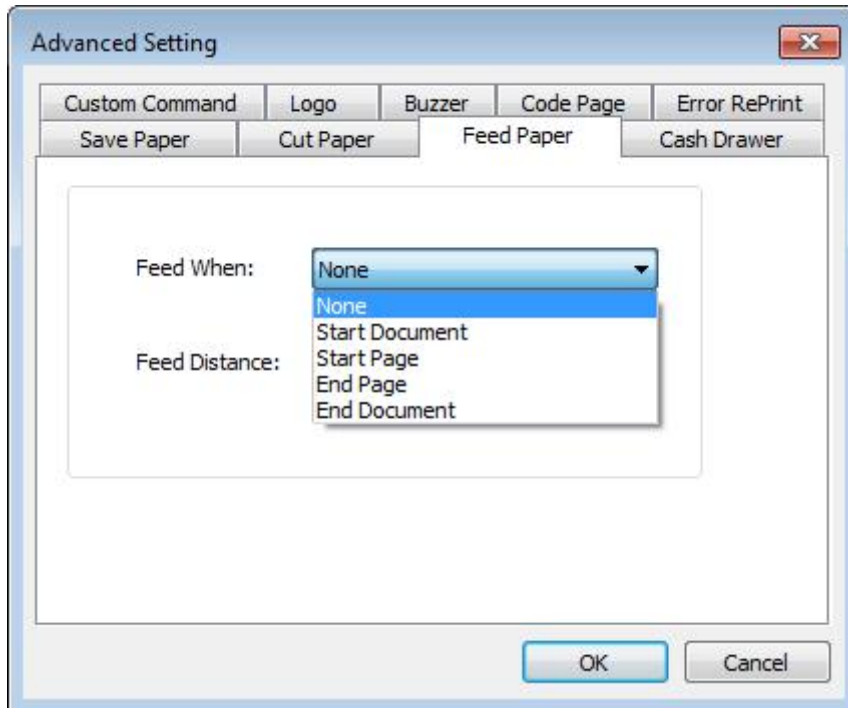

Feed Mode: Feed Automatically/Cut Automatically/Cut Automatically Per Page/None
 Feed Distance: 0/5/10/15/20mm (End Document)

4) Cash Drawer

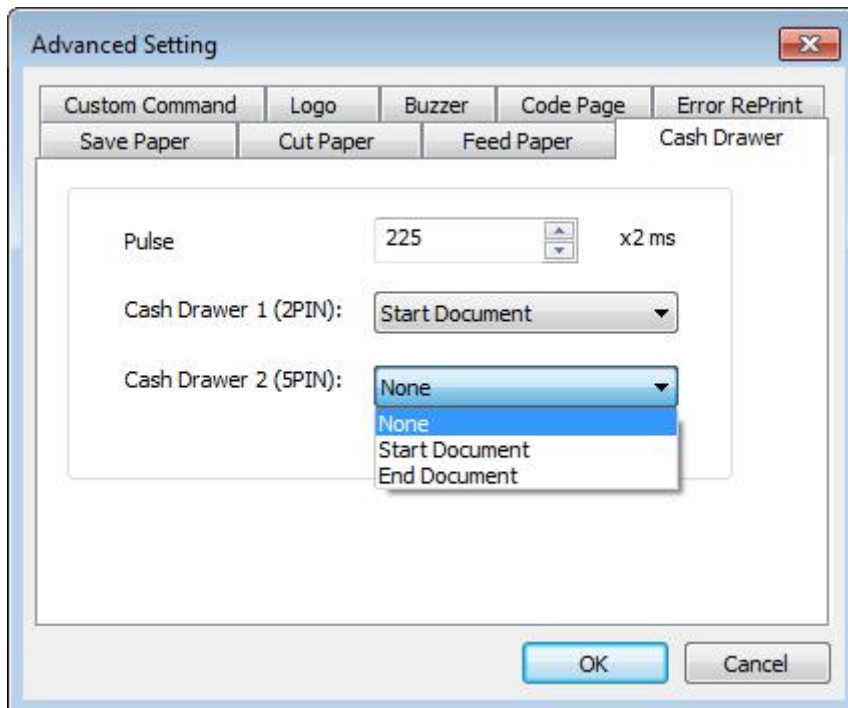
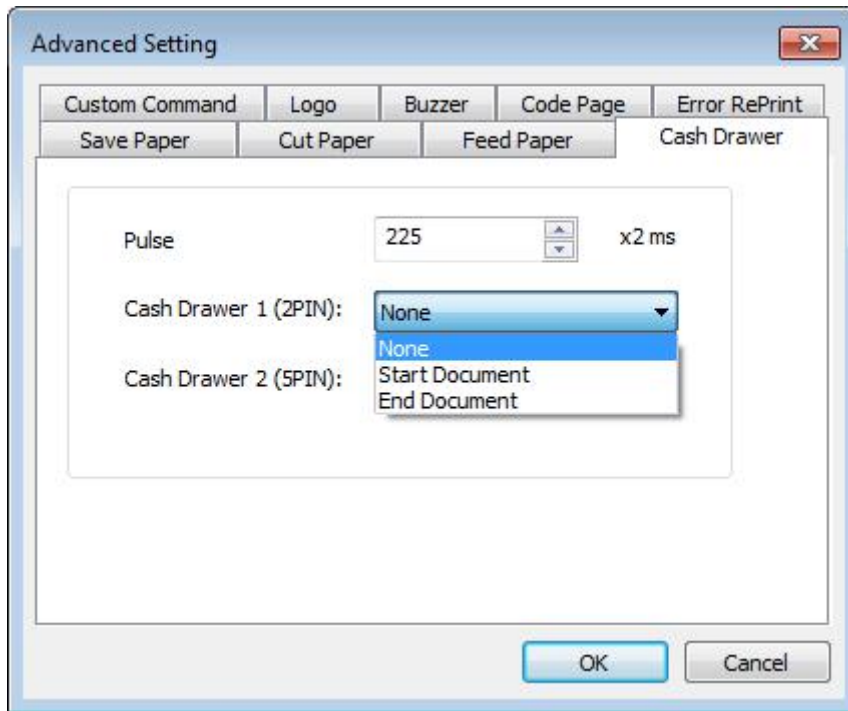

5) Logo

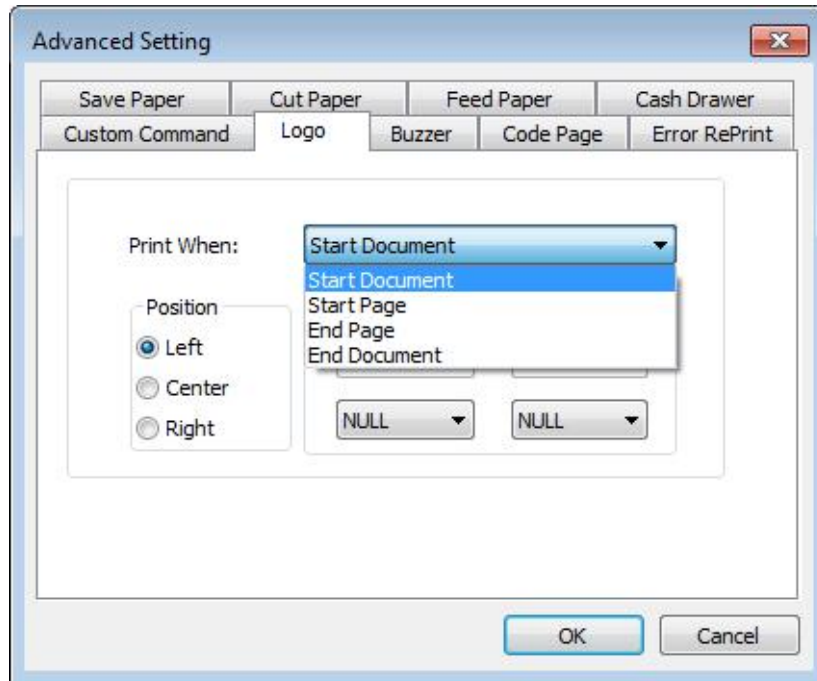

Note: This setting need to be set in utility, here are the steps:

- 1) Open the utility and click "Manage Images".

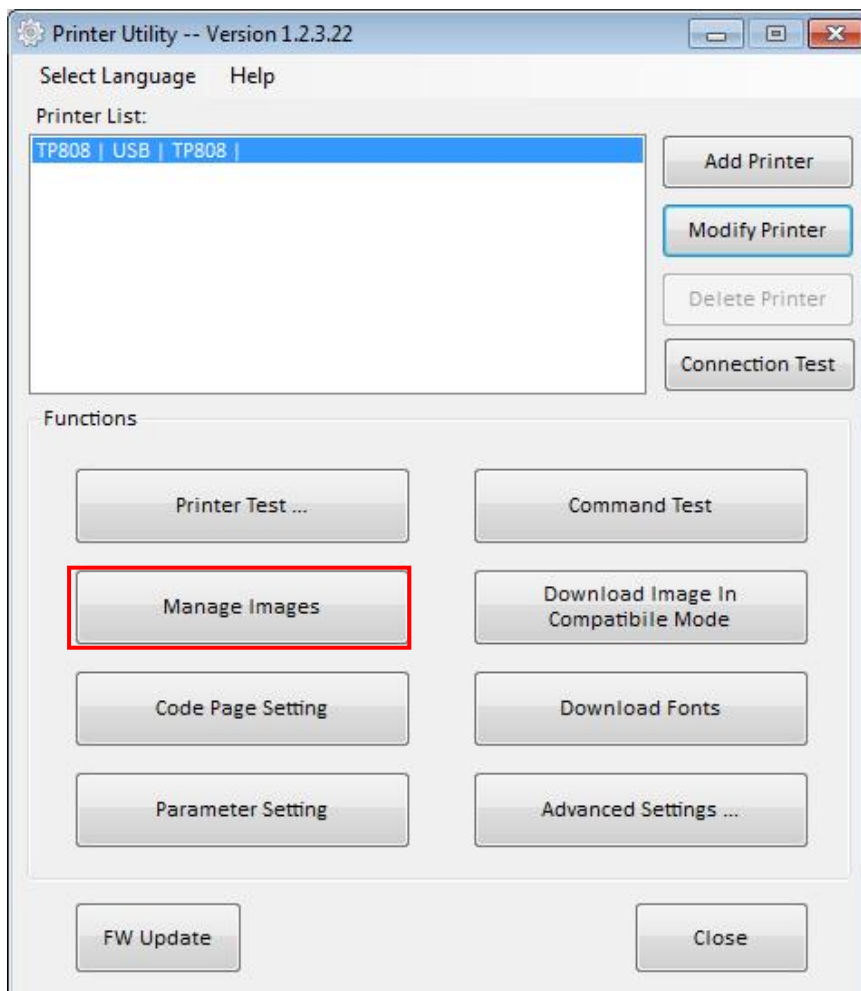

2) Click "Download".

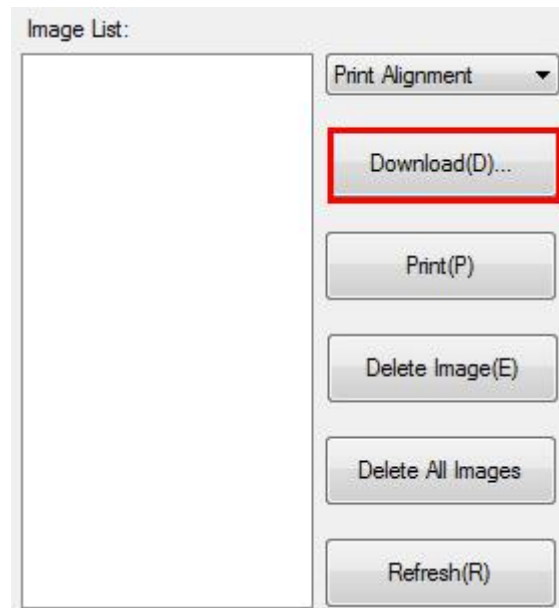

3) Click "Add" to add a logo. (BMP format is recommended)

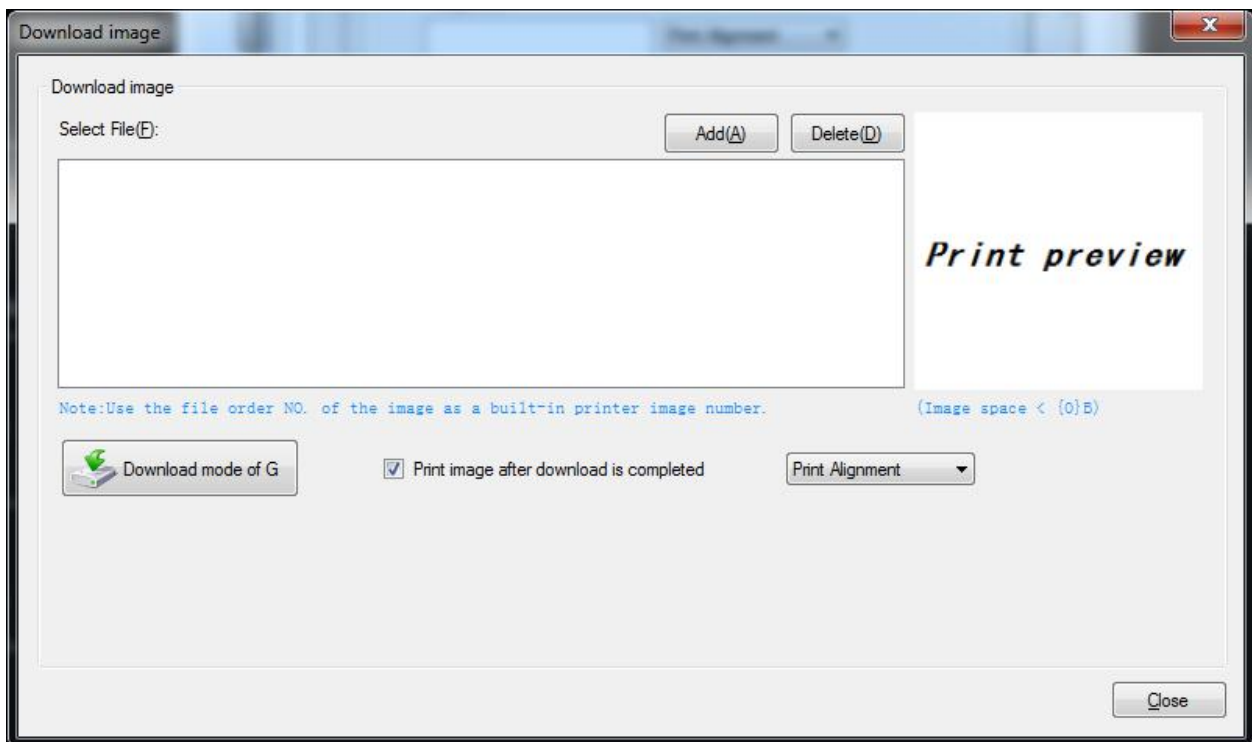

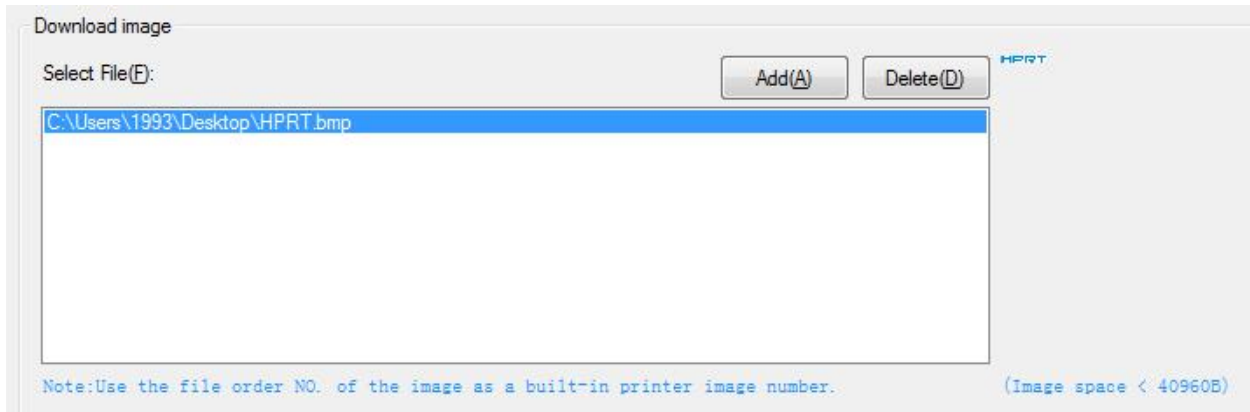

4) Select the print location, and then click "Download mode of G". (Such as: left print)

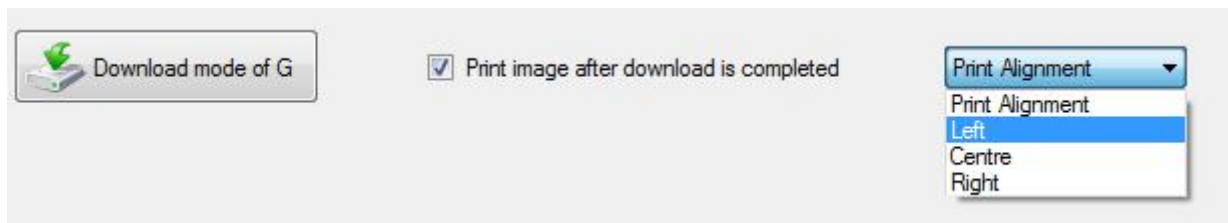

5) Return to image list to view the image number.

Note: each time click "Download mode of G", an image list number will be generated.



6) Select Printer properties in Devices and Printers, then click "Preference".

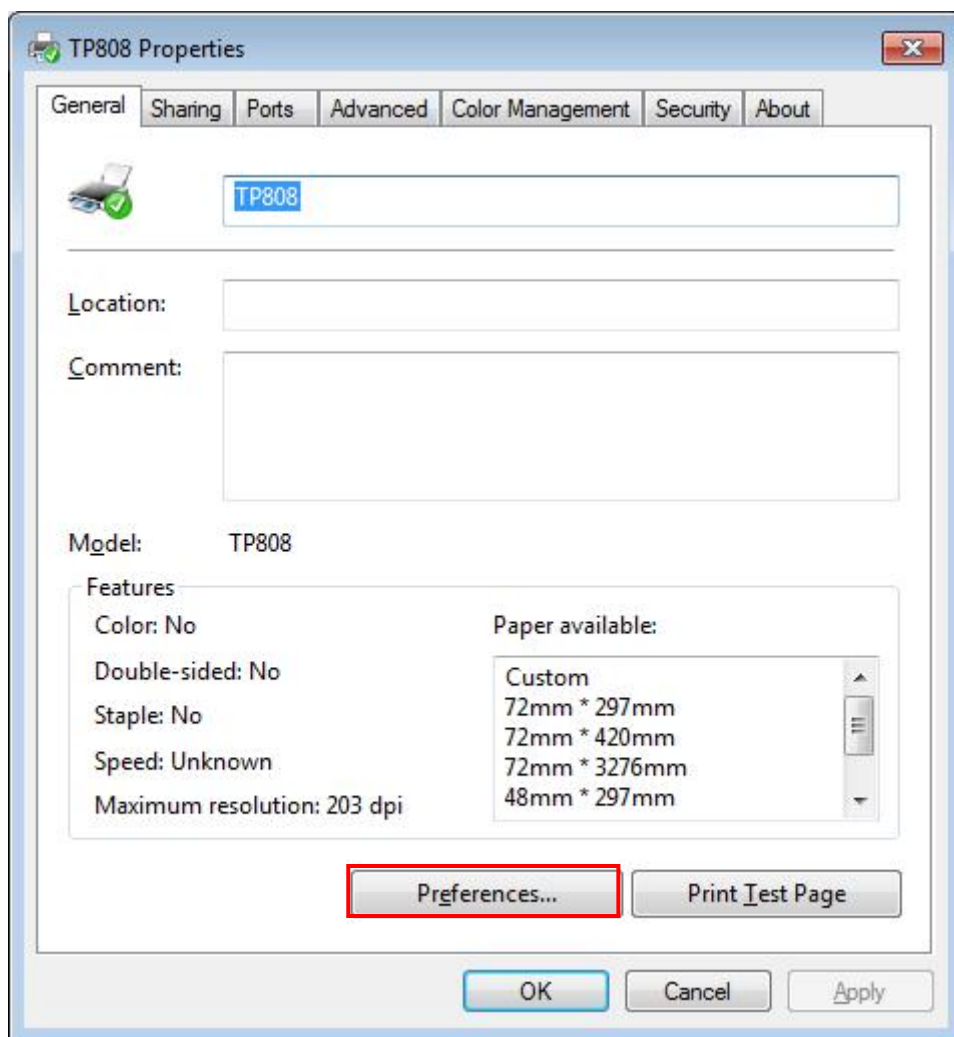
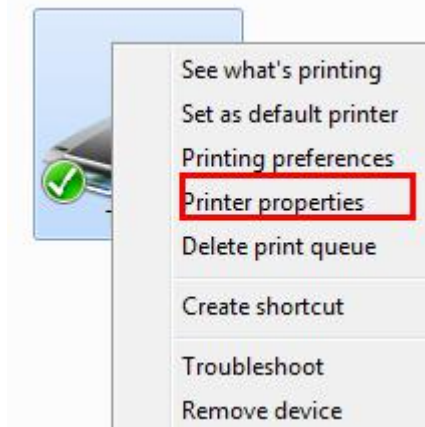

7) Click the “Advanced”, then click “Logo”.

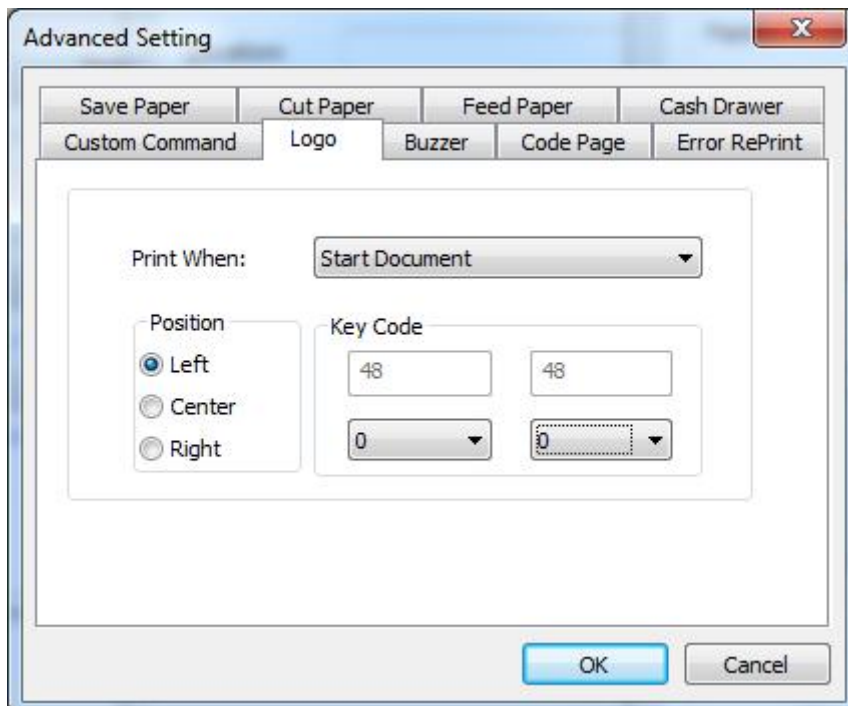
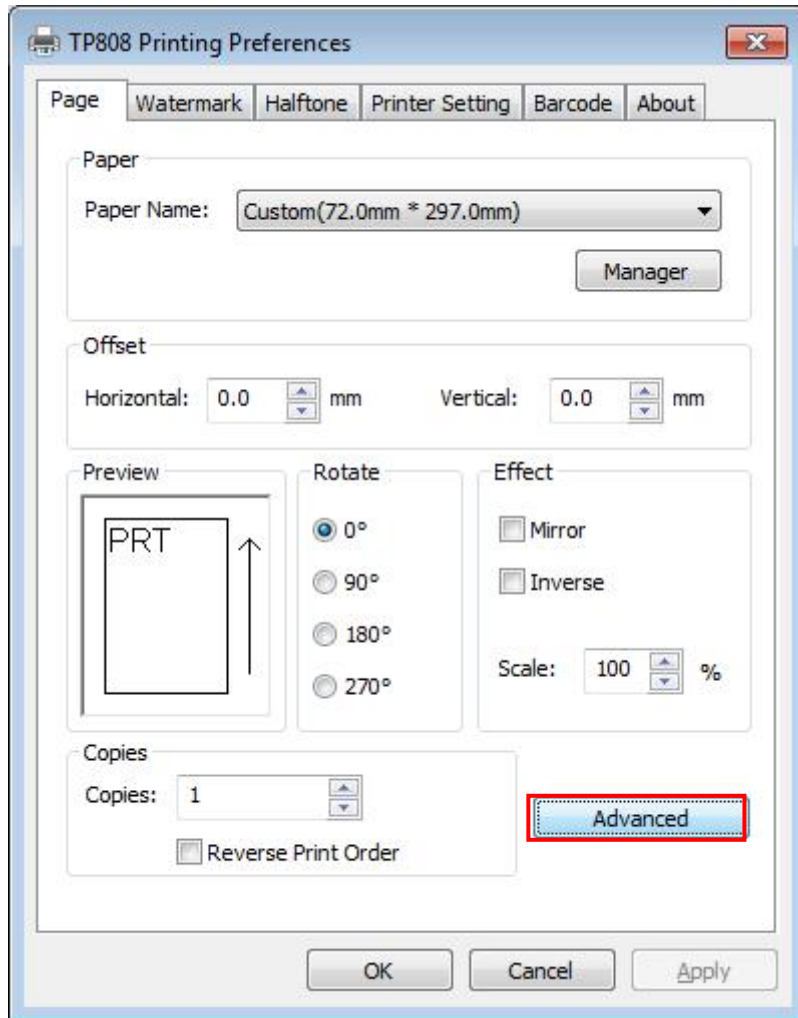

8) Set the printing time to print and click "OK". (Such as: Start Document)

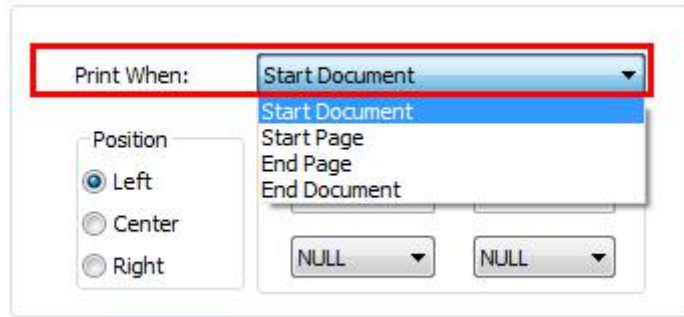

9) Return to the logo setting in driver, also select "Print left".



10) Set the key Code according to the image number. (Such as: 0 0)

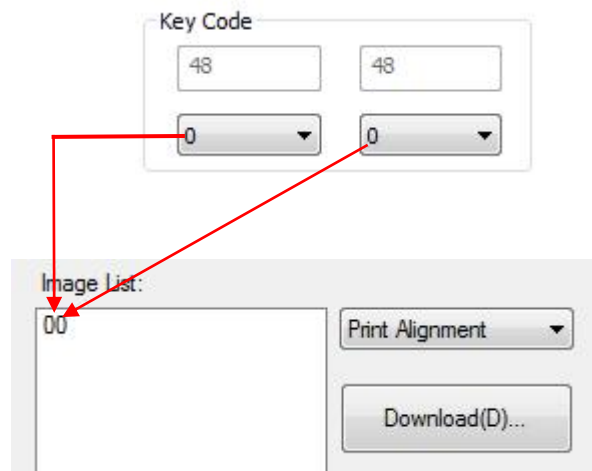

11) Then click "OK".

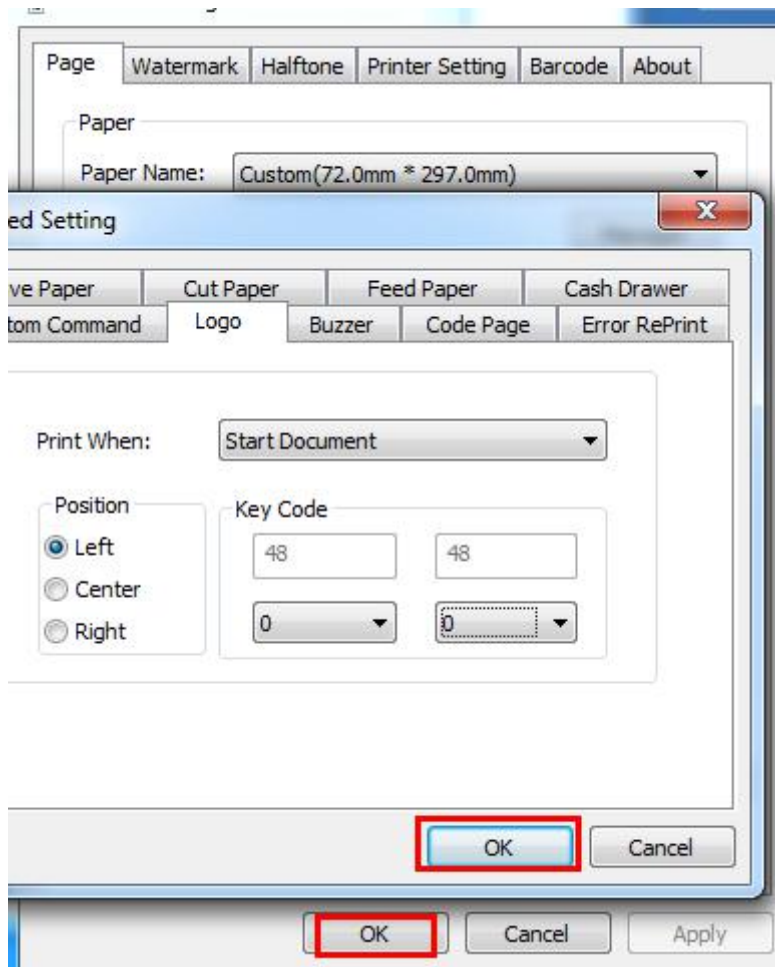

12) Click "Print Test Page" to view the printing effect.

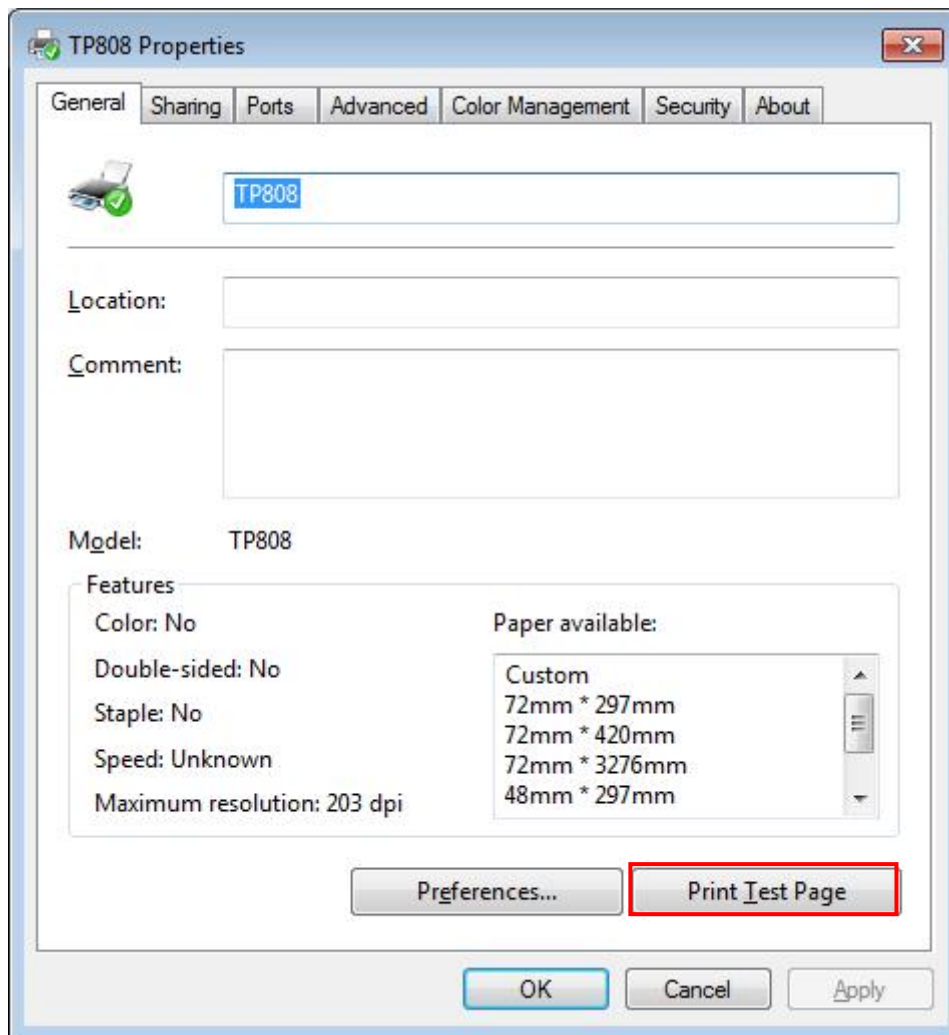

6) Buzzer

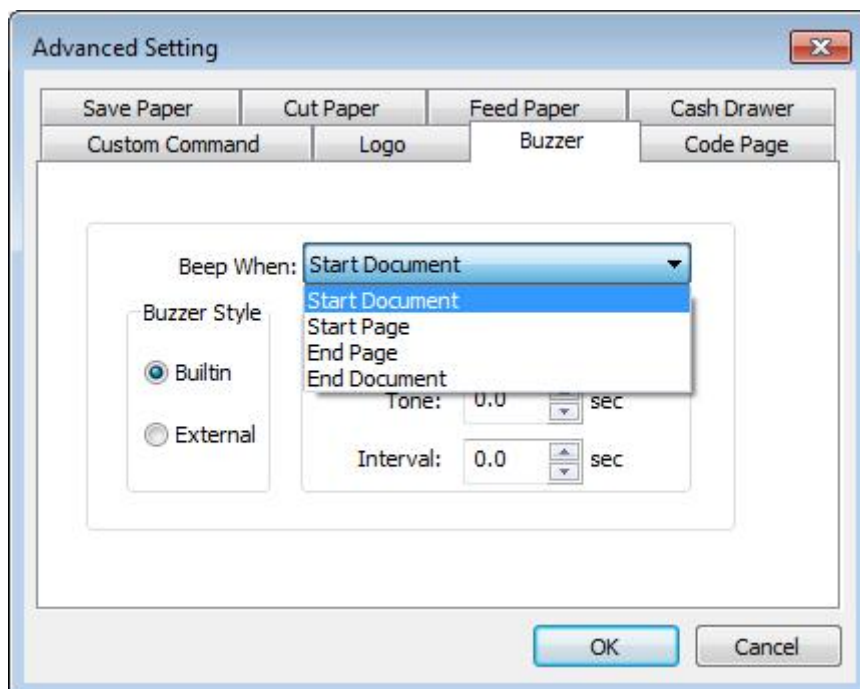
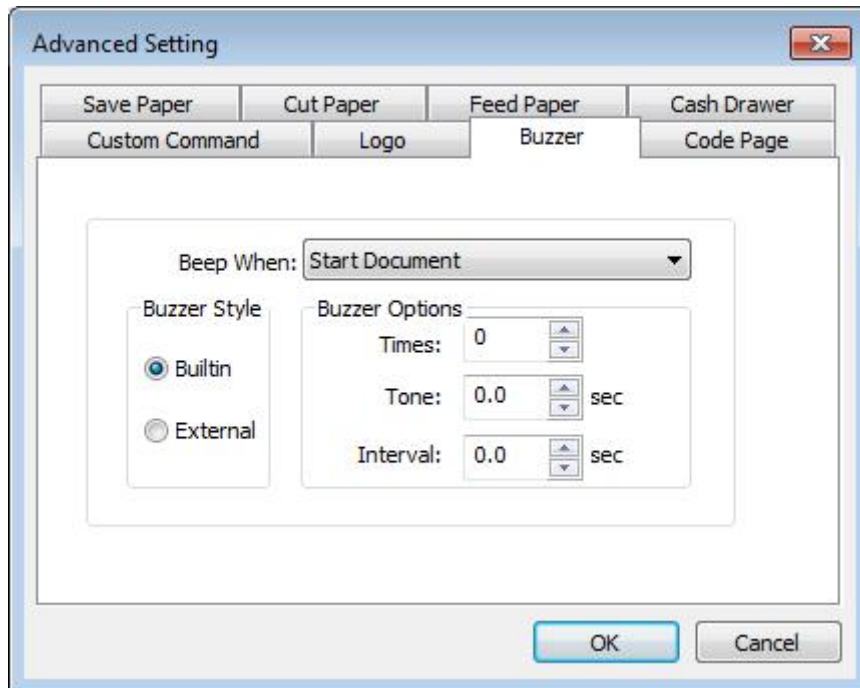

Buzzer times: 0/1/2/3/4/5

Buzzer Duration: 0.0/0.5/1/1.5/2/2.5/3.0 Sec

Buzzer Interval: 0.0/0.5/1/1.5/2/2.5/3.0 Sec

Note: this setting must be operated in Utility.

7) Code Page

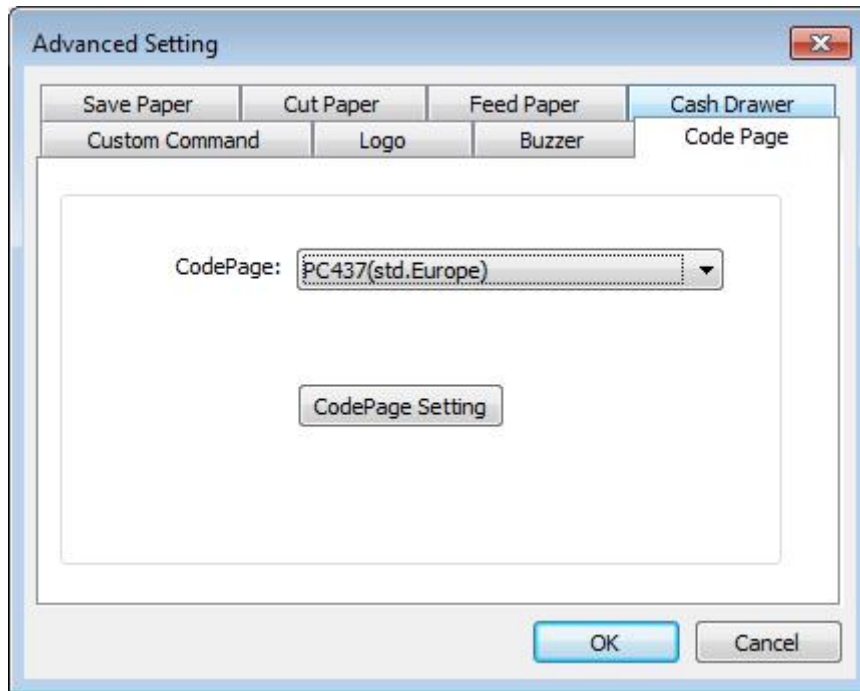

8) Error Reprint

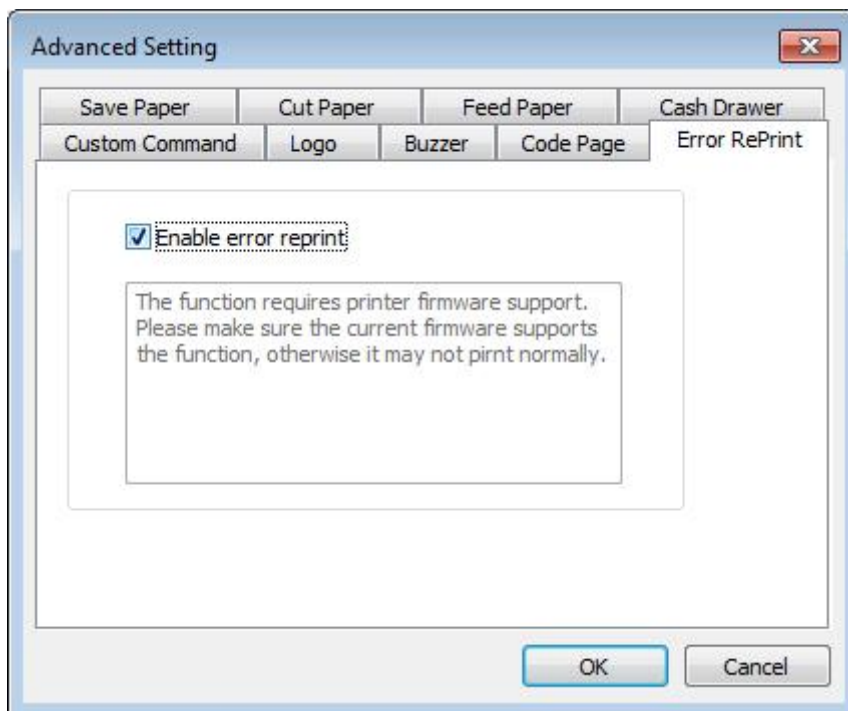

3. Click “Watermark”. Set watermark to print (BMP format is recommended) and click OK to save it.

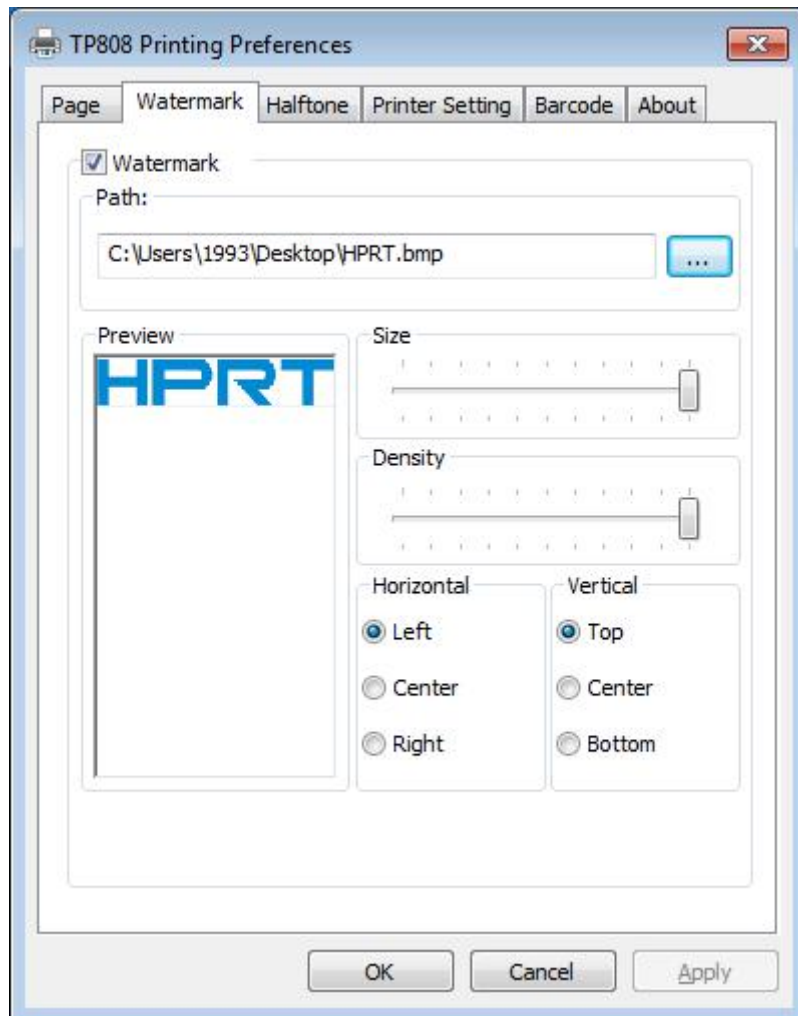

4. Click “Halftone” to set the halftone.

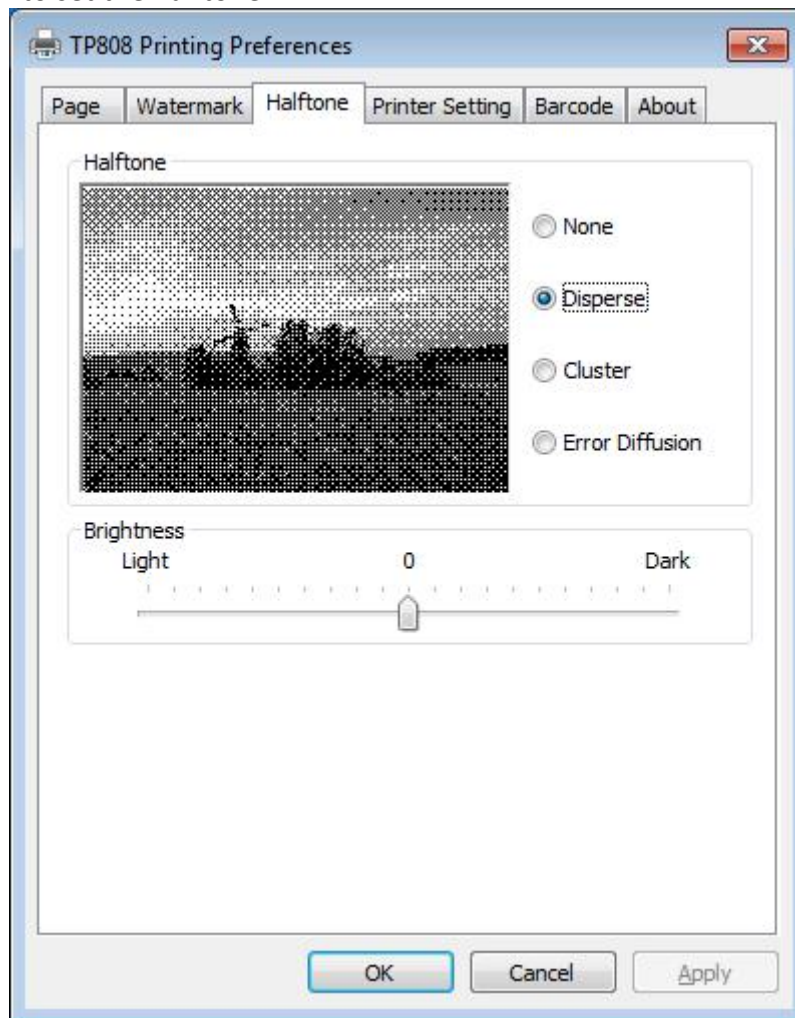

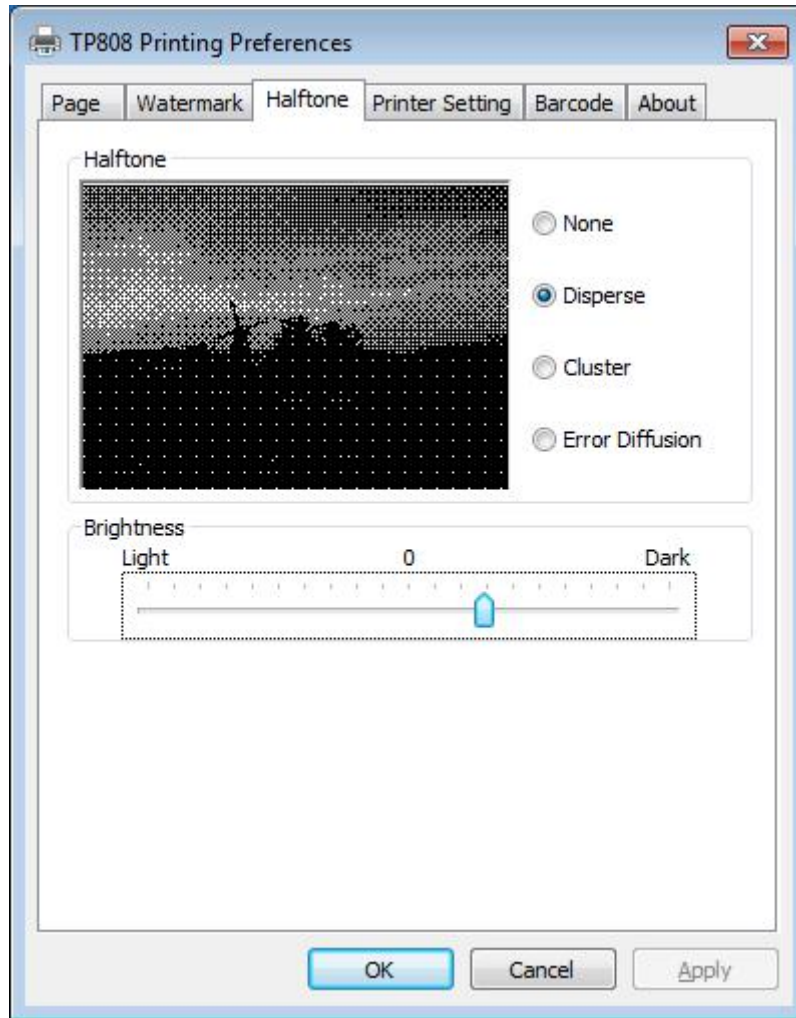

5. Set up the “Barcode”

Assuming the font type of the main document is “Italics”, if you want to convert the data “123456”to the barcode printing, the steps are as follows:

- Sets the data "123456" font type to a different font from the main document. Such as: Arial.

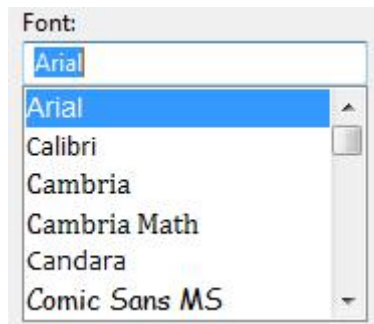
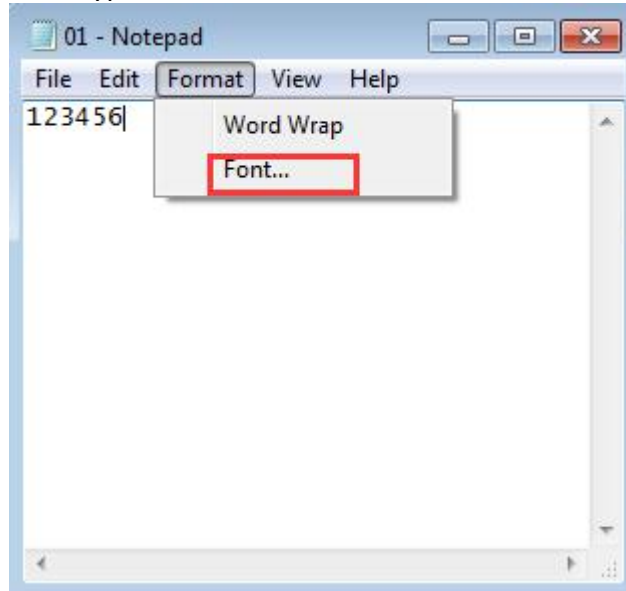

- Open the Preference.
- If the document is open, you can set it in the document: file-print-preferences.

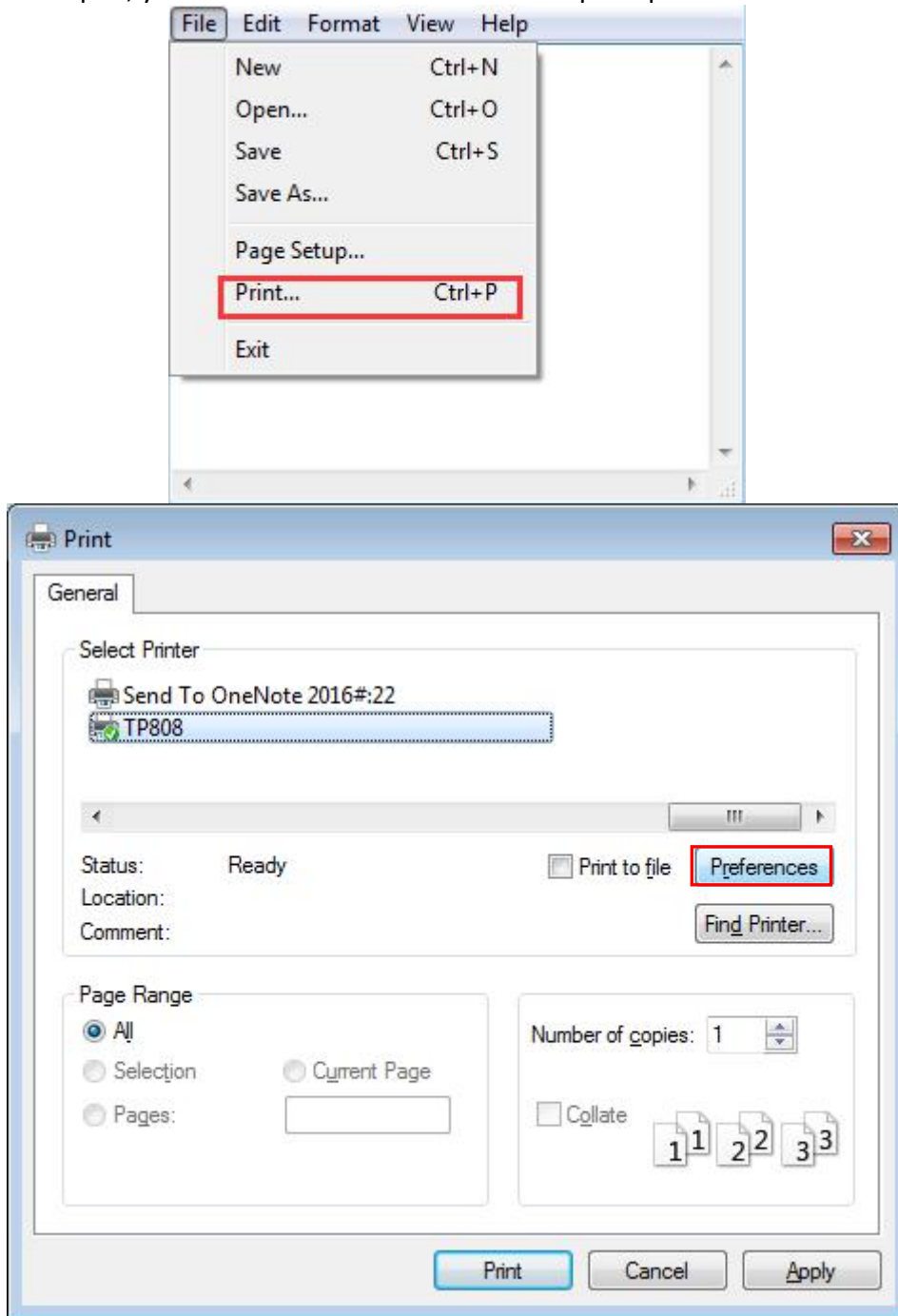

1) Add Barcode firstly.

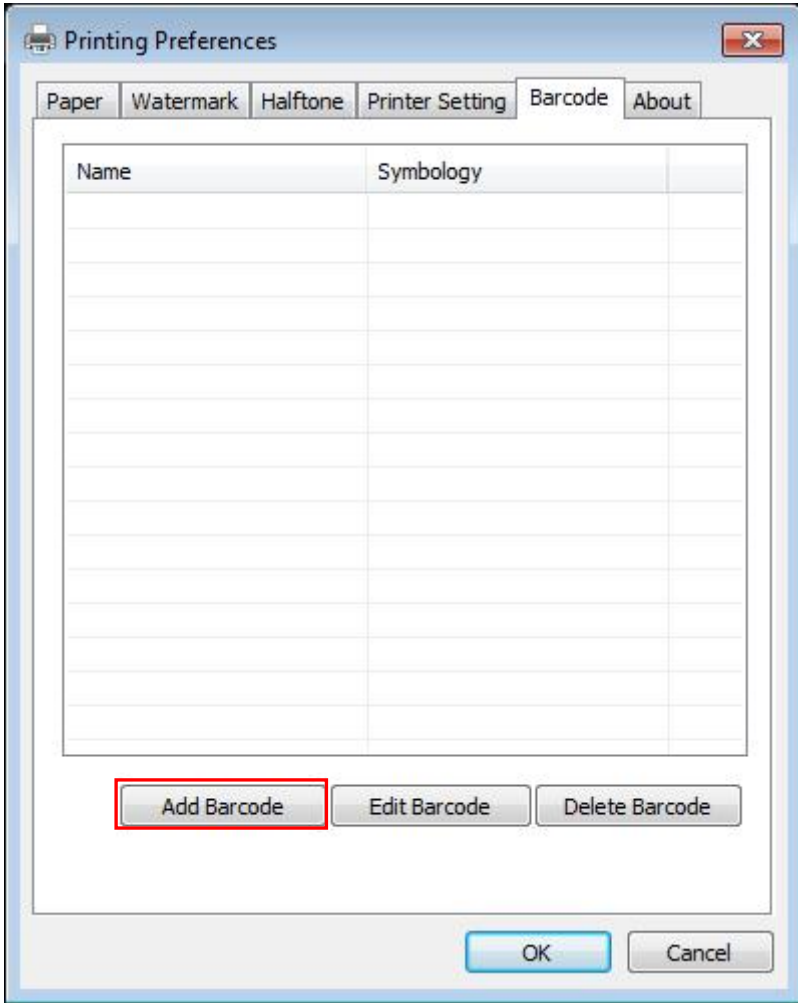

2) Set the "Font Name" and the "Barcode Option".

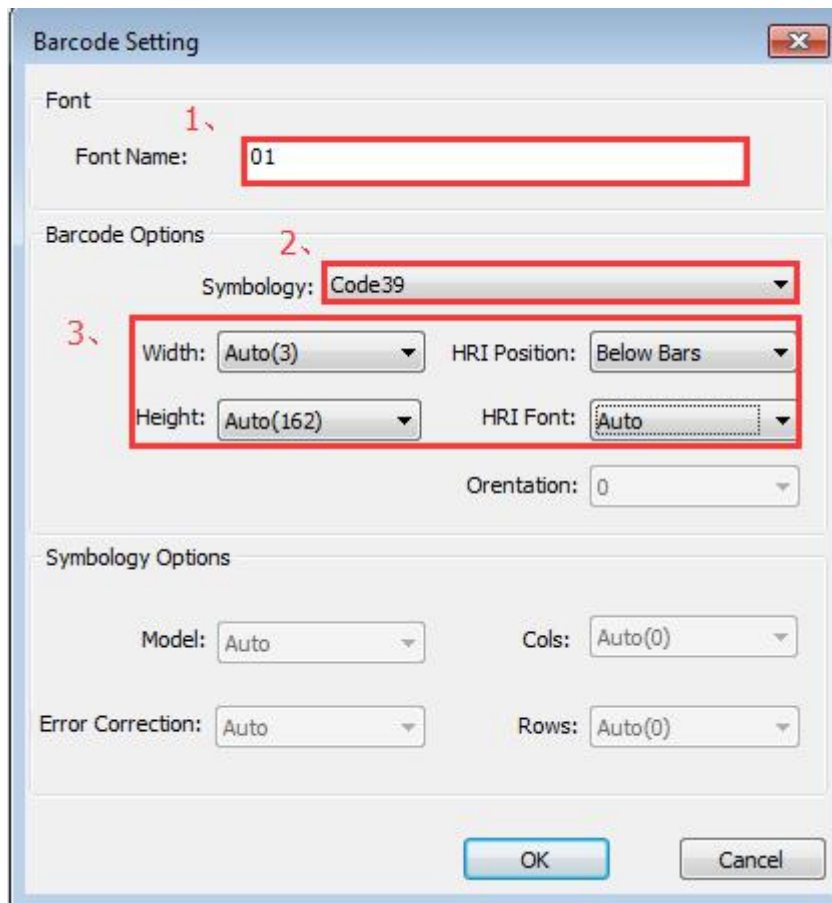

Name	Symbology
01	Code39

- 3) Click the "Printer Setting".
 - Choose the "Display Language for Properties"

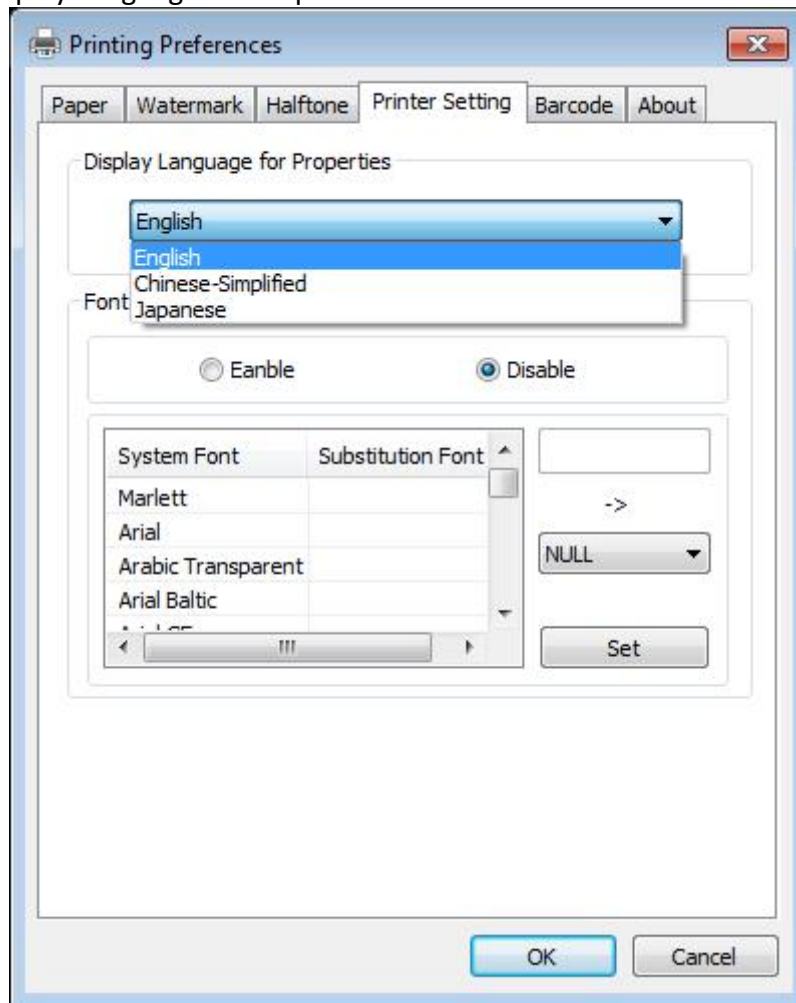

- Turn on the “Font Substitution”, select the system text need to be replaced (for example, Arial), and then select the font you want to replace (for example, 01) and click Settings, and the replacement font will display "01".

the steps are as follows:

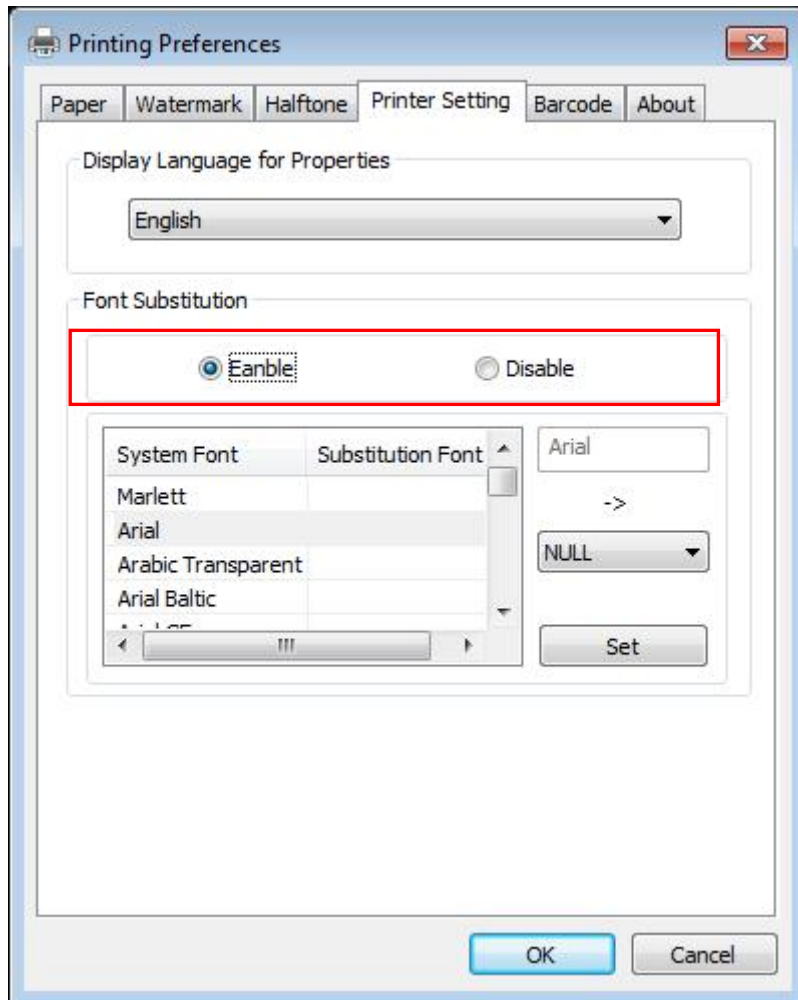

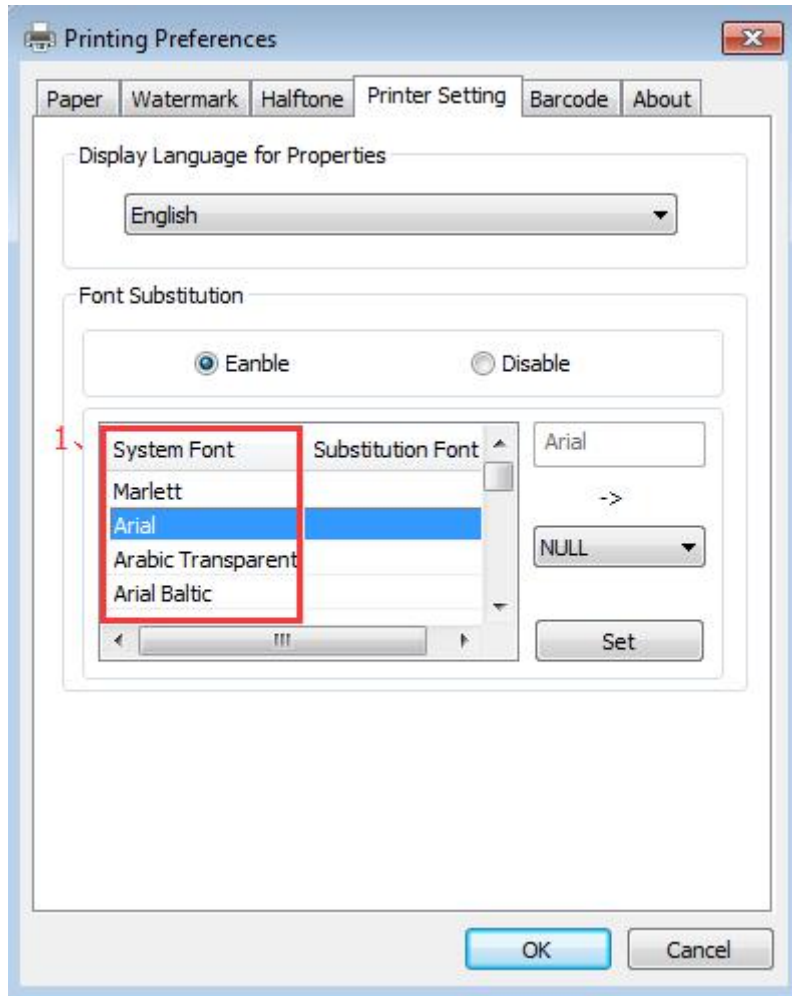

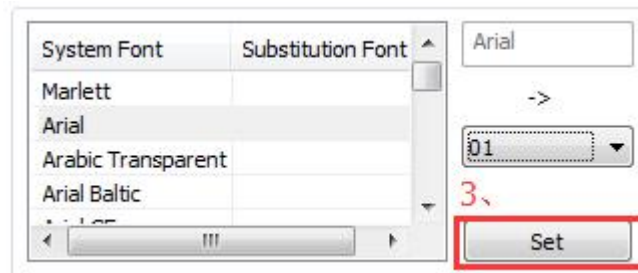
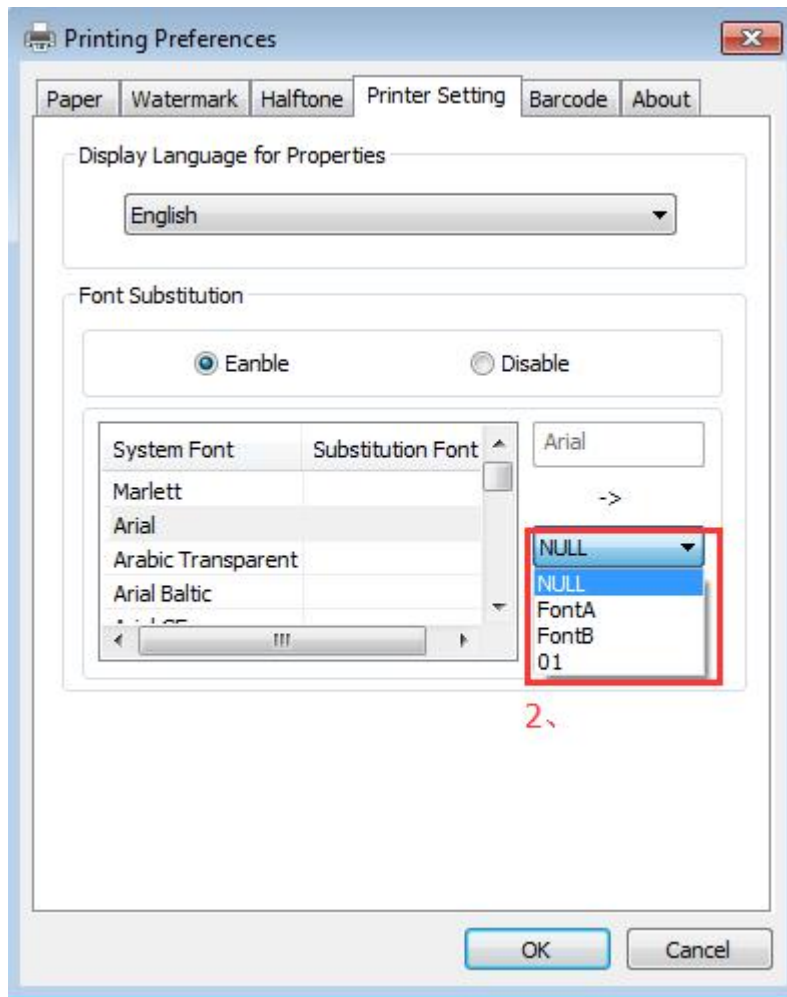

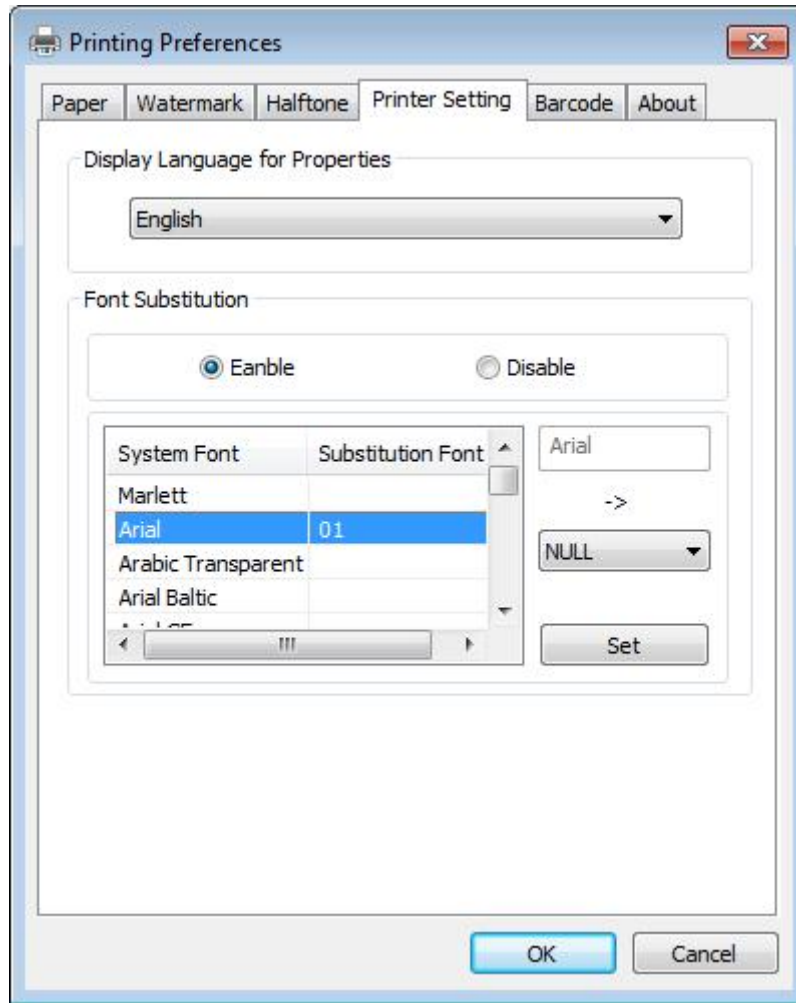

- If you do not have a barcode set, the action is as follows:
 - 1) Suppose you change the size of the data "123456", for example:

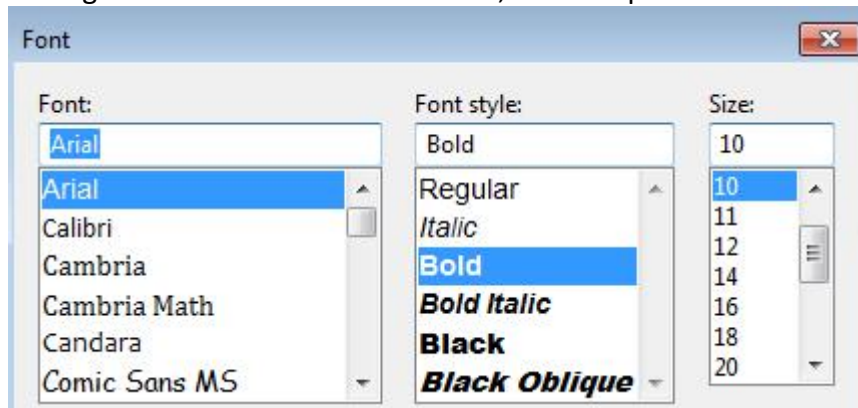

- 2) Set the Printing preferences.

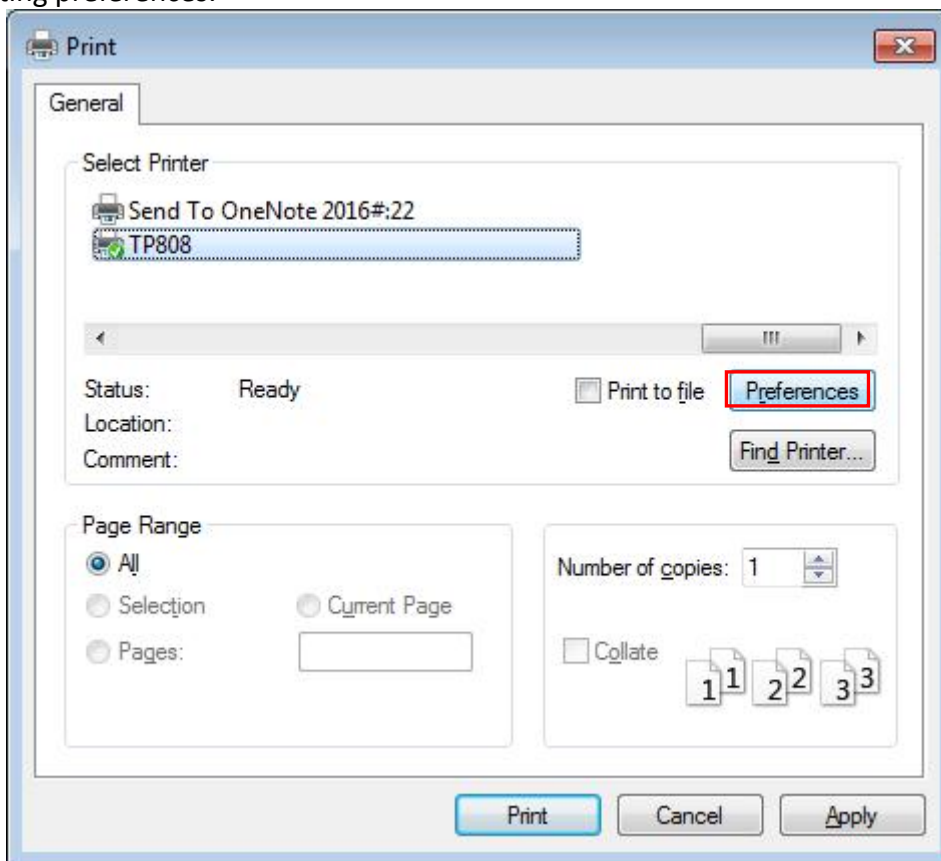

- 3) Click the "Printer Setting".
 - Choose the "Display Language for Properties".

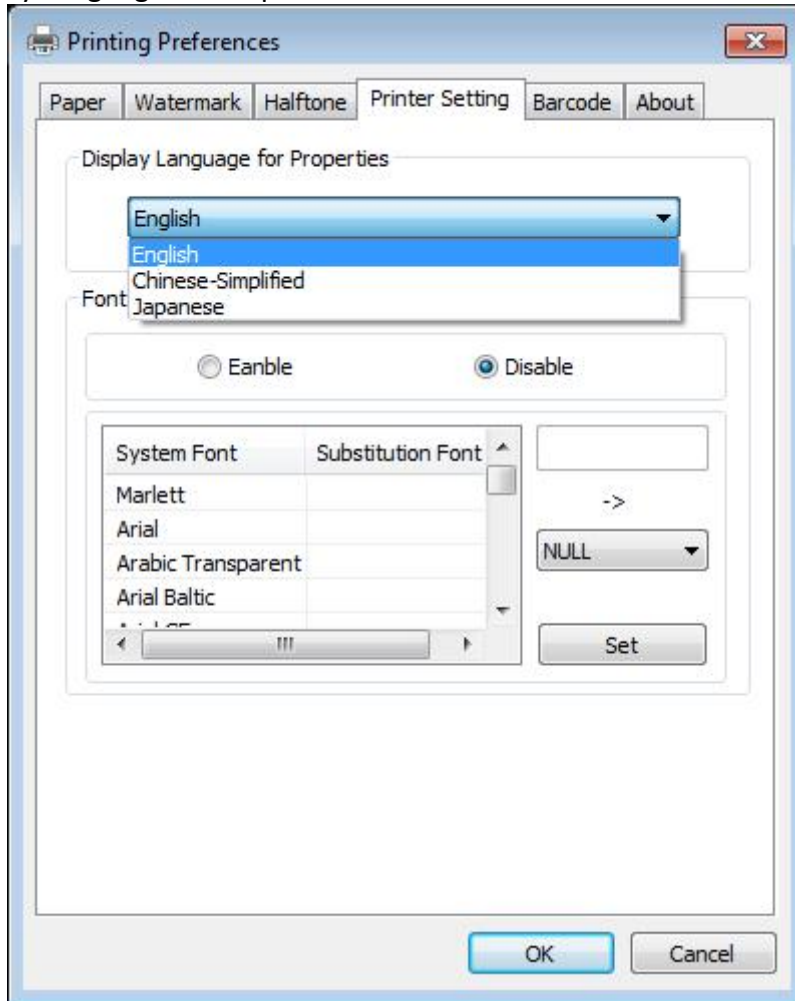

- 4) Turn on the "Font Substitution".

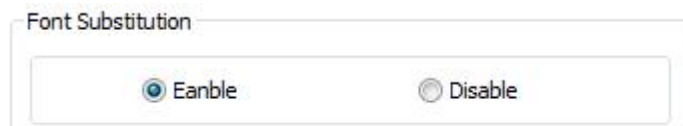

5) Select the “System Font”, for example: Arial.

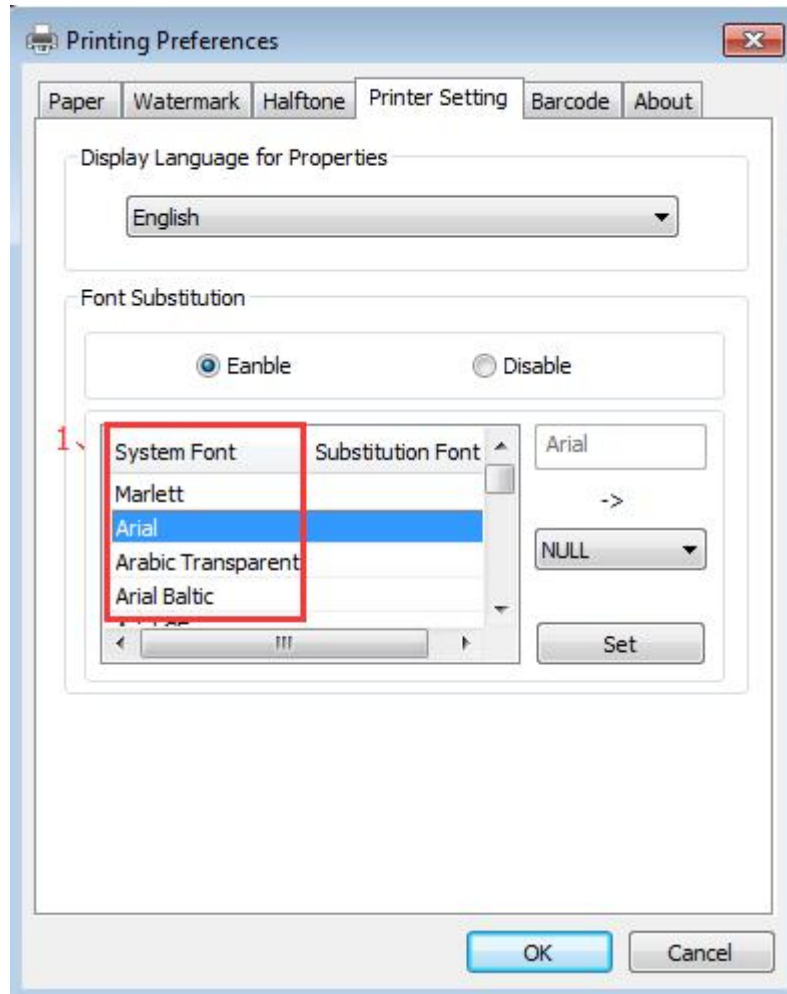

6) Select the font to that you went to replace.

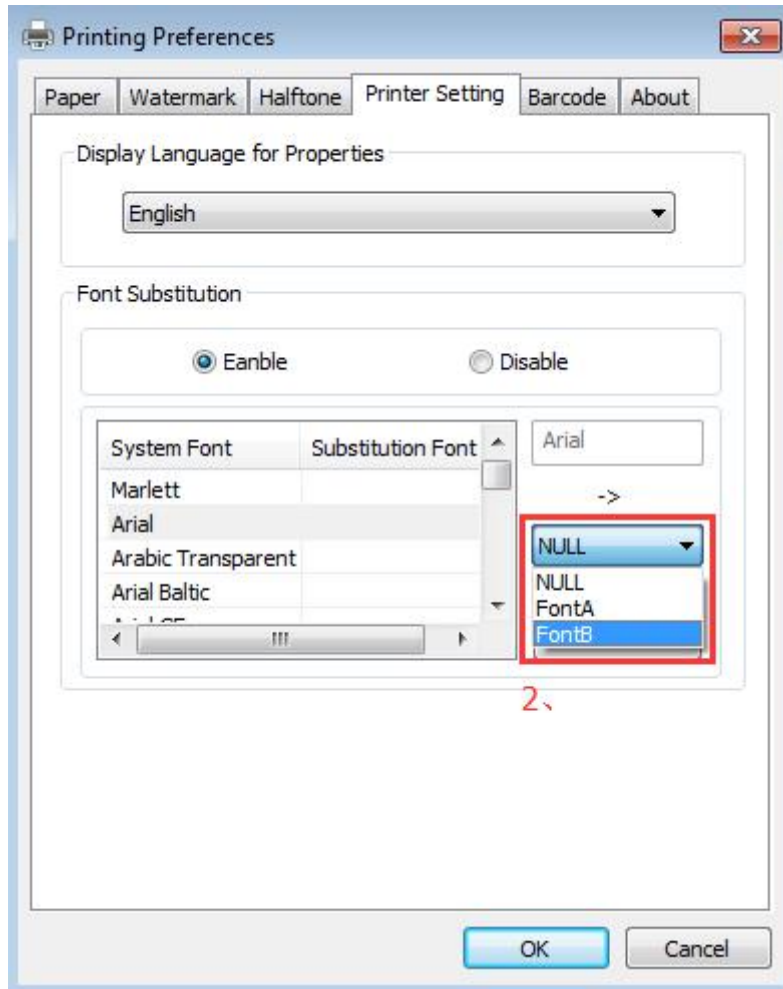

2、

7) Click "Setting".

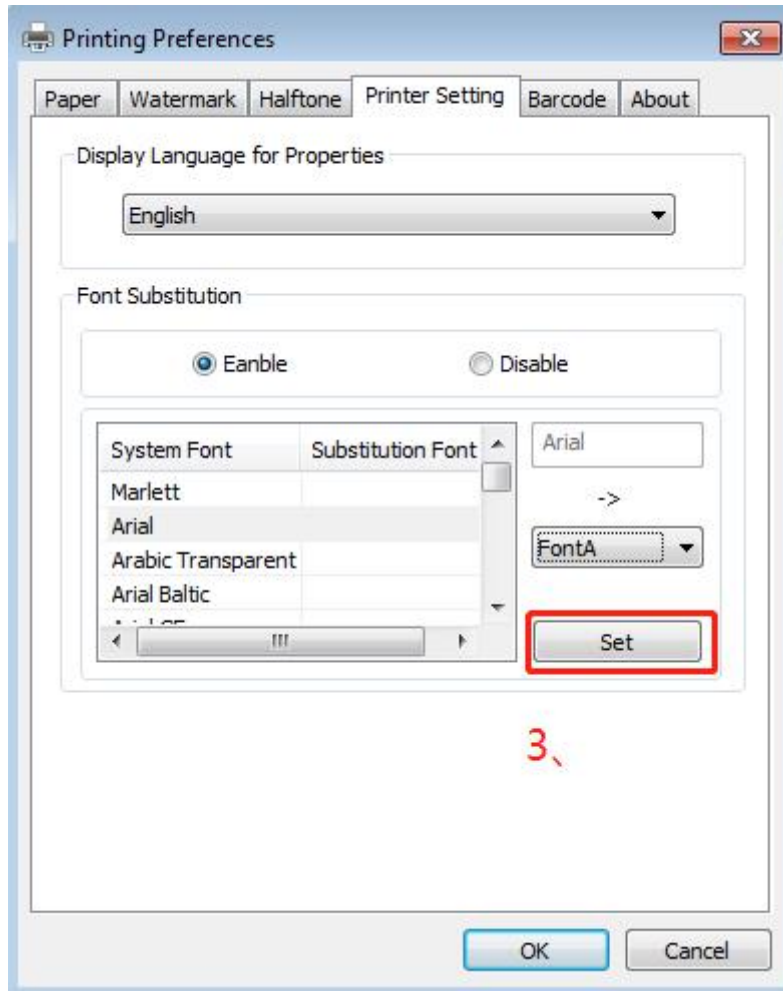

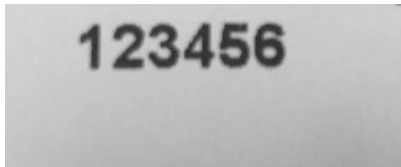
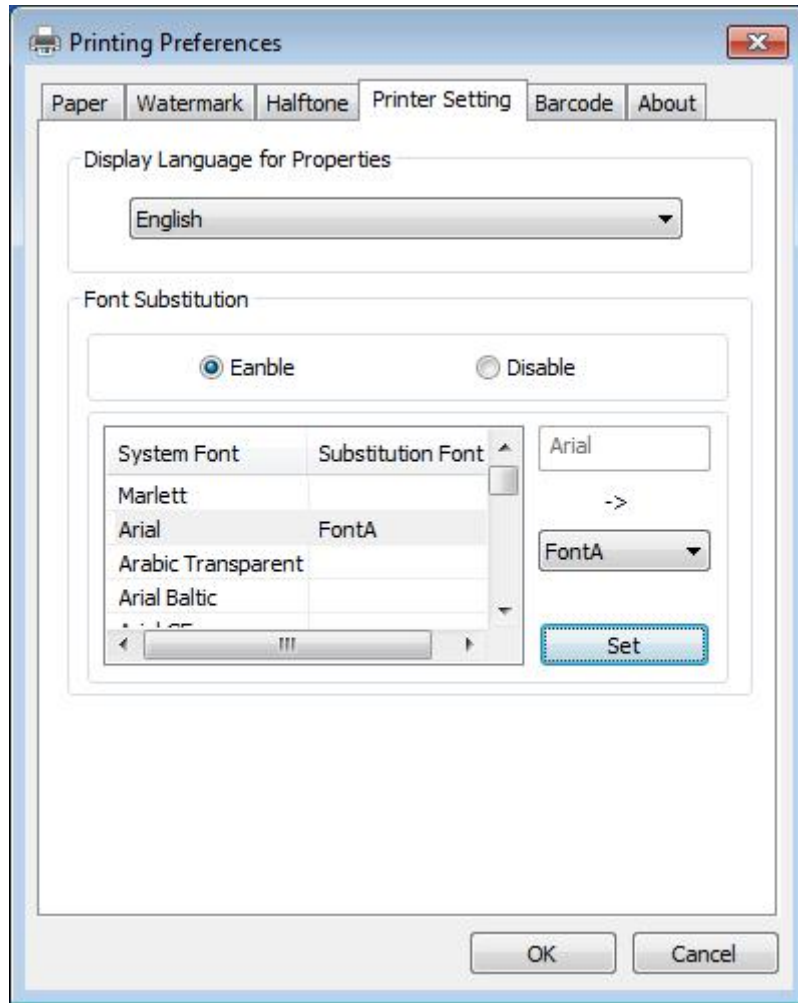

10.5.2. Other Settings

1. Click "Start" → "Devices and Printers". Right click "TP808" and choose "Printer properties".

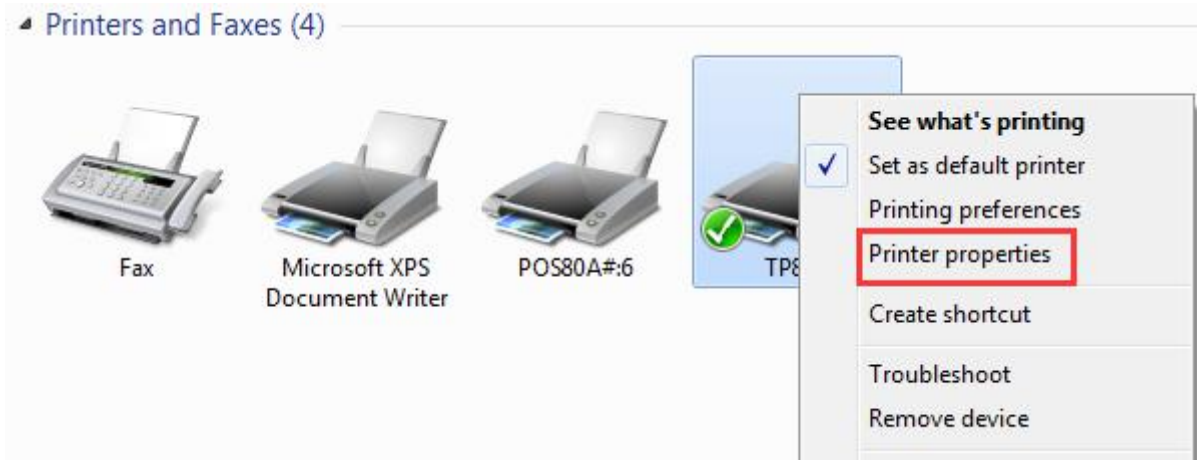

2. Choose "General", click on "Print Test Page", then it will print the current settings.

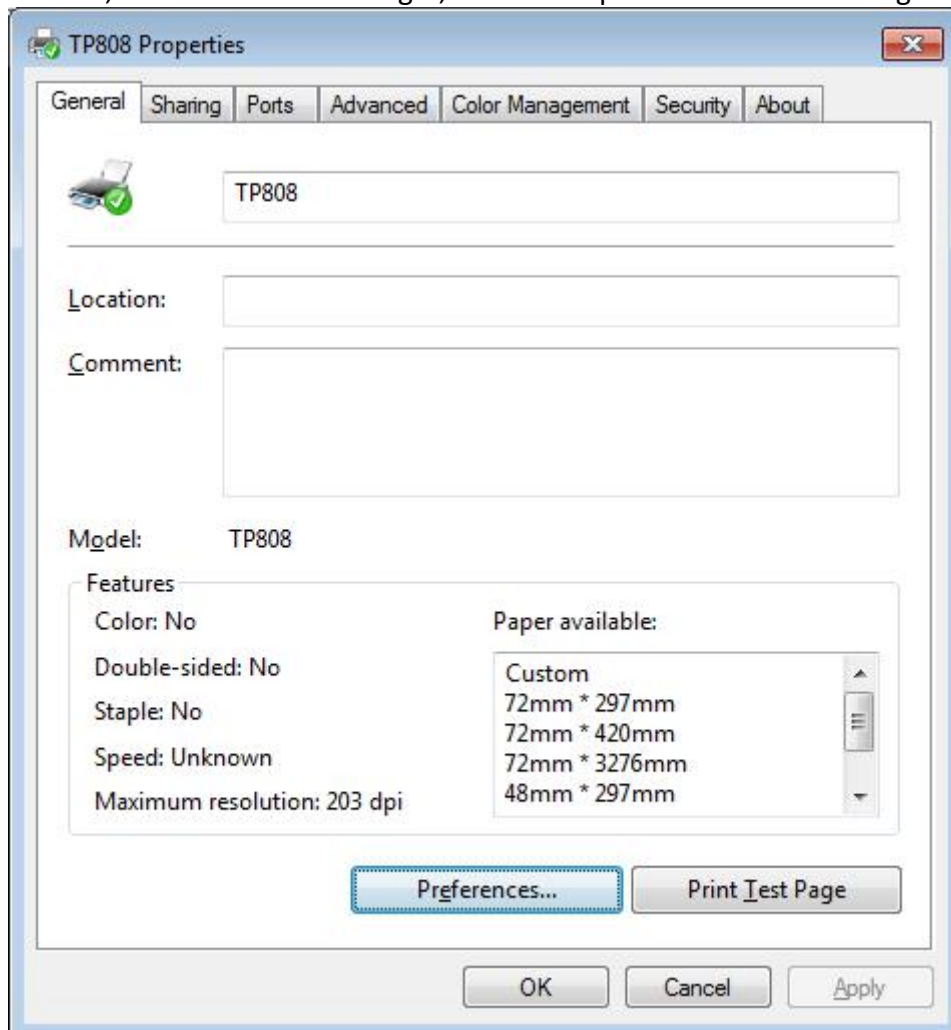

3. Setting the “Ports”

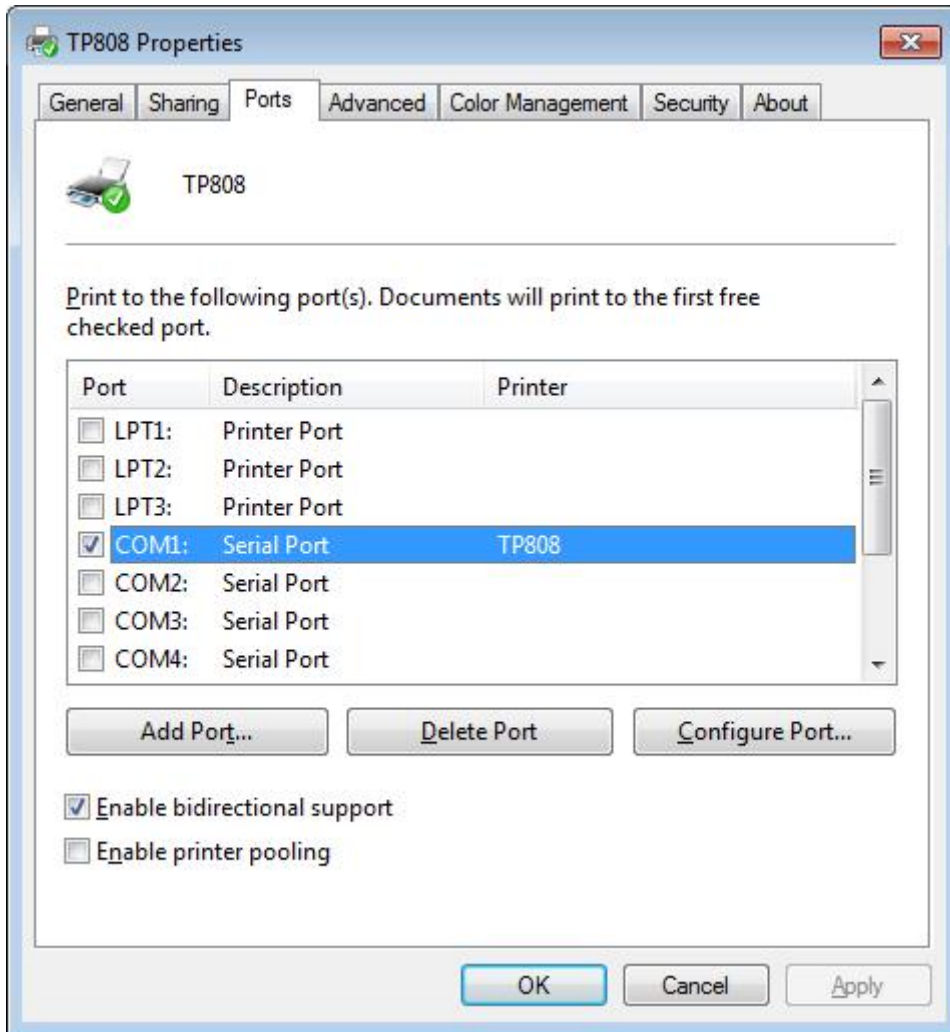

4. Click “Advanced” to set the printing time.

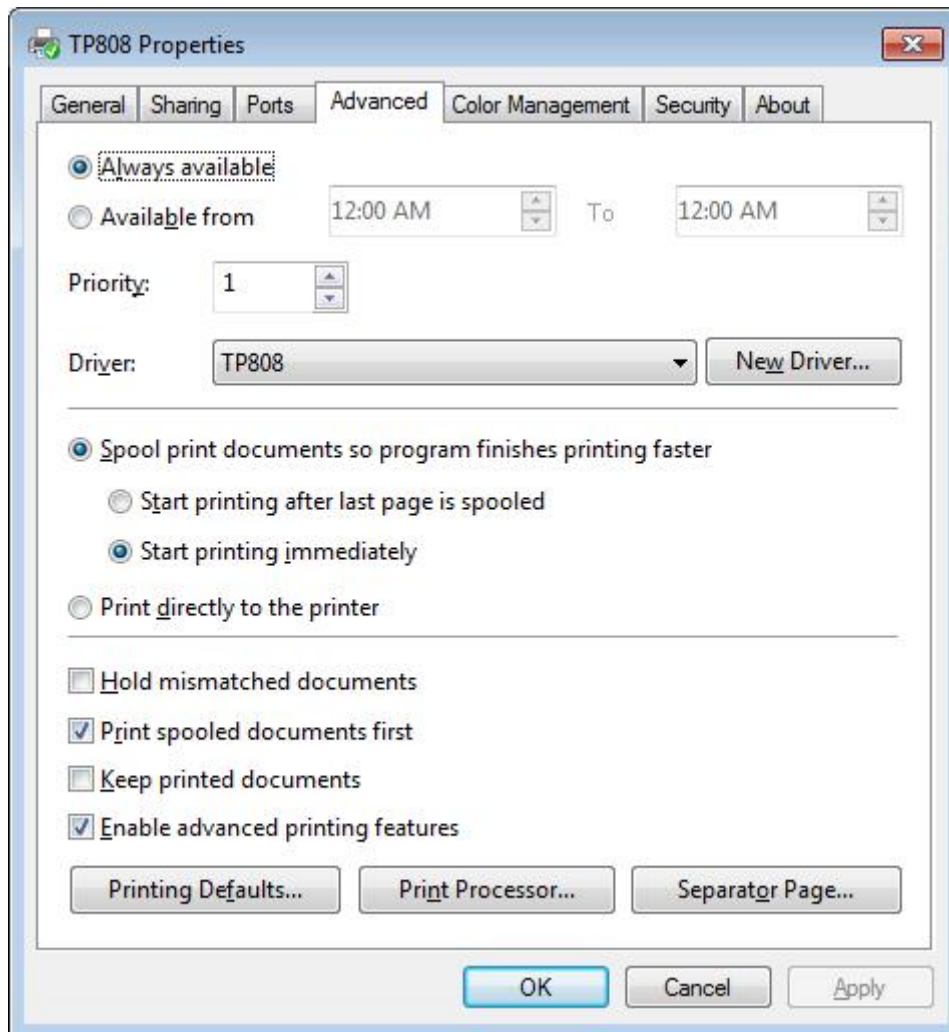

10.6 Uninstall Windows Driver

- 1) Double click Windows Driver.
- 2) Choose “Uninstall printer driver”, then click “Next”

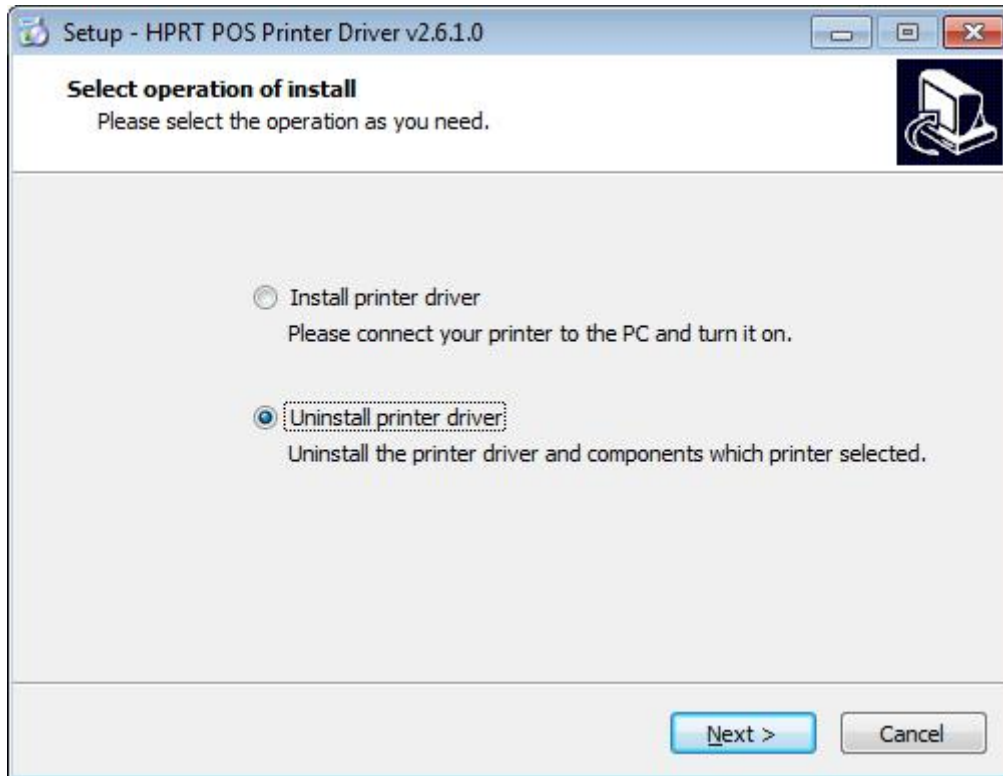

3) Choose "TP808", then click "Next"

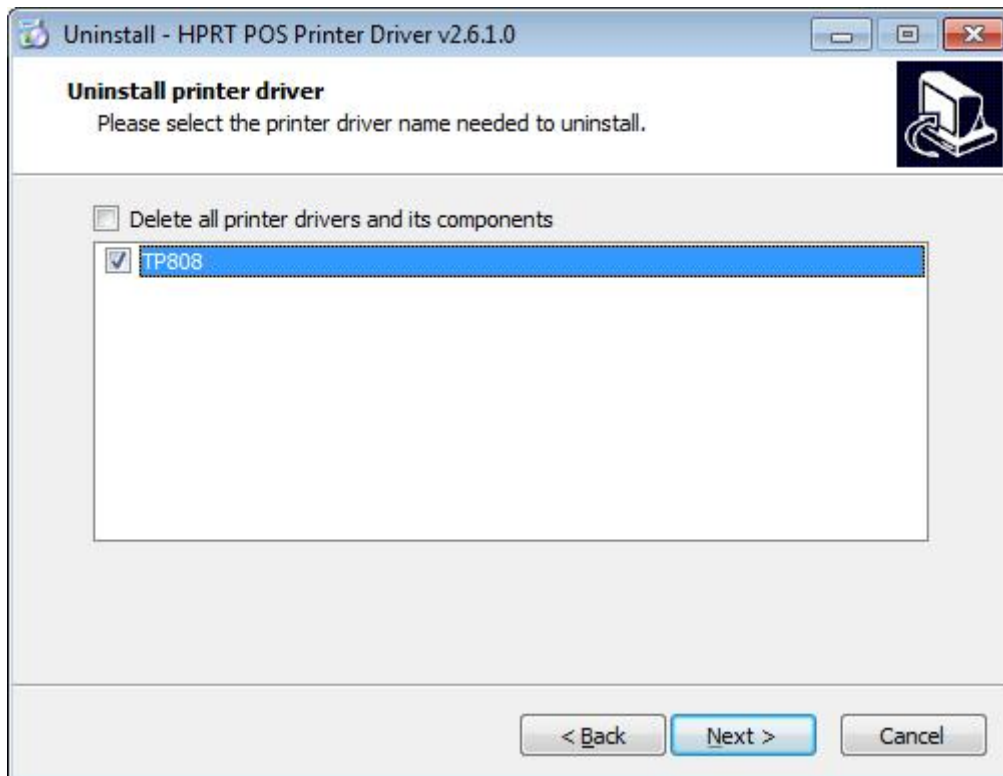

10.7 Specification

Resolution:

TP808: 203×203dpi

Paper Size:

70*297mm

72*420mm

72*3276mm

APPENDIX

FCC-DECLARATION OF CONFORMITY

Product

HPRT TP808

We declare that the product conforms to the following specification:
FCC Part 15, Subpart B Class B digital device.

This device complies with Part 15 of the FCC rules. Operation is subject to the following two conditions:

- This device may not cause harmful interference;
- This device must accept any interference received, including interference that may cause undesired operation.
- The user is cautioned that any changes or modification not expressly approved in this manual could void the user's authority to operate the equipment. To ensure compliance, this printer must be used with shielded communication cables.
- Use only power supplies listed in this manual and /or recommended and approved in this manual.

FCC Radiation Exposure Statement:

This equipment complies with FCC radiation exposure limits set forth for an uncontrolled environment. This equipment should be installed and operated with minimum distance 20cm between the radiator & your body.

NOTE 1: This equipment has been tested and found to comply with the limits for a Class B digital device, pursuant to part 15 of the FCC Rules. These limits are designed to provide reasonable protection against harmful interference in a residential installation. This equipment generates uses and can radiate radio frequency energy and, if not installed and used in accordance with the instructions, may cause harmful interference to radio communications. However, there is no guarantee that interference will not occur in a particular installation. If this equipment does cause harmful interference to radio or television reception, which can be determined by turning the equipment off and on, the user is encouraged to try to correct the interference by one or more of the following measures:

- Reorient or relocate the receiving antenna.
- Increase the separation between the equipment and receiver.
- Connect the equipment into an outlet on a circuit different from that to which the receiver is connected.
- Consult the dealer or an experienced radio/TV technician for help.

EC DECLARATION OF CONFORMITY

Manufacturer certifies that the following designated product

HPRT TP808

Type of product

Direct Thermal Line Printing

It is in conformity with the standards

Test standard information

Under the Council Directive: (LVD) Directive 2014/35/EU relating to electrical equipment designed for use within Low Voltage Directive.

EN 60950-1: 2006+A11:2009+A1:2010+A12:2011+A2:2013

Under the Council Directive: (EMC) Directive 2014/30/EU relating to Electro Magnetic Compatibility.

EN 55032: 2015

EN 55024: 2010

EN 61000-3-2: 2014

EN 61000-3-3: 2013

We declare herewith that as a result of the manner in which the device designated Below was designed, the type of construction and the devices which, as a result have been brought on to the general market comply with the relevant fundamental regulations of the EC Rules for Safety. And we declare herewith the below mentioned model is conformity with Directive 2014/30/EU and 2014/35/EU. In the event of any alteration which has not been approved by us being made to any device as designated below, this statement shall thereby be made invalid.

The declaration is sole responsibility of the manufacturer

Name of manufacturer
HPRT