

Quick Start Guide iT4R

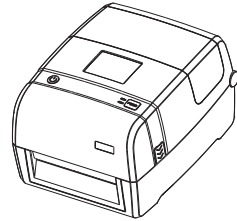

Xiamen Hanin Electronic Technology Co.,Ltd.

ADD: Room 305A, Angye Building, Pioneering Park, Torch High-tech, Zone, Xiamen
 E-mail: support@idprt.com
 Web: www.idprt.com

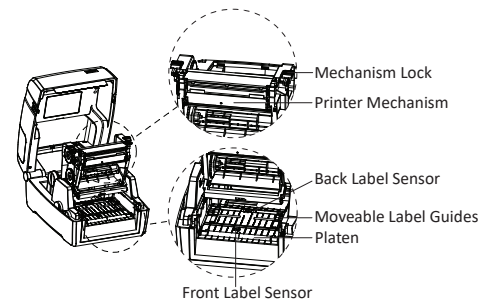

USB Connection

1. Connect the AC adapter to power receptacle.
2. Connect the power cord to AC adapter.
3. Connect the other end of power cord to the outlet.

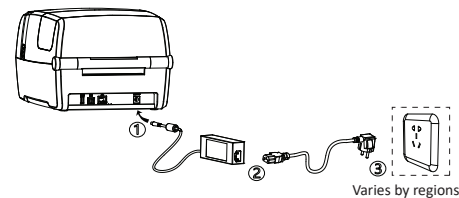

Packing List

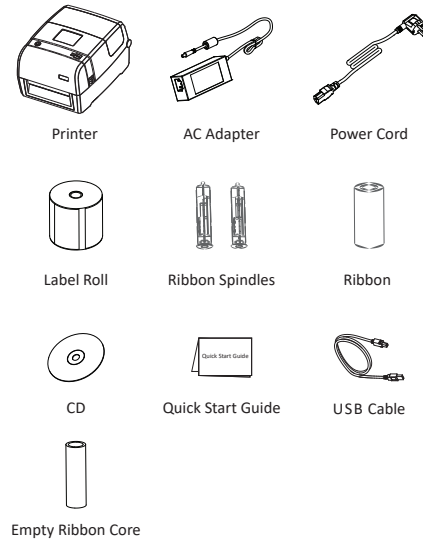

Note: The packing materials are actually based on the order.

Loading the Roll

1. Press to open the printer cover and mechanism.

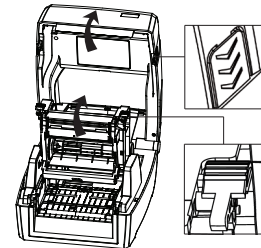

2. Pull the roll holders open and place the roll between them. Press down the locking tab.

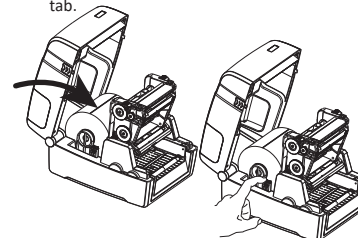

Appearance and Components

Front View

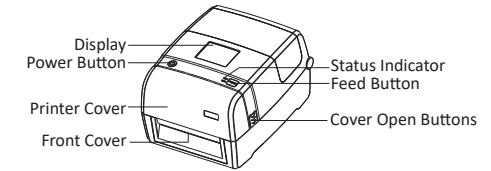

Rear View

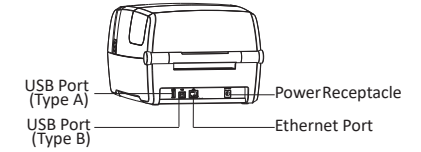

Note: The views above are for your reference. Ports vary by your choice.

Inside View

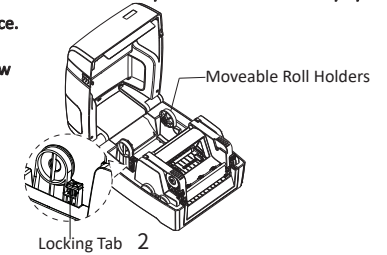

3. Pass the labels through label guides and adjust label guides to label's width.

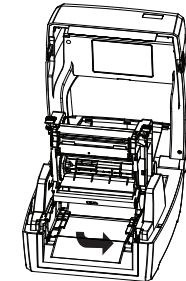

Loading the Ribbon

1. Install the ribbon module.

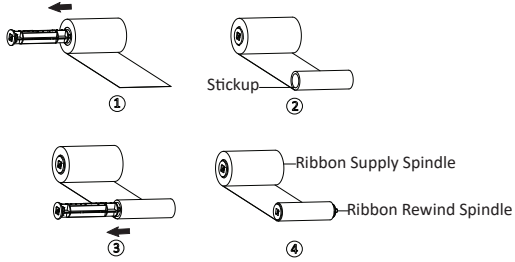

2. Insert the left part of supply spindle and then the right part spindle.

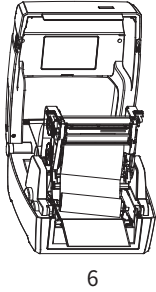

3. Press down the printer mechanism.

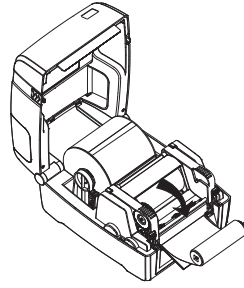

5. Wind the core 2~3 circles until the ribbon is pulled tightly.

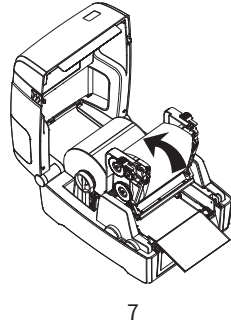

4. Insert the left part of rewind spindle and then the right part.

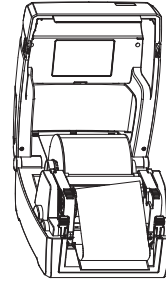

6. Press down the mechanism and close the cover.

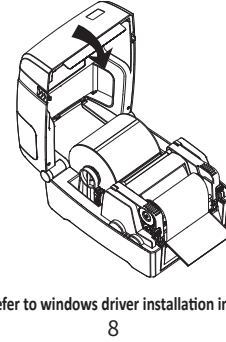

 Note: Please refer to windows driver installation in *iT4R User Manual*.

FCC Warning

This device complies with part 15 of the FCC Rules.

Operation is subject to the following two conditions:(1) This device may not cause harmful interference, and (2) this device must accept any interference received, including interference that may cause undesired operation.

Any Changes or modifications not expressly approved by the party responsible for compliance could void the user's authority to operate the equipment. This equipment has been tested and found to comply with the limits for a Class B digital device, pursuant to part 15 of the FCC Rules. These limits are designed to provide reasonable protection against harmful interference in a residential installation. This equipment generates uses and can radiate radio frequency energy and, if not installed and used in accordance with the instructions, may cause harmful interference to radio communications. However, there is no guarantee that interference will not occur in a particular installation. If this equipment does cause harmful interference to radio or television reception, which can be determined by turning the equipment off and on, the user is encouraged to try to correct the interference by one or more of the following measures:

- Reorient or relocate the receiving antenna.
- Increase the separation between the equipment and receiver.
- Connect the equipment into an outlet on a circuit different from that to which the receiver is connected.
- Consult the dealer or an experienced radio/TV technician for help.

FCC RF exposure statement:

The equipment complies with FCC radiation exposure limits set forth for an uncontrolled environment. This equipment should be installed and operated with minimum distance between 20cm the radiator your body.

FCC ID: 2AUTE-IT4R

