

Quick Start Guide

HPL3D2303

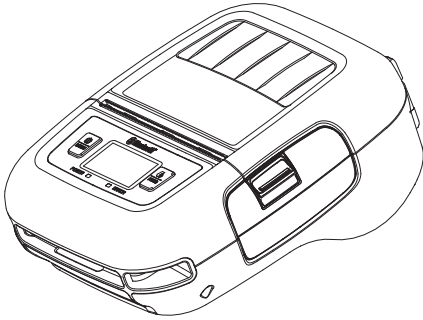

Xiamen Hanin Electronic Technology Co.,Ltd.

ADD: 5F, 10#, Aide Airport Industrial Park, Huli District, Xiamen, China

TEL: +86-(0)592-5932525

WEB: www.idprt.com

Packing List

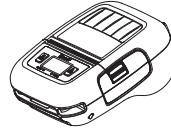

Printer



USB Cable

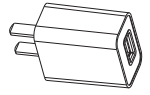

AC Adapter

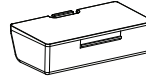

Battery

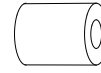

Roll Paper

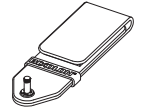

Belt Clip



Quick Start Guide



CD



Note

1. The packing items are actually based on the order.
2. The AC adapter varies by local or region.

FCC COMPLIANCE STATEMENT:

This device complies with part 15 of the FCC Rules.

Operation is subject to the following two conditions:

- (1) This device may not cause harmful interference, and
- (2) this device must accept any interference received, including interference that may cause undesired operation.

Note: This equipment has been tested and found to comply with the limits for a Class B digital device, pursuant to Part 15 of the FCC Rules. These limits are designed to provide reasonable protection against harmful interference in a residential installation. This equipment generates, uses and can radiate radio frequency energy and, if not installed and used in accordance with the instructions, may cause harmful interference to radio communications.

However, there is no guarantee that interference will not occur in a particular installation. If this equipment does cause harmful interference to radio or television reception, which can be determined by turning the equipment off and on, the user is encouraged to try to correct the interference by one or more of the following measures:

Reorient or relocate the receiving antenna.

Increase the separation between the equipment and receiver.

Connect the equipment into an outlet on a circuit different from that to which the receiver is connected.

Consult the dealer or an experienced radio/TV technician for help.

Warning: Changes or modifications to this unit not expressly approved by the part responsible for compliance could void the user's authority to operate the equipment.

FCC Radiation Exposure Statement

The device has been evaluated to meet general RF exposure requirement.

The device can be used in portable exposure condition without restriction.

Appearance and Components

Front

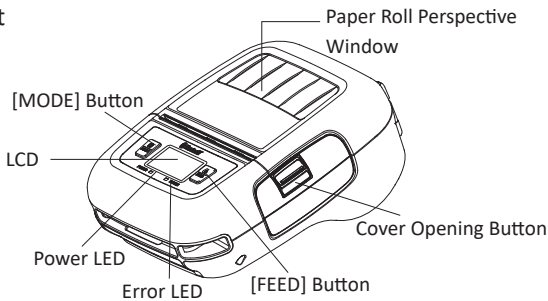

Back

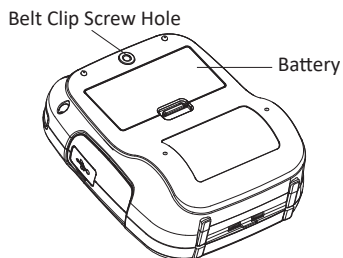

Inside

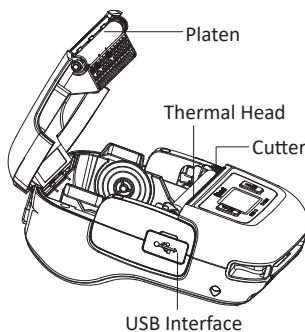

Battery Installation

1. Make sure that the printer has been turned off before you insert or remove the battery pack.
2. Insert the battery pack into the back of the printer as the figure shown below, following the direction of the arrow. Press down on the battery pack until the hook click into place.

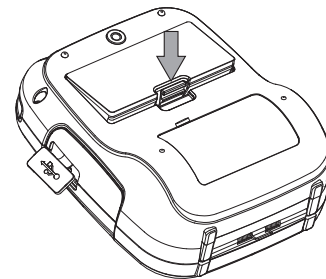

3. To remove the battery back, pull back the hook, and use the opposite procedure from the one you used to insert the battery pack.

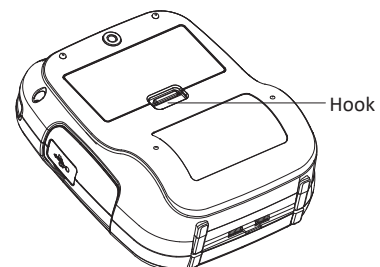

Paper Loading

1. Press the cover opening button to open the printer cover.

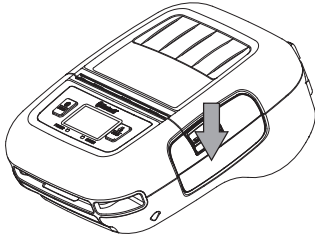

2. Load the roll paper in the orientation shown in the figure below.

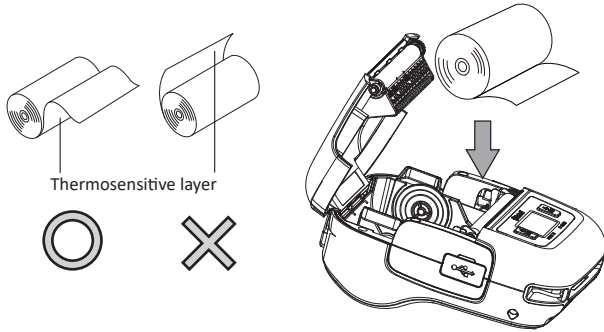

3. Pull the end of the roll straight toward you. Then press down on both sides of the printer cover to close it firmly. When you close the printer cover, make sure that it is closed on both sides.

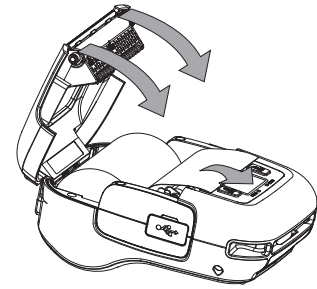

4. Use the tear bar to cut the extra paper.

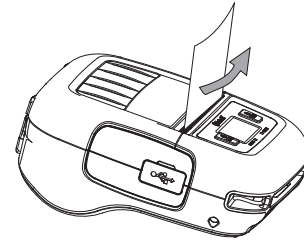

Battery Charging

Plug in socket with USB charging.

When battery pack runs out of power, the battery icon will flash. It powers off automatically when continues printing. If you want to go on, please charge it.

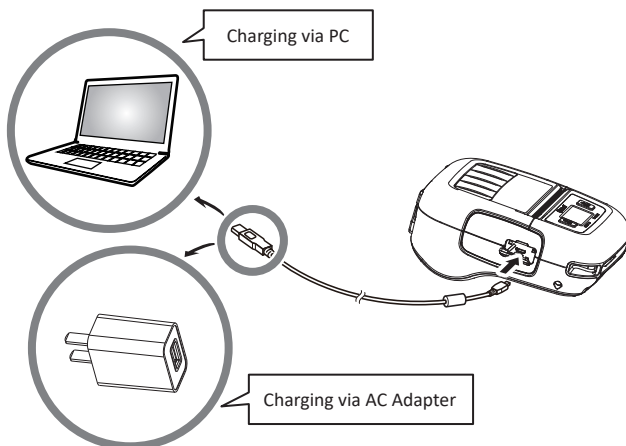

Wi-Fi Settings

Printer Wi-Fi factory default is Off, and it needs to be turned on through menu before use. In AP mode, the IP address is "192.168.1.1", SSID is "T3PRO_AP-XXXX" (last four digits of Wi-Fi Mac address). If you need to change the Wi-Fi settings, please set it by the Utility tool.

Note: This setting is only available for the models with Wi-Fi.

Menu Settings

1. Press and hold MODE button for approx. 2 seconds, and printer is turned on.

LCD display is shown as follows.

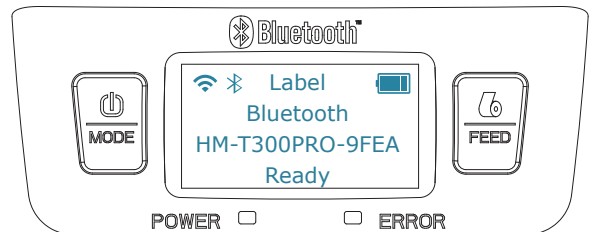

2. Press and hold MODE & FEED buttons, release the buttons after you surely confirm the screen display "Enter Menu Mode", to get a printer into the setting mode.

3. Press the MODE button, choose the item or return to previous menu.

4. Press the FEED button, you can move the cursor (" ") or confirm the new setting.

Note

◆ Before changing the menu setting, please make sure that the communication with a host device is disconnected.

◆ When the printer is under the Bluetooth communication with a host device, it cannot enter the Menu Setting mode.

Note

◆ POWER lamp will always flash in green color and goes off when fully charged.

◆ Charging the printer when it is on, even if battery icon on the LCD shows fully charged, turn off the printer and let the battery charge until the POWER lamp goes off for fully charge.