

FCC RADIO TEST REPORT

Applicant..... : Xiamen Hanin Electronic Technology Co., Ltd.
Address..... : Room 305A, Angye Building, Pioneering Park Torch High-tech, Zone
Xiamen China
Manufacturer..... : Xiamen Hanin Electronic Technology Co., Ltd.
Address..... : Room 305A, Angye Building, Pioneering Park Torch High-tech, Zone
Xiamen China
Factory..... : Xiamen Hanin Electronic Technology Co., Ltd.
Address..... : No.96, Rongyuan Road, Tong'an District, Xiamen, China 361100
Product Name..... : Mobile Thermal Printer
Brand Name..... : N/A
Model No. : MPT-II (For addition model and model difference refer to section 2)
FCC ID..... : 2AUTE-HMDR14001
Measurement Standard..... : 47 CFR FCC Part 15, Subpart C (Section 15.247)
Receipt Date of Samples..... : November 10, 2022
Date of Tested..... : November 12, 2022 to December 01, 2022
Date of Report..... : January 05, 2023

This report shows that above equipment is technically compliant with the requirements of the standards above. All test results in this report apply only to the tested sample(s). Without prior written approval of Dongguan Nore Testing Center Co., Ltd, this report shall not be reproduced except in full.

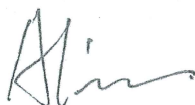

Prepared by

Alina Guo / Project Engineer



Approved by

Iori Fan / Authorized Signatory

Table of Contents

1. Summary of Test Result	4
2. General Description of EUT	5
3. Test Channels and Modes Detail.....	8
4. Configuration of EUT	8
5. Modification of EUT	8
6. Description of Support Device	9
7. Test Facility and Location	10
8. Applicable Standards and References	11
9. Deviations and Abnormalities from Standard Conditions	11
10. Test Conditions	12
11. Measurement Uncertainty	13
12. Sample Calculations	14
13. Test Items and Results	15
13.1 Conducted Emissions Measurement.....	15
13.2 Radiated Spurious Emissions and Restricted Bands Measurement	19
13.3 Channel Separation test.....	26
13.4 20dB Bandwidth	30
13.5 Hopping Channel Number	34
13.6 Time of Occupancy (Dwell Time).....	36
13.7 Maximum Peak Output Power	40
13.8 Band Edge Conducted Spurious Emission Measurement.....	44
13.9 Antenna Requirement	45
14. Test Equipment List.....	50

1. Summary of Test Result

FCC Rules	Description of Test	Result	Remarks
§15.247(a)(1)	Channel Separation test	PASS	---
§15.247(a)(1)	20dB Bandwidth	PASS	---
§15.247(a)(1)(iii)	Hopping Channel Number	PASS	---
§15.247(a)(1)(iii)	Time of Occupancy (Dwell Time)	PASS	---
§15.247(b)	Max Peak output Power test	PASS	---
§15.247(d)	Band edge test	PASS	---
§15.207 (a)	AC Power Conducted Emission	PASS	---
§15.247(d), §15.209, §15.205	Radiated Emission	PASS	---
§15.203	Antenna Requirement	PASS	---
§15.247(d)	Conducted Spurious Emission	PASS	---

2. General Description of EUT

Product Information	
Product Name:	Mobile Thermal Printer
Main Model Name:	MPT-II
Additional Model Name:	M23, ML238, MLU2381, MLU2382, MLU2383, MLU2384, MLU2385, MLX2381, MLX2382, MLX2383, MLX2384, MLX2385
Model Difference:	These models have the same circuit schematic, construction, PCB Layout and critical components. These differences is model number and color only due to trading purpose.
S/N:	2211-5978
Brand Name	N/A
Hardware Version:	MP11-J-MB
Software Version:	V1.15
Rating:	DC 12V, 0.5Az come from adapter DC 7.4V from Internal Lithium-ion battery
Classification:	Class B
Typical Arrangement:	Tabletop
I/O Port:	Refer to the user manual
Accessories Information	
Adapter:	N/A
Cable:	USB line: 1.5m shielded with one code
Other:	N/A
Additional Information	
Note:	According to these model differences, all tests were carried on model MPT-II.
Remark:	All the information above are provided by the manufacturer. More detailed feature of the EUT please refers to the user manual.

Technical Specification	
Bluetooth Version:	V5.0
Frequency Range:	2402-2480MHz
Modulation Type:	GFSK, $\pi/4$ -DQPSK, 8DPSK
Number of Channel:	79 (refer to following channel list for details)
Channel Space:	1MHz
Antenna Type:	PCB Antenna
Antenna Gain:	0 dBi (Declared by the manufacturer)
Note: This report only replies to BDR +EDR feature of the EUT.	

Channel List							
Channel	Frequency (MHz)	Channel	Frequency (MHz)	Channel	Frequency (MHz)	Channel	Frequency (MHz)
0	2402	20	2422	40	2442	60	2462
1	2403	21	2423	41	2443	61	2463
2	2404	22	2424	42	2444	62	2464
3	2405	23	2425	43	2445	63	2465
4	2406	24	2426	44	2446	64	2466
5	2407	25	2427	45	2447	65	2467
6	2408	26	2428	46	2448	66	2468
7	2409	27	2429	47	2449	67	2469
8	2410	28	2430	48	2450	68	2470
9	2411	29	2431	49	2451	69	2471
10	2412	30	2432	50	2452	70	2472
11	2413	31	2433	51	2453	71	2473
12	2414	32	2434	52	2454	72	2474
13	2415	33	2435	53	2455	73	2475
14	2416	34	2436	54	2456	74	2476
15	2417	35	2437	55	2457	75	2477
16	2418	36	2438	56	2458	76	2478
17	2419	37	2439	57	2459	77	2479
18	2420	38	2440	58	2460	78	2480
19	2421	39	2441	59	2461	---	---

3. Test Channels and Modes Detail

No.	Mode	Channel	Frequency (MHz)	Modulation
1	TX	Hopping	2402-2480	GFSK / $\pi/4$ -DQPSK / 8DPSK
2	TX	Low	2402	GFSK / $\pi/4$ -DQPSK / 8DPSK
3	TX	Mid	2441	GFSK / $\pi/4$ -DQPSK / 8DPSK
4	TX	High	2480	GFSK / $\pi/4$ -DQPSK / 8DPSK
5.	BT Link	---	---	---

Note: TX mode means that the EUT was programmed to be in continuously transmitting mode.

4. Configuration of EUT

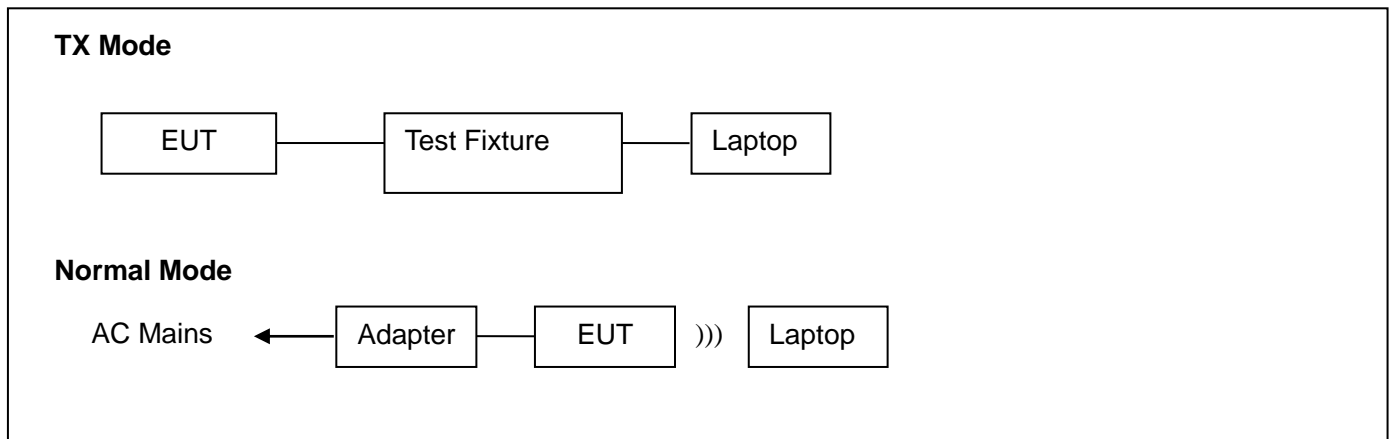

5. Modification of EUT

No modifications are made to the EUT during all test items.

6. Description of Support Device

The EUT has been tested as an independent unit together with other necessary accessories or support units. The following support units or accessories were used to form a representative test configuration during the tests.

No.	Equipment	Brand	M/N	S/N	Cable Specification	Remarks
1.	Laptop	Lenovo	02213DC	0A33012	Power cord, 1.8m, unshielded	---
2.	Power supply (Notebook)	Taida	92P1154	N/A	----	---
3.	Test fixture	---	---	---	----	Provided by manufacturer
4.	Adapter	FUHUA	UES18LCP-1201 25SPA	---	Input: AC100-240V 50/60Hz, 500mA Output: DC 12V 1.25A 15W	Provide by the manufacturer
5.	Adapter	---	P6-120050	---	Input: AC100-240V 50/60Hz, 0.5A Output: DC 12V 1.25A 15W	Provide by the manufacturer

No.	Test Software	Modulation	Power Setting
1.	BR BlueletSuite_v6_0	GFSK	Default
2.		$\pi/4$ -DQPSK	Default
3.		8DPSK	Default

7. Test Facility and Location

Test Site	:	Dongguan Nore Testing Center Co., Ltd. (Dongguan NTC Co., Ltd.)
Accreditations and Authorizations	:	<p>The Laboratory has been assessed and proved to be in compliance with CNAS/CL01 Listed by CNAS, August 13, 2018 The Certificate Registration Number is L5795. The Certificate is valid until August 13, 2024</p> <p>The Laboratory has been assessed and proved to be in compliance with ISO17025 Listed by A2LA, November 01, 2017 The Certificate Registration Number is 4429.01 The Certificate is valid until December 31, 2023</p> <p>Listed by FCC, November 06, 2017 Test Firm Registration Number: 907417</p> <p>Listed by Industry Canada, June 08, 2017 The Certificate Registration Number. Is 46405-9743A</p>
Test Site Location	:	Building D, Gaosheng Science and Technology Park, Hongtu Road, Nancheng District, Dongguan City, Guangdong Province, China

8. Applicable Standards and References

According to the specifications of the manufacturer, the EUT must comply with the requirements of the following standards:

Test Standards:

47 CFR Part 15, Subpart C, 15.247

ANSI C63.10-2013

References Test Guidance:

DTS KDB 558074 D01 15.247 Meas Guidance v05r02

Remark:

The EUT has also been tested and complied with the requirements of FCC Part 15, Subpart B, recorded in a separate test report.

9. Deviations and Abnormalities from Standard Conditions

No additions, deviations and exclusions from the standard.

10. Test Conditions

No.	Test Item	Test Mode	Test Voltage	Tested by	Remarks
1.	Channel Separation test	1	DC 7.4V	Sean Yuan	See note ¹
2.	20dB Bandwidth	2-4	DC 7.4V	Sean Yuan	See note ¹
3.	Hopping Channel Number	1	DC 7.4V	Sean Yuan	See note ¹
4.	Time of Occupancy (Dwell Time)	1	DC 7.4V	Sean Yuan	See note ¹
5.	Max Peak output Power test	2-4	DC 7.4V	Sean Yuan	See note ¹
6.	Band edge test	1-4	DC 7.4V	Sean Yuan	See note ¹
7.	AC Power Conducted Emission	5	AC 120V 60Hz	Sean Yuan	See note ¹
8.	Radiated Emission	1-5	DC 7.4V AC 120V 60Hz	Sean Yuan	See note ¹
9.	Antenna Requirement	---	---	---	---
10.	Conducted Spurious Emission	1-4	DC 7.4V	Sean Yuan	See note ¹

Note:

- The testing climatic conditions for temperature, humidity, and atmospheric pressure are within: 15~35°C, 30~70%, 86~106kPa
- Test voltage AC 120V 60Hz was come from the adapter.

11. Measurement Uncertainty

No.	Test Item	Frequency	Uncertainty	Remarks
1.	Conducted Emission	150KHz ~ 30MHz	±3.04 dB	---
2.	Radiated Emission	9kHz ~ 30MHz	±5.04 dB	
		30MHz ~ 1GHz	±5.04 dB	---
		1GHz ~ 18GHz	±5.23 dB	---
		18GHz ~ 40GHz	±5.23 dB	
3.	RF Conducted	10Hz ~ 40GHz	±0.78 dB	---
4.	Occupied Channel Bandwidth	---	±0.94 dB	---

Note:

1. This uncertainty represents an expanded uncertainty expressed at approximately the 95% confidence level using a coverage factor of k=2.
2. The measurement uncertainty levels above are estimated and calculated according to CISPR 16-4-2.
3. The conformity assessment statement in this report is based solely on the test results, measurement uncertainty is excluded.

12. Sample Calculations

Conducted Emission						
Freq. (MHz)	Reading Level (dBuV)	Correct Factor (dB)	Measurement (dBuV)	Limit (dBuV)	Over (dB)	Detector
0.1500	27.50	10.60	38.10	66.00	-27.90	QP
Where, Freq. = Emission frequency in MHz Reading Level = Spectrum Analyzer/Receiver Reading Corrector Factor = Insertion loss of LISN + Cable Loss + RF Switching Unit attenuation Measurement = Reading + Corrector Factor Limit = Limit stated in standard Margin = Measurement - Limit Detector = Reading for Quasi-Peak / Average / Peak						

Radiated Spurious Emissions and Restricted Bands						
Freq. (MHz)	Reading Level (dBuV)	Correct Factor (dB/m)	Measurement (dBuV/m)	Limit (dBuV/m)	Over (dB)	Detector
142.5200	39.06	-10.96	28.10	43.50	-15.40	QP
Where, Freq. = Emission frequency in MHz Reading Level = Spectrum Analyzer/Receiver Reading Corrector Factor = Antenna Factor + Cable Loss - Pre-amplifier Measurement = Reading + Corrector Factor Limit = Limit stated in standard Over = Margin, which calculated by Measurement - Limit Detector = Reading for Quasi-Peak / Average / Peak						

Note: For all conducted test items, the spectrum analyzer offset or transducer is derived from RF cable loss and attenuator factor. The offset or transducer is equal to the RF cable loss plus attenuator factor.

13. Test Items and Results

13.1 Conducted Emissions Measurement

LIMITS

According to the requirements of FCC PART 15.207, the limits are as follows:

Frequency (MHz)	Quasi-peak	Average
0.15 to 0.5	66 to 56	56 to 46
0.5 to 5	56	46
5 to 30	60	50

- Note:
1. If the limits for the average detector are met when using the quasi-peak detector, then the limits for the measurements with the average detector are considered to be met.
 2. The lower limit shall apply at the transition frequencies.
 3. The limit decreases linearly with the logarithm of the frequency in the range 0.15 MHz to 0.5MHz.

BLOCK DIAGRAM OF TEST SETUP

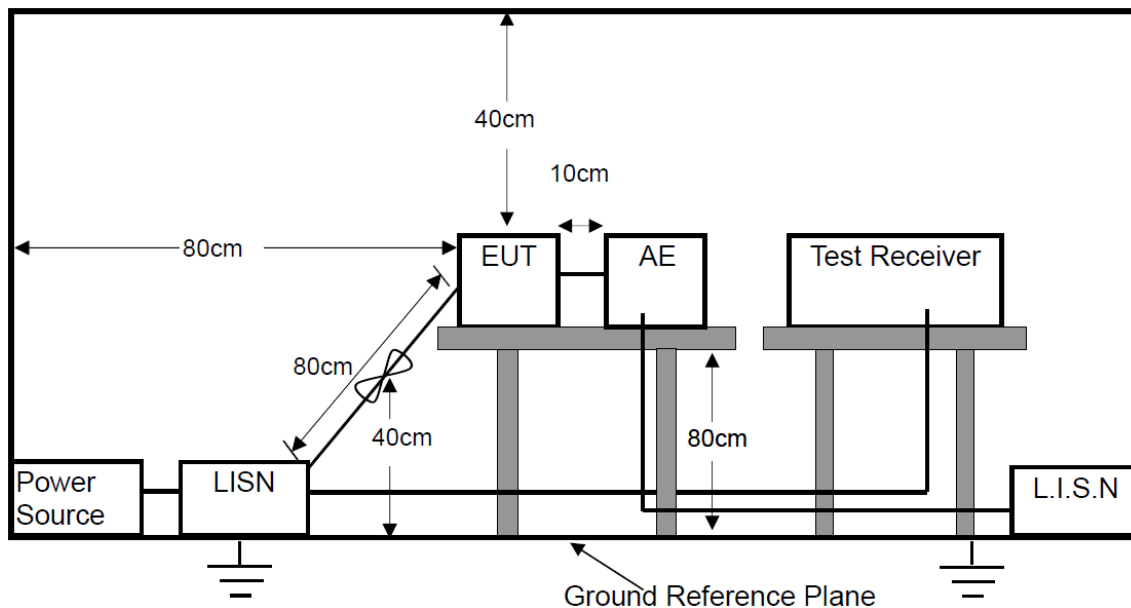

TEST PROCEDURES

- a. The EUT was placed on a wooden table 0.8m height from the metal ground plan and 0.4m from the conducting wall of the shielding room and it was kept at 0.8m from any other grounded conducting surface.
- b. All I/O cables and support devices were positioned as per ANSI C63.10.
- c. Connect mains power port of the EUT to a line impedance stabilization network (LISN).
- d. Connect all support devices to the other LISN and AAN, if needed.
- e. Scan the frequency range from 150KHz to 30MHz at both sides of AC line for maximum conducted interference checking and record the test data.

TEST RESULTS

PASS

Please refer to the following pages.

M/N: MPT-II	Testing Voltage: AC 120V 60Hz
Phase: L1	Detector: QP & AVG
Test Mode: 5	

Conducted Emission Measurement

Date: 2022/11/29

Time: 15:31:03

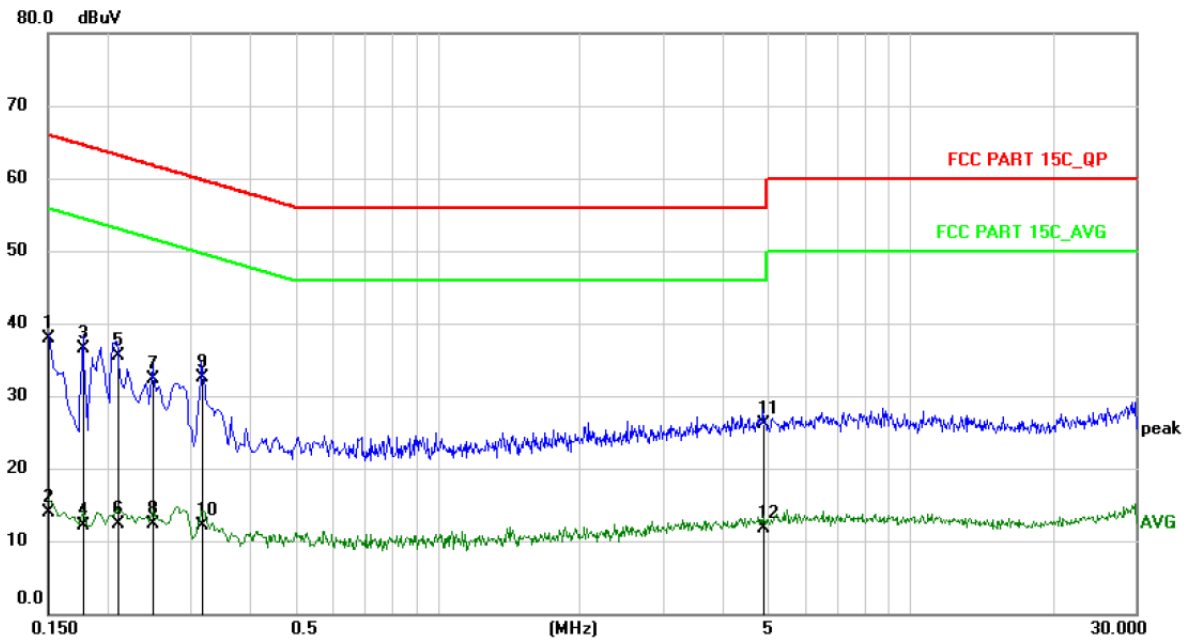

No. Mk.	Freq.	Reading Level	Correct Factor	Measurement	Limit	Over	Detector	Comment
	MHz	dBuV	dB	dBuV	dBuV	dB		
1	0.1500	17.31	20.59	37.90	66.00	-28.10	QP	
2	0.1500	-6.69	20.59	13.90	56.00	-42.10	AVG	
3	0.1780	16.00	20.60	36.60	64.58	-27.98	QP	
4	0.1780	-8.50	20.60	12.10	54.58	-42.48	AVG	
5	0.2100	14.89	20.61	35.50	63.21	-27.71	QP	
6	0.2100	-8.21	20.61	12.40	53.21	-40.81	AVG	
7	0.2500	11.79	20.61	32.40	61.76	-29.36	QP	
8	0.2500	-8.21	20.61	12.40	51.76	-39.36	AVG	
9 *	0.3180	11.98	20.62	32.60	59.76	-27.16	QP	
10	0.3180	-8.42	20.62	12.20	49.76	-37.56	AVG	
11	4.8778	5.55	20.65	26.20	56.00	-29.80	QP	
12	4.8778	-8.95	20.65	11.70	46.00	-34.30	AVG	

M/N: MPT-II	Testing Voltage: AC 120V 60Hz
Phase: N	Detector: QP & AVG
Test Mode: 5	

Conducted Emission Measurement

Date: 2022/11/29

Time: 15:36:10

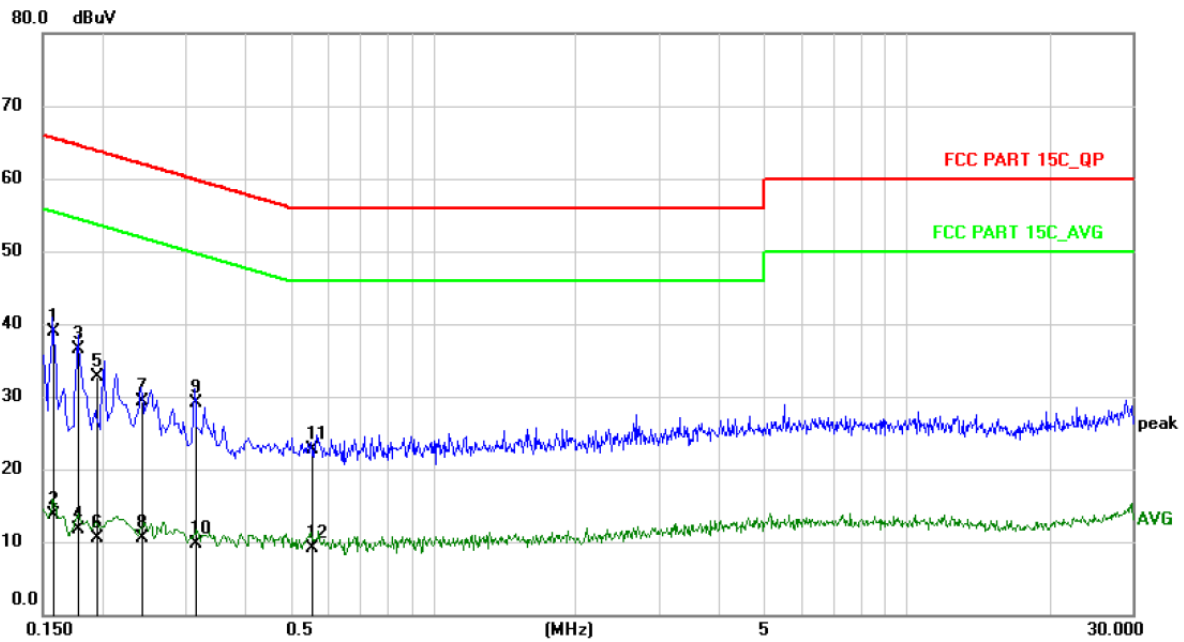

No. Mk.	Freq.	Reading Level	Correct Factor	Measurement	Limit	Over	Detector	Comment
	MHz	dBuV	dB	dBuV	dBuV	dB		
1 *	0.1580	18.35	20.55	38.90	65.57	-26.67	QP	
2	0.1580	-6.75	20.55	13.80	55.57	-41.77	AVG	
3	0.1780	15.94	20.56	36.50	64.58	-28.08	QP	
4	0.1780	-8.76	20.56	11.80	54.58	-42.78	AVG	
5	0.1954	12.24	20.56	32.80	63.80	-31.00	QP	
6	0.1954	-10.06	20.56	10.50	53.80	-43.30	AVG	
7	0.2420	8.73	20.57	29.30	62.03	-32.73	QP	
8	0.2420	-9.97	20.57	10.60	52.03	-41.43	AVG	
9	0.3140	8.62	20.58	29.20	59.86	-30.66	QP	
10	0.3140	-10.88	20.58	9.70	49.86	-40.16	AVG	
11	0.5540	2.13	20.57	22.70	56.00	-33.30	QP	
12	0.5540	-11.37	20.57	9.20	46.00	-36.80	AVG	

13.2 Radiated Spurious Emissions and Restricted Bands Measurement

LIMITS

Frequency range MHz	Distance Meters	Field Strengths Limit (15.209)
		$\mu\text{V/m}$
0.009 ~ 0.490	300	2400/F(kHz)
0.490 ~ 1.705	30	24000/F(kHz)
1.705 ~ 30	30	30
30 ~ 88	3	100
88 ~ 216	3	150
216 ~ 960	3	200
Above 960	3	500

- Remark:
- (1) Emission level (dB) μV = 20 log Emission level $\mu\text{V/m}$
 - (2) The smaller limit shall apply at the cross point between two frequency bands.
 - (3) As shown in 15.35(b), for frequencies above 1000MHz, the field strength limits are based on average detector, however, the peak field strength of any emission shall not exceed the maximum permitted average limits, specified above by more than 20dB under any condition of modulation.
 - (4) The frequency range scanned is from the lowest radio frequency signal generated in the device which is greater than 9 kHz to the tenth harmonic of the highest fundamental frequency or 40 GHz, whichever is lower.
 - (5) §15.247(d) specifies that emissions which fall in the restricted bands, as defined in §15.205 comply with radiated emission limits specified in §15.209.

BLOCK DIAGRAM OF TEST SETUP

For Radiated Emission below 30MHz

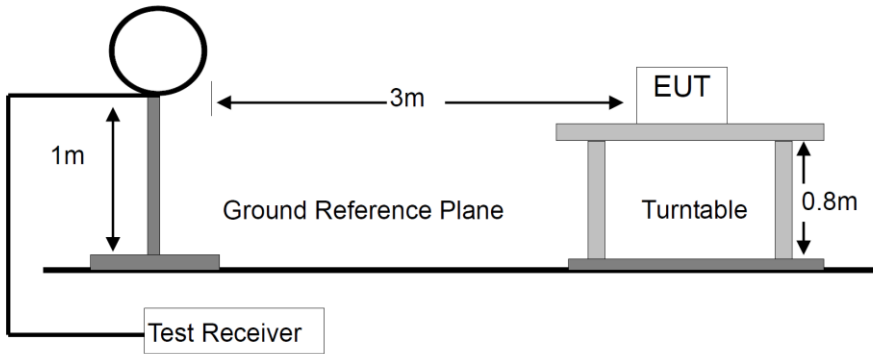

For Radiated Emission 30-1000MHz

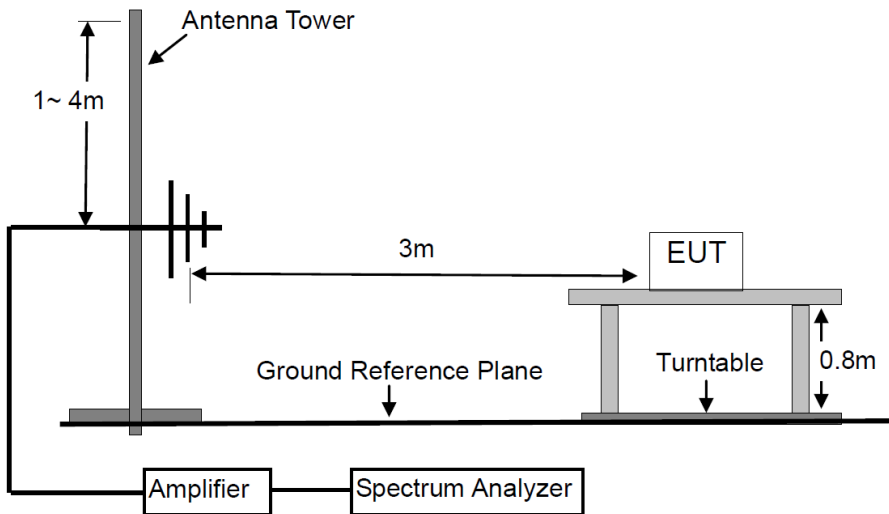

For Radiated Emission Above 1000MHz.

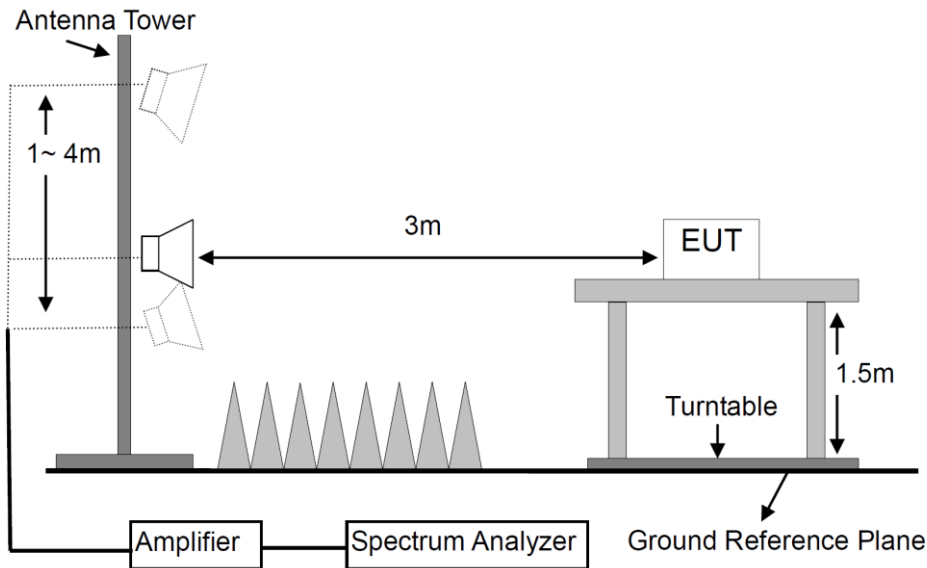

TEST PROCEDURES

- a. Below 1GHz, the EUT was placed on the top of a rotating table 0.8 meters above the ground at a 3 meter semi- anechoic chamber room.
- b. For the radiated emission test above 1GHz:

The EUT was placed on the top of a rotating table 1.5 meters above the ground at a 3 meter full anechoic chamber room. The table was rotated 360 degrees to determine the position of the highest radiation. Place the measurement antenna away from each area of the EUT determined to be a source of emissions at the specified measurement distance, while keeping the measurement antenna aimed at the source of emissions at each frequency of significant emissions, with polarization oriented for maximum response. The measurement antenna may have to be higher or lower than the EUT, depending on the radiation pattern of the emission and staying aimed at the emission source for receiving the maximum signal. The final measurement antenna elevation shall be that which maximizes the emissions. The measurement antenna elevation for maximum emissions shall be restricted to a range of heights of from 1 m to 4 m above the ground or reference ground plane.
- c. The EUT was set 3 meters away from the interference-receiving antenna, which was mounted on the top of a variable-height antenna tower.
- d. The height of antenna is varied from one meter to four meters above the ground to determine the maximum value of the field strength. Both horizontal and vertical polarizations of the antenna are set to make the measurement.

- e. For each suspected emission, the EUT was arranged to its worst case and then the antenna was tuned to heights from 1 meter to 4 meters and the rotatable table was turned from 0 degrees to 360 degrees to find the maximum reading. The test-receiver system was set to peak detect function and specified bandwidth with maximum hold mode.
- f. A Quasi-peak measurement was then made for that frequency point for below 1GHz test. PK and AV for above 1GHz emission test.
- g. Pre-Scan has been conducted to determine the worst-case mode from all possible combinations between available modulations, data rates, XYZ axis and packet type.

The worst case was found when the EUT was positioned on X axis for radiated emission.

During the radiated emission test, the spectrum analyzer was set with the following configurations:

Frequency Band (MHz)	Detector	Resolution Bandwidth	Video Bandwidth
30 to 1000	QP	120 kHz	300 kHz
Above 1000	Peak	1 MHz	3 MHz
	Average	1 MHz	10 Hz

TEST RESULTS

PASS

Please refer to the following pages of the worst case.

M/N: MPT-II	Testing Voltage: DC 7.4V
Polarization: Horizontal	Detector: QP
Test Mode: 5	Distance: 3m

Radiated Emission Measurement

Date: 2022/11/21

Time: 11:00:04

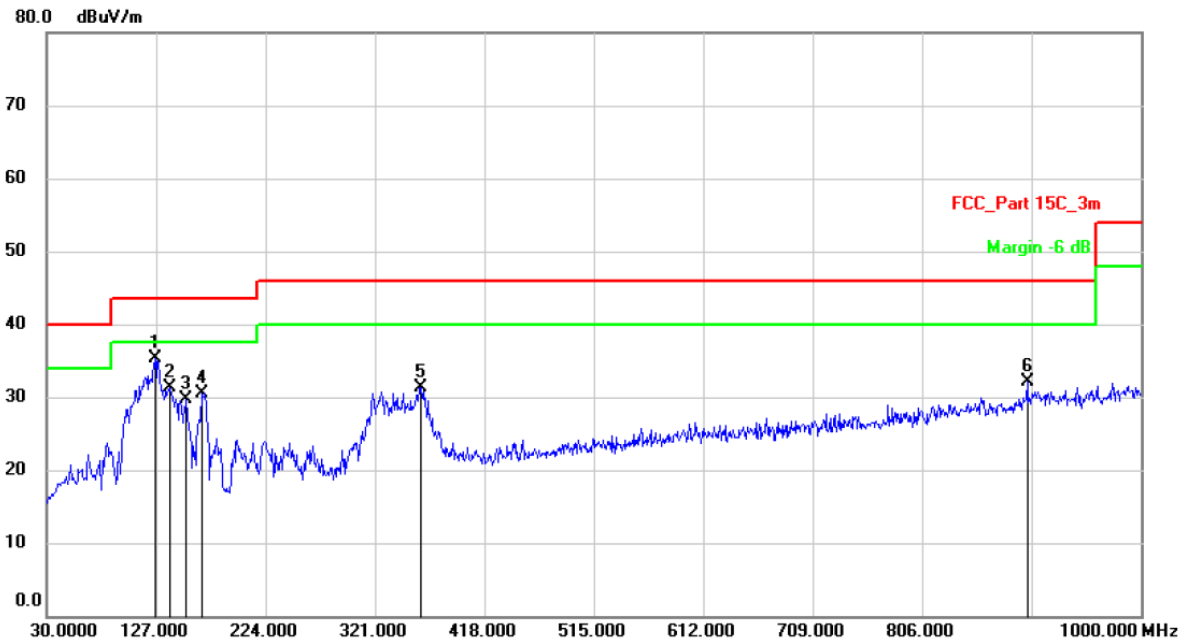

No.	Mk.	Freq.	Reading Level	Correct Factor	Measurement	Limit	Over	Detector	Comment
		MHz	dBuV	dB/m	dBuV/m	dBuV/m	dB		
1	*	126.0300	45.32	-10.10	35.22	43.50	-8.28	QP	
2		139.6100	42.29	-10.95	31.34	43.50	-12.16	QP	
3		153.1900	40.51	-10.75	29.76	43.50	-13.74	QP	
4		167.7400	40.66	-10.11	30.55	43.50	-12.95	QP	
5		361.7400	35.33	-3.99	31.34	46.00	-14.66	QP	
6		899.1200	25.98	6.15	32.13	46.00	-13.87	QP	

Note: Below 30MHz, the emissions are lower than 20dB below the allowable limit.

M/N: MPT-II	Testing Voltage: DC 7.4V
Polarization: Vertical	Detector: QP
Test Mode: 5	Distance: 3m

Radiated Emission Measurement

Date: 2022/11/21

Time: 11:05:49

80.0 dBuV/m

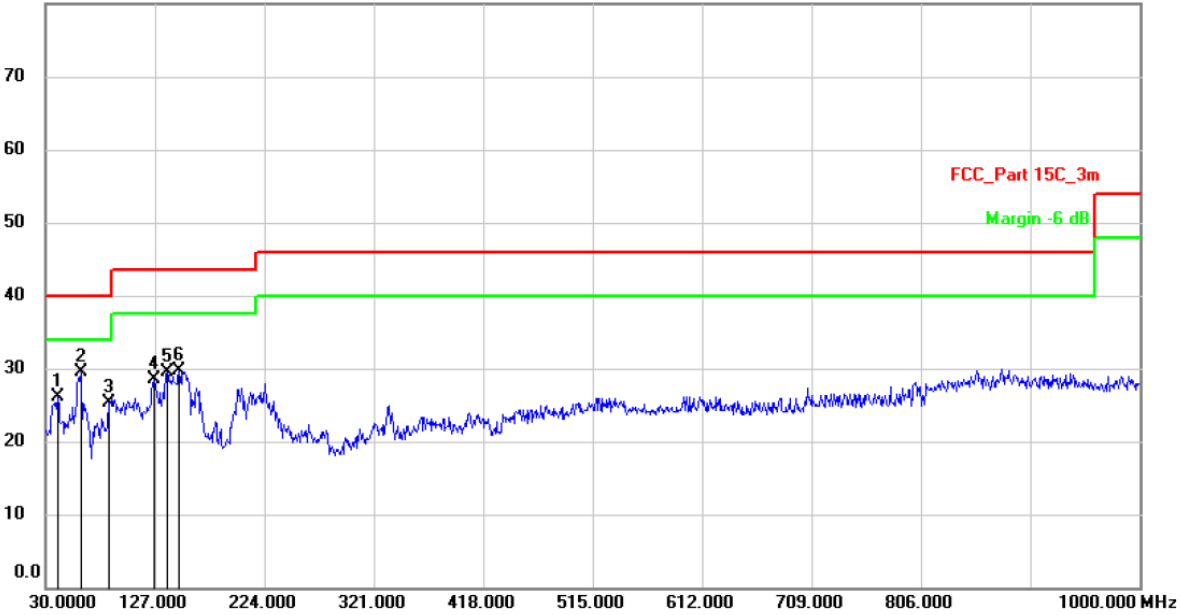

No.	Mk.	Freq.	Reading Level	Correct Factor	Measurement	Limit	Over	Detector	Comment
		MHz	dBuV	dB/m	dBuV/m	dBuV/m	dB		
1		40.6699	33.85	-7.84	26.01	40.00	-13.99	QP	
2	*	61.0400	37.49	-7.96	29.53	40.00	-10.47	QP	
3		86.2600	35.94	-10.67	25.27	40.00	-14.73	QP	
4		126.0300	39.79	-11.25	28.54	43.50	-14.96	QP	
5		137.6700	40.85	-11.42	29.43	43.50	-14.07	QP	
6		148.3400	41.51	-11.81	29.70	43.50	-13.80	QP	

Note: Below 30MHz, the emissions are lower than 20dB below the allowable limit.

Modulation: GFSK (the worst case)					Test Result: PASS		Test frequency range: 1-25GHz			
Freq. (MHz)	Ant. Pol. (H/V)	Reading Level(dBuV)		Factor (dB/m)	Emission Level (dBuV/m)		Limit 3m (dBuV/m)		Margin (dB)	
		PK	AV		PK	AV	PK	AV	PK	AV
Operation Mode: TX Mode (Low)										
4804	H	46.52	34.23	6.30	52.82	40.53	74.00	54.00	-21.18	-13.47
7206	H	45.88	35.54	10.44	56.32	45.98	74.00	54.00	-17.68	-8.02

4804	V	46.54	34.77	6.30	52.84	41.07	74.00	54.00	-21.16	-12.93
7206	V	46.44	35.35	10.44	56.88	45.79	74.00	54.00	-17.12	-8.21

Operation Mode: TX Mode (Mid)										
4882	H	46.44	36.19	6.60	53.04	42.79	74.00	54.00	-20.96	-11.21
7323	H	46.46	35.77	10.55	57.01	46.32	74.00	54.00	-16.99	-7.68

4882	V	46.46	34.42	6.60	53.06	41.02	74.00	54.00	-20.94	-12.98
7323	V	46.37	35.26	10.55	56.92	45.81	74.00	54.00	-17.08	-8.19

Operation Mode: TX Mode (High)										
4960	H	46.82	34.00	6.89	53.71	40.89	74.00	54.00	-20.29	-13.11
7440	H	48.01	35.68	10.60	58.61	46.28	74.00	54.00	-15.39	-7.72

4960	V	46.15	35.32	6.89	53.04	42.21	74.00	54.00	-20.96	-11.79
7440	V	46.72	36.29	10.60	57.32	46.89	74.00	54.00	-16.68	-7.11

Spurious Emission in restricted band:										
2390.000	H	48.42	32.55	0.13	48.55	32.68	74.00	54.00	-25.45	-21.32
2390.000	V	48.53	31.96	0.13	48.66	32.09	74.00	54.00	-25.34	-21.91
2483.500	H	49.28	35.28	0.34	49.62	35.62	74.00	54.00	-24.38	-18.38
2483.500	V	49.37	34.72	0.34	49.71	35.06	74.00	54.00	-24.29	-18.94

Remark: Data of measurement within this frequency range shown “---” in the table above means the reading of emissions are attenuated more than 20dB below the permissible limits.

13.3 Channel Separation test

LIMIT

Frequency hopping systems operating in the 2400-2483.5 MHz band may have hopping channel carrier frequencies that are separated by 25 kHz or two-thirds of the 20 dB bandwidth of the hopping channel, whichever is greater.

BLOCK DIAGRAM OF TEST SETUP

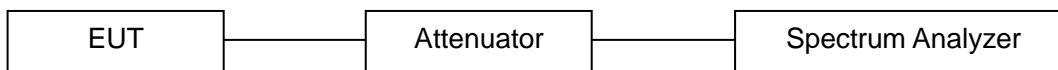

TEST PROCEDURES

- a. The RF output of EUT was connected to the spectrum analyzer by RF cable and attenuator. The path loss was compensated to the results for each measurement.
- b. Set to the maximum power setting and enable the EUT transmit continuously.
- c. Enable the EUT hopping function.
- d. Set spectrum analyzer and perform testing according to ANSI C63.10 clause 7.8.2.

TEST RESULTS

PASS

Please refer to the following tables.

Modulation	Channel	Frequency (MHz)	Hopping Separation Measurement (MHz)	Hopping Separation Limit (MHz)	Test Result
GFSK	Low	2402	0.990	>0.642	Pass
	Mid	2441	0.999	>0.644	Pass
	High	2480	0.999	>0.644	Pass
$\pi/4$ -DQPSK	Low	2402	1.002	>0.854	Pass
	Mid	2441	0.999	>0.842	Pass
	High	2480	1.002	>0.840	Pass
8DPSK	Low	2402	0.993	>0.864	Pass
	Mid	2441	1.002	>0.843	Pass
	High	2480	0.999	>0.843	Pass

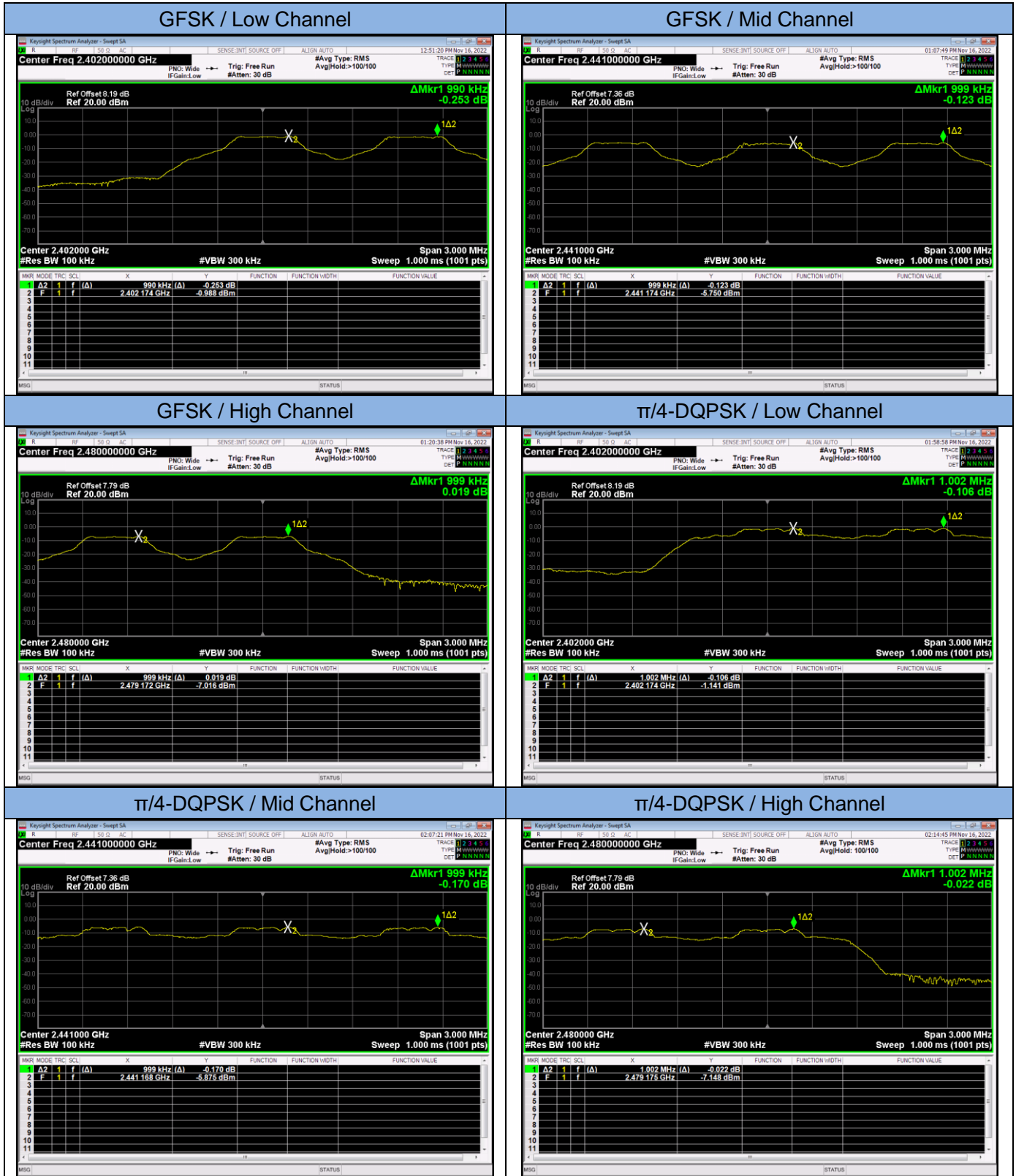

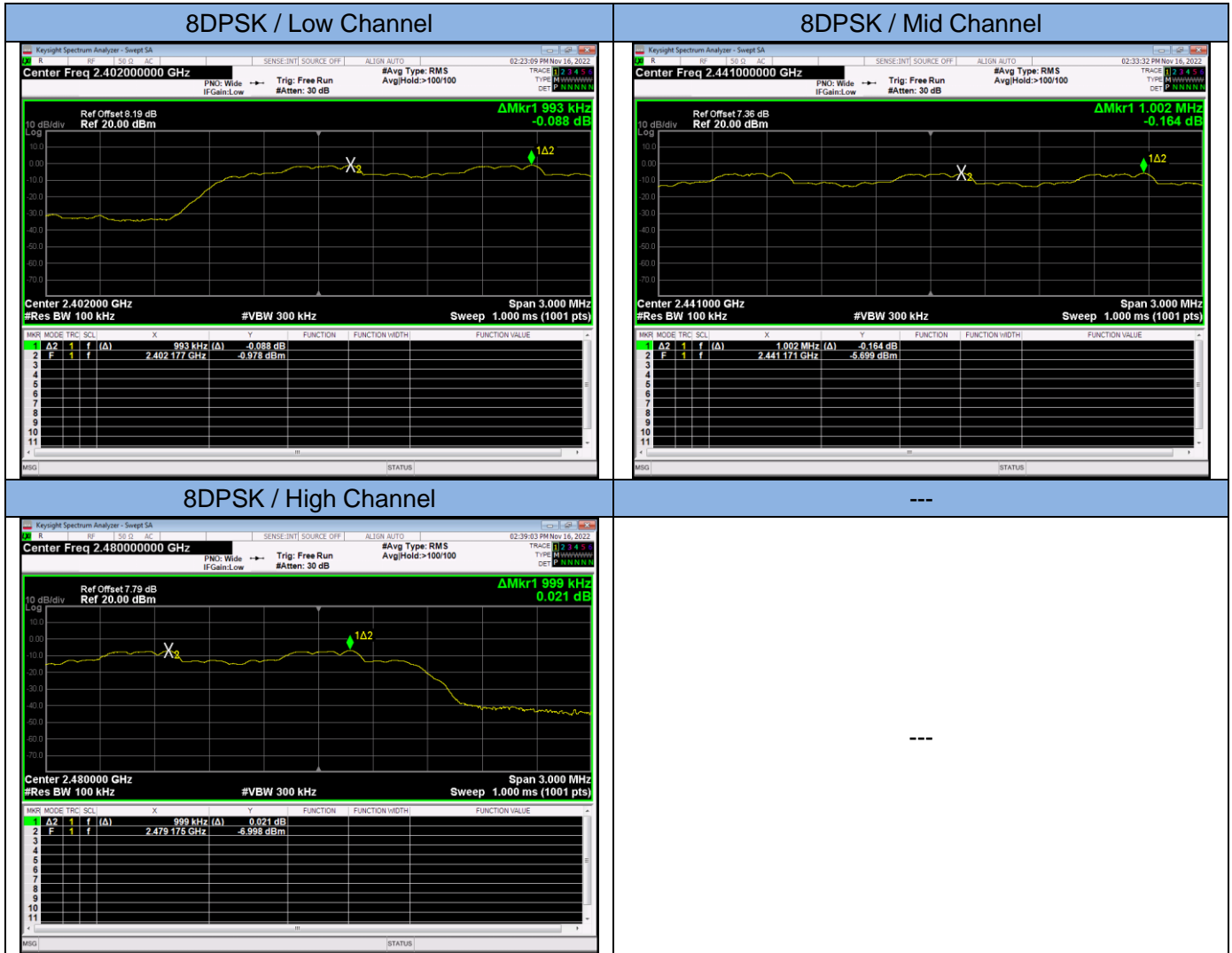

13.4 20dB Bandwidth

LIMIT

N/A

BLOCK DIAGRAM OF TEST SETUP

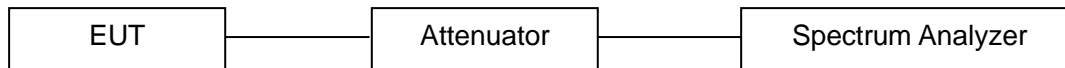

TEST PROCEDURES

- a. The RF output of EUT was connected to the spectrum analyzer by RF cable and attenuator. The path loss was compensated to the results for each measurement.
- b. Set to the maximum power setting and enable the EUT transmit continuously.
- c. Set spectrum analyzer and perform testing according to ANSI C63.10 clause 6.9.2.

TEST RESULTS

PASS

Please refer to the following tables.