

# FCC Radio Test Report

## FCC ID: 2AUT-FT800

**This report concerns: Original Grant**

**Project No.** : 2103C008  
**Equipment** : Wireless Home Printer  
**Brand Name** : HPRT, iDPRT  
**Test Model** : FT800  
**Series Model** : Future800  
**Applicant** : Xiamen Hanin Electronic Technology Co.,Ltd.  
**Address** : Room 305A, Angye Building, Pioneering Park,Torch High-tech, Zone, Xiamen  
**Manufacturer** : Xiamen Hanin Electronic Technology Co.,Ltd.  
**Address** : Room 305A, Angye Building, Pioneering Park,Torch High-tech, Zone, Xiamen  
**Factory** : Xiamen Hanin Electronic Technology Co.,Ltd.  
**Address** : 96# Rongyuan Road,Tong'an District,Xiamen  
**Date of Receipt** : Mar. 04, 2021  
**Date of Test** : May 25, 2021 ~ Jul. 06, 2021  
**Issued Date** : Jul. 06, 2021  
**Report Version** : R00  
**Test Sample** : Engineering Sample No.: DG2021030838  
**Standard(s)** : FCC CFR Title 47, Part 15, Subpart C  
ANSI C63.10-2013

The above equipment has been tested and found compliance with the requirement of the relative standards by BTL Inc.

*Vincent Tan*

Prepared by : Vincent Tan

*Ethan Ma*

Approved by : Ethan Ma



TESTING CERT #5123.02

Add: No.3, Jinshagang 1st Road, Shixia, Dalang Town,Dongguan, Guangdong, China.

Tel: +86-769-8318-3000

Web: [www.newbtl.com](http://www.newbtl.com)

**Declaration**

**BTL** represents to the client that testing is done in accordance with standard procedures as applicable and that test instruments used has been calibrated with standards traceable to international standard(s) and/or national standard(s).

**BTL's** reports apply only to the specific samples tested under conditions. It is manufacture's responsibility to ensure that additional production units of this model are manufactured with the identical electrical and mechanical components. **BTL** shall have no liability for any declarations, inferences or generalizations drawn by the client or others from **BTL** issued reports.

The report must not be used by the client to claim product certification, approval, or endorsement by NVLAP, NIST, A2LA, or any agency of the U.S. Government.

This report is the confidential property of the client. As a mutual protection to the clients, the public and ourselves, the test report shall not be reproduced, except in full, without our written approval.

**BTL's** laboratory quality assurance procedures are in compliance with the **ISO/IEC 17025** requirements, and accredited by the conformity assessment authorities listed in this test report.

**BTL** is not responsible for the sampling stage, so the results only apply to the sample as received.

The information, data and test plan are provided by manufacturer which may affect the validity of results, so it is manufacturer's responsibility to ensure that the apparatus meets the essential requirements of applied standards and in all the possible configurations as representative of its intended use.

**Limitation**

For the use of the authority's logo is limited unless the Test Standard(s)/Scope(s)/Item(s) mentioned in this test report is (are) included in the conformity assessment authorities acceptance respective.

Please note that the measurement uncertainty is provided for informational purpose only and are not use in determining the Pass/Fail results.

<b>Table of Contents</b>	<b>Page</b>
<b>REPORT ISSUED HISTORY</b>	<b>5</b>
<b>1 . SUMMARY OF TEST RESULTS</b>	<b>6</b>
1.1 TEST FACILITY	7
1.2 MEASUREMENT UNCERTAINTY	7
1.3 TEST ENVIRONMENT CONDITIONS	7
<b>2 . GENERAL INFORMATION</b>	<b>8</b>
2.1 GENERAL DESCRIPTION OF EUT	8
2.2 DESCRIPTION OF TEST MODES	9
2.3 BLOCK DIAGRAM SHOWING THE CONFIGURATION OF SYSTEM TESTED	10
2.4 SUPPORT UNITS	10
<b>3 . AC POWER LINE CONDUCTED EMISSIONS TEST</b>	<b>11</b>
3.1 LIMIT	11
3.2 TEST PROCEDURE	11
3.3 DEVIATION FROM TEST STANDARD	11
3.4 TEST SETUP	12
3.5 EUT OPERATING CONDITIONS	12
3.6 TEST RESULTS	12
<b>4 . RADIATED EMISSION TEST</b>	<b>13</b>
4.1 LIMIT	13
4.2 TEST PROCEDURE	14
4.3 DEVIATION FROM TEST STANDARD	14
4.4 TEST SETUP	15
4.5 EUT OPERATING CONDITIONS	16
4.6 TEST RESULTS - 9 KHZ TO 30 MHZ	16
4.7 TEST RESULTS - 30 MHZ TO 1000 MHZ	16
<b>5 . FREQUENCY TOLERANCE TEST</b>	<b>17</b>
5.1 LIMIT	17
5.2 TEST PROCEDURE	17
5.3 DEVIATION FROM STANDARD	17
5.4 TEST SETUP	17
5.5 EUT OPERATION CONDITIONS	17
5.6 TEST RESULTS	17
<b>6 . MEASUREMENT INSTRUMENTS LIST</b>	<b>18</b>

**Table of Contents****Page**

<b>7 . EUT TEST PHOTO</b>	<b>19</b>
<b>APPENDIX A - AC POWER LINE CONDUCTED EMISSIONS</b>	<b>22</b>
<b>APPENDIX B - RADIATED EMISSION - 9 KHZ TO 30 MHZ</b>	<b>25</b>
<b>APPENDIX C - RADIATED EMISSION - 30 MHZ TO 1000 MHZ</b>	<b>32</b>
<b>APPENDIX D - FREQUENCY TOLERANCE</b>	<b>35</b>

**REPORT ISSUED HISTORY**

Report Version	Description	Issued Date
R00	Original Issue.	Jul. 06, 2021

## 1. SUMMARY OF TEST RESULTS

Test procedures according to the technical standard(s):

FCC CFR Title 47, Part 15, Subpart C				
Standard(s) Section	Test Item	Test Result	Judgment	Remark
15.207	AC Power Line Conducted Emissions	APPENDIX A	PASS	-----
15.225(a)-(d) 15.205(a) 15.209(a)	Radiated Emission	APPENDIX B APPENDIX C	PASS	-----
15.225(e)	Frequency Tolerance	APPENDIX D	PASS	-----
15.203	Antenna Requirement	-----	PASS	Note(2)

Note:

- (1) "N/A" denotes test is not applicable in this test report
- (2) The device what use a permanently attached antenna were considered sufficient to comply with the provisions of 15.203.

### 1.1 TEST FACILITY

The test facilities used to collect the test data in this report is at the location of No.3, Jinshagang 1st Road, Shixia, Dalang Town, Dongguan, Guangdong, China  
 BTL's Test Firm Registration Number for FCC: 357015  
 BTL's Designation Number for FCC: CN1240

### 1.2 MEASUREMENT UNCERTAINTY

ISO/IEC 17025 requires that an estimate of the measurement uncertainties associated with the emissions test results be included in the report. The measurement uncertainties given below are based on a 95% confidence level (based on a coverage factor (k=2))  
 The BTL measurement uncertainty as below table:

A. AC power line conducted emissions test:

Test Site	Method	Measurement Frequency Range	U, (dB)
DG-C02	CISPR	150 kHz ~ 30 MHz	2.68

B. Radiated emissions test:

Test Site	Method	Measurement Frequency Range	Ant. H / V	U, (dB)
DG-CB03	CISPR	9kHz ~ 30MHz	-	3.02
		30MHz ~ 200MHz	V	4.26
		30MHz ~ 200MHz	H	3.38
		200MHz ~ 1,000MHz	V	3.98
		200MHz ~ 1,000MHz	H	3.94

C. Other Measurement test:

Test Item	Uncertainty
Frequency Stability	±0.16 dB
Temperature	±0.08 °C
Humidity	±1.5%

Note: Unless specifically mentioned, the uncertainty of measurement has not been taken into account to declare the compliance or non-compliance to the specification.

### 1.3 TEST ENVIRONMENT CONDITIONS

Test Item	Temperature	Humidity	Test Voltage	Tested By
AC Power Line Conducted Emissions	25°C	53%	AC 120V/60Hz	Hand Huang
Radiated Emissions-9kHz to 30MHz	25°C	60%	AC 120V/60Hz	Hayden Chen
Radiated Emissions-30MHz to 1000MHz	26°C	52%	AC 120V/60Hz	Hayden Chen
Frequency Tolerance	Normal & Extreme			Kwok Guo

## 2. GENERAL INFORMATION

### 2.1 GENERAL DESCRIPTION OF EUT

Equipment	Wireless Home Printer
Brand Name	HPRT, iDPRT
Test Model	FT800
Series Model	Future800
Model Difference(s)	Only differ in model name, the internal circuit, panel, enclosure and power board are all the same.
Power Source	DC voltage supplied from AC adapter. Model: AP091G-140300
Power Rating	I/P: 100-240V~ 50/60Hz 1.5A Max. O/P: 14.0V $\approx$ 3.0A
Operation Frequency	13.56 MHz
Antenna Type	Loop Antenna

Note:

1. For a more detailed features description, please refer to the manufacturer's specifications or the user's manual.

2. Channel List:

Test Channel	Test Frequency (MHz)
01	13.56



## 2.2 DESCRIPTION OF TEST MODES

The test system was pre-tested based on the consideration of all possible combinations of EUT operation mode.

Pretest Mode	Description
Mode 1	TX Mode_ 13.56MHz

Following mode(s) was (were) found to be the worst case(s) and selected for the final test.

<b>AC power line conducted emissions test</b>	
Final Test Mode	Description
Mode 1	TX Mode_ 13.56MHz

<b>Radiated emissions test - Below 1GHz</b>	
Final Test Mode	Description
Mode 1	TX Mode_ 13.56MHz

<b>Conducted test</b>	
Final Test Mode	Description
Mode 1	TX Mode_ 13.56MHz

**2.3 BLOCK DIAGRAM SHOWING THE CONFIGURATION OF SYSTEM TESTED**

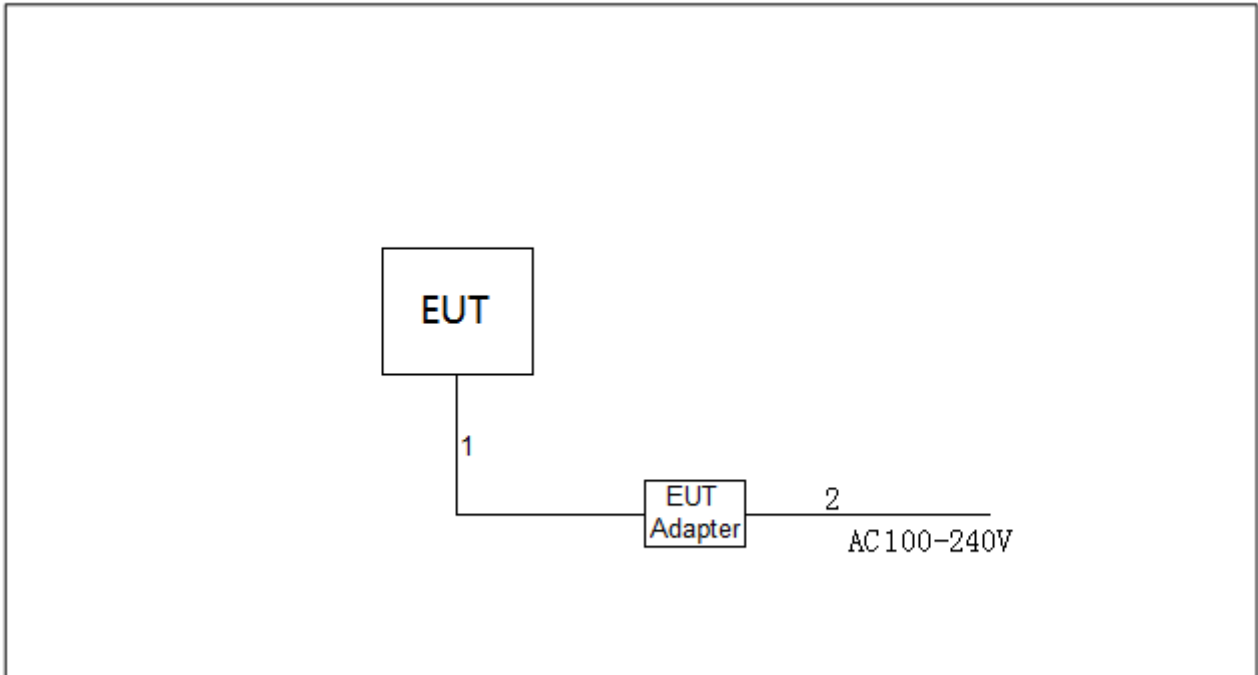

**2.4 SUPPORT UNITS**

Item	Equipment	Mfr/Brand	Model	Series No.
-	-	-	-	-

Item	Cable Type	Shielded Type	Ferrite Core	Length
1	DC Cable	NO	NO	1.2m
2	AC Cable	NO	NO	1.5m

### 3. AC POWER LINE CONDUCTED EMISSIONS TEST

#### 3.1 LIMIT

Frequency of Emission (MHz)	Limit (dB $\mu$ V)	
	Quasi-peak	Average
0.15 - 0.5	66 to 56*	56 to 46*
0.5 - 5.0	56	46
5.0 - 30.0	60	50

Note:

- (1) The tighter limit applies at the band edges.
- (2) The limit of "\*" marked band means the limitation decreases linearly with the logarithm of the frequency in the range.

#### 3.2 TEST PROCEDURE

- a. The EUT was placed 0.8 meters from the horizontal ground plane with EUT being connected to the power mains through a line impedance stabilization network (LISN). All other support equipment powered from additional LISN(s). The LISN provide 50 Ohm/ 50uH of coupling impedance for the measuring instrument.
- b. Interconnecting cables that hang closer than 40 cm to the ground plane shall be folded back and forth in the center forming a bundle 30 to 40 cm long.
- c. I/O cables that are not connected to a peripheral shall be bundled in the center. The end of the cable may be terminated, if required, using the correct terminating impedance. The overall length shall not exceed 1 m.
- d. LISN at least 80 cm from nearest part of EUT chassis.
- e. For the actual test configuration, please refer to the related Item –EUT Test Photos.

The following table is the setting of the receiver

Receiver Parameter	Setting
Start Frequency	0.15 MHz
Stop Frequency	30 MHz
IF Bandwidth	9 kHz

#### 3.3 DEVIATION FROM TEST STANDARD

No deviation

### 3.4 TEST SETUP

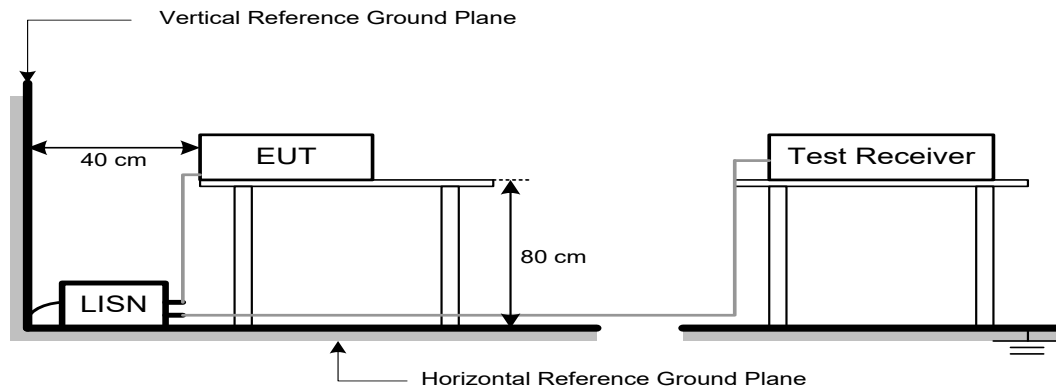

### 3.5 EUT OPERATING CONDITIONS

The EUT was configured for testing in a typical function (as a customer would normally use it), EUT was programmed to be in continuously transmitting data or hopping on mode.

### 3.6 TEST RESULTS

Please refer to the APPENDIX A.

Remark:

- (1) All readings are QP Mode value unless otherwise stated AVG in column of Note . If the QP Mode Measured value compliance with the QP Limits and lower than AVG Limits, the EUT shall be deemed to meet both QP & AVG Limits and then only QP Mode was measured, but AVG Mode didn't perform in this case, a "\*" marked in AVG Mode column of Interference Voltage Measured.
- (2) Measuring frequency range from 150 kHz to 30 MHz.

## 4. RADIATED EMISSION TEST

### 4.1 LIMIT

#### §15.225 (a)

The field strength of any emissions within the band 13.553-13.567 MHz shall not exceed 15,848 microvolts/meter at 30 meters.

#### §15.225 (b)

Within the bands 13.410-13.553 MHz and 13.567-13.710 MHz, the field strength of any emissions shall not exceed 334 microvolts/meter at 30 meters.

#### §15.225 (c)

Within the bands 13.110-13.410 MHz and 13.710-14.010 MHz the field strength of any emissions shall not exceed 106 microvolts/meter at 30 meters.

#### §15.225 (d)

The field strength of any emissions appearing outside of the 13.110-14.010 MHz band shall not exceed the general radiated emission limits in §15.209.

#### §15.209 (a)

Except as provided elsewhere in this subpart, the emissions from an intentional radiator shall not exceed the field strength levels specified in the following table:

#### LIMITS OF RADIATED EMISSION MEASUREMENT (9 kHz-1000 MHz)

Frequency (MHz)	Field Strength (microvolts/meter)	Measurement Distance (meters)
0.009-0.490	2400/F(kHz)	300
0.490-1.705	24000/F(kHz)	30
1.705-30.0	30	30
30-88	100	3
88-216	150	3
216-960	200	3
Above 960	500	3

#### Note:

- (1) The limit for radiated test was performed according to FCC CFR Title 47, Part 15, Subpart C.
- (2) The tighter limit applies at the band edges.
- (3) Emission level (dBuV/m)=20log Emission level (uV/m).

## 4.2 TEST PROCEDURE

The test set-up was made in accordance to the general provisions of ANSI C63.10-2013. The Equipment Under Test (EUT) was set up on a non-conductive table in the semi-anechoic chamber. The test was performed at the distance of 3 m between the EUT and the receiving antenna. The radiated emissions measurements were made in a typical installation configuration.

Sweep the whole frequency band through the range from 9 kHz to the 10th harmonic of the carrier, and the emissions less than 20 dB below the permissible value are reported.

During the test, below 30MHz, the center of the loop shall be 1 meters; above 30MHz, the height of receive antenna shall be moved from 1 to 4 meters, and the antenna shall be performed under horizontal and vertical polarization. The turntable shall be rotated from 0 to 360 degrees for detecting the maximum of radiated spurious signal level. The measurements shall be repeated with orthogonal polarization of the test antenna. The data of cable loss and antenna factor has been calibrated in full testing frequency range before the testing.

Spectrum Parameters	Setting
Start ~ Stop Frequency	9 kHz~150 kHz for RBW 200 Hz
Start ~ Stop Frequency	0.15 MHz~30 MHz for RBW 9 kHz
Start ~ Stop Frequency	30 MHz~1000 MHz for RBW 100 kHz

Receiver Parameters	Setting
Start ~ Stop Frequency	9 kHz~90 kHz for PK/AVG detector
Start ~ Stop Frequency	90 kHz~110 kHz for QP detector
Start ~ Stop Frequency	110 kHz~490 kHz for PK/AVG detector
Start ~ Stop Frequency	490 kHz~30 MHz for QP detector
Start ~ Stop Frequency	30 MHz~1000 MHz for QP detector

The radiated emission was measured in the following position: EUT stand-up position (Z axis), lie-down position (X, Y axis). The worst emission was found in stand-up position (Z axis) and the worst case was recorded.

## 4.3 DEVIATION FROM TEST STANDARD

No deviation

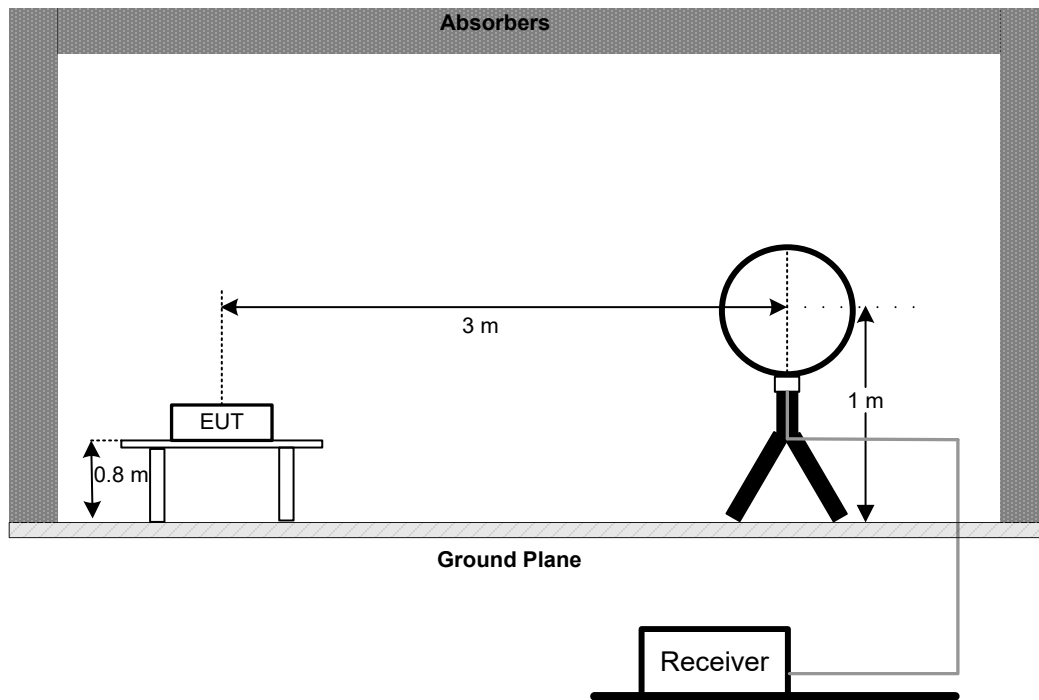
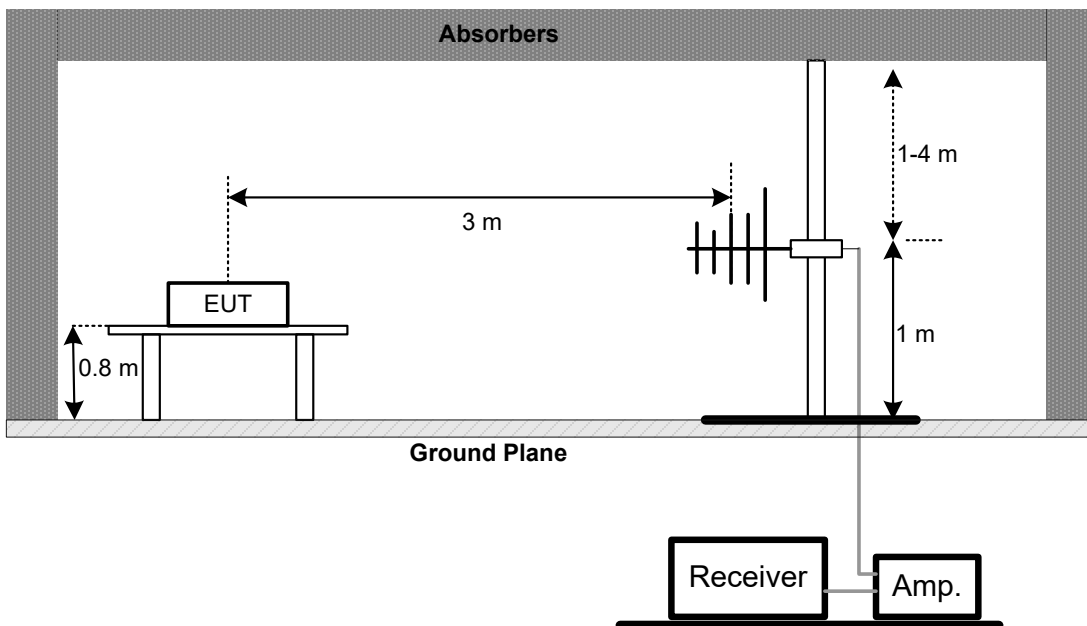
**4.4 TEST SETUP****9 kHz to 30 MHz****30 MHz to 1000 MHz**

**4.5 EUT OPERATING CONDITIONS**

The EUT was programmed to be in continuously transmitting mode.

**4.6 TEST RESULTS - 9 kHz TO 30 MHz**

Please refer to the APPENDIX B

Remark:

- (1) Distance extrapolation factor =  $40 \log$  (specific distance / test distance) (dB).
- (2) Limit line = specific limits (dBuV) + distance extrapolation factor.

**4.7 TEST RESULTS - 30 MHz TO 1000 MHz**

Please refer to the APPENDIX C.



## 5. FREQUENCY TOLERANCE TEST

### 5.1 LIMIT

Section	Test Item	Limit
FCC 15.225(e)	Frequency Tolerance	$\pm 1.356$ kHz

### 5.2 TEST PROCEDURE

The frequency tolerance of the carrier signal shall be maintained within  $\pm 0.01\%$  of the operating frequency over a temperature variation of  $-20$  degrees to  $+ 50$  degrees C at normal supply voltage, and for a variation in the primary supply voltage from 85% to 115% of the rated supply voltage at a temperature of 20 degrees C. For battery operated equipment, the equipment tests shall be performed using a new battery.

### 5.3 DEVIATION FROM STANDARD

No deviation.

### 5.4 TEST SETUP

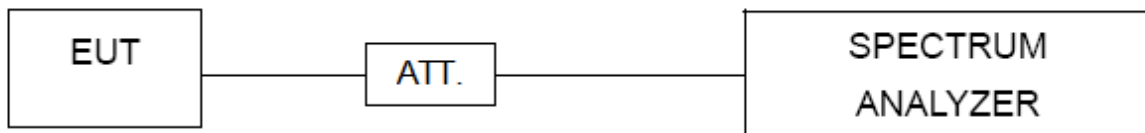

### 5.5 EUT OPERATION CONDITIONS

The EUT tested system was configured as the statements of 3.5 unless otherwise a special operating condition is specified in the follows during the testing.

### 5.6 TEST RESULTS

Please refer to the APPENDIX D.

## 6. MEASUREMENT INSTRUMENTS LIST

AC Power Line Conducted Emissions					
Item	Kind of Equipment	Manufacturer	Type No.	Serial No.	Calibrated until
1	EMI Test Receiver	R&S	ESCI	100382	Feb. 28, 2022
2	LISN	EMCO	3816/2	52765	Feb. 27, 2022
3	TWO-LINE V-NETWORK	R&S	ENV216	101447	Feb. 27, 2022
4	50Ω Terminator	SHX	TF5-3	15041305	Feb. 27, 2022
5	Measurement Software	Farad	EZ-EMC Ver.NB-03A1-01	N/A	N/A
6	Cable	N/A	RG223	12m	Mar. 09, 2022
7	643 Shield Room	ETS	6*4*3m	N/A	N/A

Radiated Emissions - 9 kHz to 30 MHz					
Item	Kind of Equipment	Manufacturer	Type No.	Serial No.	Calibrated until
1	Antenna	EM	EM-6876-1	230	Apr. 28, 2022
2	Cable	N/A	RG 213/U(9kHz~1GHz)	N/A	May 27, 2022
3	EMI Test Receiver	R&S	ESCI	100895	Feb. 27, 2022
4	Measurement Software	Farad	EZ-EMC Ver.NB-03A1-01	N/A	N/A
5	966 Chambe Room	RM	9*6*6m	N/A	Jul. 25, 2021

Radiated Emissions - 30 MHz to 1 GHz					
Item	Kind of Equipment	Manufacturer	Type No.	Serial No.	Calibrated until
1	Antenna	Schwarzbeck	VULB9160	9160-3231	Apr. 14, 2022
2	Amplifier	HP	8447D	2944A09673	Aug. 11, 2021
3	Receiver	Agilent	N9038A	MY52130039	Jul. 25, 2021
4	Cable	emci	LMR-400(30MHz-1 GHz)(8m+5m)	N/A	May 20, 2022
5	Controller	CT	SC100	N/A	N/A
6	Controller	MF	MF-7802	MF780208416	N/A
7	Measurement Software	Farad	EZ-EMC Ver.NB-03A1-01	N/A	N/A
8	966 Chambe Room	RM	9*6*6m	N/A	Jul. 25, 2021

Frequency Tolerance					
Item	Kind of Equipment	Manufacturer	Type No.	Serial No.	Calibrated until
1	Spectrum Analyzer	R&S	FSP40	100185	Jul. 25, 2021
2	Precision Oven Tester	CEPREI	CEEC-M64T-40	15-008	Feb. 27, 2022

Remark "N/A" denotes no model name, serial no. or calibration specified.

All calibration period of equipment list is one year.

**7. EUT TEST PHOTO****AC Power Line Conducted Emissions Test Photos**

**Radiated Emissions Test Photos****9 kHz to 30 MHz**

**Radiated Emissions Test Photos****30 MHz to 1 GHz**

## **APPENDIX A - AC POWER LINE CONDUCTED EMISSIONS**

Test Mode	TX Mode_13.56MHz
-----------	------------------

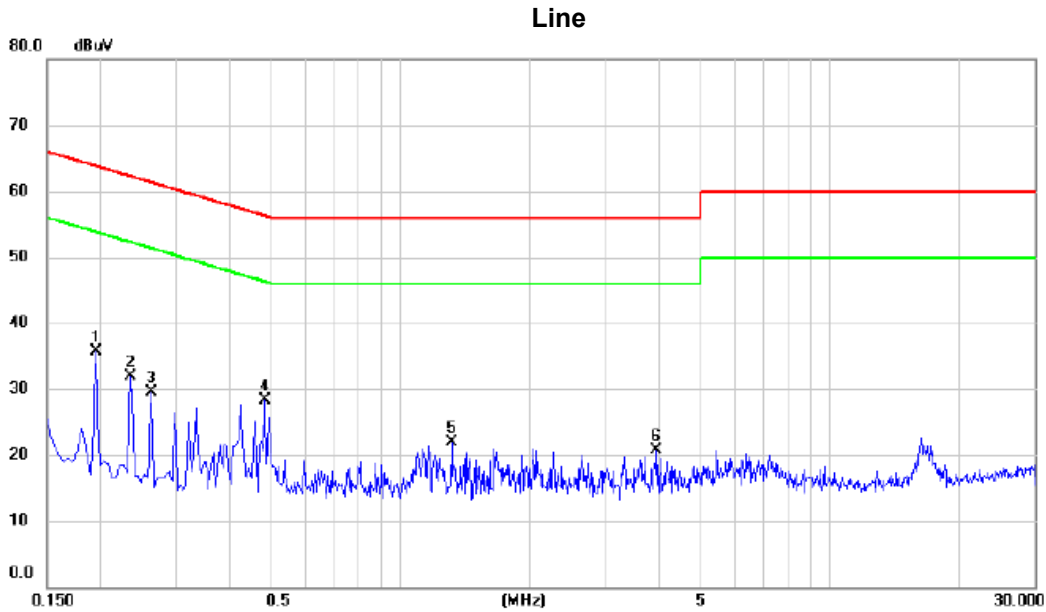

No.	Mk.	Freq. MHz	Reading Level dBuV	Correct Factor dB	Measure- ment dBuV	Limit dBuV	Margin dB	Detector	Comment
1		0.1950	25.76	9.90	35.66	63.82	-28.16	peak	
2		0.2355	21.98	9.88	31.86	62.25	-30.39	peak	
3		0.2625	19.68	9.87	29.55	61.35	-31.80	peak	
4	*	0.4830	18.41	9.93	28.34	56.29	-27.95	peak	
5		1.3154	11.97	10.00	21.97	56.00	-34.03	peak	
6		3.9480	10.51	10.20	20.71	56.00	-35.29	peak	

**REMARKS:**

- (1) Measurement Value = Reading Level + Correct Factor.
- (2) Margin Level = Measurement Value - Limit Value.

Test Mode TX Mode\_13.56MHz

### Neutral

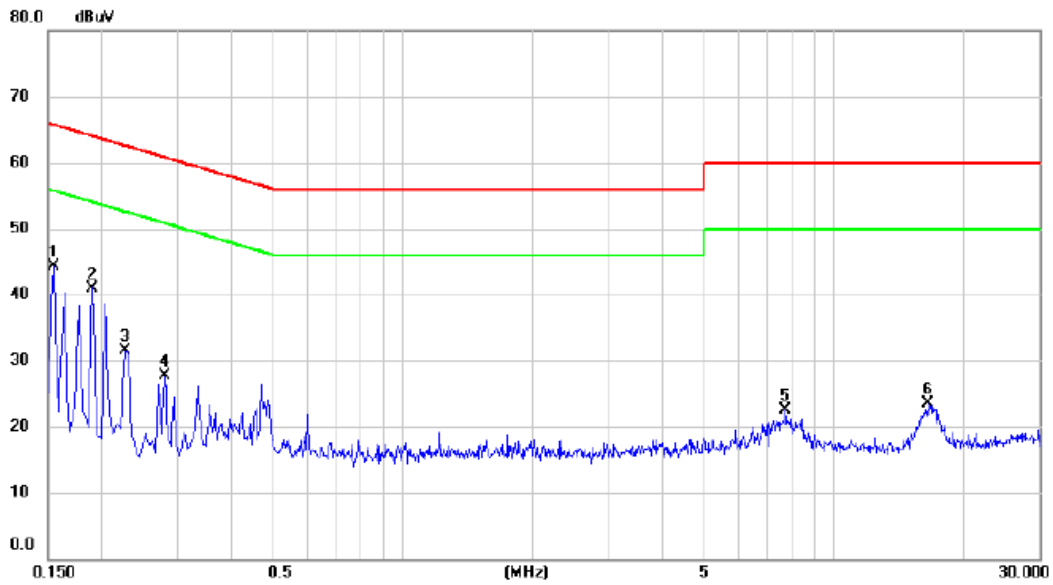

No.	Mk.	Freq. MHz	Reading Level dBuV	Correct Factor dB	Measure- ment dBuV	Limit dBuV	Margin dB	Detector	Comment
1	*	0.1544	34.46	9.77	44.23	65.76	-21.53	peak	
2		0.1905	31.02	9.98	41.00	64.01	-23.01	peak	
3		0.2267	21.55	9.99	31.54	62.57	-31.03	peak	
4		0.2805	17.64	9.99	27.63	60.80	-33.17	peak	
5		7.7010	11.65	10.83	22.48	60.00	-37.52	peak	
6		16.5660	12.36	11.10	23.46	60.00	-36.54	peak	

**REMARKS:**

- (1) Measurement Value = Reading Level + Correct Factor.
- (2) Margin Level = Measurement Value - Limit Value.



## **APPENDIX B - RADIATED EMISSION - 9 KHZ TO 30 MHZ**

Test Mode	TX Mode_13.56MHz	Polarization	Ant 0°
-----------	------------------	--------------	--------

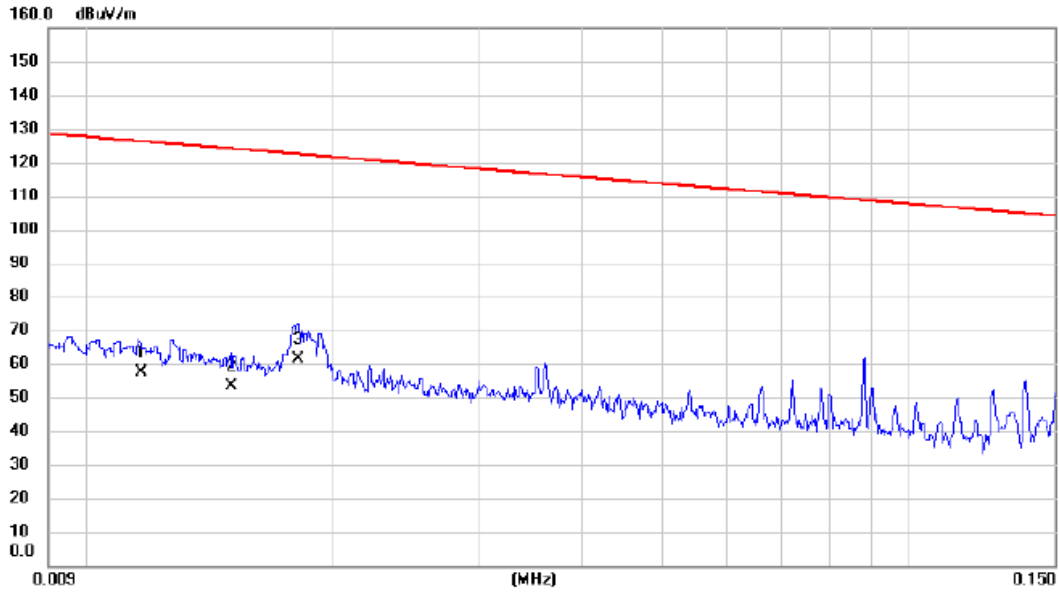

No.	Mk.	Freq.	Reading Level	Correct Factor	Measurement	Limit	Margin	Antenna Height	Table Degree	Comment
		MHz	dBuV	dB	dBuV/m	dBuV/m	dB	cm	degree	
1		0.0117	40.25	17.02	57.27	126.24	-68.97	AVG		
2		0.0150	37.54	15.98	53.52	124.08	-70.56	AVG		
3	*	0.0181	46.52	15.01	61.53	122.45	-60.92	AVG		

**REMARKS:**

- (1) Measurement Value = Reading Level + Correct Factor.
- (2) Margin Level = Measurement Value - Limit Value.

Test Mode	TX Mode_ 13.56MHz	Polarization	Ant 0°
-----------	-------------------	--------------	--------

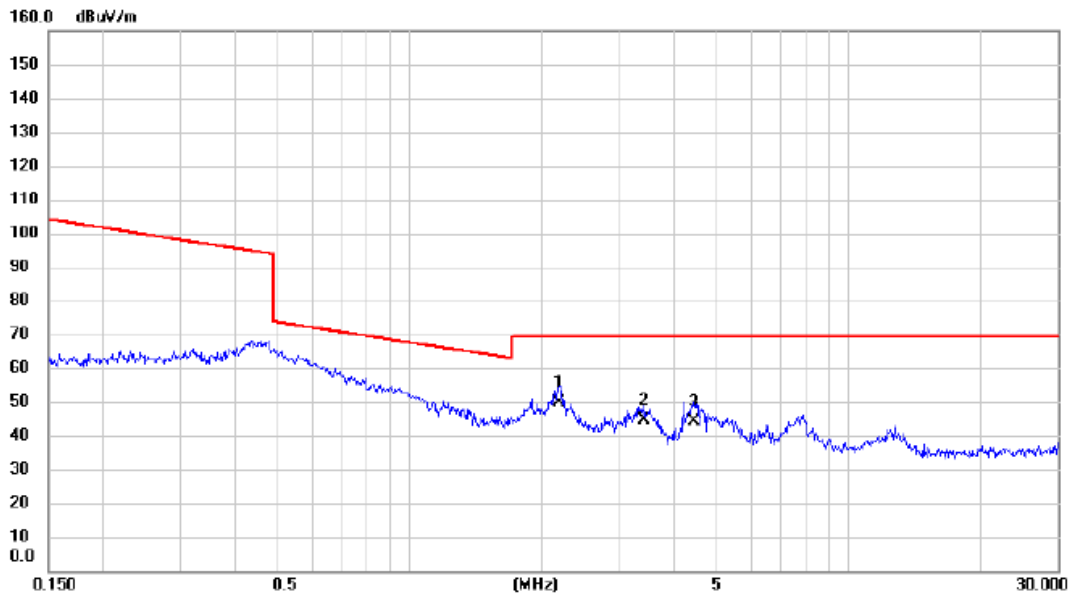

No. Mk.	Freq. MHz	Reading Level dBuV	Correct Factor dB	Measurement dBuV/m	Limit dBuV/m	Margin dB	Detector	Antenna Height cm	Table Degree	Comment
1 *	2.1898	37.54	12.19	49.73	69.54	-19.81	QP			
2	3.4174	32.62	11.99	44.61	69.54	-24.93	QP			
3	4.4305	32.24	12.07	44.31	69.54	-25.23	QP			

**REMARKS:**

- (1) Measurement Value = Reading Level + Correct Factor.
- (2) Margin Level = Measurement Value - Limit Value.

Test Mode	TX Mode_ 13.56MHz	Polarization	Ant 90°
-----------	-------------------	--------------	---------

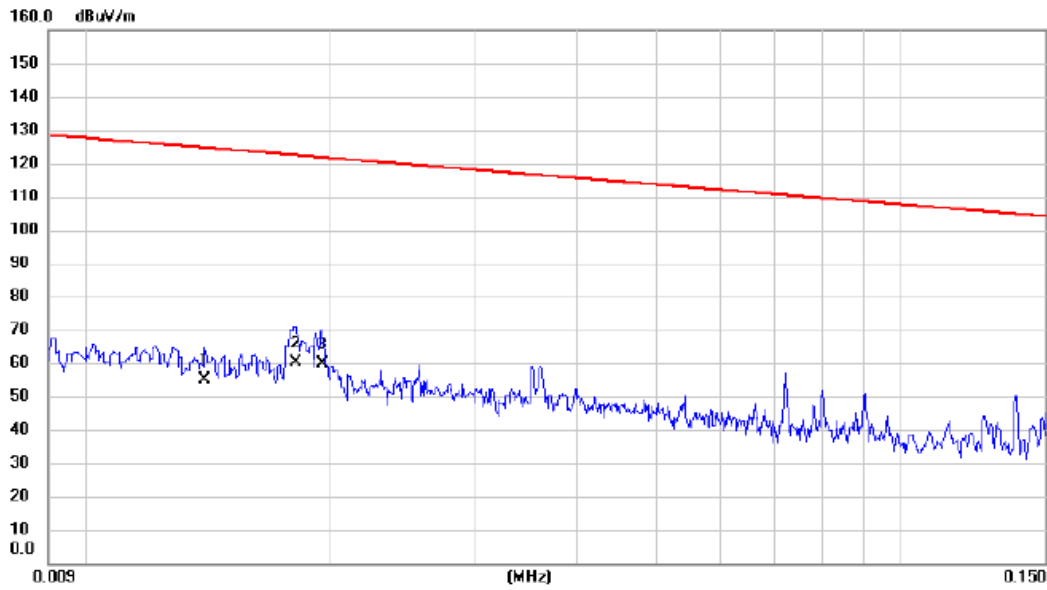

No.	Mk.	Freq.	Reading Level	Correct Factor	Measurement	Limit	Margin	Antenna Height	Table Degree	
		MHz	dBuV	dB	dBuV/m	dBuV/m	dB	cm	degree	Comment
1		0.0140	38.69	16.30	54.99	124.68	-69.69	AVG		
2		0.0181	45.26	15.01	60.27	122.45	-62.18	AVG		
3	*	0.0195	45.36	14.57	59.93	121.80	-61.87	AVG		

**REMARKS:**

- (1) Measurement Value = Reading Level + Correct Factor.
- (2) Margin Level = Measurement Value - Limit Value.

Test Mode	TX Mode_ 13.56MHz	Polarization	Ant 90°
-----------	-------------------	--------------	---------

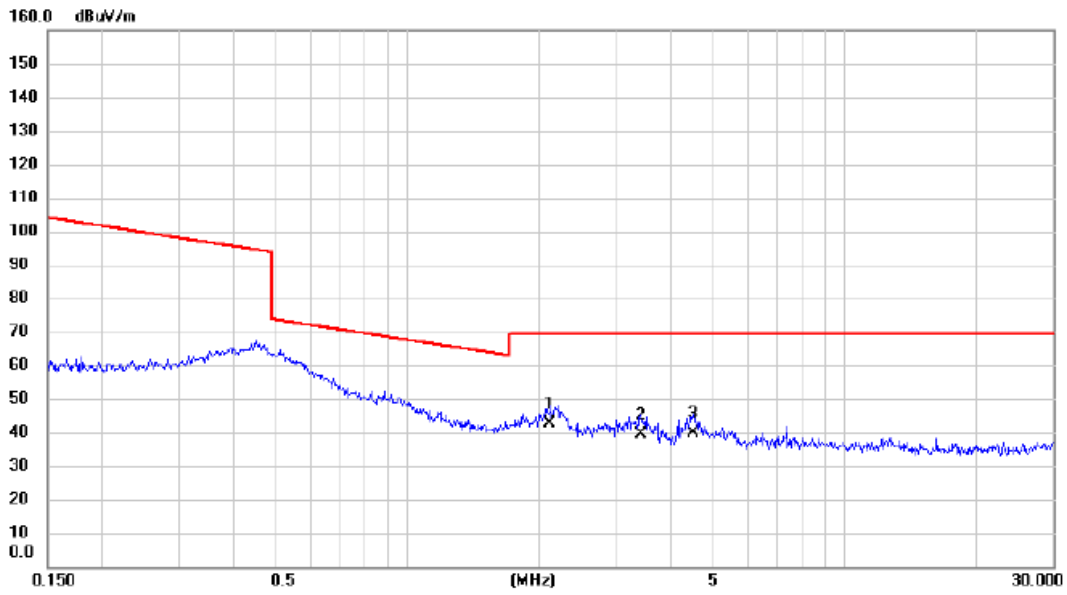

No.	Mk.	Freq.	Reading Level	Correct Factor	Measurement	Limit	Margin	Antenna Height	Table Degree	
		MHz	dBuV	dB	dBuV/m	dBuV/m	dB	cm	degree	Comment
1	*	2.1213	30.54	12.20	42.74	69.54	-26.80			QP
2		3.4174	27.33	11.99	39.32	69.54	-30.22			QP
3		4.5015	27.56	12.07	39.63	69.54	-29.91			QP

**REMARKS:**

- (1) Measurement Value = Reading Level + Correct Factor.
- (2) Margin Level = Measurement Value - Limit Value.

Test Mode	TX Mode_13.56MHz	Polarization	Ant 0°
-----------	------------------	--------------	--------



No.	Mk.	Freq. MHz	Reading Level dBuV	Correct Factor dB	Measure- ment dBuV/m	Limit dBuV/m	Margin dB	Detector	Comment
1	*	0.4967	58.21	12.02	70.23	73.88	-3.65	peak	
2		3.1900	50.30	10.83	61.13	69.50	-8.37	peak	
3		13.6228	51.09	11.57	62.66	90.50	-27.84	peak	

**REMARKS:**

- (1) Measurement Value = Reading Level + Correct Factor.
- (2) Margin Level = Measurement Value - Limit Value.

Test Mode	TX Mode_ 13.56MHz	Polarization	Ant 90°
-----------	-------------------	--------------	---------

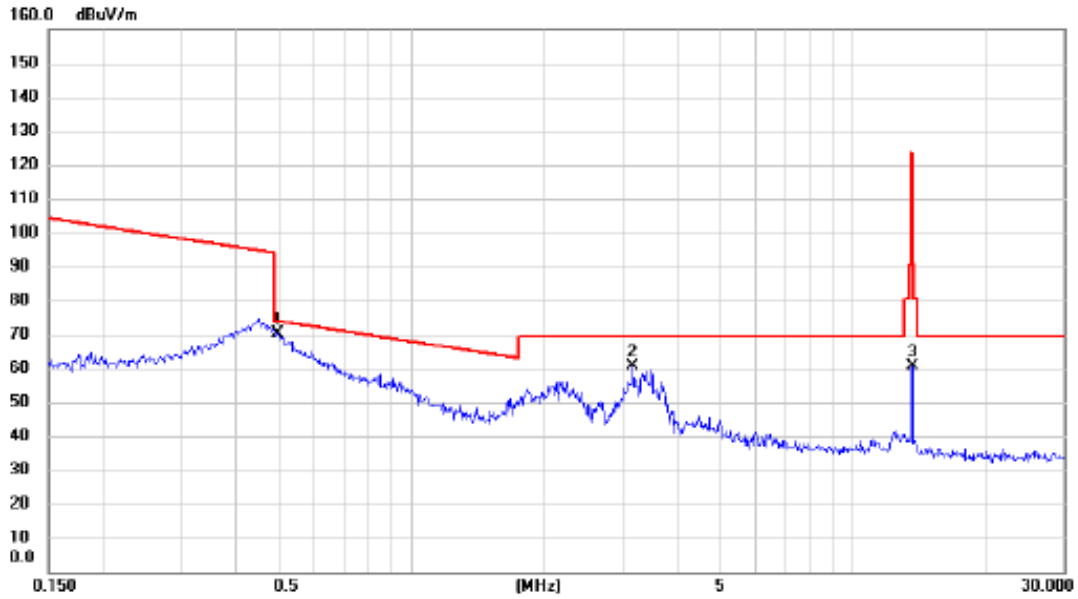

No.	Mk.	Freq. MHz	Reading Level dBuV	Correct Factor dB	Measure- ment dBuV/m	Limit dBuV/m	Margin dB	Detector	Comment
1	*	0.4967	58.05	12.02	70.07	73.88	-3.81	peak	
2		3.1731	49.81	10.83	60.64	69.50	-8.86	peak	
3		13.6228	48.88	11.57	60.45	90.50	-30.05	peak	

REMARKS:

- (1) Measurement Value = Reading Level + Correct Factor.
- (2) Margin Level = Measurement Value - Limit Value.

**APPENDIX C - RADIATED EMISSION - 30 MHZ TO 1000 MHZ**



Test Mode TX Mode\_13.56MHz

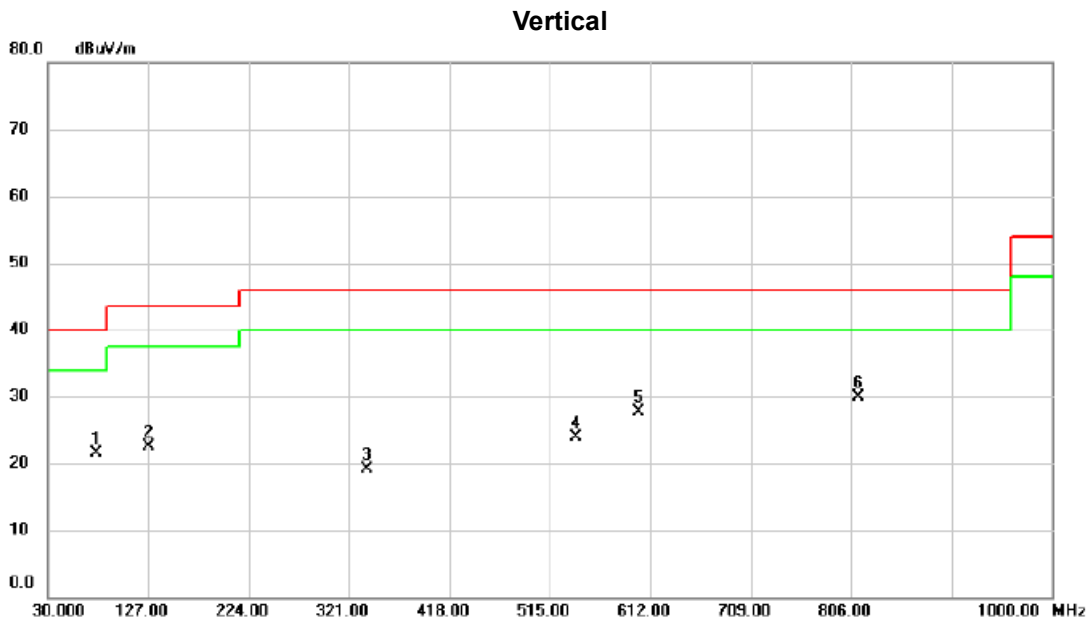

No.	Mk.	Freq. MHz	Reading Level dBuV	Correct Factor dB	Measure- ment dBuV/m	Limit dBuV/m	Margin dB	Detector	Comment
1		77.5300	39.42	-17.86	21.56	40.00	-18.44	peak	
2		127.9700	36.04	-13.55	22.49	43.50	-21.01	peak	
3		338.4600	29.22	-10.18	19.04	46.00	-26.96	peak	
4		540.2200	29.97	-6.02	23.95	46.00	-22.05	peak	
5		600.3600	32.25	-4.55	27.70	46.00	-18.30	peak	
6	*	812.7900	30.52	-0.67	29.85	46.00	-16.15	peak	

REMARKS:

- (1) Measurement Value = Reading Level + Correct Factor.
- (2) Margin Level = Measurement Value - Limit Value.

Test Mode TX Mode\_13.56MHz

### Horizontal

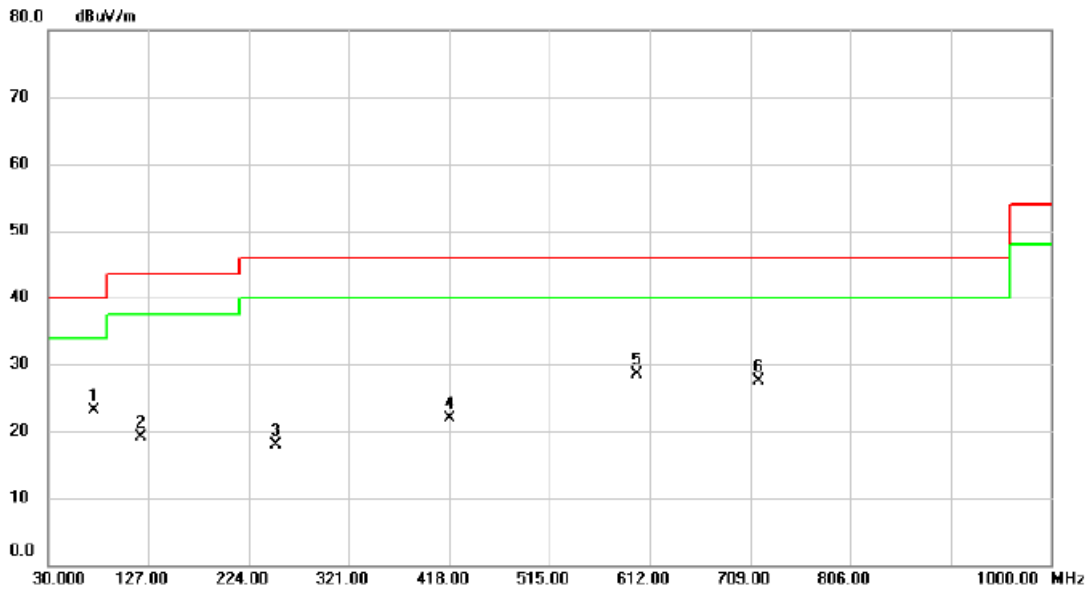

No.	Mk.	Freq. MHz	Reading Level dBuV	Correct Factor dB	Measure- ment dBuV/m	Limit dBuV/m	Margin dB	Detector	Comment
1	*	74.6200	40.41	-17.23	23.18	40.00	-16.82	peak	
2		120.2100	33.19	-14.15	19.04	43.50	-24.46	peak	
3		250.1900	30.82	-12.92	17.90	46.00	-28.10	peak	
4		418.0000	30.28	-8.29	21.99	46.00	-24.01	peak	
5		599.3900	33.00	-4.57	28.43	46.00	-17.57	peak	
6		716.7600	30.17	-2.69	27.48	46.00	-18.52	peak	

**REMARKS:**

(1) Measurement Value = Reading Level + Correct Factor.

(2) Margin Level = Measurement Value - Limit Value.

## APPENDIX D - FREQUENCY TOLERANCE

Test Mode	TX Mode_13.56MHz
-----------	------------------

**Frequency Tolerance Versus Environmental Temperature**

	Temperature (°C)	Voltage (V)	Frequency (MHz)	Frequency Error (kHz)	Limit (kHz)	Result
	24	120V	13.56	-	-	-
0 min	40	120V	13.5611	1.10	+/- 1.356	PASS
	0	120V	13.5608	0.80	+/- 1.356	PASS
2 min	40	120V	13.5591	-0.90	+/- 1.356	PASS
	0	120V	13.5595	-0.50	+/- 1.356	PASS
5 min	40	120V	13.5605	0.50	+/- 1.356	PASS
	0	120V	13.5589	-1.10	+/- 1.356	PASS
10 min	40	120V	13.5607	0.70	+/- 1.356	PASS
	0	120V	13.5597	-0.30	+/- 1.356	PASS

**Frequency Tolerance Versus Input Voltage**

Temperature (°C)	Voltage (V)		Frequency (MHz)	Frequency Error (kHz)	Limit (kHz)	Result
20	V-nom	120V	13.5612	1.20	-	-
20	V-min	108V	13.5597	-0.30	+/- 1.356	PASS
20	V-max	132V	13.5594	-0.60	+/- 1.356	PASS

**End of Test Report**