

# FCC Radio Test Report

## FCC ID: 2AUTE-FT800

This report concerns: Original Grant

**Project No.** : 2103C008  
**Equipment** : Wireless Home Printer  
**Brand Name** : HPRT, iDPRT  
**Test Model** : FT800  
**Series Model** : Future800  
**Applicant** : Xiamen Hanin Electronic Technology Co.,Ltd.  
**Address** : Room 305A, Angye Building, Pioneering Park,Torch High-tech, Zone,  
Xiamen  
**Manufacturer** : Xiamen Hanin Electronic Technology Co.,Ltd.  
**Address** : Room 305A, Angye Building, Pioneering Park,Torch High-tech, Zone,  
Xiamen  
**Factory** : Xiamen Hanin Electronic Technology Co.,Ltd.  
**Address** : 96# Rongyuan Road,Tong'an District,Xiamen  
**Date of Receipt** : Mar. 04, 2021  
**Date of Test** : Mar. 08, 2021 ~ Jun. 01, 2021  
**Issued Date** : Jun. 16, 2021  
**Report Version** : R00  
**Test Sample** : Engineering Sample No.: DG2021030837 for conducted,  
DG2021030838 for radiated.  
**Standard(s)** : FCC CFR Title 47, Part 15, Subpart C  
FCC KDB 558074 D01 15.247 Meas Guidance v05r02  
ANSI C63.10-2013

The above equipment has been tested and found compliance with the requirement of the relative standards by BTL Inc.

*Vincent Tan*

Prepared by : Vincent Tan

*Ethan Ma*

Approved by : Ethan Ma



Certificate #5123.02

Add: No.3, Jinshagang 1st Road, Shixia, Dalang Town,Dongguan, Guangdong, China.

Tel: +86-769-8318-3000

Web: www.newbtl.com

**Declaration**

**BTL** represents to the client that testing is done in accordance with standard procedures as applicable and that test instruments used has been calibrated with standards traceable to international standard(s) and/or national standard(s).

**BTL's** reports apply only to the specific samples tested under conditions. It is manufacture's responsibility to ensure that additional production units of this model are manufactured with the identical electrical and mechanical components. **BTL** shall have no liability for any declarations, inferences or generalizations drawn by the client or others from **BTL** issued reports.

The report must not be used by the client to claim product certification, approval, or endorsement by NVLAP, NIST, A2LA, or any agency of the U.S. Government.

This report is the confidential property of the client. As a mutual protection to the clients, the public and ourselves, the test report shall not be reproduced, except in full, without our written approval.

**BTL's** laboratory quality assurance procedures are in compliance with the **ISO/IEC 17025** requirements, and accredited by the conformity assessment authorities listed in this test report.

**BTL** is not responsible for the sampling stage, so the results only apply to the sample as received.

The information, data and test plan are provided by manufacturer which may affect the validity of results, so it is manufacturer's responsibility to ensure that the apparatus meets the essential requirements of applied standards and in all the possible configurations as representative of its intended use.

**Limitation**

For the use of the authority's logo is limited unless the Test Standard(s)/Scope(s)/Item(s) mentioned in this test report is (are) included in the conformity assessment authorities acceptance respective.

Please note that the measurement uncertainty is provided for informational purpose only and are not use in determining the Pass/Fail results.

<b>Table of Contents</b>	<b>Page</b>
<b>REPORT ISSUED HISTORY</b>	<b>6</b>
<b>1 . SUMMARY OF TEST RESULTS</b>	<b>7</b>
1.1 TEST FACILITY	8
1.2 MEASUREMENT UNCERTAINTY	8
1.3 TEST ENVIRONMENT CONDITIONS	8
<b>2 . GENERAL INFORMATION</b>	<b>9</b>
2.1 GENERAL DESCRIPTION OF EUT	9
2.2 DESCRIPTION OF TEST MODES	10
2.3 PARAMETERS OF TEST SOFTWARE	10
2.4 BLOCK DIAGRAM SHOWING THE CONFIGURATION OF SYSTEM TESTED	11
2.5 SUPPORT UNITS	11
<b>3 . AC POWER LINE CONDUCTED EMISSIONS</b>	<b>12</b>
3.1 LIMIT	12
3.2 TEST PROCEDURE	12
3.3 DEVIATION FROM TEST STANDARD	12
3.4 TEST SETUP	13
3.5 EUT OPERATING CONDITIONS	13
3.6 TEST RESULTS	13
<b>4 . RADIATED EMISSIONS</b>	<b>14</b>
4.1 LIMIT	14
4.2 TEST PROCEDURE	15
4.3 DEVIATION FROM TEST STANDARD	16
4.4 TEST SETUP	16
4.5 EUT OPERATING CONDITIONS	17
4.6 TEST RESULT - 9 KHZ TO 30 MHZ	17
4.7 TEST RESULT - 30 MHZ TO 1000 MHZ	17
4.8 TEST RESULT - ABOVE 1000 MHZ	17
<b>5 . BANDWIDTH</b>	<b>18</b>
5.1 LIMIT	18
5.2 TEST PROCEDURE	18
5.3 DEVIATION FROM STANDARD	18
5.4 TEST SETUP	18

<b>Table of Contents</b>	<b>Page</b>
5.5 EUT OPERATION CONDITIONS	18
5.6 TEST RESULTS	18
<b>6 . MAXIMUM OUTPUT POWER</b>	<b>19</b>
6.1 LIMIT	19
6.2 TEST PROCEDURE	19
6.3 DEVIATION FROM STANDARD	19
6.4 TEST SETUP	19
6.5 EUT OPERATION CONDITIONS	19
6.6 TEST RESULTS	19
<b>7 . CONDUCTED SPURIOUS EMISSION</b>	<b>20</b>
7.1 LIMIT	20
7.2 TEST PROCEDURE	20
7.3 DEVIATION FROM STANDARD	20
7.4 TEST SETUP	20
7.5 EUT OPERATION CONDITIONS	20
7.6 TEST RESULTS	20
<b>8 . POWER SPECTRAL DENSITY</b>	<b>21</b>
8.1 LIMIT	21
8.2 TEST PROCEDURE	21
8.3 DEVIATION FROM STANDARD	21
8.4 TEST SETUP	21
8.5 EUT OPERATION CONDITIONS	21
8.6 TEST RESULTS	21
<b>9 . MEASUREMENT INSTRUMENTS LIST</b>	<b>22</b>
<b>10 . EUT TEST PHOTO</b>	<b>24</b>
<b>APPENDIX A - AC POWER LINE CONDUCTED EMISSIONS</b>	<b>28</b>
<b>APPENDIX B - RADIATED EMISSION - 9 KHZ TO 30 MHZ</b>	<b>31</b>
<b>APPENDIX C - RADIATED EMISSION - 30 MHZ TO 1000 MHZ</b>	<b>36</b>
<b>APPENDIX D - RADIATED EMISSION - ABOVE 1000 MHZ</b>	<b>39</b>
<b>APPENDIX E - BANDWIDTH</b>	<b>52</b>
<b>APPENDIX F - MAXIMUM OUTPUT POWER</b>	<b>54</b>

**Table of Contents****Page****APPENDIX G - CONDUCTED SPURIOUS EMISSION****56****APPENDIX H - POWER SPECTRAL DENSITY****58**

**REPORT ISSUED HISTORY**

Report Version	Description	Issued Date
R00	Original Issue.	Jun. 16, 2021

## 1. SUMMARY OF TEST RESULTS

Test procedures according to the technical standard(s):

FCC CFR Title 47, Part 15, Subpart C				
Standard(s) Section	Test Item	Test Result	Judgment	Remark
15.207	AC Power Line Conducted Emissions	APPENDIX A	PASS	-----
15.247(d) 15.205(a) 15.209(a)	Radiated Emissions	APPENDIX B APPENDIX C APPENDIX D	PASS	-----
15.247(a)(2)	Bandwidth	APPENDIX E	PASS	-----
15.247(b)(3)	Maximum Output Power	APPENDIX F	PASS	-----
15.247(d)	Conducted Spurious Emission	APPENDIX G	PASS	-----
15.247(e)	Power Spectral Density	APPENDIX H	PASS	-----
15.203	Antenna Requirement	-----	PASS	Note(2)

Note:

- (1) "N/A" denotes test is not applicable to this device.
- (2) The device what use a permanently attached antenna were considered sufficient to comply with the provisions of 15.203.

### 1.1 TEST FACILITY

The test facilities used to collect the test data in this report is at the location of No.3, Jinshagang 1st Road, Shixia, Dalang Town, Dongguan, Guangdong, China  
 BTL's Test Firm Registration Number for FCC: 357015  
 BTL's Designation Number for FCC: CN1240

### 1.2 MEASUREMENT UNCERTAINTY

ISO/IEC 17025 requires that an estimate of the measurement uncertainties associated with the emissions test results be included in the report. The measurement uncertainties given below are based on a 95% confidence level (based on a coverage factor (k=2))

The BTL measurement uncertainty as below table:

#### A. AC power line conducted emissions Measurement:

Test Site	Method	Measurement Frequency Range	U, (dB)
DG-C02	CISPR	150kHz ~ 30MHz	2.68

#### B. Radiated emissions Measurement:

Test Site	Method	Measurement Frequency Range	Ant. H / V	U, (dB)
DG-CB03	CISPR	9kHz ~ 30MHz	-	3.02
		30MHz ~ 200MHz	V	4.26
		30MHz ~ 200MHz	H	3.38
		200MHz ~ 1,000MHz	V	3.98
		200MHz ~ 1,000MHz	H	3.94
		1GHz ~ 6GHz	-	3.96
		6GHz ~ 18GHz	-	5.24
		18GHz ~ 26.5GHz	-	3.62
		26.5GHz ~ 40GHz	-	4.00

#### C. Other Measurement:

Test Item	Uncertainty
Bandwidth	±3.8 %
Maximum Output Power	±0.95 dB
Conducted Spurious Emission	±2.71 dB
Power Spectral Density	±0.86 dB
Temperature	±0.08 °C
Humidity	±1.5%

Note: Unless specifically mentioned, the uncertainty of measurement has not been taken into account to declare the compliance or non-compliance to the specification.

### 1.3 TEST ENVIRONMENT CONDITIONS

Test Item	Temperature	Humidity	Test Voltage	Tested By
AC Power Line Conducted Emissions	25°C	53%	AC 120V/60Hz	Hand Huang
Radiated Emissions-9 kHz to 30 MHz	25°C	60%	AC 120V/60Hz	Hayden Chen
Radiated Emissions-30 MHz to 1000 MHz	26°C	52%	AC 120V/60Hz	Hayden Chen
Radiated Emissions-Above 1000 MHz	26°C	52%	AC 120V/60Hz	Hayden Chen
Bandwidth	24°C	52%	AC 120V/60Hz	Kwok Guo
Maximum Output Power	24°C	52%	AC 120V/60Hz	Hand Huang
Conducted Spurious Emission	24°C	52%	AC 120V/60Hz	Kwok Guo
Power Spectral Density	24°C	52%	AC 120V/60Hz	Kwok Guo



## 2. GENERAL INFORMATION

### 2.1 GENERAL DESCRIPTION OF EUT

Equipment	Wireless Home Printer
Brand Name	HPRT, iDPRT
Test Model	FT800
Series Model	Future800
Model Difference(s)	Only differ in model name, the internal circuit, panel, enclosure and power board are all the same.
Power Source	DC voltage supplied from AC adapter. Model: AP091G-140300
Power Rating	I/P: 100-240V~ 50/60Hz 1.5A Max. O/P: 14.0V $\equiv$ 3.0A
Operation Frequency	2402 MHz ~ 2480 MHz
Modulation Type	GFSK
Bit Rate of Transmitter	1Mbps
Max. Output Power	-0.45 dBm (0.0009 W)

Note:

- For a more detailed features description, please refer to the manufacturer's specifications or the user's manual.

#### 2. Channel List:

Channel	Frequency (MHz)	Channel	Frequency (MHz)
00	2402	20	2442
01	2404	21	2444
02	2406	22	2446
03	2408	23	2448
04	2410	24	2450
05	2412	25	2452
06	2414	26	2454
07	2416	27	2456
08	2418	28	2458
09	2420	29	2460
10	2422	30	2462
11	2424	31	2464
12	2426	32	2466
13	2428	33	2468
14	2430	34	2470
15	2432	35	2472
16	2434	36	2474
17	2436	37	2476
18	2438	38	2478
19	2440	39	2480

#### 3. Table for Filed Antenna:

Ant.	Brand	Model Name	Antenna Type	Connector	Gain (dBi)
1	N/A	N/A	Printed	N/A	3.0

Note: The antenna gain is provided by the manufacturer.

## 2.2 DESCRIPTION OF TEST MODES

The test system was pre-tested based on the consideration of all possible combinations of EUT operation mode.

Pretest Mode	Description
Mode 1	TX Mode_1Mbps Channel 00/19/39
Mode 2	TX Mode_1Mbps Channel 19

Following mode(s) was (were) found to be the worst case(s) and selected for the final test.

<b>AC power line conducted emissions test</b>	
Final Test Mode	Description
Mode 2	TX Mode_1Mbps Channel 19

<b>Radiated emissions test - Below 1GHz</b>	
Final Test Mode	Description
Mode 2	TX Mode_1Mbps Channel 19

<b>Radiated emissions test - Above 1GHz</b>	
Final Test Mode	Description
Mode 1	TX Mode_1Mbps Channel 00/19/39

<b>Conducted test</b>	
Final Test Mode	Description
Mode 1	TX Mode_1Mbps Channel 00/19/39

Note:

- (1) For radiated emission above 1 GHz test, the spurious points of 1GHz~26.5GHz have been pre-tested and in this report only recorded the worst case. The remaining spurious points are all below the limit value of 20dB.
- (2) For AC power line conducted emissions and radiated emissions below 1 GHz test, the 1Mbps Channel 19 is found to be the worst case and recorded.

## 2.3 PARAMETERS OF TEST SOFTWARE

During testing channel & power controlling software provided by the customer was used to control the operating channel as well as the output power level.

Test Software Version	BK3435		
Frequency (MHz)	2402	2440	2480
1Mbps	N/A	N/A	N/A

**2.4 BLOCK DIAGRAM SHOWING THE CONFIGURATION OF SYSTEM TESTED**

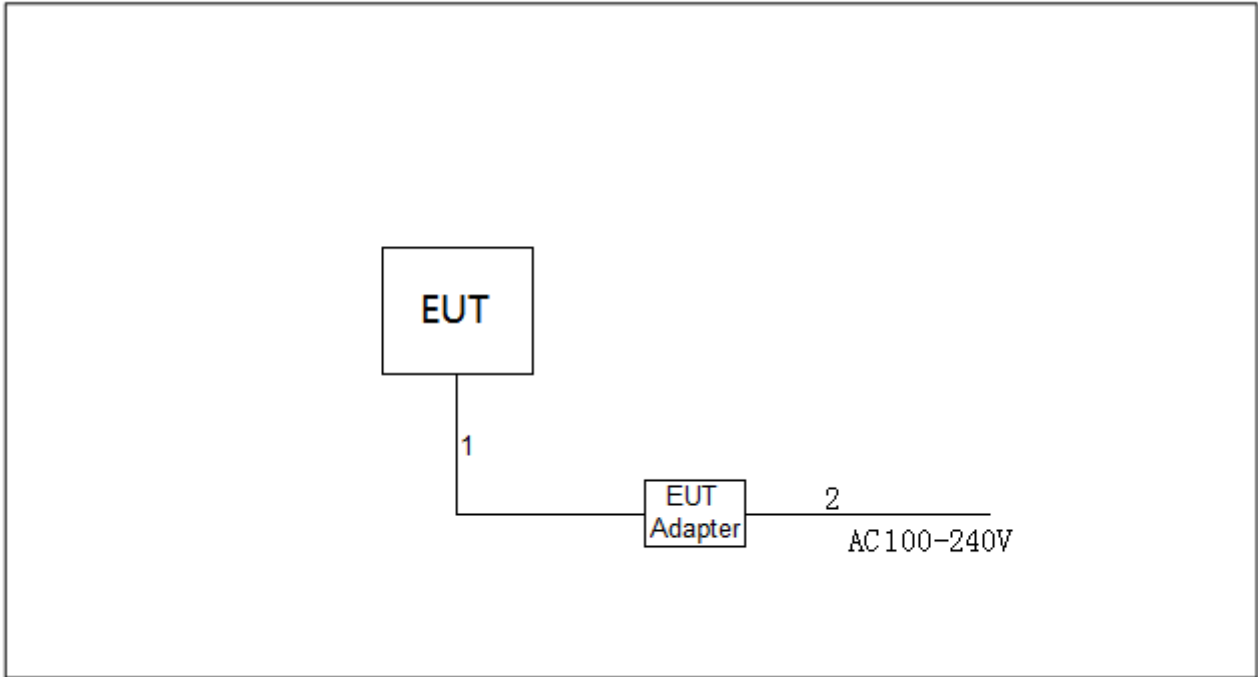

**2.5 SUPPORT UNITS**

Item	Equipment	Brand	Model No.	Series No.
-	-	-	-	-

Item	Cable Type	Shielded Type	Ferrite Core	Length
1	DC Cable	NO	NO	1.2m
2	AC Cable	NO	NO	1.5m

### 3. AC POWER LINE CONDUCTED EMISSIONS

#### 3.1 LIMIT

Frequency of Emission (MHz)	Limit (dB $\mu$ V)	
	Quasi-peak	Average
0.15 - 0.5	66 to 56*	56 to 46*
0.5 - 5.0	56	46
5.0 - 30.0	60	50

Note:

- (1) The tighter limit applies at the band edges.
- (2) The limit of " \* " marked band means the limitation decreases linearly with the logarithm of the frequency in the range.

#### 3.2 TEST PROCEDURE

- a. The EUT was placed 0.8 meters from the horizontal ground plane with EUT being connected to the power mains through a line impedance stabilization network (LISN). All other support equipment powered from additional LISN(s). The LISN provide 50 Ohm/ 50uH of coupling impedance for the measuring instrument.
- b. Interconnecting cables that hang closer than 40 cm to the ground plane shall be folded back and forth in the center forming a bundle 30 to 40 cm long.
- c. I/O cables that are not connected to a peripheral shall be bundled in the center. The end of the cable may be terminated, if required, using the correct terminating impedance. The overall length shall not exceed 1 m.
- d. LISN at least 80 cm from nearest part of EUT chassis.
- e. For the actual test configuration, please refer to the related Item –EUT Test Photos.

The following table is the setting of the receiver:

Receiver Parameters	Setting
Start Frequency	0.15 MHz
Stop Frequency	30 MHz
IF Bandwidth	9 kHz

#### 3.3 DEVIATION FROM TEST STANDARD

No deviation.

### 3.4 TEST SETUP

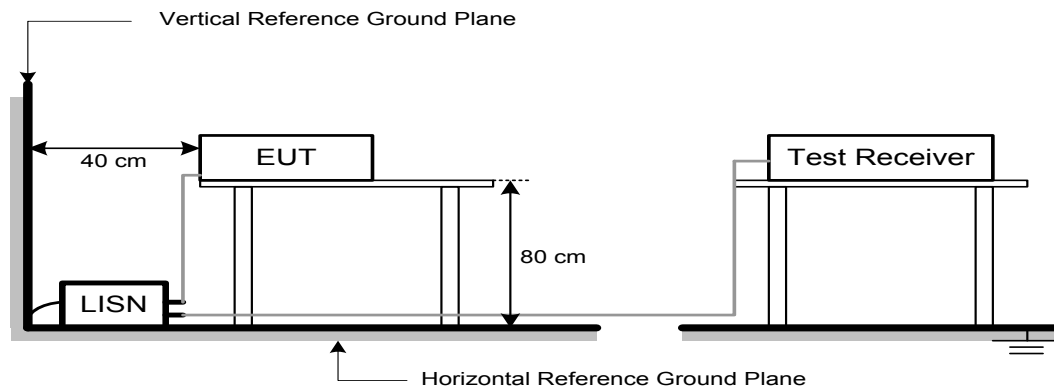

### 3.5 EUT OPERATING CONDITIONS

The EUT was configured for testing in a typical fashion (as a customer would normally use it). The EUT has been programmed to continuously transmit during test. This operating condition was tested and used to collect the included data.

### 3.6 TEST RESULTS

Please refer to the APPENDIX A.

Remark:

- (1) All readings are QP Mode value unless otherwise stated AVG in column of 『Note』 . If the QP Mode Measured value compliance with the QP Limits and lower than AVG Limits, the EUT shall be deemed to meet both QP & AVG Limits and then only QP Mode was measured, but AVG Mode didn't perform. In this case, a “ \* ” marked in AVG Mode column of Interference Voltage Measured.
- (2) Measuring frequency range from 150 kHz to 30 MHz.

## 4. RADIATED EMISSIONS

### 4.1 LIMIT

In case the emission fall within the restricted band specified on 15.205(a), then the 15.209(a) limit in the table below has to be followed.

#### LIMITS OF RADIATED EMISSION MEASUREMENT (9 kHz-1000 MHz)

Frequency (MHz)	Field Strength (microvolts/meter)	Measurement Distance (meters)
0.009-0.490	2400/F(kHz)	300
0.490-1.705	24000/F(kHz)	30
1.705-30.0	30	30
30-88	100	3
88-216	150	3
216-960	200	3
Above 960	500	3

#### LIMITS OF RADIATED EMISSION MEASUREMENT (Above 1000 MHz)

Frequency (MHz)	(dBuV/m at 3 m)	
	Peak	Average
Above 1000	74	54

Note:

- (1) The limit for radiated test was performed according to FCC CFR Title 47, Part 15, Subpart C.
- (2) The tighter limit applies at the band edges.
- (3) Emission level (dBuV/m)=20log Emission level (uV/m).

#### 4.2 TEST PROCEDURE

- a. The measuring distance of 3 m shall be used for measurements. The EUT was placed on the top of a rotating table 0.8 meter above the ground at a 3 meter semi-anechoic chamber. The table was rotated 360 degrees to determine the position of the highest radiation.(below 1 GHz)
- b. The measuring distance of 3 m shall be used for measurements. The EUT was placed on the top of a rotating table 1.5 meter above the ground at a 3 meter semi-anechoic chamber. The table was rotated 360 degrees to determine the position of the highest radiation.(above 1 GHz)
- c. The height of the equipment or of the substitution antenna shall be 0.8m or 1.5m; the height of the test antenna shall vary between 1 m to 4 m. Both horizontal and vertical polarizations of the antenna are set to make the measurement.
- d. For each suspected emission, the EUT was arranged to its worst case and then the antenna was tuned to heights find the maximum reading (used Bore sight function).
- e. The receiver system was set to peak and average detect function and specified bandwidth with maximum hold mode when the test frequency is above 1 GHz.
- f. The initial step in collecting radiated emission data is a receiver peak detector mode pre-scanning the measurement frequency range. Significant peaks are then marked and then Quasi Peak detector mode re-measured.
- g. All readings are Peak unless otherwise stated QP in column of Note. Peak denotes that the Peak reading compliance with the QP Limits and then QP Mode measurement didn't perform. (below 1 GHz)
- h. All readings are Peak Mode value unless otherwise stated AVG in column of Note. If the Peak Mode Measured value compliance with the Peak Limits and lower than AVG Limits, the EUT shall be deemed to meet both Peak & AVG Limits and then only Peak Mode was measured, but AVG Mode didn't perform. (above 1 GHz)
- i. For the actual test configuration, please refer to the related Item –EUT Test Photos.

The following table is the setting of the receiver:

Spectrum Parameters	Setting
Start ~ Stop Frequency	9 kHz~150 kHz for RBW 200 Hz
Start ~ Stop Frequency	0.15 MHz~30 MHz for RBW 9 kHz
Start ~ Stop Frequency	30 MHz~1000 MHz for RBW 100 kHz

Spectrum Parameters	Setting
Start Frequency	1000 MHz
Stop Frequency	10th carrier harmonic
RBW / VBW (Emission in restricted band)	1 MHz / 3 MHz for PK value 1 MHz / 1/T Hz for AVG value

Spectrum Parameters	Setting
Start ~ Stop Frequency	9 kHz~90 kHz for PK/AVG detector
Start ~ Stop Frequency	90 kHz~110 kHz for QP detector
Start ~ Stop Frequency	110 kHz~490 kHz for PK/AVG detector
Start ~ Stop Frequency	490 kHz~30 MHz for QP detector
Start ~ Stop Frequency	30 MHz~1000 MHz for QP detector
Start ~ Stop Frequency	1 GHz~26.5 GHz for PK/AVG detector

**4.3 DEVIATION FROM TEST STANDARD**

No deviation.

**4.4 TEST SETUP**

9 kHz to 30 MHz

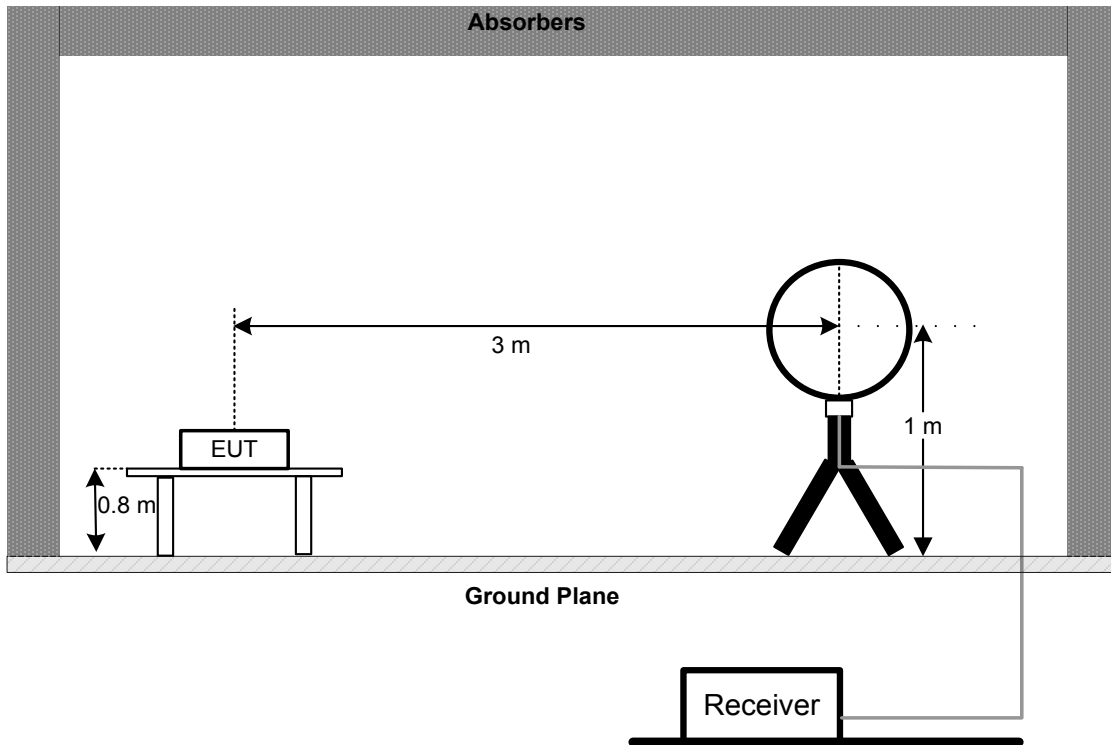

30 MHz to 1 GHz

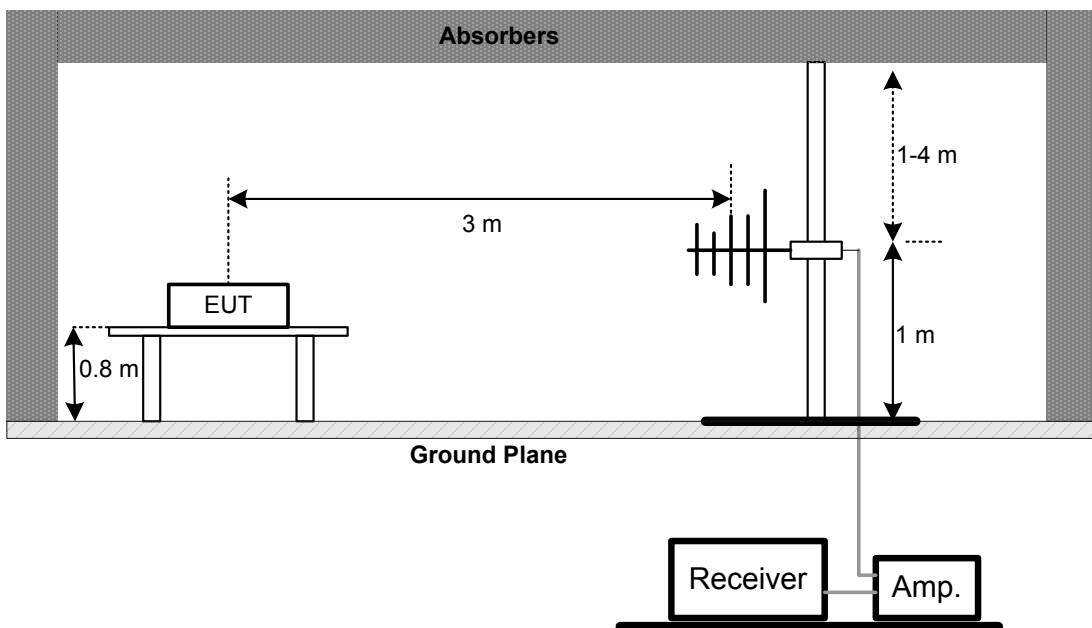



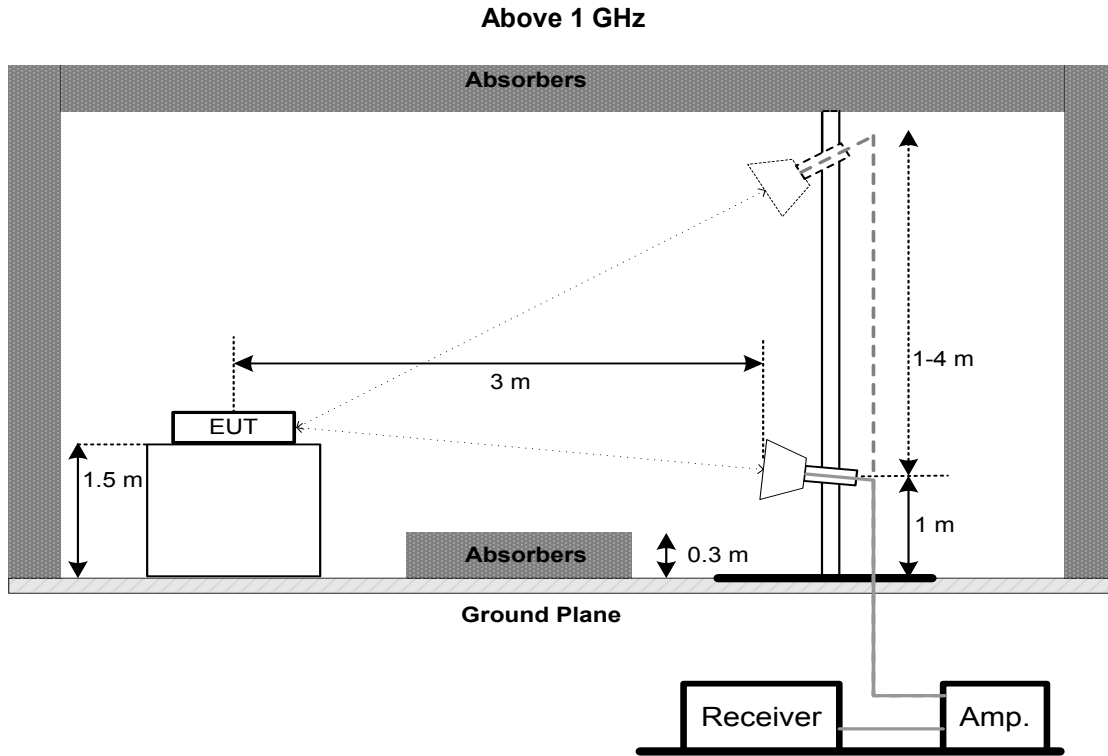

#### 4.5 EUT OPERATING CONDITIONS

The EUT was programmed to be in continuously transmitting mode.

#### 4.6 TEST RESULT - 9 kHz TO 30 MHz

Please refer to the APPENDIX B.

Remark:

- (1) Distance extrapolation factor =  $40 \log(\text{specific distance} / \text{test distance})$  (dB).
- (2) Limit line = specific limits (dBuV) + distance extrapolation factor.

#### 4.7 TEST RESULT - 30 MHz TO 1000 MHz

Please refer to the APPENDIX C.

#### 4.8 TEST RESULT - ABOVE 1000 MHz

Please refer to the APPENDIX D.

Remark:

- (1) No limit: This is fundamental signal, the judgment is not applicable.  
For fundamental signal judgment was referred to Peak output test.

## 5. BANDWIDTH

### 5.1 LIMIT

Section	Test Item	Limit
FCC 15.247(a)(2)	6 dB Bandwidth	$\geq 500$ kHz
	99% Emission Bandwidth	-

### 5.2 TEST PROCEDURE

- The EUT was directly connected to the spectrum analyzer and antenna output port as show in the block diagram below.
- The following table is the setting of the spectrum analyzer:

For 6 dB Bandwidth:

Spectrum Parameters	Setting
Span Frequency	> Measurement Bandwidth
RBW	100 kHz
VBW	300 kHz
Detector	Peak
Trace	Max Hold
Sweep Time	Auto

For 99% Emission Bandwidth:

Spectrum Parameters	Setting
Span Frequency	Between 1.5 times and 5.0 times the OBW
RBW	30 kHz
VBW	100 kHz
Detector	Peak
Trace	Max Hold
Sweep Time	Auto

### 5.3 DEVIATION FROM STANDARD

No deviation.

### 5.4 TEST SETUP

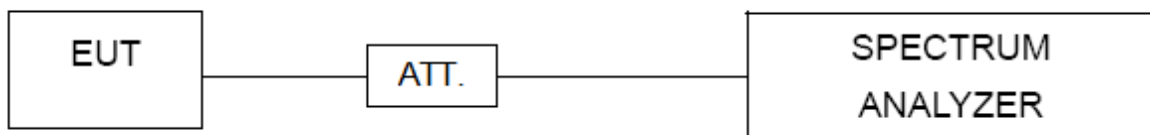

### 5.5 EUT OPERATION CONDITIONS

The EUT was programmed to be in continuously transmitting mode.

### 5.6 TEST RESULTS

Please refer to the APPENDIX E.

**6. MAXIMUM OUTPUT POWER**

**6.1 LIMIT**

Section	Test Item	Limit
FCC 15.247(b)(3)	Maximum Output Power	1.0000 watt or 30.00 dBm

**6.2 TEST PROCEDURE**

- a. The EUT was directly connected to the spectrum analyzer and antenna output port as show in the block diagram below.
- b. The following table is the setting of the spectrum analyzer:

Spectrum Parameters	Setting
Span Frequency	$\geq 3 \times \text{RBW}$
RBW	3 MHz
VBW	3 MHz
Detector	Peak
Trace	Max Hold
Sweep Time	Auto

**6.3 DEVIATION FROM STANDARD**

No deviation.

**6.4 TEST SETUP**

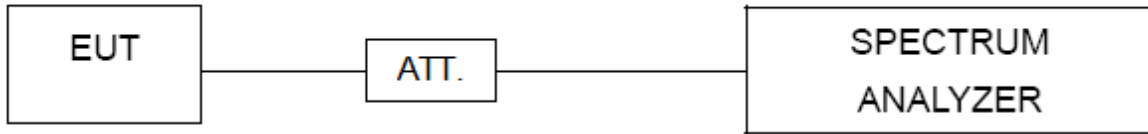

**6.5 EUT OPERATION CONDITIONS**

The EUT was programmed to be in continuously transmitting mode.

**6.6 TEST RESULTS**

Please refer to the APPENDIX F.

## 7. CONDUCTED SPURIOUS EMISSION

### 7.1 LIMIT

In any 100 kHz bandwidth outside the frequency band in which the spread spectrum or digitally modulated intentional radiator is operating, the radio frequency power that is produced by the intentional radiator shall be at least 20 dB below that in the 100 kHz bandwidth within the band that contains the highest level of the desired power, based on either an RF conducted or a radiated measurement, provided the transmitter demonstrates compliance with the peak Output Power limits. If the transmitter complies with the Output Power limits based on the use of RMS averaging over a time interval, as permitted under paragraph (b)(3) of this section, the attenuation required under this paragraph shall be 30 dB instead of 20 dB. Attenuation below the general limits specified in Section 15.209(a) is not required.

### 7.2 TEST PROCEDURE

- a. The EUT was directly connected to the spectrum analyzer and antenna output port as show in the block diagram below.
- b. The following table is the setting of the spectrum analyzer:

Spectrum Parameters	Setting
Start Frequency	30 MHz
Stop Frequency	26.5 GHz
RBW	100 kHz
VBW	300 kHz
Detector	Peak
Trace	Max Hold
Sweep Time	Auto

### 7.3 DEVIATION FROM STANDARD

No deviation.

### 7.4 TEST SETUP



### 7.5 EUT OPERATION CONDITIONS

The EUT was programmed to be in continuously transmitting mode.

### 7.6 TEST RESULTS

Please refer to the APPENDIX G.

## 8. POWER SPECTRAL DENSITY

### 8.1 LIMIT

Section	Test Item	Limit
FCC 15.247(e)	Power Spectral Density	8 dBm (in any 3 kHz)

### 8.2 TEST PROCEDURE

- a. The EUT was directly connected to the spectrum analyzer and antenna output port as show in the block diagram below.
- b. The following table is the setting of the spectrum analyzer:

Spectrum Parameters	Setting
Span Frequency	2 MHz (1 Mbps)
RBW	3 kHz
VBW	10 kHz
Detector	Peak
Trace	Max Hold
Sweep Time	Auto

### 8.3 DEVIATION FROM STANDARD

No deviation.

### 8.4 TEST SETUP

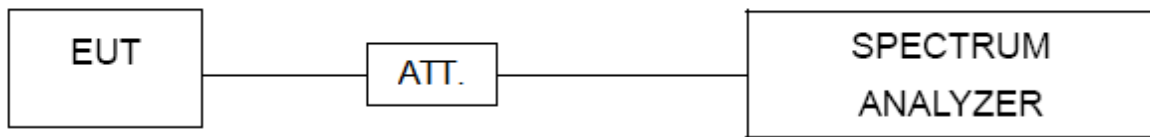

### 8.5 EUT OPERATION CONDITIONS

The EUT was programmed to be in continuously transmitting mode.

### 8.6 TEST RESULTS

Please refer to the APPENDIX H.

**9. MEASUREMENT INSTRUMENTS LIST**

AC Power Line Conducted Emissions					
Item	Kind of Equipment	Manufacturer	Type No.	Serial No.	Calibrated until
1	EMI Test Receiver	R&S	ESCI	100382	Feb. 28, 2022
2	LISN	EMCO	3816/2	52765	Feb. 27, 2022
3	TWO-LINE V-NETWORK	R&S	ENV216	101447	Feb. 27, 2022
4	50Ω Terminator	SHX	TF5-3	15041305	Feb. 27, 2022
5	Measurement Software	Farad	EZ-EMC Ver.NB-03A1-01	N/A	N/A
6	Cable	N/A	RG223	12m	Mar. 09, 2022
7	643 Shield Room	ETS	6*4*3m	N/A	N/A

Radiated Emissions - 9 kHz to 30 MHz					
Item	Kind of Equipment	Manufacturer	Type No.	Serial No.	Calibrated until
1	Loop Antenna	EM	EM-6876-1	230	Apr. 28, 2022
2	Cable	N/A	RG 213/U	N/A	May 29, 2022
3	EMI Test Receiver	R&S	ESCI	100895	Feb. 27, 2022
4	Measurement Software	Farad	EZ-EMC Ver.NB-03A1-01	N/A	N/A
5	966 Chambe Room	RM	9*6*6m	N/A	Jul. 25, 2021

Radiated Emissions - 30 MHz to 1 GHz					
Item	Kind of Equipment	Manufacturer	Type No.	Serial No.	Calibrated until
1	Antenna	Schwarzbeck	VULB9160	9160-3232	Mar. 15, 2022
2	Amplifier	HP	8447D	2944A08742	Feb. 28, 2022
3	Receiver	Agilent	N9038A	MY52130039	Jul. 25, 2021
4	Cable	emci	LMR-400(30MHz-1 GHz)(8m+5m)	N/A	May 22, 2022
5	Controller	CT	SC100	N/A	N/A
6	Controller	MF	MF-7802	MF780208416	N/A
7	Measurement Software	Farad	EZ-EMC Ver.NB-03A1-01	N/A	N/A
8	966 Chambe Room	RM	9*6*6m	N/A	Jul. 25, 2021

Radiated Emissions - Above 1 GHz					
Item	Kind of Equipment	Manufacturer	Type No.	Serial No.	Calibrated until
1	Double Ridged Guide Antenna	ETS	3115	75846	Mar. 17, 2022
2	Broad-Band Horn Antenna	Schwarzbeck	BBHA 9170	9170319	Jul. 07, 2021
3	Amplifier	Agilent	8449B	3008A02584	Jul. 25, 2021
4	Microwave Preamplifier With Adaptor	EMC INSTRUMENT	EMC2654045	980039 & HA01	Feb. 28, 2022
5	Receiver	Agilent	N9038A	MY52130039	Jul. 25, 2021
6	Controller	CT	SC100	N/A	N/A
7	Controller	MF	MF-7802	MF780208416	N/A
8	Cable	N/A	EMC104-SM-SM-6000	N/A	Oct. 16, 2021
9	Measurement Software	Farad	EZ-EMC Ver.NB-03A1-01	N/A	N/A
10	Filter	STI	STI15-9912	N/A	Jul. 25, 2021
11	966 Chambe Room	RM	9*6*6m	N/A	Jul. 25, 2021

**Bandwidth &  
Maximum Output Power &  
Power Spectral Density &  
Conducted Spurious Emission**

Item	Kind of Equipment	Manufacturer	Type No.	Serial No.	Calibrated until
1	Spectrum Analyzer	R&S	FSP40	100185	Jul. 25, 2021
2	Attenuator	WOKEN	6SM3502	VAS1214NL	Feb. 07, 2022
3	RF Cable	Tongkaichuan	N/A	N/A	N/A
4	DC Block	Mini	N/A	N/A	N/A

Remark: "N/A" denotes no model name, serial no. or calibration specified.  
All calibration period of equipment list is one year.

**10. EUT TEST PHOTO****AC Power Line Conducted Emissions Test Photos**



**Radiated Emissions Test Photos****9 kHz to 30 MHz**

**Radiated Emissions Test Photos**

**30 MHz to 1000 MHz**

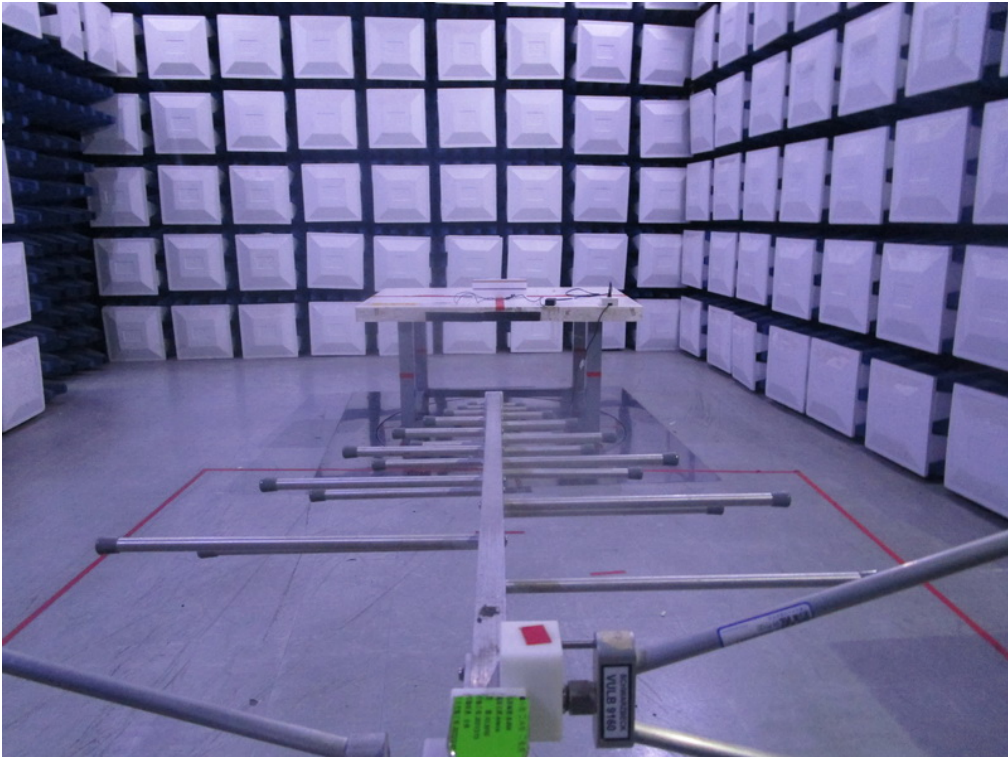
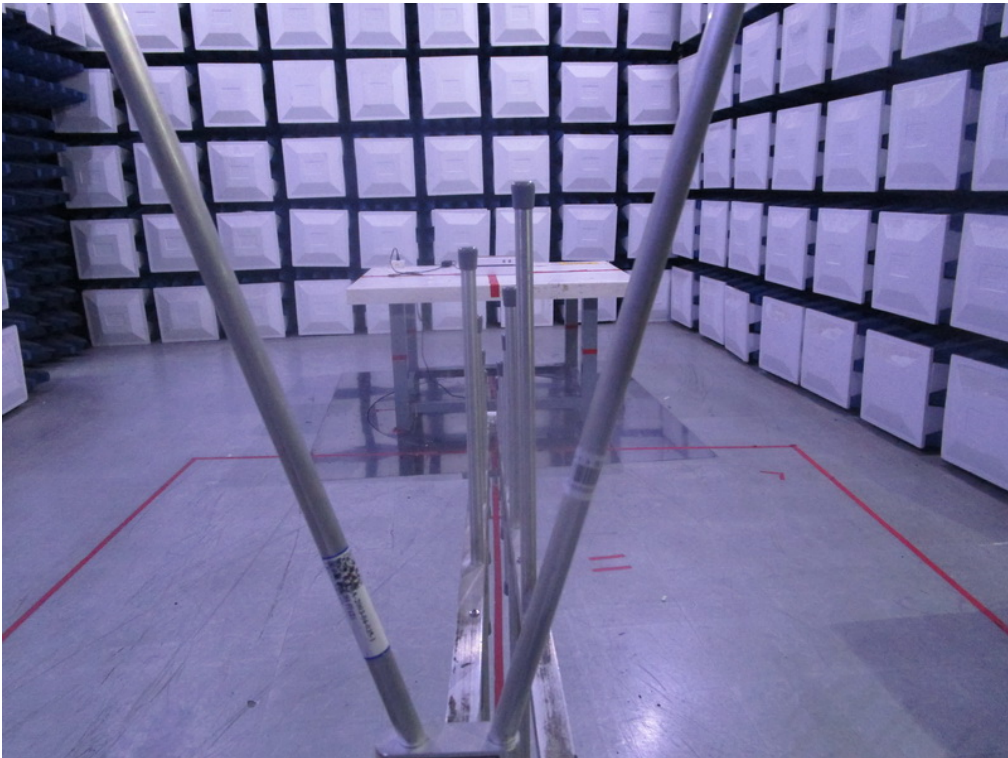

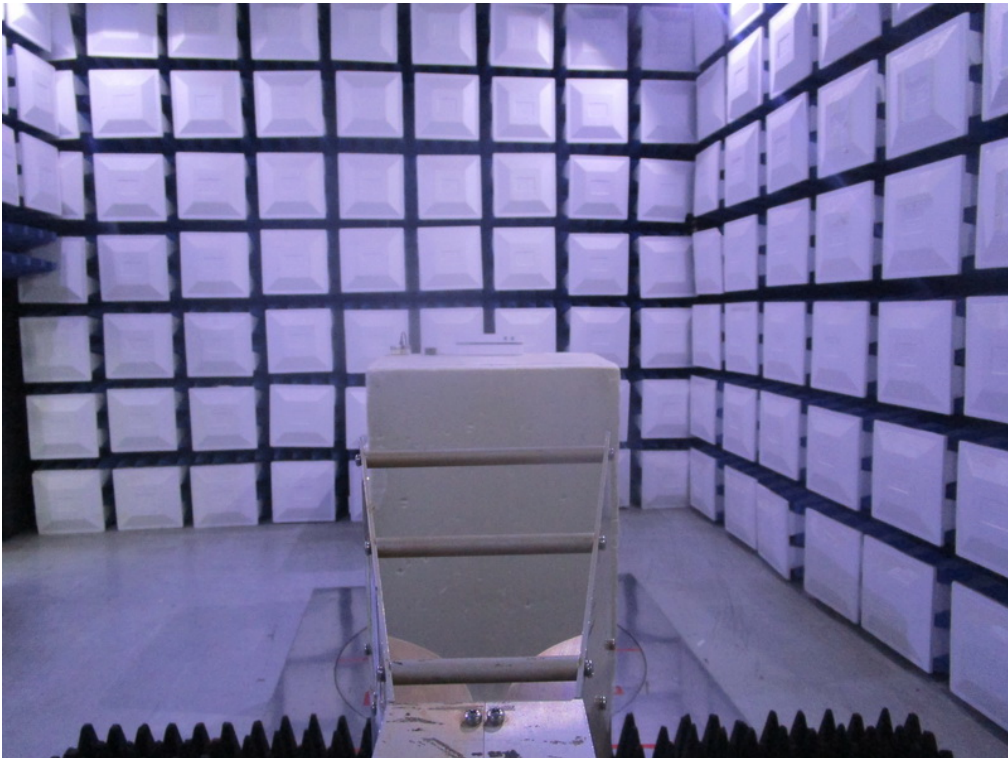
**Radiated Emissions Test Photos****Above 1 GHz**

## **APPENDIX A - AC POWER LINE CONDUCTED EMISSIONS**

Test Mode	TX Mode_1Mbps Channel 19	Phase	Line
-----------	--------------------------	-------	------

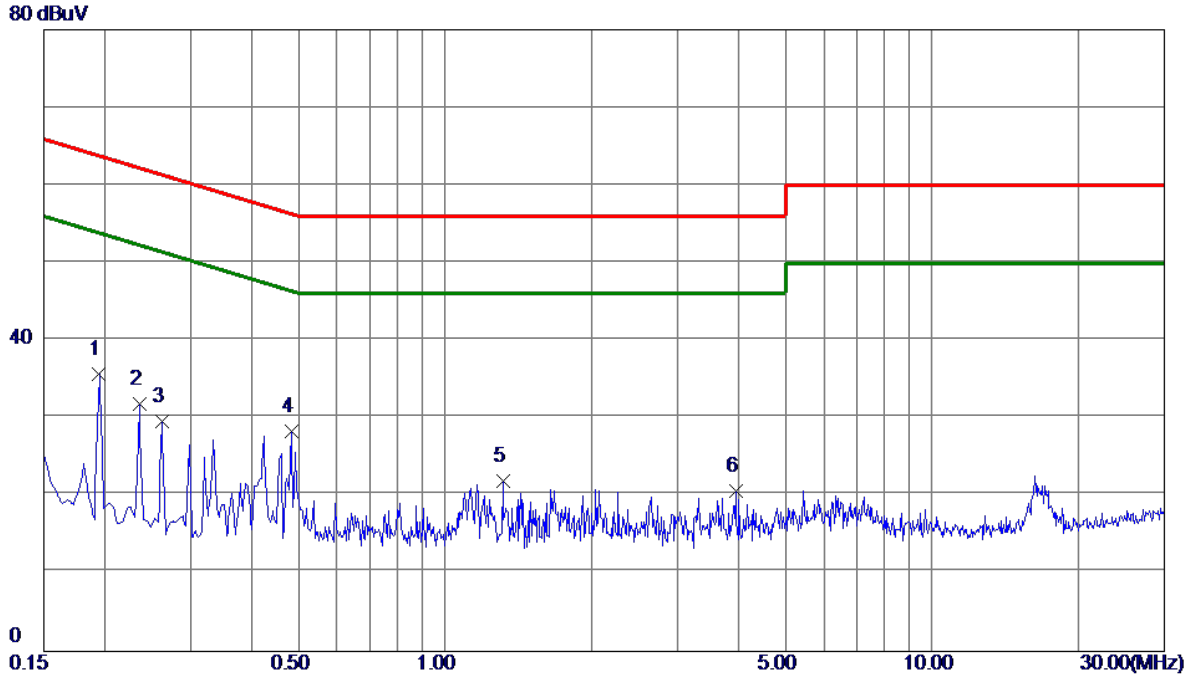

No.	Freq. MHz	Reading Level dBuV	Correct Factor dB	Measure ment dBuV	Limit dBuV	Margin dB	Detector	Comment
1	0.1949	25.77	9.89	35.66	63.83	-28.17	Peak	
2	0.2355	21.98	9.88	31.86	62.25	-30.39	Peak	
3	0.2625	19.68	9.87	29.55	61.35	-31.80	Peak	
4 *	0.4830	18.42	9.92	28.34	56.29	-27.95	Peak	
5	1.3154	11.97	10.00	21.97	56.00	-34.03	Peak	
6	3.9480	10.51	10.20	20.71	56.00	-35.29	Peak	

**REMARKS:**

- (1) Measurement Value = Reading Level + Correct Factor.
- (2) Margin Level = Measurement Value - Limit Value.

Test Mode	TX Mode_1Mbps Channel 19	Phase	Neutral
-----------	--------------------------	-------	---------

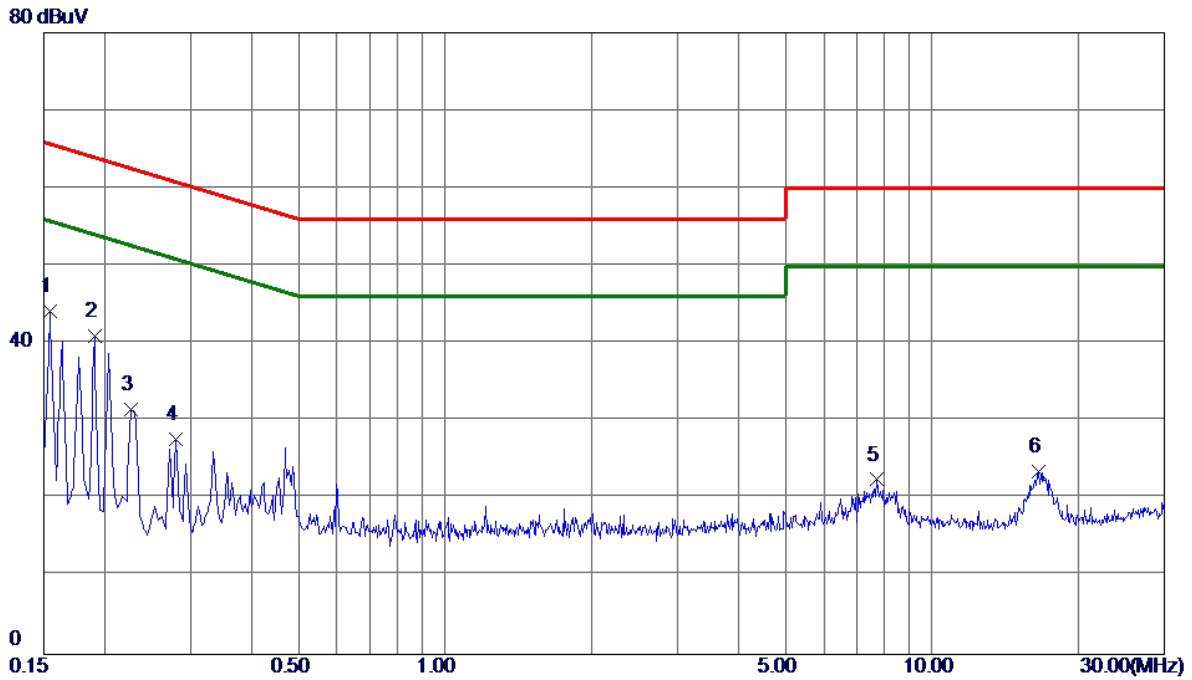

No.	Freq. MHz	Reading Level dBuV	Correct Factor dB	Measure ment dBuV	Limit dBuV	Margin dB	Detector	Comment
1 *	0.1544	34.45	9.78	44.23	65.76	-21.53	Peak	
2	0.1905	31.03	9.97	41.00	64.01	-23.01	Peak	
3	0.2267	21.55	9.99	31.54	62.57	-31.03	Peak	
4	0.2805	17.64	9.99	27.63	60.80	-33.17	Peak	
5	7.7010	11.65	10.83	22.48	60.00	-37.52	Peak	
6	16.5660	12.36	11.10	23.46	60.00	-36.54	Peak	

**REMARKS:**

- (1) Measurement Value = Reading Level + Correct Factor.
- (2) Margin Level = Measurement Value - Limit Value.

## **APPENDIX B - RADIATED EMISSION - 9 KHZ TO 30 MHZ**

Test Mode	TX Mode_1Mbps Channel 19	Polarization	Ant 0°
-----------	--------------------------	--------------	--------

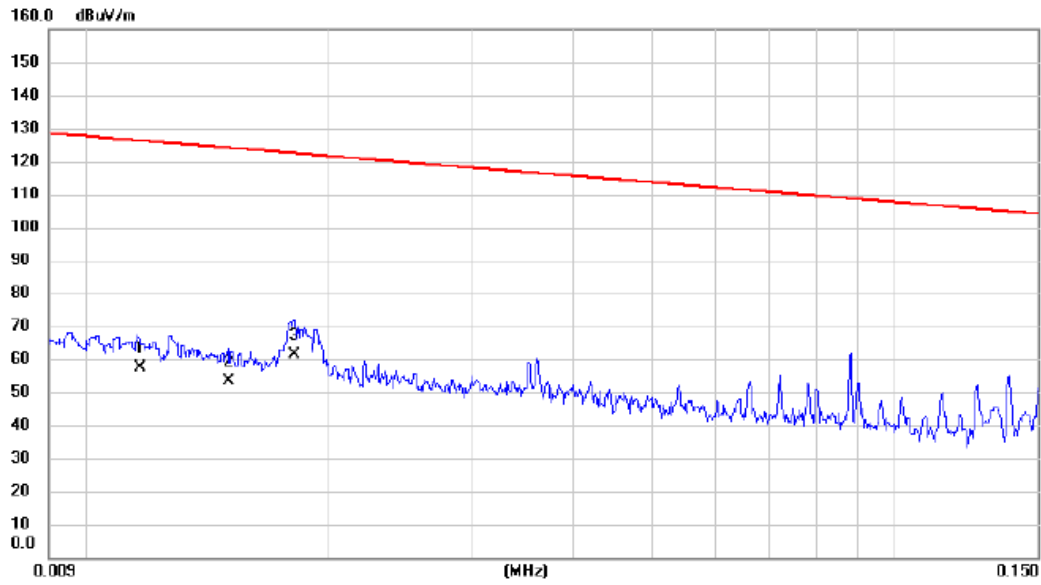

No. Mk.	Freq. MHz	Reading Level dBuV	Correct Factor dB	Measurement dBuV/m	Limit dBuV/m	Margin dB	Detector	Antenna Height cm	Table Degree	Comment
1	0.0117	40.25	17.02	57.27	126.24	-68.97	AVG			
2	0.0150	37.54	15.98	53.52	124.08	-70.56	AVG			
3 *	0.0181	46.52	15.01	61.53	122.45	-60.92	AVG			

**REMARKS:**

- (1) Measurement Value = Reading Level + Correct Factor.
- (2) Margin Level = Measurement Value - Limit Value.



Test Mode	Test Mode TX Mode_1Mbps Channel 19	Polarization	Ant 0°
-----------	------------------------------------	--------------	--------

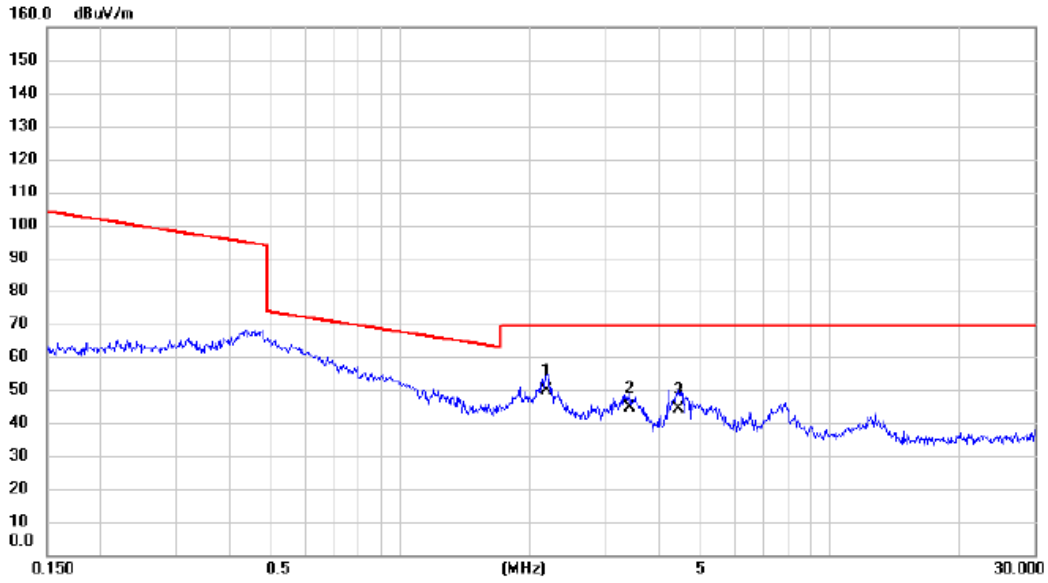

No.	Mk.	Freq.	Reading Level	Correct Factor	Measurement	Limit	Margin	Antenna Height	Table Degree	Comment
		MHz	dBuV	dB	dBuV/m	dBuV/m	dB	cm	degree	
1	*	2.1898	37.54	12.19	49.73	69.54	-19.81	QP		
2		3.4174	32.62	11.99	44.61	69.54	-24.93	QP		
3		4.4305	32.24	12.07	44.31	69.54	-25.23	QP		

REMARKS:

- (1) Measurement Value = Reading Level + Correct Factor.
- (2) Margin Level = Measurement Value - Limit Value.

Test Mode	Test Mode TX Mode_1Mbps Channel 19	Polarization	Ant 90°
-----------	------------------------------------	--------------	---------

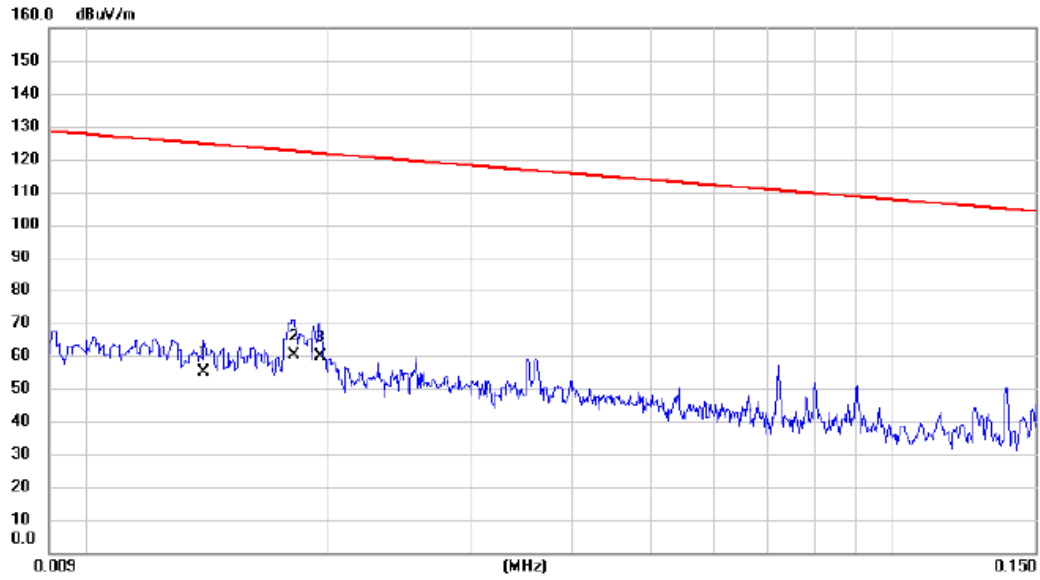

No.	Mk.	Freq.	Reading Level	Correct Factor	Measurement	Limit	Margin	Antenna Height	Table Degree	
		MHz	dBuV	dB	dBuV/m	dBuV/m	dB	cm	degree	Comment
1		0.0140	38.69	16.30	54.99	124.68	-69.69	AVG		
2		0.0181	45.26	15.01	60.27	122.45	-62.18	AVG		
3	*	0.0195	45.36	14.57	59.93	121.80	-61.87	AVG		

**REMARKS:**

- (1) Measurement Value = Reading Level + Correct Factor.
- (2) Margin Level = Measurement Value - Limit Value.

Test Mode	Test Mode TX Mode_1Mbps Channel 19	Polarization	Ant 90°
-----------	------------------------------------	--------------	---------

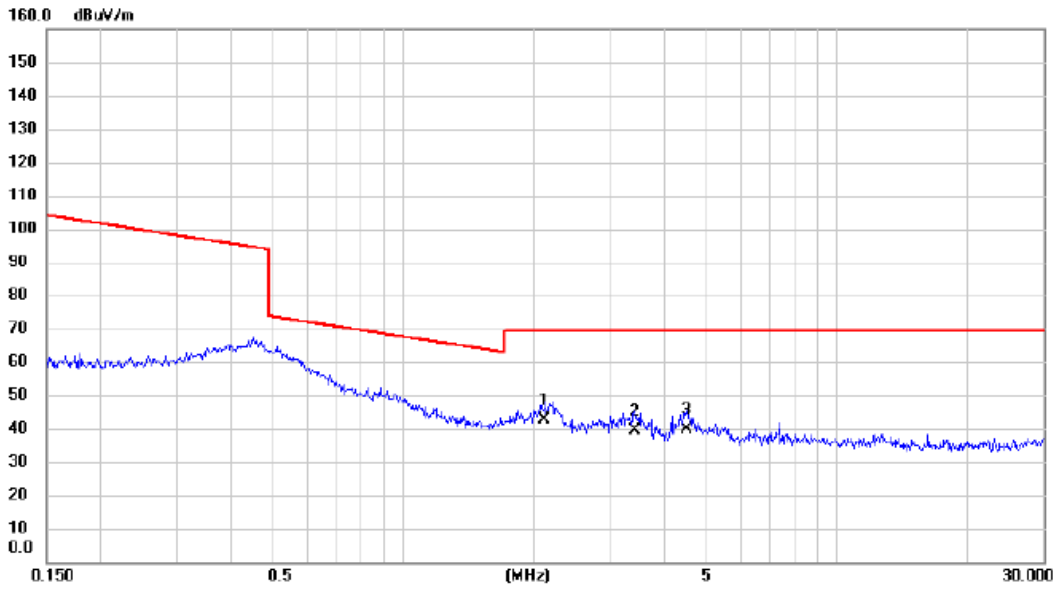

No.	Mk.	Freq. MHz	Reading Level dBuV	Correct Factor dB	Measure- ment dBuV/m	Limit dBuV/m	Margin dB	Detector	Antenna Height cm	Table Degree	Comment
1	*	2.1213	30.54	12.20	42.74	69.54	-26.80	QP			
2		3.4174	27.33	11.99	39.32	69.54	-30.22	QP			
3		4.5015	27.56	12.07	39.63	69.54	-29.91	QP			

REMARKS:

- (1) Measurement Value = Reading Level + Correct Factor.
- (2) Margin Level = Measurement Value - Limit Value.

**APPENDIX C - RADIATED EMISSION - 30 MHZ TO 1000 MHZ**

Test Mode	Test Mode TX Mode_1Mbps Channel 19	Polarization	Vertical
-----------	------------------------------------	--------------	----------

80 dBuV/m

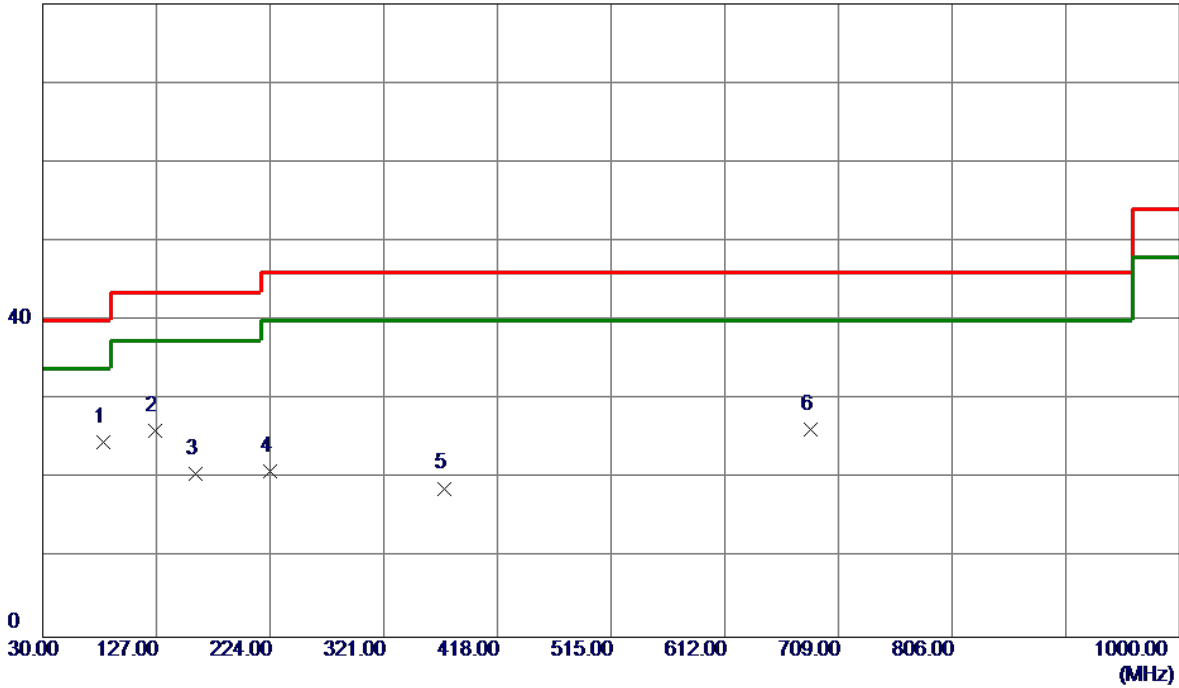

No.	Freq. MHz	Reading Level dBuV/m	Correct Factor dB	Measure ment dBuV/m	Limit dBuV/m	Margin dB	Detector	Comment
1 *	81.4100	43.12	-18.46	24.66	40.00	-15.34	Peak	
2	126.0300	39.71	-13.70	26.01	43.50	-17.49	Peak	
3	159.9800	32.99	-12.37	20.62	43.50	-22.88	Peak	
4	224.0000	35.46	-14.46	21.00	46.00	-25.00	Peak	
5	372.4100	28.23	-9.43	18.80	46.00	-27.20	Peak	
6	685.7199	29.50	-3.26	26.24	46.00	-19.76	Peak	

**REMARKS:**

- (1) Measurement Value = Reading Level + Correct Factor.
- (2) Margin Level = Measurement Value - Limit Value.

Test Mode	Test Mode TX Mode_1Mbps Channel 19	Polarization	Horizontal
-----------	------------------------------------	--------------	------------

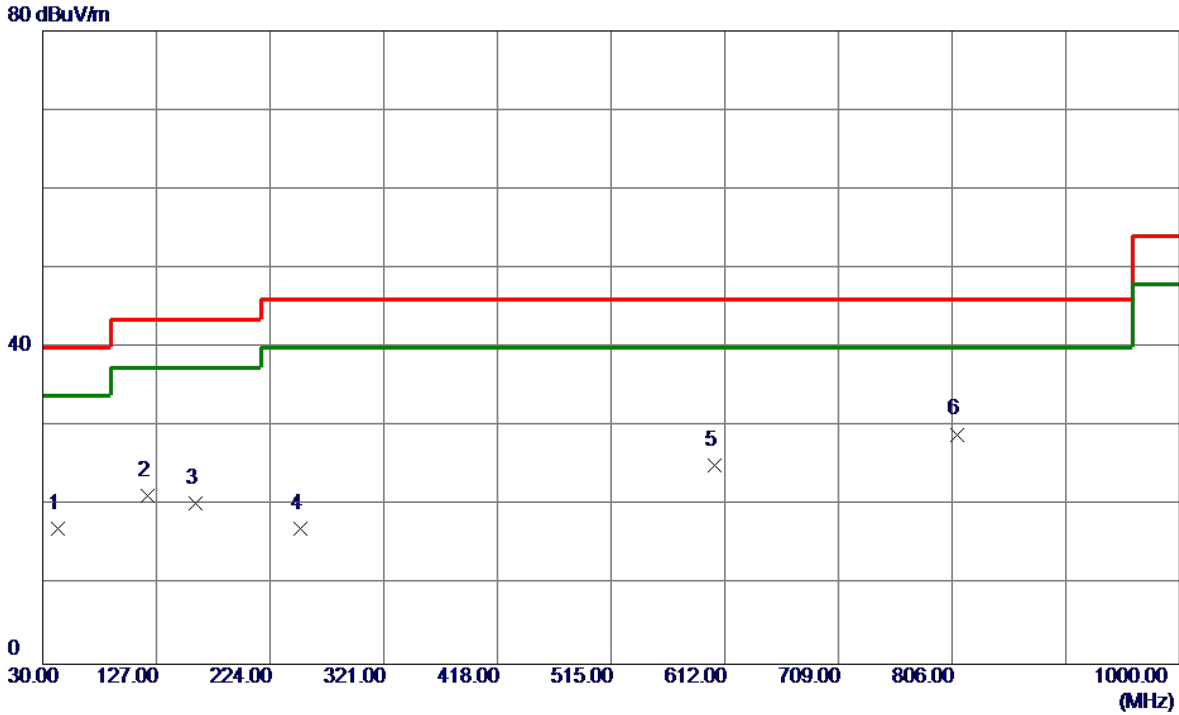

No.	Freq. MHz	Reading Level dBuV/m	Correct Factor dB	Measure ment dBuV/m	Limit dBuV/m	Margin dB	Detector	Comment
1	42.6100	31.08	-13.95	17.13	40.00	-22.87	Peak	
2	119.2400	35.47	-14.22	21.25	43.50	-22.25	Peak	
3	159.9800	32.62	-12.37	20.25	43.50	-23.25	Peak	
4	250.1900	30.12	-12.93	17.19	46.00	-28.81	Peak	
5	603.2700	29.64	-4.50	25.14	46.00	-20.86	Peak	
6 *	809.8800	29.71	-0.67	29.04	46.00	-16.96	Peak	

**REMARKS:**

- (1) Measurement Value = Reading Level + Correct Factor.
- (2) Margin Level = Measurement Value - Limit Value.

## **APPENDIX D - RADIATED EMISSION - ABOVE 1000 MHZ**

Test Mode	TX 2402 MHz _CH00_1Mbps	Polarization	Vertical
-----------	-------------------------	--------------	----------

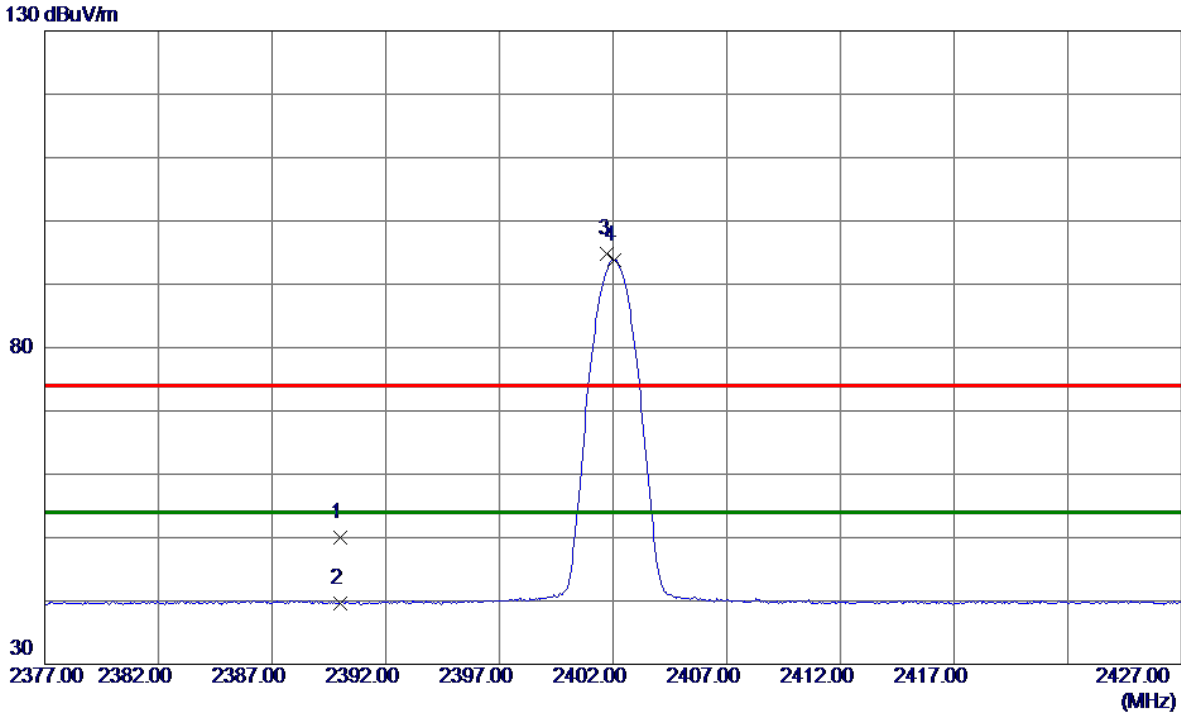

No.	Freq. MHz	Reading Level dBuV/m	Correct Factor dB	Measure ment dBuV/m	Limit dBuV/m	Margin dB	Detector	Comment
1	2390.0000	42.71	7.26	49.97	74.00	-24.03	Peak	
2	2390.0000	32.33	7.26	39.59	54.00	-14.41	AVG	
3	2401.7500	87.54	7.26	94.80	74.00	20.80	Peak	No Limit
4 *	2402.0500	86.62	7.26	93.88	54.00	39.88	AVG	No Limit

REMARKS:  
 (1) Measurement Value = Reading Level + Correct Factor.  
 (2) Margin Level = Measurement Value - Limit Value.



Test Mode	TX 2402 MHz _CH00_1Mbps	Polarization	Vertical
-----------	-------------------------	--------------	----------

80 dBuV/m

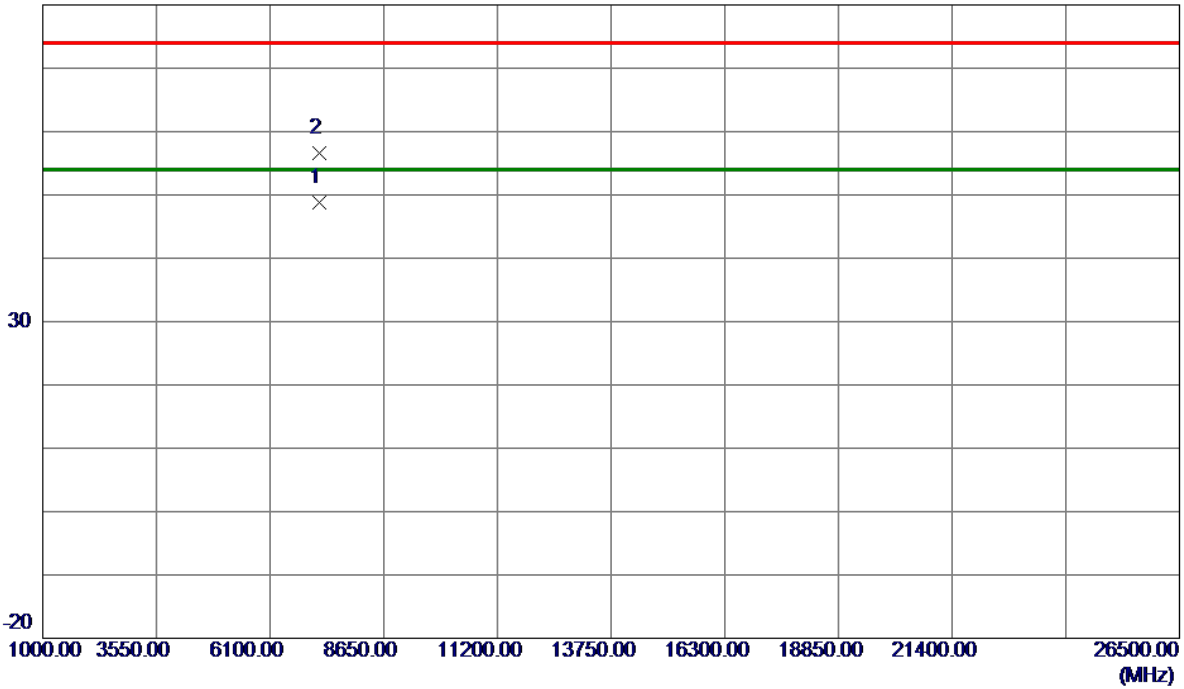

No.	Freq. MHz	Reading Level dBuV/m	Correct Factor dB	Measure ment dBuV/m	Limit dBuV/m	Margin dB	Detector	Comment
1 *	7205.3730	38.69	10.14	48.83	54.00	-5.17	AVG	
2	7206.9250	46.54	10.14	56.68	74.00	-17.32	Peak	

REMARKS:

- (1) Measurement Value = Reading Level + Correct Factor.
- (2) Margin Level = Measurement Value - Limit Value.

Test Mode	TX 2402 MHz _CH00_1Mbps	Polarization	Horizontal
-----------	-------------------------	--------------	------------

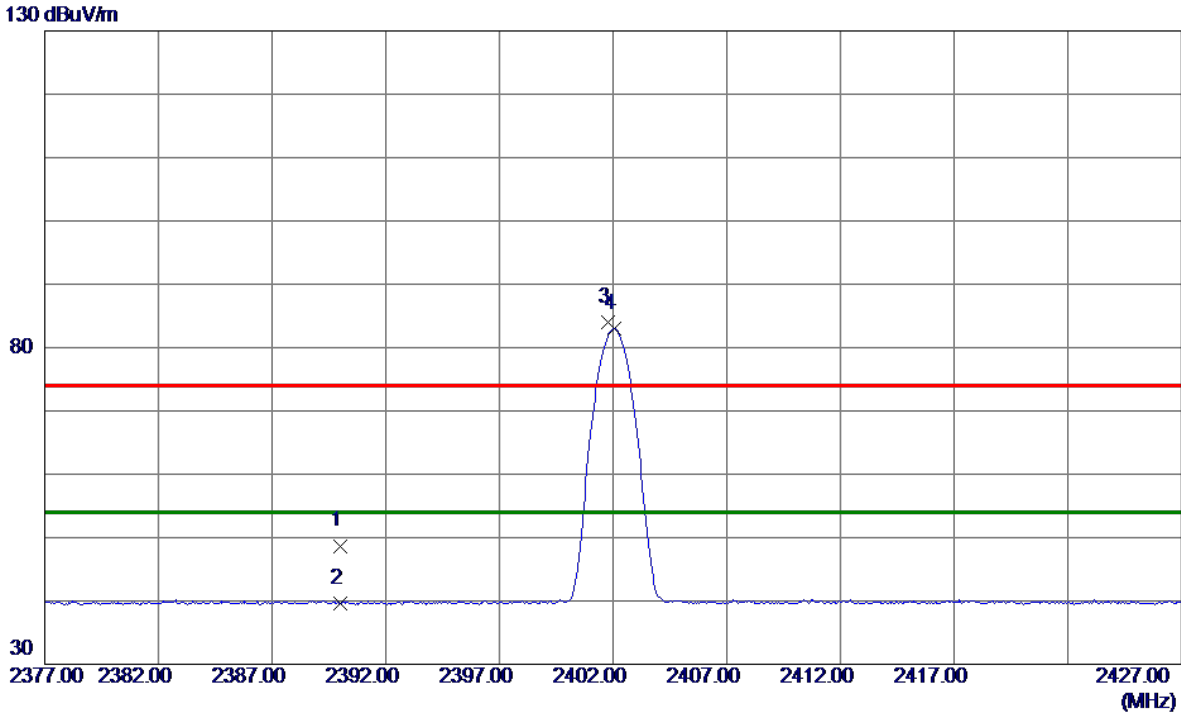

No.	Freq. MHz	Reading Level dBuV/m	Correct Factor dB	Measure ment dBuV/m	Limit dBuV/m	Margin dB	Detector	Comment
1	2390.0000	41.44	7.26	48.70	74.00	-25.30	Peak	
2	2390.0000	32.36	7.26	39.62	54.00	-14.38	AVG	
3	2401.8000	76.75	7.26	84.01	74.00	10.01	Peak	No Limit
4 *	2402.0500	75.70	7.26	82.96	54.00	28.96	AVG	No Limit

REMARKS:  
 (1) Measurement Value = Reading Level + Correct Factor.  
 (2) Margin Level = Measurement Value - Limit Value.

Test Mode	TX 2402 MHz _CH00_1Mbps	Polarization	Horizontal
-----------	-------------------------	--------------	------------

80 dBuV/m

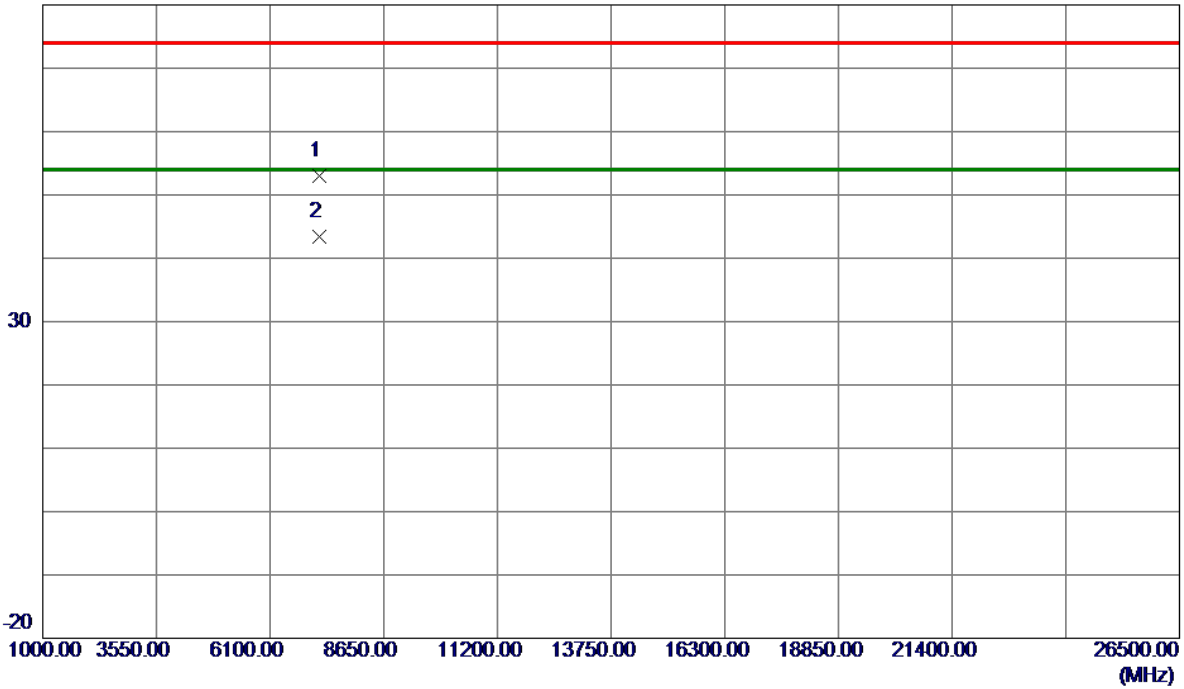

No.	Freq. MHz	Reading Level dBuV/m	Correct Factor dB	Measure ment dBuV/m	Limit dBuV/m	Margin dB	Detector	Comment
1	7205.0630	42.88	10.14	53.02	74.00	-20.98	Peak	
2 *	7205.2730	33.33	10.14	43.47	54.00	-10.53	AVG	

REMARKS:

- (1) Measurement Value = Reading Level + Correct Factor.
- (2) Margin Level = Measurement Value - Limit Value.

Test Mode	TX 2440 MHz _CH19_1Mbps	Polarization	Vertical
-----------	-------------------------	--------------	----------

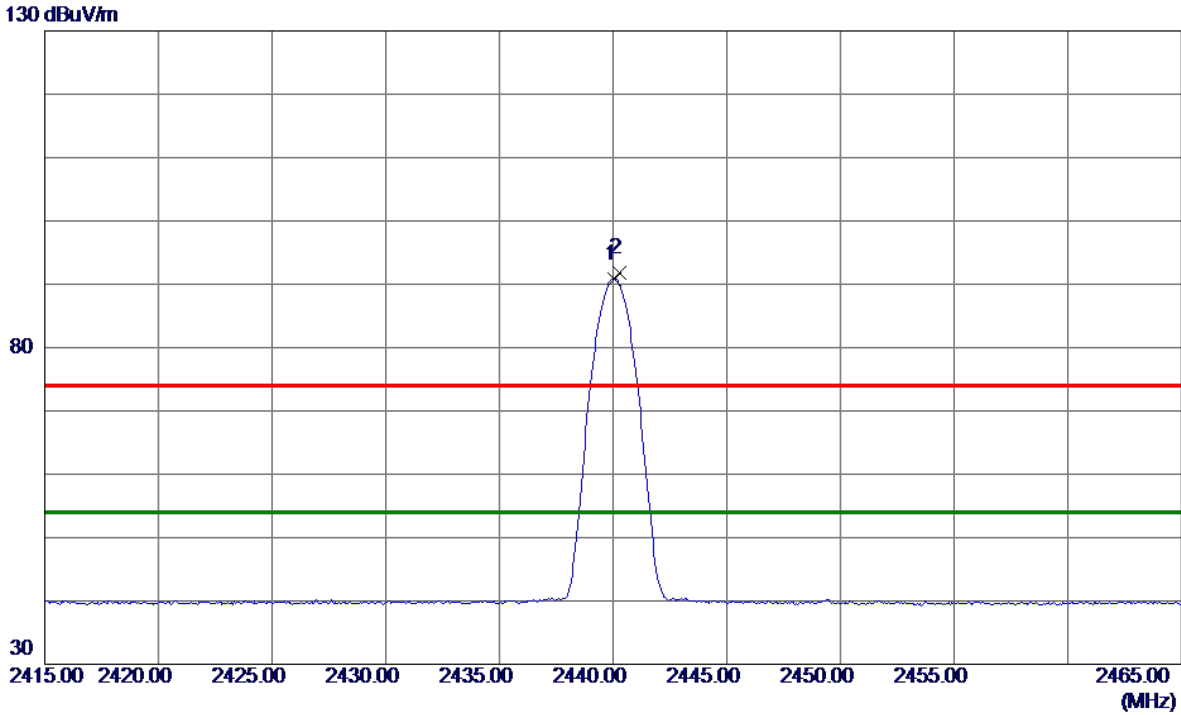

No.	Freq. MHz	Reading Level dBuV/m	Correct Factor dB	Measure ment dBuV/m	Limit dBuV/m	Margin dB	Detector	Comment
1 *	2440.0500	83.64	7.25	90.89	54.00	36.89	AVG	No Limit
2	2440.3000	84.63	7.25	91.88	74.00	17.88	Peak	No Limit

REMARKS:

- (1) Measurement Value = Reading Level + Correct Factor.
- (2) Margin Level = Measurement Value - Limit Value.

Test Mode	TX 2440 MHz _CH19_1Mbps	Polarization	Vertical
-----------	-------------------------	--------------	----------

80 dBuV/m

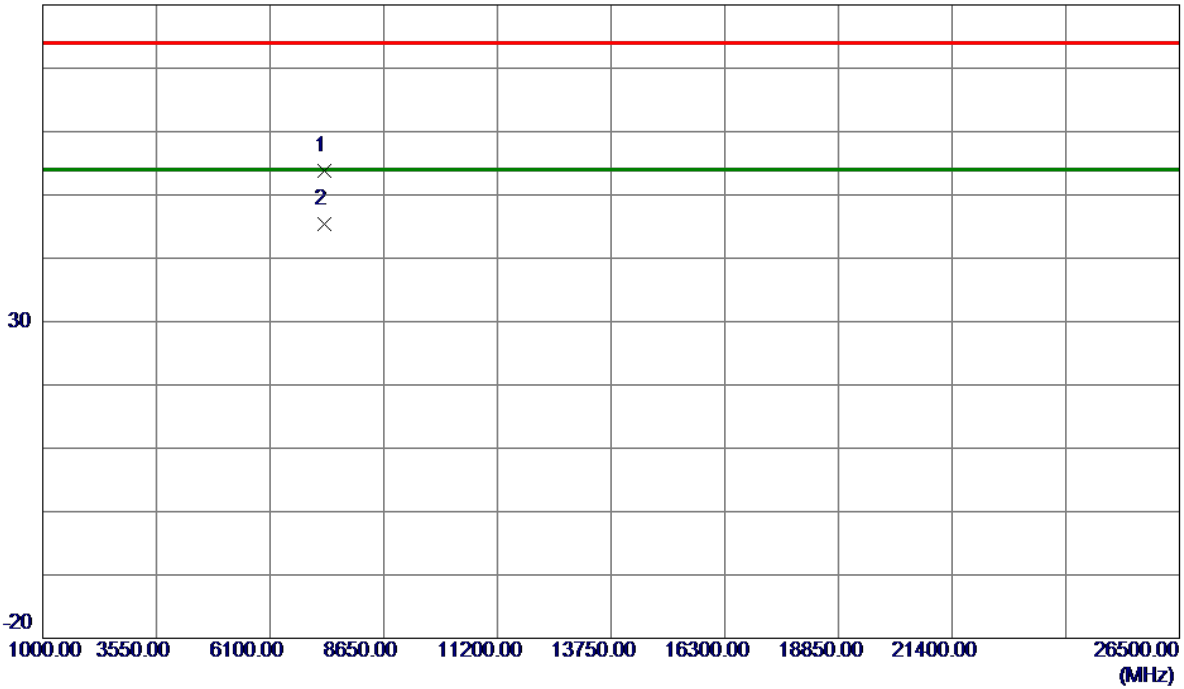

No.	Freq. MHz	Reading Level dBuV/m	Correct Factor dB	Measure ment dBuV/m	Limit dBuV/m	Margin dB	Detector	Comment
1	7319.0750	43.48	10.33	53.81	74.00	-20.19	Peak	
2 *	7320.7120	35.11	10.34	45.45	54.00	-8.55	AVG	

REMARKS:

- (1) Measurement Value = Reading Level + Correct Factor.
- (2) Margin Level = Measurement Value - Limit Value.

Test Mode	TX 2440 MHz _CH19_1Mbps	Polarization	Horizontal
-----------	-------------------------	--------------	------------

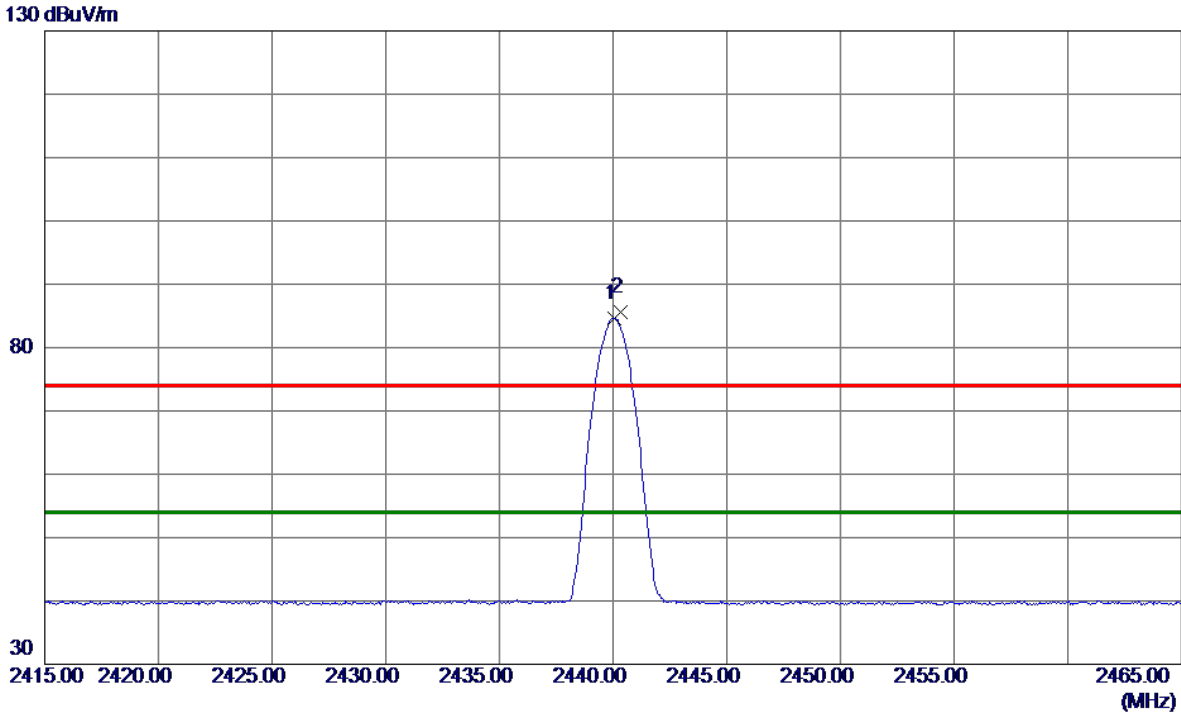

No.	Freq. MHz	Reading Level dBuV/m	Correct Factor dB	Measure ment dBuV/m	Limit dBuV/m	Margin dB	Detector	Comment
1 *	2440.0500	77.38	7.25	84.63	54.00	30.63	AVG	No Limit
2	2440.3500	78.37	7.25	85.62	74.00	11.62	Peak	No Limit

REMARKS:

- (1) Measurement Value = Reading Level + Correct Factor.
- (2) Margin Level = Measurement Value - Limit Value.

Test Mode	TX 2440 MHz _CH19_1Mbps	Polarization	Horizontal
-----------	-------------------------	--------------	------------

80 dBuV/m

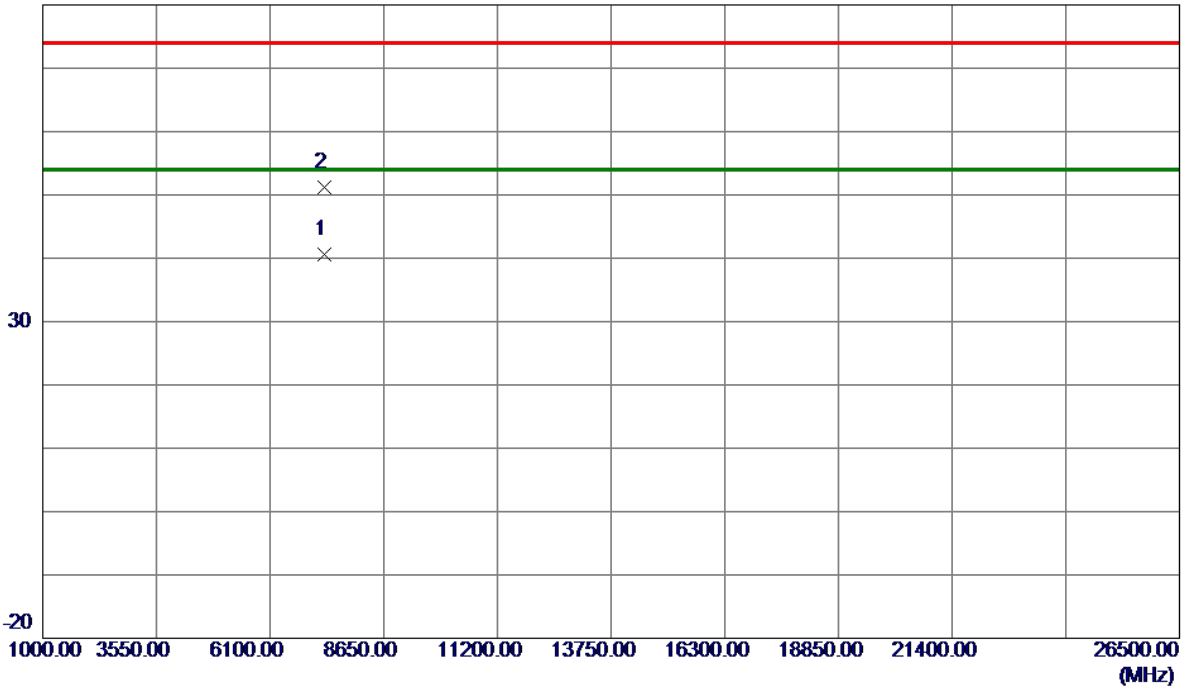

No.	Freq. MHz	Reading Level dBuV/m	Correct Factor dB	Measure ment dBuV/m	Limit dBuV/m	Margin dB	Detector	Comment
1 *	7319.4150	30.36	10.33	40.69	54.00	-13.31	AVG	
2	7320.9830	40.87	10.34	51.21	74.00	-22.79	Peak	

REMARKS:

- (1) Measurement Value = Reading Level + Correct Factor.
- (2) Margin Level = Measurement Value - Limit Value.

Test Mode	TX 2480 MHz _CH39_1Mbps	Polarization	Vertical
-----------	-------------------------	--------------	----------

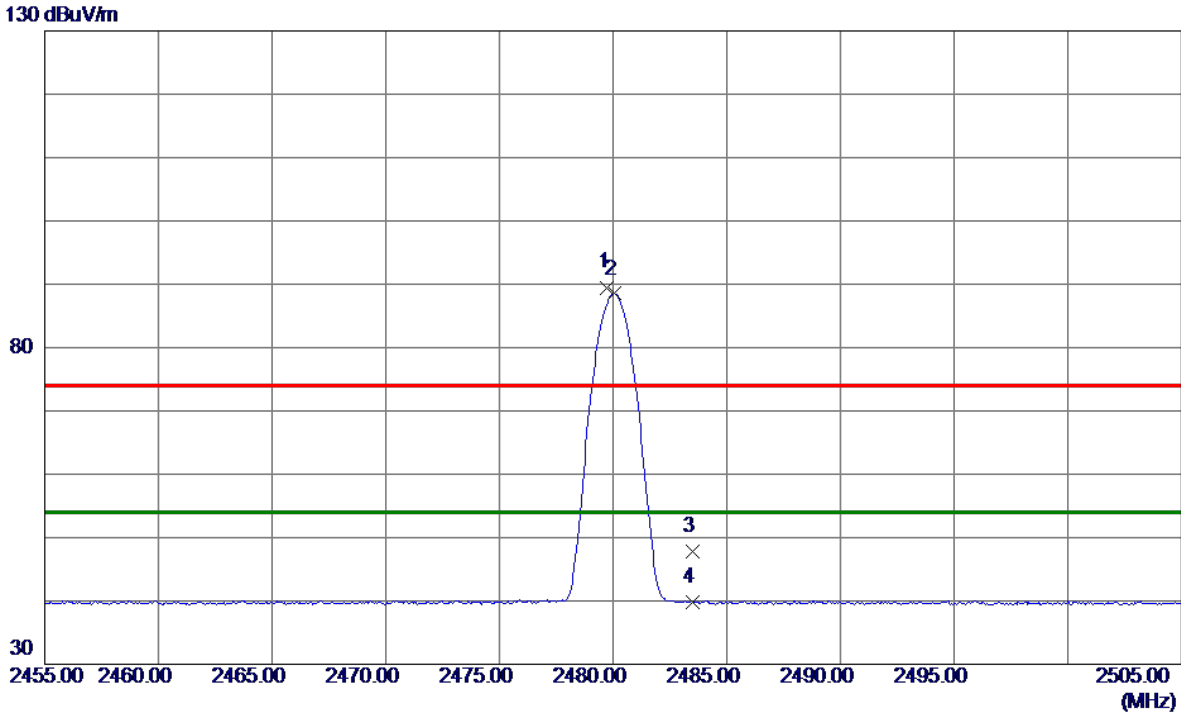

No.	Freq. MHz	Reading Level dBuV/m	Correct Factor dB	Measure ment dBuV/m	Limit dBuV/m	Margin dB	Detector	Comment
1	2479.7500	82.25	7.25	89.50	74.00	15.50	Peak	No Limit
2 *	2480.0500	81.25	7.25	88.50	54.00	34.50	AVG	No Limit
3	2483.5000	40.51	7.25	47.76	74.00	-26.24	Peak	
4	2483.5000	32.57	7.25	39.82	54.00	-14.18	AVG	

REMARKS:

- (1) Measurement Value = Reading Level + Correct Factor.
- (2) Margin Level = Measurement Value - Limit Value.



Test Mode	TX 2480 MHz _CH39_1Mbps	Polarization	Vertical
-----------	-------------------------	--------------	----------

80 dBuV/m

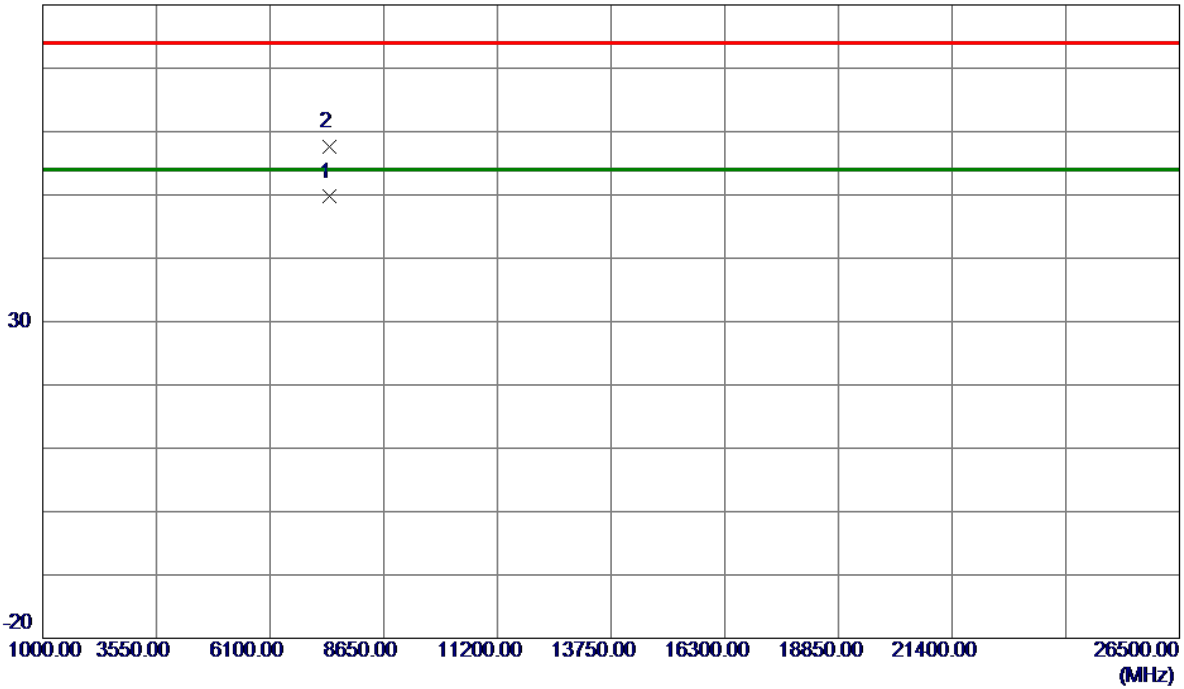

No.	Freq. MHz	Reading Level dBuV/m	Correct Factor dB	Measure ment dBuV/m	Limit dBuV/m	Margin dB	Detector	Comment
1 *	7439.3700	39.16	10.54	49.70	54.00	-4.30	AVG	
2	7440.8900	47.13	10.54	57.67	74.00	-16.33	Peak	

REMARKS:

- (1) Measurement Value = Reading Level + Correct Factor.
- (2) Margin Level = Measurement Value - Limit Value.

Test Mode	TX 2480 MHz _CH39_1Mbps	Polarization	Horizontal
-----------	-------------------------	--------------	------------

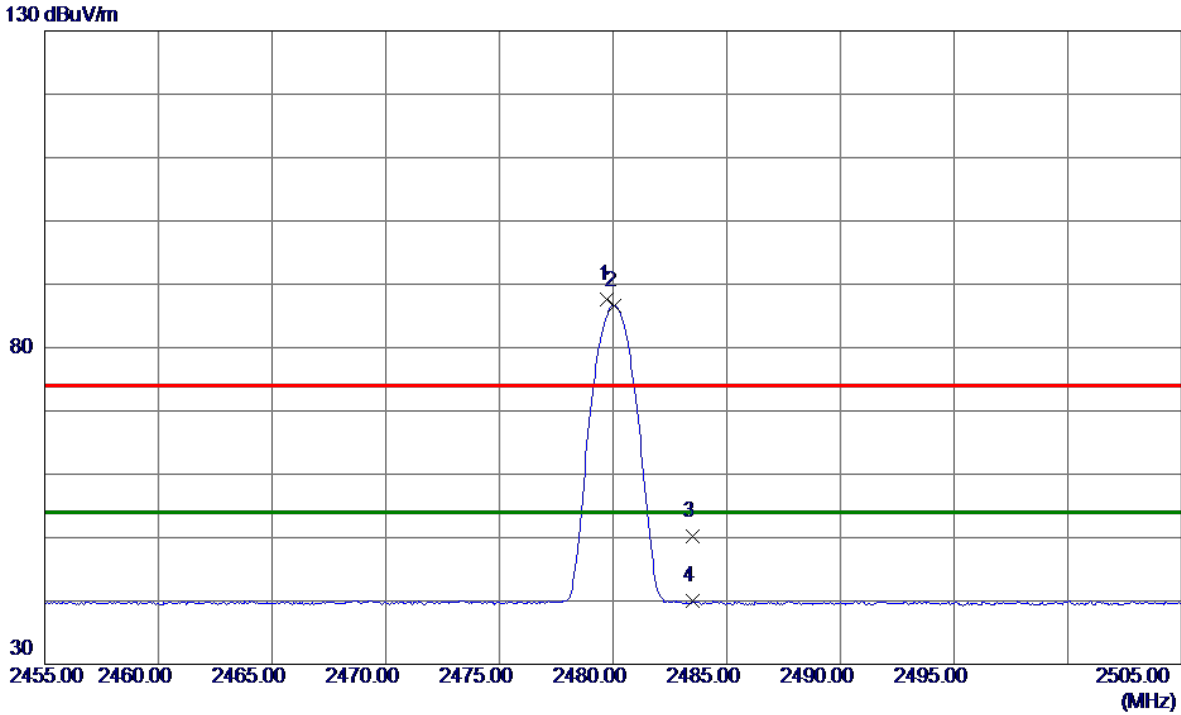

No.	Freq. MHz	Reading Level dBuV/m	Correct Factor dB	Measure ment dBuV/m	Limit dBuV/m	Margin dB	Detector	Comment
1	2479.7500	80.37	7.25	87.62	74.00	13.62	Peak	No Limit
2 *	2480.0500	79.36	7.25	86.61	54.00	32.61	AVG	No Limit
3	2483.5000	42.99	7.25	50.24	74.00	-23.76	Peak	
4	2483.5000	32.72	7.25	39.97	54.00	-14.03	AVG	

REMARKS:  
 (1) Measurement Value = Reading Level + Correct Factor.  
 (2) Margin Level = Measurement Value - Limit Value.

Test Mode	TX 2480 MHz _CH39_1Mbps	Polarization	Horizontal
-----------	-------------------------	--------------	------------

80 dBuV/m

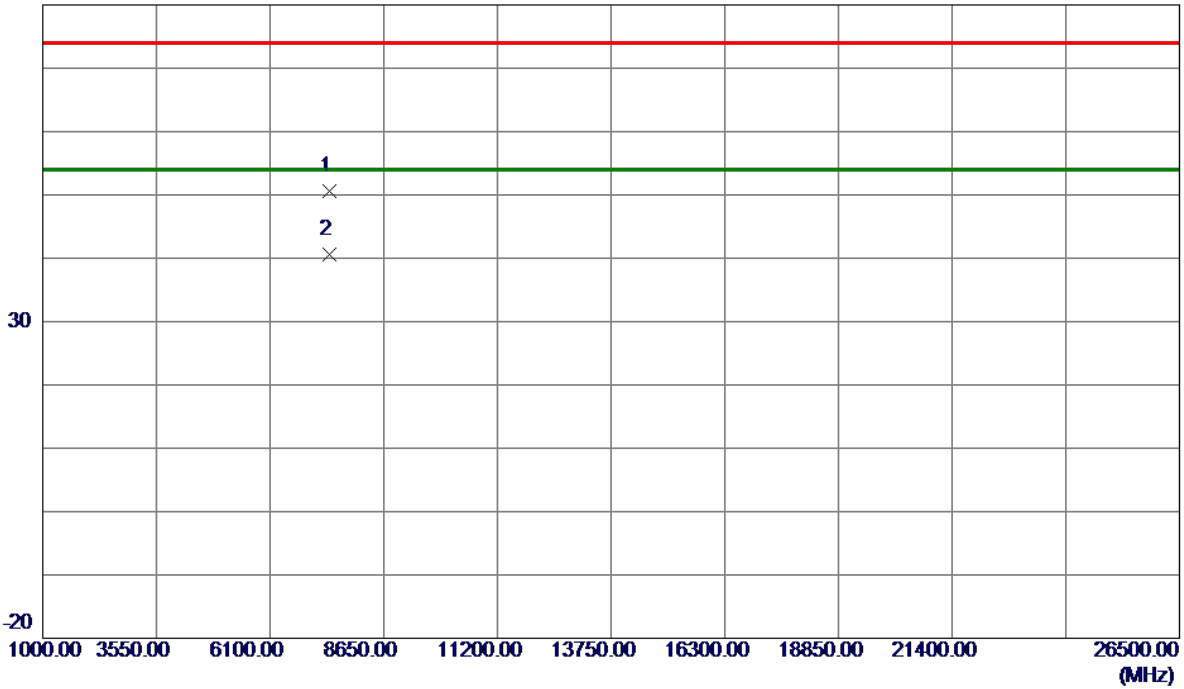

No.	Freq. MHz	Reading Level dBuV/m	Correct Factor dB	Measure ment dBuV/m	Limit dBuV/m	Margin dB	Detector	Comment
1	7438.7500	39.98	10.54	50.52	74.00	-23.48	Peak	
2 *	7439.5000	30.12	10.54	40.66	54.00	-13.34	AVG	

REMARKS:

- (1) Measurement Value = Reading Level + Correct Factor.
- (2) Margin Level = Measurement Value - Limit Value.

## APPENDIX E - BANDWIDTH

Test Mode	TX Mode_1Mbps
-----------	---------------

Channel	Frequency (MHz)	6 dB Bandwidth (MHz)	99 % Occupied Bandwidth (MHz)	6 dB Bandwidth Min. Limit (MHz)	Test Result
00	2402	0.788	1.080	0.5	Pass
19	2440	0.796	1.096	0.5	Pass
39	2480	0.792	1.092	0.5	Pass

**CH00**

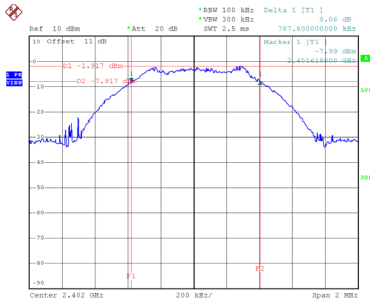

Date: 26.MAY.2021 11:45:01

**CH19**

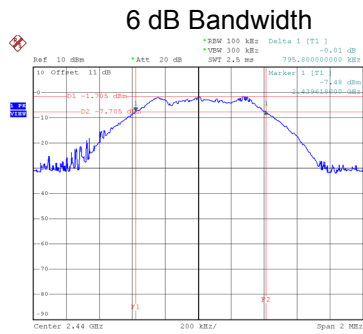

Date: 26.MAY.2021 11:48:02

**CH39**

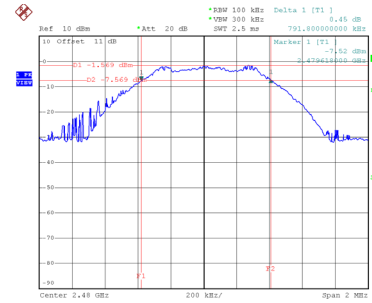

Date: 26.MAY.2021 11:50:32

**99 % Occupied Bandwidth**

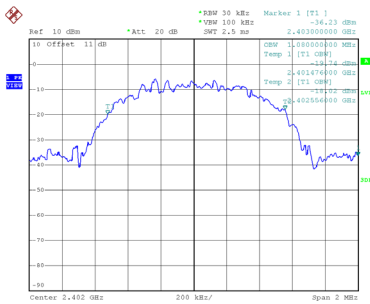

Date: 26.MAY.2021 11:44:02

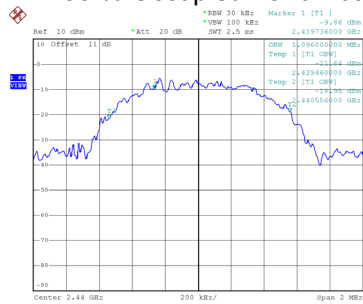

Date: 26.MAY.2021 11:48:10

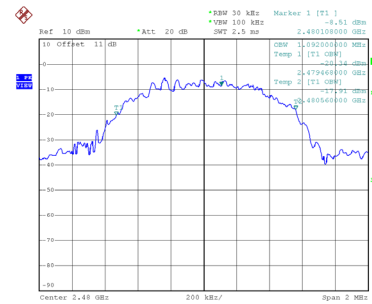

Date: 26.MAY.2021 11:50:40

**APPENDIX F - MAXIMUM OUTPUT POWER**

Test Mode	TX Mode_1Mbps
-----------	---------------

Frequency (MHz)	Output Power (dBm)	Output Power (W)	Max. Limit (dBm)	Max. Limit (W)	Test Result
2402	-1.02	0.0008	30.00	1.0000	Pass
2440	-0.45	0.0009	30.00	1.0000	Pass
2480	-0.64	0.0009	30.00	1.0000	Pass

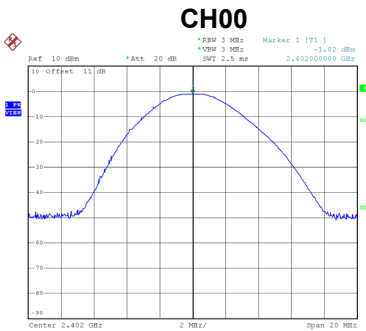

Date: 26.MAY.2021 11:45:58

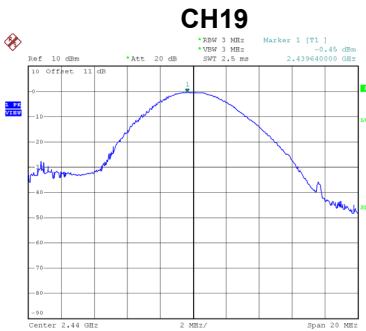

Date: 26.MAY.2021 11:49:06

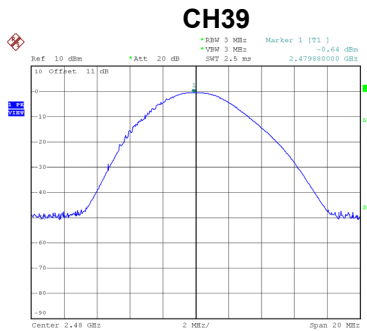

Date: 26.MAY.2021 11:51:36

## **APPENDIX G - CONDUCTED SPURIOUS EMISSION**



Test Mode TX Mode\_1Mbps

### Bandedge CH00 (Lower)

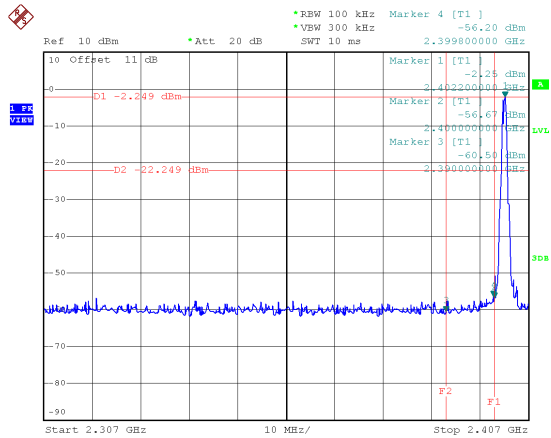

Date: 26.MAY.2021 11:45:10

### Bandedge CH39 (Upper)

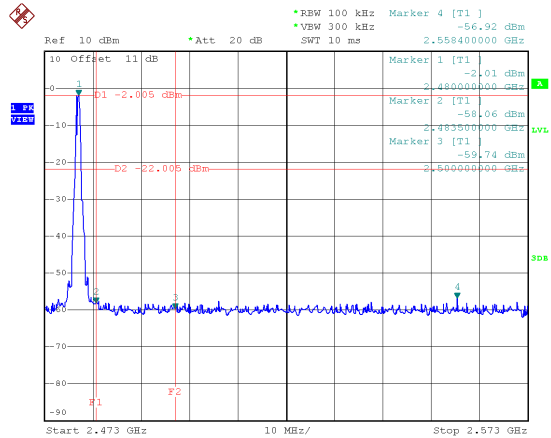

Date: 26.MAY.2021 11:50:49

### CH00 – 10th Harmonic of the fundamental frequency

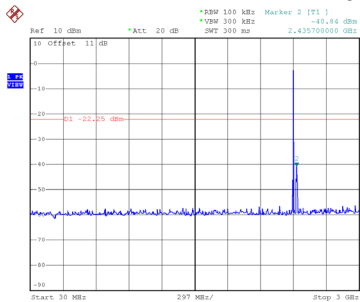

Date: 26.MAY.2021 11:45:25

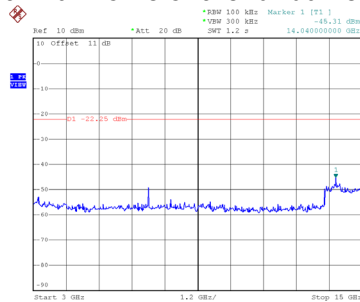

Date: 26.MAY.2021 11:45:34

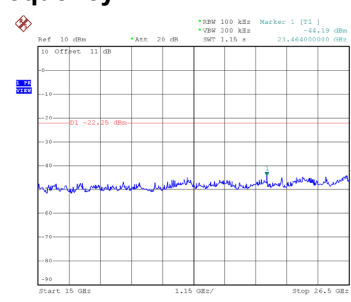

Date: 26.MAY.2021 11:45:43

### CH19 – 10th Harmonic of the fundamental frequency

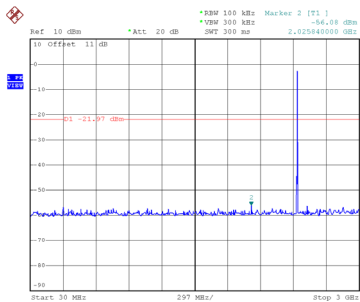

Date: 26.MAY.2021 11:48:33

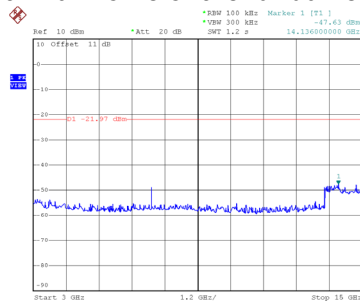

Date: 26.MAY.2021 11:48:42

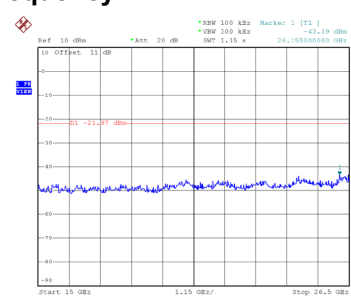

Date: 26.MAY.2021 11:48:51

### CH39 – 10th Harmonic of the fundamental frequency

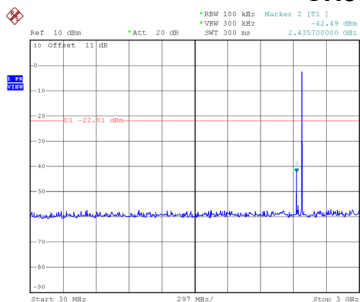

Date: 26.MAY.2021 11:51:03

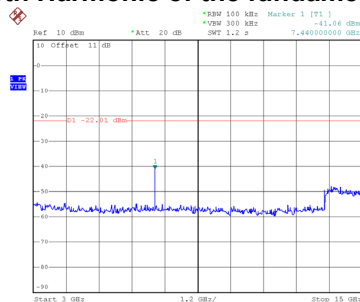

Date: 26.MAY.2021 11:51:12

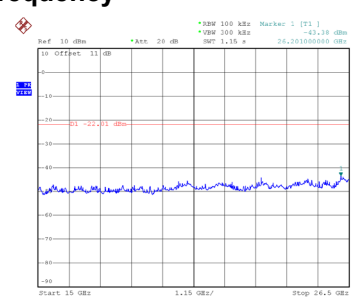

Date: 26.MAY.2021 11:51:22

## APPENDIX H - POWER SPECTRAL DENSITY

Test Mode	TX Mode_1Mbps
-----------	---------------

Channel	Frequency (MHz)	Power Spectral Density (dBm/3 kHz)	Max. Limit (dBm/3 kHz)	Test Result
00	2402	-18.11	8.00	Pass
19	2440	-18.18	8.00	Pass
39	2480	-18.07	8.00	Pass

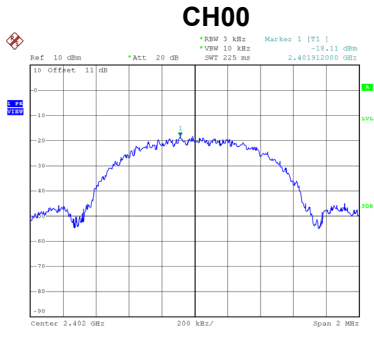

Date: 26.MAY.2021 11:45:50

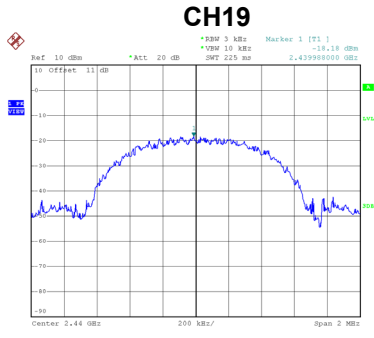

Date: 26.MAY.2021 11:48:59

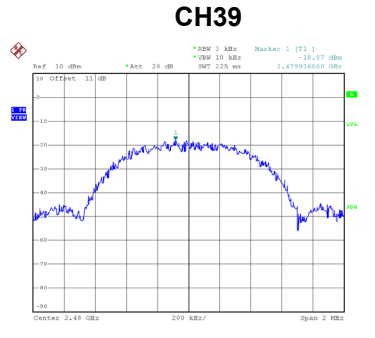

Date: 26.MAY.2021 11:51:29

**End of Test Report**