



FCC Test Report

Test report
On Behalf of
Shenzhen Joystek Intelligence Co., Ltd
For
WiFi Trail Camera
Model No.: Trailcam X1, X1, Trailcam X2, Trailcam X3, Trailcam
X4, Trailcam X5, Trailcam X6, Trailcam X7, Trailcam X8, Trailcam
X9, Trailcam X10

FCC ID: 2AUSP-X1

Prepared For : Shenzhen Joystek Intelligence Co., Ltd
3F, Building A Plus, Shun Xing Industrial Park, Zhongxing Rd., Bantian, Longgang District, Shenzhen, 518129 China

Prepared By : Shenzhen DL Testing Technology Co., Ltd.
101-201, Building C, Shuanghuan, No.8, Baoqing Road, Baolong Industrial Zone, Baolong Street, Longgang District, Shenzhen, Guangdong, China

Date of Test: Apr. 16, 2024 ~ May 16, 2024
Date of Report: May 16, 2024
Report Number: DL-240604013-1ER



Test Result Certification

Applicant's name : Shenzhen Joystek Intelligence Co., Ltd
Address : 3F, Building A Plus, Shun Xing Industrial Park, Zhongxing Rd.,
 Bantian, Longgang District, Shenzhen, 518129 China
Manufacturer's Name : Shenzhen Joystek Intelligence Co., Ltd
Address : 3F, Building A Plus, Shun Xing Industrial Park, Zhongxing Rd.,
 Bantian, Longgang District, Shenzhen, 518129 China

Product description

Trade Mark: N/A
Product name..... : WiFi Trail Camera
Model and/or type reference : Trailcam X1, X1, Trailcam X2, Trailcam X3, Trailcam X4, Trailcam X5, Trailcam X6, Trailcam X7, Trailcam X8, Trailcam X9, Trailcam X10
Standards..... : FCC Rules and Regulations Part 15 Subpart C Section 15.247
 ANSI C63.10: 2013

This publication may be reproduced in whole or in part for non-commercial purposes as long as the Shenzhen DL Testing Technology Co., Ltd. is acknowledged as copyright owner and source of the material. Shenzhen DL Testing Technology Co., Ltd. takes no responsibility for and will not assume liability for damages resulting from the reader's interpretation of the reproduced material due to its placement and context.

Date of Test..... :
Date (s) of performance of tests..... : **Apr. 16, 2024 ~ May 16, 2024**
Date of Issue..... : **May 16, 2024**
Test Result : **Pass**

Testing Engineer : *Randy Xie*

 Randy Xie

Technical Manager : *Jack Bu*

 Jack Bu

Authorized Signatory : *Jade Yang*

 Jade Yang





Table of Contents

1. Test Result Summary	5
1.1. Test Procedures and Results	5
1.2. Information of the Test Laboratory	5
1.3. Measurement Uncertainty	6
2. EUT Description.....	7
2.1. General Description of EUT	7
2.2. Carrier Frequency of Channels.....	8
2.3. Operation of EUT During Testing	8
2.4. Description of Test Setup.....	9
2.5. Description of Support Units	10
2.6. Equipments List for All Test Items	11
3. Genera Information.....	12
3.1. Test Environment and Mode	12
4. Test Results and Measurement Data	15
4.1. Conducted Emission.....	15
4.2. Test Result	16
4.3. Maximum Conducted Output Power	18
4.4. Emission Bandwidth	20
4.5. Power Spectral Density	26
4.6. Conducted Band Edge and Spurious Emission Measurement	32
4.7. Radiated Spurious Emission Measurement	45
4.8. Antenna Requirement	70
5. Photograph of Test.....	71
6. Photos of the EUT.....	73



**** Modified History ****

Revision	Description	Issued Data	Remark
Revision 1.0	Initial Test Report Release	May 16, 2024	



1. Test Result Summary

1.1. Test Procedures and Results

Requirement	CFR 47 Section	Result
Antenna requirement	§15.203/§15.247(b)(4)	PASS
AC Power Line Conducted Emission	§15.207	PASS
Conducted Peak Output Power	§15.247(b)(3)	PASS
6dB Emission Bandwidth	§15.247(a)(2)	PASS
Power Spectral Density	§15.247(e)	PASS
Band Edge	§15.247(d)	PASS
Spurious Emission	§15.205/§15.209	PASS

Note:

1. PASS: Test item meets the requirement.
2. Fail: Test item does not meet the requirement.
3. N/A: Test case does not apply to the test object.
4. The test result judgment is decided by the limit of test standard.

1.2. Information of the Test Laboratory

Shenzhen DL Testing Technology Co., Ltd.

Add.: 101-201, Building C, Shuanghuan, No.8, Baoqing Road, Baolong Industrial Zone, Baolong Street, Longgang District, Shenzhen, Guangdong, China

Testing Laboratory Authorization :

FCC Test Firm Registration Number: 854456

Designation Number: CN1307

IC Registered No.: 27485

CAB ID.: CN0118



1.3. Measurement Uncertainty

The reported uncertainty of measurement $y \pm U$, where expanded uncertainty U is based on a standard uncertainty multiplied by a coverage factor of $k=2$, providing a level of confidence of approximately 95 %.

No.	Item	MU
1	Conducted Emission	$\pm 2.71\text{dB}$
2	RF power, conducted	$\pm 0.37\text{dB}$
3	Spurious emissions, conducted	$\pm 0.11\text{dB}$
4	All emissions, radiated(<1G)	$\pm 3.90\text{dB}$
5	All emissions, radiated(>1G)	$\pm 4.28\text{dB}$
6	Temperature	$\pm 0.1^\circ\text{C}$
7	Humidity	$\pm 1.0\%$



2. EUT Description

2.1. General Description of EUT

Equipment:	WiFi Trail Camera
Model Name:	Trailcam X1
Series Model:	X1, Trailcam X2, Trailcam X3, Trailcam X4, Trailcam X5, Trailcam X6, Trailcam X7, Trailcam X8, Trailcam X9, Trailcam X10
Model Difference:	All model's the function, software and electric circuit are the same, only with a product appearance, color and model named different. Test sample mode: Trailcam X1.
FCC ID:	2AUSP-X1
Antenna Type:	Iron sheet antenna
Antenna Gain:	1.94dBi
Operation frequency:	802.11b/g/n (HT20):2412~2462 MHz 802.11n (HT40): 2422~2452MHz
Number of Channels:	802.11b/g/n(HT20): 11CH 802.11n (HT40): 7CH
Modulation Type:	DSSS, OFDM
Power Source:	DC 5V From Type-C or DC 3.6V From Battery
Power Rating:	DC 5V From Type-C or DC 3.6V From Battery

Note:

1. For a more detailed features description, please refer to the manufacturer's specifications or the User's Manual.
2. Antenna gain Refer to the antenna specifications.
3. The cable loss data is obtained from the supplier.
4. The test results in the report only apply to the tested sample.



2.2. Carrier Frequency of Channels

Channel List For 802.11b/802.11g/802.11n (HT20)							
Channel	Frequency (MHz)	Channel	Frequency (MHz)	Channel	Frequency (MHz)	Channel	Frequency (MHz)
01	2412	04	2427	07	2442	10	2457
02	2417	05	2432	08	2447	11	2462
03	2422	06	2437	09	2452	--	--

Channel List For 802.11n (HT40)							
Channel	Frequency (MHz)	Channel	Frequency (MHz)	Channel	Frequency (MHz)	Channel	Frequency (MHz)
--	--	04	2427	07	2442	--	--
--	--	05	2432	08	2447	--	--
03	2422	06	2437	09	2452	--	--

Note:

In section 15.31(m), regards to the operating frequency range over 10 MHz, the Lowest frequency, the middle frequency, and the highest frequency of channel were selected to perform the test, and the selected channel see below:

2.3. Operation of EUT During Testing

Operating Mode

The mode is used: Transmitting mode for 802.11b/802.11g/802.11n (HT20)

- Low Channel: 2412MHz
- Middle Channel: 2437MHz
- High Channel: 2462MHz

The mode is used: Transmitting mode for 802.11n (HT40)

- Low Channel: 2422MHz
- Middle Channel: 2437MHz
- High Channel: 2452MHz



2.4. Description of Test Setup

Operation of EUT during conducted testing and below 1GHz radiation testing:

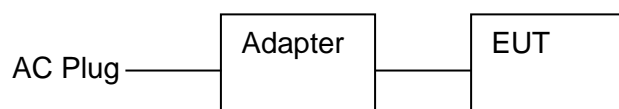

Operation of EUT during above 1GHz radiation testing:



The sample was placed (0.8m below 1GHz, 1.5m above 1GHz) above the ground plane of 3m chamber. Measurements in both horizontal and vertical polarities were performed. During the test, each emission was maximized by: having the EUT continuously working, investigated all operating modes, rotated about all 3 axis (X, Y & Z) and considered typical configuration to obtain worst position, manipulating interconnecting cables, rotating the turntable, varying antenna height from 1m to 4m in both horizontal and vertical polarizations. The emissions worst-case are shown in Test Results of the following pages. The worst case is X position.



2.5. Description of Support Units

The EUT has been tested as an independent unit together with other necessary accessories or support units. The following support units or accessories were used to form a representative test configuration during the tests.

Item	Equipment	Trade Mark	Model/Type No.	Specification	Remark
1	WiFi Trail Camera	N/A	Trailcam X1	N/A	EUT
2	USB Cable	N/A	N/A	Length:1.0m	Peripheral
3	Adapter	N/A	MDY-10-EH	Input: 100-240V, 50/60Hz, 0.7A Output: 5V, 3A/9V, 3A/12V, 2.25A/20V, 1.35A	Peripheral
4	Adapter	N/A	N/A	Input: 100-240V, 50/60Hz, 0.5A Output: 5VDC, 2A	Peripheral

Note:

1. All the equipment/cables were placed in the worst-case configuration to maximize the emission during the test.
2. Grounding was established in accordance with the manufacturer's requirements and conditions for the intended use.
3. For conducted measurements (Output Power, 6dB Emission Bandwidth, Power Spectral Density, Spurious Emissions), the antenna of EUT is connected to the test equipment via temporary antenna connector, the antenna connector is soldered on the antenna port of EUT, and the temporary antenna connector is listed in the Test Instruments.



2.6. Equipments List for All Test Items

Radiation test, Band-edge test and 20db bandwidth test equipment

Item	Equipment	Manufacturer	Type No.	Serial No.	Last calibration	Calibrated until
1	Spectrum Analyzer (9kHz-26.5GHz)	Agilent	E4408B	MY50140780	Nov. 04, 2023	Nov. 03, 2024
2	Test Receiver (9kHz-7GHz)	R&S	ESRP7	101393	Nov. 04, 2023	Nov. 03, 2024
3	Bilog Antenna (30MHz-1GHz)	R&S	VULB9162	00306	Nov. 04, 2023	Nov. 03, 2024
4	Horn Antenna (1GHz-18GHz)	Schwarzbeck	BBHA9120D	02139	Nov. 04, 2023	Nov. 03, 2024
5	Horn Antenna (18GHz-40GHz)	A.H. Systems	SAS-574	588	Nov. 04, 2023	Nov. 03, 2024
6	Amplifier (9KHz-6GHz)	Schwarzbeck	BBV9743B	00153	Nov. 04, 2023	Nov. 03, 2024
7	Amplifier (1GHz-18GHz)	EMEC	EM01G8GA	00270	Nov. 04, 2023	Nov. 03, 2024
8	Amplifier (18GHz-40GHz)	Quanjuda	DLE-161	97	Nov. 04, 2023	Nov. 03, 2024
9	Loop Antenna (9KHz-30MHz)	Schwarzbeck	FMZB1519B	00014	Nov. 04, 2023	Nov. 03, 2024
10	RF cables1 (9kHz-1GHz)	ChengYu	966	004	Nov. 04, 2023	Nov. 03, 2024
11	RF cables2 (1GHz-40GHz)	ChengYu	966	003	Nov. 04, 2023	Nov. 03, 2024
12	Antenna connector	Florida RF Labs	N/A	RF 01#	Nov. 04, 2023	Nov. 03, 2024
13	Power probe	KEYSIGHT	U2021XA	MY55210018	Nov. 04, 2023	Nov. 03, 2024
14	Signal Analyzer 9kHz-26.5GHz	Agilent	N9020A	MY55370280	Nov. 04, 2023	Nov. 03, 2024
15	Test Receiver 20kHz-40GHz	R&S	ESU 40	100376	Nov. 04, 2023	Nov. 03, 2024
16	D.C. Power Supply	LongWei	PS-305D	010964729	Nov. 04, 2023	Nov. 03, 2024

Conduction Test equipment

Item	Equipment	Manufacturer	Type No.	Serial No.	Last calibration	Calibrated until
1	843 Shielded Room	ChengYu	843 Room	843	Sep. 20, 2022	Sep. 19, 2025
2	EMI Receiver	R&S	ESR	101421	Nov. 04, 2023	Nov. 03, 2024
3	LISN	R&S	ENV216	102417	Nov. 04, 2023	Nov. 03, 2024
4	843 Cable 1#	ChengYu	CE Cable	001	Nov. 04, 2023	Nov. 03, 2024
5	10dB Attenuator	Schwarzbeck	VTSD9561F	00154	Nov. 04, 2023	Nov. 03, 2024

Other

Item	Name	Manufacturer	Model	Software version
1	EMC Conduction Test System	FALA	EZ_EMCC	EMC-CON 3A1.1
2	EMC radiation test system	FALA	EZ_EMCC	FA-03A2
3	RF test system	MAIWEI	MTS8310	2.0.0.0
4	RF communication test system	MAIWEI	MTS8200	2.0.0.0



3. General Information

3.1. Test Environment and Mode

Operating Environment:	
Temperature:	25.0 °C
Humidity:	56 % RH
Atmospheric Pressure:	1010 mbar
Test Mode:	
Engineering mode:	Keep the EUT in continuous transmitting by select channel and modulations
<p>The sample was placed (0.8m below 1GHz, 1.5m above 1GHz) above the ground plane of 3m chamber. Measurements in both horizontal and vertical polarities were performed. During the test, each emission was maximized by: having the EUT continuously working, investigated all operating modes, rotated about all 3 axis (X, Y & Z) and considered typical configuration to obtain worst position, manipulating interconnecting cables, rotating the turntable, varying antenna height from 1m to 4m in both horizontal and vertical polarizations. The emissions worst-case are shown in Test Results of the following pages. For the full battery state and The output power to the maximum state.</p>	



We have verified the construction and function in typical operation. All the test modes were carried out with the EUT in transmitting operation, which was shown in this test report and defined as follows:

Per-scan all kind of data rate in lowest channel, and found the follow list which it was worst case.

Mode	Data rate
802.11b	1Mbps
802.11g	6Mbps
802.11n(HT20)	6.5Mbps
802.11n(HT40)	13.5Mbps

Final Test Mode:

Operation mode:	Keep the EUT in continuous transmitting with modulation
-----------------	---

1. For WIFI function, the engineering test program was provided and enabled to make EUT continuous transmit/receive.

2. According to ANSI C63.10 standards, the test results are both the "worst case" and "worst setup" 1Mbps for 802.11b, 6Mbps for 802.11g, 6.5Mbps for 802.11n(HT20), 13.5Mbps for 802.11n(HT40).

3. Mode Test Duty Cycle

Mode	Duty Cycle	Duty Cycle Factor (dB)
802.11b	0.99	-0.04
802.11g	0.99	-0.04
802.11n(HT20)	0.99	-0.04
802.11n(HT40)	0.99	-0.04

Test plots as follows:



802.11b



802.11g



802.11n(HT20)



802.11n(HT40)

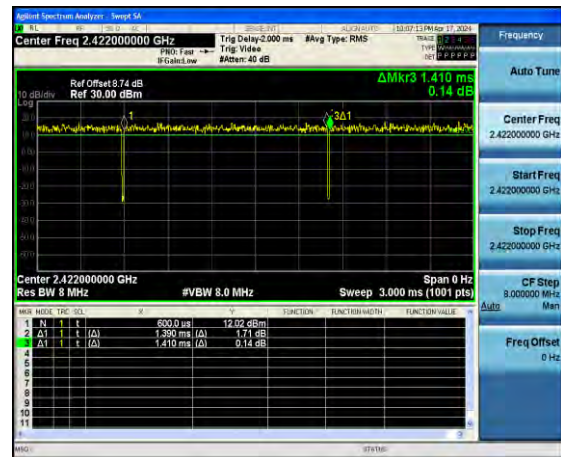



4. Test Results and Measurement Data

4.1. Conducted Emission

Test Specification

Test Requirement:	FCC Part15 C Section 15.207														
Test Method:	ANSI C63.10:2013														
Frequency Range:	150 kHz to 30 MHz														
Receiver setup:	RBW=9 kHz, VBW=30 kHz, Sweep time=auto														
Limits:	<table border="1"> <thead> <tr> <th rowspan="2">Frequency range (MHz)</th> <th colspan="2">Limit (dBuV)</th> </tr> <tr> <th>Quasi-peak</th> <th>Average</th> </tr> </thead> <tbody> <tr> <td>0.15-0.5</td> <td>66 to 56*</td> <td>56 to 46*</td> </tr> <tr> <td>0.5-5</td> <td>56</td> <td>46</td> </tr> <tr> <td>5-30</td> <td>60</td> <td>50</td> </tr> </tbody> </table>	Frequency range (MHz)	Limit (dBuV)		Quasi-peak	Average	0.15-0.5	66 to 56*	56 to 46*	0.5-5	56	46	5-30	60	50
Frequency range (MHz)	Limit (dBuV)														
	Quasi-peak	Average													
0.15-0.5	66 to 56*	56 to 46*													
0.5-5	56	46													
5-30	60	50													
Test Setup:	<p style="text-align: center;">Reference Plane</p> <p style="text-align: center;">40cm</p> <p style="text-align: center;">E.U.T — AC power — 80cm — LISN</p> <p style="text-align: center;">Test table/Insulation plane</p> <p style="text-align: center;">Filter — AC power</p> <p style="text-align: center;">EMI Receiver</p> <p><i>Remark</i> <i>E.U.T: Equipment Under Test</i> <i>LISN: Line Impedance Stabilization Network</i> <i>Test table height=0.8m</i></p>														
Test Mode:	transmitting with modulation														
Test Procedure:	<ol style="list-style-type: none"> 1. The E.U.T is connected to the main power through a line impedance stabilization network (L.I.S.N.). This provides a 50ohm/50uH coupling impedance for the measuring equipment. 2. The peripheral devices are also connected to the main power through a LISN that provides a 50ohm/50uH coupling impedance with 50ohm termination. (Please refer to the block diagram of the test setup and photographs). 3. Both sides of A.C. line are checked for maximum conducted interference. In order to find the maximum emission, the relative positions of equipment and all of the interface cables must be changed according to ANSI C63.10: 2013 on conducted measurement. 														
Test Result:	PASS														



4.2. Test Result

Remark: All the test modes completed for test. only the worst result

Of was reported as below:

Conducted Emission on Line Terminal of the power line (150 kHz to 30MHz)

Test Specification: Line

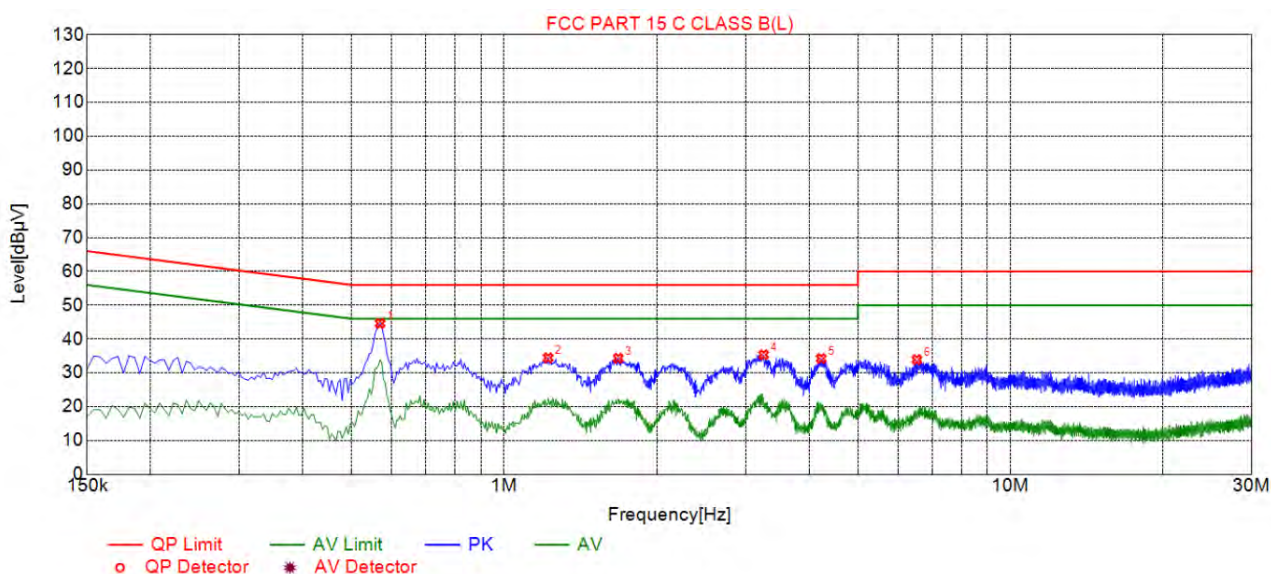

Suspected List								
NO.	Freq. [MHz]	Level [dBµV]	Factor [dB]	Limit [dBµV]	Margin [dB]	Reading [dBµV]	Detector	Type
1	0.5685	44.62	20.13	56.00	11.38	24.49	PK	L
2	1.2210	34.43	20.24	56.00	21.57	14.19	PK	L
3	1.6800	34.32	20.32	56.00	21.68	14.00	PK	L
4	3.2550	35.36	20.60	56.00	20.64	14.76	PK	L
5	4.2315	34.24	20.72	56.00	21.76	13.52	PK	L
6	6.5355	33.91	20.93	60.00	26.09	12.98	PK	L

Remark: Margin = Limit – Level

Correction factor = Cable lose + LISN insertion loss

Level=Test receiver reading + correction factor



Test Specification: Neutral

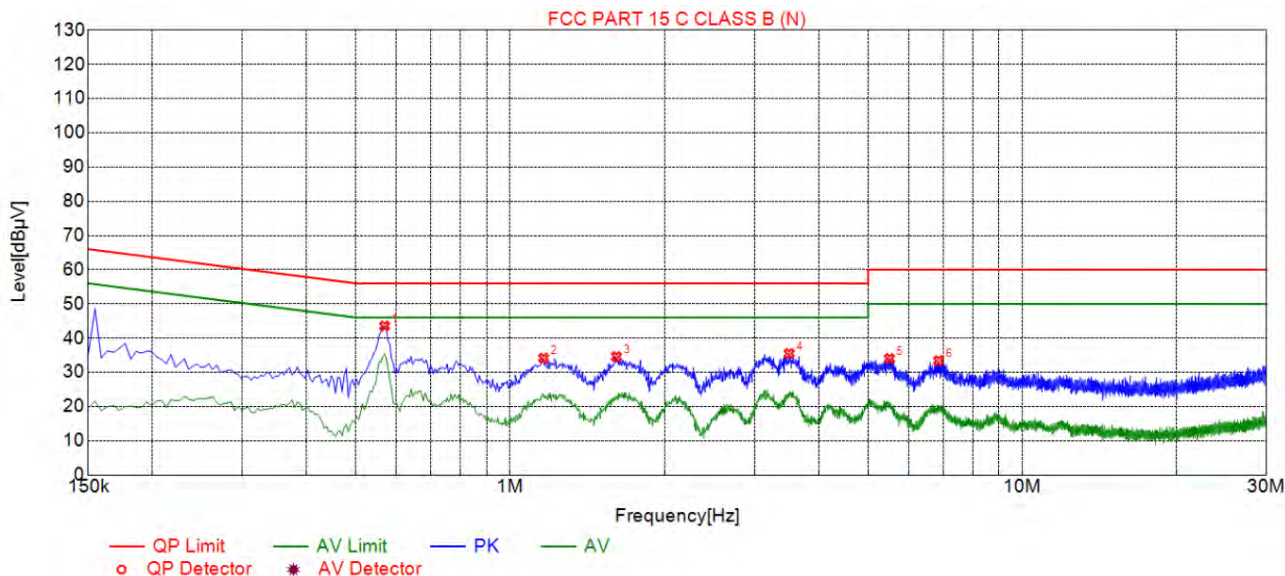

Suspected List

NO.	Freq. [MHz]	Level [dBµV]	Factor [dB]	Limit [dBµV]	Margin [dB]	Reading [dBµV]	Detector	Type
1	0.5685	43.55	20.22	56.00	12.45	23.33	PK	N
2	1.1625	34.13	20.31	56.00	21.87	13.82	PK	N
3	1.6125	34.57	20.37	56.00	21.43	14.20	PK	N
4	3.5070	35.53	20.70	56.00	20.47	14.83	PK	N
5	5.5050	34.00	20.90	60.00	26.00	13.10	PK	N
6	6.8685	33.39	20.97	60.00	26.61	12.42	PK	N

Remark: Margin = Limit – Level

Correction factor = Cable lose + LISN insertion loss

Level=Test receiver reading + correction factor



4.3. Maximum Conducted Output Power

Test Specification

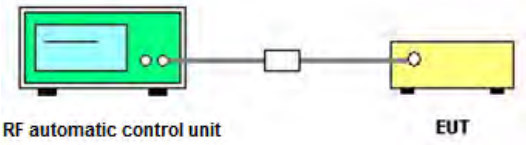
Test Requirement:	FCC Part15 C Section 15.247 (b)(3)
Test Method:	KDB 558074 D01 15.247 Meas Guidance v05r02
Limit:	30dBm
Test Setup:	 <p>The diagram illustrates the test setup. On the left is a green 'RF automatic control unit' with a screen and two ports. A cable connects it to a small white 'attenuator' box. Another cable connects the attenuator to a yellow 'EUT' (Equipment Under Test) box on the right.</p>
Test Mode:	Transmitting mode with modulation
Test Procedure:	<ol style="list-style-type: none"> 1. The testing follows the Measurement Procedure of FCC KDB 558074 D01 15.247 Meas Guidance v05r02. 2. The RF output of EUT was connected to the RF automatic control unit by RF cable and attenuator. The path loss was compensated to the results for each measurement. 3. Set to the maximum power setting and enable the EUT transmit continuously. 4. Measure the Peak output power and record the results in the test report.
Test Result:	PASS

**Test Data**

Mode	Test Channel	Frequency	Maximum Peak Conducted Output Power	LIMIT
		(MHz)	(dBm)	dBm
802.11b	CH01	2412	8.62	30
802.11b	CH06	2437	7.48	30
802.11b	CH11	2462	8.74	30
802.11g	CH01	2412	5.65	30
802.11g	CH06	2437	8.38	30
802.11g	CH11	2462	7.74	30
802.11n(HT20)	CH01	2412	5.45	30
802.11n(HT20)	CH06	2437	6.48	30
802.11n(HT20)	CH11	2462	6.45	30
802.11n(HT40)	CH03	2422	6.34	30
802.11n(HT40)	CH06	2437	6.28	30
802.11n(HT40)	CH09	2452	6.10	30

Note: 1.The test results including the cable lose.



4.4. Emission Bandwidth

Test Specification

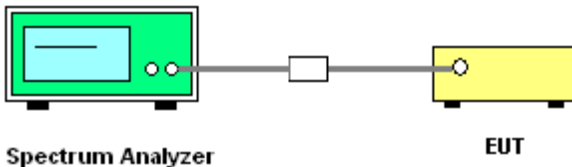
Test Requirement:	FCC Part15 C Section 15.247 (a)(2)
Test Method:	KDB 558074 D01 15.247 Meas Guidance v05r02
Limit:	>500kHz
Test Setup:	 <p>The diagram illustrates the test setup. On the left is a green Spectrum Analyzer. A cable connects it to a small white rectangular component, which is then connected to a yellow EUT (Equipment Under Test) on the right. Labels 'Spectrum Analyzer' and 'EUT' are placed below their respective components.</p>
Test Mode:	Transmitting mode with modulation
Test Procedure:	<ol style="list-style-type: none">1. The testing follows FCC KDB Publication 558074 D01 15.247 Meas Guidance v05r02.2. Set to the maximum power setting and enable the EUT transmit continuously.3. Make the measurement with the spectrum analyzer's resolution bandwidth (RBW) = 100 kHz. Set the Video bandwidth (VBW) = 300 kHz. In order to make an accurate measurement. The 6dB bandwidth must be greater than 500 kHz.4. Measure and record the results in the test report.
Test Result:	PASS

**Test data**

Test channel	6dB Emission Bandwidth (MHz)			
	802.11b	802.11g	802.11n(HT20)	802.11n(HT40)
Lowest	9.52	16.04	16.36	35.04
Middle	9.12	16.28	15.76	33.76
Highest	8.40	15.72	16.28	35.68
Limit:	>500kHz			
Test Result:	PASS			

Test plots as follows:



802.11b Modulation

Lowest channel



Middle channel



Highest channel





802.11g Modulation

Lowest channel



Middle channel

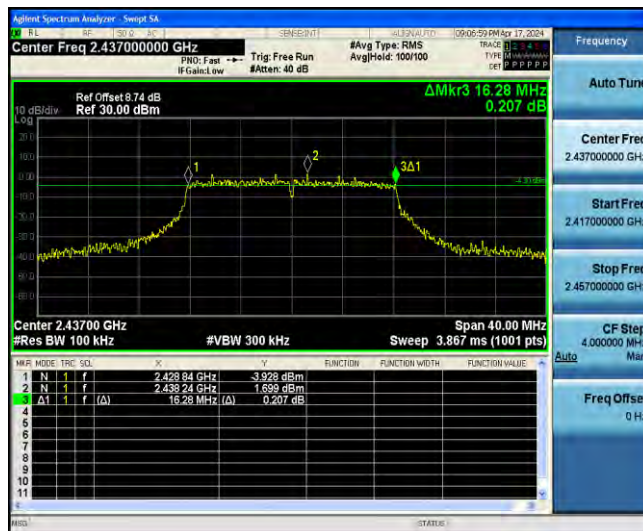

Highest channel





802.11n (HT20) Modulation

Lowest channel



Middle channel



Highest channel





802.11n (HT40) Modulation

Lowest channel



Middle channel



Highest channel





4.5. Power Spectral Density

Test Specification

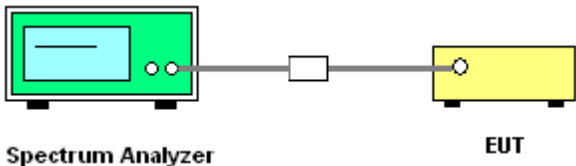
Test Requirement:	FCC Part15 C Section 15.247 (e)
Test Method:	KDB 558074 D01 15.247 Meas Guidance v05r02
Limit:	The average power spectral density shall not be greater than 8dBm in any 3kHz band at any time interval of continuous transmission.
Test Setup:	 <p style="text-align: center;">Spectrum Analyzer EUT</p>
Test Mode:	Transmitting mode with modulation
Test Procedure:	<ol style="list-style-type: none"> 1. The testing follows Measurement procedure 10.2 method PKPSD of FCC KDB Publication 558074 D01 15.247 Meas Guidance v05r02. 2. The RF output of EUT was connected to the spectrum analyzer by RF cable and attenuator. The path loss was compensated to the results for each measurement. 3. Set to the maximum power setting and enable the EUT transmit continuously. 4. Make the measurement with the spectrum analyzer's resolution bandwidth (RBW): $3\text{ kHz} \leq \text{RBW} \leq 100\text{ kHz}$. Video bandwidth $\text{VBW} \geq 3 \times \text{RBW}$. Set the span to at least 1.5 times the OBW. 5. Detector = Peak, Sweep time = auto couple. 6. Employ trace averaging (Peak) mode over a minimum of 100 traces. Use the peak marker function to determine the maximum power level. 7. Measure and record the results in the test report.
Test Result:	PASS



Test data

EUT Set Mode	Channel	Test Result (dBm/30kHz)	Result (dBm/3kHz)
802.11b	Lowest	0.21	-9.79
	Middle	0.76	-9.24
	Highest	0.02	-9.98
802.11g	Lowest	-2.24	-12.24
	Middle	-1.9	-11.9
	Highest	-1.95	-11.95
802.11n(H20)	Lowest	-4.71	-14.71
	Middle	-4.06	-14.06
	Highest	-3.32	-13.32
802.11n(H40)	Lowest	-5.58	-15.58
	Middle	-4.31	-14.31
	Highest	-4.99	-14.99
PSD test result (dBm/3kHz)= PSD test result (dBm/30kHz)-10			
Limit: 8dBm/3kHz			
Test Result:	PASS		

Test plots as follows:



802.11b Modulation

Lowest channel



Middle channel



Highest channel





802.11g Modulation

Lowest channel



Middle channel

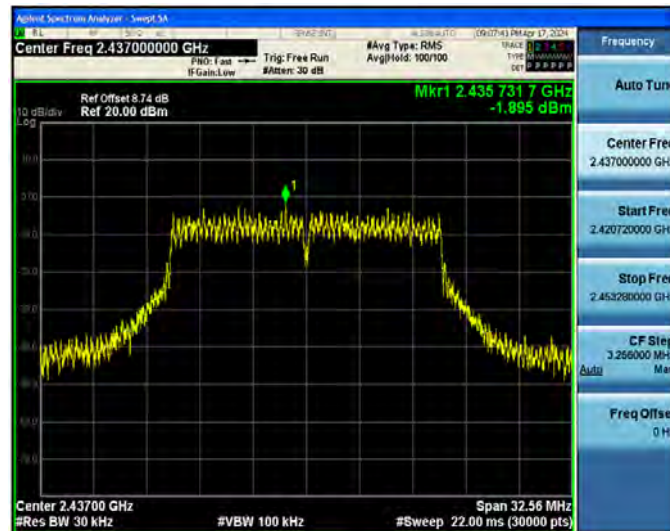

Highest channel

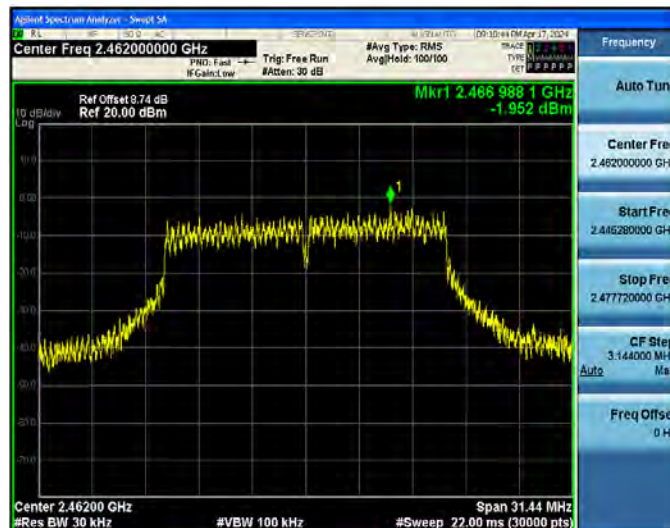



802.11n (HT20) Modulation

Lowest channel

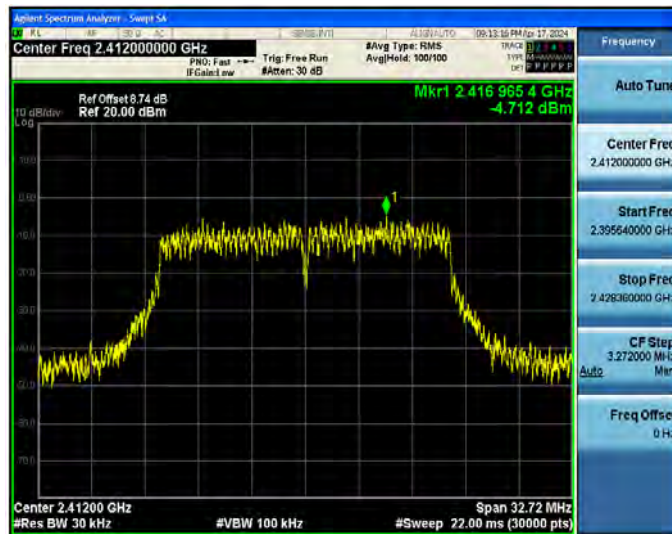

Middle channel

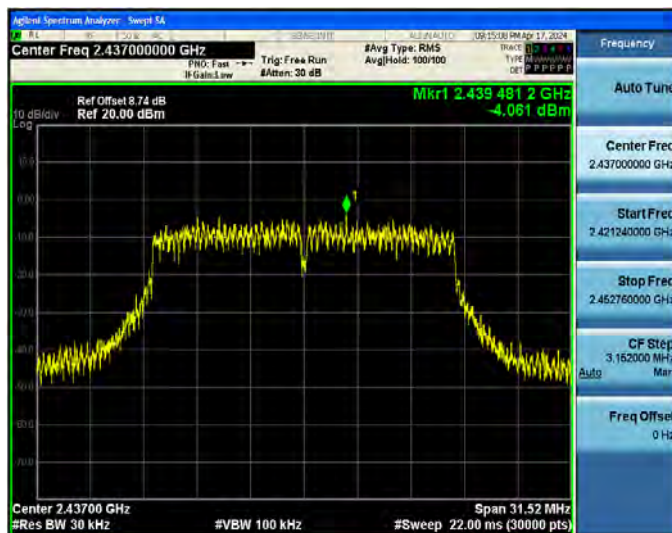

Highest channel





802.11n (HT40) Modulation

Lowest channel



Middle channel



Highest channel

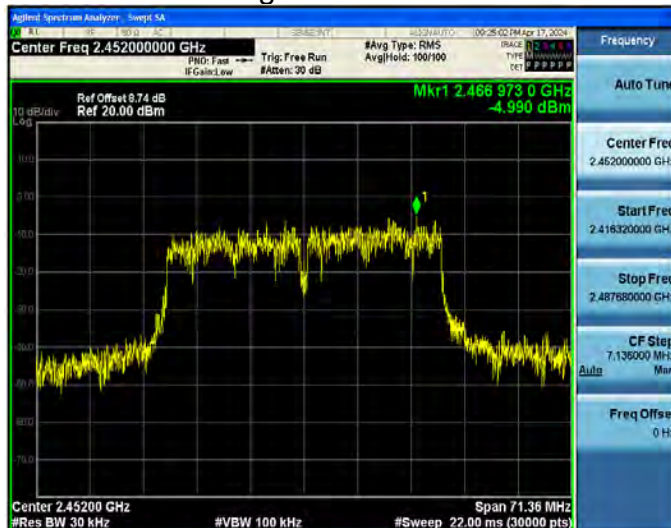



Test Data

802.11b Modulation

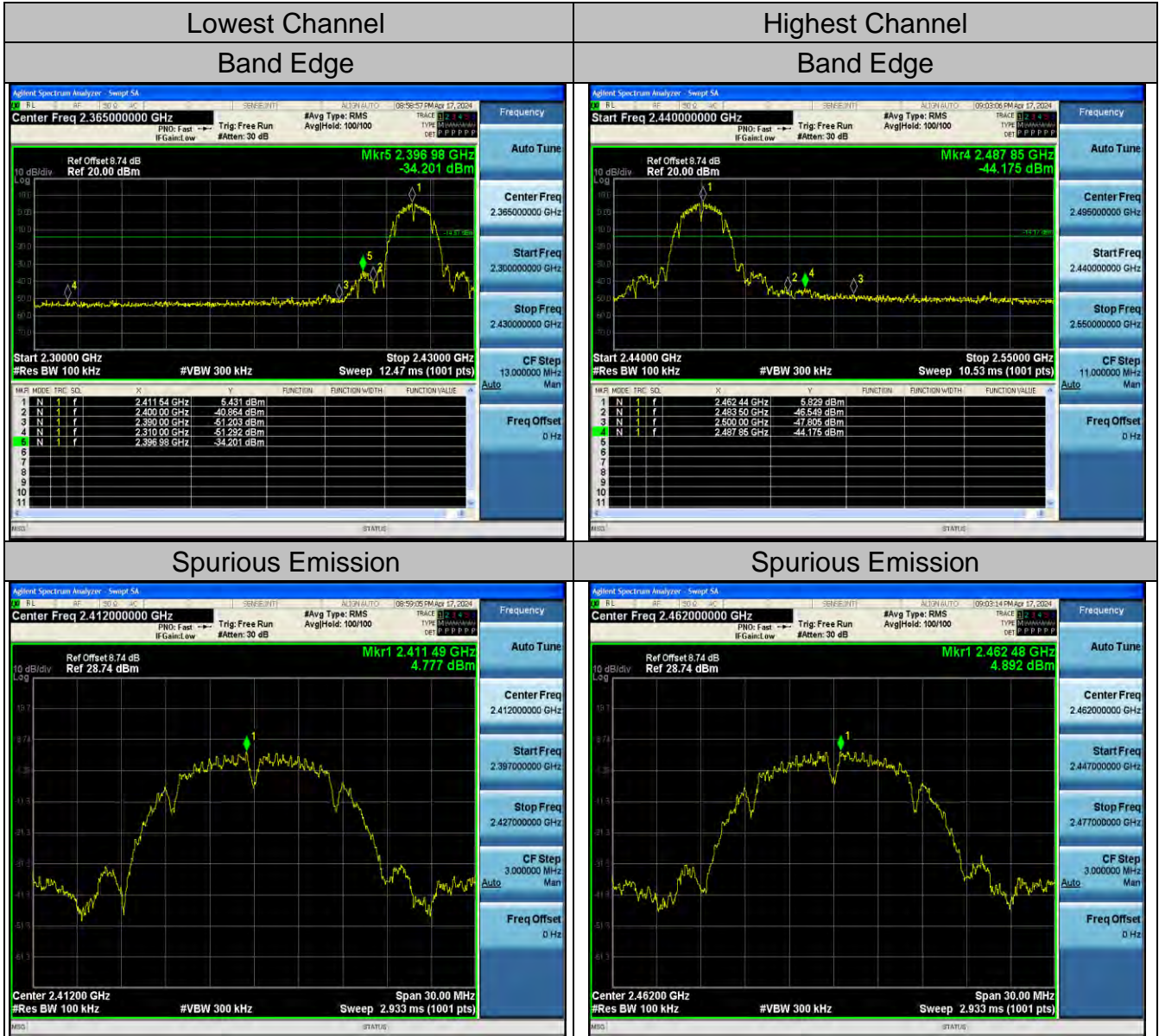

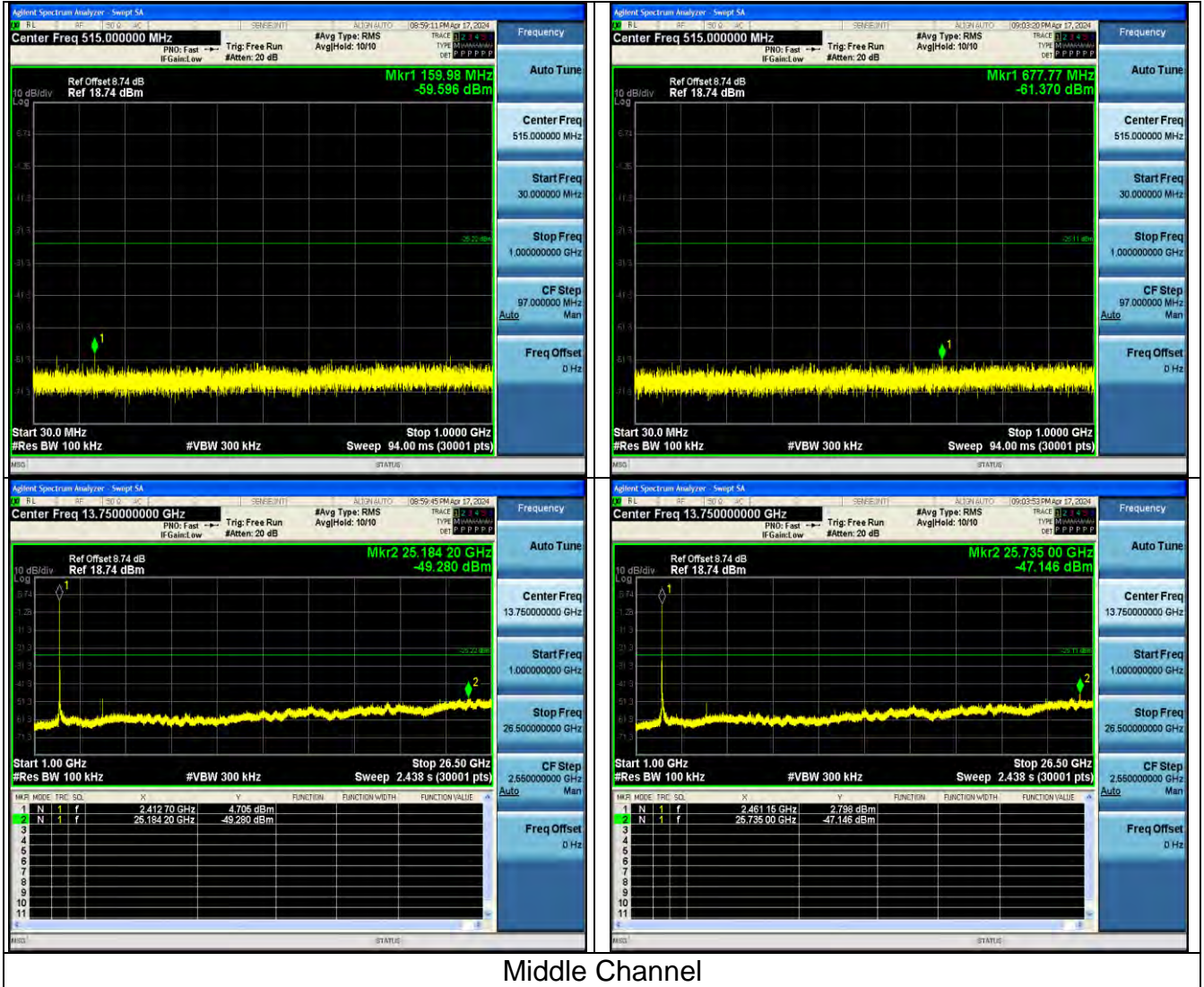

Middle Channel



Spurious Emission

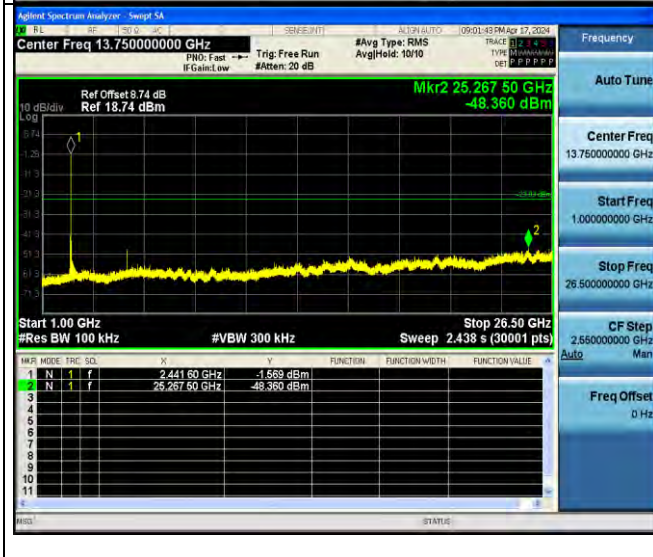
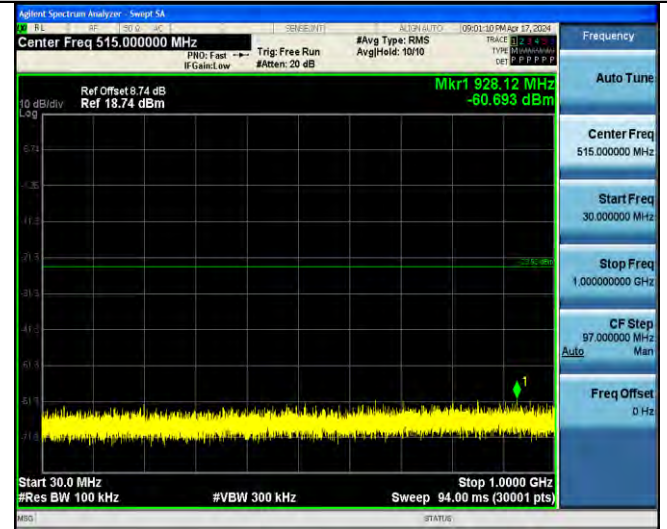



802.11g Modulation

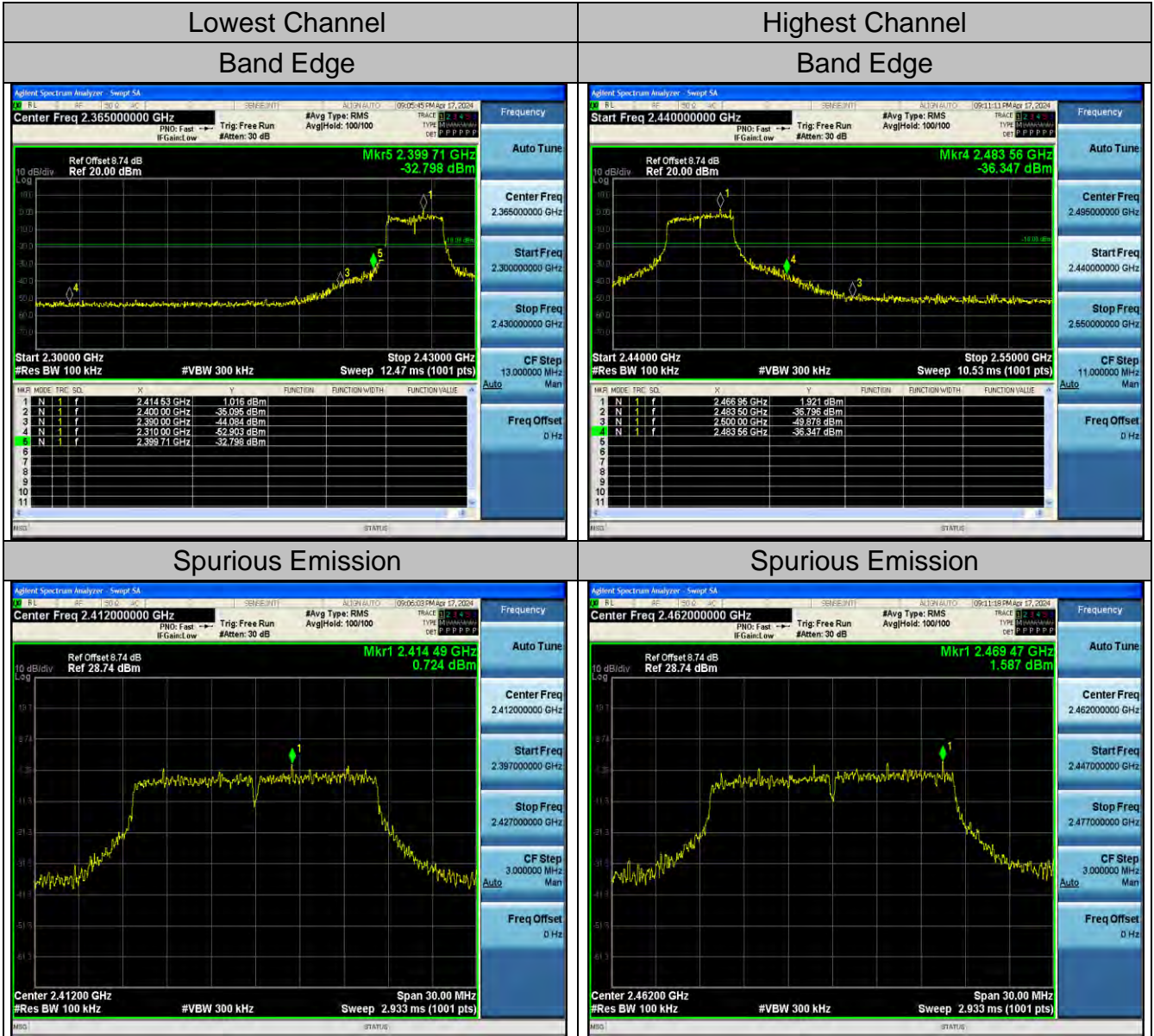

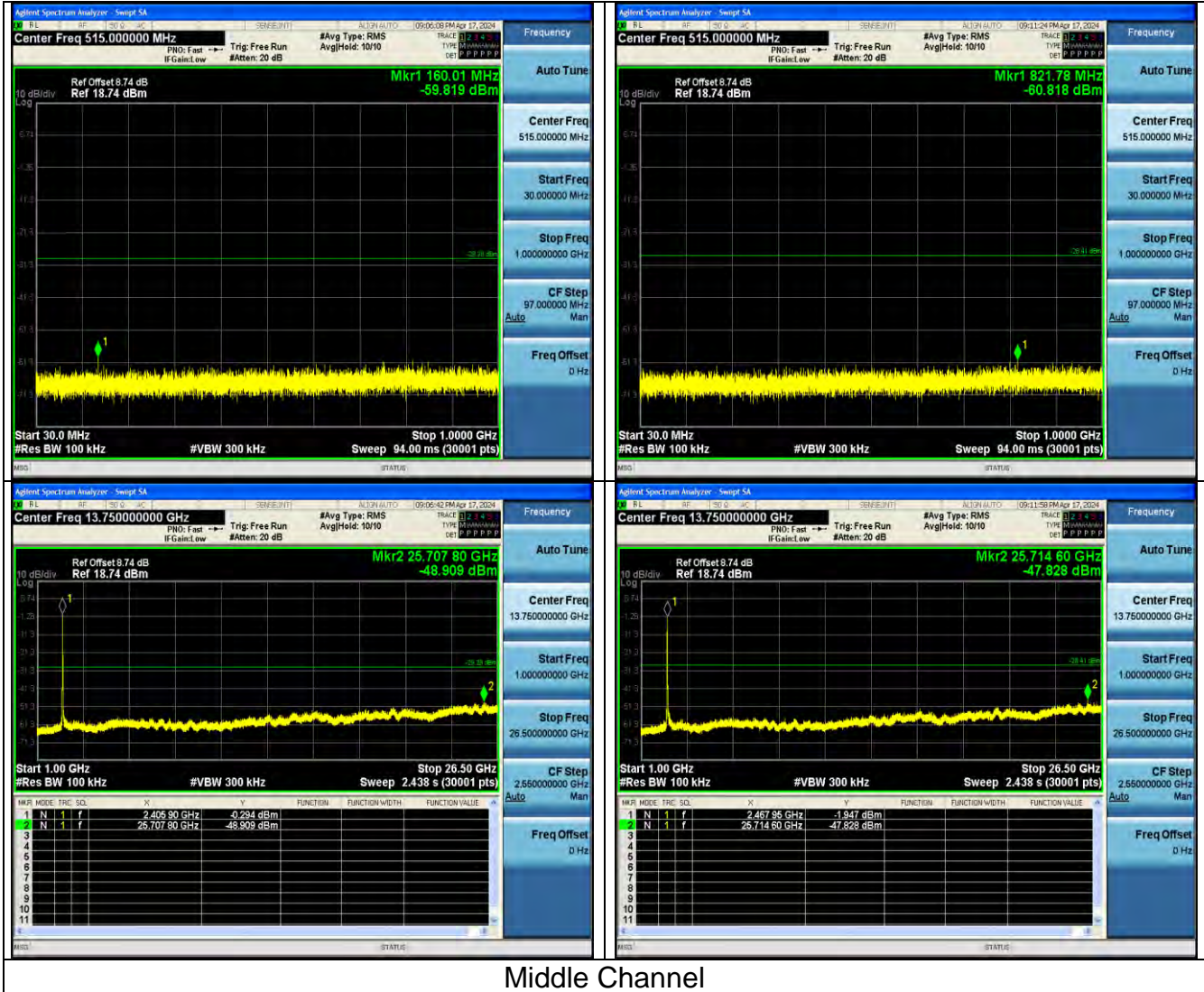

Middle Channel



Spurious Emission





802.11n (HT20) Modulation



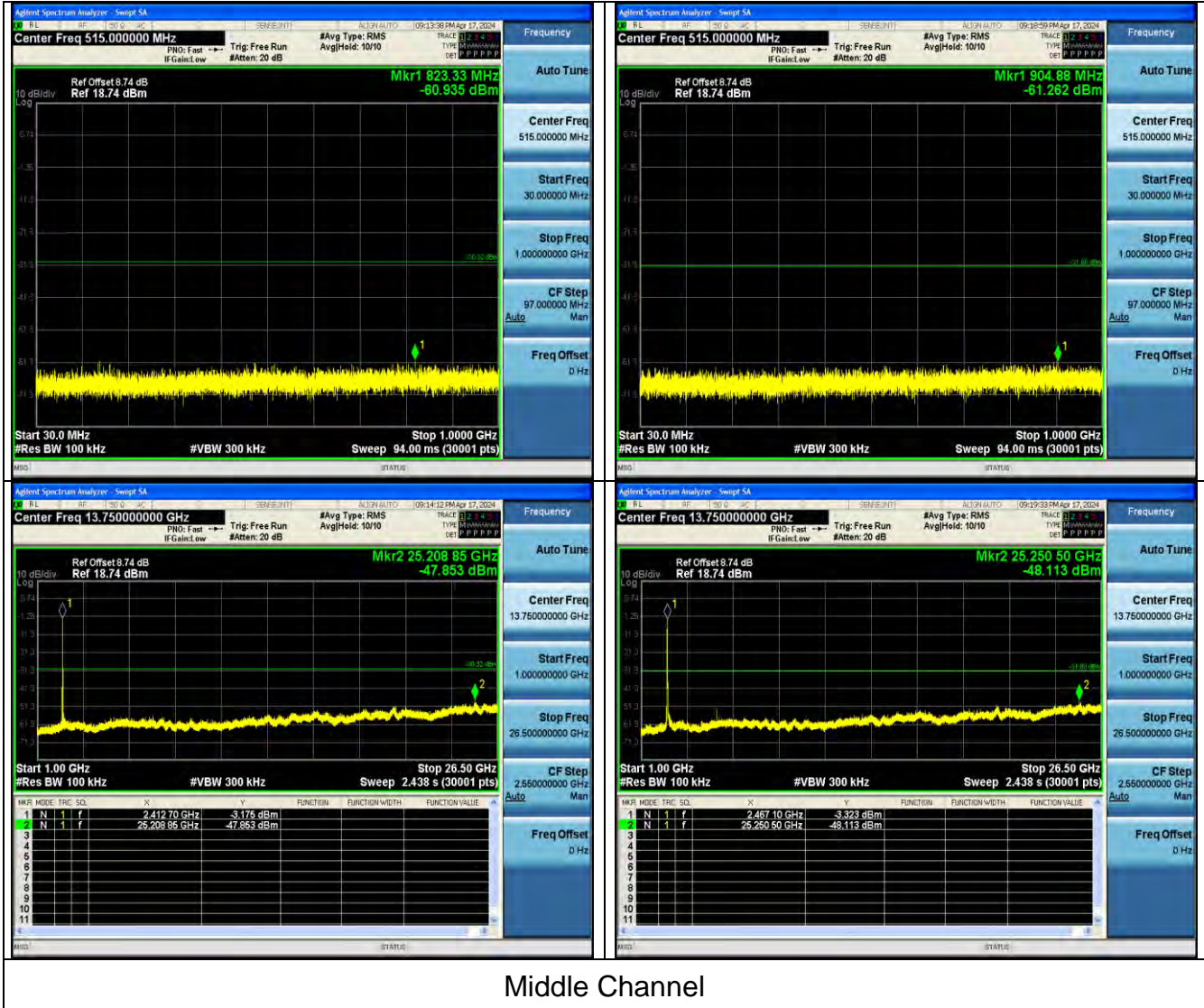

Middle Channel



Spurious Emission

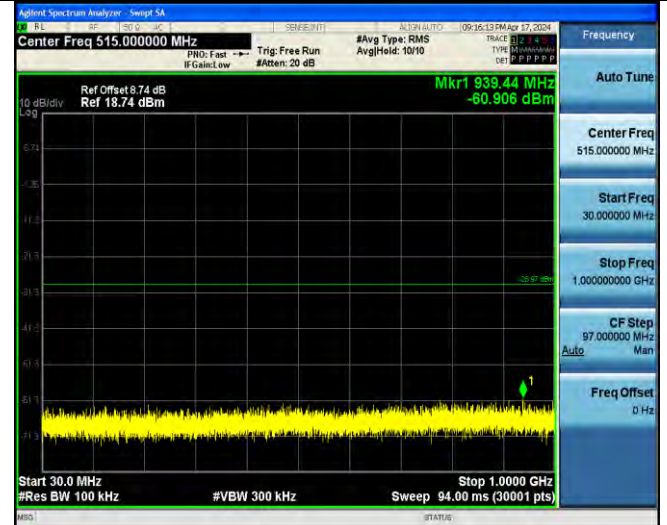



802.11n (HT40) Modulation

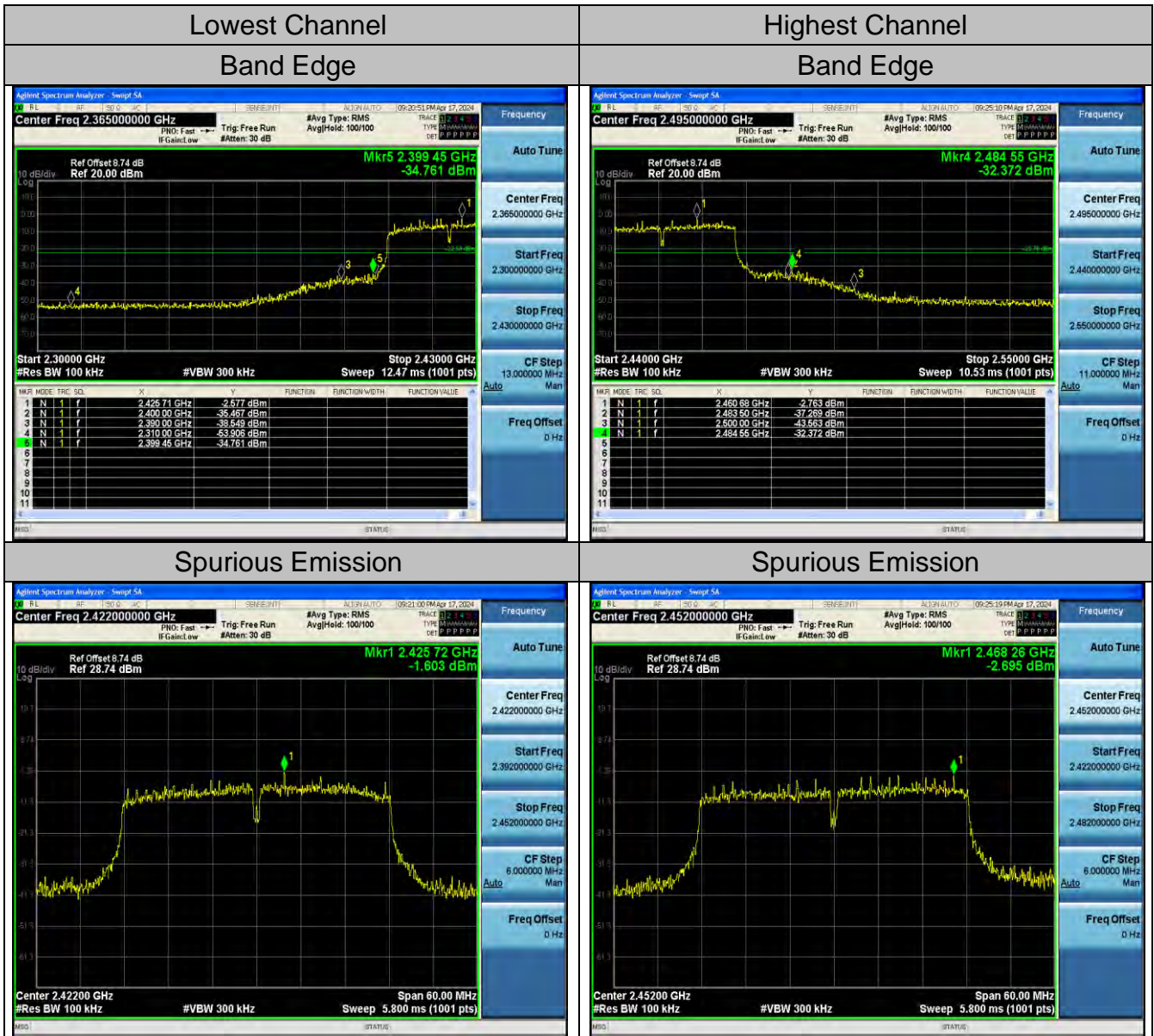

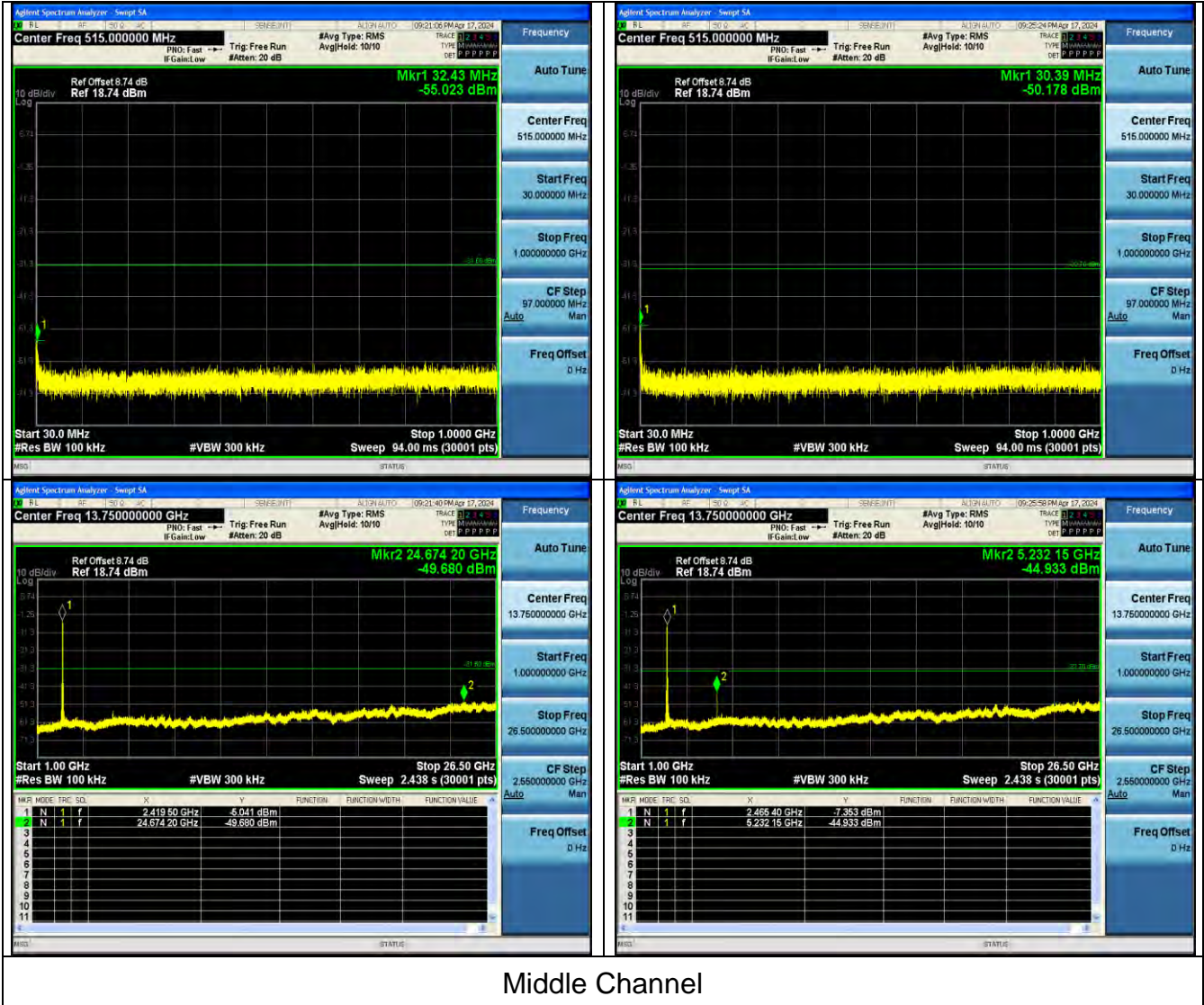

Middle Channel



Spurious Emission

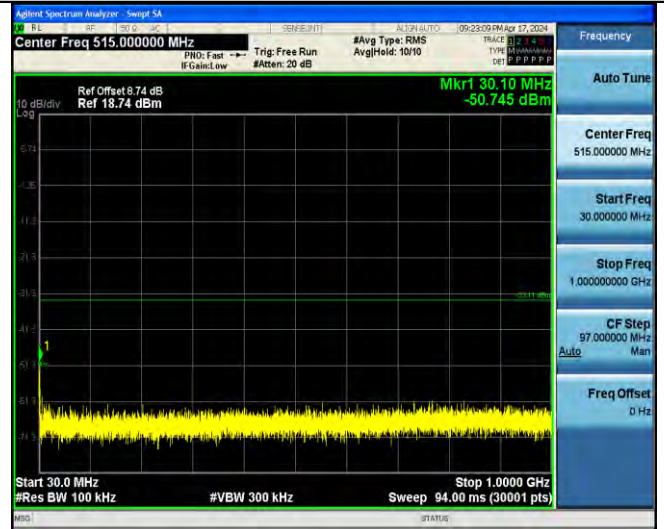



4.7. Radiated Spurious Emission Measurement

Test Specification

Test Requirement:	FCC Part15 C Section 15.209					
Test Method:	ANSI C63.10: 2013					
Frequency Range:	9 kHz to 25 GHz					
Measurement Distance:	3 m					
Antenna Polarization:	Horizontal & Vertical					
Operation mode:	Transmitting mode with modulation					
Receiver Setup:	Frequency	Detector	RBW	VBW	Remark	
	9kHz- 150kHz	Quasi-peak	200Hz	1kHz	Quasi-peak Value	
	150kHz- 30MHz	Quasi-peak	9kHz	30kHz	Quasi-peak Value	
	30MHz-1GHz	Quasi-peak	120KHz	300KHz	Quasi-peak Value	
	Above 1GHz	Peak	1MHz	3MHz	Peak Value	
		Peak	1MHz	10Hz	Average Value	
Limit:	Frequency	Field Strength (microvolts/meter)	Measurement Distance (meters)			
	0.009-0.490	2400/F(KHz)	300			
	0.490-1.705	24000/F(KHz)	30			
	1.705-30	30	30			
	30-88	100	3			
	88-216	150	3			
	216-960	200	3			
	Above 960	500	3			
	Frequency	Field Strength (microvolts/meter)	Measurement Distance (meters)	Detector		
	Above 1GHz	500	3	Average		
	5000	3	Peak			
Test setup:	For radiated emissions below 30MHz					
	30MHz to 1GHz					

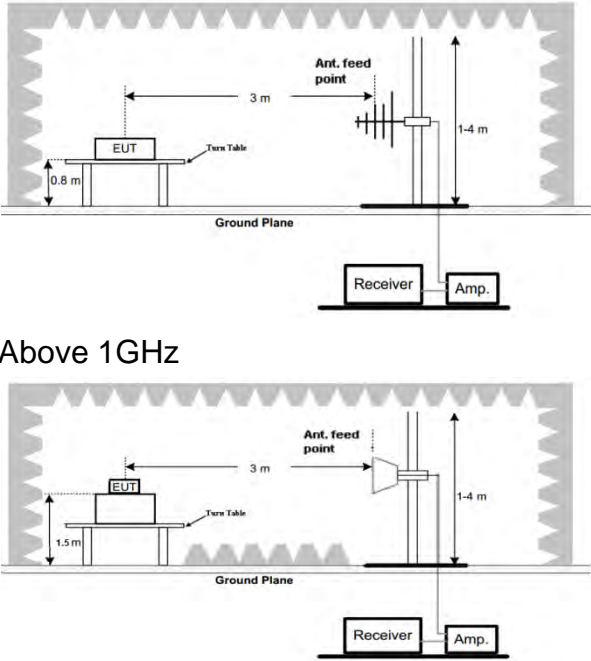
	 <p>Above 1GHz</p>
<p>Test Procedure:</p>	<ol style="list-style-type: none"> 1. For the radiated emission test below 1GHz: The EUT was placed on a turntable with 0.8 meter above ground. The EUT was set 3 meters from the interference receiving antenna, which was mounted on the top of a variable height antenna tower. The EUT was arranged to its worst case and then tune the antenna tower (from 1 m to 4 m) and turntable (from 0 degree to 360 degrees) to find the maximum reading. A pre-amp and a high PASS filter are used for the test in order to get better signal level. 2. For the radiated emission test above 1GHz: Place the measurement antenna on a turntable with 1.5 meter above ground, which is away from each area of the EUT determined to be a source of emissions at the specified measurement distance, while keeping the measurement antenna aimed at the source of emissions at each frequency of significant emissions, with polarization oriented for maximum response. The measurement antenna may have to be higher or lower than the EUT, depending on the radiation pattern of the emission and staying aimed at the emission source for receiving the maximum signal.



	<p>The final measurement antenna elevation shall be that which maximizes the emissions. The measurement antenna elevation for maximum emissions shall be restricted to a range of heights of from 1 m to 4 m above the ground or reference ground plane.</p> <ol style="list-style-type: none">3. Corrected Reading: Antenna Factor + Cable Loss + Read Level - Preamp Factor = Level4. For measurement below 1GHz, If the emission level of the EUT measured by the peak detector is 3 dB lower than the applicable limit, the peak emission level will be reported. Otherwise, the emission measurement will be repeated using the quasi-peak detector and reported.5. Use the following spectrum analyzer settings:<ol style="list-style-type: none">(1) Span shall wide enough to fully capture the emission being measured;(2) Set RBW=120 kHz for $f < 1$ GHz; VBW \geq RBW; Sweep = auto; Detector function = peak; Trace = max hold;(3) Set RBW = 1 MHz, VBW= 3MHz for $f > 1$ GHz for peak measurement.6. For average measurement: VBW = 10 Hz, when duty cycle is no less than 98 percent. VBW $\geq 1/T$, when duty cycle is less than 98 percent where T is the minimum transmission duration over which the transmitter is on and is transmitting at its maximum power control level for the tested mode of operation.
Test results:	PASS



Test Data

All the test modes completed for test. only the worst result of (802.11b at 2412MHz) was reported as below:

Below 1GHz

Horizontal

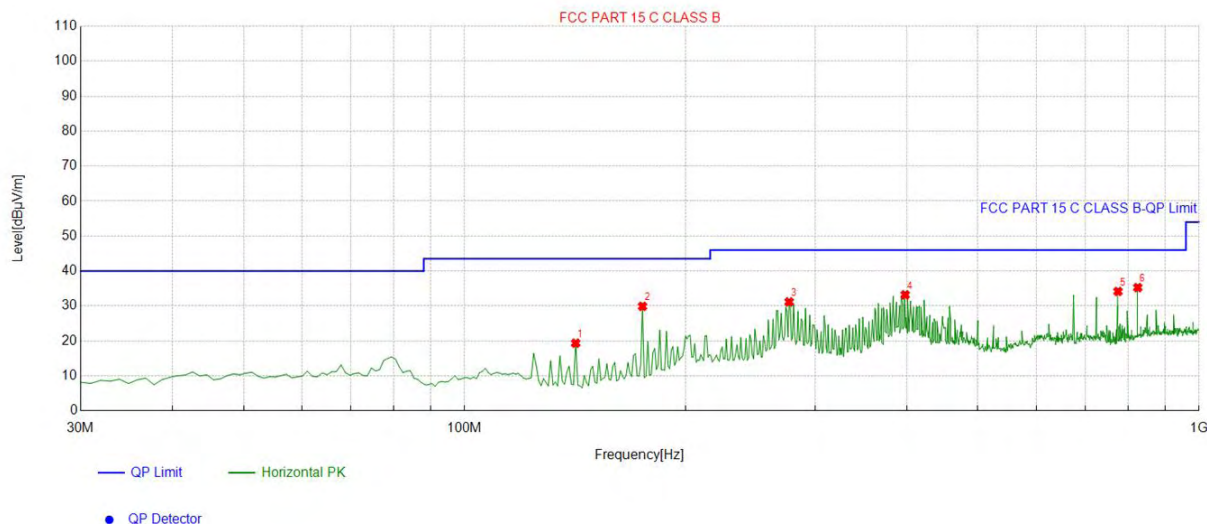

Suspected List									
NO.	Freq. [MHz]	Factor [dB]	Reading [dBµV/m]	Level [dBµV/m]	Limit [dBµV/m]	Margin [dB]	Height [cm]	Angle [°]	Polarity
1	141.66166	-18.38	37.72	19.34	43.50	24.16	100	288	Horizontal
2	174.67467	-16.85	46.74	29.89	43.50	13.61	100	85	Horizontal
3	276.62662	-12.69	43.83	31.14	46.00	14.86	100	312	Horizontal
4	397.99799	-9.55	42.72	33.17	46.00	12.83	100	285	Horizontal
5	775.70570	-4.68	38.82	34.14	46.00	11.86	100	90	Horizontal
6	825.22522	-2.88	38.12	35.24	46.00	10.76	100	85	Horizontal

Remark: Factor = Cable loss + Antenna factor + Attenuator – Preamplifier; Level = Reading + Factor; Margin = Limit – Level



Vertical

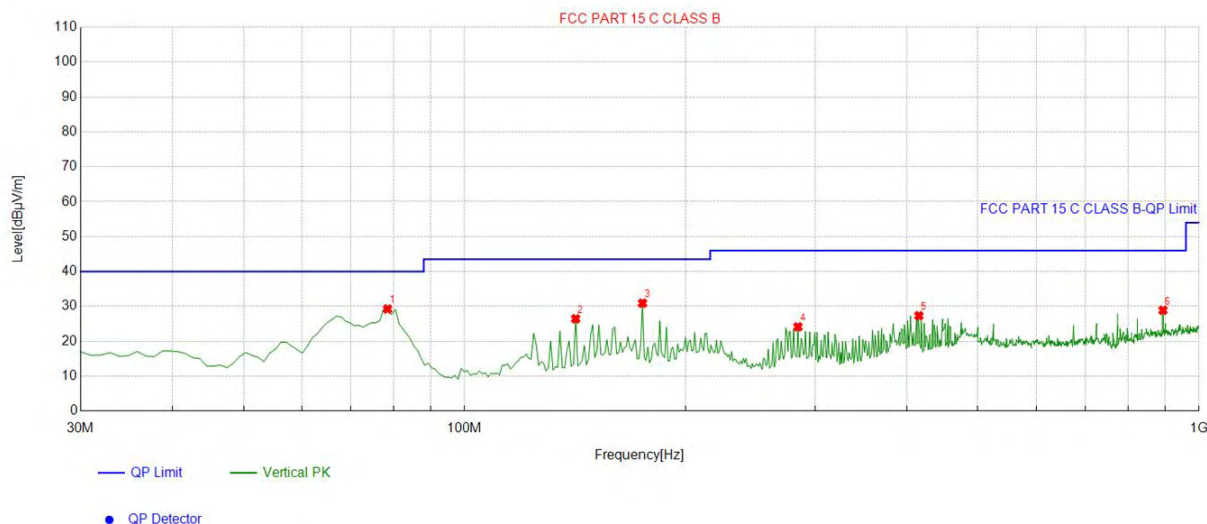

Suspected List									
NO.	Freq. [MHz]	Factor [dB]	Reading [dBµV/m]	Level [dBµV/m]	Limit [dBµV/m]	Margin [dB]	Height [cm]	Angle [°]	Polarity
1	78.548549	-17.92	47.16	29.24	40.00	10.76	100	304	Vertical
2	141.66166	-18.38	44.82	26.44	43.50	17.06	100	44	Vertical
3	174.67467	-16.85	47.76	30.91	43.50	12.59	100	64	Vertical
4	284.39439	-12.50	36.63	24.13	46.00	21.87	100	1	Vertical
5	415.47547	-9.28	36.59	27.31	46.00	18.69	100	56	Vertical
6	893.19319	-1.30	30.19	28.89	46.00	17.11	100	262	Vertical

Remark: Factor = Cable loss + Antenna factor + Attenuator – Preamplifier; Level = Reading + Factor; Margin = Limit – Level

Harmonics and Spurious Emissions

Frequency Range (9kHz-30MHz)

Frequency (MHz)	Level@3m (dBµV/m)	Limit@3m (dBµV/m)
--	--	--
--	--	--
--	--	--
--	--	--

- Note:** 1. Emission Level=Reading+ Cable loss-Antenna factor-Amp factor.
 2. The emission levels are 20 dB below the limit value, which are not reported. It is deemed to comply with the requirement.

**Above 1GHz****Radiated Emission Test**

LOW CH1 (802.11b Mode)/2412

Horizontal:

Frequency	Reading Result	Factor	Emission Level	Limits	Margin	Detector Type
(MHz)	(dB μ V)	(dB)	(dB μ V/m)	(dB μ V/m)	(dB)	
4824	54.26	-3.64	50.62	74	-23.38	peak
4824	42.93	-3.64	39.29	54	-14.71	AVG
7236	51.34	-0.95	50.39	74	-23.61	peak
7236	40.58	-0.95	39.63	54	-14.37	AVG

Remark: Factor = Cable loss + Antenna factor + Attenuator – Pre-amplifier; Level = Reading + Factor; Margin = Level-Limit.

Vertical:

Frequency	Reading Result	Factor	Emission Level	Limits	Margin	Detector Type
(MHz)	(dB μ V)	(dB)	(dB μ V/m)	(dB μ V/m)	(dB)	
4824	53.04	-3.64	49.4	74	-24.6	peak
4824	43.69	-3.64	40.05	54	-13.95	AVG
7236	52.34	-0.95	51.39	74	-22.61	peak
7236	41.62	-0.95	40.67	54	-13.33	AVG

Remark: Factor = Cable loss + Antenna factor + Attenuator – Pre-amplifier; Level = Reading + Factor; Margin = Level-Limit.



MID CH6 (802.11b Mode)/2437

Horizontal:

Frequency (MHz)	Reading Result (dB μ V)	Factor (dB)	Emission Level (dB μ V/m)	Limits (dB μ V/m)	Margin (dB)	Detector Type
4874	53.04	-3.51	49.53	74	-24.47	peak
4874	42.17	-3.51	38.66	54	-15.34	AVG
7311	50.49	-0.82	49.67	74	-24.33	peak
7311	41.23	-0.82	40.41	54	-13.59	AVG

Remark: Factor = Cable loss + Antenna factor + Attenuator – Preamplifier; Level = Reading + Factor; Margin = Level-Limit.

Vertical:

Frequency (MHz)	Reading Result (dB μ V)	Factor (dB)	Emission Level (dB μ V/m)	Limits (dB μ V/m)	Margin (dB)	Detector Type
4874	53.12	-3.51	49.61	74	-24.39	peak
4874	45.06	-3.51	41.55	54	-12.45	AVG
7311	51.17	-0.82	50.35	74	-23.65	peak
7311	42.62	-0.82	41.8	54	-12.2	AVG

Remark: Factor = Cable loss + Antenna factor + Attenuator – Preamplifier; Level = Reading + Factor; Margin = Level-Limit.



HIGH CH11 (802.11b Mode)/2462

Horizontal:

Frequency (MHz)	Reading Result (dBμV)	Factor (dB)	Emission Level (dBμV/m)	Limits (dBμV/m)	Margin (dB)	Detector Type
4924	53.77	-3.43	50.34	74	-23.66	peak
4924	43.54	-3.43	40.11	54	-13.89	AVG
7386	51.26	-0.75	50.51	74	-23.49	peak
7386	40.85	-0.75	40.1	54	-13.9	AVG

Remark: Factor = Cable loss + Antenna factor + Attenuator – Preamplifier; Level = Reading + Factor; Margin = Level-Limit.

Vertical:

Frequency (MHz)	Reading Result (dBμV)	Factor (dB)	Emission Level (dBμV/m)	Limits (dBμV/m)	Margin (dB)	Detector Type
4924	54.09	-3.43	50.66	74	-23.34	peak
4924	45.02	-3.43	41.59	54	-12.41	AVG
7386	52.44	-0.75	51.69	74	-22.31	peak
7386	41.03	-0.75	40.28	54	-13.72	AVG

Remark: Factor = Cable loss + Antenna factor + Attenuator – Preamplifier; Level = Reading + Factor; Margin = Level-Limit.

Remark:

- (1) Measuring frequencies from 1 GHz to the 25 GHz.
- (2) "F" denotes fundamental frequency; "H" denotes spurious frequency; "E" denotes band edge frequency.
- (3) * denotes emission frequency which appearing within the Restricted Bands specified in provision of 15.205, then the general radiated emission limits in 15.209 apply.
- (4) The emissions are attenuated more than 20dB below the permissible limits are not recorded in the report.
- (5) The IF bandwidth of EMI Test Receiver between 30MHz to 1GHz was 120KHz, 1 MHz for measuring above 1 GHz, below 30MHz was 10KHz.
- (6) When the test results of Peak Detected below the limits of Average Detected, the Average Detected is not need completed. For example: Top Channel at Fundamental 73.16dBuV/m(PK Value) <93.98(AV Limit), at harmonic 53.20 dBuV/m(PK Value) <54dBuV/m(AV Limit), the Average Detected not need to completed.



LOW CH1 (802.11g Mode)/2412

Horizontal:

Frequency (MHz)	Reading Result (dB μ V)	Factor (dB)	Emission Level (dB μ V/m)	Limits (dB μ V/m)	Margin (dB)	Detector Type
4824	53.76	-3.64	50.12	74	-23.88	peak
4824	44.19	-3.64	40.55	54	-13.45	AVG
7236	52.88	-0.95	51.93	74	-22.07	peak
7236	41.11	-0.95	40.16	54	-13.84	AVG

Remark: Factor = Cable loss + Antenna factor + Attenuator – Preamplifier; Level = Reading + Factor; Margin = Level-Limit.

Vertical:

Frequency (MHz)	Reading Result (dB μ V)	Factor (dB)	Emission Level (dB μ V/m)	Limits (dB μ V/m)	Margin (dB)	Detector Type
4824	53.11	-3.64	49.47	74	-24.53	peak
4824	43.04	-3.64	39.4	54	-14.6	AVG
7236	51.44	-0.95	50.49	74	-23.51	peak
7236	41.34	-0.95	40.39	54	-13.61	AVG

Remark: Factor = Cable loss + Antenna factor + Attenuator – Preamplifier; Level = Reading + Factor; Margin = Level-Limit.



MID CH6 (802.11g Mode)/2437

Horizontal:

Frequency (MHz)	Reading Result (dB μ V)	Factor (dB)	Emission Level (dB μ V/m)	Limits (dB μ V/m)	Margin (dB)	Detector Type
4874	54.02	-3.51	50.51	74	-23.49	peak
4874	42.46	-3.51	38.95	54	-15.05	AVG
7311	51.34	-0.82	50.52	74	-23.48	peak
7311	40.59	-0.82	39.77	54	-14.23	AVG

Remark: Factor = Cable loss + Antenna factor + Attenuator – Pre-amplifier; Level = Reading + Factor; Margin = Level-Limit.

Vertical:

Frequency (MHz)	Reading Result (dB μ V)	Factor (dB)	Emission Level (dB μ V/m)	Limits (dB μ V/m)	Margin (dB)	Detector Type
4874	53.02	-3.51	49.51	74	-24.49	peak
4874	42.91	-3.51	39.4	54	-14.6	AVG
7311	50.16	-0.82	49.34	74	-24.66	peak
7311	41.21	-0.82	40.39	54	-13.61	AVG

Remark: Factor = Cable loss + Antenna factor + Attenuator – Pre-amplifier; Level = Reading + Factor; Margin = Level-Limit.



HIGH CH11 (802.11g Mode)/2462

Horizontal:

Frequency (MHz)	Reading Result (dBμV)	Factor (dB)	Emission Level (dBμV/m)	Limits (dBμV/m)	Margin (dB)	Detector Type
4924	54.32	-3.43	50.89	74	-23.11	peak
4924	45.98	-3.43	42.55	54	-11.45	AVG
7386	51.87	-0.75	51.12	74	-22.88	peak
7386	43.53	-0.75	42.78	54	-11.22	AVG

Remark: Factor = Cable loss + Antenna factor + Attenuator – Preamplifier; Level = Reading + Factor; Margin = Level-Limit.

Vertical:

Frequency (MHz)	Reading Result (dBμV)	Factor (dB)	Emission Level (dBμV/m)	Limits (dBμV/m)	Margin (dB)	Detector Type
4924	54.22	-3.43	50.79	74	-23.21	peak
4924	42.19	-3.43	38.76	54	-15.24	AVG
7386	51.75	-0.75	51	74	-23	peak
7386	40.17	-0.75	39.42	54	-14.58	AVG

Remark: Factor = Cable loss + Antenna factor + Attenuator – Preamplifier; Level = Reading + Factor; Margin = Level-Limit.

Remark:

- (1) Measuring frequencies from 1 GHz to the 25 GHz.
- (2) "F" denotes fundamental frequency; "H" denotes spurious frequency; "E" denotes band edge frequency.
- (3) * denotes emission frequency which appearing within the Restricted Bands specified in provision of 15.205, then the general radiated emission limits in 15.209 apply.
- (4) The emissions are attenuated more than 20dB below the permissible limits are not recorded in the report.
- (5) The IF bandwidth of EMI Test Receiver between 30MHz to 1GHz was 120KHz, 1 MHz for measuring above 1 GHz, below 30MHz was 10KHz.
- (6) When the test results of Peak Detected below the limits of Average Detected, the Average Detected is not need completed. For example: Top Channel at Fundamental 73.16dBuV/m(PK Value) <93.98(AV Limit), at harmonic 53.20 dBuV/m(PK Value) <54dBuV/m(AV Limit), the Average Detected not need to completed.



LOW CH1 (802.11n/H20 Mode)/2412

Horizontal:

Frequency (MHz)	Reading Result (dB μ V)	Factor (dB)	Emission Level (dB μ V/m)	Limits (dB μ V/m)	Margin (dB)	Detector Type
4824	54.11	-3.64	50.47	74	-23.53	peak
4824	43.16	-3.64	39.52	54	-14.48	AVG
7236	51.42	-0.95	50.47	74	-23.53	peak
7236	42.06	-0.95	41.11	54	-12.89	AVG

Remark: Factor = Cable loss + Antenna factor + Attenuator – Pre-amplifier; Level = Reading + Factor; Margin = Level-Limit.

Vertical:

Frequency (MHz)	Reading Result (dB μ V)	Factor (dB)	Emission Level (dB μ V/m)	Limits (dB μ V/m)	Margin (dB)	Detector Type
4824	52.72	-3.64	49.08	74	-24.92	peak
4824	44.43	-3.64	40.79	54	-13.21	AVG
7236	51.02	-0.95	50.07	74	-23.93	peak
7236	42.54	-0.95	41.59	54	-12.41	AVG

Remark: Factor = Cable loss + Antenna factor + Attenuator – Pre-amplifier; Level = Reading + Factor; Margin = Level-Limit.



MID CH6 (802.11n/H20 Mode)/2437

Horizontal:

Frequency (MHz)	Reading Result (dB μ V)	Factor (dB)	Emission Level (dB μ V/m)	Limits (dB μ V/m)	Margin (dB)	Detector Type
4874	53.21	-3.51	49.70	74.00	-24.30	peak
4874	42.88	-3.51	39.37	54.00	-14.63	AVG
7311	50.69	-0.82	49.87	74.00	-24.13	peak
7311	39.17	-0.82	38.35	54.00	-15.65	AVG

Remark: Factor = Cable loss + Antenna factor + Attenuator – Preamplifier; Level = Reading + Factor; Margin = Level-Limit.

Vertical:

Frequency (MHz)	Reading Result (dB μ V)	Factor (dB)	Emission Level (dB μ V/m)	Limits (dB μ V/m)	Margin (dB)	Detector Type
4874	54.06	-3.51	50.55	74.00	-23.45	peak
4874	43.15	-3.51	39.64	54.00	-14.36	AVG
7311	52.69	-0.82	51.87	74.00	-22.13	peak
7311	41.55	-0.82	40.73	54.00	-13.27	AVG

Remark: Factor = Cable loss + Antenna factor + Attenuator – Preamplifier; Level = Reading + Factor; Margin = Level-Limit.



HIGH CH11 (802.11n/H20 Mode)/2462

Horizontal:

Frequency (MHz)	Reading Result (dB μ V)	Factor (dB)	Emission Level (dB μ V/m)	Limits (dB μ V/m)	Margin (dB)	Detector Type
4924	54.27	-3.43	50.84	74	-23.16	peak
4924	44.19	-3.43	40.76	54	-13.24	AVG
7386	52.06	-0.75	51.31	74	-22.69	peak
7386	41.37	-0.75	40.62	54	-13.38	AVG

Remark: Factor = Cable loss + Antenna factor + Attenuator – Pre-amplifier; Level = Reading + Factor; Margin = Level-Limit.

Vertical:

Frequency (MHz)	Reading Result (dB μ V)	Factor (dB)	Emission Level (dB μ V/m)	Limits (dB μ V/m)	Margin (dB)	Detector Type
4924	53.48	-3.43	50.05	74	-23.95	peak
4924	42.82	-3.43	39.39	54	-14.61	AVG
7386	51.91	-0.75	51.16	74	-22.84	peak
7386	40.86	-0.75	40.11	54	-13.89	AVG

Remark: Factor = Cable loss + Antenna factor + Attenuator – Pre-amplifier; Level = Reading + Factor; Margin = Level-Limit.



LOW CH3 (802.11n/H40 Mode)/2422

Horizontal:

Frequency	Meter Reading	Factor	Emission Level	Limits	Margin	Detector Type
(MHz)	(dBμV)	(dB)	(dBμV/m)	(dBμV/m)	(dB)	
4844	53.53	-3.63	49.9	74	-24.1	peak
4844	41.63	-3.63	38	54	-16	AVG
7266	50.46	-0.94	49.52	74	-24.48	peak
7266	40.06	-0.94	39.12	54	-14.88	AVG

Remark: Factor = Cable loss + Antenna factor + Attenuator – Preamplifier; Level = Reading + Factor; Margin = Level-Limit.

Vertical:

Frequency	Meter Reading	Factor	Emission Level	Limits	Margin	Detector Type
(MHz)	(dBμV)	(dB)	(dBμV/m)	(dBμV/m)	(dB)	
4844	53.76	-3.63	50.13	74	-23.87	peak
4844	42.06	-3.63	38.43	54	-15.57	AVG
7266	50.07	-0.94	49.13	74	-24.87	peak
7266	41.46	-0.94	40.52	54	-13.48	AVG

Remark: Factor = Cable loss + Antenna factor + Attenuator – Preamplifier; Level = Reading + Factor; Margin = Level-Limit.



MID CH6 (802.11n/H40 Mode)/2437

Horizontal:

Frequency	Meter Reading	Factor	Emission Level	Limits	Margin	Detector Type
(MHz)	(dBμV)	(dB)	(dBμV/m)	(dBμV/m)	(dB)	
4874	55.03	-3.51	51.52	74	-22.48	peak
4874	41.02	-3.51	37.51	54	-16.49	AVG
7311	52.02	-0.82	51.2	74	-22.8	peak
7311	40.24	-0.82	39.42	54	-14.58	AVG

Remark: Factor = Cable loss + Antenna factor + Attenuator – Preamplifier; Level = Reading + Factor; Margin = Level-Limit.

Vertical:

Frequency	Meter Reading	Factor	Emission Level	Limits	Margin	Detector Type
(MHz)	(dBμV)	(dB)	(dBμV/m)	(dBμV/m)	(dB)	
4874	53.91	-3.51	50.4	74	-23.6	peak
4874	44.05	-3.51	40.54	54	-13.46	AVG
7311	51.77	-0.82	50.95	74	-23.05	peak
7311	41.76	-0.82	40.94	54	-13.06	AVG

Remark: Factor = Cable loss + Antenna factor + Attenuator – Preamplifier; Level = Reading + Factor; Margin = Level-Limit.



HIGH CH9 (802.11n/H40 Mode)/2452

Horizontal:

Frequency (MHz)	Meter Reading (dBμV)	Factor (dB)	Emission Level (dBμV/m)	Limits (dBμV/m)	Margin (dB)	Detector Type
4904	53.44	-3.43	50.01	74	-23.99	peak
4904	43.38	-3.43	39.95	54	-14.05	AVG
7356	52.62	-0.75	51.87	74	-22.13	peak
7356	42.53	-0.75	41.78	54	-12.22	AVG

Remark: Factor = Cable loss + Antenna factor + Attenuator – Preamplifier; Level = Reading + Factor; Margin = Level-Limit.

Vertical:

Frequency (MHz)	Meter Reading (dBμV)	Factor (dB)	Emission Level (dBμV/m)	Limits (dBμV/m)	Margin (dB)	Detector Type
4904	52.59	-3.43	49.16	74	-24.84	peak
4904	42.67	-3.43	39.24	54	-14.76	AVG
7356	50.82	-0.75	50.07	74	-23.93	peak
7356	40.46	-0.75	39.71	54	-14.29	AVG

Remark: Factor = Cable loss + Antenna factor + Attenuator – Preamplifier; Level = Reading + Factor; Margin = Level-Limit.

Remark:

- (1) Measuring frequencies from 1 GHz to the 25 GHz.
- (2) "F" denotes fundamental frequency; "H" denotes spurious frequency; "E" denotes band edge frequency.
- (3) * denotes emission frequency which appearing within the Restricted Bands specified in provision of 15.205, then the general radiated emission limits in 15.209 apply.
- (4) The emissions are attenuated more than 20dB below the permissible limits are not recorded in the report.
- (5) The IF bandwidth of EMI Test Receiver between 30MHz to 1GHz was 120KHz, 1 MHz for measuring above 1 GHz, below 30MHz was 10KHz.
- (6) When the test results of Peak Detected below the limits of Average Detected, the Average Detected is not need completed. For example: Top Channel at Fundamental 73.16dBuV/m(PK Value) <93.98(AV Limit), at harmonic 53.20 dBuV/m(PK Value) <54 dBuV/m(AV Limit), the Average Detected not need to completed.



Test Result of Radiated Spurious at Band edges

Operation Mode:

802.11b Mode TX CH Low (2412MHz)

Horizontal

Frequency	Reading Result	Factor	Emission Level	Limits	Margin	Detector Type
(MHz)	(dBμV)	(dB)	(dBμV/m)	(dBμV/m)	(dB)	
2310.00	53.06	-5.81	47.25	74	-26.75	peak
2310.00	44.62	-5.81	38.81	54	-15.19	AVG
2390.00	50.61	-5.84	44.77	74	-29.23	peak
2390.00	41.27	-5.84	35.43	54	-18.57	AVG

Remark: Factor = Cable loss + Antenna factor + Attenuator – Preamplifier; Level = Reading + Factor; Margin = Level-Limit.

Vertical:

Frequency	Reading Result	Factor	Emission Level	Limits	Margin	Detector Type
(MHz)	(dBμV)	(dB)	(dBμV/m)	(dBμV/m)	(dB)	
2310.00	52.24	-5.81	46.43	74	-27.57	peak
2310.00	42.15	-5.81	36.34	54	-17.66	AVG
2390.00	50.34	-5.84	44.5	74	-29.5	peak
2390.00	40.29	-5.84	34.45	54	-19.55	AVG

Remark: Factor = Cable loss + Antenna factor + Attenuator – Preamplifier; Level = Reading + Factor; Margin = Level-Limit.



Operation Mode: TX CH High (2462MHz)

Horizontal

Frequency	Reading Result	Factor	Emission Level	Limits	Margin	Detector Type
(MHz)	(dBµV)	(dB)	(dBµV/m)	(dBµV/m)	(dB)	
2483.50	55.32	-5.81	49.51	74	-24.49	peak
2483.50	41.19	-5.81	35.38	54	-18.62	AVG
2500.00	52.14	-6.06	46.08	74	-27.92	peak
2500.00	40.18	-6.06	34.12	54	-19.88	AVG

Remark: Factor = Cable loss + Antenna factor + Attenuator – Preamplifier; Level = Reading + Factor; Margin = Level-Limit.

Vertical:

Frequency	Reading Result	Factor	Emission Level	Limits	Margin	Detector Type
(MHz)	(dBµV)	(dB)	(dBµV/m)	(dBµV/m)	(dB)	
2483.50	53.97	-5.81	48.16	74	-25.84	peak
2483.50	44.13	-5.81	38.32	54	-15.68	AVG
2500.00	51.74	-6.06	45.68	74	-28.32	peak
2500.00	42.05	-6.06	35.99	54	-18.01	AVG

Remark: Factor = Cable loss + Antenna factor + Attenuator – Preamplifier; Level = Reading + Factor; Margin = Level-Limit.

Remark: All the other emissions not reported were too low to read and deemed to comply with FCC limit.



Operation Mode: 802.11g Mode TX CH Low (2412MHz)

Horizontal

Frequency	Reading Result	Factor	Emission Level	Limits	Margin	Detector Type
(MHz)	(dB μ V)	(dB)	(dB μ V/m)	(dB μ V/m)	(dB)	
2310.00	53.87	-5.81	48.06	74	-25.94	peak
2310.00	42.46	-5.81	36.65	54	-17.35	AVG
2390.00	51.03	-5.84	45.19	74	-28.81	peak
2390.00	39.07	-5.84	33.23	54	-20.77	AVG

Remark: Factor = Cable loss + Antenna factor + Attenuator – Preamplifier; Level = Reading + Factor; Margin = Level-Limit.

Vertical:

Frequency	Reading Result	Factor	Emission Level	Limits	Margin	Detector Type
(MHz)	(dB μ V)	(dB)	(dB μ V/m)	(dB μ V/m)	(dB)	
2310.00	53.31	-5.81	47.5	74	-26.5	peak
2310.00	43.69	-5.81	37.88	54	-16.12	AVG
2390.00	50.32	-5.84	44.48	74	-29.52	peak
2390.00	41.87	-5.84	36.03	54	-17.97	AVG

Remark: Factor = Cable loss + Antenna factor + Attenuator – Preamplifier; Level = Reading + Factor; Margin = Level-Limit.



Operation Mode: TX CH High (2462MHz)

Horizontal

Frequency	Reading Result	Factor	Emission Level	Limits	Margin	Detector Type
(MHz)	(dB μ V)	(dB)	(dB μ V/m)	(dB μ V/m)	(dB)	
2483.50	52.56	-5.65	46.91	74	-27.09	peak
2483.50	43.22	-5.65	37.57	54	-16.43	AVG
2500.00	51.47	-5.65	45.82	74	-28.18	peak
2500.00	41.07	-5.65	35.42	54	-18.58	AVG

Remark: Factor = Cable loss + Antenna factor + Attenuator – Preamplifier; Level = Reading + Factor; Margin = Level-Limit.

Vertical:

Frequency	Reading Result	Factor	Emission Level	Limits	Margin	Detector Type
(MHz)	(dB μ V)	(dB)	(dB μ V/m)	(dB μ V/m)	(dB)	
2483.50	54.05	-5.65	48.4	74	-25.6	peak
2483.50	41.55	-5.65	35.9	54	-18.1	AVG
2500.00	51.69	-5.65	46.04	74	-27.96	peak
2500.00	40.03	-5.65	34.38	54	-19.62	AVG

Remark: Factor = Cable loss + Antenna factor + Attenuator – Preamplifier; Level = Reading + Factor; Margin = Level-Limit.

Remark: All the other emissions not reported were too low to read and deemed to comply with FCC limit.



Operation Mode: 802.11n/H20 Mode TX CH Low (2412MHz)

Horizontal

Frequency	Reading Result	Factor	Emission Level	Limits	Margin	Detector Type
(MHz)	(dB μ V)	(dB)	(dB μ V/m)	(dB μ V/m)	(dB)	
2310.00	54.33	-5.81	48.52	74	-25.48	peak
2310.00	43.09	-5.81	37.28	54	-16.72	AVG
2390.00	50.83	-5.84	44.99	74	-29.01	peak
2390.00	41.32	-5.84	35.48	54	-18.52	AVG

Remark: Factor = Cable loss + Antenna factor + Attenuator – Preamplifier; Level = Reading + Factor; Margin = Level-Limit.

Vertical:

Frequency	Reading Result	Factor	Emission Level	Limits	Margin	Detector Type
(MHz)	(dB μ V)	(dB)	(dB μ V/m)	(dB μ V/m)	(dB)	
2310.00	53.17	-5.81	47.36	74	-26.64	peak
2310.00	41.33	-5.81	35.52	54	-18.48	AVG
2390.00	52.04	-5.84	46.2	74	-27.8	peak
2390.00	39.88	-5.84	34.04	54	-19.96	AVG

Remark: Factor = Cable loss + Antenna factor + Attenuator – Preamplifier; Level = Reading + Factor; Margin = Level-Limit.



Operation Mode: TX CH High (2462MHz)

Horizontal

Frequency	Reading Result	Factor	Emission Level	Limits	Margin	Detector Type
(MHz)	(dB μ V)	(dB)	(dB μ V/m)	(dB μ V/m)	(dB)	
2483.50	54.13	-5.65	48.48	74	-25.52	peak
2483.50	43.56	-5.65	37.91	54	-16.09	AVG
2500.00	52.26	-5.65	46.61	74	-27.39	peak
2500.00	41.08	-5.65	35.43	54	-18.57	AVG

Remark: Factor = Cable loss + Antenna factor + Attenuator – Preamplifier; Level = Reading + Factor; Margin = Level-Limit.

Vertical:

Frequency	Reading Result	Factor	Emission Level	Limits	Margin	Detector Type
(MHz)	(dB μ V)	(dB)	(dB μ V/m)	(dB μ V/m)	(dB)	
2483.50	55.12	-5.65	49.47	74	-24.53	peak
2483.50	43.81	-5.65	38.16	54	-15.84	AVG
2500.00	52.14	-5.65	46.49	74	-27.51	peak
2500.00	42.85	-5.65	37.2	54	-16.8	AVG

Remark: Factor = Cable loss + Antenna factor + Attenuator – Preamplifier; Level = Reading + Factor; Margin = Level-Limit.

Remark: All the other emissions not reported were too low to read and deemed to comply with FCC limit.



Operation Mode: 802.11n/H40 Mode TX CH Low (2422MHz)

Horizontal

Frequency	Reading Result	Factor	Emission Level	Limits	Margin	Detector Type
(MHz)	(dBμV)	(dB)	(dBμV/m)	(dBμV/m)	(dB)	
2310.00	56.21	-5.81	50.4	74	-23.6	peak
2310.00	/	-5.81	/	54	/	AVG
2390.00	54.13	-5.84	48.29	74	-25.71	peak
2390.00	/	-5.84	/	54	/	AVG

Remark: Factor = Cable loss + Antenna factor + Attenuator – Preamplifier; Level = Reading + Factor; Margin = Level-Limit.

Vertical:

Frequency	Reading Result	Factor	Emission Level	Limits	Margin	Detector Type
(MHz)	(dBμV)	(dB)	(dBμV/m)	(dBμV/m)	(dB)	
2310.00	54.36	-5.81	48.55	74	-25.45	peak
2310.00	/	-5.81	/	54	/	AVG
2390.00	52.77	-5.84	46.93	74	-27.07	peak
2390.00	/	-5.84	/	54	/	AVG

Remark: Factor = Cable loss + Antenna factor + Attenuator – Preamplifier; Level = Reading + Factor; Margin = Level-Limit.



Operation Mode: TX CH High (2452MHz)

Horizontal

Frequency	Reading Result	Factor	Emission Level	Limits	Margin	Detector Type
(MHz)	(dBμV)	(dB)	(dBμV/m)	(dBμV/m)	(dB)	
2483.50	55.13	-5.65	49.48	74	-24.52	peak
2483.50	/	-5.65	/	54	/	AVG
2500.00	54.76	-5.65	49.11	74	-24.89	peak
2500.00	/	-5.65	/	54	/	AVG

Remark: Factor = Cable loss + Antenna factor + Attenuator – Preamplifier; Level = Reading + Factor; Margin = Level-Limit.

Vertical:

Frequency	Reading Result	Factor	Emission Level	Limits	Margin	Detector Type
(MHz)	(dBμV)	(dB)	(dBμV/m)	(dBμV/m)	(dB)	
2483.50	53.49	-5.65	47.84	74	-26.16	peak
2483.50	/	-5.65	/	54	/	AVG
2500.00	52.88	-5.65	47.23	74	-26.77	peak
2500.00	/	-5.65	/	54	/	AVG

Remark: Factor = Cable loss + Antenna factor + Attenuator – Preamplifier; Level = Reading + Factor; Margin = Level-Limit.

Remark: All the other emissions not reported were too low to read and deemed to comply with FCC limit.

Remark:

1. If the PK measured levels comply with average limit, then the average level were deemed to comply with average limit.
2. In restricted bands of operation, the spurious emissions below the permissible value more than 20dB.
3. The amplitude of spurious emissions which are attenuated by more than 20dB below the permissible value has no need to be reported.



4.8. Antenna Requirement

Standard Applicable

For intentional device, according to FCC 47 CFR Section 15.203, an intentional radiator shall be designed to ensure that no antenna other than that furnished by the responsible party shall be used with the device. And according to FCC 47 CFR Section 15.247, if transmitting antennas of directional gain greater than 6dBi are used, the power shall be reduced by the amount in dB that the directional gain of the antenna exceeds 6dBi.

Refer to statement below for compliance.

The manufacturer may design the unit so that the user can replace a broken antenna, but the use of a standard antenna jack or electrical connector is prohibited. Further, this requirement does not apply to intentional radiators that must be professionally installed.

Antenna Connected Construction

The antenna used in this product is a Iron sheet antenna, which permanently attached. It conforms to the standard requirements. The directional gains of antenna used for transmitting is 1.94dBi.

Antenna

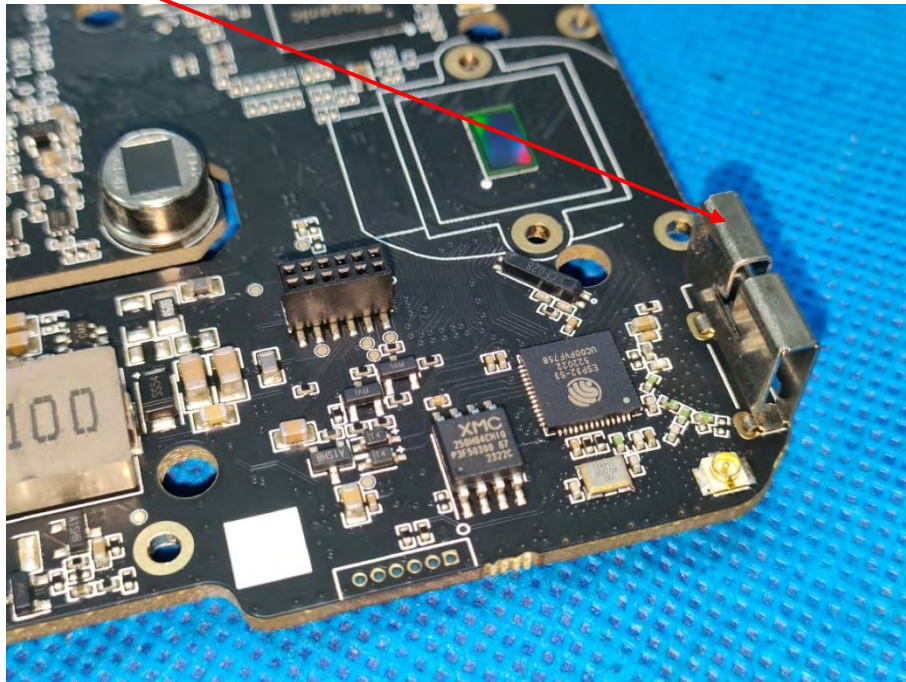



5. Photograph of Test

Radiated Emissions





Conducted Emission





6. Photos of the EUT

Reference to the report: ANNEX A of external photos and ANNEX B of internal photos.

-----End of test report-----