

FCC Test Report (BT LE)

Report No.: RFBHKO-WTW-P21110131-3

FCC ID: 2AUS4-NFF1

Test Model: NF-F1

Received Date: 2021/11/3

Test Date: 2021/11/17 ~ 2021/11/27

Issued Date: 2021/12/15

Applicant: Neatframe AS

Address: Martin Linges vei 25 Fornebu 1364 Norway

Issued By: Bureau Veritas Consumer Products Services (H.K.) Ltd., Taoyuan Branch
Lin Kou Laboratories

Lab Address: No. 47-2, 14th Ling, Chia Pau Vil., Lin Kou Dist., New Taipei City, Taiwan

**FCC Registration /
Designation Number:** 198487 / TW2021



This report is for your exclusive use. Any copying or replication of this report to or for any other person or entity, or use of our name or trademark, is permitted only with our prior written permission. This report sets forth our findings solely with respect to the test samples identified herein. The results set forth in this report are not indicative or representative of the quality or characteristics of the lot from which a test sample was taken or any similar or identical product unless specifically and expressly noted. Our report includes all of the tests requested by you and the results thereof based upon the information that you provided to us. You have 60 days from date of issuance of this report to notify us of any material error or omission caused by our negligence, provided, however, that such notice shall be in writing and shall specifically address the issue you wish to raise. A failure to raise such issue within the prescribed time shall constitute your unqualified acceptance of the completeness of this report, the tests conducted and the correctness of the report contents. Unless specific mention, the uncertainty of measurement has been explicitly taken into account to declare the compliance or non-compliance to the specification.

Table of Contents

Release Control Record	4
1 Certificate of Conformity	5
2 Summary of Test Results	6
2.1 Measurement Uncertainty	6
2.2 Modification Record	6
3 General Information	7
3.1 General Description of EUT	7
3.2 Description of Test Modes	8
3.2.1 Test Mode Applicability and Tested Channel Detail	9
3.3 Duty Cycle of Test Signal	10
3.4 Description of Support Units	11
3.4.1 Configuration of System under Test	11
3.5 General Description of Applied Standards and references	12
4 Test Types and Results	13
4.1 Radiated Emission and Bandedge Measurement.....	13
4.1.1 Limits of Radiated Emission and Bandedge Measurement	13
4.1.2 Test Instruments	14
4.1.3 Test Procedures.....	15
4.1.4 Deviation from Test Standard	15
4.1.5 Test Setup.....	16
4.1.6 EUT Operating Conditions.....	17
4.1.7 Test Results	18
4.2 Conducted Emission Measurement	26
4.2.1 Limits of Conducted Emission Measurement	26
4.2.2 Test Instruments	26
4.2.3 Test Procedures.....	27
4.2.4 Deviation From Test Standard	27
4.2.5 Test Setup.....	27
4.2.6 EUT Operating Condition	27
4.2.7 Test Results	28
4.3 6dB Bandwidth Measurement	30
4.3.1 Limits of 6dB Bandwidth Measurement	30
4.3.2 Test Setup.....	30
4.3.3 Test Instruments	30
4.3.4 Test Procedure	30
4.3.5 Deviation from Test Standard	30
4.3.6 EUT Operating Conditions.....	30
4.3.7 Test Result	31
4.4 Conducted Output Power Measurement.....	32
4.4.1 Limits OF Conducted Output Power Measurement	32
4.4.2 Test Setup.....	32
4.4.3 Test Instruments	32
4.4.4 Test Procedures.....	32
4.4.5 Deviation from Test Standard	32
4.4.6 EUT Operating Conditions.....	32
4.4.7 Test Results	33
4.5 Power Spectral Density Measurement.....	34
4.5.1 Limits of Power Spectral Density Measurement	34
4.5.2 Test Setup.....	34
4.5.3 Test Instruments	34
4.5.4 Test Procedure	34
4.5.5 Deviation from Test Standard	34

4.5.6 EUT Operating Condition	34
4.5.7 Test Results	35
4.6 Conducted Out of Band Emission Measurement	36
4.6.1 Limits of Conducted Out of Band Emission Measurement.....	36
4.6.2 Test Setup.....	36
4.6.3 Test Instruments	36
4.6.4 Test Procedure	36
4.6.5 Deviation from Test Standard	36
4.6.6 EUT Operating Condition	36
4.6.7 Test Results	36
Annex A- Band Edge Measurement	39
5 Pictures of Test Arrangements.....	41
Appendix – Information of the Testing Laboratories	42

Release Control Record

Issue No.	Description	Date Issued
RFBHKO-WTW-P21110131-3	Original release.	2021/12/15

1 Certificate of Conformity

Product: Video conferencing device

Brand: neat.

Test Model: NF-F1

Sample Status: Engineering sample

Applicant: Neatframe AS

Test Date: 2021/11/17 ~ 2021/11/27

Standards: 47 CFR FCC Part 15, Subpart C (Section 15.247)
ANSI C63.10: 2013

The above equipment has been tested by **Bureau Veritas Consumer Products Services (H.K.) Ltd., Taoyuan Branch**, and found compliance with the requirement of the above standards. The test record, data evaluation & Equipment Under Test (EUT) configurations represented herein are true and accurate accounts of the measurements of the sample's RF characteristics under the conditions specified in this report.

Prepared by :



Date:

2021/12/15

Jessica Cheng / Senior Specialist

Approved by :



Date:

2021/12/15

Jeremy Lin / Project Engineer

2 Summary of Test Results

47 CFR FCC Part 15, Subpart C (SECTION 15.247)			
FCC Clause	Test Item	Result	Remarks
15.207	AC Power Conducted Emission	Pass	Meet the requirement of limit. Minimum passing margin is -3.27dB at 0.59600MHz.
15.205 & 209 & 15.247(d)	Radiated Emissions & Band Edge Measurement	PASS	Meet the requirement of limit. Minimum passing margin is -8.40dB at 31.75MHz.
15.247(d)	Antenna Port Emission	PASS	Meet the requirement of limit.
15.247(a)(2)	6dB bandwidth	PASS	Meet the requirement of limit.
15.247(b)	Conducted power	PASS	Meet the requirement of limit.
15.247(e)	Power Spectral Density	PASS	Meet the requirement of limit.
15.203	Antenna Requirement	PASS	Antenna connector is ipex not a standard connector.

Note:

- For 2.4GHz band compliance with rule 15.247(d) of the band-edge items, the test plots were recorded in Annex A. Test Procedures refer to report 4.1.3.
- Determining compliance based on the results of the compliance measurement, not taking into account measurement instrumentation uncertainty.

2.1 Measurement Uncertainty

Where relevant, the following measurement uncertainty levels have been estimated for tests performed on the EUT as specified in CISPR 16-4-2:

Measurement	Frequency	Expanded Uncertainty (k=2) (\pm)
Conducted Emissions at mains ports	150kHz ~ 30MHz	3.00 dB
Conducted Emissions	9kHz ~ 40GHz	2.63 dB
Radiated Emissions up to 1 GHz	9kHz ~ 30MHz	2.38 dB
	30MHz ~ 1GHz	5.70 dB
Radiated Emissions above 1 GHz	Above 1GHz	5.21 dB

2.2 Modification Record

There were no modifications required for compliance.

3 General Information

3.1 General Description of EUT

Product	Video conferencing device
Brand	neat.
Test Model	NF-F1
Status of EUT	Engineering sample
Power Supply Rating	AC Input: 100-240V~ 50/60Hz, 2.5A
Modulation Type	GFSK
Transfer Rate	Up to 2Mbps
Operating Frequency	2402MHz ~ 2480MHz
Number of Channel	40
Output Power	2.483mW
Antenna Type	Refer to note as below
Antenna Connector	Refer to note as below
Accessory Device	N/A
Data Cable Supplied	Non-shielded AC 3-Pin cable (3.0m)

Note:

1. WLAN 2.4GHz & WLAN 5GHz & Bluetooth technologies cannot transmit at same time.
2. The following antennas were provided to the EUT.

Ant. 1 Gain (dBi)	Ant. 2 Gain (dBi)	Antenna Type	Antenna Connector	Remark
3.21	3.36	PCB	ipex	Ant. 1 and Ant. 2 diversity

3. The above Antenna information is declared by manufacturer and for more detailed features description, please refer to the manufacturer's specifications, the laboratory shall not be held responsible.
4. The above EUT information is declared by manufacturer and for more detailed features description, please refers to the manufacturer's specifications or user's manual.

3.2 Description of Test Modes

40 channels are provided to this EUT:

CHANNEL	FREQ. (MHz)	CHANNEL	FREQ. (MHz)	CHANNEL	FREQ. (MHz)	CHANNEL	FREQ. (MHz)
0	2402	10	2422	20	2442	30	2462
1	2404	11	2424	21	2444	31	2464
2	2406	12	2426	22	2446	32	2466
3	2408	13	2428	23	2448	33	2468
4	2410	14	2430	24	2450	34	2470
5	2412	15	2432	25	2452	35	2472
6	2414	16	2434	26	2454	36	2474
7	2416	17	2436	27	2456	37	2476
8	2418	18	2438	28	2458	38	2478
9	2420	19	2440	29	2460	39	2480

3.2.1 Test Mode Applicability and Tested Channel Detail

EUT CONFIGURE MODE	APPLICABLE TO				DESCRIPTION
	RE \geq 1G	RE $<$ 1G	PLC	APCM	
-	√	√	√	√	-

Where **RE \geq 1G**: Radiated Emission above 1GHz **RE $<$ 1G**: Radiated Emission below 1GHz
PLC: Power Line Conducted Emission **APCM**: Antenna Port Conducted Measurement

Radiated Emission Test (Above 1GHz):

- Pre-Scan has been conducted to determine the worst-case mode from all possible combinations between available modulations, data rates and antenna ports (if EUT with antenna diversity architecture).
- Following channel(s) was (were) selected for the final test as listed below.

EUT Configure Mode	Available Channel	Tested Channel	Modulation Type	Data Rate (Mbps)
-	0 to 39	0, 19, 39	GFSK	1, 2

Radiated Emission Test (Below 1GHz):

- Pre-Scan has been conducted to determine the worst-case mode from all possible combinations between available modulations, data rates and antenna ports (if EUT with antenna diversity architecture).
- Following channel(s) was (were) selected for the final test as listed below.

EUT Configure Mode	Available Channel	Tested Channel	Modulation Type	Data Rate (Mbps)
-	0 to 39	0	GFSK	2

Power Line Conducted Emission Test:

- Pre-Scan has been conducted to determine the worst-case mode from all possible combinations between available modulations, data rates and antenna ports (if EUT with antenna diversity architecture).
- Following channel(s) was (were) selected for the final test as listed below.

EUT Configure Mode	Available Channel	Tested Channel	Modulation Type	Data Rate (Mbps)
-	0 to 39	0	GFSK	2

Antenna Port Conducted Measurement:

- This item includes all test value of each mode, but only includes spectrum plot of worst value of each mode.
- Pre-Scan has been conducted to determine the worst-case mode from all possible combinations between available modulations, data rates and antenna ports (if EUT with antenna diversity architecture).
- Following channel(s) was (were) selected for the final test as listed below.

EUT Configure Mode	Available Channel	Tested Channel	Modulation Type	Data Rate (Mbps)
-	0 to 39	0, 19, 39	GFSK	1, 2

Test Condition:

Applicable To	Environmental Conditions	Input Power	Tested By
RE≥1G	23deg. C, 69%RH	120Vac, 60Hz	Ian Chang
RE<1G	25deg. C, 70%RH	120Vac, 60Hz	Jed Wu
PLC	25deg. C, 75%RH	120Vac, 60Hz	Ian Chang
APCM	25deg. C, 76%RH	120Vac, 60Hz	Dalen Dai

3.3 Duty Cycle of Test Signal

Duty cycle of test signal is < 98 %, duty factor shall be considered.

GFSK (1Mbps): Duty cycle = 0.41ms/0.628ms = 0.653, Duty factor = 10 * log(1/0.653) = 1.85

GFSK (2Mbps): Duty cycle = 1.15ms/1.883ms = 0.611, Duty factor = 10 * log(1/0.611) = 2.14

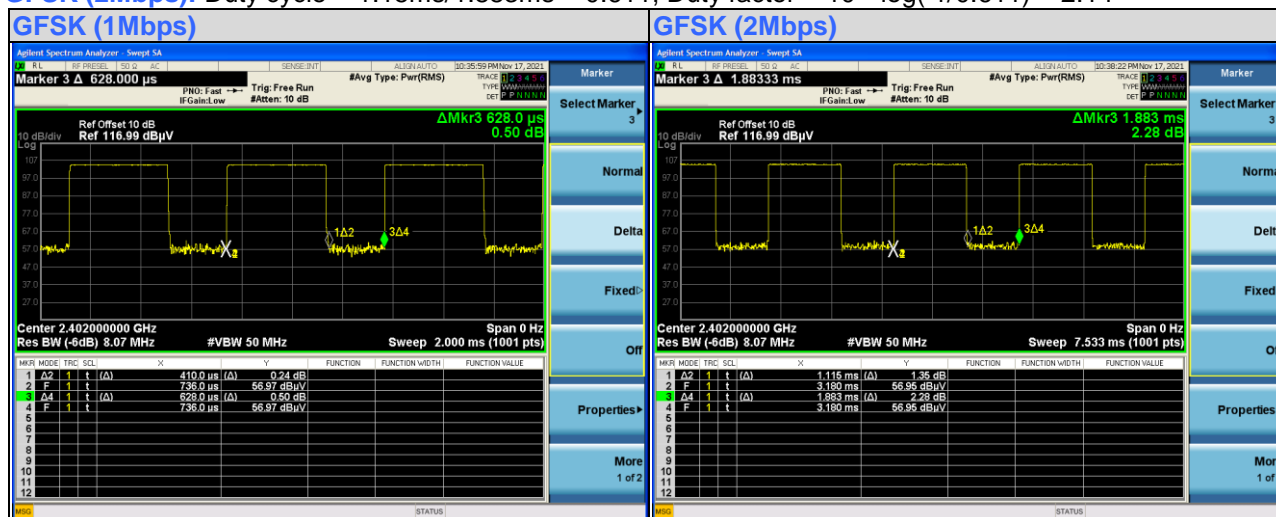

3.4 Description of Support Units

The EUT has been tested as an independent unit together with other necessary accessories or support units. The following support units or accessories were used to form a representative test configuration during the tests.

ID	Product	Brand	Model No.	Serial No.	FCC ID	Remarks
A.	Type-C to HDMI adapter	DELL	DPQANBC067	N/A	N/A	Provided by Lab
B.	LCD Monitor	ASUS	MG28U	N/A	N/A	Provided by Lab
C.	Earphone /Mic.	Oppo	L1516	N/A	N/A	Provided by Lab

ID	Cable Descriptions	Qty.	Length (m)	Shielding (Yes/ No)	Cores (Qty.)	Remarks
1.	HDMI cable	1	2	Y	0	Provided by Lab
2.	AC cable	1	3	N	0	Supplied by applicant
3.	Audio cable	1	1.2	N	0	Provided by Lab.

3.4.1 Configuration of System under Test

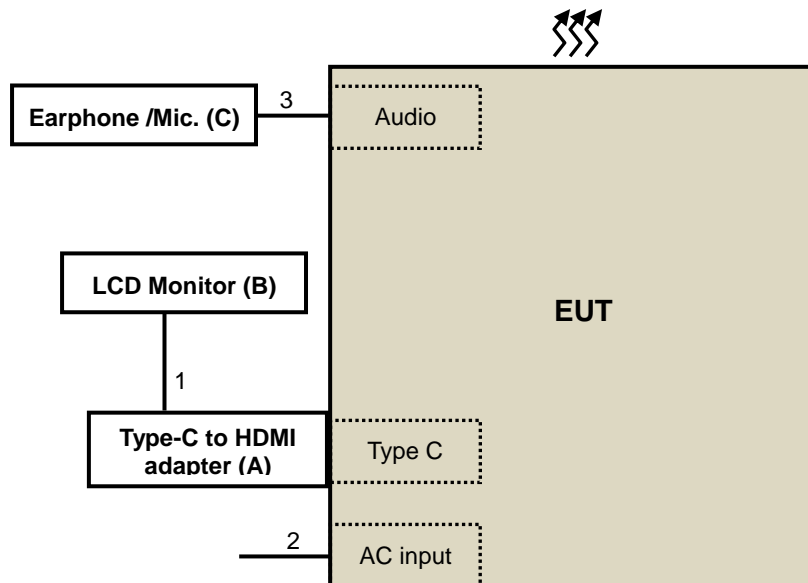

3.5 General Description of Applied Standards and references

The EUT is a RF Product. According to the specifications of the manufacturer, it must comply with the requirements of the following standards and references:

Test standard:

FCC Part 15, Subpart C (15.247)

ANSI C63.10-2013

All test items have been performed and recorded as per the above standards.

References Test Guidance:

KDB 558074 D01 15.247 Meas Guidance v05r02

All test items have been performed as a reference to the above KDB test guidance.

4 Test Types and Results

4.1 Radiated Emission and Bandedge Measurement

4.1.1 Limits of Radiated Emission and Bandedge Measurement

Radiated emissions which fall in the restricted bands must comply with the radiated emission limits specified as below table. Other emissions shall be at least 20dB below the highest level of the desired power:

Frequencies (MHz)	Field Strength (microvolts/meter)	Measurement Distance (meters)
0.009 ~ 0.490	2400/F(kHz)	300
0.490 ~ 1.705	24000/F(kHz)	30
1.705 ~ 30.0	30	30
30 ~ 88	100	3
88 ~ 216	150	3
216 ~ 960	200	3
Above 960	500	3

NOTE:

1. The lower limit shall apply at the transition frequencies.
2. Emission level (dBuV/m) = 20 log Emission level (uV/m).
3. For frequencies above 1000MHz, the field strength limits are based on average detector, however, the peak field strength of any emission shall not exceed the maximum permitted average limits, specified above by more than 20dB under any condition of modulation.

4.1.2 Test Instruments

Description & Manufacturer	Model no.	Serial No.	Calibrated Date	Calibrated Until
Test Receiver Agilent	N9038A	MY51210129	2021/3/12	2022/3/11
Software BVADT	ADT_Radiated_V8.7.08	NA	NA	NA
Software BVADT	ADT_RF Test Software V6.6.5.4	NA	NA	NA
Auto Control System(Antenna Tower, Table, Controller) ADT	SC100+AT100+TT100	0306	NA	NA
Pre_Amplifier EMCI	EMC001340	980269	2021/6/29	2022/6/28
LOOP ANTENNA EMCI	LPA600	270	2021/9/2	2023/9/1
RF Coaxial Cable Pacific	8D-FB	Cable-CH6-02	2021/7/13	2022/7/12
Pre_Amplifier HP	8447D	2432A03504	2021/2/18	2022/2/17
Bi-log Broadband Antenna Schwarzbeck	VULB9168	139	2021/11/1	2022/10/31
Attenuator Mini-Circuits	UNAT-5+	PAD-CH6-01	2021/7/13	2022/7/12
RF Coaxial Cable Pacific	8D-FB	Cable-CH6-02	2021/7/13	2022/7/12
Antenna(Horn) EMCO	3115	00028257	2021/11/14	2022/11/13
Test Receiver Agilent	N9038A	MY51210129	2021/3/12	2022/3/11
Pre-amplifier HP	8449B	3008A01201	2021/2/19	2022/2/18
RF Coaxial Cable NEAT BAR PROER SUHNER	SF-102	Cable-CH6-01	2021/7/8	2022/7/7
Highpass filter Wainwright Instruments	WHK 3.1/18G-10SS	SN 8	2021/5/28	2022/5/27
Fix tool for Boresight	BAF-01	5	NA	NA
Pre_Amplifier MITEQ	AMF-6F-260400-33-8P	892164	2021/2/19	2022/2/18
Antenna(Horn) Schwarzbeck	BBHA-9170	BBHA9170190	2021/11/14	2022/11/13
Spectrum Analyzer R&S	FSV40	101544	2021/5/24	2022/5/23
RF Coaxial Cable WOKEN	WC01	Cable-CH10-03	2021/7/8	2022/7/7
RF Coaxial Cable Rosnol	K1K50-UP0279-K1K50-3000	Cable-CH10(3m)-04	2021/7/8	2022/7/7
Highpass filter SUHNER	11SH10-7000/T18000-O/OP	SN 4	2021/5/28	2022/5/27

- NOTE:**
1. The calibration interval of the above test instruments is 12/24 months. And the calibrations are traceable to NML/ROC and NIST/USA.
 2. The horn antenna and HP preamplifier (model: 8449B) are used only for the measurement of emission frequency above 1GHz if tested.
 3. The test was performed in LK - 966 chamber 1.
 4. Tested Date: 2021/11/17 ~ 2021/11/26

4.1.3 Test Procedures

For Radiated emission below 30MHz

- a. The EUT was placed on the top of a rotating table 0.8 meters above the ground at a 3 meter chamber room. The table was rotated 360 degrees to determine the position of the highest radiation.
- b. The EUT was set 3 meters away from the interference-receiving antenna, which was mounted on the top of a variable-height antenna tower.
- c. Parallel, perpendicular, and ground-parallel orientations of the antenna are set to make the measurement.
- d. For each suspected emission, the EUT was arranged to its worst case and the rotatable table was turned from 0 degrees to 360 degrees to find the maximum reading.
- e. The test-receiver system was set to Quasi-Peak Detect Function and Specified Bandwidth with Maximum Hold Mode.

NOTE:

1. The resolution bandwidth and video bandwidth of test receiver/spectrum analyzer is 9kHz at frequency below 30MHz.

For Radiated emission above 30MHz

- a. The EUT was placed on the top of a rotating table 0.8 meters (for 30MHz ~ 1GHz) / 1.5 meters (for above 1GHz) above the ground at 3 meter chamber room for test. The table was rotated 360 degrees to determine the position of the highest radiation.
- b. The EUT was set 3 meters away from the interference-receiving antenna, which was mounted on the top of a variable-height antenna tower.
- c. The height of antenna is varied from one meter to four meters above the ground to determine the maximum value of the field strength. Both horizontal and vertical polarizations of the antenna are set to make the measurement.
- d. For each suspected emission, the EUT was arranged to its worst case and then the antenna was tuned to heights from 1 meter to 4 meters and the rotatable table was turned from 0 degrees to 360 degrees to find the maximum reading.
- e. The test-receiver system was set to quasi-peak detect function and specified bandwidth with maximum hold mode when the test frequency is below 1 GHz.
- f. The test-receiver system was set to peak and average detect function and specified bandwidth with maximum hold mode when the test frequency is above 1 GHz. If the peak reading value also meets average limit, measurement with the average detector is unnecessary.

Note:

1. The resolution bandwidth and video bandwidth of test receiver/spectrum analyzer is 120kHz for Quasi-peak detection (QP) at frequency below 1GHz.
2. The resolution bandwidth of test receiver/spectrum analyzer is 1 MHz and the video bandwidth is 3 MHz for Peak detection (PK) at frequency above 1GHz.
3. The resolution bandwidth of test receiver/spectrum analyzer is 1MHz and the video bandwidth is $\geq 1/T$ (Duty cycle < 98%) or 10Hz (Duty cycle $\geq 98\%$) for Average detection (AV) at frequency above 1GHz.
(**GFSK (1Mbps)**): RBW = 1MHz, VBW = 2.7kHz ; (**GFSK (2Mbps)**): RBW = 1MHz, VBW = 910Hz)
4. All modes of operation were investigated and the worst-case emissions are reported.

4.1.4 Deviation from Test Standard

No deviation.

4.1.5 Test Setup

For Radiated emission below 30MHz

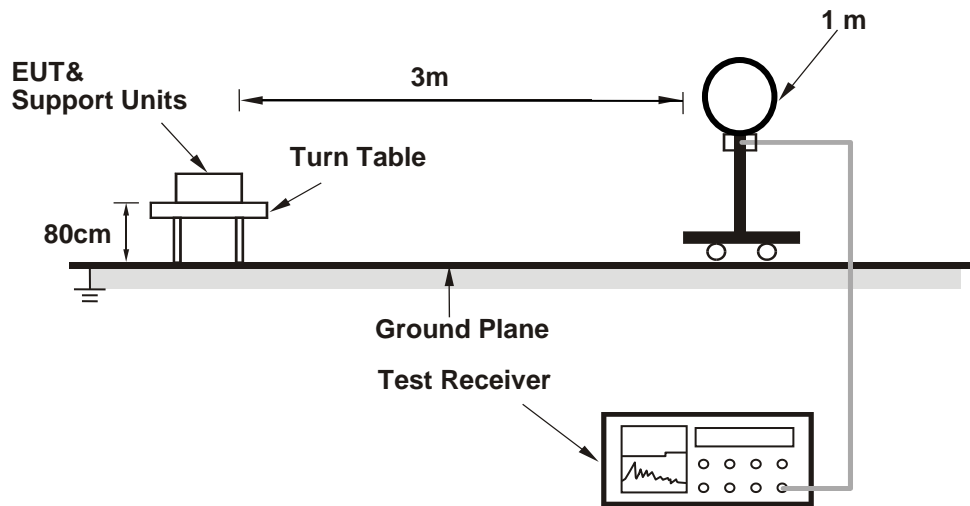

For Radiated emission 30MHz to 1GHz

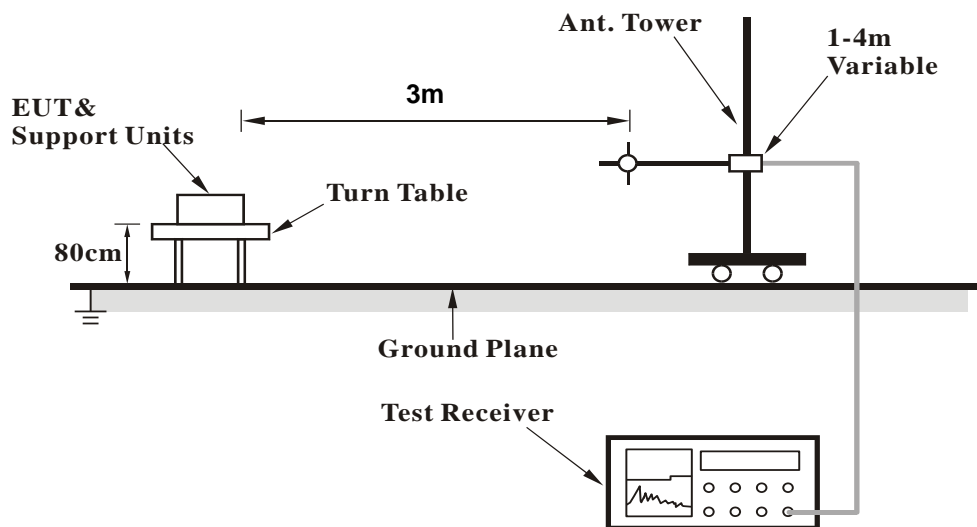

For Radiated emission above 1GHz

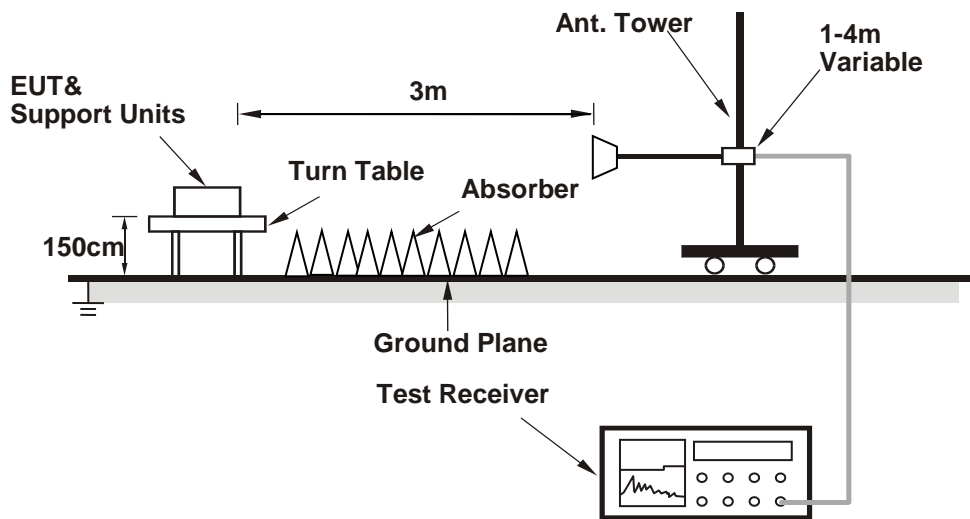

For the actual test configuration, please refer to the attached file (Test Setup Photo).

4.1.6 EUT Operating Conditions

- a. Placed the EUT on the testing table.
- b. Set the EUT under transmission condition continuously at specific channel frequency.
- c. Video camera of EUT captured video image, then sent messages to ext. monitor.
- d. The necessary accessories enable the system in full functions.

4.1.7 Test Results

ABOVE 1GHz DATA

RF Mode	TX BT-LE 1M	Channel	CH 0 : 2402 MHz
Frequency Range	1GHz ~ 25GHz	Detector Function	Peak (PK) Average (AV)

Antenna Polarity & Test Distance : Horizontal at 3 m								
No	Frequency (MHz)	Emission Level (dBuV/m)	Limit (dBuV/m)	Margin (dB)	Antenna Height (m)	Table Angle (Degree)	Raw Value (dBuV)	Correction Factor (dB/m)
1	2390.00	50.93 PK	74.00	-23.07	2.28 H	311	53.21	-2.28
2	2390.00	40.91 AV	54.00	-13.09	2.28 H	311	43.19	-2.28
3	*2402.00	96.65 PK			2.28 H	311	98.87	-2.22
4	*2402.00	96.05 AV			2.28 H	311	98.27	-2.22
5	4804.00	45.02 PK	74.00	-28.98	2.36 H	295	39.36	5.66
6	4804.00	34.12 AV	54.00	-19.88	2.36 H	295	28.46	5.66
Antenna Polarity & Test Distance : Vertical at 3 m								
No	Frequency (MHz)	Emission Level (dBuV/m)	Limit (dBuV/m)	Margin (dB)	Antenna Height (m)	Table Angle (Degree)	Raw Value (dBuV)	Correction Factor (dB/m)
1	2390.00	51.33 PK	74.00	-22.67	2.61 V	118	53.61	-2.28
2	2390.00	41.52 AV	54.00	-12.48	2.61 V	118	43.80	-2.28
3	*2402.00	102.37 PK			2.61 V	118	104.59	-2.22
4	*2402.00	100.97 AV			2.61 V	118	103.19	-2.22
5	4804.00	45.84 PK	74.00	-28.16	1.67 V	241	40.18	5.66
6	4804.00	35.47 AV	54.00	-18.53	1.67 V	241	29.81	5.66

Remarks:

1. Emission Level(dBuV/m) = Raw Value(dBuV) + Correction Factor(dB/m)
2. Correction Factor(dB/m) = Antenna Factor(dB/m) + Cable Factor(dB) – Pre-Amplifier Factor(dB)
3. Margin value = Emission Level – Limit value
4. The other emission levels were very low against the limit.
5. " * ": Fundamental frequency.

RF Mode	TX BT-LE 1M	Channel	CH 19 : 2440 MHz
Frequency Range	1GHz ~ 25GHz	Detector Function	Peak (PK) Average (AV)

Antenna Polarity & Test Distance : Horizontal at 3 m

No	Frequency (MHz)	Emission Level (dBuV/m)	Limit (dBuV/m)	Margin (dB)	Antenna Height (m)	Table Angle (Degree)	Raw Value (dBuV)	Correction Factor (dB/m)
1	*2440.00	97.12 PK			2.31 H	308	99.26	-2.14
2	*2440.00	96.02 AV			2.31 H	308	98.16	-2.14
3	4880.00	45.06 PK	74.00	-28.94	1.63 H	296	39.36	5.70
4	4880.00	34.16 AV	54.00	-19.84	1.63 H	296	28.46	5.70

Antenna Polarity & Test Distance : Vertical at 3 m

No	Frequency (MHz)	Emission Level (dBuV/m)	Limit (dBuV/m)	Margin (dB)	Antenna Height (m)	Table Angle (Degree)	Raw Value (dBuV)	Correction Factor (dB/m)
1	*2440.00	101.91 PK			2.53 V	123	104.05	-2.14
2	*2440.00	101.38 AV			2.53 V	123	103.52	-2.14
3	4880.00	46.36 PK	74.00	-27.64	1.64 V	287	40.66	5.70
4	4880.00	35.05 AV	54.00	-18.95	1.64 V	287	29.35	5.70

Remarks:

1. Emission Level(dBuV/m) = Raw Value(dBuV) + Correction Factor(dB/m)
2. Correction Factor(dB/m) = Antenna Factor(dB/m) + Cable Factor(dB) – Pre-Amplifier Factor(dB)
3. Margin value = Emission Level – Limit value
4. The other emission levels were very low against the limit.
5. " * ": Fundamental frequency.

RF Mode	TX BT-LE 1M	Channel	CH 39 : 2480 MHz
Frequency Range	1GHz ~ 25GHz	Detector Function	Peak (PK) Average (AV)

Antenna Polarity & Test Distance : Horizontal at 3 m

No	Frequency (MHz)	Emission Level (dBuV/m)	Limit (dBuV/m)	Margin (dB)	Antenna Height (m)	Table Angle (Degree)	Raw Value (dBuV)	Correction Factor (dB/m)
1	*2480.00	96.50 PK			2.31 H	305	98.46	-1.96
2	*2480.00	95.73 AV			2.31 H	305	97.69	-1.96
3	2483.50	50.61 PK	74.00	-23.39	2.31 H	305	52.55	-1.94
4	2483.50	40.16 AV	54.00	-13.84	2.31 H	305	42.10	-1.94
5	4960.00	45.08 PK	74.00	-28.92	2.25 H	236	39.22	5.86
6	4960.00	34.20 AV	54.00	-19.80	2.25 H	236	28.34	5.86

Antenna Polarity & Test Distance : Vertical at 3 m

No	Frequency (MHz)	Emission Level (dBuV/m)	Limit (dBuV/m)	Margin (dB)	Antenna Height (m)	Table Angle (Degree)	Raw Value (dBuV)	Correction Factor (dB/m)
1	*2480.00	101.15 PK			2.46 V	112	103.11	-1.96
2	*2480.00	100.58 AV			2.46 V	112	102.54	-1.96
3	2483.50	51.99 PK	74.00	-22.01	2.46 V	112	53.93	-1.94
4	2483.50	41.55 AV	54.00	-12.45	2.46 V	112	43.49	-1.94
5	4960.00	46.22 PK	74.00	-27.78	1.45 V	136	40.36	5.86
6	4960.00	35.21 AV	54.00	-18.79	1.45 V	136	29.35	5.86

Remarks:

1. Emission Level(dBuV/m) = Raw Value(dBuV) + Correction Factor(dB/m)
2. Correction Factor(dB/m) = Antenna Factor(dB/m) + Cable Factor(dB) – Pre-Amplifier Factor(dB)
3. Margin value = Emission Level – Limit value
4. The other emission levels were very low against the limit.
5. " * ": Fundamental frequency.

RF Mode	TX BT-LE 2M	Channel	CH 0 : 2402 MHz
Frequency Range	1GHz ~ 25GHz	Detector Function	Peak (PK) Average (AV)

Antenna Polarity & Test Distance : Horizontal at 3 m

No	Frequency (MHz)	Emission Level (dBuV/m)	Limit (dBuV/m)	Margin (dB)	Antenna Height (m)	Table Angle (Degree)	Raw Value (dBuV)	Correction Factor (dB/m)
1	2390.00	50.94 PK	74.00	-23.06	2.32 H	306	53.22	-2.28
2	2390.00	40.08 AV	54.00	-13.92	2.32 H	306	42.36	-2.28
3	*2402.00	96.24 PK			2.32 H	306	98.46	-2.22
4	*2402.00	94.06 AV			2.32 H	306	96.28	-2.22
5	4804.00	45.16 PK	74.00	-28.84	3.26 H	222	39.50	5.66
6	4804.00	34.23 AV	54.00	-19.77	3.26 H	222	28.57	5.66

Antenna Polarity & Test Distance : Vertical at 3 m

No	Frequency (MHz)	Emission Level (dBuV/m)	Limit (dBuV/m)	Margin (dB)	Antenna Height (m)	Table Angle (Degree)	Raw Value (dBuV)	Correction Factor (dB/m)
1	2390.00	51.74 PK	74.00	-22.26	1.59 V	143	54.02	-2.28
2	2390.00	41.08 AV	54.00	-12.92	1.59 V	143	43.36	-2.28
3	*2402.00	101.64 PK			1.59 V	143	103.86	-2.22
4	*2402.00	99.72 AV			1.59 V	143	101.94	-2.22
5	4804.00	45.91 PK	74.00	-28.09	1.87 V	296	40.25	5.66
6	4804.00	35.02 AV	54.00	-18.98	1.87 V	296	29.36	5.66

Remarks:

1. Emission Level(dBuV/m) = Raw Value(dBuV) + Correction Factor(dB/m)
2. Correction Factor(dB/m) = Antenna Factor(dB/m) + Cable Factor(dB) – Pre-Amplifier Factor(dB)
3. Margin value = Emission Level – Limit value
4. The other emission levels were very low against the limit.
5. " * " : Fundamental frequency.

RF Mode	TX BT-LE 2M	Channel	CH 19 : 2440 MHz
Frequency Range	1GHz ~ 25GHz	Detector Function	Peak (PK) Average (AV)

Antenna Polarity & Test Distance : Horizontal at 3 m

No	Frequency (MHz)	Emission Level (dBuV/m)	Limit (dBuV/m)	Margin (dB)	Antenna Height (m)	Table Angle (Degree)	Raw Value (dBuV)	Correction Factor (dB/m)
1	*2440.00	96.30 PK			2.35 H	308	98.44	-2.14
2	*2440.00	94.72 AV			2.35 H	308	96.86	-2.14
3	4880.00	44.85 PK	74.00	-29.15	1.44 H	152	39.15	5.70
4	4880.00	34.16 AV	54.00	-19.84	1.44 H	152	28.46	5.70

Antenna Polarity & Test Distance : Vertical at 3 m

No	Frequency (MHz)	Emission Level (dBuV/m)	Limit (dBuV/m)	Margin (dB)	Antenna Height (m)	Table Angle (Degree)	Raw Value (dBuV)	Correction Factor (dB/m)
1	*2440.00	101.20 PK			1.55 V	145	103.34	-2.14
2	*2440.00	99.03 AV			1.55 V	145	101.17	-2.14
3	4880.00	45.94 PK	74.00	-28.06	2.55 V	153	40.24	5.70
4	4880.00	35.04 AV	54.00	-18.96	2.55 V	153	29.34	5.70

Remarks:

1. Emission Level(dBuV/m) = Raw Value(dBuV) + Correction Factor(dB/m)
2. Correction Factor(dB/m) = Antenna Factor(dB/m) + Cable Factor(dB) – Pre-Amplifier Factor(dB)
3. Margin value = Emission Level – Limit value
4. The other emission levels were very low against the limit.
5. " * ": Fundamental frequency.

RF Mode	TX BT-LE 2M	Channel	CH 39 : 2480 MHz
Frequency Range	1GHz ~ 25GHz	Detector Function	Peak (PK) Average (AV)

Antenna Polarity & Test Distance : Horizontal at 3 m

No	Frequency (MHz)	Emission Level (dBuV/m)	Limit (dBuV/m)	Margin (dB)	Antenna Height (m)	Table Angle (Degree)	Raw Value (dBuV)	Correction Factor (dB/m)
1	*2480.00	96.47 PK			2.28 H	312	98.43	-1.96
2	*2480.00	94.73 AV			2.28 H	312	96.69	-1.96
3	2483.50	50.94 PK	74.00	-23.06	2.28 H	312	52.88	-1.94
4	2483.50	40.74 AV	54.00	-13.26	2.28 H	312	42.68	-1.94
5	4960.00	45.20 PK	74.00	-28.80	2.51 H	158	39.34	5.86
6	4960.00	34.08 AV	54.00	-19.92	2.51 H	158	28.22	5.86

Antenna Polarity & Test Distance : Vertical at 3 m

No	Frequency (MHz)	Emission Level (dBuV/m)	Limit (dBuV/m)	Margin (dB)	Antenna Height (m)	Table Angle (Degree)	Raw Value (dBuV)	Correction Factor (dB/m)
1	*2480.00	101.47 PK			1.55 V	149	103.43	-1.96
2	*2480.00	99.54 AV			1.55 V	149	101.50	-1.96
3	2483.50	51.51 PK	74.00	-22.49	1.55 V	149	53.45	-1.94
4	2483.50	41.24 AV	54.00	-12.76	1.55 V	149	43.18	-1.94
5	4960.00	46.08 PK	74.00	-27.92	1.92 V	254	40.22	5.86
6	4960.00	35.18 AV	54.00	-18.82	1.92 V	254	29.32	5.86

Remarks:

1. Emission Level(dBuV/m) = Raw Value(dBuV) + Correction Factor(dB/m)
2. Correction Factor(dB/m) = Antenna Factor(dB/m) + Cable Factor(dB) – Pre-Amplifier Factor(dB)
3. Margin value = Emission Level – Limit value
4. The other emission levels were very low against the limit.
5. " * ": Fundamental frequency.

BELOW 1GHz WORST-CASE DATA

RF Mode	TX BT-LE 2M	Channel	CH 0 : 2402 MHz
Frequency Range	9kHz ~ 1GHz	Detector Function	Quasi-Peak (QP)

Antenna Polarity & Test Distance : Horizontal at 3 m								
No	Frequency (MHz)	Emission Level (dBuV/m)	Limit (dBuV/m)	Margin (dB)	Antenna Height (m)	Table Angle (Degree)	Raw Value (dBuV)	Correction Factor (dB/m)
1	66.52	24.75 QP	40.00	-15.25	1.65 H	319	32.84	-8.09
2	82.38	23.39 QP	40.00	-16.61	1.27 H	94	35.09	-11.70
3	178.99	23.91 QP	43.50	-19.59	2.13 H	259	31.20	-7.29
4	266.15	23.95 QP	46.00	-22.05	2.54 H	256	29.38	-5.43
5	320.08	25.18 QP	46.00	-20.82	1.75 H	282	28.74	-3.56
6	415.43	27.34 QP	46.00	-18.66	1.66 H	319	29.09	-1.75

Remarks:

1. Emission Level(dBuV/m) = Raw Value(dBuV) + Correction Factor(dB/m)
2. Correction Factor(dB/m) = Antenna Factor(dB/m) + Cable Factor(dB) – Pre-Amplifier Factor(dB)
3. Margin value = Emission Level – Limit value
4. The other emission levels were very low against the limit of frequency range 30MHz~1000MHz.
5. The emission levels were very low against the limit of frequency range 9kHz~30MHz: the amplitude of spurious emissions attenuated more than 20 dB below the permissible value to be report.

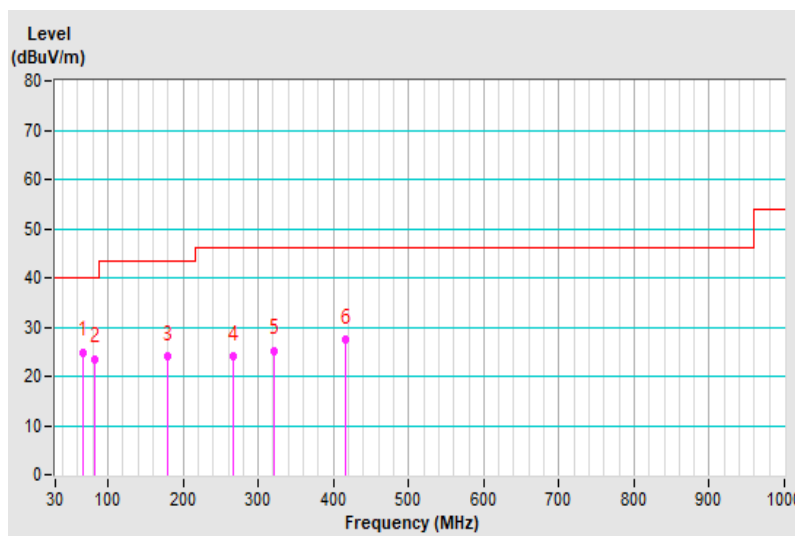

RF Mode	TX BT-LE 2M	Channel	CH 0 : 2402 MHz
Frequency Range	9kHz ~ 1GHz	Detector Function	Quasi-Peak (QP)

Antenna Polarity & Test Distance : Vertical at 3 m								
No	Frequency (MHz)	Emission Level (dBuV/m)	Limit (dBuV/m)	Margin (dB)	Antenna Height (m)	Table Angle (Degree)	Raw Value (dBuV)	Correction Factor (dB/m)
1	31.75	31.60 QP	40.00	-8.40	1.77 V	325	40.19	-8.59
2	48.33	28.05 QP	40.00	-11.95	1.20 V	199	34.82	-6.77
3	74.96	26.72 QP	40.00	-13.28	1.43 V	0	36.63	-9.91
4	165.85	30.02 QP	43.50	-13.48	1.56 V	360	36.34	-6.32
5	332.20	26.21 QP	46.00	-19.79	1.89 V	144	29.55	-3.34
6	392.93	27.45 QP	46.00	-18.55	1.62 V	278	29.77	-2.32

Remarks:

1. Emission Level(dBuV/m) = Raw Value(dBuV) + Correction Factor(dB/m)
2. Correction Factor(dB/m) = Antenna Factor(dB/m) + Cable Factor(dB) – Pre-Amplifier Factor(dB)
3. Margin value = Emission Level – Limit value
4. The other emission levels were very low against the limit of frequency range 30MHz~1000MHz.
5. The emission levels were very low against the limit of frequency range 9kHz~30MHz: the amplitude of spurious emissions attenuated more than 20 dB below the permissible value to be report.

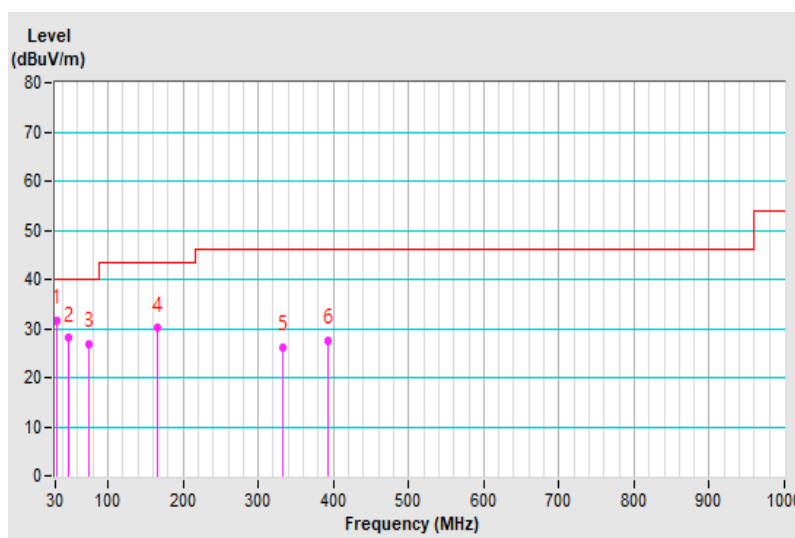

4.2 Conducted Emission Measurement

4.2.1 Limits of Conducted Emission Measurement

Frequency (MHz)	Conducted Limit (dBuV)	
	Quasi-peak	Average
0.15 - 0.5	66 - 56	56 - 46
0.50 - 5.0	56	46
5.0 - 30.0	60	50

- Note: 1. The lower limit shall apply at the transition frequencies.
 2. The limit decreases in line with the logarithm of the frequency in the range of 0.15 to 0.50MHz.

4.2.2 Test Instruments

Description & Manufacturer	Model no.	Serial No.	Calibrated Date	Calibrated Until
Test Receiver ESR3 R&S	ESR3	102412	2021/1/29	2022/1/28
LISN SCHWARZBECK	NSLK 8128	8128-244	2021/11/11	2022/11/10
LISN SCHWARZBECK	NNLK8129	8129229	2021/5/20	2022/5/19
DC LISN SCHWARZBECK	NNLK 8121	8121-808	2021/4/18	2022/4/17
LISN SCHWARZBECK	NNLK 8121	8121-731	2021/4/28	2022/4/27
LISN R&S	ENV216	101196	2021/4/26	2022/4/25
LISN R&S	ESH3-Z5	100220	2020/12/1	2021/11/30
LISN R&S	ESH3-Z6	844950/018	2021/7/25	2022/7/24
DC LISN R&S	ESH3-Z6	100219	2021/7/25	2022/7/24
High Voltage Probe Schwarzbeck	TK9420	00982	2021/1/8	2022/1/7
RF Coaxial Cable Commate	5D-FB	Cable-CO5-01	2021/1/29	2022/1/28
Attenuator STI	STI02-2200-10	NO.4	2021/9/3	2022/9/2
50 Ohms Terminator LYNICS	0900510	E1-01-305	2021/2/17	2022/2/16
Isolation Transformer Erika Fiedler	D-65396	017	2021/9/9	2022/9/8
Software BVADT	Cond_V7.3.7.4	NA	NA	NA

- Note: 1. The calibration interval of the above test instruments is 12 months and the calibrations are traceable to NML/ROC and NIST/USA.
 2. The test was performed in Linkou Conduction05
 3. The VCCI Site Registration No. C-11093.
 4. Tested Date: 2021/11/27

4.2.3 Test Procedures

- The EUT was placed 0.4 meters from the conducting wall of the shielded room with EUT being connected to the power mains through a line impedance stabilization network (LISN). Other support units were connected to the power mains through another LISN. The two LISNs provide 50 ohm/ 50uH of coupling impedance for the measuring instrument.
- Both lines of the power mains connected to the EUT were checked for maximum conducted interference.
- The frequency range from 150kHz to 30MHz was searched. Emission levels under (Limit - 20dB) was not recorded.

NOTE: The resolution bandwidth and video bandwidth of test receiver is 9kHz for quasi-peak detection (QP) and average detection (AV) at frequency 0.15MHz-30MHz.

4.2.4 Deviation From Test Standard

No deviation.

4.2.5 Test Setup

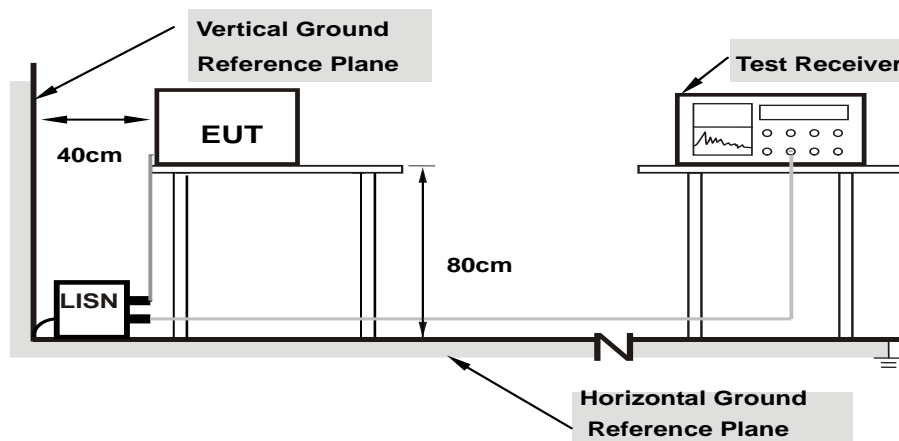

Note: 1.Support units were connected to second LISN.

For the actual test configuration, please refer to the attached file (Test Setup Photo).

4.2.6 EUT Operating Condition

Same as Item 4.1.6.

4.2.7 Test Results

RF Mode	TX BT-LE 2M	Channel	CH 0 : 2402 MHz
Frequency Range	150kHz ~ 30MHz	Detector Function & Resolution Bandwidth	Quasi-Peak (QP) / Average (AV), 9kHz

Phase Of Power : Line (L)										
No	Frequency (MHz)	Correction Factor (dB)	Reading Value (dBuV)		Emission Level (dBuV)		Limit (dBuV)		Margin (dB)	
			Q.P.	AV.	Q.P.	AV.	Q.P.	AV.	Q.P.	AV.
1	0.15400	9.88	45.93	32.86	55.81	42.74	65.78	55.78	-9.97	-13.04
2	0.23837	9.88	46.50	34.94	56.38	44.82	62.15	52.15	-5.77	-7.33
3	0.45242	9.90	41.90	29.93	51.80	39.83	56.83	46.83	-5.03	-7.00
4	0.59600	9.92	42.62	32.81	52.54	42.73	56.00	46.00	-3.46	-3.27
5	1.15200	9.95	30.45	14.69	40.40	24.64	56.00	46.00	-15.60	-21.36
6	7.64800	10.14	22.09	14.51	32.23	24.65	60.00	50.00	-27.77	-25.35
7	19.94800	10.45	25.25	21.46	35.70	31.91	60.00	50.00	-24.30	-18.09

Remarks:

1. Q.P. and AV. are abbreviations of quasi-peak and average individually.
2. The emission levels of other frequencies were very low against the limit.
3. Margin value = Emission level – Limit value
4. Correction factor = Insertion loss + Cable loss
5. Emission Level = Correction Factor + Reading Value

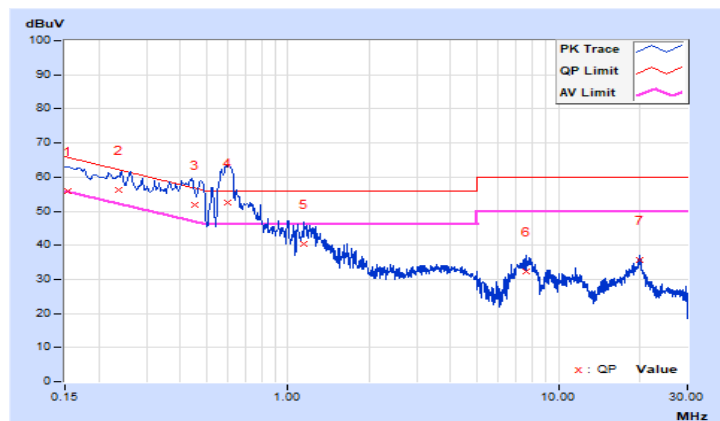

RF Mode	TX BT-LE 2M	Channel	CH 0 : 2402 MHz
Frequency Range	150kHz ~ 30MHz	Detector Function & Resolution Bandwidth	Quasi-Peak (QP) / Average (AV), 9kHz

Phase Of Power : Neutral (N)										
No	Frequency (MHz)	Correction Factor (dB)	Reading Value (dBuV)		Emission Level (dBuV)		Limit (dBuV)		Margin (dB)	
			Q.P.	AV.	Q.P.	AV.	Q.P.	AV.	Q.P.	AV.
1	0.15687	9.89	43.10	23.79	52.99	33.68	65.63	55.63	-12.64	-21.95
2	0.25400	9.90	40.01	23.21	49.91	33.11	61.63	51.63	-11.72	-18.52
3	0.44999	9.91	37.90	20.92	47.81	30.83	56.88	46.88	-9.07	-16.05
4	0.59600	9.93	40.56	23.90	50.49	33.83	56.00	46.00	-5.51	-12.17
5	1.22780	9.97	21.19	5.98	31.16	15.95	56.00	46.00	-24.84	-30.05
6	7.88400	10.16	19.52	12.38	29.68	22.54	60.00	50.00	-30.32	-27.46
7	19.95600	10.47	24.53	20.65	35.00	31.12	60.00	50.00	-25.00	-18.88

Remarks:

1. Q.P. and AV. are abbreviations of quasi-peak and average individually.
2. The emission levels of other frequencies were very low against the limit.
3. Margin value = Emission level – Limit value
4. Correction factor = Insertion loss + Cable loss
5. Emission Level = Correction Factor + Reading Value

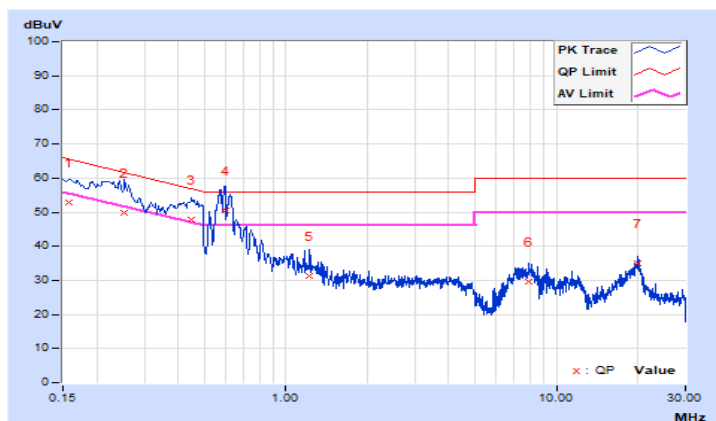

4.3 6dB Bandwidth Measurement

4.3.1 Limits of 6dB Bandwidth Measurement

The minimum of 6dB Bandwidth Measurement is 0.5 MHz.

4.3.2 Test Setup

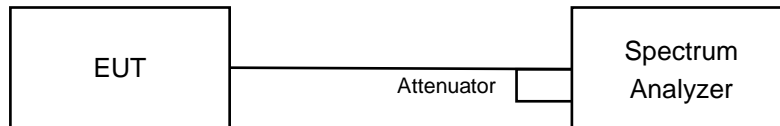

4.3.3 Test Instruments

Description & Manufacturer	Model no.	Serial No.	Calibrated Date	Calibrated Until
Spectrum Analyzer R&S	FSV40	101042	2021/9/9	2022/9/8

- NOTE:**
1. The calibration interval of the above test instruments is 12 months. And the calibrations are traceable to NML/ROC and NIST/USA.
 2. The test was performed in LK - Oven
 3. Tested Date: 2021/11/26

4.3.4 Test Procedure

- a. Set resolution bandwidth (RBW) = 100kHz
- b. Set the video bandwidth (VBW) $\geq 3 \times$ RBW, Detector = Peak.
- c. Trace mode = max hold.
- d. Sweep = auto couple.
- e. Measure the maximum width of the emission that is constrained by the frequencies associated with the two amplitude points (upper and lower) that are attenuated by 6 dB relative to the maximum level measured in the fundamental emission

4.3.5 Deviation from Test Standard

No deviation.

4.3.6 EUT Operating Conditions

The software provided by client to enable the EUT under transmission condition continuously at lowest, middle and highest channel frequencies individually.

4.3.7 Test Result

Channel	Frequency (MHz)	6dB Bandwidth (MHz)		Minimum Limit (MHz)	Pass / Fail
		GFSK (1Mbps)	GFSK (2Mbps)		
0	2402	0.68	1.16	0.5	Pass
19	2440	0.68	1.17	0.5	Pass
39	2480	0.68	1.17	0.5	Pass

Spectrum Plot of Worst Value

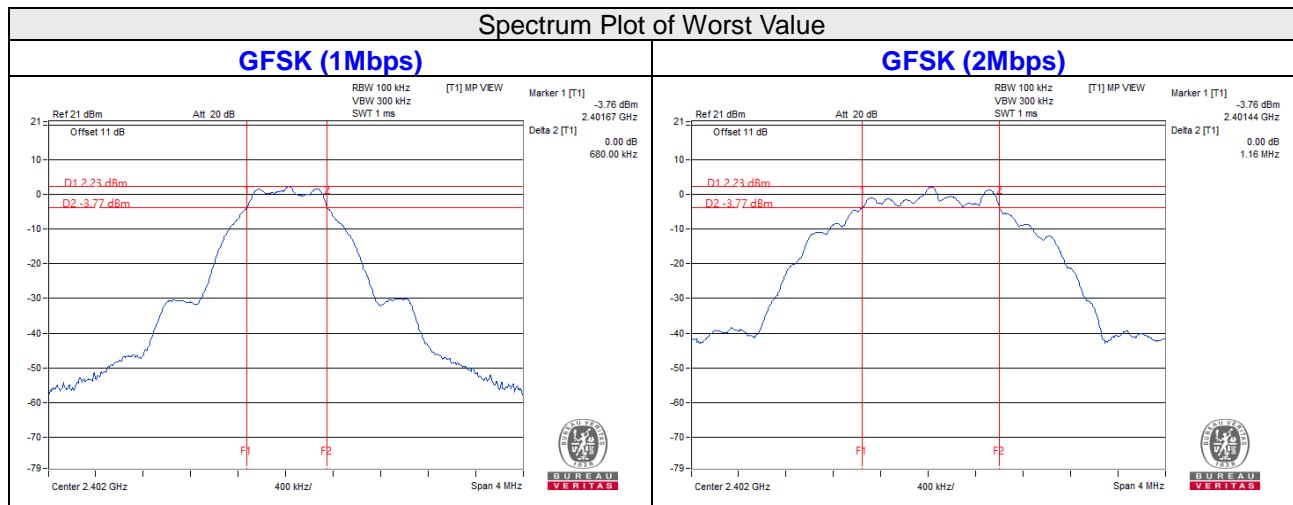

4.4 Conducted Output Power Measurement

4.4.1 Limits OF Conducted Output Power Measurement

For systems using digital modulation in the 2400–2483.5 MHz bands: 1 Watt (30dBm)

4.4.2 Test Setup

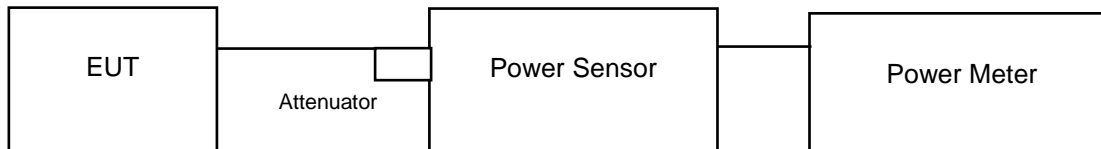

4.4.3 Test Instruments

Description & Manufacturer	Model no.	Serial No.	Calibrated Date	Calibrated Until
Pulse Power Sensor Anritsu	MA2411B	0738404	2021/4/15	2022/4/14
Peak Power meter Anritsu	ML2495A	0842014	2021/4/15	2022/4/14

- NOTE:**
1. The calibration interval of the above test instruments is 12 months. And the calibrations are traceable to NML/ROC and NIST/USA.
 2. The test was performed in LK - Oven
 3. Tested Date: 2021/11/26

4.4.4 Test Procedures

A peak power sensor was used on the output port of the EUT. A power meter was used to read the response of the peak power sensor. Record the power level.

Average power sensor was used to perform output power measurement, trigger and gating function of wide band power meter is enabled to measure max output power of TX on burst. Duty factor is not added to measured value.

4.4.5 Deviation from Test Standard

No deviation.

4.4.6 EUT Operating Conditions

Same as Item 4.3.6.

4.4.7 Test Results

FOR PEAK POWER

Channel	Frequency (MHz)	Peak Power (mW)		Peak Power (dBm)		Limit (dBm)	Pass / Fail
		GFSK (1Mbps)	GFSK (2Mbps)	GFSK (1Mbps)	GFSK (2Mbps)		
0	2402	2.377	2.483	3.76	3.95	30	Pass
19	2440	2.296	2.399	3.61	3.80	30	Pass
39	2480	2.042	2.104	3.10	3.23	30	Pass

FOR AVERAGE POWER

Channel	Frequency (MHz)	Average Power (mW)		Average Power (dBm)	
		GFSK (1Mbps)	GFSK (2Mbps)	GFSK (1Mbps)	GFSK (2Mbps)
0	2402	2.27	2.259	3.56	3.54
19	2440	2.193	2.178	3.41	3.38
39	2480	1.932	1.932	2.86	2.86

4.5 Power Spectral Density Measurement

4.5.1 Limits of Power Spectral Density Measurement

The Maximum of Power Spectral Density Measurement is 8dBm per 3 kHz.

4.5.2 Test Setup

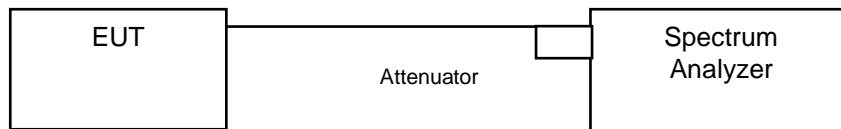

4.5.3 Test Instruments

Refer to section 4.3.3 to get information of above instrument.

4.5.4 Test Procedure

- a. Set analyzer center frequency to DTS channel center frequency.
- b. Set the span to 1.5 times the DTS bandwidth.
- c. Set the RBW to: $3 \text{ kHz} \leq \text{RBW} \leq 100 \text{ kHz}$.
- d. Set the VBW $\geq 3 \times \text{RBW}$.
- e. Detector = peak.
- f. Sweep time = auto couple.
- g. Trace mode = max hold.
- h. Allow trace to fully stabilize.
- i. Use the peak marker function to determine the maximum amplitude level within the RBW.

4.5.5 Deviation from Test Standard

No deviation.

4.5.6 EUT Operating Condition

Same as Item 4.3.6.

4.5.7 Test Results

Channel	Freq. (MHz)	PSD (dBm/3kHz)		Limit (dBm/3kHz)	Pass /Fail
		GFSK (1Mbps)	GFSK (2Mbps)		
0	2402	-12.18	-16.44	8	Pass
19	2440	-12.23	-16.45	8	Pass
39	2480	-12.64	-16.92	8	Pass

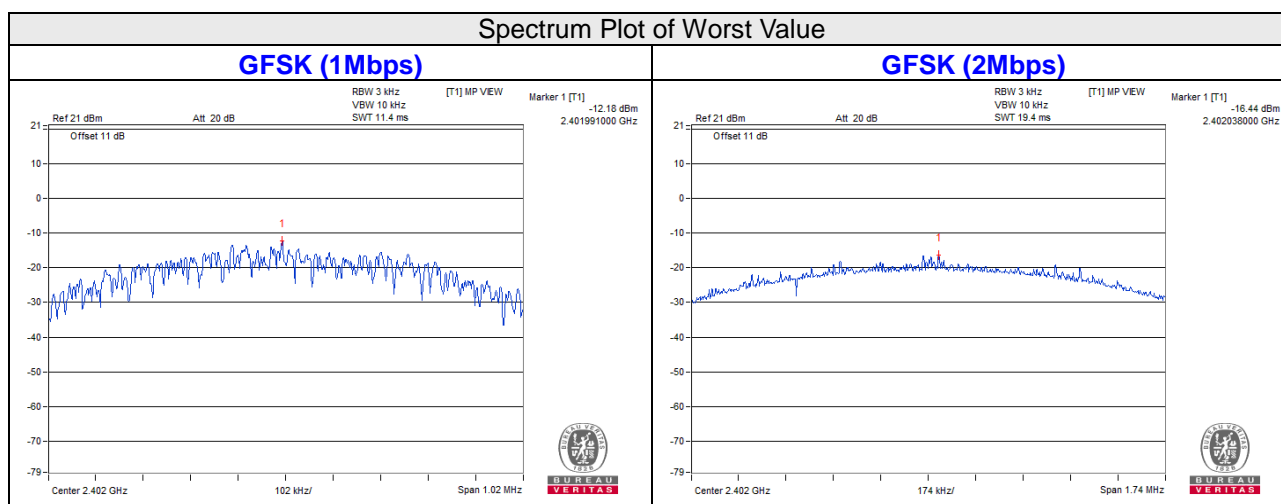

4.6 Conducted Out of Band Emission Measurement

4.6.1 Limits of Conducted Out of Band Emission Measurement

Below 20dB of the highest emission level of operating band (in 100kHz Resolution Bandwidth).

4.6.2 Test Setup

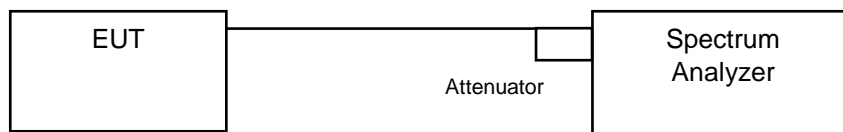

4.6.3 Test Instruments

Refer to section 4.3.3 to get information of above instrument.

4.6.4 Test Procedure

MEASUREMENT PROCEDURE REF

1. Set the RBW = 100 kHz.
2. Set the VBW \geq 300 kHz.
3. Detector = peak.
4. Sweep time = auto couple.
5. Trace mode = max hold.
6. Allow trace to fully stabilize.
7. Use the peak marker function to determine the maximum power level in any 100 kHz band segment within the fundamental EBW.

MEASUREMENT PROCEDURE OOBE

1. Set RBW = 100 kHz.
2. Set VBW \geq 300 kHz.
3. Detector = peak.
4. Sweep = auto couple.
5. Trace Mode = max hold.
6. Allow trace to fully stabilize.
7. Use the peak marker function to determine the maximum amplitude level.

4.6.5 Deviation from Test Standard

No deviation.

4.6.6 EUT Operating Condition

Same as Item 4.3.6.

4.6.7 Test Results

The spectrum plots are attached on the following pages. D1 line indicates the highest level, and D2 line indicates the 20dB offset below D1. It shows compliance with the requirement.

GFSK (1Mbps)

CH 0

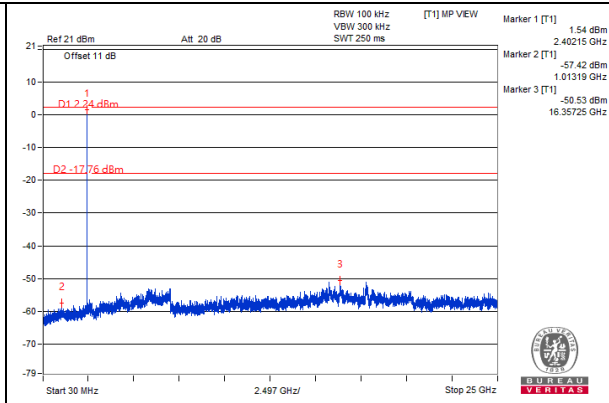
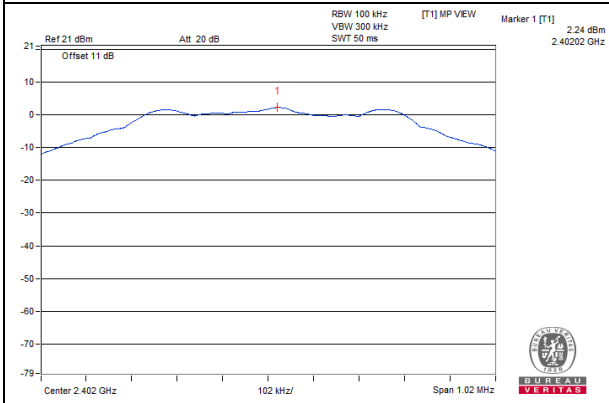

CH 19

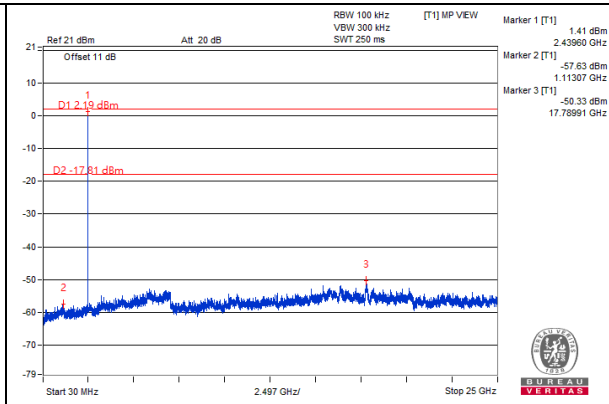
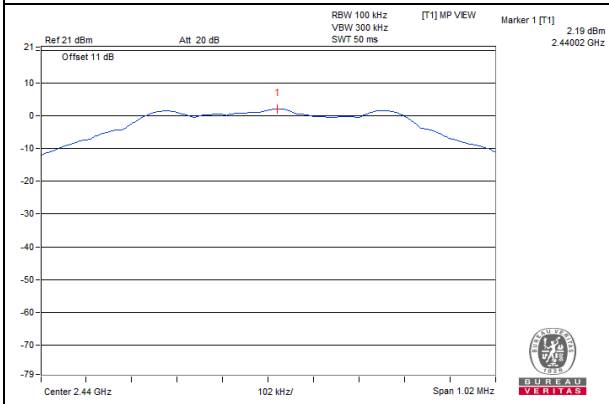

CH 39

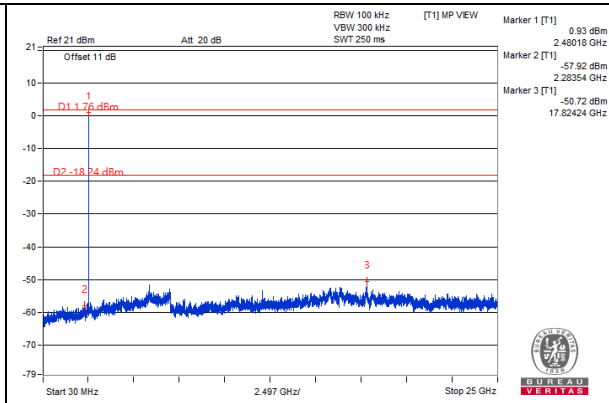
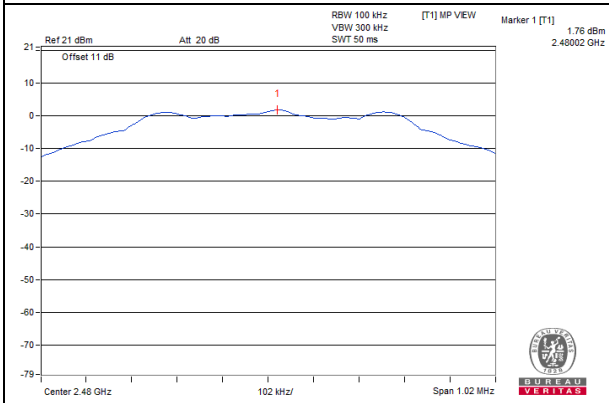

CH 0 Band edge

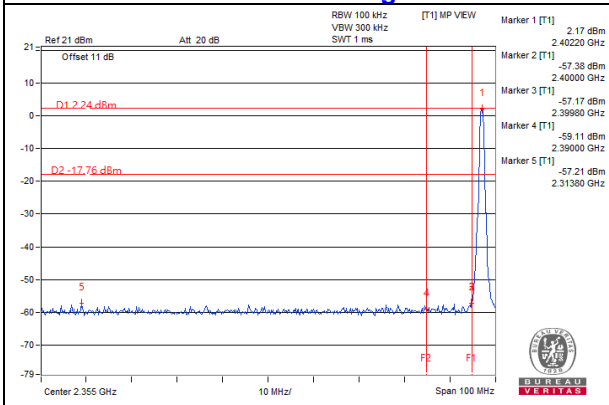

CH 39 Band edge

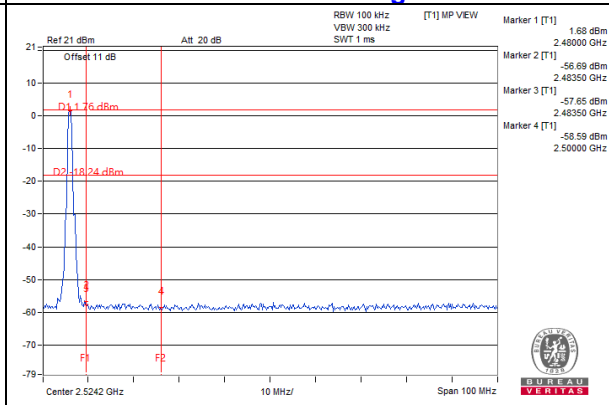

GFSK (2Mbps)

CH 0

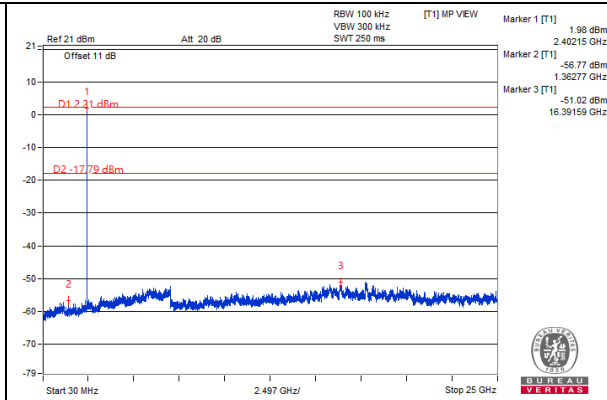
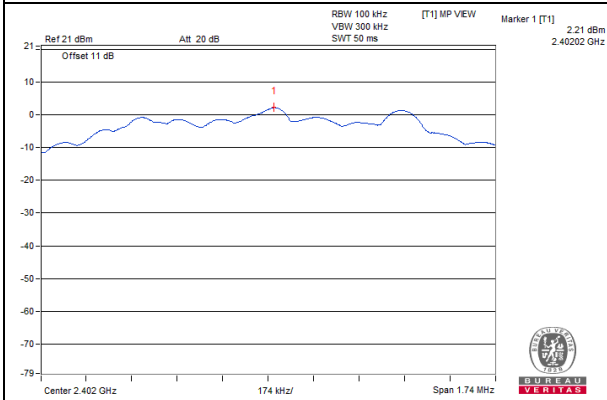

CH 19

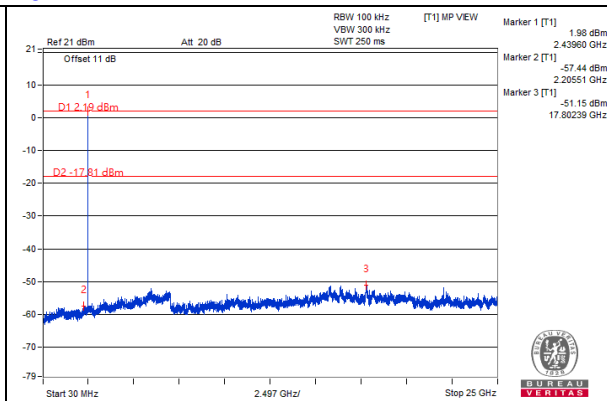
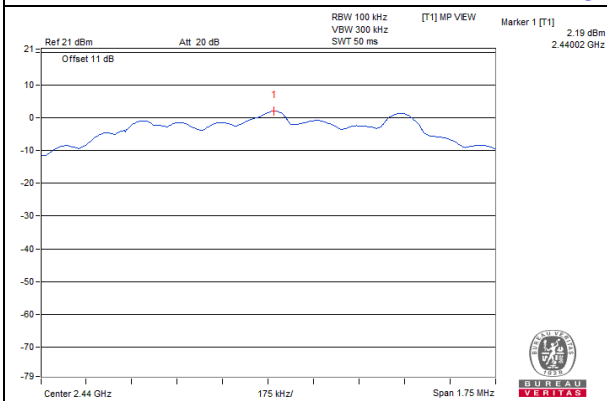

CH 39

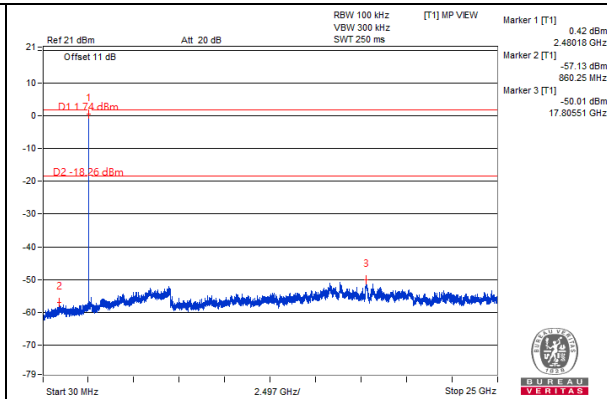
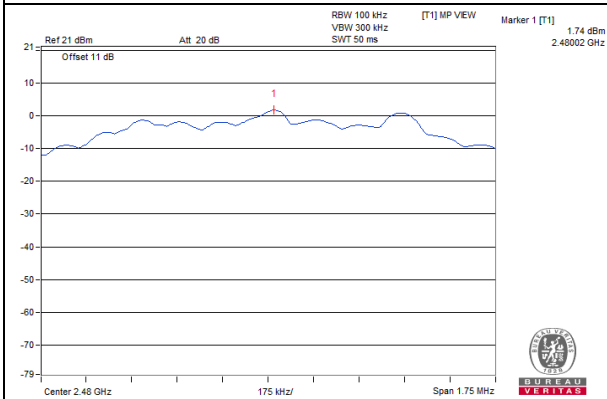

CH 0 Band edge

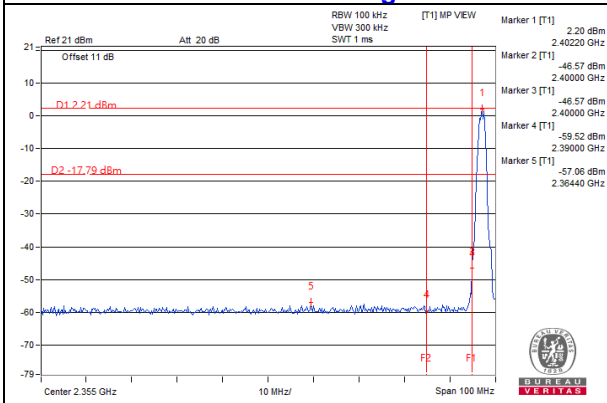

CH 39 Band edge

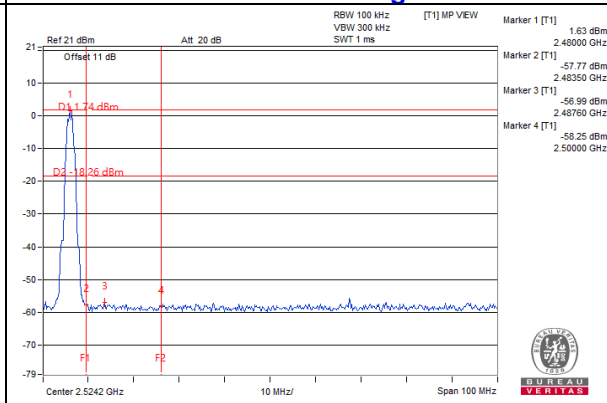

Annex A- Band Edge Measurement

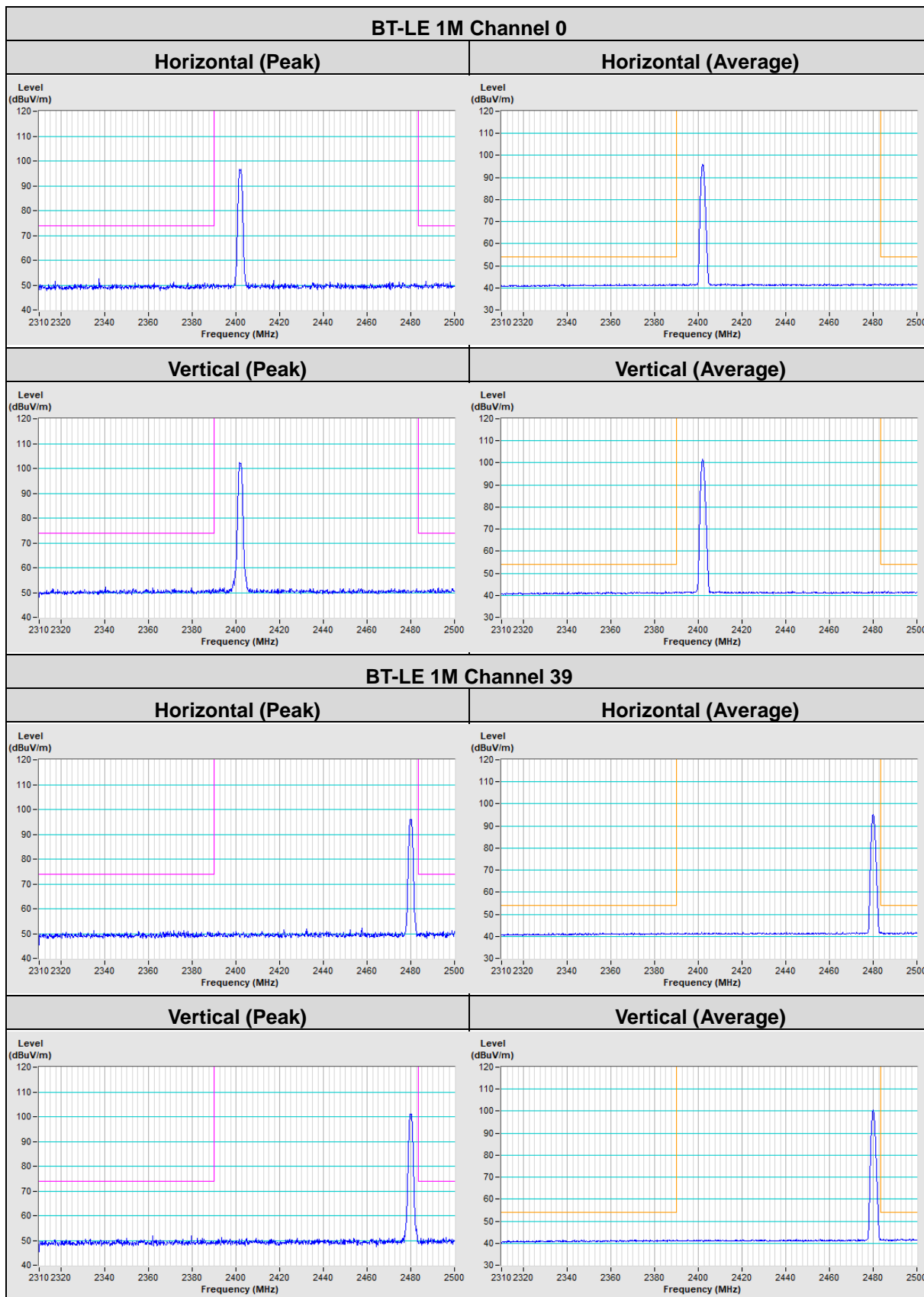

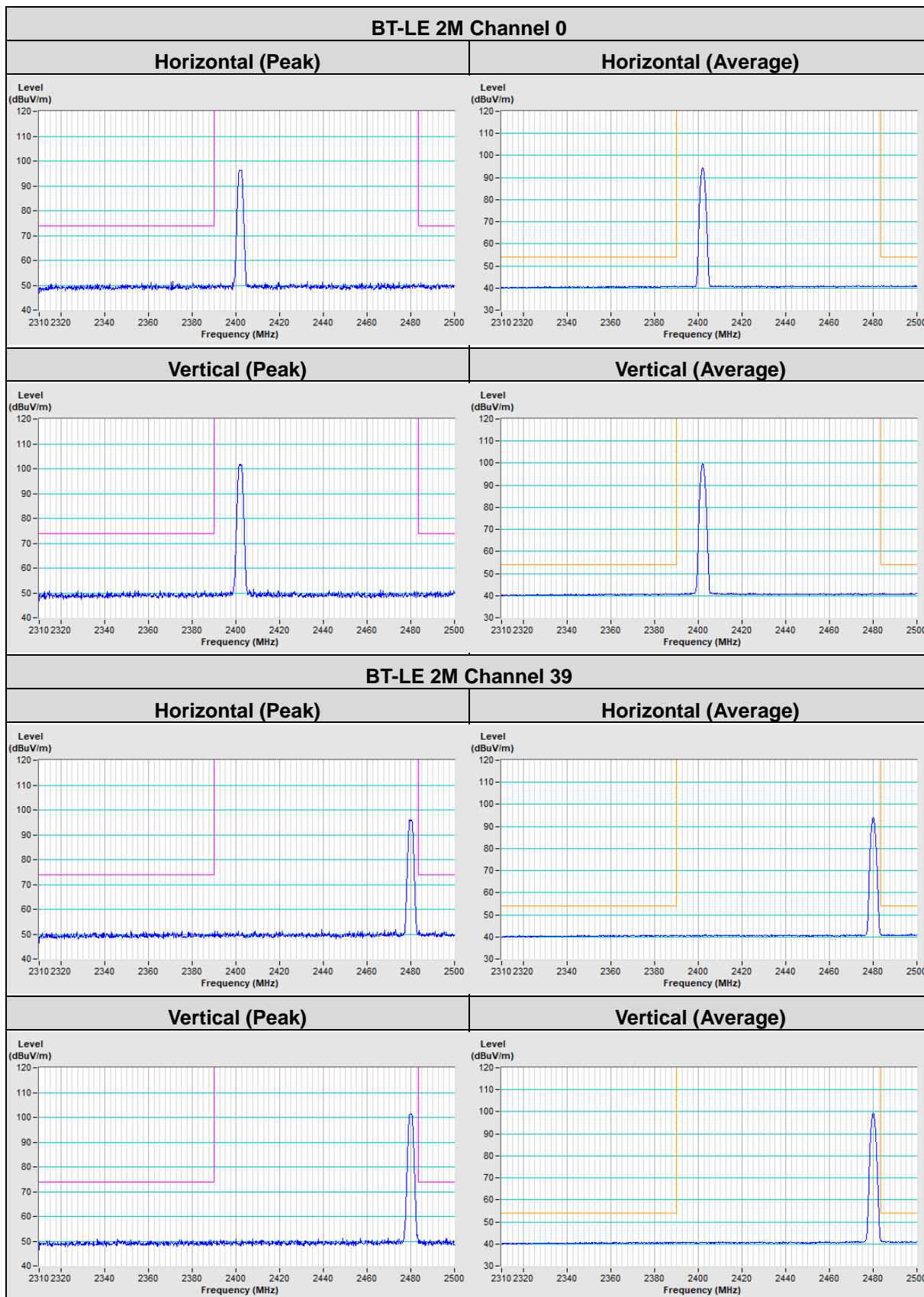

5 Pictures of Test Arrangements

Please refer to the attached file (Test Setup Photo).

Appendix – Information of the Testing Laboratories

We, Bureau Veritas Consumer Products Services (H.K.) Ltd., Taoyuan Branch, were founded in 1988 to provide our best service in EMC, Radio, Telecom and Safety consultation. Our laboratories are FCC recognized accredited test firms and accredited according to ISO/IEC 17025.

If you have any comments, please feel free to contact us at the following:

Lin Kou EMC/RF Lab

Tel: 886-2-26052180

Fax: 886-2-26051924

Hsin Chu EMC/RF/Telecom Lab

Tel: 886-3-6668565

Fax: 886-3-6668323

Hwa Ya EMC/RF/Safety Lab

Tel: 886-3-3183232

Fax: 886-3-3270892

Email: service.adt@tw.bureauveritas.com

Web Site: www.bureauveritas-adt.com

The address and road map of all our labs can be found in our web site also.

--- END ---