

5.5 CONDUCTED BANDEDGE AND SPURIOUS EMISSION

5.5.1 Test Limit

According to §15.247(d),

In any 100 kHz bandwidth outside the authorized frequency band,

Non-restricted bands shall be attenuated at least 20 dB/30 dB relative to the maximum PSD level in 100 kHz by RF conducted or a radiated measurement which fall in the restricted bands, as defined in §15.205(a), must also comply with the radiated emission limits specified in §15.209(a).

5.5.2 Test Procedure

Test method Refer as KDB 558074 D01.

1. EUT RF output port connected to the SA by RF cable, and the path loss was compensated to result.
2. SA setting, RBW=100kHz, VBW=300kHz, Detector=Peak, Trace mode = max hold, SWT = Auto.
3. In any 100 kHz bandwidth outside the authorized frequency band, shall be attenuated at least 20 dB relative to the maximum in-band peak PSD level in 100 kHz when conducted power procedure is used. If the transmitter complies with the conducted power limits based on the use of RMS averaging over a time interval, the attenuation required under this paragraph shall be 30 dB instead of 20 dB.

5.5.3 Test Setup

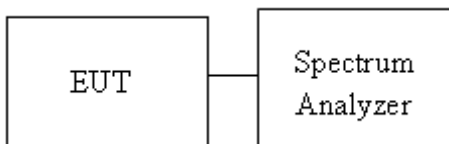

Report No.: T190902W03-RP1

5.5.4 Test Result

Test Data

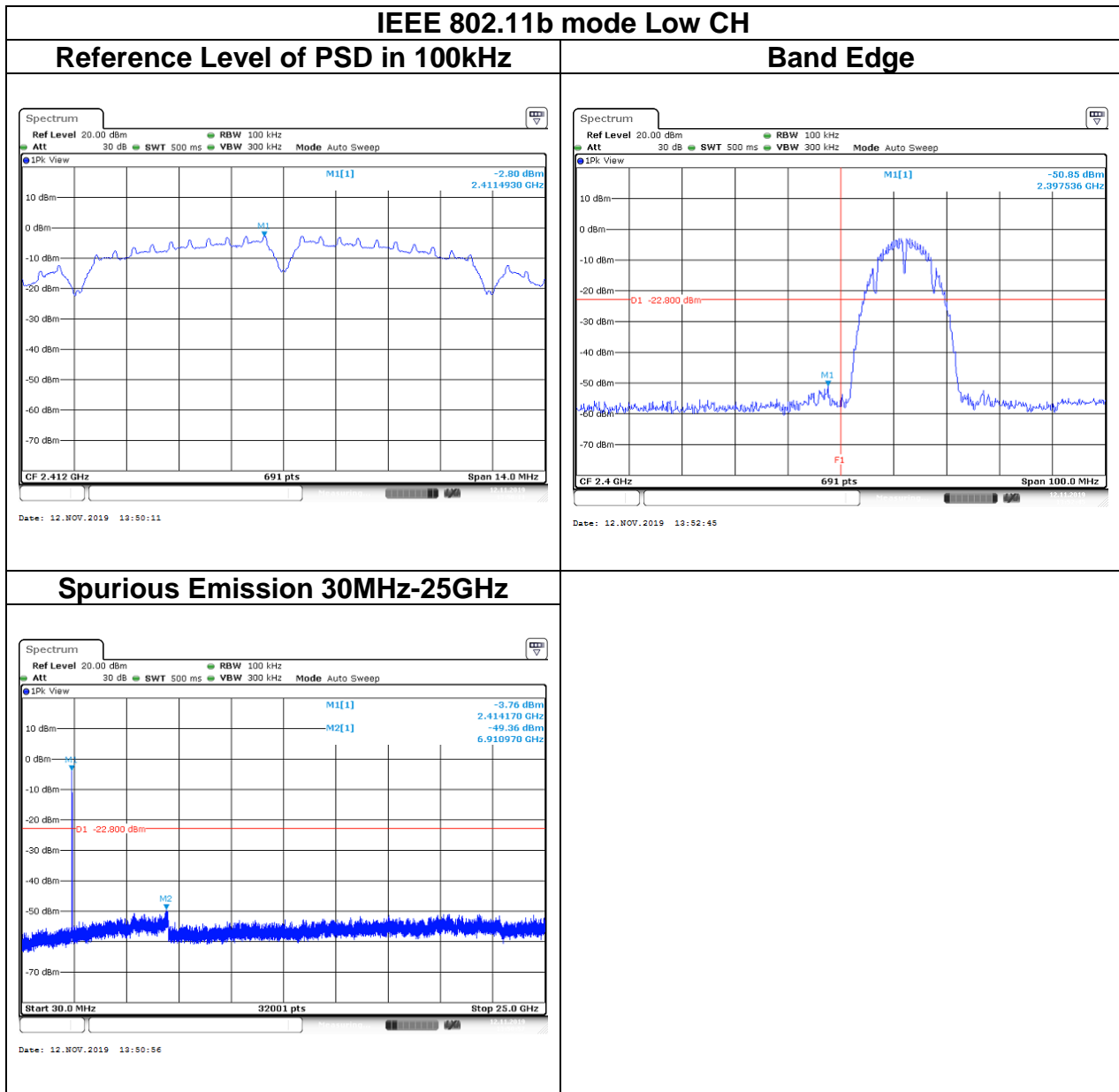

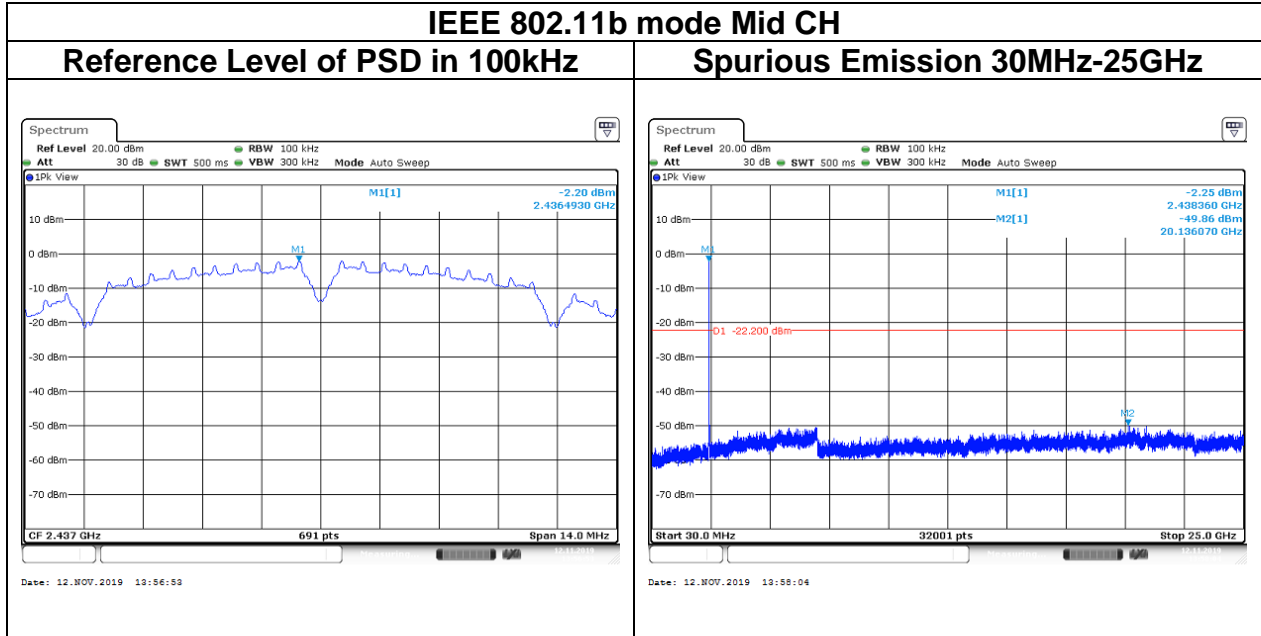

Report No.: T190902W03-RP1

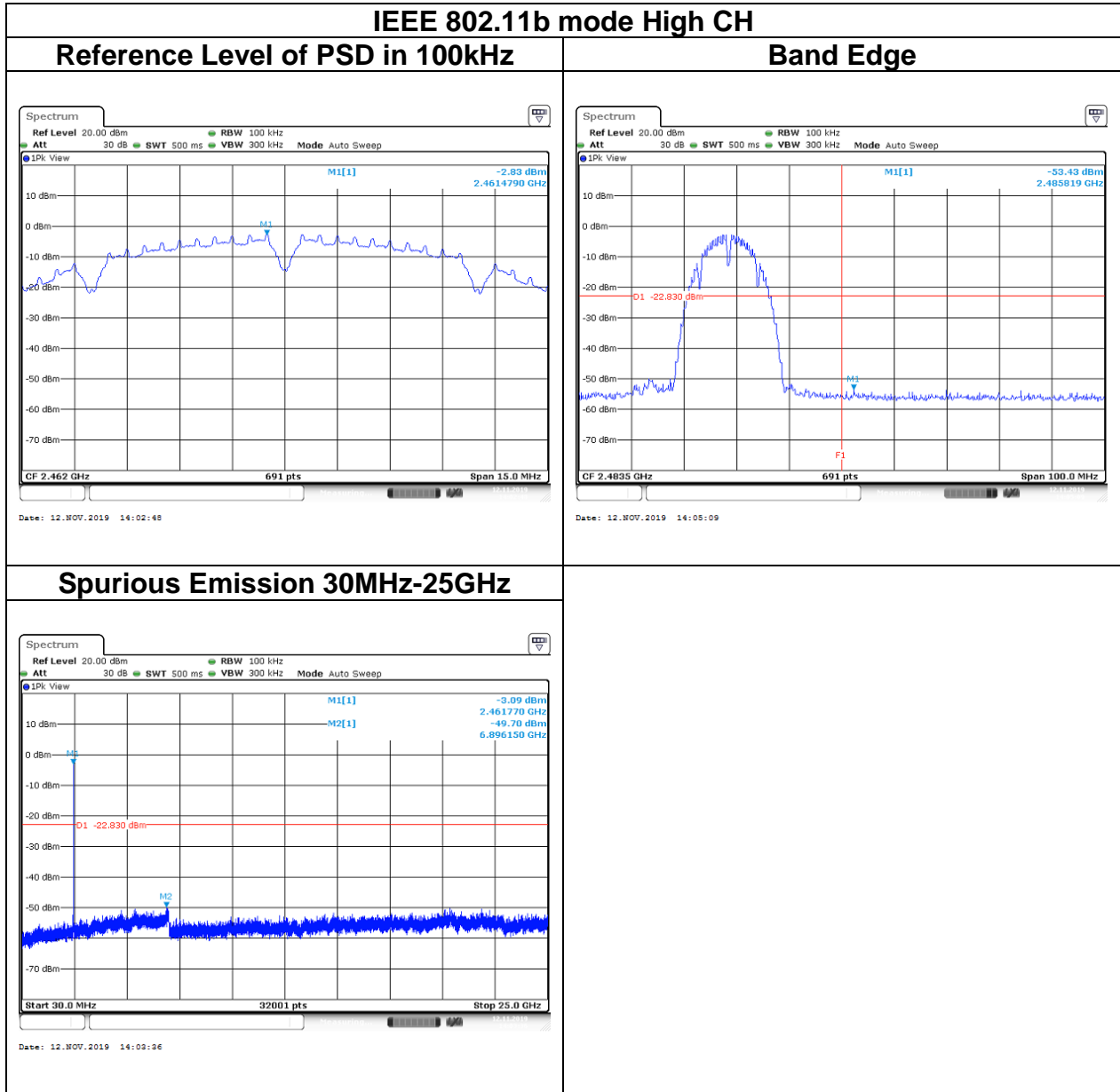

Report No.: T190902W03-RP1

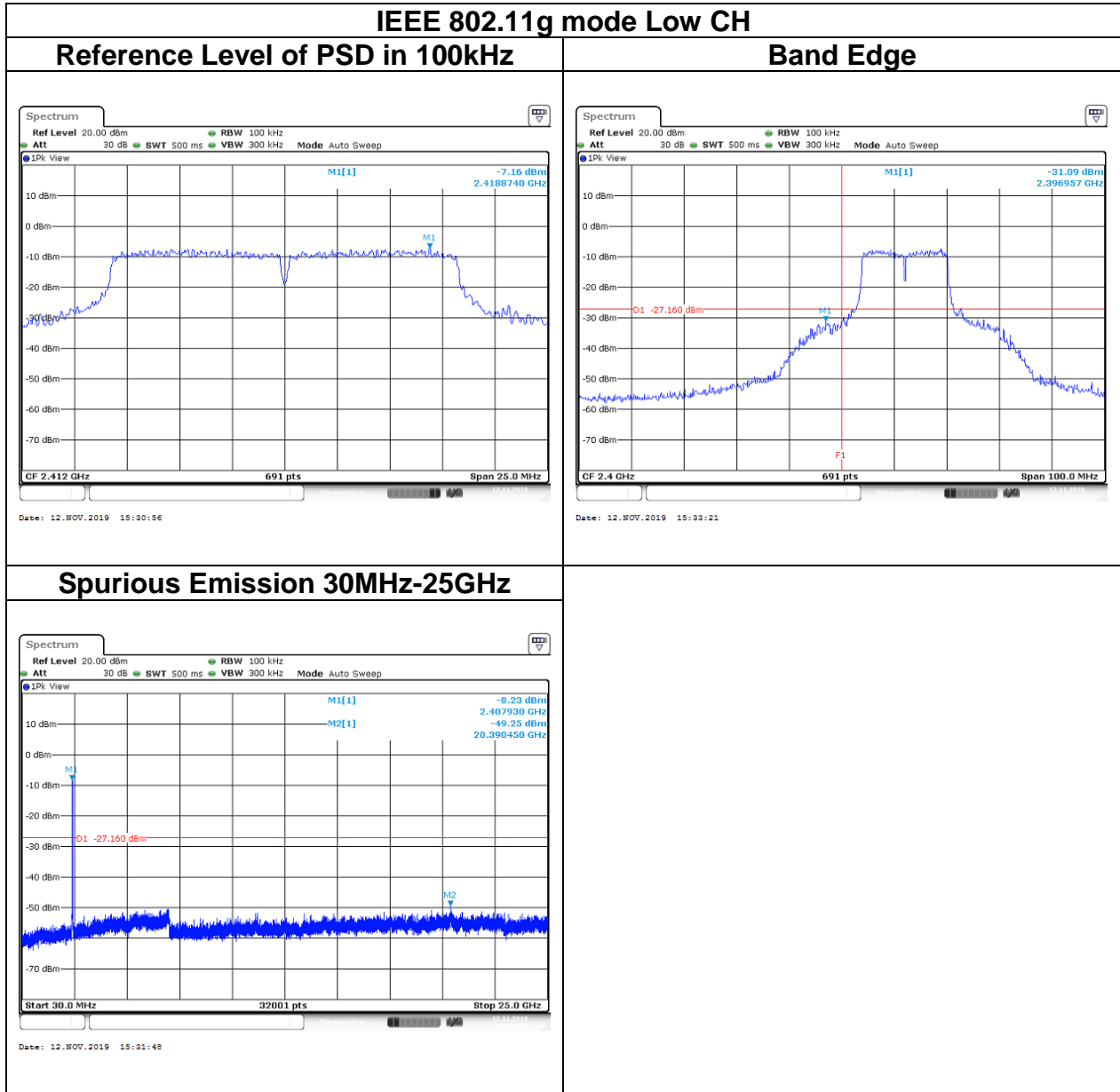

Report No.: T190902W03-RP1

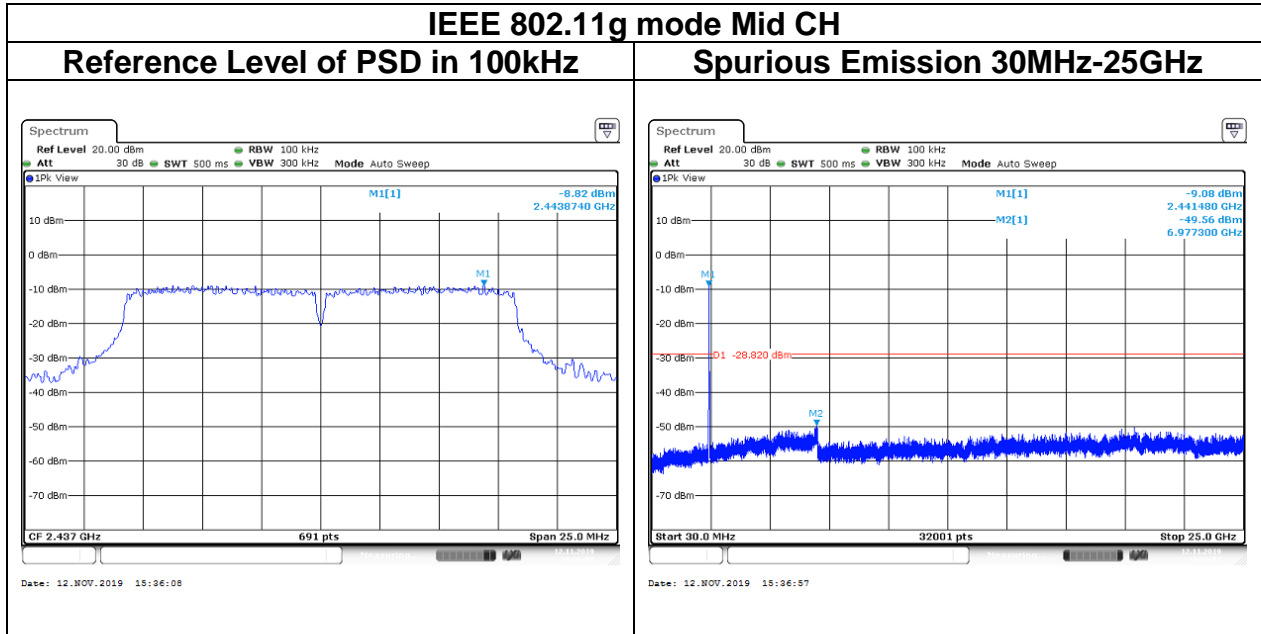

Report No.: T190902W03-RP1

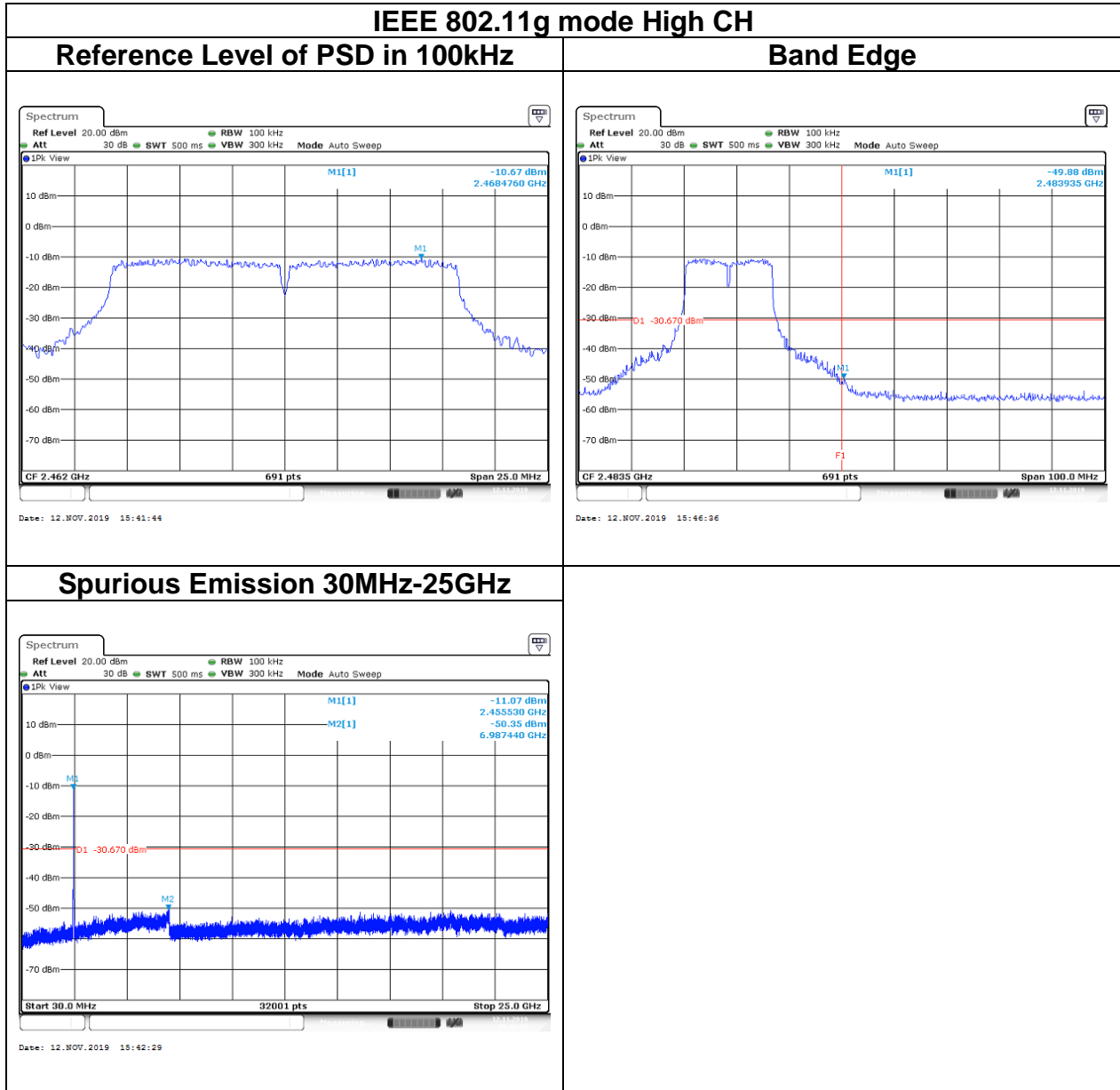

Report No.: T190902W03-RP1

Chain A

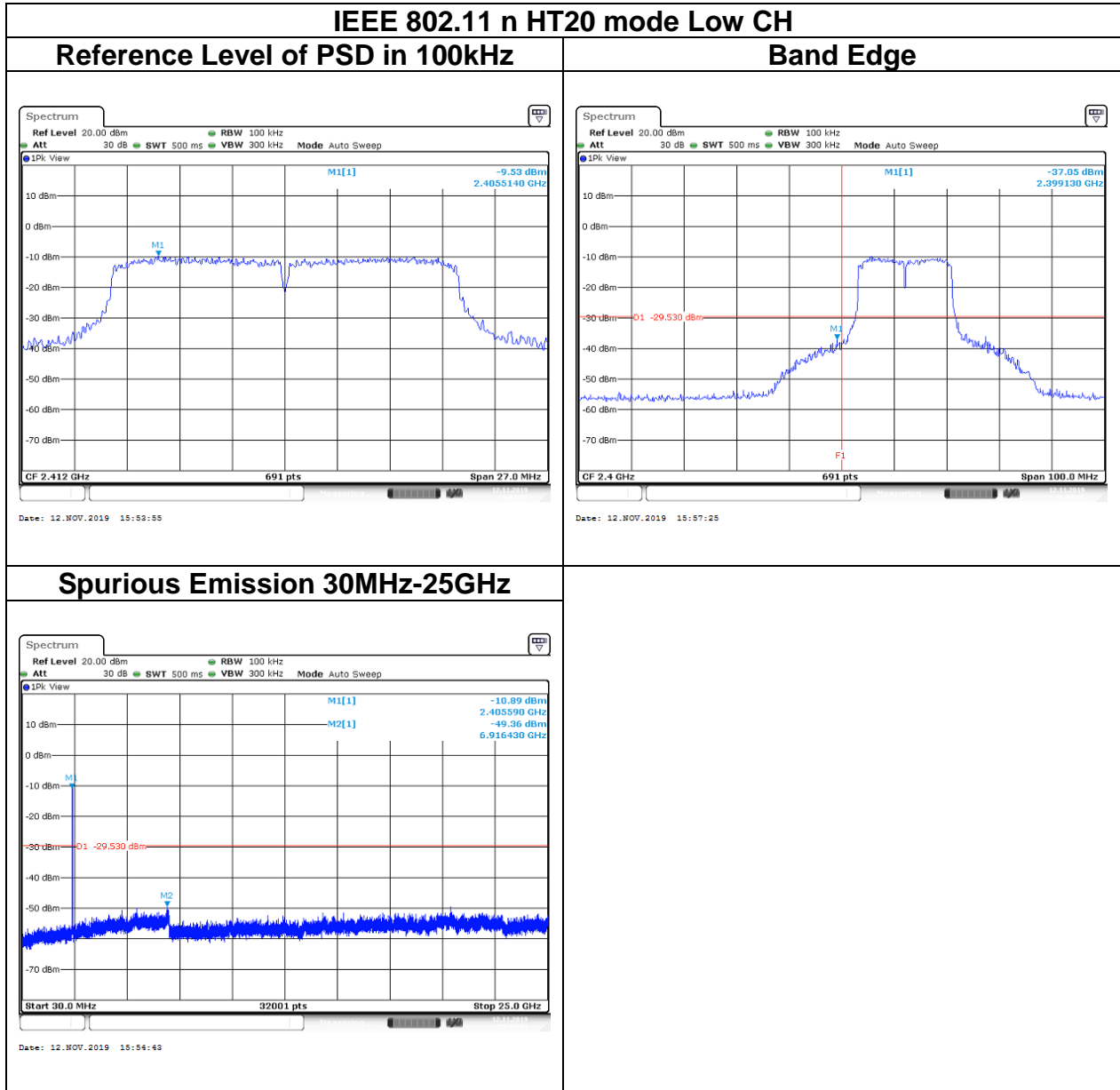

Report No.: T190902W03-RP1

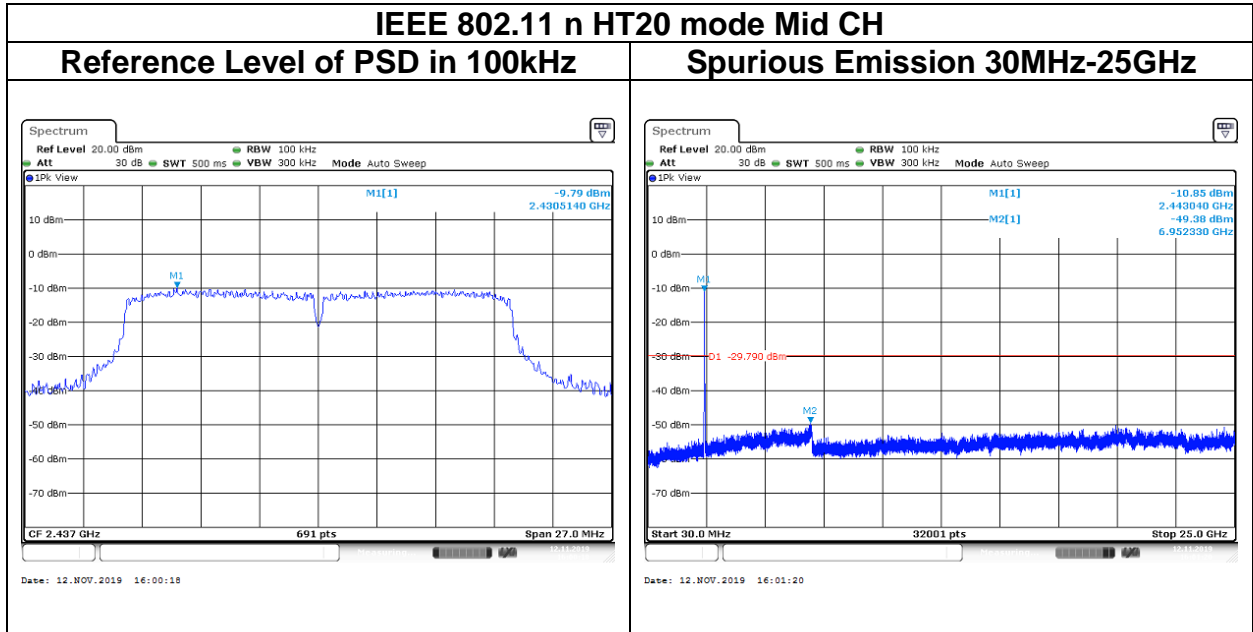

Report No.: T190902W03-RP1

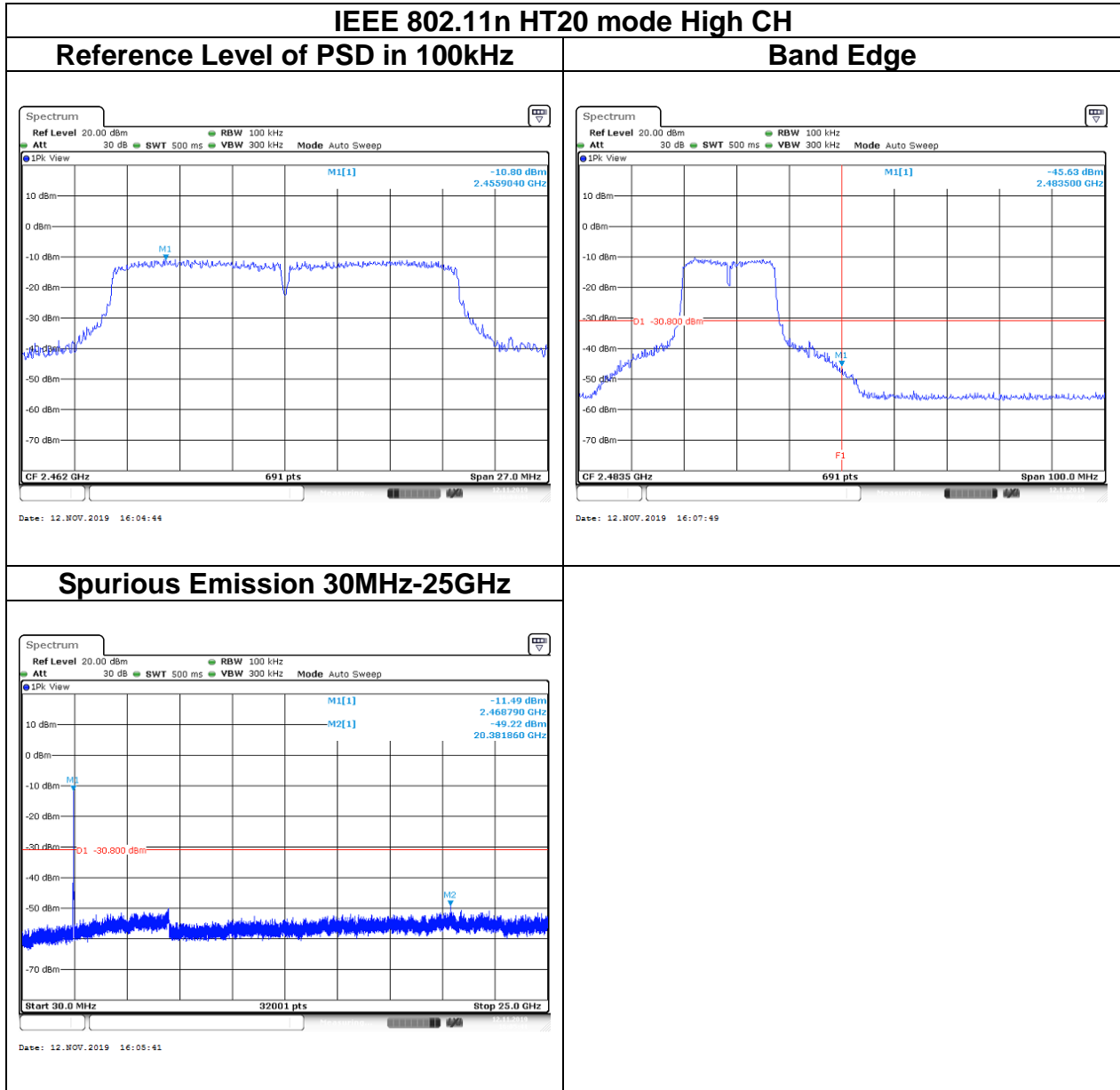

Report No.: T190902W03-RP1

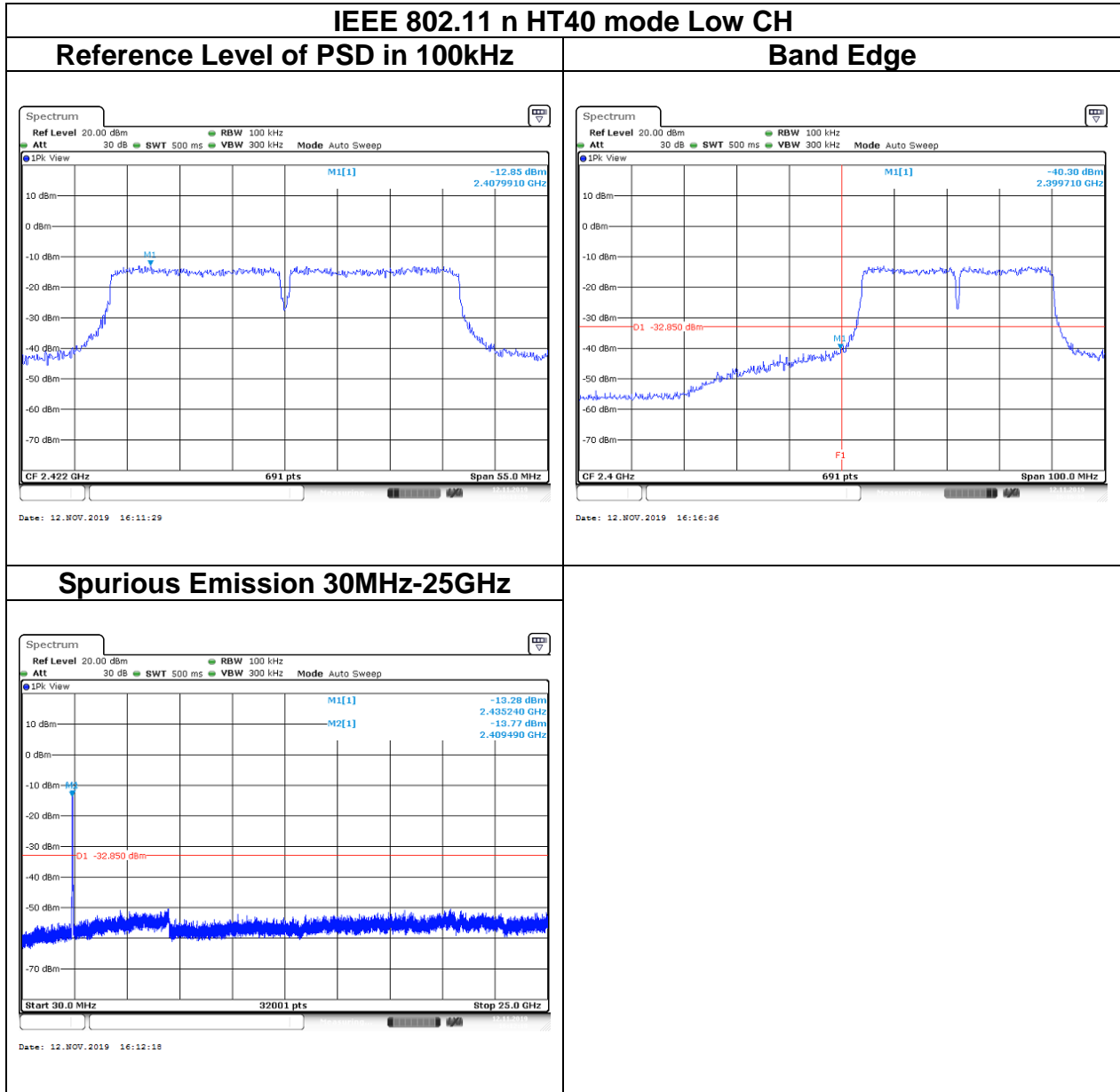

Report No.: T190902W03-RP1

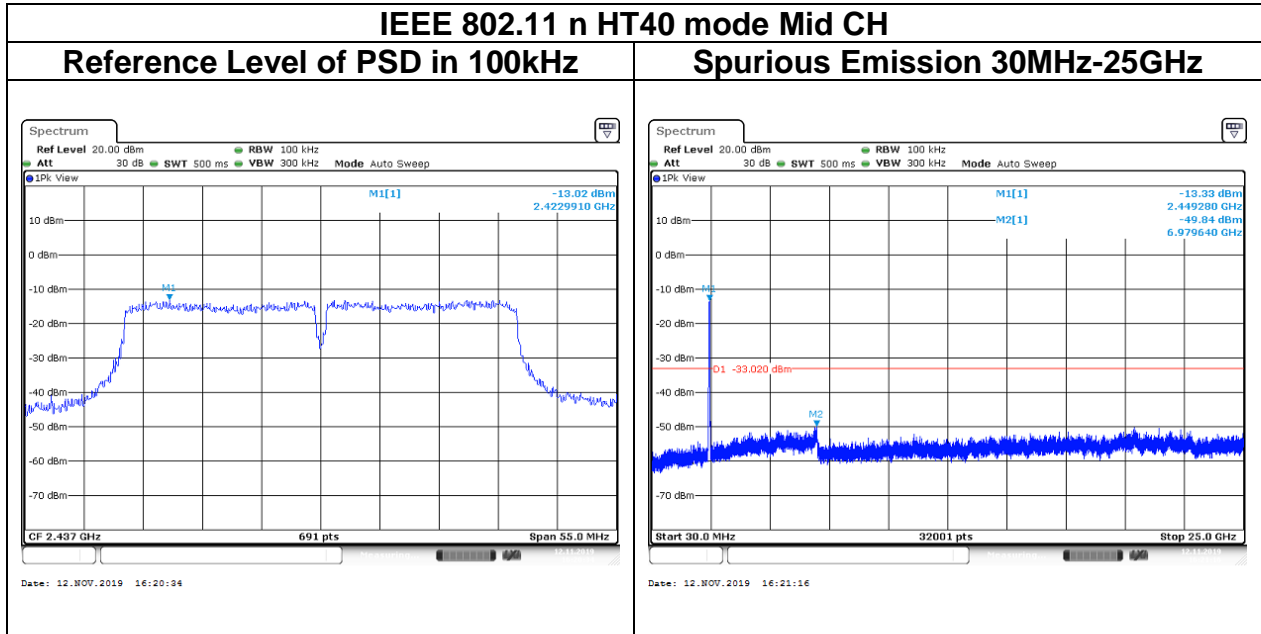

Report No.: T190902W03-RP1

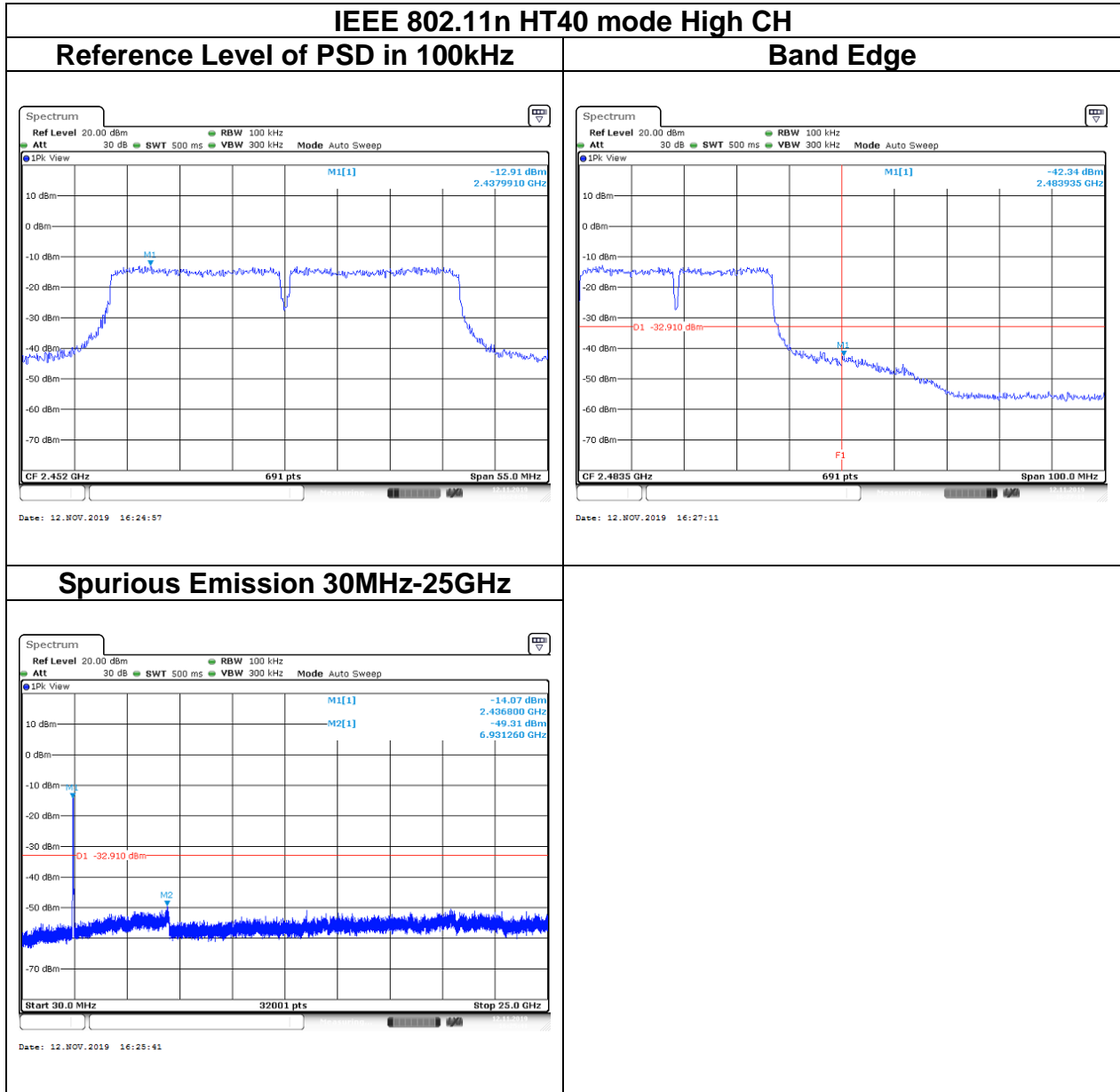

Report No.: T190902W03-RP1

Chain B

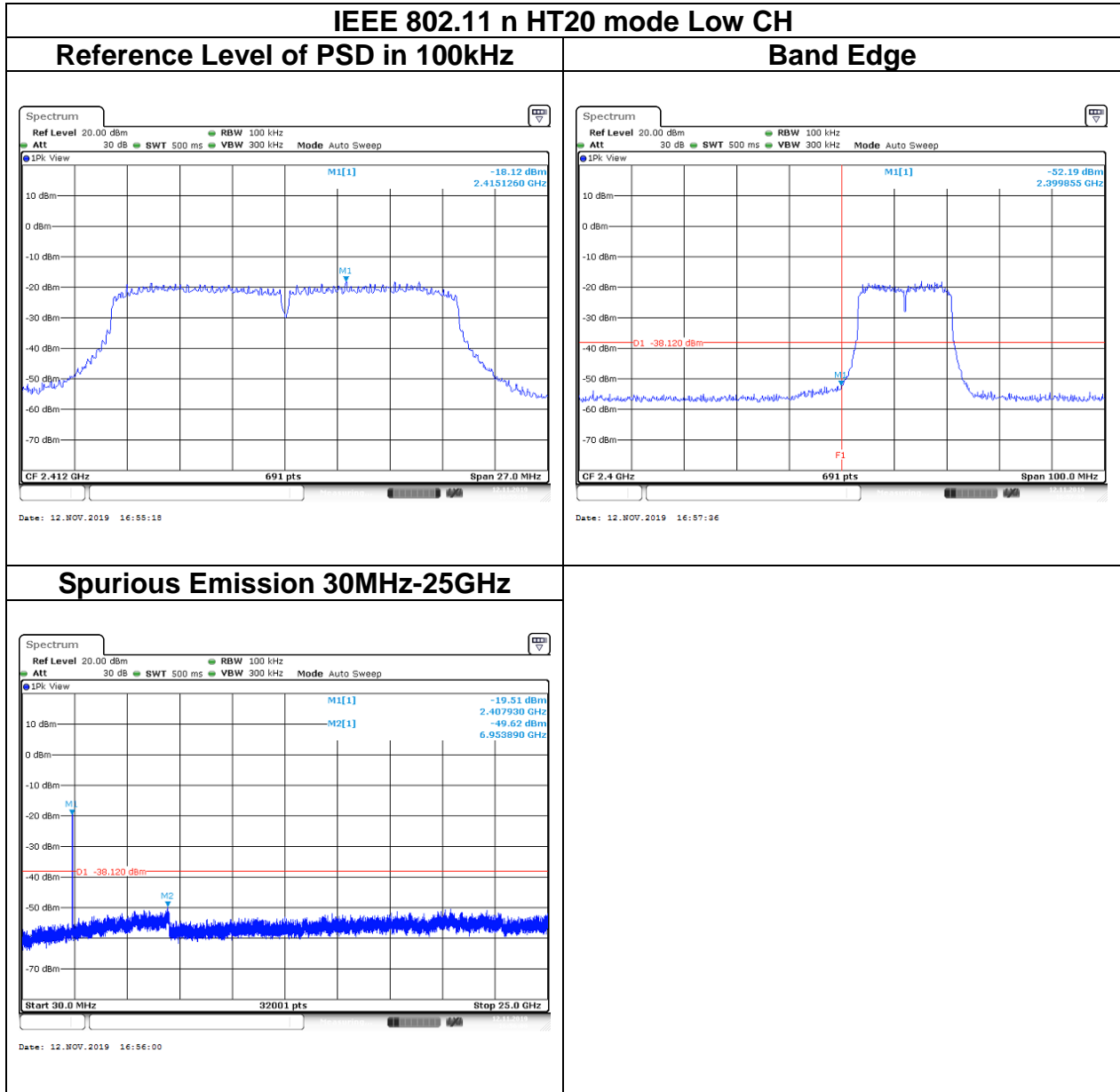

Report No.: T190902W03-RP1

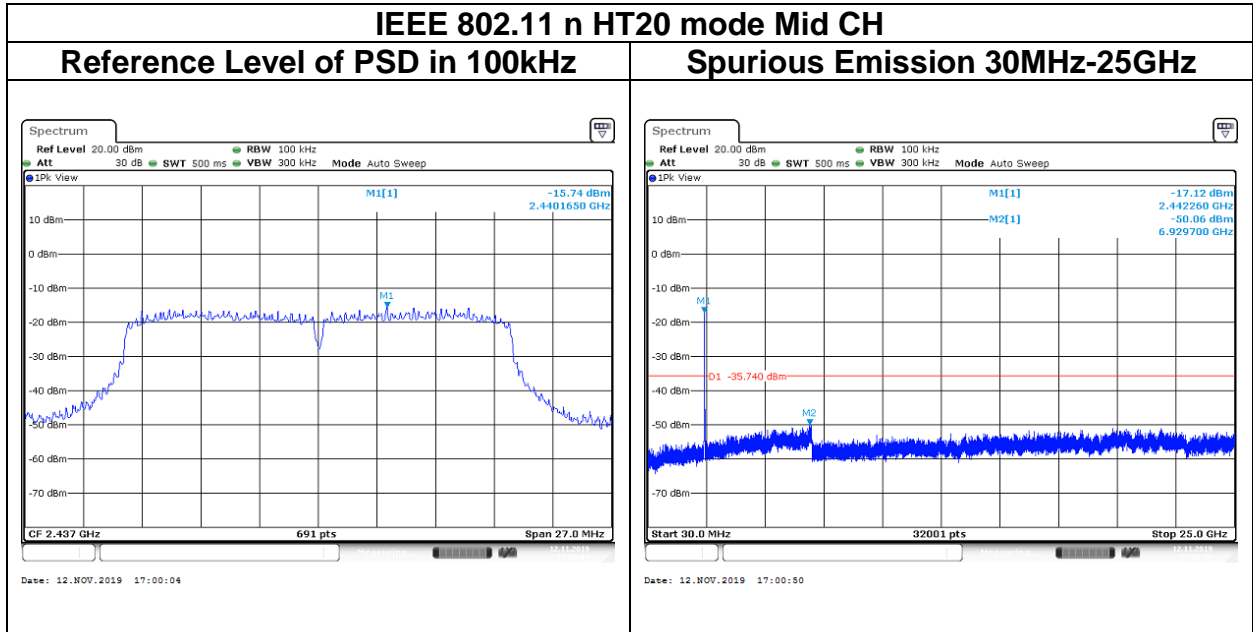

Report No.: T190902W03-RP1

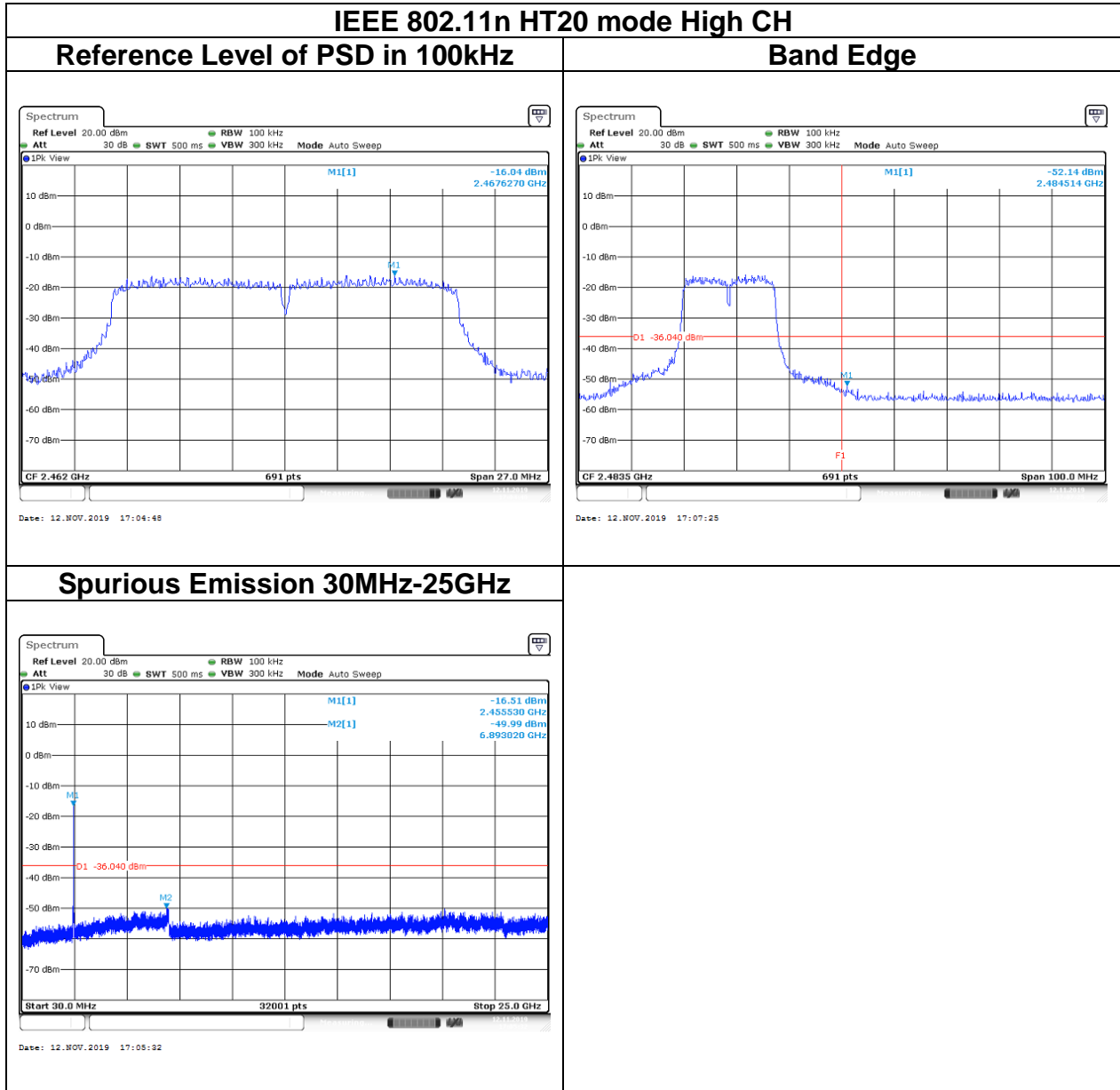

Report No.: T190902W03-RP1

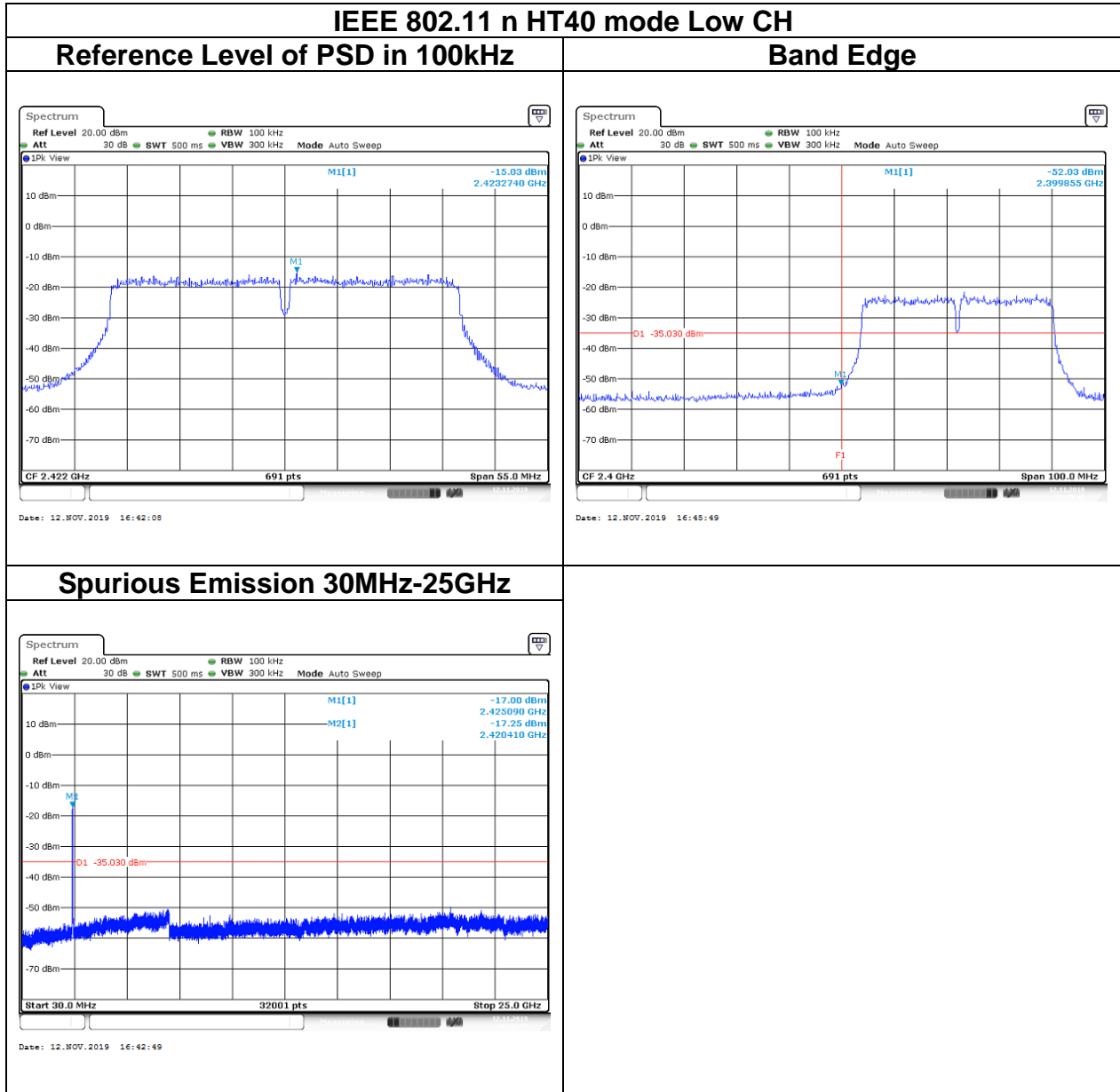

Report No.: T190902W03-RP1

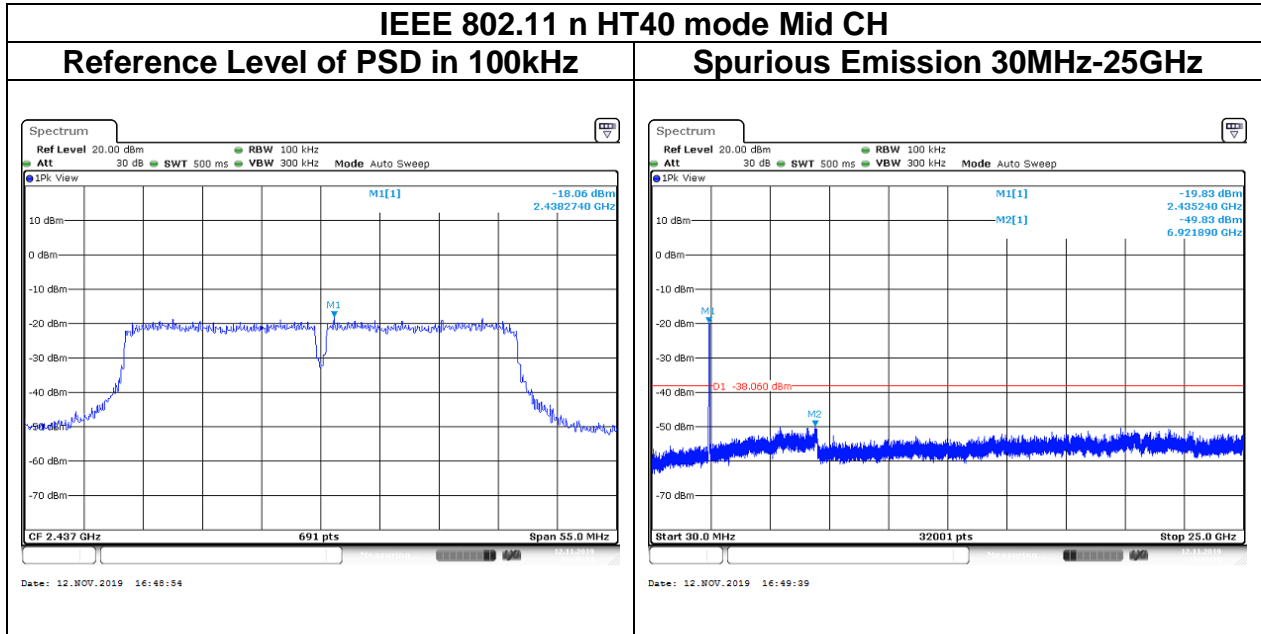

Report No.: T190902W03-RP1

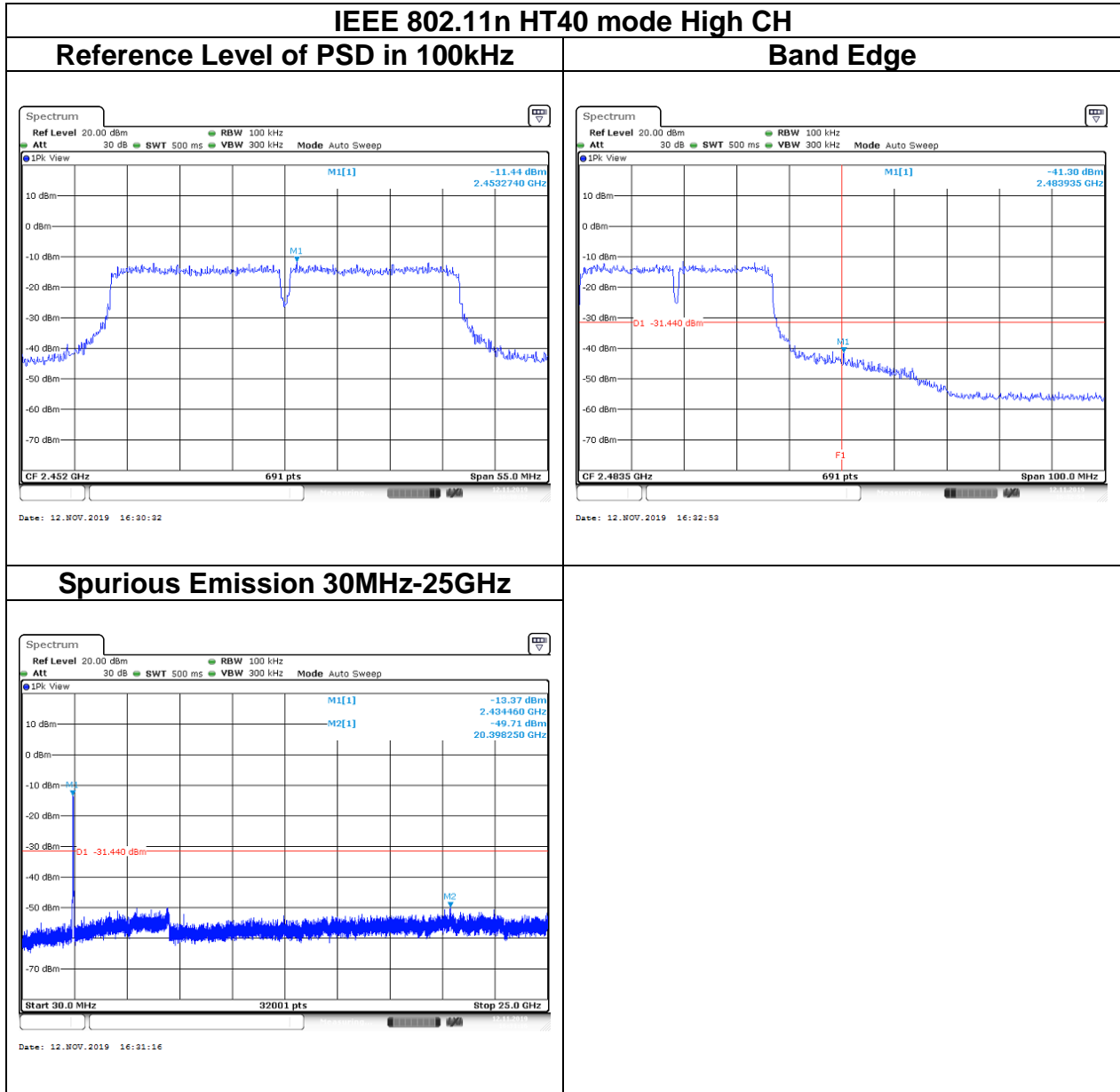

Report No.: T190902W03-RP1

5.6 RADIATION BANDEDGE AND SPURIOUS EMISSION

5.6.1 Test Limit

FCC according to §15.247(d), §15.209 and §15.205,

In any 100 kHz bandwidth outside the authorized frequency band, all harmonic and spurious must be least 20 dB below the highest emission level with the authorized frequency band. Radiation emission which fall in the restricted bands must also follow the FCC section 15.209 as below limit in table.

Below 30 MHz

Frequency	Field Strength (microvolts/m)	Magnetic H-Field (microamperes/m)	Measurement Distance (metres)
9-490 kHz	2,400/F (F in kHz)	2,400/F (F in kHz)	300
490-1,705 kHz	24,000/F (F in kHz)	24,000/F (F in kHz)	30
1.705-30 MHz	30	N/A	30

Above 30 MHz

Frequency	Field Strength (microvolts/m)	Measurement Distance (metres)
30-88	100	3
88-216	150	3
216-960	200	3
Above 960	500	3

Report No.: T190902W03-RP1

5.6.2 Test Procedure

Test method Refer as KDB 558074 D01.

1. The EUT is placed on a turntable, Above 1 GHz is 1.5m and below 1 GHz is 0.8m above ground plane. The EUT Configured un accordance with ANSI C63.10: 2013, and the EUT set in a continuous mode.
2. The turntable shall be rotated for 360 degrees to determine the position of maximum emission level. And EUT is set 3m away from the receiving antenna, which is scanned from 1m to 4m above the ground plane to find out the highest emissions. Measurement are made polarized in both the vertical and the horizontal positions with antenna.
3. Span shall wide enough to full capture the emission measured. The SA from 9kHz to 26.5GHz set to the low, Mid and High channels with the EUT transmit.

Note: No emission found between lowest internal used/generated frequency to 30MHz (9KHz~30MHz)

Remark:

1. Although these tests were performed other than open area test site, adequate comparison measurements were confirmed against 30 m open are test site. Therefore sufficient tests were made to demonstrate that the alternative site produces results that correlate with the ones of tests made in an open field based on KDB 414788.

4. The SA setting following :

- (1) Below 1G : RBW = 100kHz, VBW \geq 3 RBW, Sweep = Auto, Detector = Peak, Trace = Max hold.
- (2) Above 1G :
 - (2.1) For Peak measurement : RBW = 1MHz, VBW \geq 3 RBW, Sweep = Auto, Detector = Peak, Trace = Max hold.
 - (2.2) For Average measurement : RBW = 1MHz, VBW
 - *If Duty Cycle \geq 98%, VBW=10Hz.
 - *If Duty Cycle < 98%, VBW=1/T.

Configuration	Duty Cycle (%)	T(ms)	1/T (kHz)	VBW Setting
802.11b	100%	1.0000	-	10Hz
802.11g	100%	1.0000	-	10Hz
802.11n HT20	100%	1.0000	-	10Hz
802.11n HT40	100%	1.0000	-	10Hz

Report No.: T190902W03-RP1

5.6.3 Test Setup

9kHz ~ 30MHz

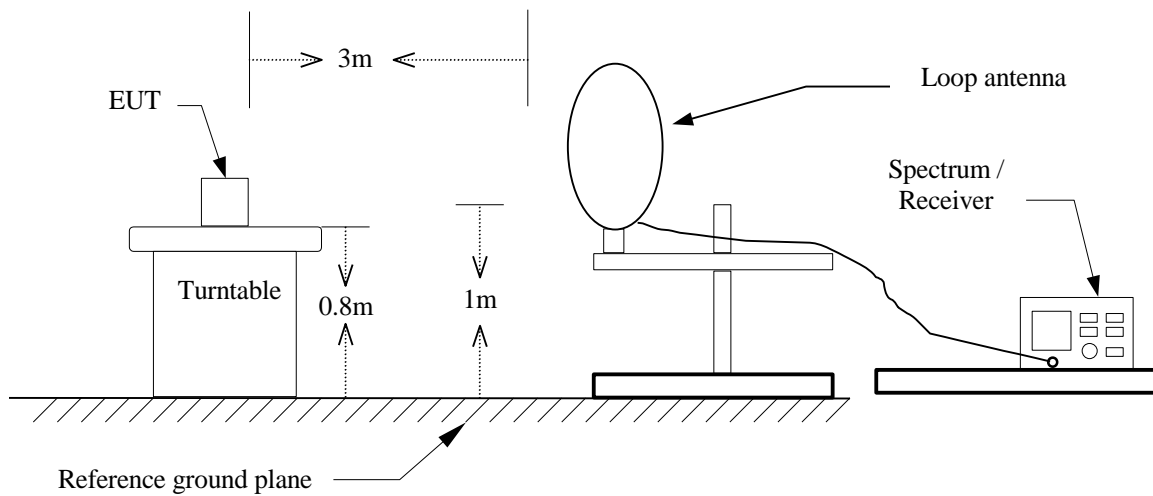

30MHz ~ 1GHz

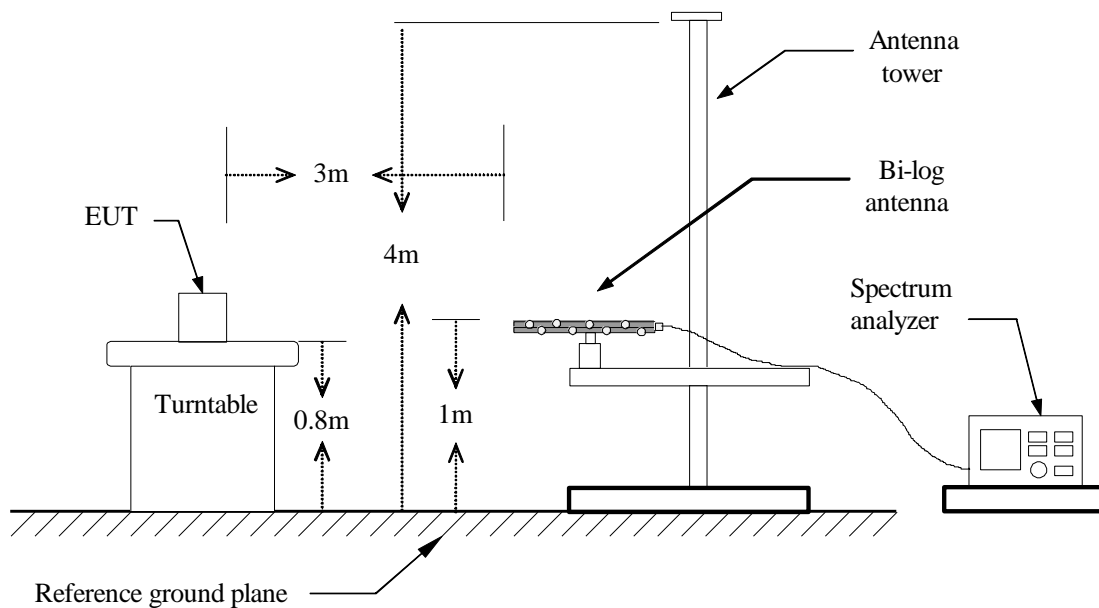

Above 1 GHz

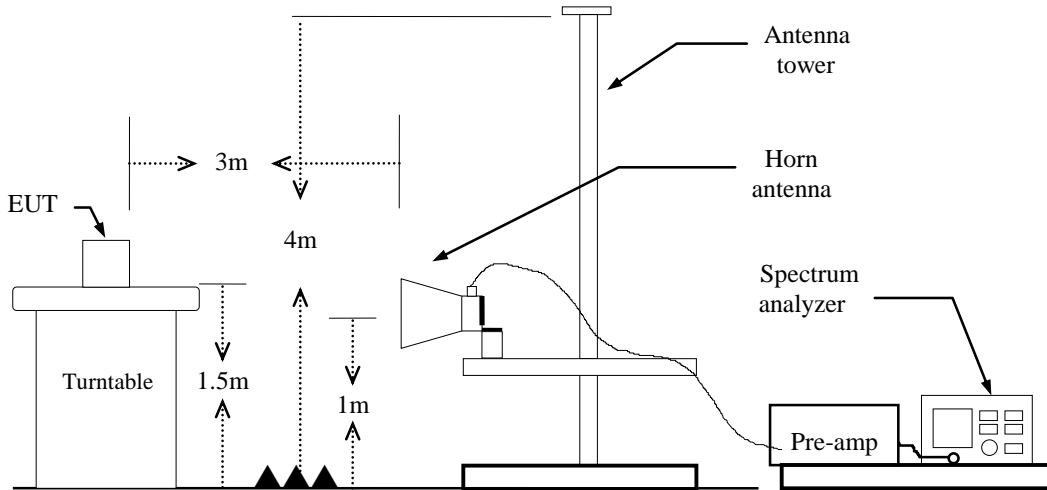

Report No.: T190902W03-RP1

5.6.4 Test Result

Band Edge Test Data

Test Mode	IEEE 802.11b Low CH	Temp/Hum	23.4(°C)/ 50%RH
Test Item	Band Edge	Test Date	November 8, 2019
Polarize	Vertical	Test Engineer	Dally Hong
Detector	Peak / Average		

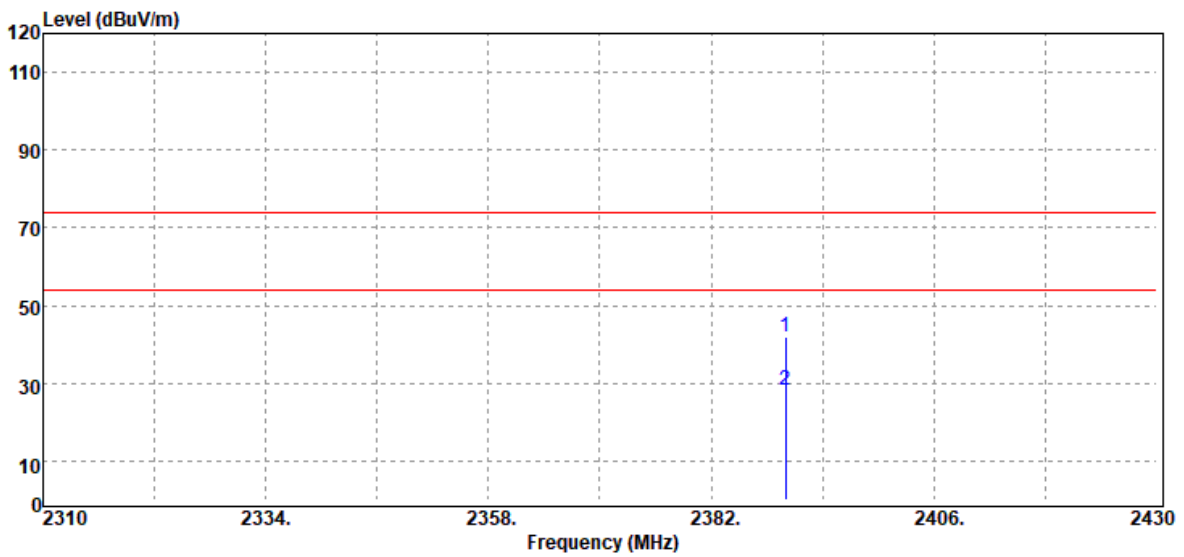

Freq. MHz	Detector Mode PK/QP/AV	Spectrum Reading Level dB μ V	Factor dB	Actual FS dB μ V/m	Limit @3m dB μ V/m	Margin dB
2390.00	Peak	51.76	-9.79	41.97	74.00	-32.03
2390.00	Average	38.13	-9.79	28.34	54.00	-25.66

Report No.: T190902W03-RP1

Test Mode	IEEE 802.11b Low CH	Temp/Hum	23.4(°C)/ 50%RH
Test Item	Band Edge	Test Date	November 8, 2019
Polarize	Horizontal	Test Engineer	Dally Hong
Detector	Peak / Average		

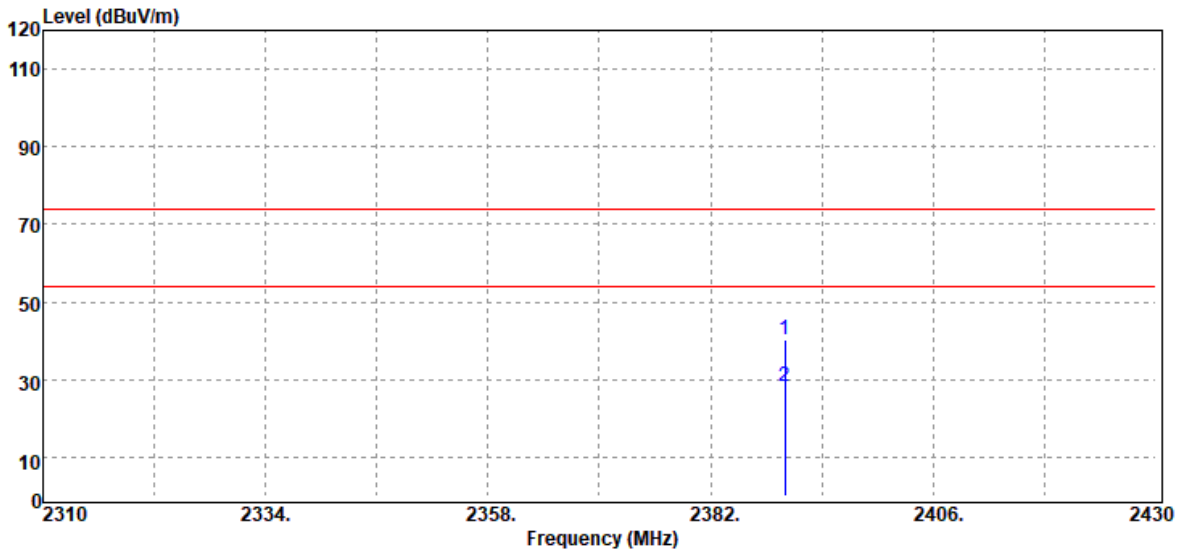

Freq. MHz	Detector Mode PK/QP/AV	Spectrum Reading Level dB μ V	Factor dB	Actual FS dB μ V/m	Limit @3m dB μ V/m	Margin dB
2390.00	Peak	50.25	-9.79	40.46	74.00	-33.54
2390.00	Average	38.11	-9.79	28.32	54.00	-25.68

Report No.: T190902W03-RP1

Test Mode	IEEE 802.11b high CH	Temp/Hum	23.4(°C)/ 50%RH
Test Item	Band Edge	Test Date	November 8, 2019
Polarize	Vertical	Test Engineer	Dally Hong
Detector	Peak / Average		

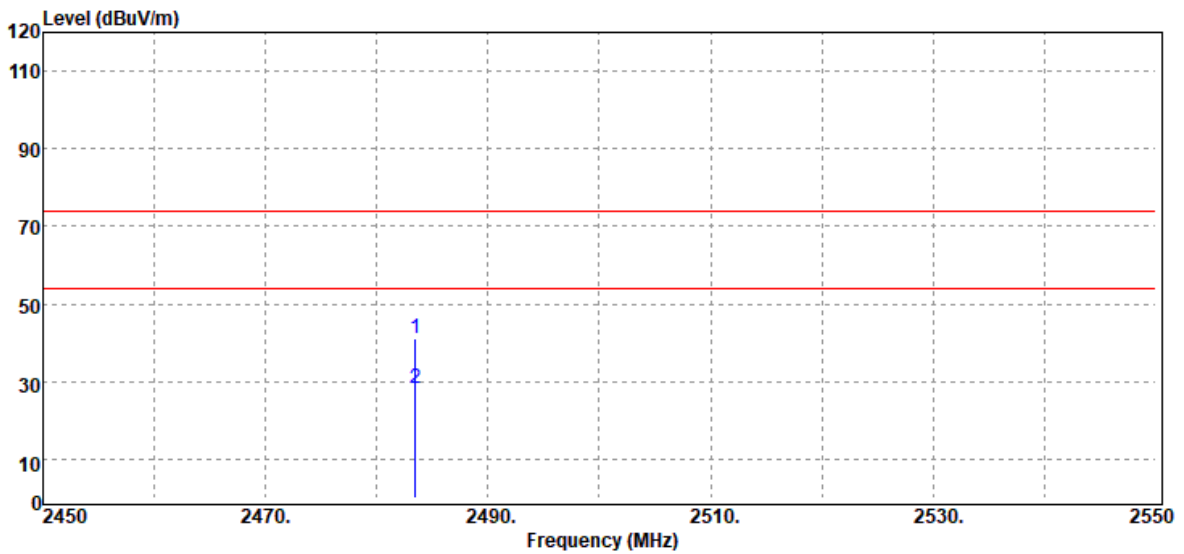

Freq. MHz	Detector Mode PK/QP/AV	Spectrum Reading Level dB μ V	Factor dB	Actual FS dB μ V/m	Limit @3m dB μ V/m	Margin dB
2483.50	Peak	50.43	-9.40	41.03	74.00	-32.97
2483.50	Average	37.81	-9.40	28.41	54.00	-25.59

Report No.: T190902W03-RP1

Test Mode	IEEE 802.11b high CH	Temp/Hum	23.4(°C)/ 50%RH
Test Item	Band Edge	Test Date	November 8, 2019
Polarize	Horizontal	Test Engineer	Dally Hong
Detector	Peak / Average		

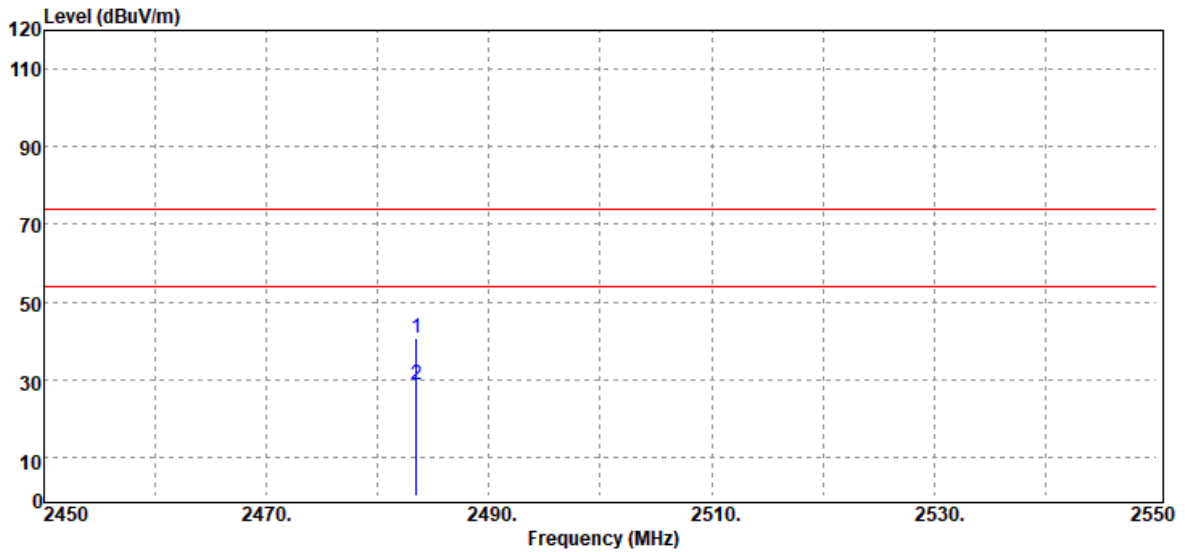

Freq. MHz	Detector Mode PK/QP/AV	Spectrum Reading Level dB μ V	Factor dB	Actual FS dB μ V/m	Limit @3m dB μ V/m	Margin dB
2483.50	Peak	50.00	-9.40	40.60	74.00	-33.40
2483.50	Average	37.98	-9.40	28.58	54.00	-25.42

Report No.: T190902W03-RP1

Test Mode	IEEE 802.11g Low CH	Temp/Hum	23.4(°C)/ 50%RH
Test Item	Band Edge	Test Date	November 8, 2019
Polarize	Vertical	Test Engineer	Dally Hong
Detector	Peak / Average		

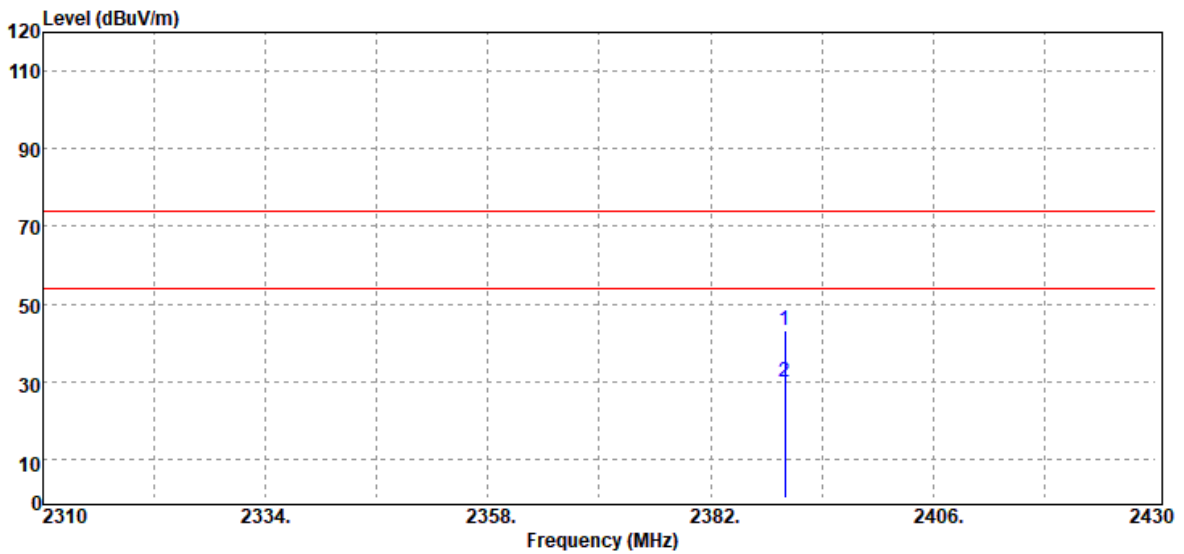

Freq. MHz	Detector Mode PK/QP/AV	Spectrum Reading Level dB μ V	Factor dB	Actual FS dB μ V/m	Limit @3m dB μ V/m	Margin dB
2390.00	Peak	53.16	-9.79	43.37	74.00	-30.63
2390.00	Average	39.71	-9.79	29.92	54.00	-24.08

Report No.: T190902W03-RP1

Test Mode	IEEE 802.11g Low CH	Temp/Hum	23.4(°C)/ 50%RH
Test Item	Band Edge	Test Date	November 8, 2019
Polarize	Horizontal	Test Engineer	Dally Hong
Detector	Peak / Average		

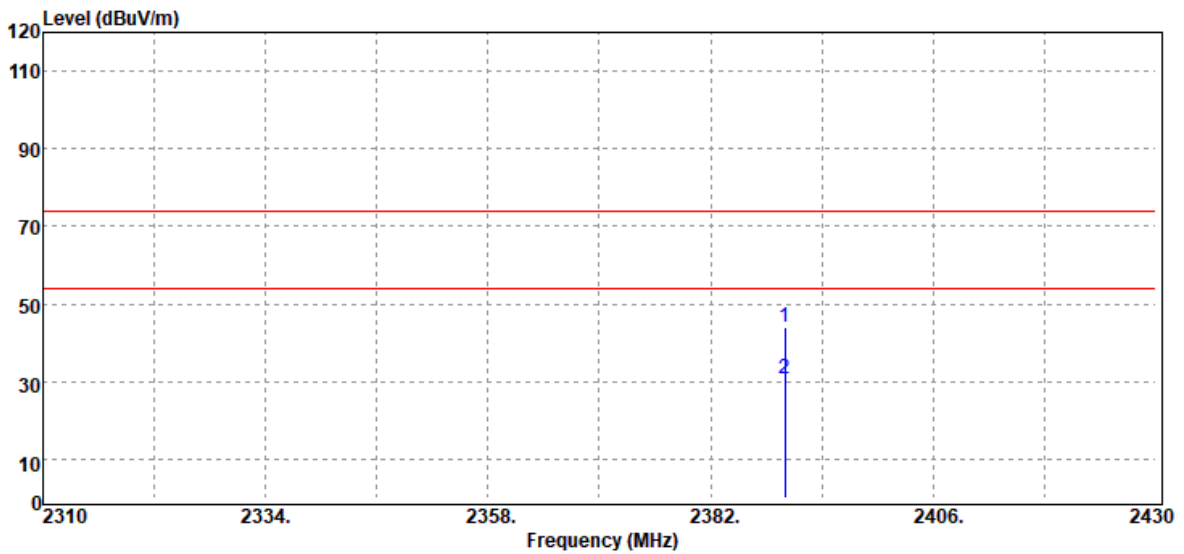

Freq. MHz	Detector Mode PK/QP/AV	Spectrum Reading Level dB μ V	Factor dB	Actual FS dB μ V/m	Limit @3m dB μ V/m	Margin dB
2390.00	Peak	53.89	-9.79	44.10	74.00	-29.90
2390.00	Average	40.66	-9.79	30.87	54.00	-23.13

Report No.: T190902W03-RP1

Test Mode	IEEE 802.11g high CH	Temp/Hum	23.4(°C)/ 50%RH
Test Item	Band Edge	Test Date	November 8, 2019
Polarize	Vertical	Test Engineer	Dally Hong
Detector	Peak / Average		

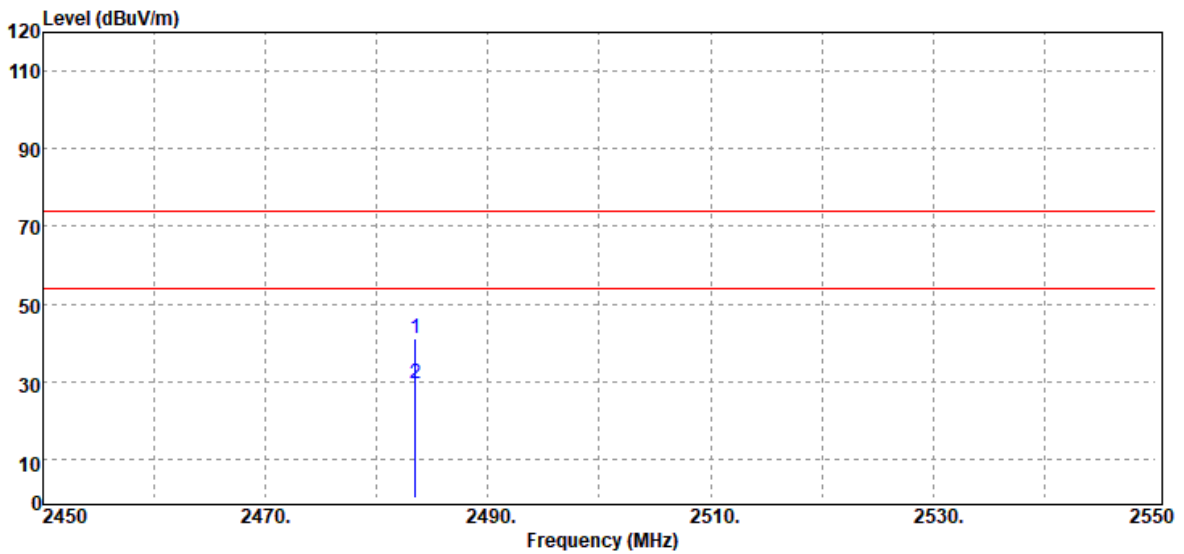

Freq. MHz	Detector Mode PK/QP/AV	Spectrum Reading Level dB μ V	Factor dB	Actual FS dB μ V/m	Limit @3m dB μ V/m	Margin dB
2483.50	Peak	50.35	-9.40	40.95	74.00	-33.05
2483.50	Average	38.78	-9.40	29.38	54.00	-24.62

Report No.: T190902W03-RP1

Test Mode	IEEE 802.11g Low CH	Temp/Hum	23.4(°C)/ 50%RH
Test Item	Band Edge	Test Date	November 8, 2019
Polarize	Horizontal	Test Engineer	Dally Hong
Detector	Peak / Average		

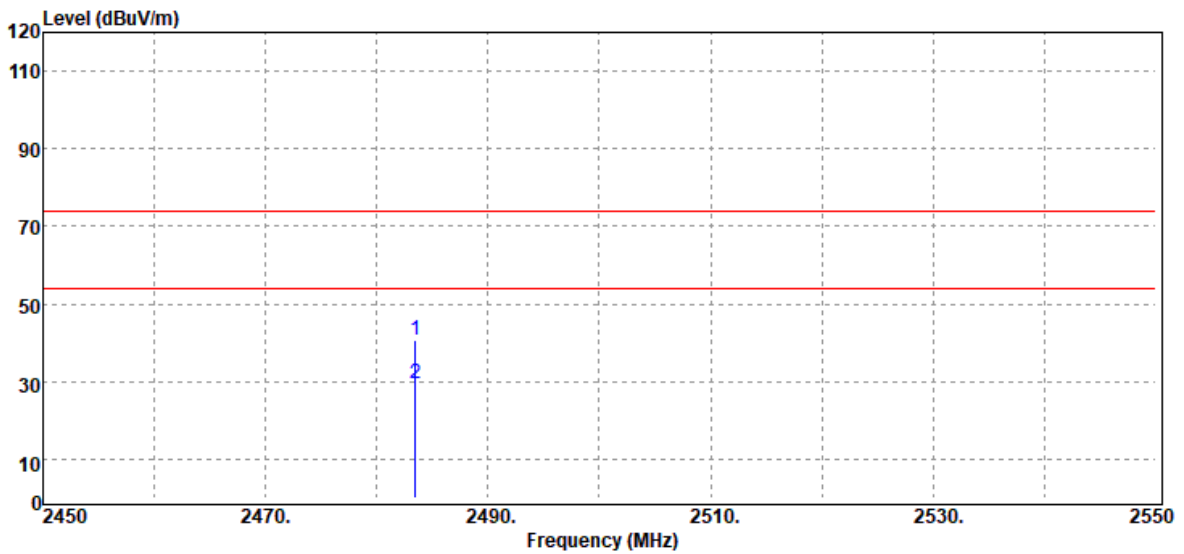

Freq. MHz	Detector Mode PK/QP/AV	Spectrum Reading Level dB μ V	Factor dB	Actual FS dB μ V/m	Limit @3m dB μ V/m	Margin dB
2483.50	Peak	50.03	-9.40	40.63	74.00	-33.37
2483.50	Average	38.80	-9.40	29.40	54.00	-24.60

Report No.: T190902W03-RP1

Test Mode	IEEE 802.11n HT20 Low CH	Temp/Hum	23.4(°C)/ 50%RH
Test Item	Band Edge	Test Date	November 8, 2019
Polarize	Vertical	Test Engineer	Dally Hong
Detector	Peak / Average		

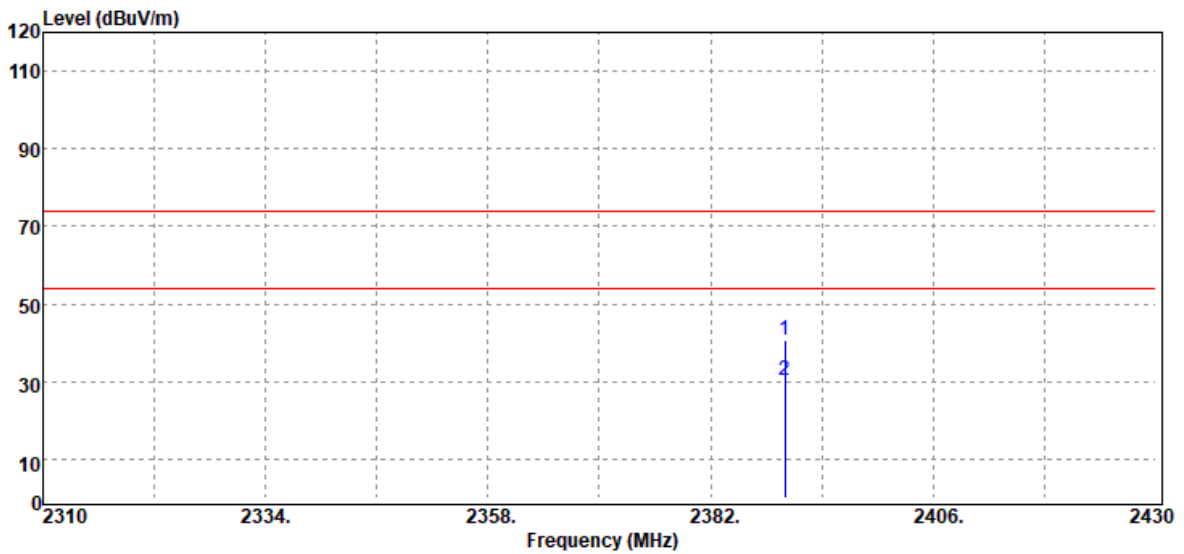

Freq. MHz	Detector Mode PK/QP/AV	Spectrum Reading Level dB μ V	Factor dB	Actual FS dB μ V/m	Limit @3m dB μ V/m	Margin dB
2390.00	Peak	50.66	-9.79	40.87	74.00	-33.13
2390.00	Average	40.13	-9.79	30.34	54.00	-23.66

Report No.: T190902W03-RP1

Test Mode	IEEE 802.11n HT20 Low CH	Temp/Hum	23.4(°C)/ 50%RH
Test Item	Band Edge	Test Date	November 8, 2019
Polarize	Horizontal	Test Engineer	Dally Hong
Detector	Peak / Average		

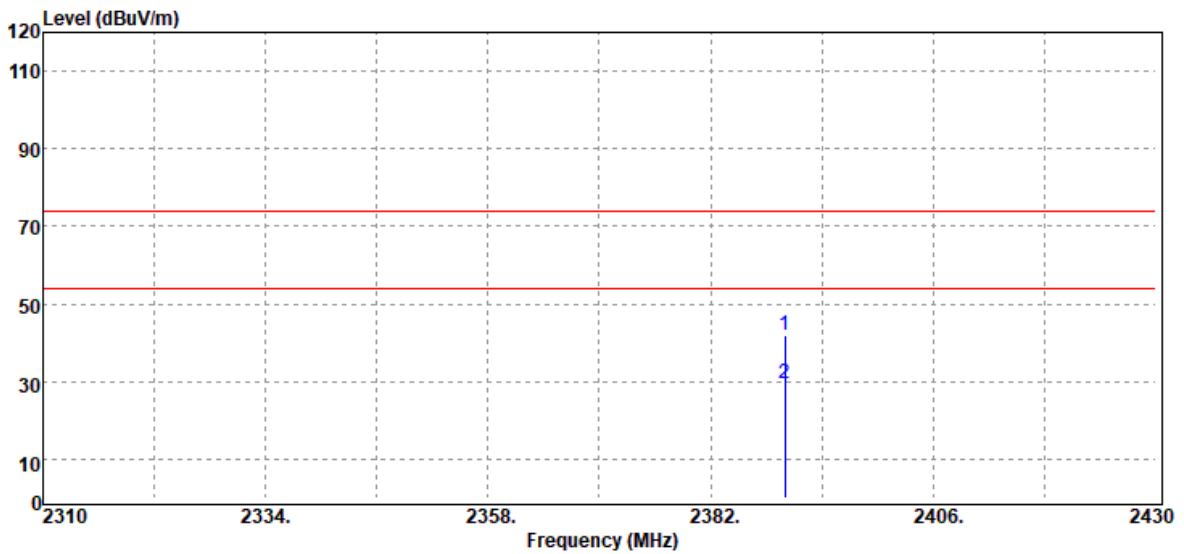

Freq. MHz	Detector Mode PK/QP/AV	Spectrum Reading Level dB μ V	Factor dB	Actual FS dB μ V/m	Limit @3m dB μ V/m	Margin dB
2390.00	Peak	51.78	-9.79	41.99	74.00	-32.01
2390.00	Average	39.10	-9.79	29.31	54.00	-24.69

Report No.: T190902W03-RP1

Test Mode	IEEE 802.11n HT20 high CH	Temp/Hum	23.4(°C)/ 50%RH
Test Item	Band Edge	Test Date	November 8, 2019
Polarize	Vertical	Test Engineer	Dally Hong
Detector	Peak / Average		

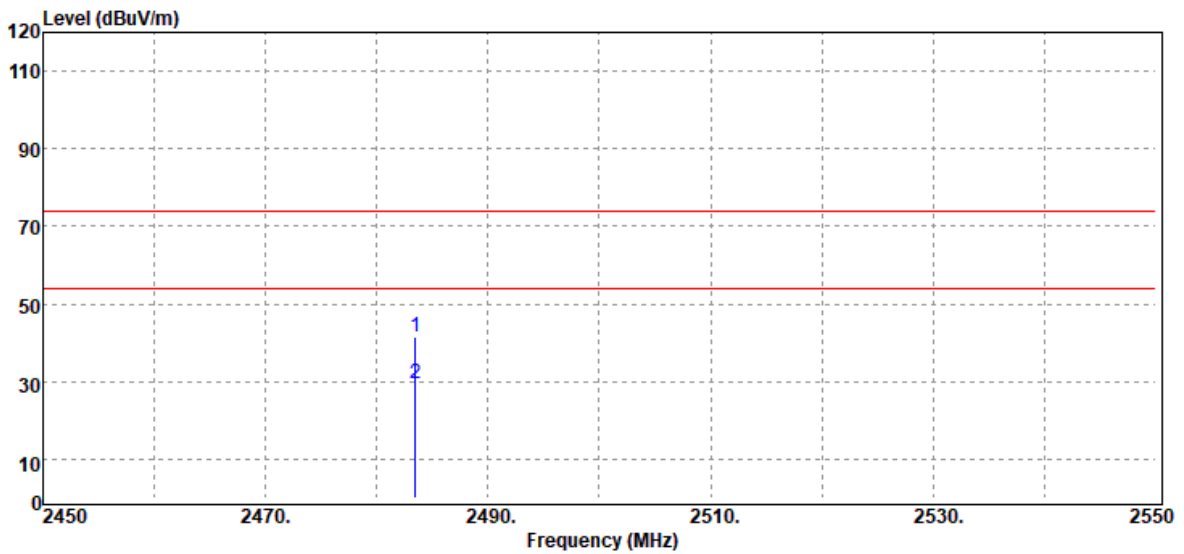

Freq. MHz	Detector Mode PK/QP/AV	Spectrum Reading Level dB μ V	Factor dB	Actual FS dB μ V/m	Limit @3m dB μ V/m	Margin dB
2483.50	Peak	51.00	-9.40	41.60	74.00	-32.40
2483.50	Average	38.77	-9.40	29.37	54.00	-24.63

Report No.: T190902W03-RP1

Test Mode	IEEE 802.11n HT20 high CH	Temp/Hum	23.4(°C)/ 50%RH
Test Item	Band Edge	Test Date	November 8, 2019
Polarize	Horizontal	Test Engineer	Dally Hong
Detector	Peak / Average		

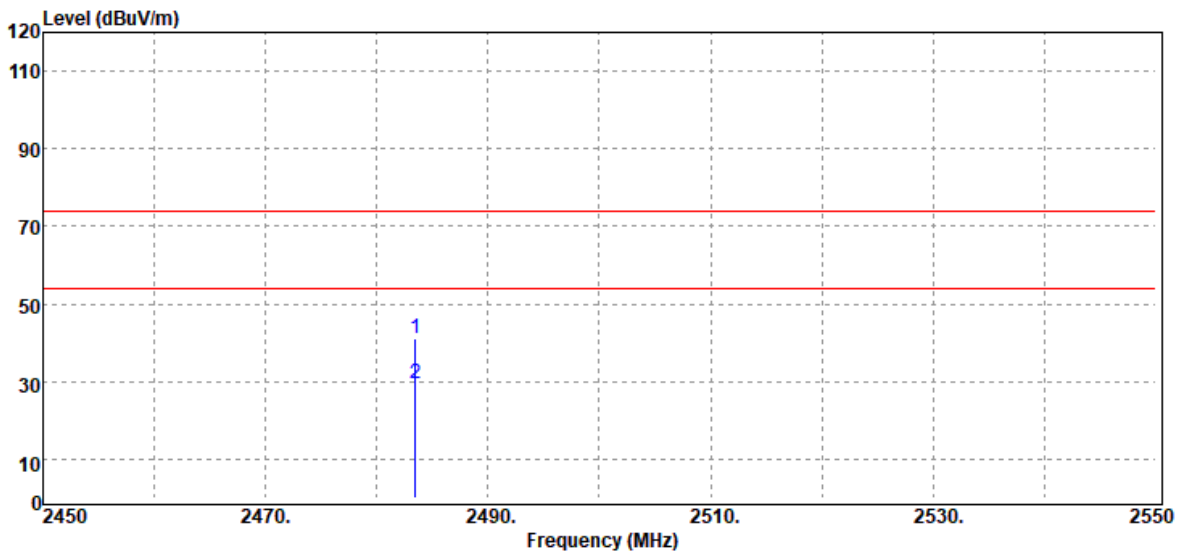

Freq. MHz	Detector Mode PK/QP/AV	Spectrum Reading Level dB μ V	Factor dB	Actual FS dB μ V/m	Limit @3m dB μ V/m	Margin dB
2483.50	Peak	50.60	-9.40	41.20	74.00	-32.80
2483.50	Average	38.72	-9.40	29.32	54.00	-24.68

Report No.: T190902W03-RP1

Test Mode	IEEE 802.11n HT40 Low CH	Temp/Hum	23.4(°C)/ 50%RH
Test Item	Band Edge	Test Date	November 8, 2019
Polarize	Vertical	Test Engineer	Dally Hong
Detector	Peak / Average		

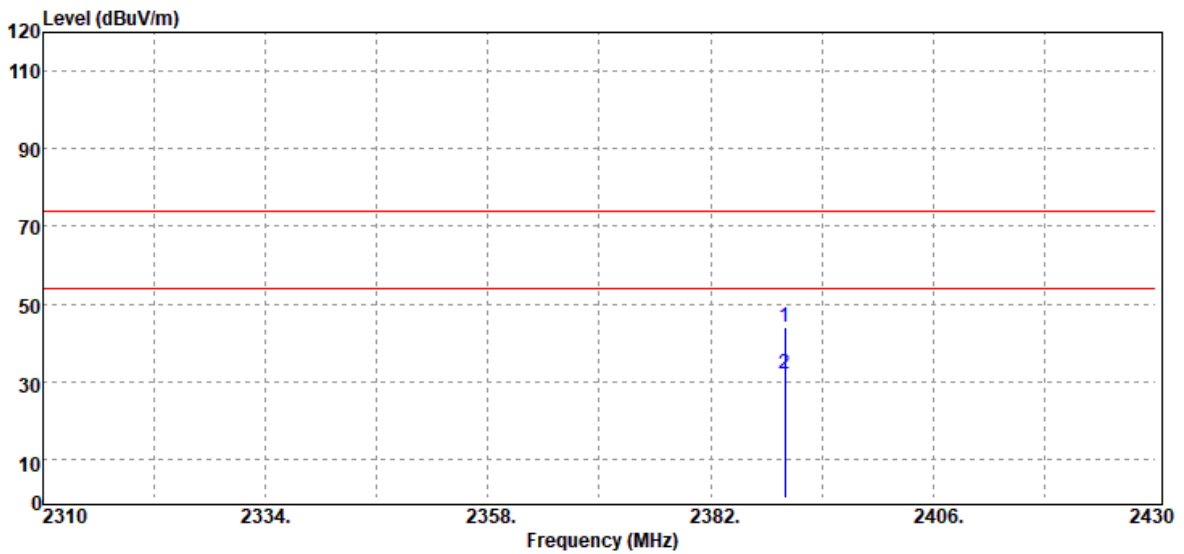

Freq. MHz	Detector Mode PK/QP/AV	Spectrum Reading Level dB μ V	Factor dB	Actual FS dB μ V/m	Limit @3m dB μ V/m	Margin dB
2390.00	Peak	53.97	-9.79	44.18	74.00	-29.82
2390.00	Average	41.63	-9.79	31.84	54.00	-22.16

Report No.: T190902W03-RP1

Test Mode	IEEE 802.11n HT40 Low CH	Temp/Hum	23.4(°C)/ 50%RH
Test Item	Band Edge	Test Date	November 8, 2019
Polarize	Horizontal	Test Engineer	Dally Hong
Detector	Peak / Average		

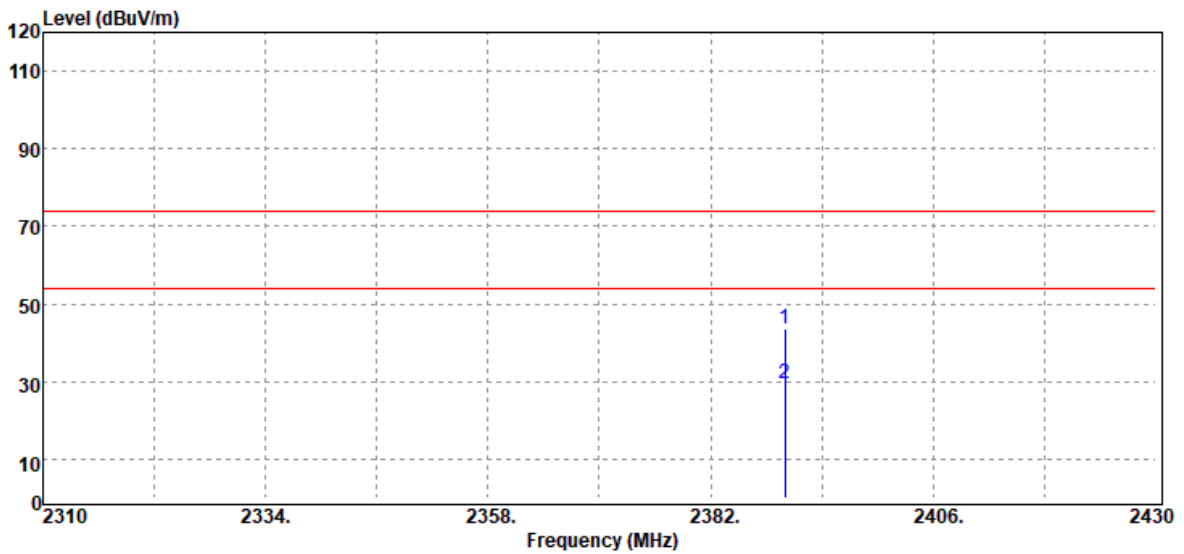

Freq. MHz	Detector Mode PK/QP/AV	Spectrum Reading Level dB μ V	Factor dB	Actual FS dB μ V/m	Limit @3m dB μ V/m	Margin dB
2390.00	Peak	53.43	-9.79	43.64	74.00	-30.36
2390.00	Average	39.35	-9.79	29.56	54.00	-24.44

Report No.: T190902W03-RP1

Test Mode	IEEE 802.11n HT40 high CH	Temp/Hum	23.4(°C)/ 50%RH
Test Item	Band Edge	Test Date	November 8, 2019
Polarize	Vertical	Test Engineer	Dally Hong
Detector	Peak / Average		

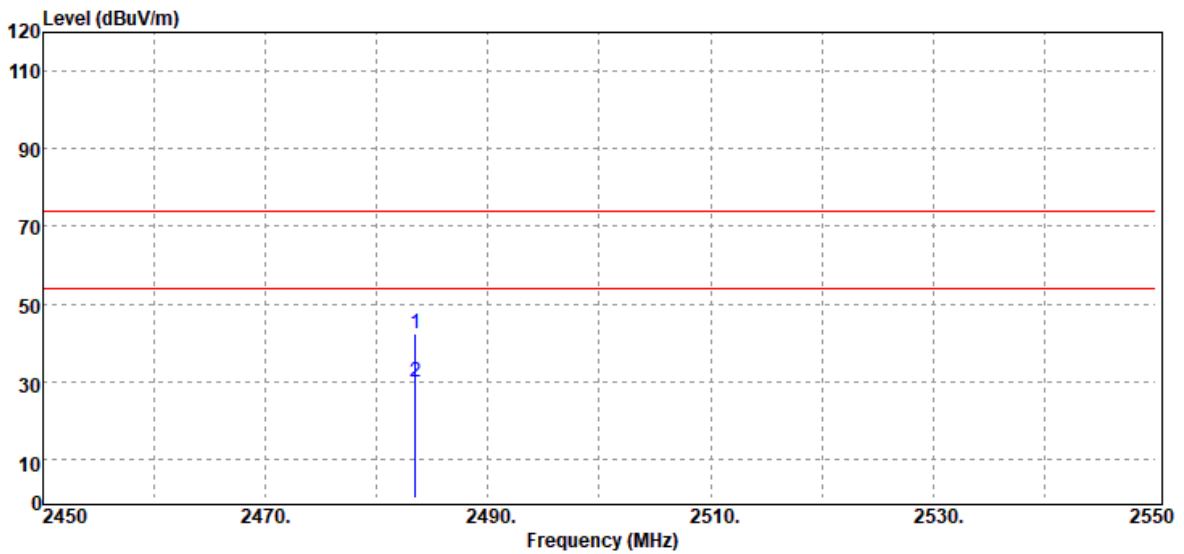

Freq. MHz	Detector Mode PK/QP/AV	Spectrum Reading Level dB μ V	Factor dB	Actual FS dB μ V/m	Limit @3m dB μ V/m	Margin dB
2483.50	Peak	51.61	-9.40	42.21	74.00	-31.79
2483.50	Average	39.17	-9.40	29.77	54.00	-24.23

Report No.: T190902W03-RP1

Test Mode	IEEE 802.11n HT40 high CH	Temp/Hum	23.4(°C)/ 50%RH
Test Item	Band Edge	Test Date	November 8, 2019
Polarize	Horizontal	Test Engineer	Dally Hong
Detector	Peak / Average		

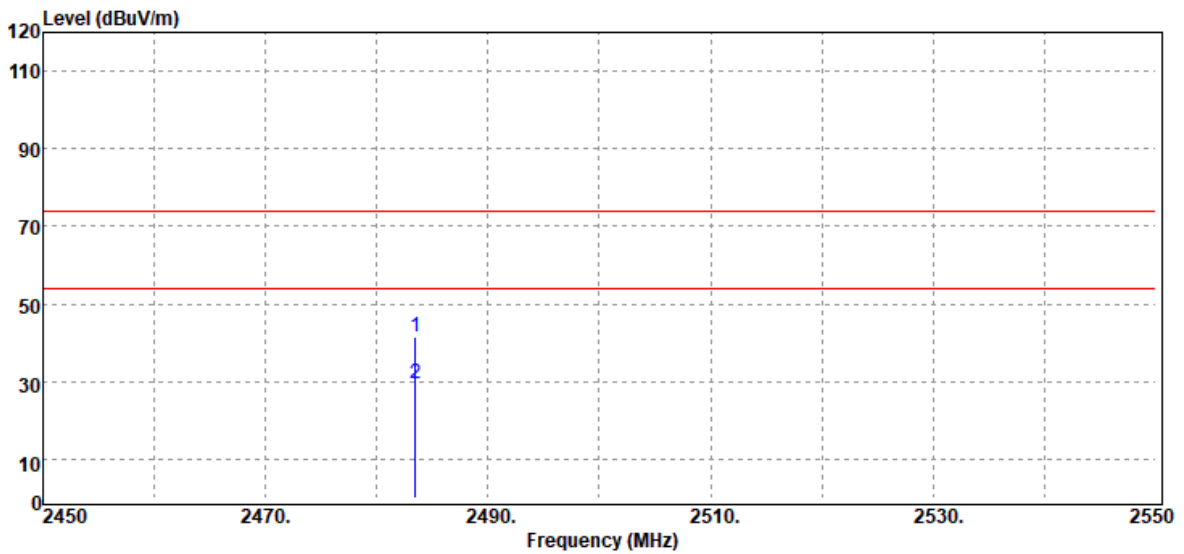

Freq. MHz	Detector Mode PK/QP/AV	Spectrum Reading Level dB μ V	Factor dB	Actual FS dB μ V/m	Limit @3m dB μ V/m	Margin dB
2483.50	Peak	51.05	-9.40	41.65	74.00	-32.35
2483.50	Average	38.86	-9.40	29.46	54.00	-24.54

Report No.: T190902W03-RP1

Below 1G Test Data

Test Mode	Mode 1	Temp/Hum	23.4(°C)/ 50%RH
Test Item	30MHz-1GHz	Test Date	November 8, 2019
Polarize	Vertical	Test Engineer	Dally Hong
Detector	Peak		

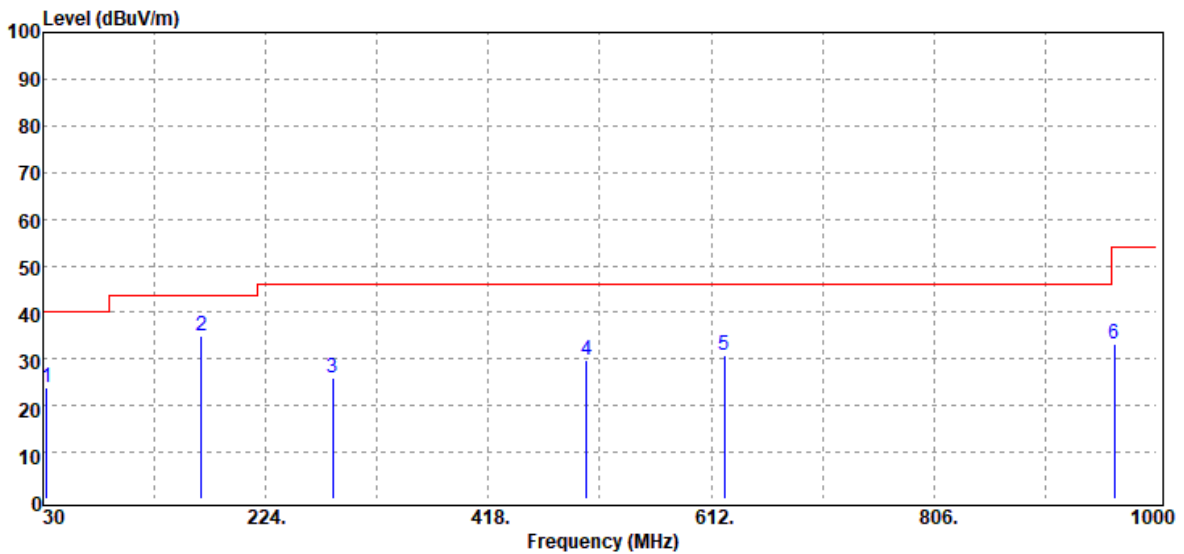

Freq. MHz	Detector Mode PK/QP/AV	Spectrum Reading Level dB μ V	Factor dB	Actual FS dB μ V/m	Limit @3m dB μ V/m	Margin dB
32.91	Peak	28.23	-4.28	23.95	40.00	-16.05
167.74	Peak	45.35	-10.56	34.79	43.50	-8.71
282.20	Peak	34.34	-8.42	25.92	46.00	-20.08
503.36	Peak	32.93	-3.03	29.90	46.00	-16.10
623.64	Peak	31.31	-0.66	30.65	46.00	-15.35
963.14	Peak	28.59	4.62	33.21	54.00	-20.79

Note: No emission found between lowest internal used/generated frequency to 30MHz(9KHz~30MHz)

Report No.: T190902W03-RP1

Test Mode	Mode 1	Temp/Hum	23.4(°C)/ 50%RH
Test Item	30MHz-1GHz	Test Date	November 8, 2019
Polarize	Horizontal	Test Engineer	Dally Hong
Detector	Peak		

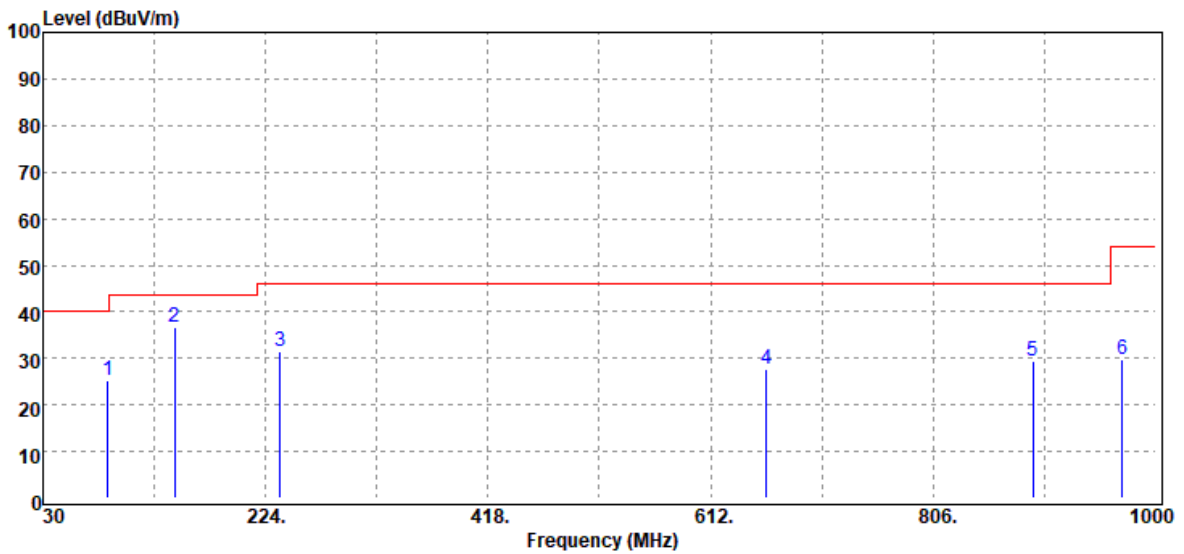

Freq. MHz	Detector Mode PK/QP/AV	Spectrum Reading Level dB μ V	Factor dB	Actual FS dB μ V/m	Limit @3m dB μ V/m	Margin dB
86.26	Peak	40.99	-15.65	25.34	40.00	-14.66
144.46	Peak	46.56	-9.92	36.64	43.50	-6.86
236.61	Peak	41.88	-10.51	31.37	46.00	-14.63
660.50	Peak	27.75	-0.23	27.52	46.00	-18.48
893.30	Peak	25.42	4.08	29.50	46.00	-16.50
970.90	Peak	24.39	5.37	29.76	54.00	-24.24

Note: No emission found between lowest internal used/generated frequency to 30MHz(9KHz~30MHz)

Report No.: T190902W03-RP1

Above 1G Test Data

Test Mode	IEEE 802.11b Low CH	Temp/Hum	23.4(°C)/ 50%RH
Test Item	Harmonic	Test Date	November 8, 2019
Polarize	Vertical	Test Engineer	Dally Hong
Detector	Peak		

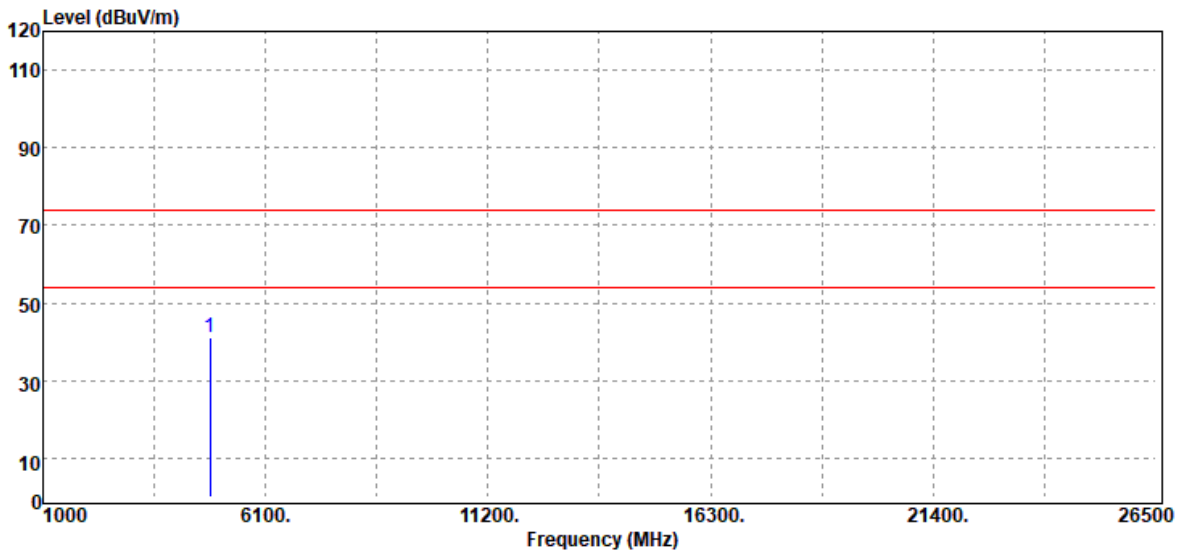

Frequency (MHz)	Reading (dBuV)	Correct Factor (dB/m)	Result (dBuV/m)	Limit (dBuV/m)	Margin (dB)	Remark
4824.00	38.12	2.84	40.96	74.00	-33.04	Peak
N/A						

Remark:

1. Measuring frequencies from 1 GHz to the 10th harmonic of highest fundamental frequency.
2. For above 1GHz, the EUT peak value was under average limit, therefore the Average value compliance with the average limit

Report No.: T190902W03-RP1

Test Mode	IEEE 802.11b Low CH	Temp/Hum	23.4(°C)/ 50%RH
Test Item	Harmonic	Test Date	November 8, 2019
Polarize	Horizontal	Test Engineer	Dally Hong
Detector	Peak		

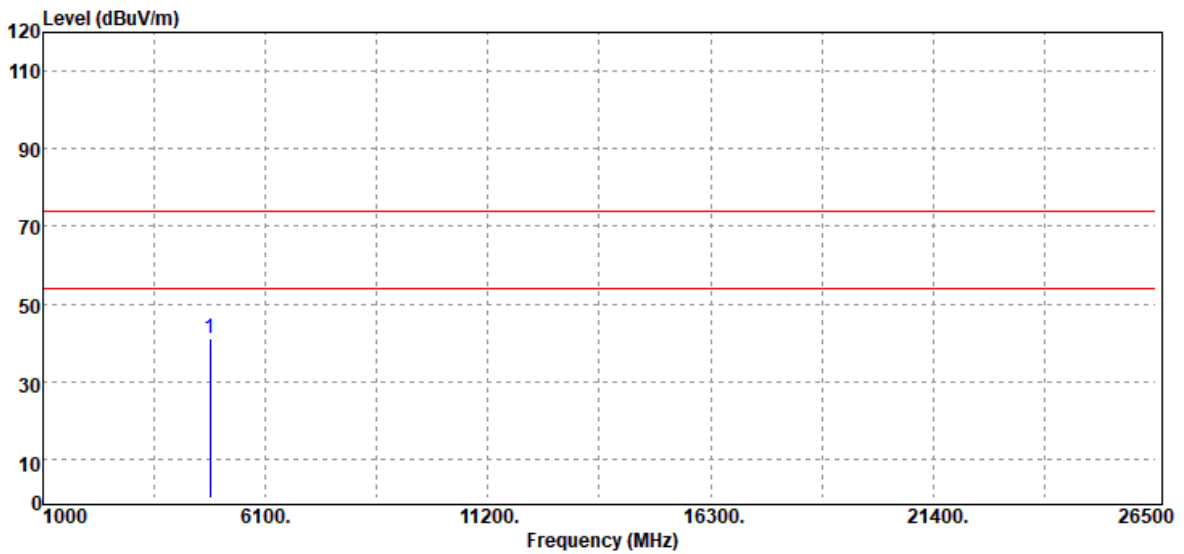

Frequency (MHz)	Reading (dBuV)	Correct Factor (dB/m)	Result (dBuV/m)	Limit (dBuV/m)	Margin (dB)	Remark
4824.00	38.20	2.84	41.04	74.00	-32.96	Peak
N/A						

Remark:

1. Measuring frequencies from 1 GHz to the 10th harmonic of highest fundamental frequency.
2. For above 1GHz, the EUT peak value was under average limit, therefore the Average value compliance with the average limit

Report No.: T190902W03-RP1

Test Mode	IEEE 802.11b Mid CH	Temp/Hum	23.4(°C)/ 50%RH
Test Item	Harmonic	Test Date	November 8, 2019
Polarize	Vertical	Test Engineer	Dally Hong
Detector	Peak		

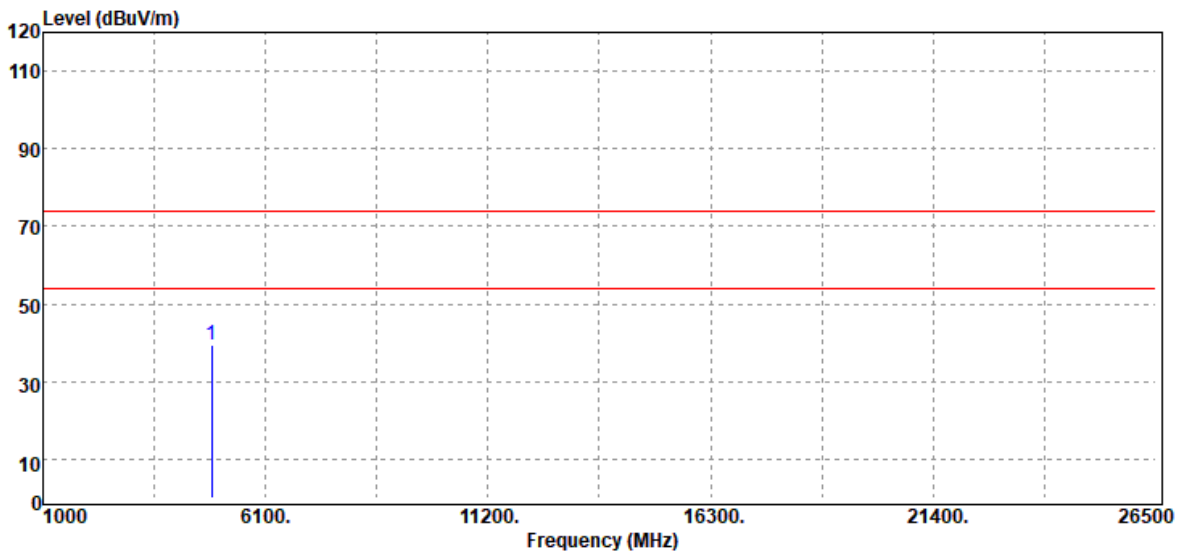

Frequency (MHz)	Reading (dBuV)	Correct Factor (dB/m)	Result (dBuV/m)	Limit (dBuV/m)	Margin (dB)	Remark
4874.00	36.35	2.98	39.33	74.00	-34.67	Peak
N/A						

Remark:

1. Measuring frequencies from 1 GHz to the 10th harmonic of highest fundamental frequency.
2. For above 1GHz, the EUT peak value was under average limit, therefore the Average value compliance with the average limit

Report No.: T190902W03-RP1

Test Mode	IEEE 802.11b Mid CH	Temp/Hum	23.4(°C)/ 50%RH
Test Item	Harmonic	Test Date	November 8, 2019
Polarize	Horizontal	Test Engineer	Dally Hong
Detector	Peak		

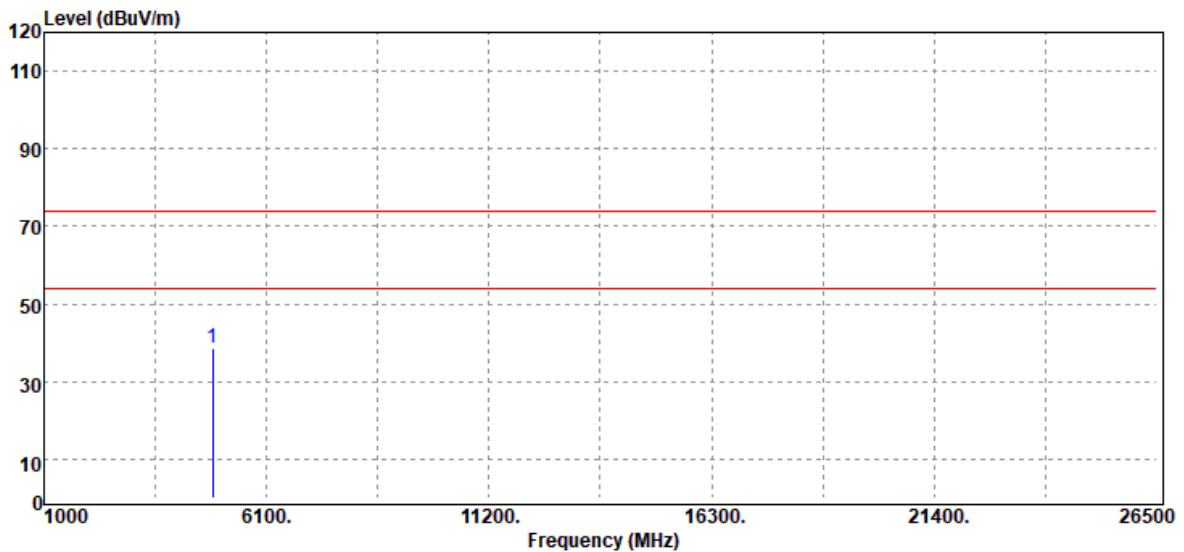

Frequency (MHz)	Reading (dBuV)	Correct Factor (dB/m)	Result (dBuV/m)	Limit (dBuV/m)	Margin (dB)	Remark
4874.00	35.74	2.98	38.72	74.00	-35.28	Peak
N/A						

Remark:

1. Measuring frequencies from 1 GHz to the 10th harmonic of highest fundamental frequency.
2. For above 1GHz, the EUT peak value was under average limit, therefore the Average value compliance with the average limit

Report No.: T190902W03-RP1

Test Mode	IEEE 802.11b High CH	Temp/Hum	23.4(°C)/ 50%RH
Test Item	Harmonic	Test Date	November 8, 2019
Polarize	Vertical	Test Engineer	Dally Hong
Detector	Peak		

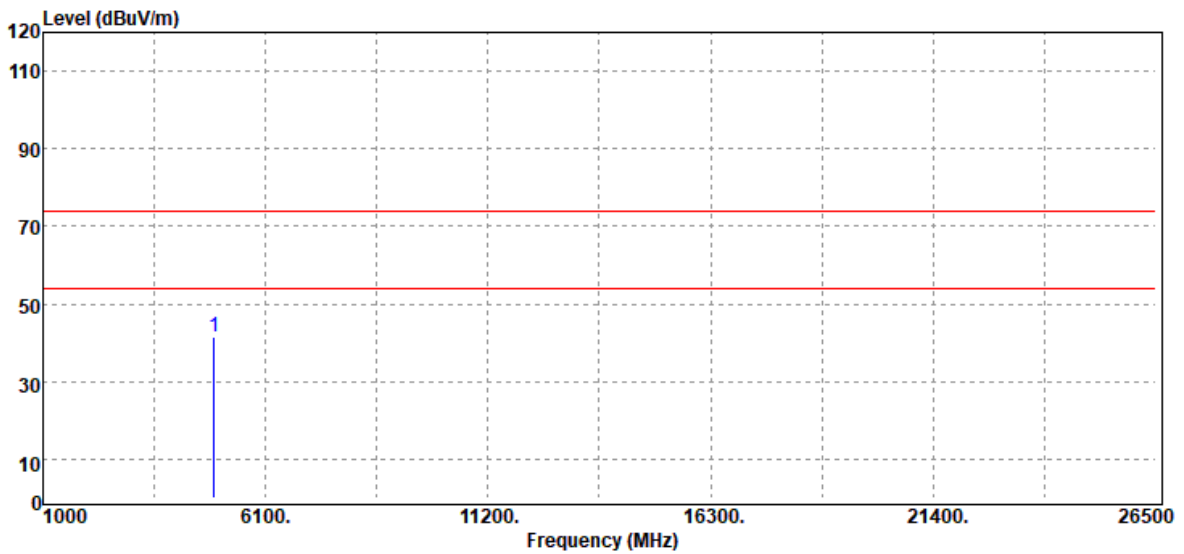

Frequency (MHz)	Reading (dBuV)	Correct Factor (dB/m)	Result (dBuV/m)	Limit (dBuV/m)	Margin (dB)	Remark
4924.00	38.03	3.46	41.49	74.00	-32.51	Peak
N/A						

Remark:

1. Measuring frequencies from 1 GHz to the 10th harmonic of highest fundamental frequency.
2. For above 1GHz, the EUT peak value was under average limit, therefore the Average value compliance with the average limit

Report No.: T190902W03-RP1

Test Mode	IEEE 802.11b High CH	Temp/Hum	23.4(°C)/ 50%RH
Test Item	Harmonic	Test Date	November 8, 2019
Polarize	Horizontal	Test Engineer	Dally Hong
Detector	Peak		

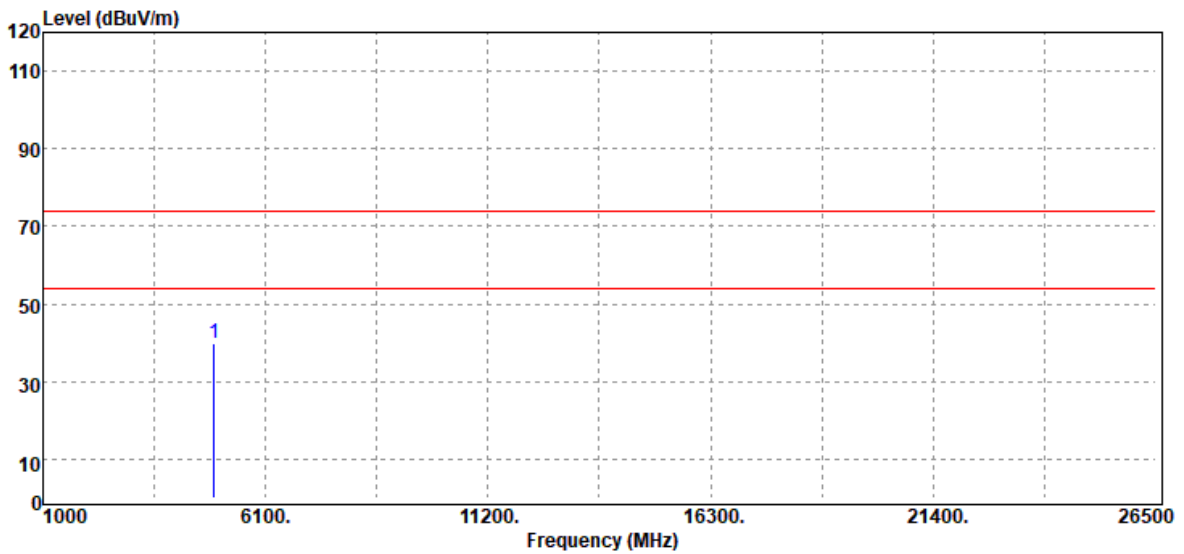

Frequency (MHz)	Reading (dBuV)	Correct Factor (dB/m)	Result (dBuV/m)	Limit (dBuV/m)	Margin (dB)	Remark
4924.00	36.31	3.46	39.77	74.00	-34.23	Peak
N/A						

Remark:

1. Measuring frequencies from 1 GHz to the 10th harmonic of highest fundamental frequency.
2. For above 1GHz, the EUT peak value was under average limit, therefore the Average value compliance with the average limit

Report No.: T190902W03-RP1

Test Mode	IEEE 802.11g Low CH	Temp/Hum	23.4(°C)/ 50%RH
Test Item	Harmonic	Test Date	November 8, 2019
Polarize	Vertical	Test Engineer	Dally Hong
Detector	Peak		

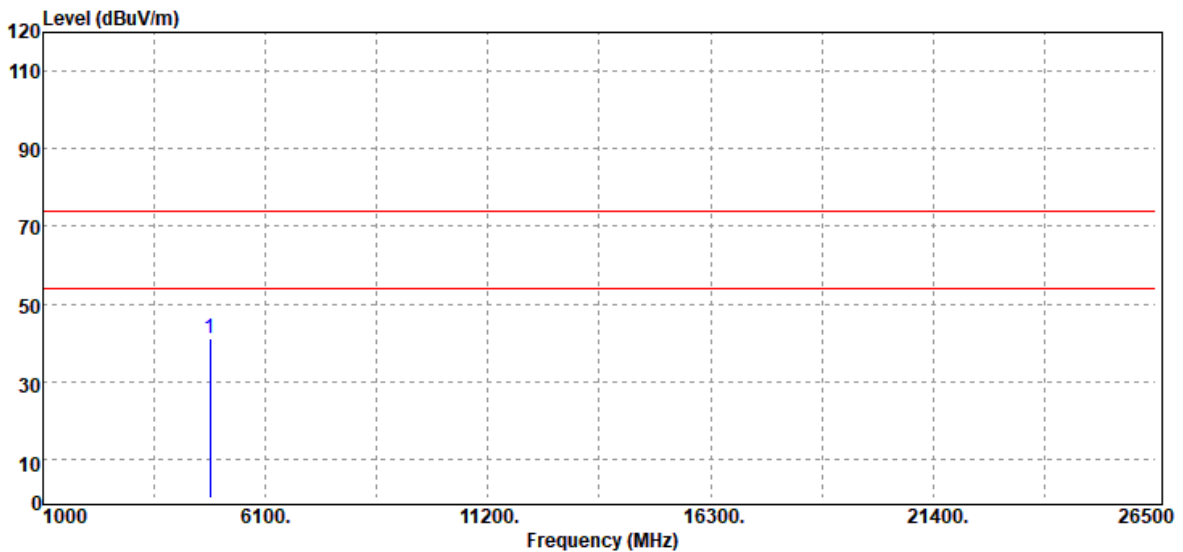

Frequency (MHz)	Reading (dBuV)	Correct Factor (dB/m)	Result (dBuV/m)	Limit (dBuV/m)	Margin (dB)	Remark
4824.00	38.42	2.84	41.26	74.00	-32.74	Peak
N/A						

Remark:

1. Measuring frequencies from 1 GHz to the 10th harmonic of highest fundamental frequency.
2. For above 1GHz, the EUT peak value was under average limit, therefore the Average value compliance with the average limit

Report No.: T190902W03-RP1

Test Mode	IEEE 802.11g Low CH	Temp/Hum	23.4(°C)/ 50%RH
Test Item	Harmonic	Test Date	November 8, 2019
Polarize	Horizontal	Test Engineer	Dally Hong
Detector	Peak		

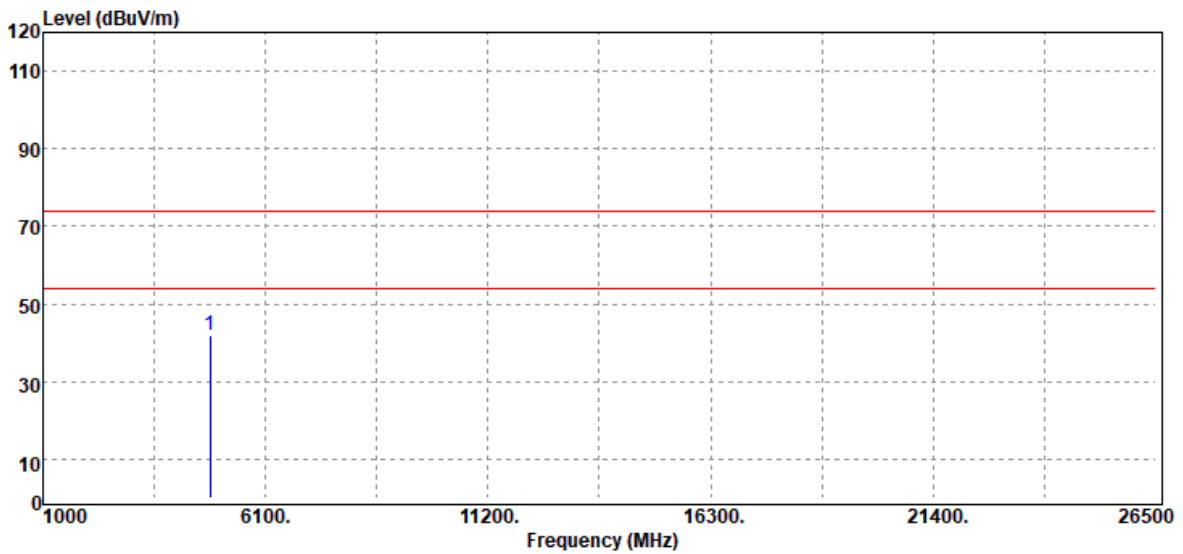

Frequency (MHz)	Reading (dBuV)	Correct Factor (dB/m)	Result (dBuV/m)	Limit (dBuV/m)	Margin (dB)	Remark
4824.00	39.11	2.84	41.95	74.00	-32.05	Peak
N/A						

Remark:

1. Measuring frequencies from 1 GHz to the 10th harmonic of highest fundamental frequency.
2. For above 1GHz, the EUT peak value was under average limit, therefore the Average value compliance with the average limit

Report No.: T190902W03-RP1

Test Mode	IEEE 802.11g Mid CH	Temp/Hum	23.4(°C)/ 50%RH
Test Item	Harmonic	Test Date	November 8, 2019
Polarize	Vertical	Test Engineer	Dally Hong
Detector	Peak		

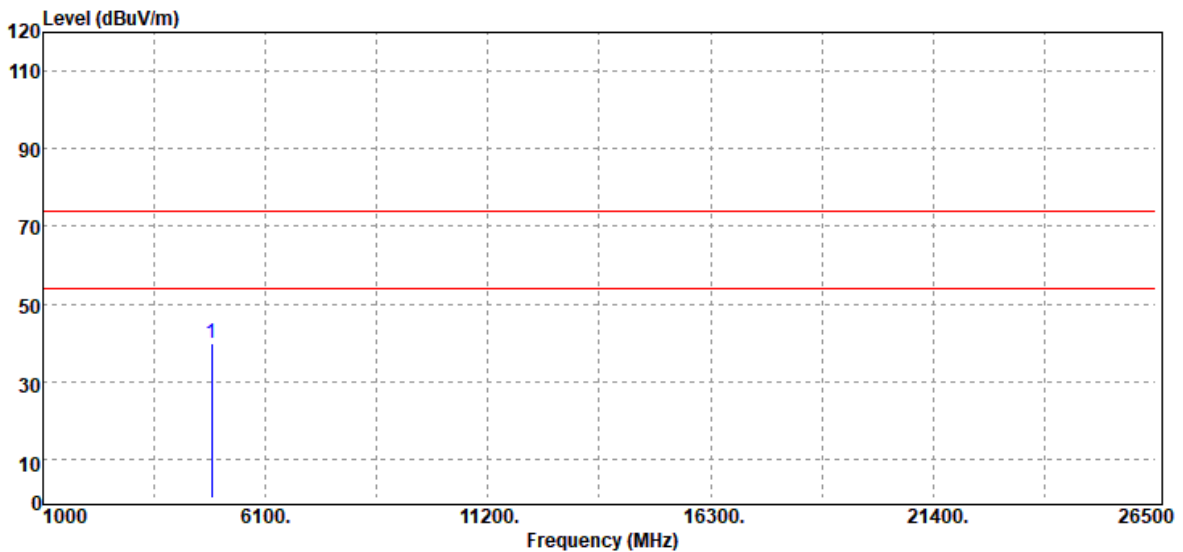

Frequency (MHz)	Reading (dBuV)	Correct Factor (dB/m)	Result (dBuV/m)	Limit (dBuV/m)	Margin (dB)	Remark
4874.00	36.93	2.98	39.91	74.00	-34.09	Peak
N/A						

Remark:

1. Measuring frequencies from 1 GHz to the 10th harmonic of highest fundamental frequency.
2. For above 1GHz, the EUT peak value was under average limit, therefore the Average value compliance with the average limit

Report No.: T190902W03-RP1

Test Mode	IEEE 802.11g Mid CH	Temp/Hum	23.4(°C)/ 50%RH
Test Item	Harmonic	Test Date	November 8, 2019
Polarize	Horizontal	Test Engineer	Dally Hong
Detector	Peak		

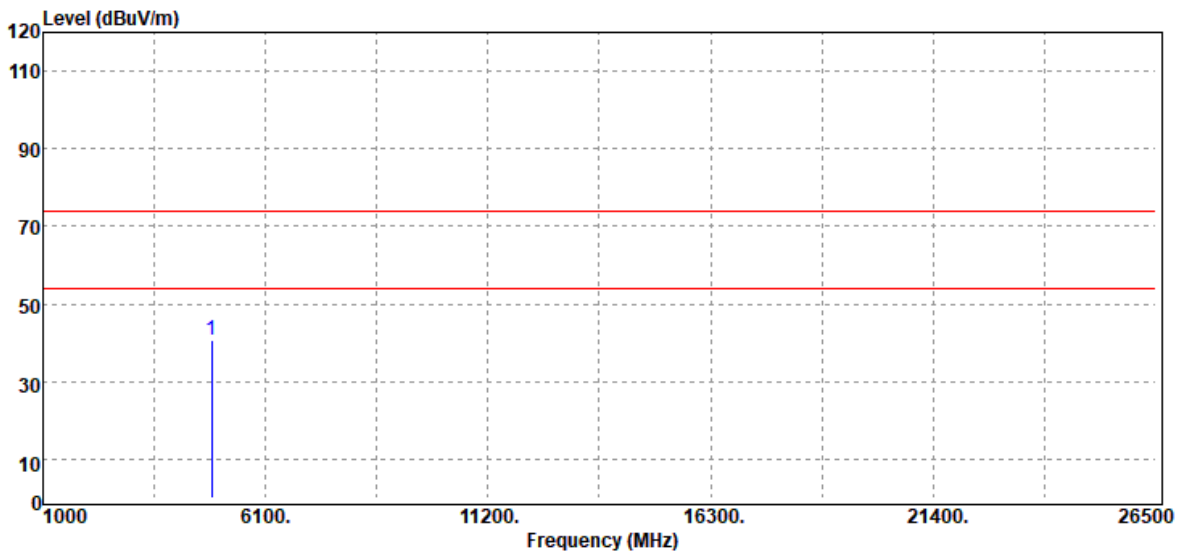

Frequency (MHz)	Reading (dBuV)	Correct Factor (dB/m)	Result (dBuV/m)	Limit (dBuV/m)	Margin (dB)	Remark
4874.00	37.75	2.98	40.73	74.00	-33.27	Peak
N/A						

Remark:

1. Measuring frequencies from 1 GHz to the 10th harmonic of highest fundamental frequency.
2. For above 1GHz, the EUT peak value was under average limit, therefore the Average value compliance with the average limit

Report No.: T190902W03-RP1

Test Mode	IEEE 802.11g High CH	Temp/Hum	23.4(°C)/ 50%RH
Test Item	Harmonic	Test Date	November 8, 2019
Polarize	Vertical	Test Engineer	Dally Hong
Detector	Peak		

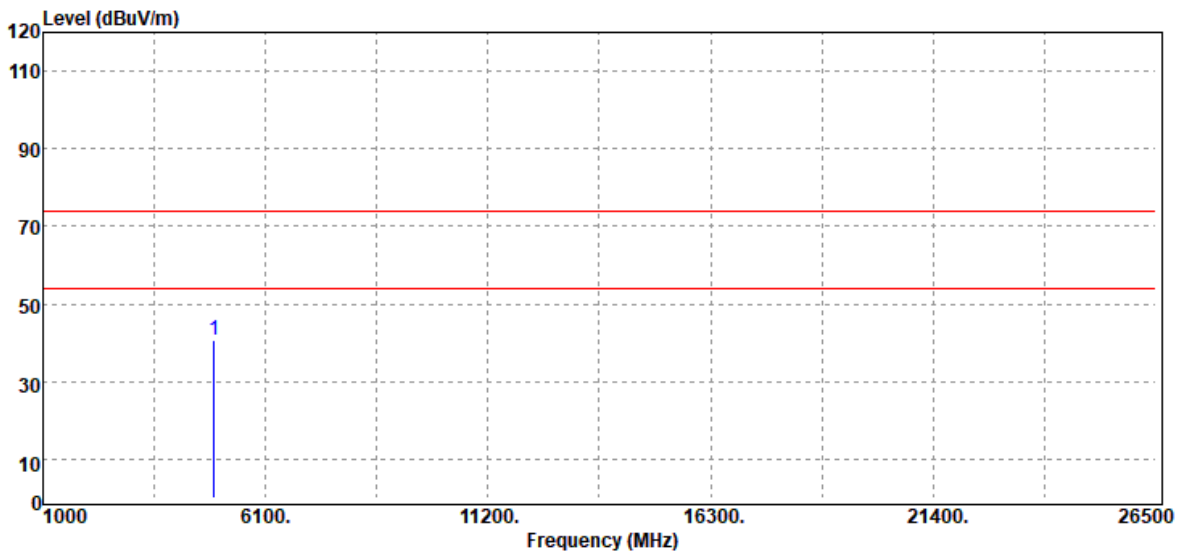

Frequency (MHz)	Reading (dBuV)	Correct Factor (dB/m)	Result (dBuV/m)	Limit (dBuV/m)	Margin (dB)	Remark
4924.00	37.26	3.46	40.72	74.00	-33.28	Peak
N/A						

Remark:

1. Measuring frequencies from 1 GHz to the 10th harmonic of highest fundamental frequency.
2. For above 1GHz, the EUT peak value was under average limit, therefore the Average value compliance with the average limit

Report No.: T190902W03-RP1

Test Mode	IEEE 802.11g High CH	Temp/Hum	23.4(°C)/ 50%RH
Test Item	Harmonic	Test Date	November 8, 2019
Polarize	Horizontal	Test Engineer	Dally Hong
Detector	Peak		

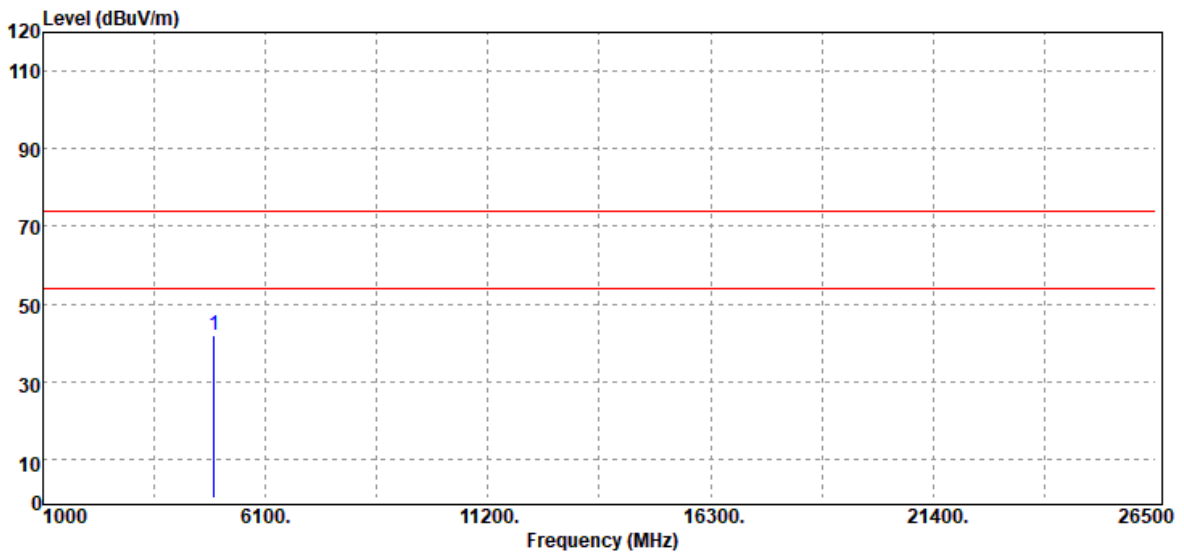

Frequency (MHz)	Reading (dBuV)	Correct Factor (dB/m)	Result (dBuV/m)	Limit (dBuV/m)	Margin (dB)	Remark
4924.00	38.41	3.46	41.87	74.00	-32.13	Peak
N/A						

Remark:

1. Measuring frequencies from 1 GHz to the 10th harmonic of highest fundamental frequency.
2. For above 1GHz, the EUT peak value was under average limit, therefore the Average value compliance with the average limit

Report No.: T190902W03-RP1

Test Mode	IEEE 802.11n HT20 Low CH	Temp/Hum	23.4(°C)/ 50%RH
Test Item	Harmonic	Test Date	November 8, 2019
Polarize	Vertical	Test Engineer	Dally Hong
Detector	Peak		

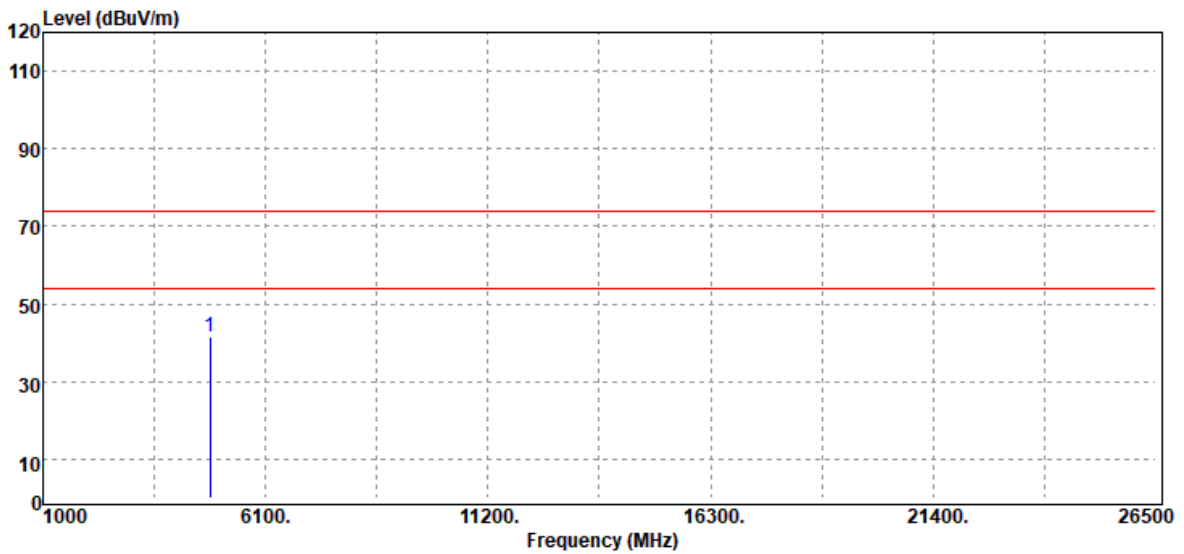

Frequency (MHz)	Reading (dBuV)	Correct Factor (dB/m)	Result (dBuV/m)	Limit (dBuV/m)	Margin (dB)	Remark
4824.00	38.48	2.84	41.32	74.00	-32.68	Peak
N/A						

Remark:

1. Measuring frequencies from 1 GHz to the 10th harmonic of highest fundamental frequency.
2. For above 1GHz, the EUT peak value was under average limit, therefore the Average value compliance with the average limit

Report No.: T190902W03-RP1

Test Mode	IEEE 802.11n HT20 Low CH	Temp/Hum	23.4(°C)/ 50%RH
Test Item	Harmonic	Test Date	November 8, 2019
Polarize	Horizontal	Test Engineer	Dally Hong
Detector	Peak		

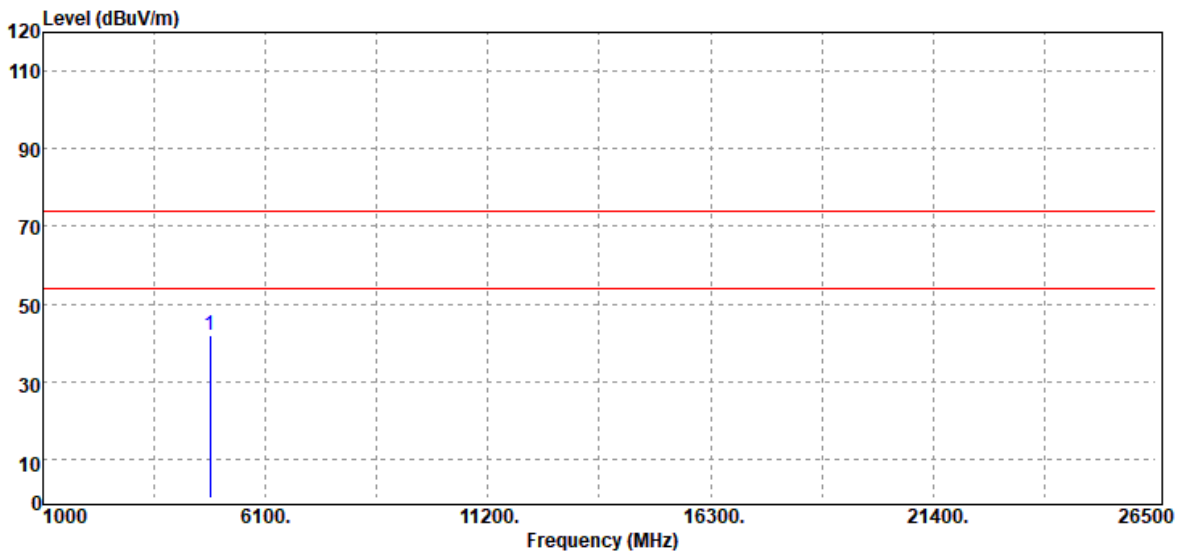

Frequency (MHz)	Reading (dBuV)	Correct Factor (dB/m)	Result (dBuV/m)	Limit (dBuV/m)	Margin (dB)	Remark
4824.00	38.98	2.84	41.82	74.00	-32.18	Peak
N/A						

Remark:

1. Measuring frequencies from 1 GHz to the 10th harmonic of highest fundamental frequency.
2. For above 1GHz, the EUT peak value was under average limit, therefore the Average value compliance with the average limit

Report No.: T190902W03-RP1

Test Mode	IEEE 802.11n HT20 Mid CH	Temp/Hum	23.4(°C)/ 50%RH
Test Item	Harmonic	Test Date	November 8, 2019
Polarize	Vertical	Test Engineer	Dally Hong
Detector	Peak		

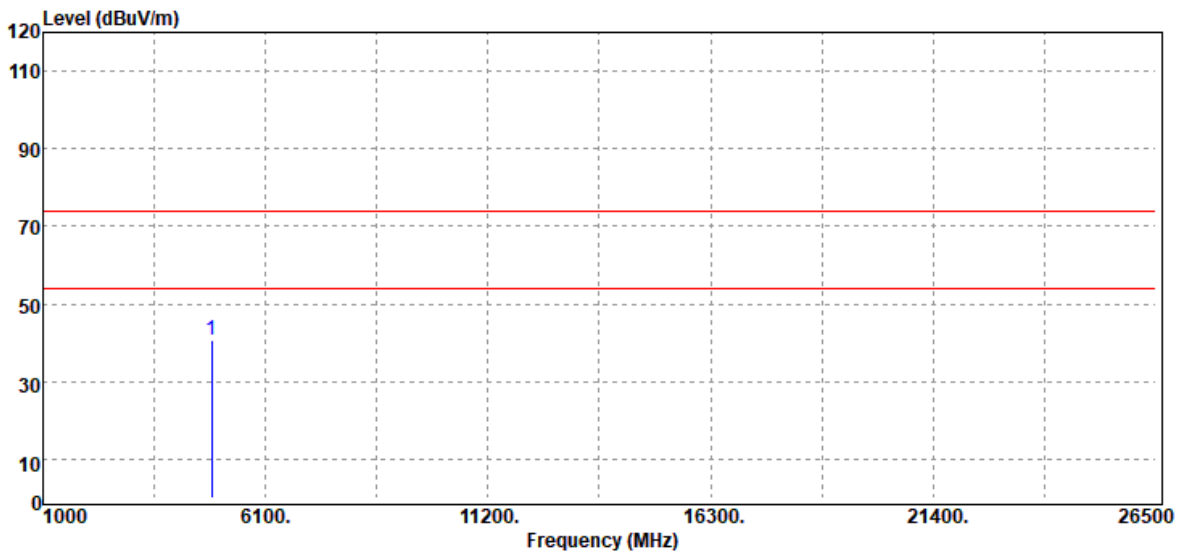

Frequency (MHz)	Reading (dBuV)	Correct Factor (dB/m)	Result (dBuV/m)	Limit (dBuV/m)	Margin (dB)	Remark
4874.00	37.67	2.98	40.65	74.00	-33.35	Peak
N/A						

Remark:

1. Measuring frequencies from 1 GHz to the 10th harmonic of highest fundamental frequency.
2. For above 1GHz, the EUT peak value was under average limit, therefore the Average value compliance with the average limit

Report No.: T190902W03-RP1

Test Mode	IEEE 802.11n HT20 Mid CH	Temp/Hum	23.4(°C)/ 50%RH
Test Item	Harmonic	Test Date	November 8, 2019
Polarize	Horizontal	Test Engineer	Dally Hong
Detector	Peak		

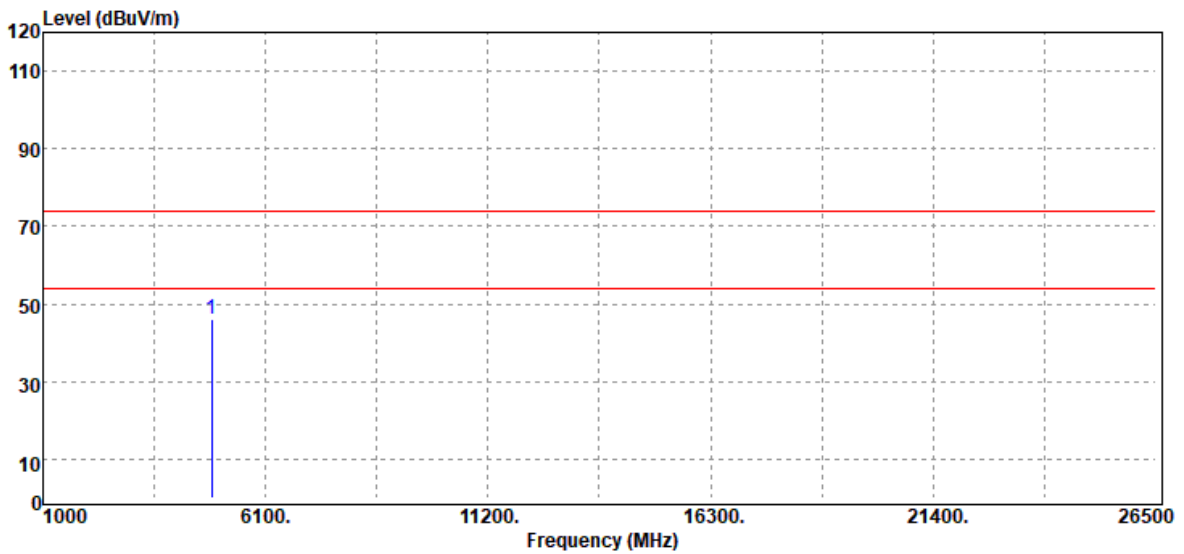

Frequency (MHz)	Reading (dBuV)	Correct Factor (dB/m)	Result (dBuV/m)	Limit (dBuV/m)	Margin (dB)	Remark
4874.00	43.04	2.98	46.02	74.00	-27.98	Peak
N/A						

Remark:

1. Measuring frequencies from 1 GHz to the 10th harmonic of highest fundamental frequency.
2. For above 1GHz, the EUT peak value was under average limit, therefore the Average value compliance with the average limit

Report No.: T190902W03-RP1

Test Mode	IEEE 802.11n HT20 High CH	Temp/Hum	23.4(°C)/ 50%RH
Test Item	Harmonic	Test Date	November 8, 2019
Polarize	Vertical	Test Engineer	Dally Hong
Detector	Peak		

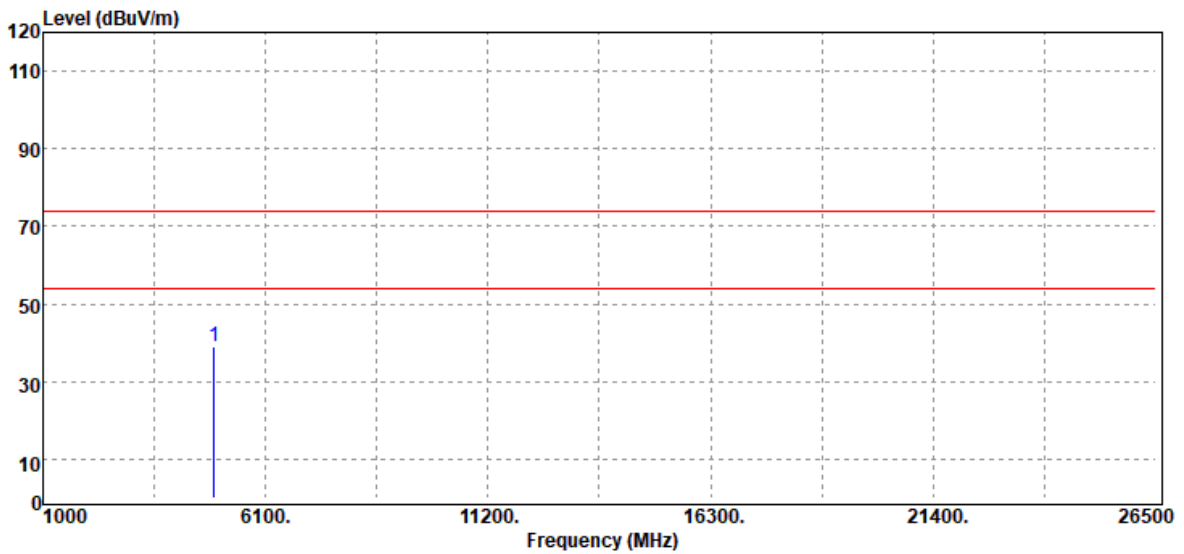

Frequency (MHz)	Reading (dBuV)	Correct Factor (dB/m)	Result (dBuV/m)	Limit (dBuV/m)	Margin (dB)	Remark
4924.00	35.39	3.46	38.85	74.00	-35.15	Peak
N/A						

Remark:

1. Measuring frequencies from 1 GHz to the 10th harmonic of highest fundamental frequency.
2. For above 1GHz, the EUT peak value was under average limit, therefore the Average value compliance with the average limit

Report No.: T190902W03-RP1

Test Mode	IEEE 802.11n HT20 High CH	Temp/Hum	23.4(°C)/ 50%RH
Test Item	Harmonic	Test Date	November 8, 2019
Polarize	Horizontal	Test Engineer	Dally Hong
Detector	Peak		

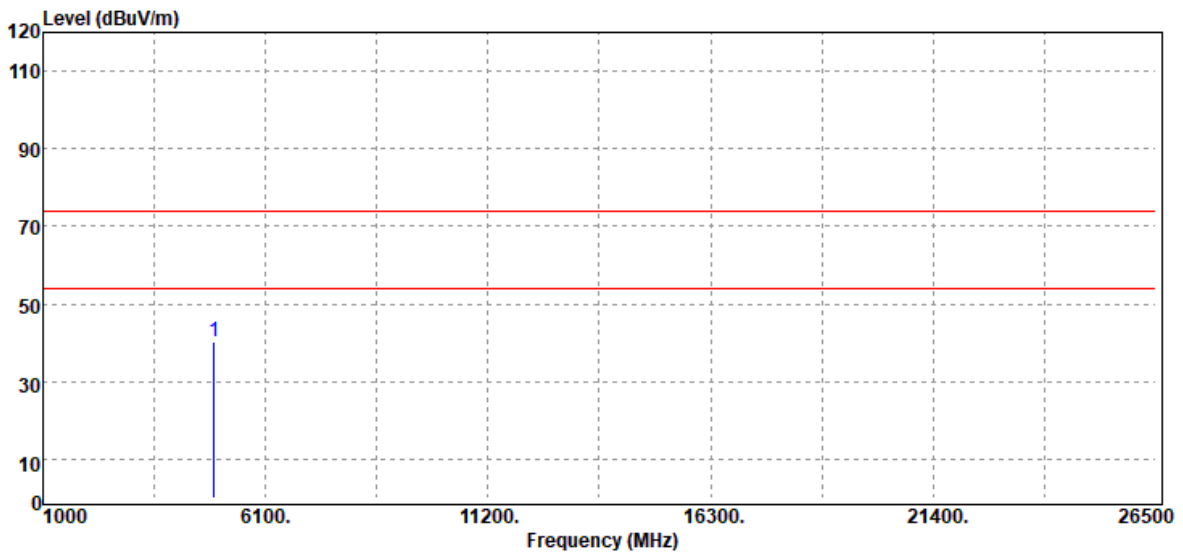

Frequency (MHz)	Reading (dBuV)	Correct Factor (dB/m)	Result (dBuV/m)	Limit (dBuV/m)	Margin (dB)	Remark
4924.00	36.76	3.46	40.22	74.00	-33.78	Peak
N/A						

Remark:

1. Measuring frequencies from 1 GHz to the 10th harmonic of highest fundamental frequency.
2. For above 1GHz, the EUT peak value was under average limit, therefore the Average value compliance with the average limit

Report No.: T190902W03-RP1

Test Mode	IEEE 802.11n HT40 Low CH	Temp/Hum	23.4(°C)/ 50%RH
Test Item	Harmonic	Test Date	November 8, 2019
Polarize	Vertical	Test Engineer	Dally Hong
Detector	Peak		

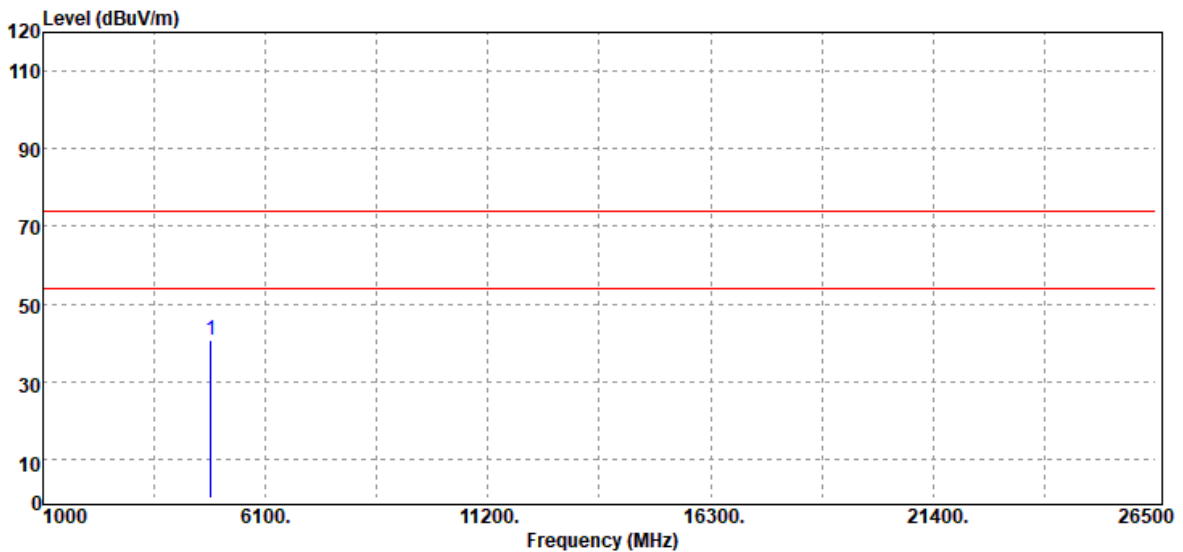

Frequency (MHz)	Reading (dBuV)	Correct Factor (dB/m)	Result (dBuV/m)	Limit (dBuV/m)	Margin (dB)	Remark
4844.00	37.90	2.84	40.74	74.00	-33.26	Peak
N/A						

Remark:

1. Measuring frequencies from 1 GHz to the 10th harmonic of highest fundamental frequency.
2. For above 1GHz, the EUT peak value was under average limit, therefore the Average value compliance with the average limit

Report No.: T190902W03-RP1

Test Mode	IEEE 802.11n HT40 Low CH	Temp/Hum	23.4(°C)/ 50%RH
Test Item	Harmonic	Test Date	November 8, 2019
Polarize	Horizontal	Test Engineer	Dally Hong
Detector	Peak		

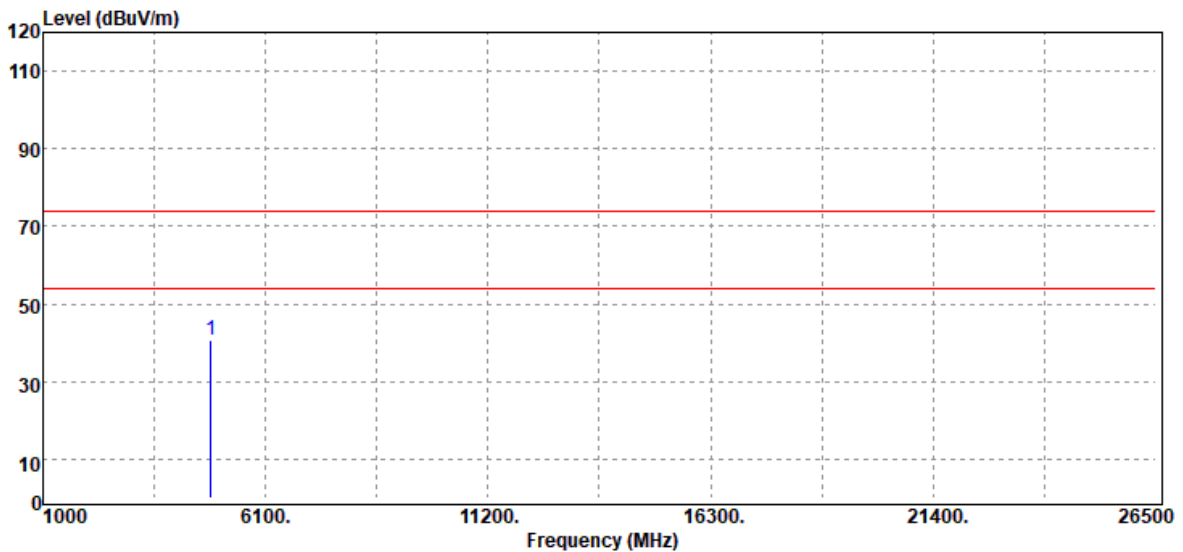

Frequency (MHz)	Reading (dBuV)	Correct Factor (dB/m)	Result (dBuV/m)	Limit (dBuV/m)	Margin (dB)	Remark
4844.00	37.92	2.84	40.76	74.00	-33.24	Peak
N/A						

Remark:

1. Measuring frequencies from 1 GHz to the 10th harmonic of highest fundamental frequency.
2. For above 1GHz, the EUT peak value was under average limit, therefore the Average value compliance with the average limit

Report No.: T190902W03-RP1

Test Mode	IEEE 802.11n HT40 Mid CH	Temp/Hum	23.4(°C)/ 50%RH
Test Item	Harmonic	Test Date	November 8, 2019
Polarize	Vertical	Test Engineer	Dally Hong
Detector	Peak		

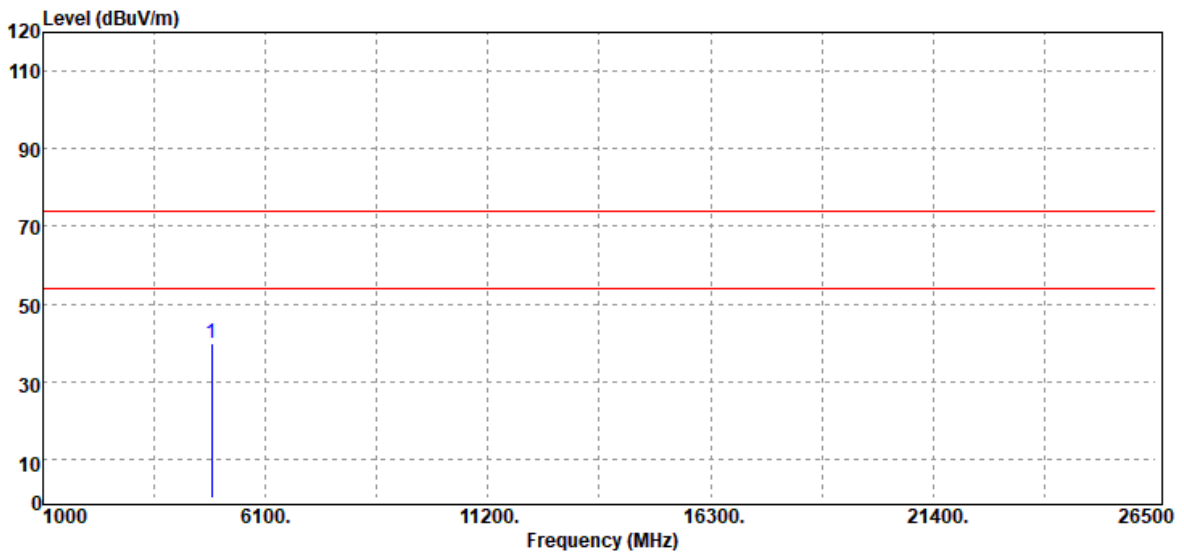

Frequency (MHz)	Reading (dBuV)	Correct Factor (dB/m)	Result (dBuV/m)	Limit (dBuV/m)	Margin (dB)	Remark
4874.00	37.06	2.98	40.04	74.00	-33.96	Peak
N/A						

Remark:

1. Measuring frequencies from 1 GHz to the 10th harmonic of highest fundamental frequency.
2. For above 1GHz, the EUT peak value was under average limit, therefore the Average value compliance with the average limit

Report No.: T190902W03-RP1

Test Mode	IEEE 802.11n HT40 Mid CH	Temp/Hum	23.4(°C)/ 50%RH
Test Item	Harmonic	Test Date	November 8, 2019
Polarize	Horizontal	Test Engineer	Dally Hong
Detector	Peak		

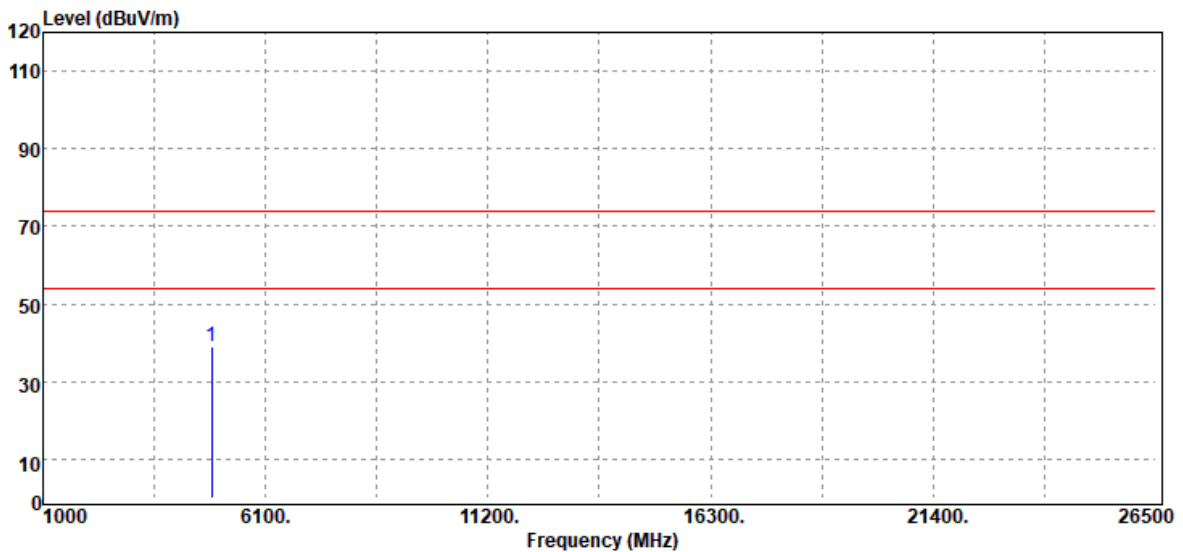

Frequency (MHz)	Reading (dBuV)	Correct Factor (dB/m)	Result (dBuV/m)	Limit (dBuV/m)	Margin (dB)	Remark
4874.00	36.21	2.98	39.19	74.00	-34.81	Peak
N/A						

Remark:

1. Measuring frequencies from 1 GHz to the 10th harmonic of highest fundamental frequency.
2. For above 1GHz, the EUT peak value was under average limit, therefore the Average value compliance with the average limit

Report No.: T190902W03-RP1

Test Mode	IEEE 802.11n HT40 High CH	Temp/Hum	23.4(°C)/ 50%RH
Test Item	Harmonic	Test Date	November 8, 2019
Polarize	Vertical	Test Engineer	Dally Hong
Detector	Peak		

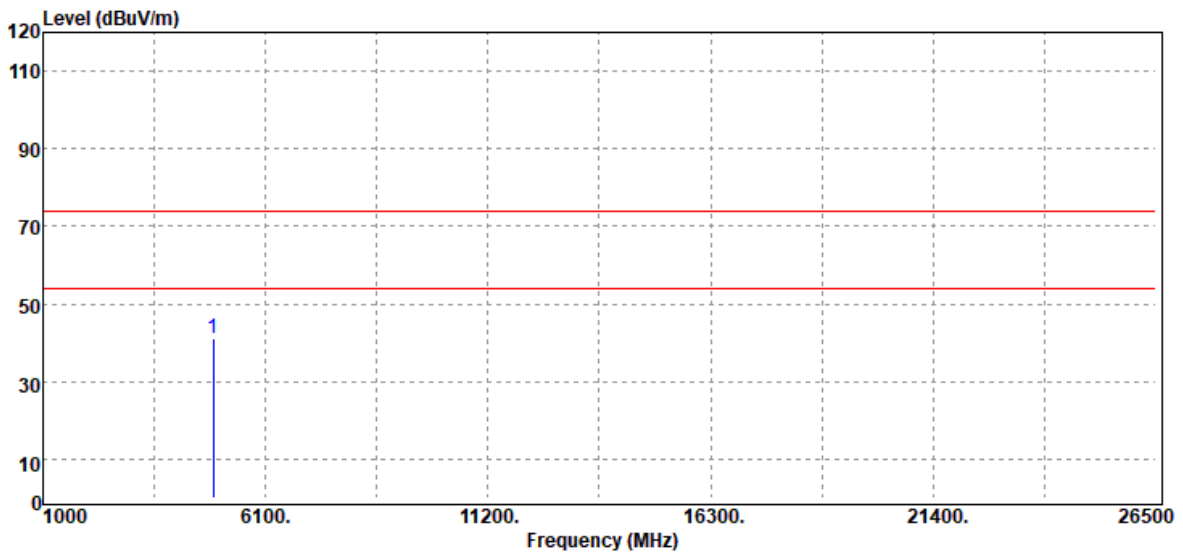

Frequency (MHz)	Reading (dBuV)	Correct Factor (dB/m)	Result (dBuV/m)	Limit (dBuV/m)	Margin (dB)	Remark
4904.00	38.01	3.22	41.23	74.00	-32.77	Peak
N/A						

Remark:

1. Measuring frequencies from 1 GHz to the 10th harmonic of highest fundamental frequency.
2. For above 1GHz, the EUT peak value was under average limit, therefore the Average value compliance with the average limit

Report No.: T190902W03-RP1

Test Mode	IEEE 802.11n HT40 High CH	Temp/Hum	23.4(°C)/ 50%RH
Test Item	Harmonic	Test Date	November 8, 2019
Polarize	Horizontal	Test Engineer	Dally Hong
Detector	Peak		

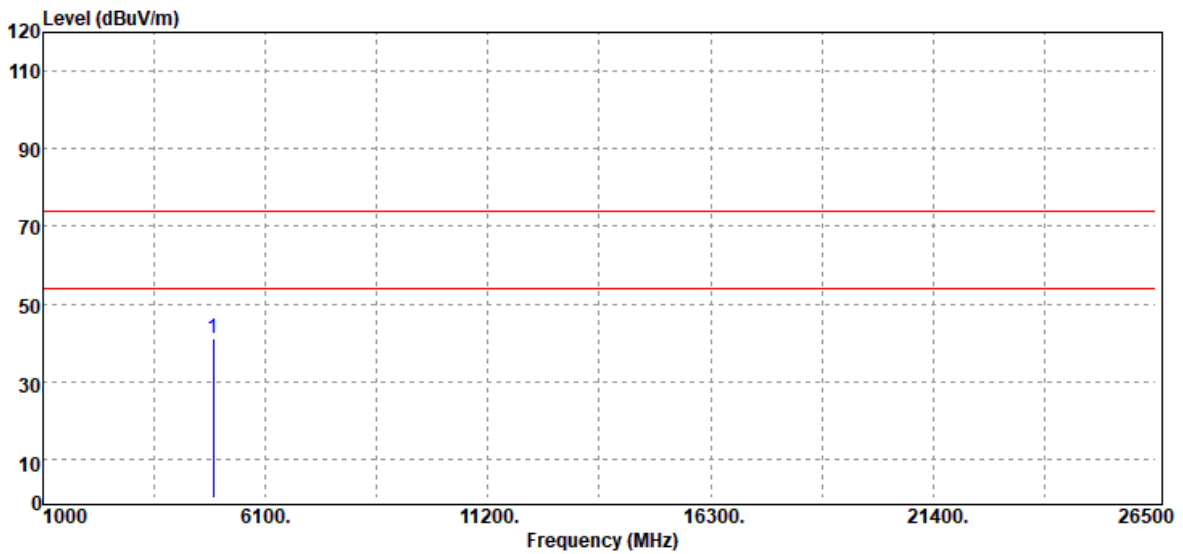

Frequency (MHz)	Reading (dBuV)	Correct Factor (dB/m)	Result (dBuV/m)	Limit (dBuV/m)	Margin (dB)	Remark
4904.00	38.00	3.22	41.22	74.00	-32.78	Peak
N/A						

Remark:

1. Measuring frequencies from 1 GHz to the 10th harmonic of highest fundamental frequency.
2. For above 1GHz, the EUT peak value was under average limit, therefore the Average value compliance with the average limit

- End of Test Report -