



F700

# Manual

The operation of this equipment is subject to the following two conditions: (1) this equipment or device may not cause harmful interference and (2) this equipment or device must accept any interference, including any that may cause undesired operation

F700  
User manual

# Index

Introduction .....	6
Sales package contents.....	7
Precautions for use .....	8
Overview .....	12
Installation .....	14
Keyboard.....	18
Numeric keypad .....	21
Display .....	22
System icons .....	23
Applications menu .....	24
Settings diagram.....	28
Calling .....	30
Messages.....	34
Contacts .....	38
Bluetooth®connection.....	40
Troubleshooting.....	41
Regulations .....	44

# Introduction

---

Thank you for choosing the Co-Comm F700 smartphone. This phone is designed for use with GSM 850/1900 and UMTS 850/1900 MHz networks and for operation requires a valid SIM card from your network operator. Please consult your network operator for more information.

- Product Name: Fixed wireless phone
- Electrical characteristics of the equipment: 5 Vdc 1.5 A
- Electrical characteristics of the adapter:
  - Input: 100-240 Vac 50/60 Hz 0.25A
  - Output: 5 Vdc 1.5 A

Please check with your network operator for more information.

## Security instructions

Please read the following instructions carefully before you start using your smartphone Co-Comm F700:

- Keep this manual for future reference.
- Keep the phone away from moisture.
- Place the phone on a stable surface before start using.
- If any of the following situations occurs, have it checked by a qualified service technician:
  - It has been exposed to moisture.
  - It has been dropped or damaged.
  - It has obvious signs of breakage.
- Do not place the phone at a distance of less than 1.5 m from a water source.
- Do not use the device in areas where there is risk of explosion.

# Sales package contents

Please check the sales package includes the following components. If any items are missing, please contact your dealer.



1. Co-Comm F700 wireless phone



2. User manual



3. Guarantee card



4. AC/DC power adapter



5. Li-Po rechargeable battery



6. Security screw, key and QC PASS sticker



7. USB data cable

# Precautions for use

---

## Operating Environment

Your phone Co-Comm F700 is a RF transmitter, so please turn off your terminal or disable the radio functions in the following situations:

- When you are on an airplane.
- When you are in the vicinity of flammable atmospheres and is indicated by the entity responsible for risk management.
- When you are in the vicinity of electro-explosive devices and is indicated by the entity responsible for risk management.

Respect special regulations in force in any area, and always switch off your phone when its use is prohibited, or if it could cause danger. When connecting the phone or any accessory to another device, read the user manual for detailed safety instructions. Do not connect incompatible products. It is recommended that the equipment should only be used in the normal position for proper operation and personnel safety. Do not expose to temperatures below -10 °C or above 50 °C.

## Medical equipment

Be sure to turn off the phone near electronic medical equipment which obviously require that the phone is turned off (such as pacemakers, hearing aids, etc.).

Most medical devices can be protected from the RF signal of the phone, but not all of them. If you have any questions or need more information, consult your doctor or the manufacturer of your medical device.

# Precautions for use

---

## Pacemakers

Pacemaker manufacturers warn that the distance between the phone and the pacemaker of the heart must be at least 6 inches (15.3 cm), otherwise the phone can interfere with pacemakers.

People with pacemakers should consider the following:

- Always keep a distance (at least 6 inches) between the phone and pacemaker when the phone is on.
- Do not carry your phone near your chest.
- Use the phone in the ear that is furthest from the pacemaker.

Please turn off your phone if you feel there is interference, and consult your doctor as soon as possible.

## Emergency calls

Like any mobile phone, this phone works with radio signals that can not guarantee connection in all conditions. Therefore, you should never rely solely on a mobile phone for essential communications like medical emergencies. To make or receive calls, the phone must be switched on and in a service area with adequate signal strength. To make an emergency call, enter the local emergency number in standby mode and press the call button.

# Precautions for use

---

## Care and maintenance

Your phone is a product of superior design and should be treated with care. The following tips will allow you to enjoy this product for a longer period of time:

- Keep the phone away from children and pets. They could damage the phone accidentally or choke on small parts.
- Keep the phone dry and avoid liquids that could corrode the phone. Do not use the phone with wet hands, which may cause electric shock.
- Do not place the phone in areas of excessive heat, which may shorten the life of electronic devices, damage batteries, or melt accessories.
- Do not place the phone in cold areas. When the phone warms up to its normal operating temperature, moisture can accumulate inside the phone, which may damage electronic circuits.
- Do not place the phone in areas exposed to sunlight as it may cause overheating.
- Do not place the phone near flammable liquids, gases or explosive substances.
- Do not drop or knock the phone. Rough handling can damage electronic circuits.
- To clean the telephone, use a damp or antistatic cloth. Do not use a dry or static cloth.
- Do not use chemicals such as cleaning solvents to clean the surface of the phone. Turn off your phone before cleaning.
- Do not apply paint over the phone, as it can prevent proper operation.
- The manufacturer's warranty does not cover repair the appliance if the phone or battery gets wet, or phone label is damaged even when the phone warranty has not expired.



# Precautions for use

---

## Battery use

- Never use any charger or battery if damaged. Use the battery correctly.
- Do not short-circuit the battery, as this may damage the battery or cause a fire.
- Do not subject the battery to high temperatures or fire as it may explode.
- Return the old battery to the dealer, or place it in locations designated for recycling.
- Do not throw the battery in household waste.
- The charging time depends on the remaining battery charge, the type of battery and charger used.
- The battery can be charged and discharged hundreds of times, but its duration will gradually decrease.
- When the operation time is noticeably shorter than normal, replace the battery with a new one.
- Use only original chargers, batteries and accessories approved by the manufacturer.
- Disconnect the charger from the electrical plug and the device when the phone is not in use.
- Do not overload your battery as it may damage or shorten its life.
- Do not expose the battery to places of extremely hot or cold temperatures, as it will reduce the battery capacity.
- The Li-ion batteries are particularly affected by temperatures below 0° C.

# Overview

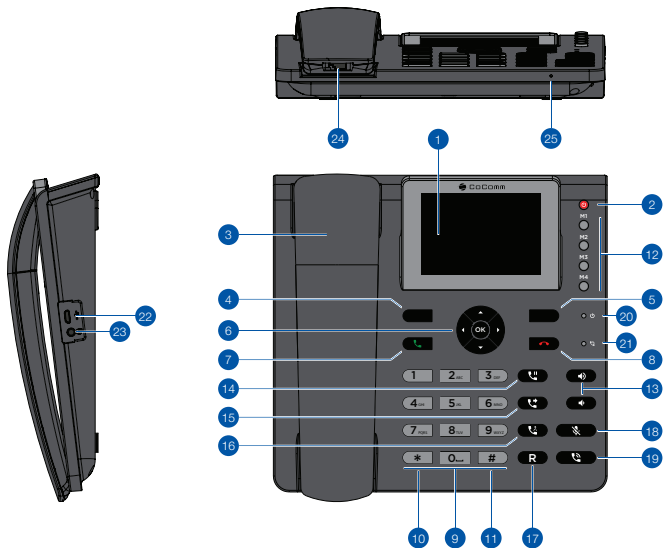

1. LCD screen
2. [ ] Turn on / off
3. Handset / receiver
4. [ - ] Menu left soft key
5. [ - ] Menu right soft key
6. Direction and confirmation buttons
7. [ ] Call key
8. [ ] End call key / back to main menu
9. Alphanumeric keypad
10. [ \* ] Asterisk key
11. [ # ] Pad key
12. [ **M1...M4** ] Speed dial keys M1 to M8
13. [ < / > ] Volume keys
14. [ ] Hold key
15. [ ] Transfer key
16. [ ] Multi-conference key
17. [ **R** ] Redial key
18. [ ] Mute key
19. [ ] Hands-free key

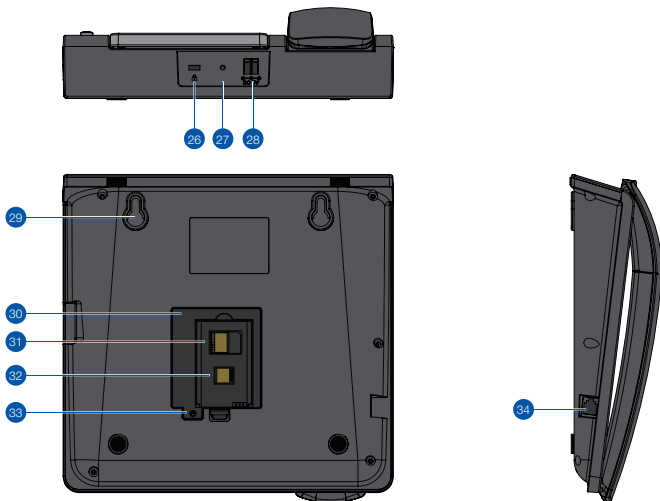

- 20. Charging indicator
- 21. Hands-free indicator
- 22. Micro-USB data port for software update
- 23. Jack connector for earphones / handsfree
- 24. RJ9 connector on the handset
- 25. Microphone for handsfree function
- 26. Ranura para cable de seguridad
- 27. Microphone for ambient noise suppression

- 28. DC 5V power connector
- 29. Wall mounting holes
- 30. Rechargeable battery compartment
- 31. SIM card compartment
- 32. Micro-SD card compartment
- 33. Hole for security screw
- 34. RJ9 connector on the receiver

# Installation

---

Follow the steps below to install the SIM card and the different accessories of your wireless phone Co-Comm F700:

1. Disconnect the power adapter and remove the cover of the battery compartment on the bottom of the device to install the SIM card and the micro-SD memory card. To install the SIM card, slide the metal tab in the direction shown to unlock it, turn it up, and place the card as shown in the figure. Turn the metal tab down and slide to the initial position to lock.

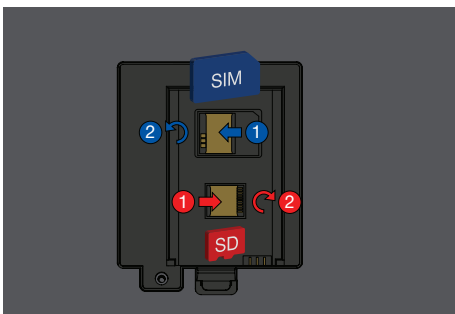

2. Follow the same procedure if you want to install a micro-SD card, but this time, slide the metal tab in the opposite direction to unlock it, as shown in the figure. Place the memory card, and then turn down the metal tab and slide to the initial position to lock.

# Installation

3. Insert the battery into the compartment, making sure that the electrodes of the connector on the terminal match the slots in the top of the battery as shown in the figure. Replace the lid of the battery compartment, making sure it is securely locked in place.



4. Close the lid of the battery compartment using the screw and hex key supplied, and use a QC PASS adhesive sticker to cover the screw hole.

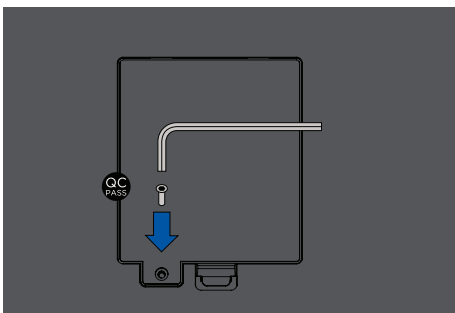

# Installation

---

5. Connect the curly cord to the handset and telephone base. Connect one end of the cord to the connector on the left side of the telephone base.

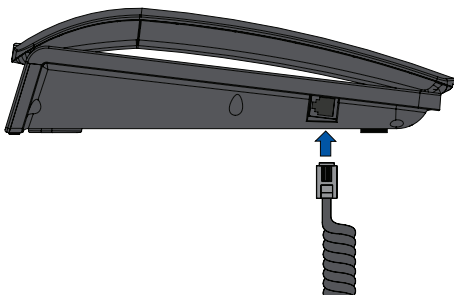

6. Connect the other end of the curly cord into the handset jack, as shown in the illustration.

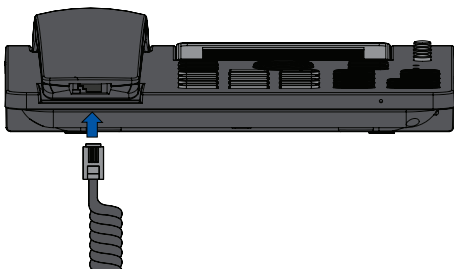

7. Connect the cable from the power supply to the connector on the back of the phone and then plug the power supply into a household AC power outlet. The battery level will be displayed on the screen showing the status of the charging process.

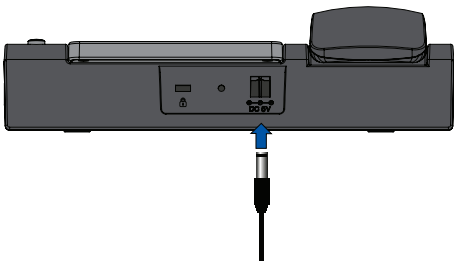

## Battery Charge

When the battery level is low, the phone will issue a warning tone and a low battery message. Connect the power adapter into the device to start charging. Battery level is indicated on the screen during the charging process, and once it is fully charged, the battery icon will appear full. Charging a completely discharged battery can comprise 2 to 3 hours.











Fully charge the battery before using the device for the first time.

### Note:

Always make sure your device is turned off before removing your SIM card. This will prevent data loss and damage to the SIM card. Do not place the SIM card near surfaces or electromagnetic environments and avoid touching the metal connectors. For more information, contact your network operator.

# Keyboard

---



Key	Function
[  ] Turn On/Off	When the terminal is off, press for 3 seconds to turn the phone. When the terminal is on, press for 5 seconds to turn off the phone.
[  ][  ] Up/Down	Move the cursor up / down when you access the on-screen menu or submenus.
[  ][  ] Left/Right	Move the cursor left / right when you access the on-screen menu or submenus.
[  ] Confirmation	Confirm operations when accessing the on-screen menu or submenu. In standby mode, press to access the call log.
[  ][  ] Soft keys	Use these keys to perform the different actions indicated at the bottom of the on-screen menus.
[  ] Pick up	Press to dial an outgoing call or answer an incoming call.
[  ] Hang up	During an active call, press to end the call. In applications, press to return to the main menu.
[ <b>1...9</b> ] Numeric pad	Press to enter numbers or characters.



Key	Function
[*] Asterisk key	Insert asterisk character.
[#] Pad key	Insert pad character. Change the text input method.
[M1-M4] Memory keys	Programmable keys to store up to four telephone numbers.
[☎] Hold button	During an active call, press to hold the current call. During two active calls, press to switch from Call 1 to Call 2.
[↻] Transfer button	When you have two calls, one active and one held, press to make a call transfer between both calls. You can make a transfer “Without consultation,” pressing when making the second call.
[🗣] Conference button	You can make conference calls from your phone, press during a call for 2 or more participants.
[R] Recall button	In standby mode, press to redial the last number of the call log.
[🔊][🔇] Decrease / Increase volume	Press to decrease / increase the volume of handset or speaker.

# Keyboard

---

Key	Function
[  ] Mute button	Press during an active call to mute the microphone of your phone.
[  ] Hands-free button	In standby, press to make a call in hands-free mode, without lifting the handset. During an active call, press to enable or disable the hands-free mode on the phone.

## Numeric keypad

---

Check the table below when using the alphanumeric keypad. When introducing some form of text on your phone, you can switch between entering numbers (123), lower case (abc) or uppercase (ABC) by pressing the # key.

Key	Lowercase (abc)	Uppercase (ABC)
1	.,?!-@ 1	.,?!-@ 1
2	abc2	ABC2
3	def3	DEF3
4	ghi4	GHI4
5	jkl5	JKL5
6	mno6	MNO6
7	pqrs7	PQRS7
8	tuv8	TUV8
9	wxyz9	WXYZ9
0	[space] y 0	
#	Toggle among: Numbers / Lowercase / Uppercase / Default text	
*	Special character selection menu	

# Display

---

Keep pressing the [⏻] key for more than 3 seconds to turn on the unit. The first time a SIM card is installed, the phone will request to enter the PIN code. Then, the following user interface will be displayed on the screen.

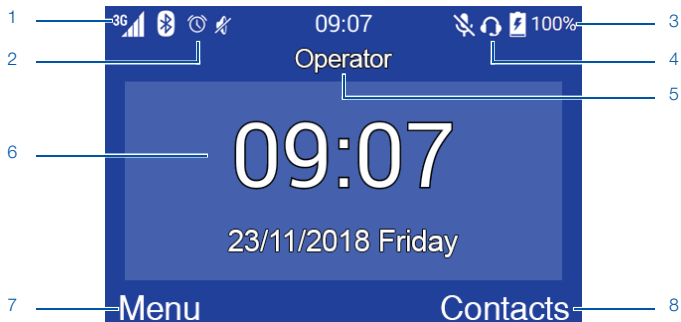

- |  |   |
|--|---|
| 1. 2G/3G coverage indicator                                  | 5. Network operator                       |
| 2. System notifications; SMS, calls, alarms, Bluetooth, etc  | 6. Time and date                          |
| 3. Battery level indicator                                   | 7. Function assigned to the left softkey  |
| 4. Status indications; microphone, handsfree, earphones, etc | 8. Function assigned to the right softkey |

Press [OK] button to display the call log, or use the left soft key to access the applications menu. You can also make a call from this interface by directly dialing the phone number on the numeric keypad.

To turn off the terminal, press the [⏻] for 5 seconds.

## System icons

---

The following illustration explain the meaning of some of the system icons that can be displayed on your phone:



Signal level



Data network connection



No signal



Mute



Call



Call end



Call transfer



Hands-free



Call missed



Call hold



Alarm active



SMS text message



MMS multimedia message



No SIM card



Low battery



Charging battery



Bluetooth connected



Bluetooth active



USB connection



Headphones connected



Headphones with mic

# Applications menu

---

Once you turn on the device and complete the setup process, the main menu will be displayed on the screen. Press the left soft key to access the applications menu and the next user interface will be displayed.

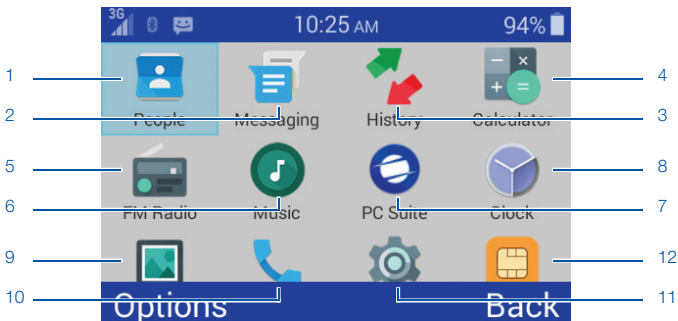

- |               |                 |
|---------------|-----------------|
| 1. People     | 7. PC suite     |
| 2. Messaging  | 8. Clock        |
| 3. History    | 9. Gallery      |
| 4. Calculator | 10. Phone       |
| 5. FM Radio   | 11. Settings    |
| 6. Music      | 12. SIM toolkit |

From the application menu you can also customize the main menu. Press the left selection key to display the available options:

- **Wallpapers:** choose the wallpaper of the main menu among the available backgrounds.
- **Soft key:** select the application associated with the right soft key in the main menu.
- **Call log widget:** enable this option to display the call log in the main menu, or disable to display the clock.

# Applications menu

Under the application menu, use the arrow keys [◀][▶][▲][▼] to select one of the icons, and press [OK] button to access the application.

## People

Select the  icon on the applications menu, and press [OK] button to access the phonebook of the phone. You can also access your favorite contacts pressing the right soft key on the main menu interface (by default).

## Messaging

Select the  icon on the applications menu, and press [OK] button to access the phone's messaging application. In this application you can compose and send SMS text and MMS multimedia messages, as well as check the messages received.

## History

Select the  icon on the applications menu, and press [OK] button to access the call log. From this menu you can consult the record of calls made, received and missed in the phone.

## Calculator

Select the  icon on the applications menu, and press [OK] button to access the call log. Use the keys displayed at the bottom of the interface to perform the different arithmetic functions.



[ ÷ ]	Divide
[ × ]	Multiply
[ − ]	Subtract
[ + ]	Add
[ OK ]	Equal to

# Applications menu

---

## FM radio

Select the  icon on the applications menu, and press [OK] button to access the FM radio application. Use the arrow keys [◀] [▶] to choose the searching mode manual (◀ ▶) or automatic (◀▶), and press [OK] button to search for radio stations. To stop the radio function, press the left soft key to display the options menu and select Power.

## Music

Select the  icon on the applications menu, and press [OK] button to access the audio player. Use the arrow keys [◀] [▶] to select the sorting type, and [▲] [▼] to choose the desired file. Press [OK] button to start playing, or press the left soft key to access the playback options, as well as delete files or share by message or Bluetooth.

## PC suite

There is a PC application available for your Co-Comm F700 that allows you to manage your calls, messages, contacts, etc. easily from your personal computer. You can download the PC application for your Co-Comm F700 on the website <http://www.cocomm.es/pcsuite>.

Install and launch the application downloaded on your PC. Select the  icon on the applications menu of the phone, and press [OK] button to access the PC suite mode. Connect an USB cable between the terminal and the PC, and then press Options and select Start PC Suite on the pop up window to connect your Co-Comm F700 to the application installed on your PC.



# Applications menu

---

## Clock

Select the  icon on the applications menu, and press [ **OK** ] button to access the alarm application. Press [ **OK** ] button enable or disable the focused alarm, or press the left soft key to edit, delete or add new alarms.

## Gallery

Select the  icon on the applications menu, and press [ **OK** ] button to access the picture gallery. In this application you can play the picture and video files stored in the phone memory or the micro SD card. Use the arrow keys [ **◀** ] [ **▶** ] [ **▲** ] [ **▼** ] to browse through the folders and files, and press [ **OK** ] button to play. Press the left soft key to access the playback options, as well as delete files or share by message or Bluetooth.

## Phone

Select the  icon on the applications menu, and press [ **OK** ] button to access the call menu. From this menu you can make calls to contacts in the phonebook, dial a phone number, or send text messages. You can also assign phone numbers to the speed dial keys [ **M1-M4** ], as well as to the buttons on the numeric keypad [ **1...9** ]. Press the left selection key to display the options menu, and follow the on-screen instructions.

## Settings

Select the  icon on the applications menu, and press [ **OK** ] button to access the system settings menu. Use the arrow keys [ **▲** ] [ **▼** ] to select the settings of display, sound, language, Bluetooth, etc., and press [ **OK** ] button to access the configuration.

# Settings diagram

---

## BLUETOOTH

## DISPLAY

- └ Brightness
- └ Wallpaper
- └ Sleep

## SOUND

- └ Volumes
- └ Phone ringtone
- └ Default notification sound

## LANGUAGE

## CALL SETTINGS

- └ Voice call
- └ Other settings
  - └ Fixed dialling numbers
  - └ Minute reminder
  - └ Quick responses
  - └ TTY mode
  - └ International dialling assist

# Settings diagram

---

## DATE & TIME

- Automatic date & time
- Automatic time zone
- Set date
- Set time
- Select time zone
- Use 24-hour format
- Choose date format

## SECURITY

- Owner info
- Set up SIM card lock
- Make passwords visible
- Factory data reset

## NETWORKS

- Network mode
- Network operators

## ABOUT PHONE



- Wireless Update
- Status
- COCOMM SAT
- Model number
- SW version
- Date compilation

# Calling





---

There are several ways to perform callings with your terminal Co-Comm F700:





## Calling using the alphanumeric keypad

1. In standby mode, pick up the handset, enter the phone number using the alphanumeric keypad and press  button to call.
2. To end the call, press the  button or hang up the handset.



## Calling in hands-free mode

1. Without picking up the handset, enter the phone number using the alphanumeric keypad and press  button to call. The  indicator will glow green, indicating that the hands-free mode is active.
2. During an active call, press  button to start hands-free mode and check how the  indicator lights up.
3. To end the call, press the  button or hang up the handset.

## Answer or silence an incoming call

1. During an incoming call, pick up the handset or press  button to answer the call.
2. Before the call is answered, you can mute the ring tone of the incoming call by pressing the  button.
3. When the call is active, press the  button to mute your microphone.
4. To reject an incoming call, press the  button.

## Adjusting the volume

During an active call, press the   buttons to decrease or increase respectively the volume of your headset or hands-free.

## Calling from call log

1. In standby mode press [OK] button or directly press the [📞] button to access the call log. The last call will be shown on screen.
2. Use the arrow keys [◀][▶] to display on the screen the list of outgoing, incoming or missed calls. Use the arrow keys [▲][▼] to scroll up and down the list, select an item and press the [📞] button to call.
3. To end the call, press the [📞] button or hang up the handset.

## Calling from phonebook

1. In standby mode, press the left soft key to access the applications menu, and then select the  icon to display the phonebook.
2. Use the arrow keys [▲][▼] to scroll up and down the contact list and select the desired contact.
3. Select the phone number and press [📞] button to call.
4. To end the call, press the [📞] button or hang up the handset.



## Transfer an incoming call

1. During an incoming call, pick up the handset or press [📞] button to answer the call.
2. Press [📞] button to pause the active call and start a second call to another phone number or contact in the phonebook, or press [Options](#) and select [Add call](#) from the popup menu.
3. When the second call is active, press [📞] button to transfer the incoming call to the second contact, or press [📞] button before the second call is active for a transfer “without consultation”.

# Calling

---

## Three way calling

1. During an incoming call, pick up the handset or press [] button to answer the call.
2. Press [] button to pause the active call and start a second call to another phone number or contact in the phonebook.
3. When the second call is active, press [] button, or press [Options](#) and select [Merge calls](#) from the popup menu to start the multi conference.
4. Repeat the same operation to add up to 5 participants.

## Calling with speed dial keys

1. In standby mode, press one of the memory keys [**M1-M4**], or hold down a key on the numeric keypad [**1...9**] to use speed dialing. The call will start automatically.
2. To end the call, press the [] button or hang up the handset.

## Configuring speed dial keys

1. Go to the applications menu, select the  icon and press [**OK**] button to access the calls menu.
2. Press [Options](#) and select [Speed Dial](#) from the popup menu.
3. Choose one of the speed dial memories **M1 - M4**, or **2 - 9** to edit its contents.
4. You can associate a phone number or a contact from the phonebook to the memory keys [**M1-M4**], while to the number keys [**1...9**] you can only associate contacts from the phonebook.
5. Select [Add](#) to confirm and complete the operation.

## Note:

Please ensure that the contacts have been installed in the memory keys before using the speed dial keys. The [ 1 ] key is reserved for voicemail function.

## Calling the voicemail

1. In standby mode, press and hold the [ 1 ] button to call the voicemail. The call will start automatically.
2. To end the call, press the [  ] button or hang up the handset.

## IMEI password

It can be obtained at any time. To do this you only need to type in the phone itself \*#06#. The terminal will automatically reveal its IMEI, which is unique to each device, regardless of the phone operator.

Additional you can consult the label in the product and the packaging.

# Messages

---

The Co-Comm F700 supports SMS text messages and MMS multimedia messages. This section explains how to send and receive messages, as well as other associated features.

## Create and send messages

1. Go to the applications menu, select the  icon and press [ **OK** ] button to access the phone's messaging application.
2. Press **Options** and select **New message** from the popup menu.
3. Enter the phone number or the name of the contact that you want to send a message. Press the [ **#** ] key to switch between uppercase, lowercase, and number, or use the [ **\*** ] key to enter special characters.
4. If you want to send the message to a contact from the phonebook, press **Options** and then press [ **OK** ] button over **Select contact** from the popup menu.
5. Type the text message in the field. If you want to add media files to your message, press **Options** and then press [ **OK** ] button over **Attach** from the popup menu.
6. Press **Options** and then press [ **OK** ] button over **Send by** to send the message.

## View and reply to messages

1. Go to the applications menu, select the  icon and press [ **OK** ] button to access the phone's messaging application.
2. Select one of the messages from the list and press [ **OK** ] button to display.
3. To reply to the message, write the text in the proper field. If you want to add media files to your message, press **Options** and then press [ **OK** ] button over **Attach** from the popup menu.
4. Press **Options** and then press [ **OK** ] button over **Send by** to send the message.



## Delete messages

1. Go to the applications menu, select the  icon and press [ **OK** ] button to access the phone's messaging application.
2. Select one of the messages from the list and press [ **OK** ] button to display.
3. Press **Options** and then press [ **OK** ] button over **Select message** from the popup menu. Choose the message you wish to delete and then press [ **OK** ] button to mark.
4. Press **Options** and then press [ **OK** ] button over **Delete message** to delete the message from the inbox.

## Empty inbox

1. Go to the applications menu, select the  icon and press [ **OK** ] button to access the phone's messaging application.
2. Press **Options** and then press [ **OK** ] button over **Delete all threads** from the popup window.
3. Select **Delete** in the confirmation window to complete the operation and delete all messages from the inbox.

## Message settings

1. Go to the applications menu, select the  icon and press [ **OK** ] button to access the phone's messaging application.
2. Press **Options** and then press [ **OK** ] button over **Settings** from the popup window. You may customize the following settings:
  - **Text message (SMS):** press to access text messages settings:
    - **Request delivery report:** select this option to receive a delivery report when sending a message.
    - **Manage SIM card messages:** use this option to delete messages and check the free and used space on the SIM card.

# Messages

---

- **Edit quick text:** this option allows you to edit and add quick texts which can be inserted in your messages.
- **SMS service center:** messaging server network operator, this field should not be modified.
- **SMS storage location:** It allows you to choose between the SIM card or phone memory for storing messages.
- **Optimization:** enable this option to send messages in optimized mode (GSM 7 bit), or disable if you want to use accent marks and other special characters in your text messages (Unicode UCS2).
- **Multimedia message (MMS):** press to access the multimedia message settings:
  - **Group messaging:** use this option to send a message to multiple recipients using MMS.
  - **Request delivery report:** select this option to receive a delivery report when sending a message.
  - **Request read report:** select this option to receive a read message report when sending a message.
  - **Send read report:** select to send a read message report when it is required by the sender.
  - **Auto-retrieve:** use this option to automatically download messages.
  - **Roaming auto-retrieve:** use this option to automatically download when you are in data roaming.
  - **Creation mode:** in free mode, a text message is converted to MMS when you exceed the maximum number of characters allowed.
  - **Size limit:** it allows you to choose the maximum size for MMS messages.
  - **Priority:** it allows you to choose the priority for MMS messages.

- **Notifications:** press to access message notifications settings:
  - **Message notifications:** press to activate or deactivate message notifications.
  - **Mute:** use this option to temporarily mute message notifications.
  - **Sound:** choose the alert message tone.
  - **Popup notification:** displays pop-up notifications for Push messages. Push messages are notifications that a server sends to an application alerting that there is a new information such as an email or a chat message.
- **General:** press to access the general message settings:
  - **Message font size:** select the text size for your conversations.
  - **Show email address:** press to include email address in contact messages.
  - **Storage settings:** it allows you to set a limit of stored messages from which the oldest messages will be deleted automatically.
  - **Cell broadcast settings:** enables cell broadcasting in the SIM card.
  - **Service message settings:** enables the reception of WAP Push messages. A WAP Push message is a type of SMS that is used to directly access a WAP site or page, usually to download files. The user sends an SMS and receive another one with a welcome message to an URL, which when accepted opens in the browser the WAP address requested.

# Contacts

---

This section explains how to create and manage your phonebook.

## Creating a new contact

1. In standby mode, use the alphanumeric keypad to enter the number of the new contact.
2. Press **Options** and select **Add to contacts** from the popup menu.
3. Press **Create new contact**, and then select the destination in which the contact will be saved (SIM card, phone, etc.).
4. Fill out the form with the data you want to enter for the new contact, and press **Done** to save the entry and complete the operation.

## Creating a new contact from the call log

1. Go to the applications menu, select the  icon and press [ **OK** ] button to access the phone's call log.
2. Use the arrow keys [ **◀** ] [ **▶** ] to display on the screen the list of outgoing, incoming or missed calls, and use the arrow keys [ **▲** ] [ **▼** ] to select a call and press [ **OK** ] button to display.
3. Press **Options** and select **Edit number before call** to display the telephone number on the screen.
4. Press **Options** and select **Add contacts**, and then press **Create a new contact**, and select the destination to store the contact (SIM card, phone, etc.).
5. Fill out the form with the data to be entered for the new contact, and press **Done** to save the entry and complete the operation.

## Import/Export contacts

1. Go to the applications menu, select the  icon and press [ **OK** ] button to access the phonebook.
2. Press **Options** and select **Import/Export** from the popup menu.
3. Choose the source from which you want to copy contacts (SIM card, phone, internal memory, etc.).
4. Select the destination you want to copy contacts.
5. Select the contacts you want to copy, or press **Options** and then **Select all** to select all contacts in the data source, and press **OK** to complete the operation.

## Contact edit

1. Go to the applications menu, select the  icon and press [ **OK** ] button to access the phonebook.
2. Use the arrow keys [ **▲** ] [ **▼** ] to select a contact and press [ **OK** ] button to display.
3. Press **Options** and select **Edit** from the popup menu.
4. Fill out the form with the data to be entered for the new contact, and press **Done** to save the entry and complete the operation.

## Delete contact

1. Go to the applications menu, select the  icon and press [ **OK** ] button to access the phonebook.
2. Use the arrow keys [ **▲** ] [ **▼** ] to select a contact and press [ **OK** ] button to display.
3. Press **Options** and select **Delete** from the popup menu.
4. Select **OK** in the confirmation window to delete the contact.

# Bluetooth® connection

---

The Bluetooth® function allows you to pair your terminal with other Bluetooth devices, allowing different functions:

- Connect Bluetooth accessories, such as Bluetooth paired headphones to answer calls received in the terminal.
- Exchange contacts and video, audio and photo files with other Bluetooth paired devices.

## Pairing to a Bluetooth® device

1. Select the  icon in the applications menu, and press [OK] button to access the system settings menu. Use the arrow keys [▲] [▼] to select **Bluetooth**, and press [OK] button to enable the Bluetooth function.
2. Press [OK] button on the name of the terminal to activate the temporary visibility of the device, and do the same on the other device you want to pair.
3. Press [OK] button over **Search for devices**, and all Bluetooth devices visible within the range of the terminal will be displayed on the screen.
4. Press [OK] button on the device you want to pair to your terminal, and enter the requested code in the popup window on both devices. Once the setup is complete, press **Options** to change the name of the paired device and make audio adjustments.

Once the Bluetooth function is enabled, the  icon will be displayed in the notification bar. If any previously paired device is within the range of the terminal, it will be connected automatically, and the  icon will light up in the notification bar.

To deactivate the Bluetooth function, access the Bluetooth setup menu within the system settings, press **Options** and select **Off** in the pop-up menu. Within this menu you can also rename your terminal or change the visibility timeout for the Bluetooth function.

## The phone can not be turned on

- Be sure to hold down the [  ] button for more than 5 seconds.
- Make sure the battery is properly connected to your phone.
- Remove the battery, reinstall it and restart your phone.
- If the battery is low, recharge the battery.

## The phone asks for PIN code

- The PIN lock feature is enabled. Each time the phone is switched on, the PIN must be entered (if you are using your phone for the first time, you must enter the PIN code provided with the SIM card).

## The phone asks for PUK code

- The PIN code has been entered incorrectly three times, and now the SIM card is locked. Enter the PUK code provided by your network operator.

## The phone asks for unlock code

- The automatic locking function has been enabled in the phone. You must enter the unlock code before you can use the phone.

## SIM card error

- Clean the metal contacts on the SIM card with a clean cloth (do not use a solvent).
- The SIM card is not properly placed. Insert the SIM card according to the figure in the unit.
- The SIM card is damaged, contact your network provider.

# Troubleshooting

---

## Network failure

- It is possible that the phone is located in an area of weak signal, move to a place with a stronger signal.

## It is out of the network service coverage

- The SIM card is not valid, contact your network provider.

## You have entered a number but the phone is not calling

- Make sure you have pressed the button correctly.
- Check the call barring options. Verify that barring is disabled for the contact number.
- Check the fixed dialing setting is disabled.
- Check that the SIM card is within network coverage.
- Your network operator may be experiencing connection problems.

## The call quality is poor

- Check the volume.
- It is in a weak signal area, such as near tall buildings or in a basement. Move to a location with better signal strength.
- Your network operator may be experiencing connection problems.

## Your correspondent can not call you

- Make sure the phone is turned on and connected to a network.
- Make sure the SIM card is not locked.
- Check that the SIM card is within network coverage.
- Check that you have not set an incoming call barring.



## Your correspondent can not hear you

- Increase the handset volume.
- Check that the handset cable is securely connected to the phone.

## The battery duration in standby mode is too short

- The battery standby duration is related to network configuration. You may be in a weak signal area. If the phone can not receive signals, it will keep sending a signal to search network and consume additional power, which shortens the battery duration.

## The battery needs to be changed

- If the battery cannot charge properly.
- Make sure the power cord is connected to the unit to charge the battery efficiently.
- Clean the charging contacts in the phone and battery with a clean, dry cloth.
- Replace the battery or charger if it seems to be damaged.

If the above guidelines do not help solve the problem, note the model number and serial number of your phone, your warranty details and a clear description of the problem. Then contact the provider after-sales service.

# Regulations

---

## SAR certification information

The SAR limit of USA (FCC) is 1.6 W/kg averaged over one gram of tissue. Device types: F700 (FCC ID: 2AUR3-F700) has also been tested against this SAR limit. The highest SAR value reported under this standard during product certification for use on the body is 1.247 W/kg on WCDMA Band II.

## FCC Compliance Statement

This device complies with part 15 of the FCC Rules. Operation is subject to the following two conditions: (1) This device may not cause harmful interference, and (2) this device must accept any interference received, including interference that may cause undesired operation.

Any Changes or modifications not expressly approved by the party responsible for compliance could void the user's authority to operate the equipment.

Note: This equipment has been tested and found to comply with the limits for a Class B digital device, pursuant to part 15 of the FCC Rules. These limits are designed to provide reasonable protection against harmful interference in a residential installation.

This equipment generates uses and can radiate radio frequency energy and, if not installed and used in accordance with the instructions, may cause harmful interference to radio communications. However, there is no guarantee that interference will not occur in a particular installation. If this equipment does cause harmful interference to radio or television reception, which can be determined by turning the equipment off and on, the user is encouraged to try to correct the interference by one or more of the following measures:

- Reorient or relocate the receiving antenna.
- Increase the separation between the equipment and receiver.
- Connect the equipment into an outlet on a circuit different from that to which the receiver is connected.
- Consult the dealer or an experienced radio/TV technician for help.

The information on this device is registered on the FCC website and can be consulted by entering on that website the FCC ID found on the back of the device.

# Regulations

---



Bluetooth® mark and logos are owned by Bluetooth SIG, Inc.

All other trademarks, products, services and company names mentioned herein belong to their respective owners.

Copyright © CO-COMM Servicios Telecomunicaciones S.L. 2018. All rights reserved. CO-COMM Servicios Telecomunicaciones S.L. reserves the right to change or modify any information or specifications contained in this manual without previous notice.



Copyright © CO-COMM  
Servicios Telecomunicaciones S.L. 2018  
All rights reserved