



FCC RADIO TEST REPORT

FCC ID : 2AUPE-8959
Equipment : Digital Media Receiver
Model Name : T4E4AT
Applicant : Turley White LLC
35 Village Road, Suite 100
Middleton, MA 01949
United States
Standard : FCC Part 15 Subpart C §15.247

The product was received on May 07, 2020 and testing was started from May 21, 2020 and completed on Jul. 08, 2020. We, SPORTON INTERNATIONAL INC., EMC & Wireless Communications Laboratory, would like to declare that the tested sample has been evaluated in accordance with the test procedures and has been in compliance with the applicable technical standards.

The test results in this report apply exclusively to the tested model / sample. Without written approval of SPORTON INTERNATIONAL INC. EMC & Wireless Communications Laboratory, the test report shall not be reproduced except in full.

Louis Wu

Approved by: Louis Wu

SPORTON INTERNATIONAL INC. EMC & Wireless Communications Laboratory

No. 52, Huaya 1st Rd., Guishan Dist., Taoyuan City, Taiwan (R.O.C.)



Table of Contents

History of this test report.....	3
Summary of Test Result.....	4
1 General Description.....	5
1.1 Product Feature of Equipment Under Test.....	5
1.2 Product Specification of Equipment Under Test.....	5
1.3 Modification of EUT	5
1.4 Testing Location	6
1.5 Applicable Standards.....	6
2 Test Configuration of Equipment Under Test	7
2.1 Carrier Frequency Channel	7
2.2 Test Mode.....	8
2.3 Connection Diagram of Test System.....	9
2.4 Support Unit used in test configuration and system	10
2.5 EUT Operation Test Setup	10
2.6 Measurement Results Explanation Example.....	11
3 Test Result.....	12
3.1 6dB and 99% Bandwidth Measurement	12
3.2 Output Power Measurement.....	17
3.3 Power Spectral Density Measurement	18
3.4 Conducted Band Edges and Spurious Emission Measurement	23
3.5 Radiated Band Edges and Spurious Emission Measurement	30
3.6 AC Conducted Emission Measurement.....	35
3.7 Antenna Requirements.....	37
4 List of Measuring Equipment	38
5 Uncertainty of Evaluation.....	40
Appendix A. Conducted Test Results	
Appendix B. AC Conducted Emission Test Result	
Appendix C. Radiated Spurious Emission	
Appendix D. Radiated Spurious Emission Plots	
Appendix E. Duty Cycle Plots	



Summary of Test Result

Report Clause	Ref Std. Clause	Test Items	Result (PASS/FAIL)
3.1	15.247(a)(2)	6dB Bandwidth	Pass
3.1	2.1049	99% Occupied Bandwidth	Reporting only
3.2	15.247(b)(3)	Output Power	Pass
3.3	15.247(e)	Power Spectral Density	Pass
3.4	15.247(d)	Radiated Band Edges and Spurious Emission	Pass
3.6	15.207	AC Conducted Emission	Pass
3.7	15.203 & 15.247(b)	Antenna Requirement	Pass

Declaration of Conformity:

The test results with all measurement uncertainty excluded are presented in accordance with the regulation limits or requirements declared by manufacturers.

Comments and Explanations:

The declared of product specification for EUT presented in the report are provided by the manufacturer, and the manufacturer takes all the responsibilities for the accuracy of product specification.

Reviewed by: Wii Chang

Report Producer: Yimin Ho



1 General Description

1.1 Product Feature of Equipment Under Test

Product Feature	
Equipment	Digital Media Receiver
Model Name	T4E4AT
FCC ID	2AUPE-8959
EUT supports Radios application	WLAN 11b/g/n HT20 WLAN 11a/n HT20/HT40 WLAN 11ac VHT20/VHT40/VHT80 Bluetooth BR/EDR/LE Zigbee/FSK/LoRa

1.2 Product Specification of Equipment Under Test

Standards-related Product Specification	
Tx/Rx Frequency Range	2405 MHz ~ 2480 MHz
Number of Channels	16
Carrier Frequency of Each Channel	5 MHz
Maximum Output Power to Antenna	16.50 dBm (0.0447 W)
99% Occupied Bandwidth	2.313 MHz
Antenna Type / Gain	Inverted F type Antenna with gain 2.15 dBi
Type of Modulation	OQPSK

1.3 Modification of EUT

No modifications are made to the EUT during all test items.



1.4 Testing Location

Test Site	SPORTON INTERNATIONAL INC. EMC & Wireless Communications Laboratory	
Test Site Location	No.52, Huaya 1st Rd., Guishan Dist., Taoyuan City, Taiwan (R.O.C.) TEL: +886-3-327-3456 FAX: +886-3-328-4978	
Test Site No.	Sporton Site No.	
	TH05-HY	CO05-HY

Note: The test site complies with ANSI C63.4 2014 requirement.

Test Site	SPORTON INTERNATIONAL INC. EMC & Wireless Communications Laboratory	
Test Site Location	No.58, Aly. 75, Ln. 564, Wenhua 3rd, Rd., Guishan Dist., Taoyuan City, Taiwan (R.O.C.) TEL: +886-3-327-0868 FAX: +886-3-327-0855	
Test Site No.	Sporton Site No.	
	03CH16-HY	

Note: The test site complies with ANSI C63.4 2014 requirement.

FCC designation No.: TW1190 and TW0007

1.5 Applicable Standards

According to the specifications of the manufacturer, the EUT must comply with the requirements of the following standards:

- ♦ FCC Part 15 Subpart C §15.247
- ♦ FCC KDB Publication No. 558074 D01 DTS Meas. Guidance v05r02
- ♦ FCC KDB 414788 D01 Radiated Test Site v01r01
- ♦ ANSI C63.10-2013

Remark:

1. All test items were verified and recorded according to the standards and without any deviation during the test.
2. The TAF code is not including all the FCC KDB listed without accreditation.



2 Test Configuration of Equipment Under Test

2.1 Carrier Frequency Channel

Frequency Band	Channel	Freq. (MHz)	Channel	Freq. (MHz)
2400-2483.5 MHz	11	2405	19	2445
	12	2410	20	2450
	13	2415	21	2455
	14	2420	22	2460
	15	2425	23	2465
	16	2430	24	2470
	17	2435	25	2475
	18	2440	26	2480



2.2 Test Mode

- a. The EUT has been associated with peripherals and configuration operated in a manner tended to maximize its emission characteristics in a typical application. Frequency range investigated: conduction emission (150 kHz to 30 MHz), radiation emission (9 kHz to the 10th harmonic of the highest fundamental frequency or to 40 GHz, whichever is lower) For radiated measurement, pre-scanned in two degrees (0 and 40). The worst cases (Degree 40) were recorded in this report.
- b. AC power line Conducted Emission was tested under maximum output power.

The following summary table is showing all test modes to demonstrate in compliance with the standard.

Summary table of Test Cases	
Test Item	Data Rate / Modulation
	250 kbps / OQPSK
Conducted Test Cases	Mode 1: Zigbee Tx CH11_2405 MHz Mode 2: Zigbee Tx CH17_2435 MHz Mode 3: Zigbee Tx CH25_2475 MHz Mode 4: Zigbee Tx CH26_2480 MHz
Radiated Test Cases	Mode 1: Zigbee Tx CH11_2405 MHz Mode 2: Zigbee Tx CH17_2435 MHz Mode 3: Zigbee Tx CH25_2475 MHz Mode 4: Zigbee Tx CH26_2480 MHz
AC Conducted Emission	Mode 1 : WLAN (2.4GHz) Link + Bluetooth Link + Zigbee Link + Motor + Adapter + H-Pattern + Audio + Display 40 Mode 2 :Lora Tx + Adapter + Display 40
Remark: The worst case of conducted emission is mode 2; only the test data of it was reported.	

2.3 Connection Diagram of Test System

<AC Conducted Emission with with WLAN (2.4GHz)/Bluetooth/Zigbee Mode>

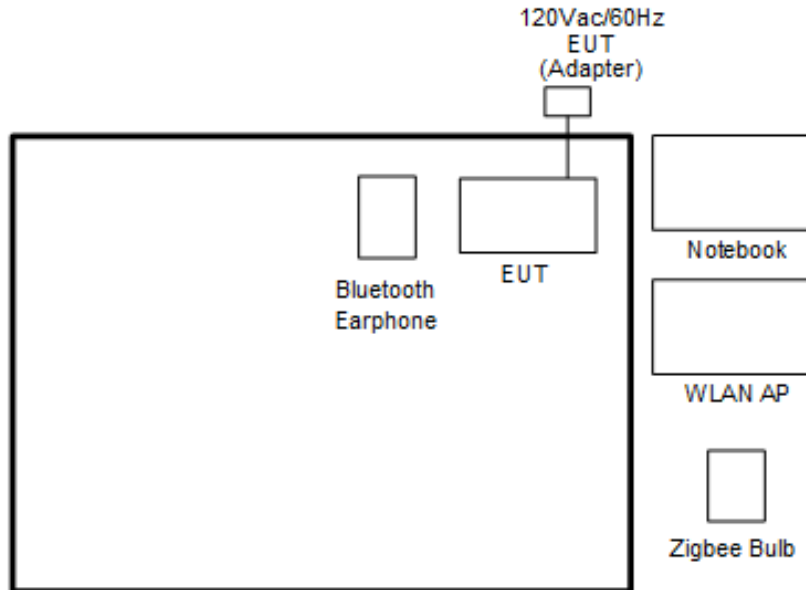

<AC Conducted Emission Lora Tx Mode>

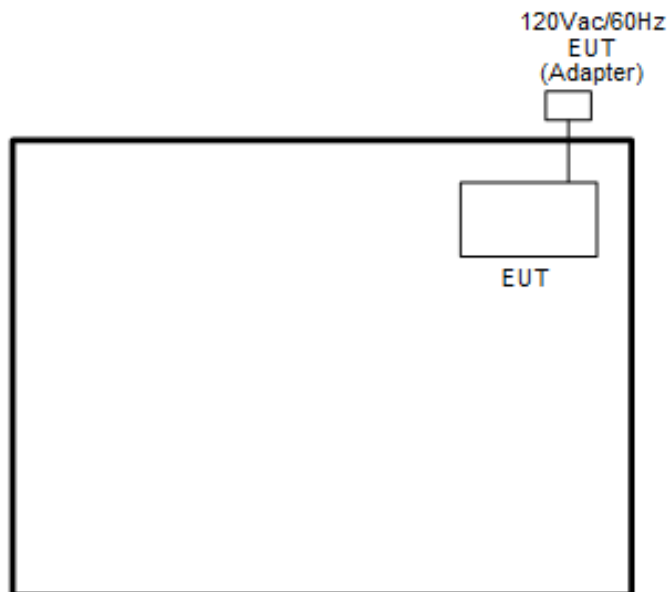

<Zigbee Tx Mode>

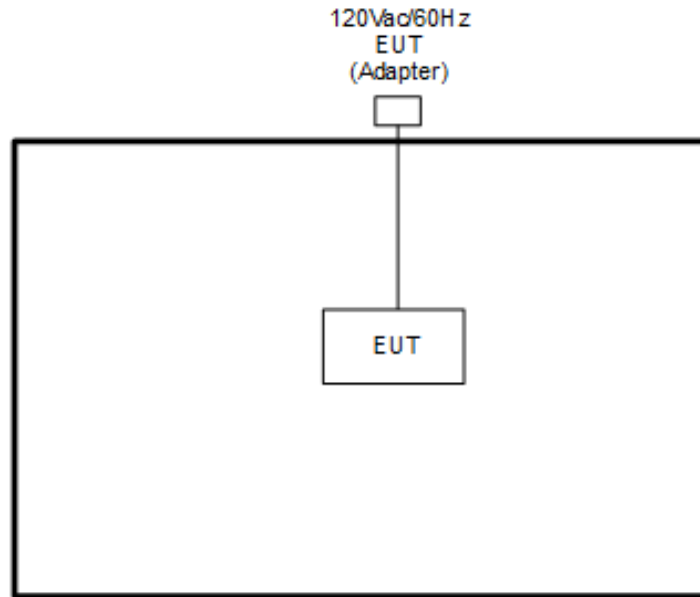

2.4 Support Unit used in test configuration and system

Item	Equipment	Trade Name	Model Name	FCC ID	Data Cable	Power Cord
1.	WLAN AP	ASUS	RT-AC66U	MSQ-RTAC66U	N/A	Unshielded, 1.8m
2.	Notebook	DELL	Latitude E3400	FCC DoC	N/A	AC I/P: Unshielded, 1.2 m DC O/P: Shielded, 1.8 m
3.	Zigbee Bulb	OSRAM	73674	DZO-IQHOME	N/A	N/A
4.	Bluetooth Earphone	Sony Ericsson	MW600	PY700A2029	N/A	N/A

2.5 EUT Operation Test Setup

The RF test items, utility “Compliance v1.0.0.80” was installed in Notebook which was programmed in order to make the EUT get into the engineering modes to provide channel selection, power level, data rate and the application type and for continuous transmitting signals.



2.6 Measurement Results Explanation Example

For all conducted test items:

The offset level is set in the spectrum analyzer to compensate the RF cable loss and attenuator factor between EUT conducted output port and spectrum analyzer. With the offset compensation, the spectrum analyzer reading level is exactly the EUT RF output level.

Example :

The spectrum analyzer offset is derived from RF cable loss and attenuator factor.

Offset = RF cable loss + attenuator factor.

Following shows an offset computation example with cable loss 4.2 dB and 10dB attenuator.

$$\begin{aligned} \text{Offset(dB)} &= \text{RF cable loss(dB)} + \text{attenuator factor(dB)}. \\ &= 4.2 + 10 = 14.2 \text{ (dB)} \end{aligned}$$

3 Test Result

3.1 6dB and 99% Bandwidth Measurement

3.1.1 Limit of 6dB and 99% Bandwidth

The minimum 6 dB bandwidth shall be at least 500 kHz.

3.1.2 Measuring Instruments

See list of measuring equipment of this test report.

3.1.3 Test Procedures

1. The testing follows the ANSI C63.10 Section 6.9.3 (OBW) and 11.8.1 (6dB BW).
2. The RF output of EUT was connected to the spectrum analyzer by RF cable and attenuator. The path loss was compensated to the results for each measurement.
3. Set to the maximum power setting and enable the EUT transmit continuously.
4. Make the measurement with the spectrum analyzer's resolution bandwidth (RBW) = 100 kHz. Set the Video bandwidth (VBW) = 300 kHz. In order to make an accurate measurement. The 6 dB bandwidth must be greater than 500 kHz.
5. For 99% Bandwidth Measurement, the spectrum analyzer's resolution bandwidth (RBW) is set 1-5% of the emission bandwidth and set the Video bandwidth (VBW) $\geq 3 * RBW$.
6. Measure and record the results in the test report.

3.1.4 Test Setup





3.1.5 Test Result of 6dB Bandwidth

Please refer to Appendix A.

6 dB Bandwidth Plot on Channel 11

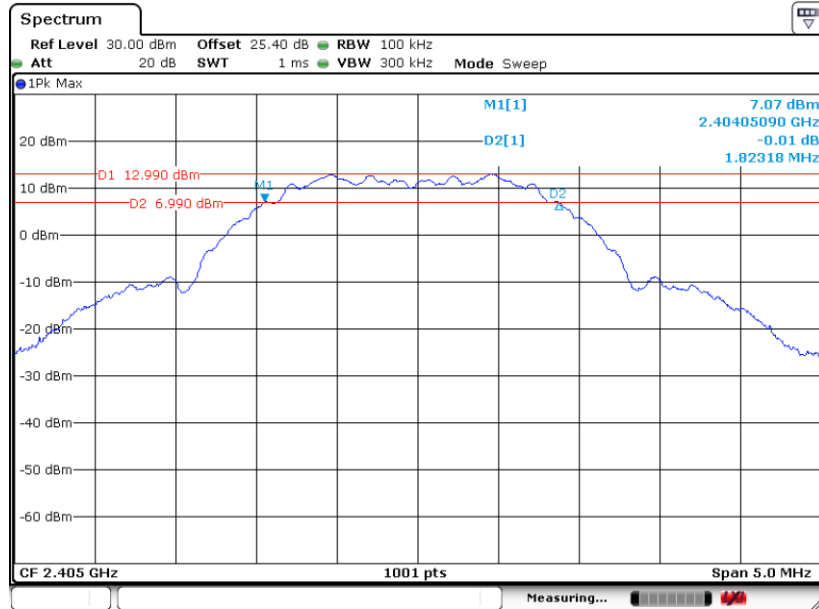

Date: 8.JUL.2020 22:29:29

6 dB Bandwidth Plot on Channel 17

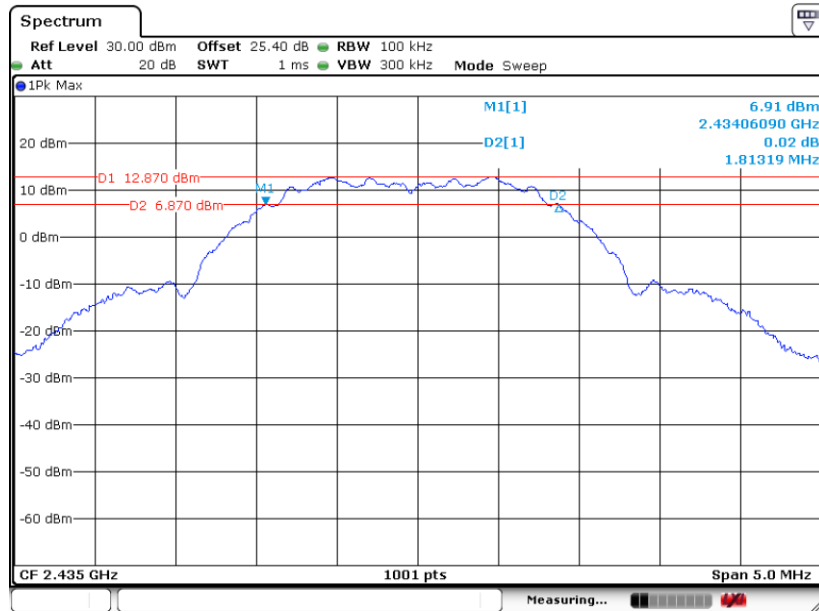

Date: 8.JUL.2020 22:36:31



6 dB Bandwidth Plot on Channel 25

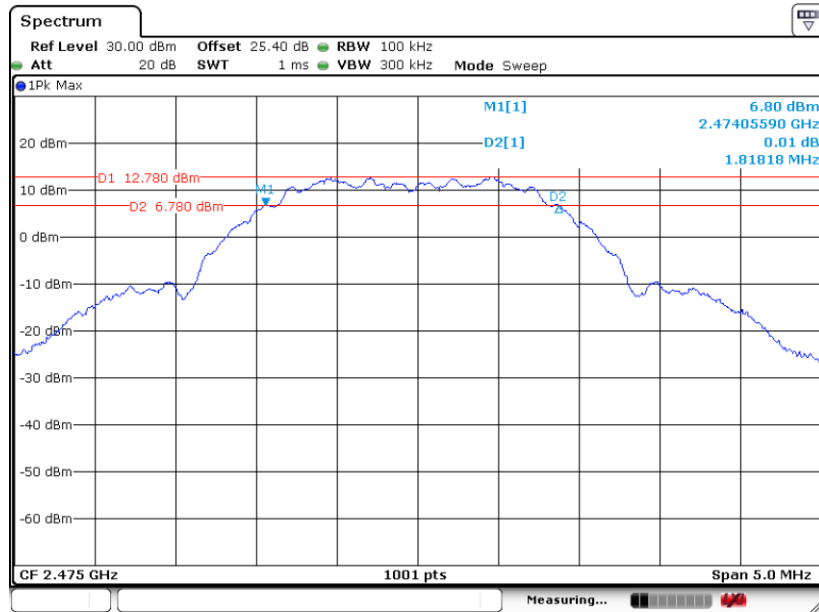

Date: 8.JUL.2020 22:41:32

6 dB Bandwidth Plot on Channel 26

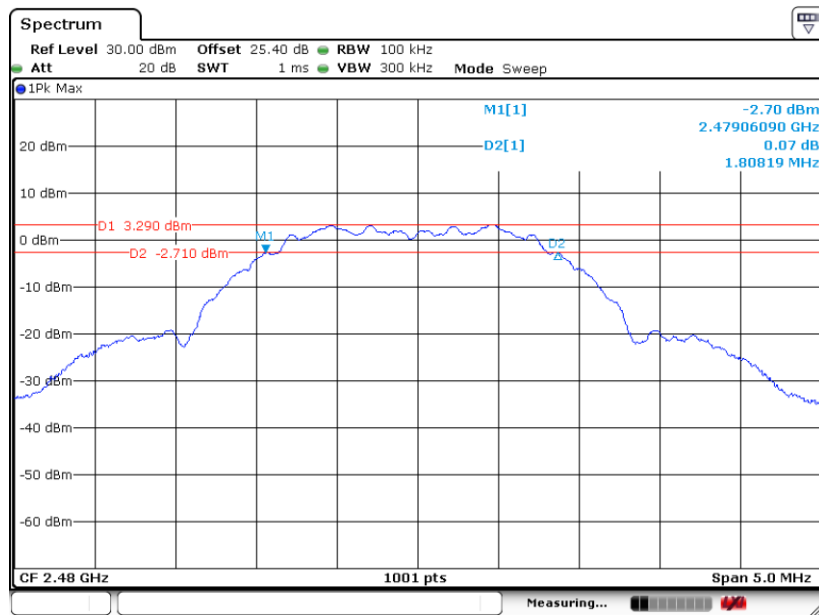

Date: 8.JUL.2020 22:47:41



3.1.6 Test Result of 99% Occupied Bandwidth

Please refer to Appendix A.

99% Occupied Bandwidth Plot on Channel 11

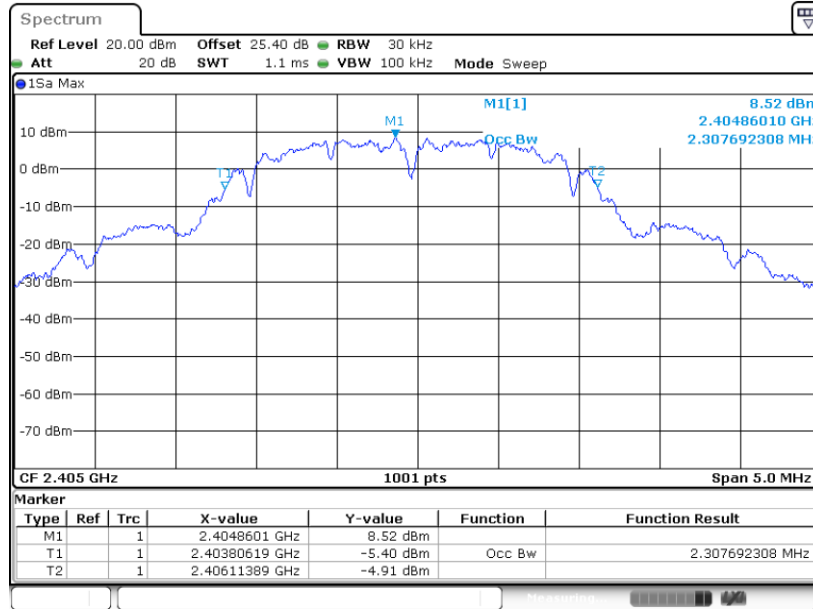

Date: 8.JUL.2020 22:33:19

99% Occupied Bandwidth Plot on Channel 17

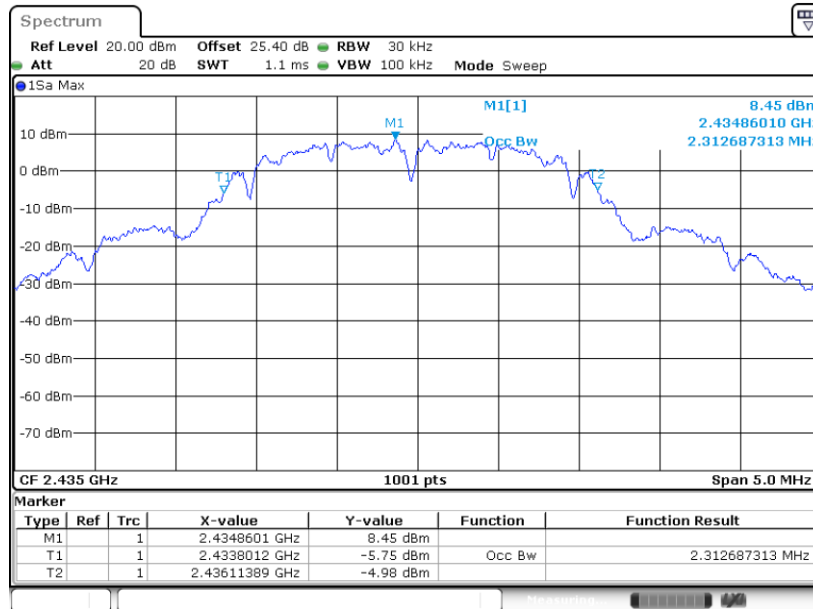

Date: 8.JUL.2020 22:39:26



99% Occupied Bandwidth Plot on Channel 25

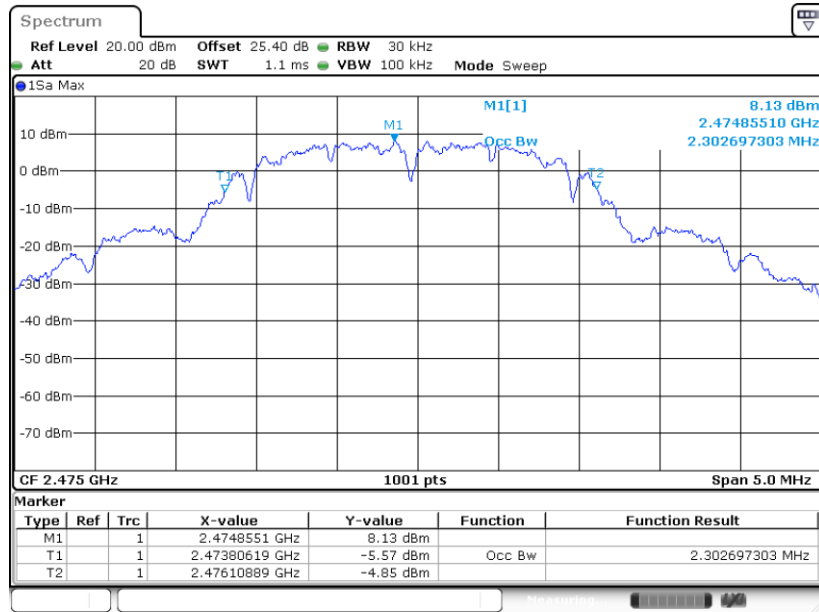

Date: 8.JUL.2020 22:45:53

99% Occupied Bandwidth Plot on Channel 26

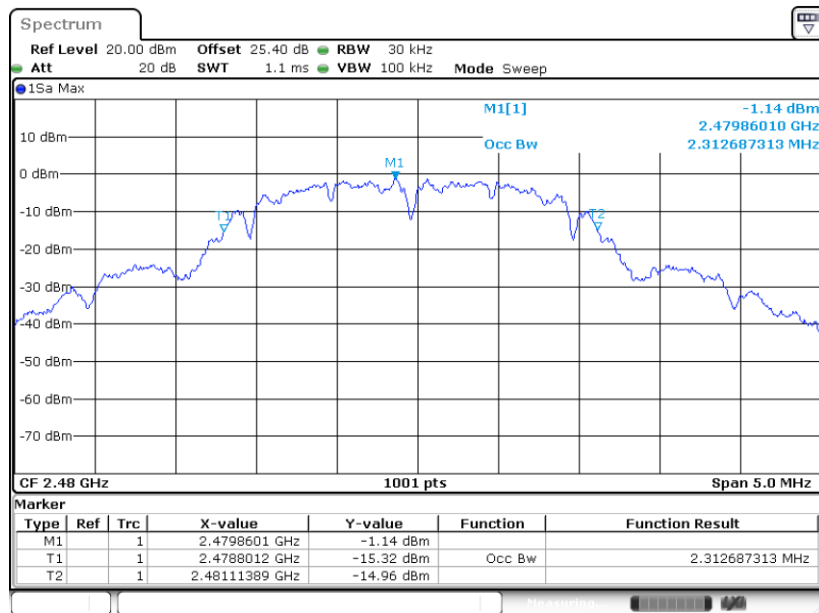

Date: 8.JUL.2020 22:51:50

Note: The occupied channel bandwidth is maintained within the band of operation for all of the modulations.

3.2 Output Power Measurement

3.2.1 Limit of Output Power

For systems using digital modulation in the 2400-2483.5MHz, the limit for peak output power is 30dBm. If transmitting antenna of directional gain greater than 6dBi is used, the peak output power from the intentional radiator shall be reduced below the above stated value by the amount in dB that the directional gain of the antenna exceeds 6 dBi. In case of point-to-point operation, the limit has to be reduced by 1dB for every 3dB that the directional gain of the antenna exceeds 6dBi.

3.2.2 Measuring Instruments

See list of measuring equipment of this test report.

3.2.3 Test Procedures

1. For Average Power, the testing follows ANSI C63.10 Section 11.9.2.3.2 Method AVGP-M-G
2. The RF output of EUT was connected to the power meter by RF cable and attenuator.
3. The path loss was compensated to the results for each measurement.
4. Set to the maximum power setting and enable the EUT transmit continuously.
5. Measure the conducted output power and record the results in the test report.

3.2.4 Test Setup

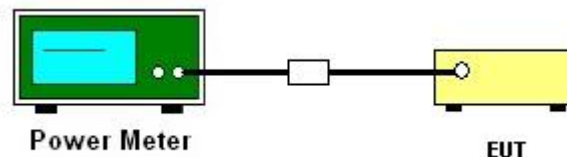

3.2.5 Test Result of Average Output Power

Please refer to Appendix A.

3.3 Power Spectral Density Measurement

3.3.1 Limit of Power Spectral Density

The peak power spectral density shall not be greater than 8dBm in any 3kHz band at any time interval of continuous transmission.

3.3.2 Measuring Instruments

See list of measuring equipment of this test report.

3.3.3 Test Procedures

1. The testing follows the ANSI C63.10 Section 11.10.2 Method PKPSD.
2. The RF output of EUT was connected to the spectrum analyzer by RF cable and attenuator. The path loss was compensated to the results for each measurement.
3. Set to the maximum power setting and enable the EUT transmit continuously.
4. Make the measurement with the spectrum analyzer's resolution bandwidth (RBW) = 3 kHz. Video bandwidth VBW = 10 kHz In order to make an accurate measurement, set the span to 1.5 times DTS Channel Bandwidth. (6dB BW)
5. Detector = peak, Sweep time = auto couple, Trace mode = max hold, Allow trace to fully stabilize. Use the peak marker function to determine the maximum power level.
6. Measure and record the results in the test report.
7. The Measured power density (dBm)/ 100kHz is a reference level and used as 20dBc down limit line for Conducted Band Edges and Conducted Spurious Emission.

3.3.4 Test Setup

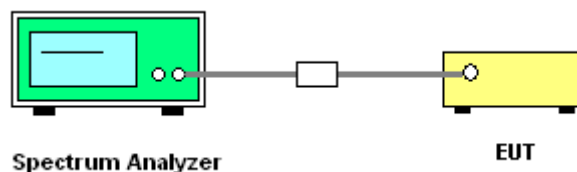

3.3.5 Test Result of Power Spectral Density

Please refer to Appendix A.



3.3.6 Test Result of Power Spectral Density Plots (100kHz)

PSD 100kHz Plot on Channel 11

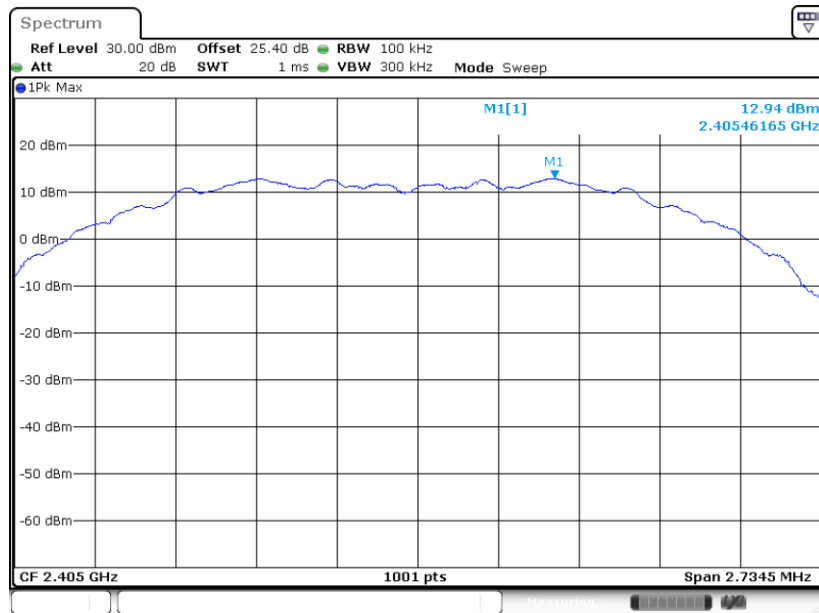

Date: 8.JUL.2020 22:30:42

PSD 100kHz Plot on Channel 17

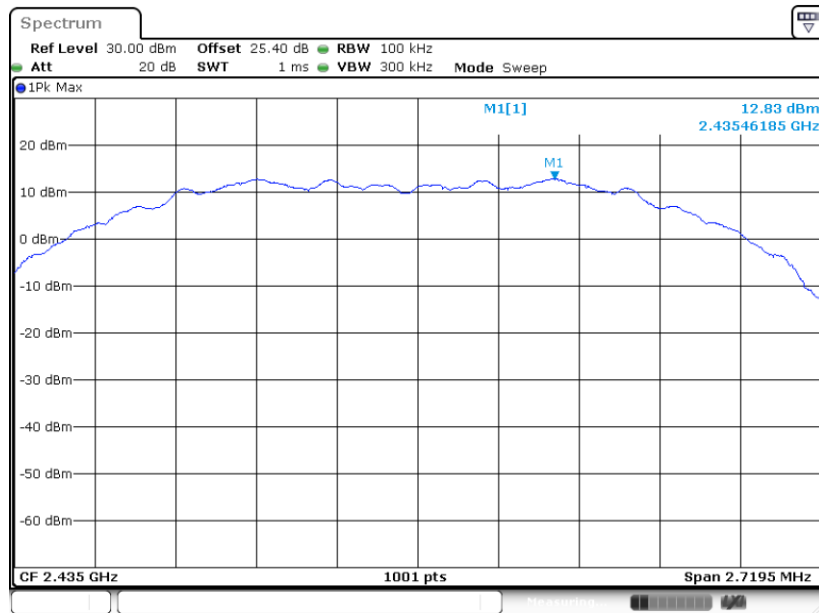

Date: 8.JUL.2020 22:37:31



PSD 100kHz Plot on Channel 25

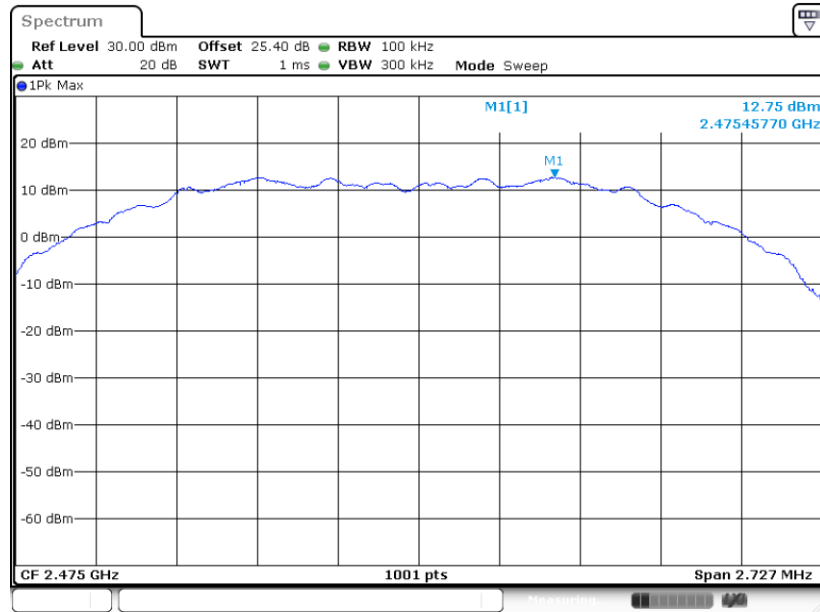

Date: 8.JUL.2020 22:43:08

PSD 100kHz Plot on Channel 26

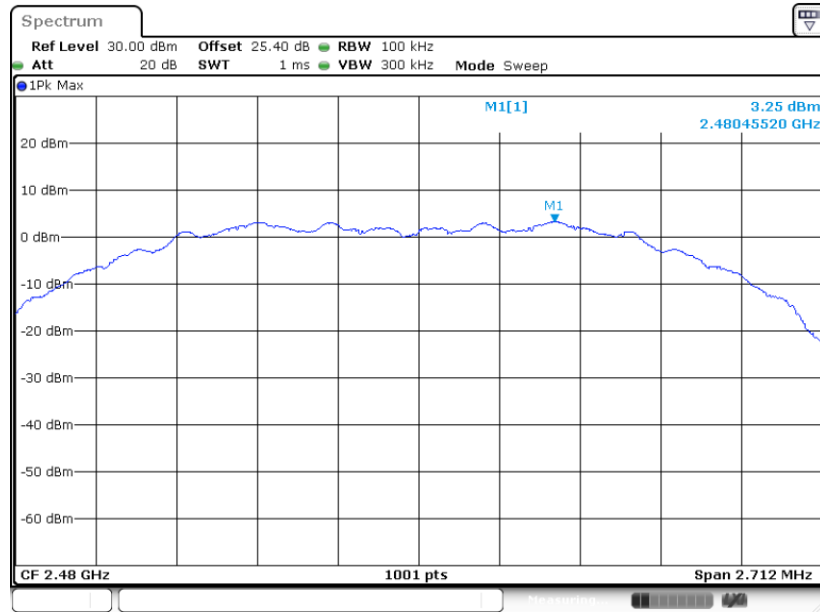

Date: 8.JUL.2020 22:48:41



3.3.7 Test Result of Power Spectral Density Plots (3kHz)

PSD 3kHz Plot on Channel 11

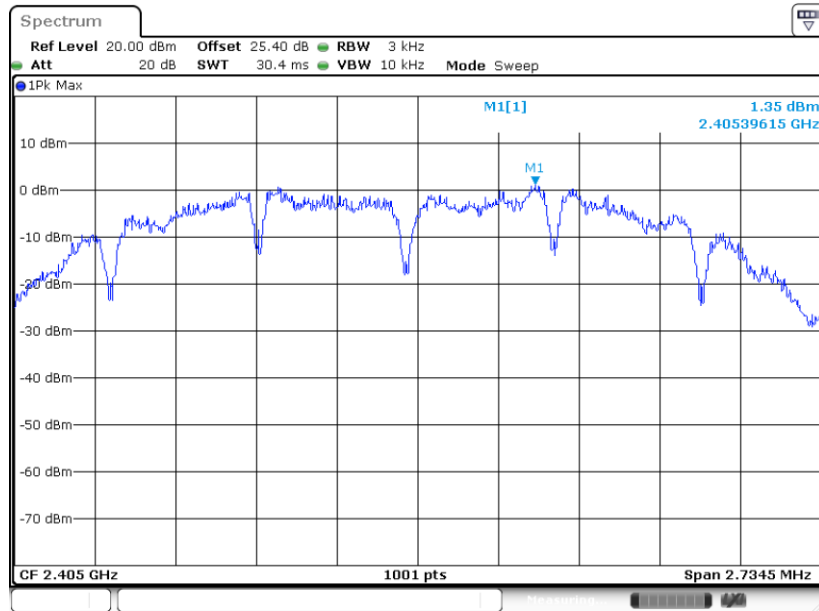

Date: 8.JUL.2020 22:29:52

PSD 3kHz Plot on Channel 17

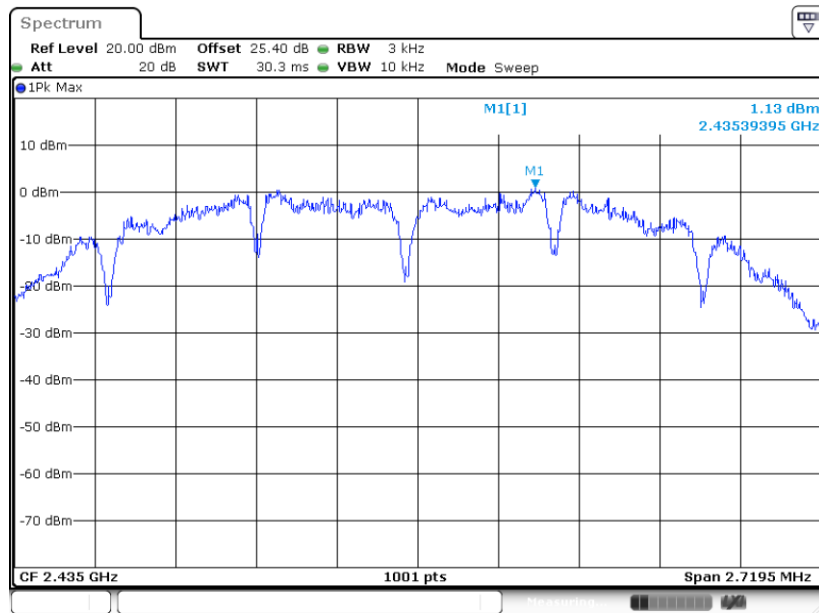

Date: 8.JUL.2020 22:36:55



PSD 3kHz Plot on Channel 25

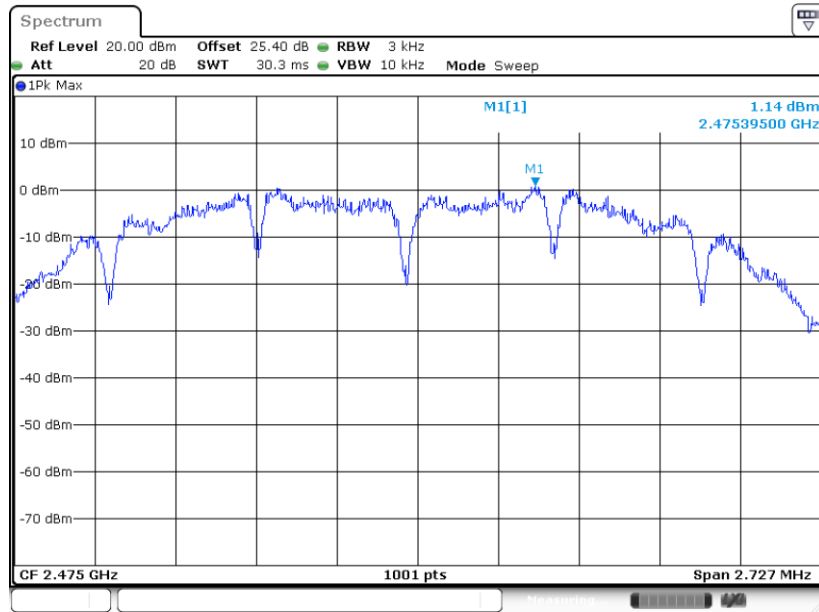

Date: 8.JUL.2020 22:42:21

PSD 3kHz Plot on Channel 26

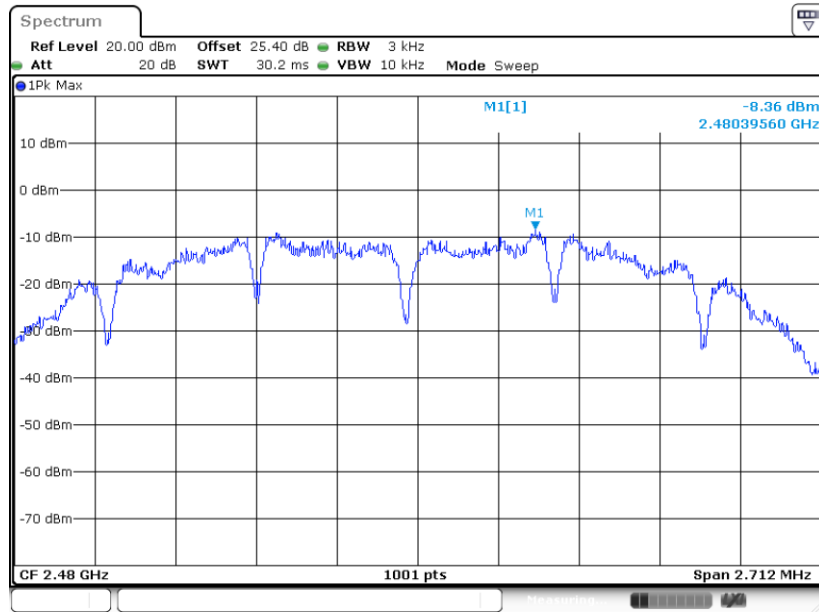

Date: 8.JUL.2020 22:48:08

3.4 Conducted Band Edges and Spurious Emission Measurement

3.4.1 Limit of Conducted Band Edges and Spurious Emission

All harmonics/spurious must be at least 30 dB down from the highest emission level within the authorized band.

3.4.2 Measuring Instruments

See list of measuring equipment of this test report.

3.4.3 Test Procedure

1. The testing follows the ANSI C63.10 Section 11.11.3 Emission level measurement.
2. The RF output of EUT was connected to the spectrum analyzer by RF cable and attenuator. The path loss was compensated to the results for each measurement.
3. Set to the maximum power setting and enable the EUT transmit continuously.
4. Set RBW = 100 kHz, VBW=300 kHz, Peak Detector. Unwanted Emissions measured in any 100 kHz bandwidth outside of the authorized frequency band shall be attenuated by at least 20 dB relative to the maximum in-band peak PSD level in 100 kHz when maximum peak conducted output power procedure is used. If the transmitter complies with the conducted power limits based on the use of RMS averaging over a time interval, the attenuation required under this paragraph shall be 30 dB instead of 20 dB.
5. Measure and record the results in the test report.
6. The RF fundamental frequency should be excluded against the limit line in the operating frequency band.

3.4.4 Test Setup

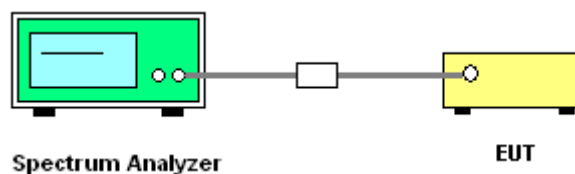



3.4.5 Test Result of Conducted Band Edges Plots

Low Band Edge Plot on Channel 11

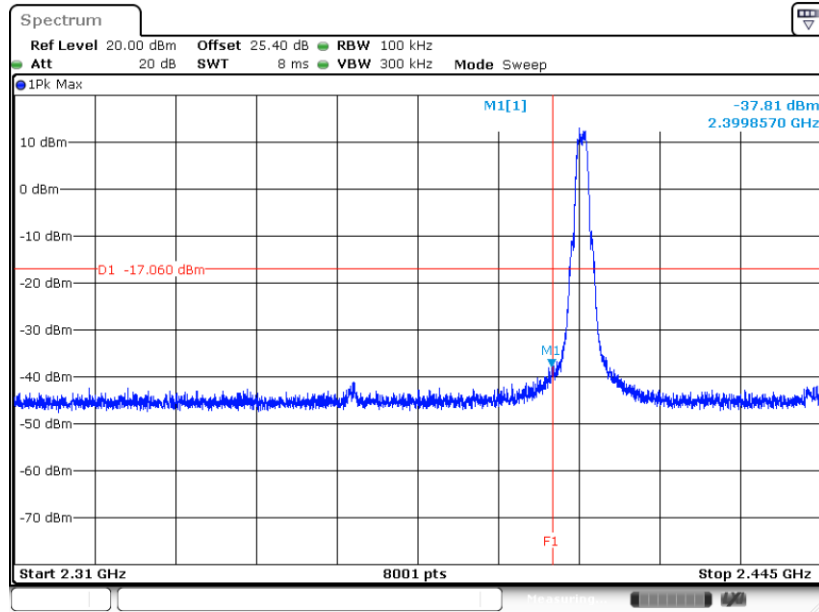

High Band Edge Plot on Channel 25

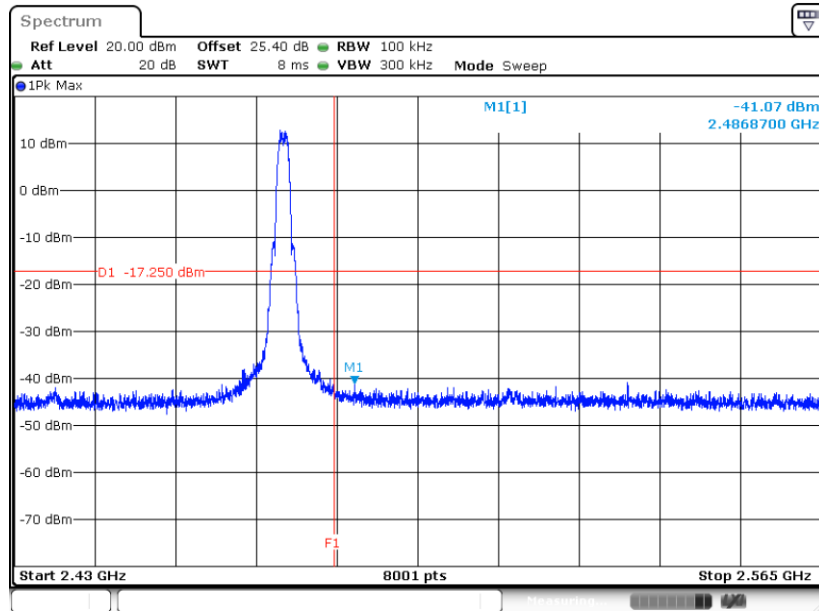



High Band Edge Plot on Channel 26

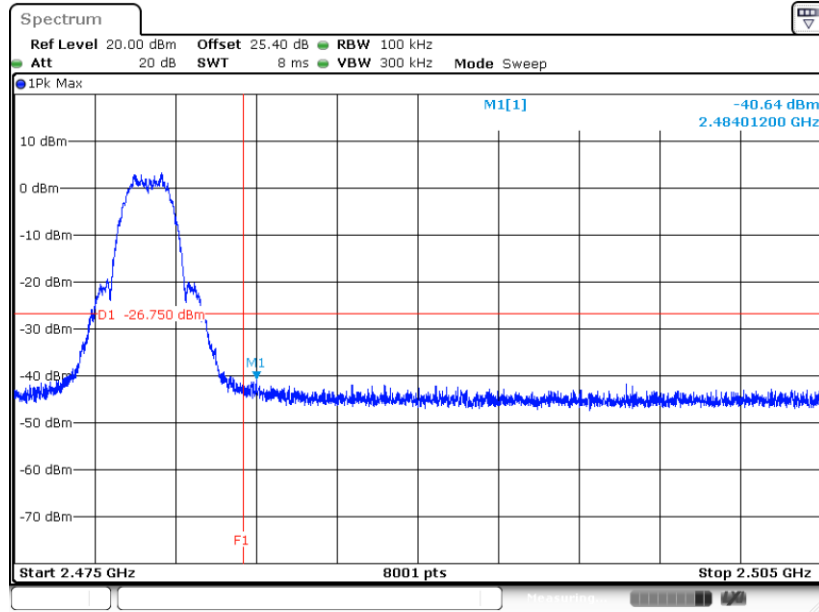

Date: 8.JUL.2020 22:49:43



3.4.6 Test Result of Conducted Spurious Emission Plots

Conducted Spurious Emission Plot on Zigbee Channel 11

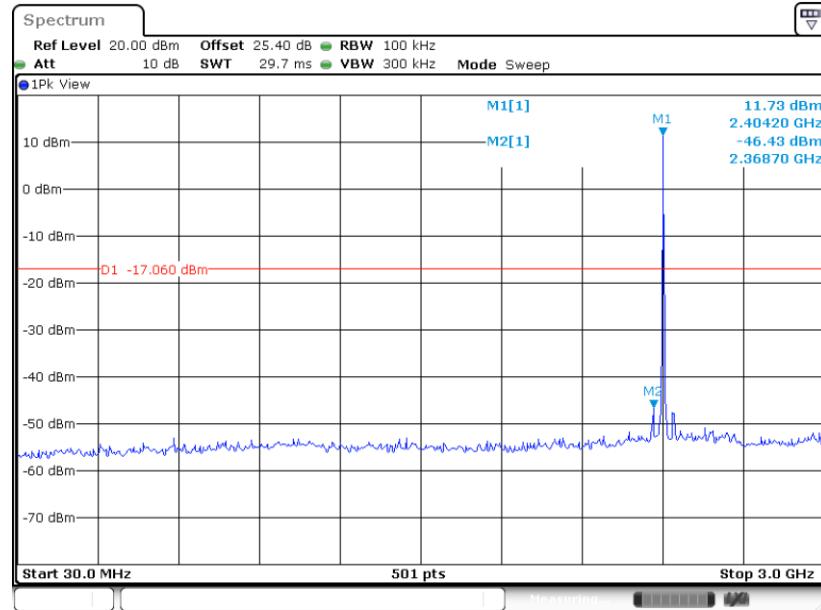

Conducted Spurious Emission Plot on Zigbee Channel 11

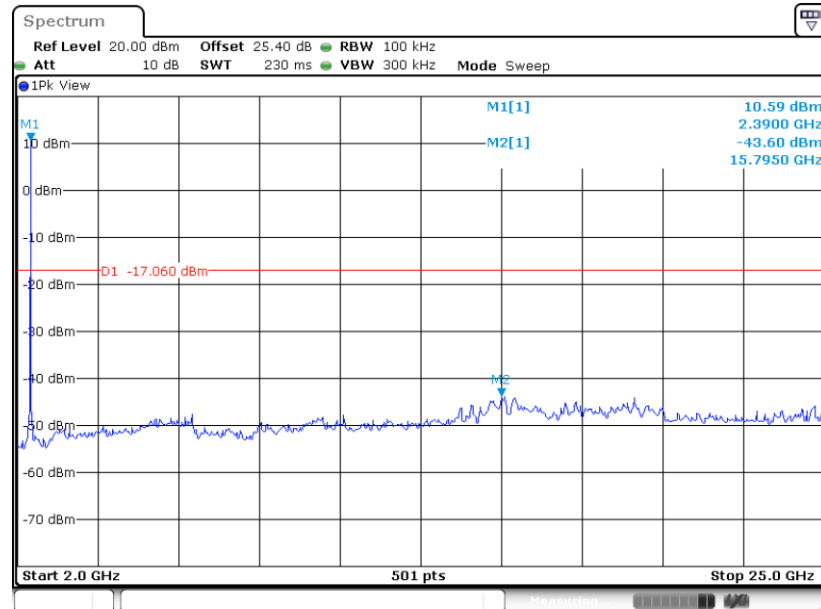



Conducted Spurious Emission Plot on Zigbee Channel 17

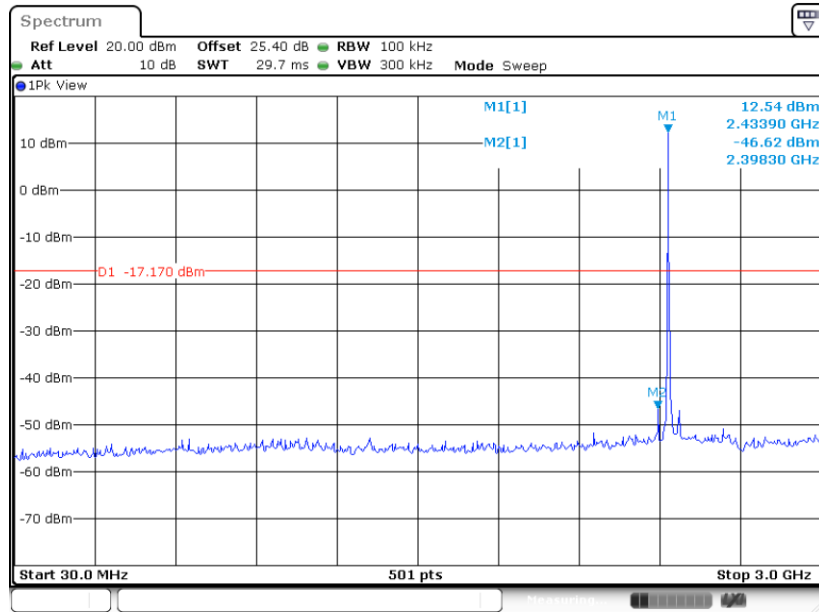

Conducted Spurious Emission Plot on Zigbee Channel 17

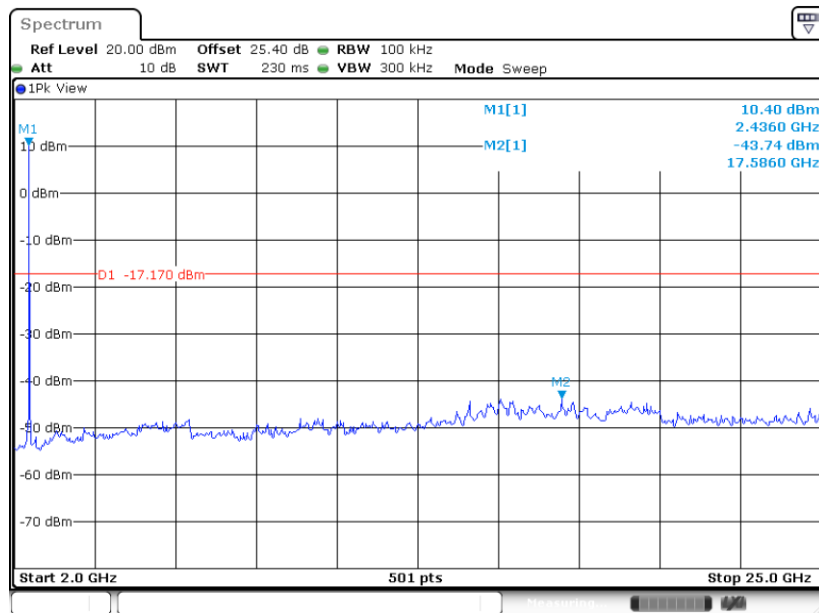



Conducted Spurious Emission Plot on Zigbee Channel 25

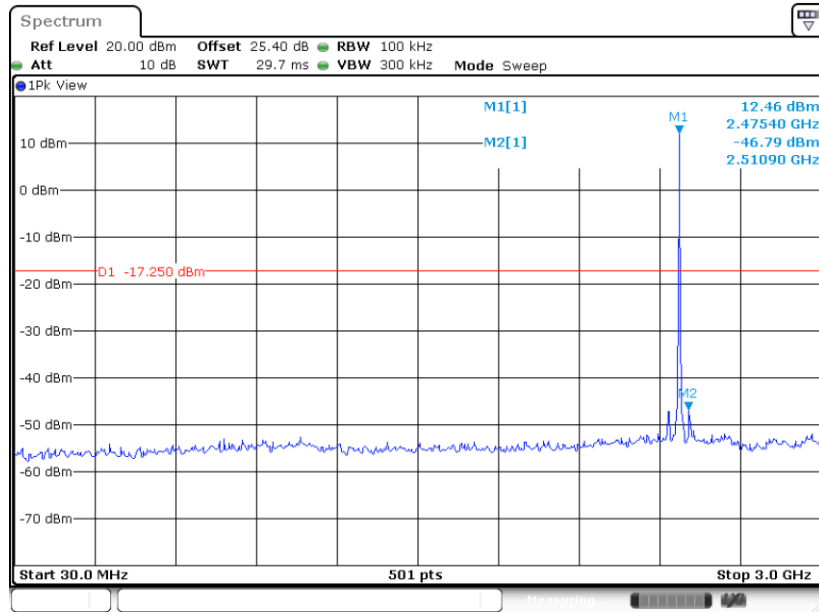

Date: 8.JUL.2020 22:45:03

Conducted Spurious Emission Plot on Zigbee Channel 25

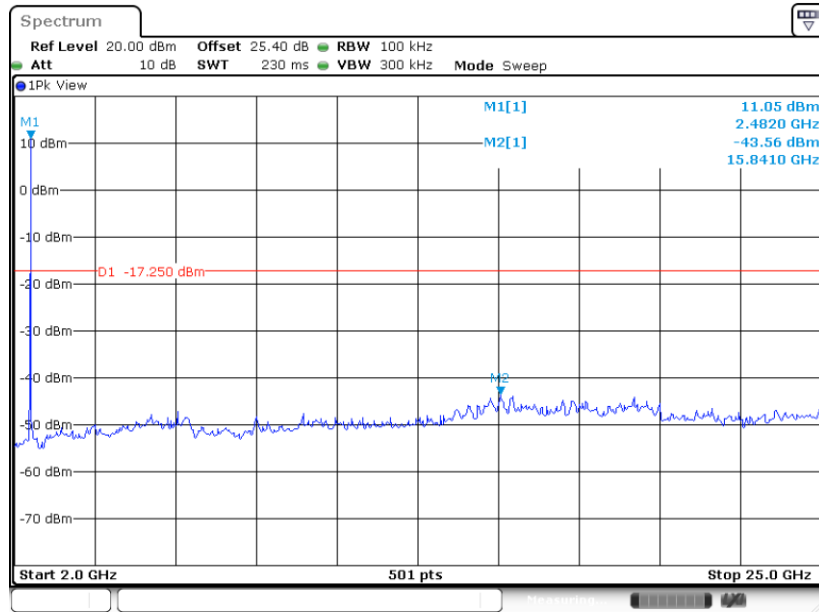

Date: 8.JUL.2020 22:45:16



Conducted Spurious Emission Plot on Zigbee Channel 26

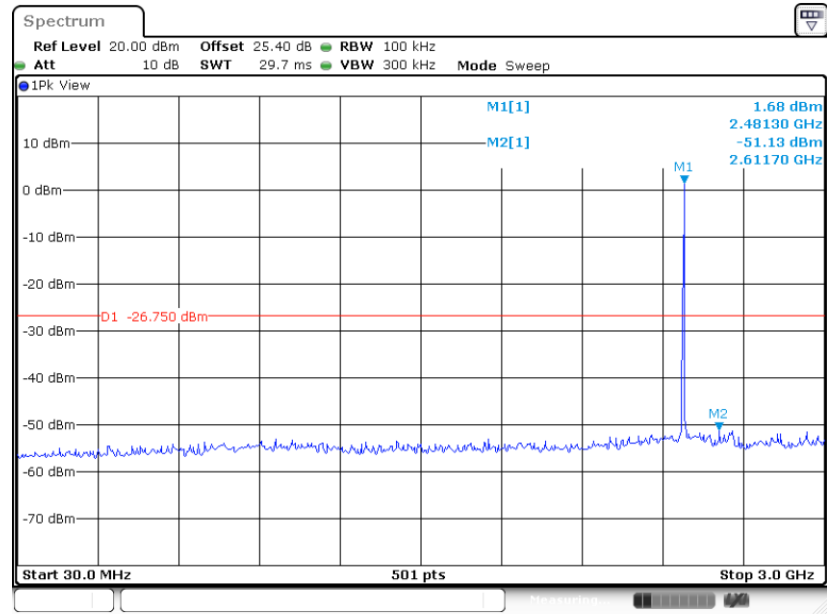

Date: 8.JUL.2020 22:50:59

Conducted Spurious Emission Plot on Zigbee Channel 26

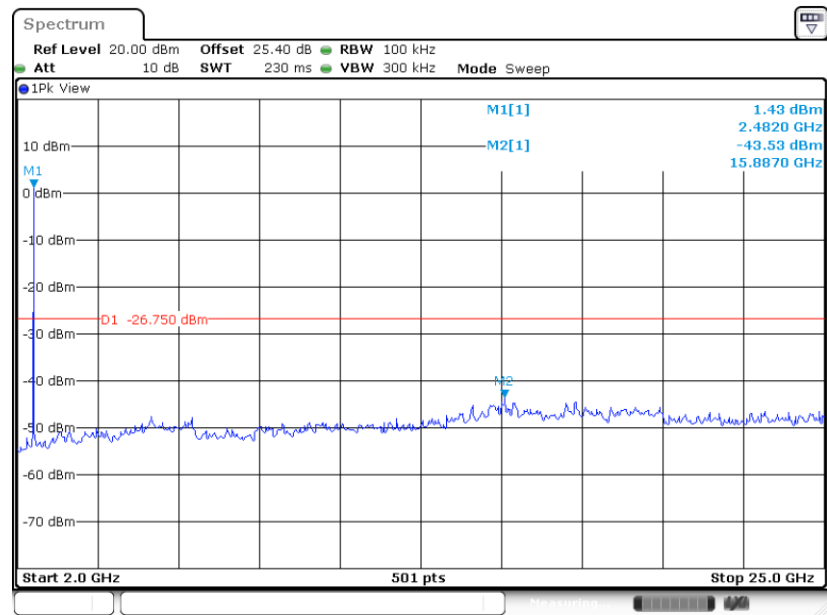

Date: 8.JUL.2020 22:51:10



3.5 Radiated Band Edges and Spurious Emission Measurement

3.5.1 Limit of Radiated Band Edges and Spurious Emission

In any 100 kHz bandwidth outside the intentional radiator frequency band, all harmonics/spurious must be at least 20 dB below the highest emission level within the authorized band. If the output power of this device was measured by spectrum analyzer, the attenuation under this paragraph shall be 30 dB instead of 20 dB. In addition, radiated emissions which fall in the restricted bands must also comply with the limits as below.

Frequency (MHz)	Field Strength (microvolts/meter)	Measurement Distance (meters)
0.009 – 0.490	2400/F(kHz)	300
0.490 – 1.705	24000/F(kHz)	30
1.705 – 30.0	30	30
30 – 88	100	3
88 – 216	150	3
216 - 960	200	3
Above 960	500	3

3.5.2 Measuring Instruments

See list of measuring equipment of this test report.

**3.5.3 Test Procedures**

1. The testing follows the ANSI C63.10 Section 11.12.1 Radiated emission measurements.
2. The EUT was arranged to its worst case and then tune the antenna tower (from 1 m to 4 m) and turntable (from 0 degree to 360 degrees) to find the maximum reading. A pre-amp and a high pass filter are used for the test in order to get better signal level.
3. The EUT was placed on a turntable with 0.8 meter for frequency below 1GHz and 1.5 meter for frequency above 1GHz respectively above ground.
4. The EUT was set 3 meters from the interference receiving antenna, which was mounted on the top of a variable height antenna tower.
5. Corrected Reading: Antenna Factor + Cable Loss + Read Level - Preamp Factor = Level
6. For testing below 1GHz, if the emission level of the EUT in peak mode was 3 dB lower than the limit specified, then peak values of EUT will be reported, otherwise, the emissions will be repeated one by one using the CISPR quasi-peak method and reported.
7. For testing above 1GHz, the emission level of the EUT in peak mode was 20dB lower than average limit (that means the emission level in average mode also complies with the limit in average mode), then peak values of EUT will be reported, otherwise, the emissions will be measured in average mode again and reported.
8. Use the following spectrum analyzer settings:
 - (1) Span shall wide enough to fully capture the emission being measured;
 - (2) Set RBW=100 kHz for $f < 1$ GHz; $VBW \geq RBW$; Sweep = auto; Detector function = peak; Trace = max hold;
 - (3) Set RBW = 1 MHz, VBW= 3MHz for $f \geq 1$ GHz for peak measurement.
For average measurement:
 - $VBW = 10$ Hz, when duty cycle is no less than 98 percent.
 - $VBW \geq 1/T$, when duty cycle is less than 98 percent where T is the minimum transmission duration over which the transmitter is on and is transmitting at its maximum power control level for the tested mode of operation.

3.5.4 Test Setup

For radiated emissions below 30MHz

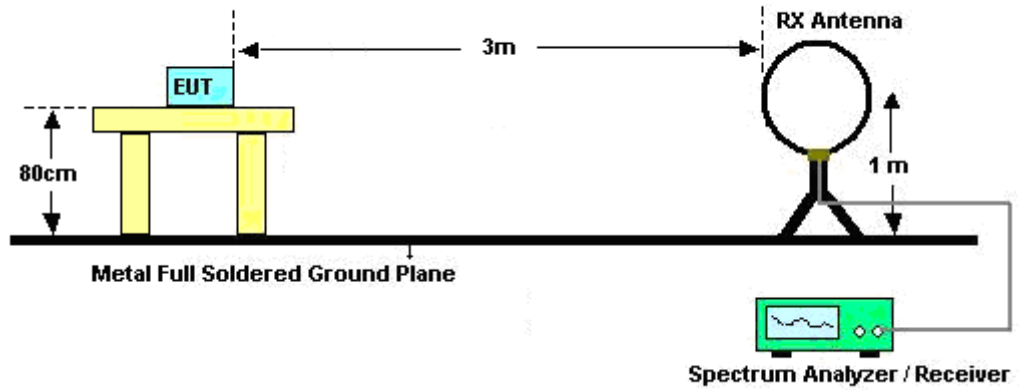

For radiated emissions from 30MHz to 1GHz

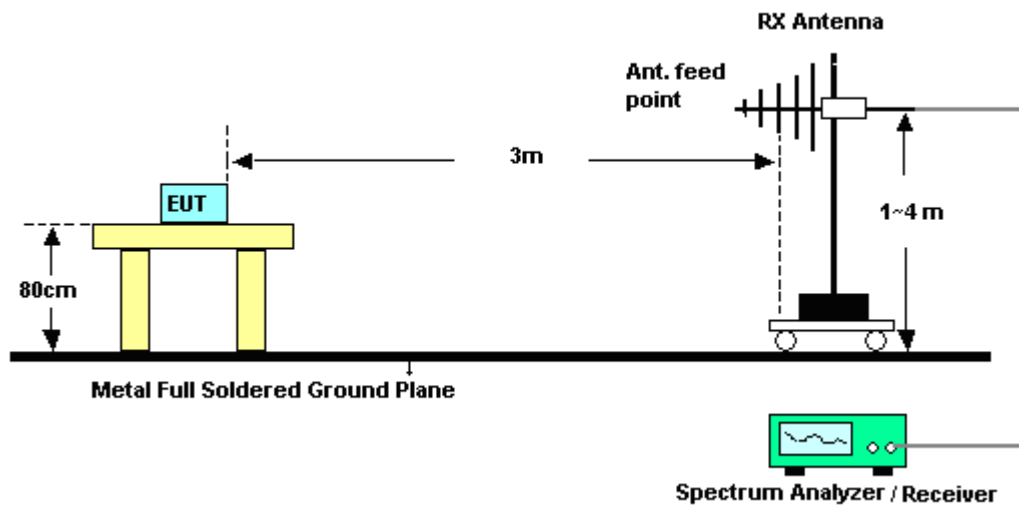

For radiated emissions above 1GHz

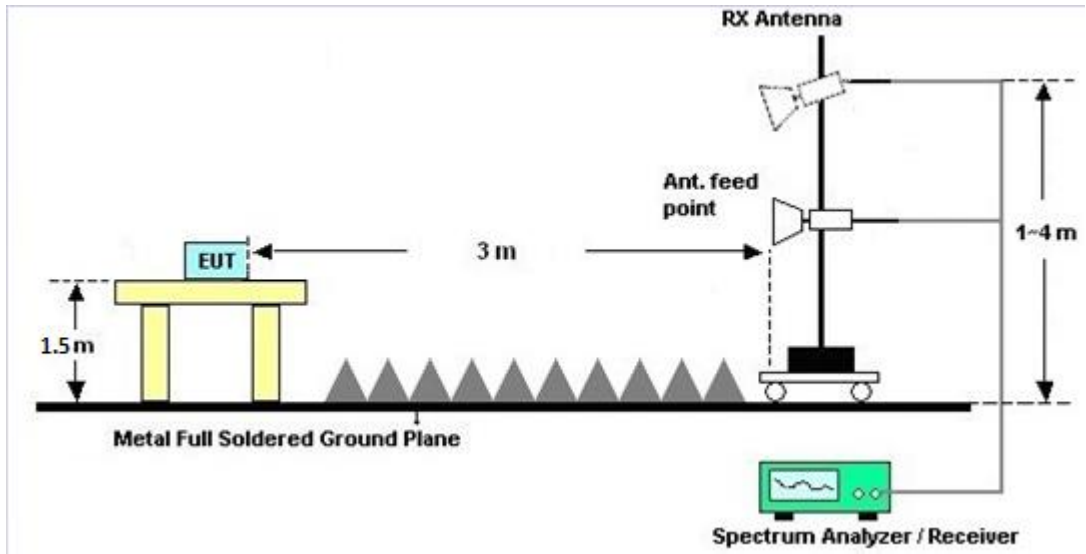

For radiated emissions above 18GHz

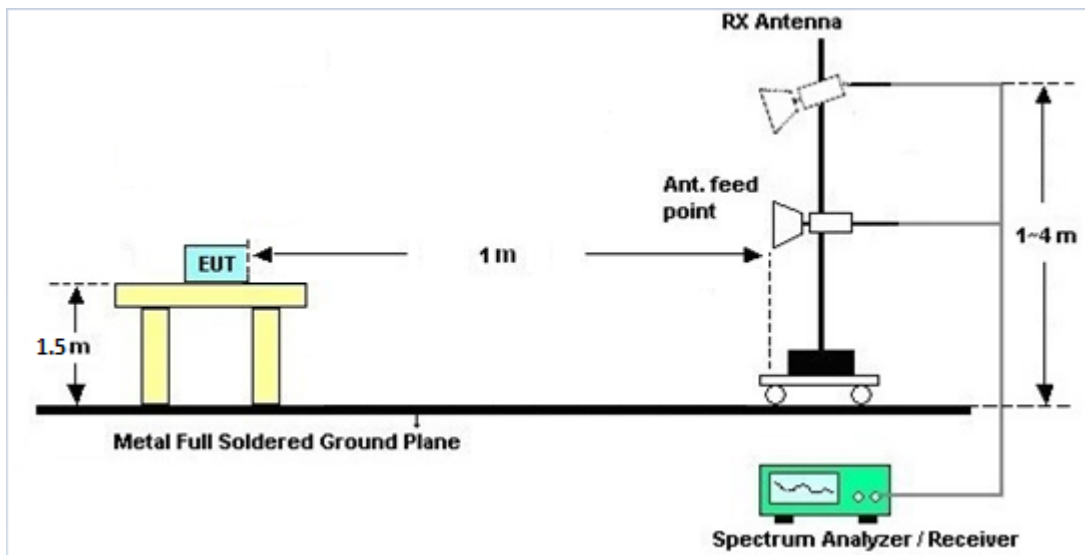



3.5.5 Test Results of Radiated Spurious Emissions (9 kHz ~ 30 MHz)

The low frequency, which started from 9 kHz to 30MHz, was pre-scanned and the result which was 20dB lower than the limit line was not reported.

There is a comparison data of both open-field test site and alternative test site - semi-Anechoic chamber according to 414788 D01 Radiated Test Site v01r01, and the result came out very similar.

3.5.6 Test Result of Radiated Spurious at Band Edges

Please refer to Appendix C and D.

3.5.7 Duty Cycle

Please refer to Appendix E.

3.5.8 Test Result of Radiated Spurious Emission (30MHz ~ 10th Harmonic)

Please refer to Appendix C and D.



3.6 AC Conducted Emission Measurement

3.6.1 Limit of AC Conducted Emission

For equipment that is designed to be connected to the public utility (AC) power line, the radio frequency voltage that is conducted back onto the AC power line on any frequency or frequencies within the band 150 kHz to 30 MHz shall not exceed the limits in the following table.

Frequency of emission (MHz)	Conducted limit (dB μ V)	
	Quasi-peak	Average
0.15-0.5	66 to 56*	56 to 46*
0.5-5	56	46
5-30	60	50

*Decreases with the logarithm of the frequency.

3.6.2 Measuring Instruments

See list of measuring equipment of this test report.

3.6.3 Test Procedures

1. The EUT was placed 0.4 meter from the conducting wall of the shielding room was kept at least 80 centimeters from any other grounded conducting surface.
2. Connect EUT to the power mains through a line impedance stabilization network (LISN).
3. All the support units are connecting to the other LISN.
4. The LISN provides 50 ohm coupling impedance for the measuring instrument.
5. The FCC states that a 50 ohm, 50 microhenry LISN should be used.
6. Both sides of AC line were checked for maximum conducted interference.
7. The frequency range from 150 kHz to 30 MHz was searched.
8. Set the test-receiver system to Peak Detect Function and specified bandwidth (IF Bandwidth = 9kHz) with Maximum Hold Mode. Then measurement is also conducted by Average Detector and Quasi-Peak Detector Function respectively.

3.6.4 Test Setup



3.6.5 Test Result of AC Conducted Emission

Please refer to Appendix B.



3.7 Antenna Requirements

3.7.1 Standard Applicable

If directional gain of transmitting antennas is greater than 6dBi, the power shall be reduced by the same level in dB comparing to gain minus 6dBi. The use of a permanently attached antenna or of an antenna that uses a unique coupling to the intentional radiator shall be considered sufficient to comply with the rule.

3.7.2 Antenna Anti-Replacement Construction

An embedded-in antenna design is used.

3.7.3 Antenna Gain

The antenna peak gain of EUT is less than 6 dBi. Therefore, it is not necessary to reduce maximum peak output power limit.



4 List of Measuring Equipment

Instrument	Manufacturer	Model No.	Serial No.	Characteristics	Calibration Date	Test Date	Due Date	Remark
Loop Antenna	Rohde & Schwarz	HFH2-Z2	100488	9 kHz~30 MHz	Jan. 09, 2020	May 21, 2020~ Jun. 18, 2020	Jan. 08, 2021	Radiation (03CH16-HY)
Bilog Antenna	TESEQ	CBL6111D&008 02N1D01N-06	47020&06	30MHz to 1GHz	Oct. 12, 2019	May 21, 2020~ Jun. 18, 2020	Oct. 11, 2020	Radiation (03CH16-HY)
Horn Antenna	SCHWARZBE CK	BBHA 9120 D	9120D-152 2	1G~18GHz	Sep. 19, 2019	May 21, 2020~ Jun. 18, 2020	Sep. 18, 2020	Radiation (03CH16-HY)
SHF-EHF Horn Antenna	SCHWARZBE CK	BBHA 9170	BBHA9170 980	18GHz~40GHz	Jan. 10, 2020	May 21, 2020~ Jun. 18, 2020	Jan. 09, 2021	Radiation (03CH16-HY)
Amplifier	SONOMA	310N	371607	9kHz~1G	Oct. 01, 2019	May 21, 2020~ Jun. 18, 2020	Sep. 30, 2020	Radiation (03CH16-HY)
Preamplifier	Jet-Power	JPA0118-55-303	171000180 0055006	1GHz~18GHz	May 07, 2020	May 21, 2020~ Jun. 18, 2020	May 06, 2021	Radiation (03CH16-HY)
Preamplifier	EMEC	EM18G40G	060715	18GHz ~40GHz	Dec. 13, 2019	May 21, 2020~ Jun. 18, 2020	Dec. 12, 2020	Radiation (03CH16-HY)
Preamplifier	Keysight	83017A	MY532702 64	1GHz~26.5GHz	Dec. 11, 2019	May 21, 2020~ Jun. 18, 2020	Dec. 10, 2020	Radiation (03CH16-HY)
EMI Test Receiver	Keysight	N9038A(MXE)	MY572901 11	3Hz~26.5GHz	Dec. 05, 2019	May 21, 2020~ Jun. 18, 2020	Dec. 04, 2020	Radiation (03CH16-HY)
RF Cable	HUBER + SUHNER	SUCOFLEX 104	MY11680/ 4PE	NA	Aug. 30, 2019	May 21, 2020~ Jun. 18, 2020	Aug. 29, 2020	Radiation (03CH16-HY)
RF Cable	HUBER + SUHNER	SUCOFLEX 104	MY11688/ 4PE	NA	Aug. 30, 2019	May 21, 2020~ Jun. 18, 2020	Aug. 29, 2020	Radiation (03CH16-HY)
RF Cable	HUBER + SUHNER	SUCOFLEX 102	EC-A5-300 -5757	NA	Aug. 30, 2019	May 21, 2020~ Jun. 18, 2020	Aug. 29, 2020	Radiation (03CH16-HY)
Software	Audix	E3 6.2009-8-24	RK-001136	N/A	N/A	May 21, 2020~ Jun. 18, 2020	N/A	Radiation (03CH16-HY)
AC Power Source	ChainTek	APC-1000W	N/A	N/A	N/A	Jun. 22, 2020~ Jul. 08, 2020	N/A	Conduction (CO05-HY)
EMI Test Receiver	Rohde & Schwarz	ESR3	102388	9kHz~3.6GHz	Nov. 15, 2019	Jun. 22, 2020~ Jul. 08, 2020	Nov. 14, 2020	Conduction (CO05-HY)
Hygrometer	Testo	608-H1	34913912	N/A	Nov. 07, 2019	Jun. 22, 2020~ Jul. 08, 2020	Nov. 06, 2020	Conduction (CO05-HY)
LISN	Rohde & Schwarz	ENV216	100081	9kHz~30MHz	Nov. 15, 2019	Jun. 22, 2020~ Jul. 08, 2020	Nov. 14, 2020	Conduction (CO05-HY)
Software	Rohde & Schwarz	EMC32 V10.30	N/A	N/A	N/A	Jun. 22, 2020~ Jul. 08, 2020	N/A	Conduction (CO05-HY)
LF Cable	HUBER + SUHNER	RG-214/U	LF01	N/A	Jan. 02, 2020	Jun. 22, 2020~ Jul. 08, 2020	Jan. 01, 2021	Conduction (CO05-HY)
Pulse Limiter	Rohde & Schwarz	ESH3-Z2	100851	N/A	Jan. 02, 2020	Jun. 22, 2020~ Jul. 08, 2020	Jan. 01, 2021	Conduction (CO05-HY)



Instrument	Manufacturer	Model No.	Serial No.	Characteristics	Calibration Date	Test Date	Due Date	Remark
Hygrometer	Testo	608-H1	34893241	N/A	Mar. 02, 2020	May 30, 2020~ Jul. 08, 2020	Mar. 01, 2021	Conducted (TH05-HY)
Power Sensor	DARE	RPR3006W	16I00054S NO10	10MHz~6GHz	Dec. 23, 2019	May 30, 2020~ Jul. 08, 2020	Dec. 22, 2020	Conducted (TH05-HY)
Signal Analyzer	Rohde & Schwarz	FSV40	101566	10Hz~40GHz	Jul. 15, 2019	May 30, 2020~ Jul. 08, 2020	Jul. 14, 2020	Conducted (TH05-HY)
Spectrum Analyzer	Rohde & Schwarz	FSP40	100055	9kHz~40GHz	Dec. 30, 2019	May 30, 2020~ Jul. 08, 2020	Dec. 29, 2020	Conducted (TH05-HY)
Switch Box & RF Cable	Burgeon	ETF-058	EC130048 4	N/A	Aug. 22, 2019	May 30, 2020~ Jul. 08, 2020	Aug. 21, 2020	Conducted (TH05-HY)



5 Uncertainty of Evaluation

Uncertainty of Conducted Emission Measurement (150 kHz ~ 30 MHz)

Measuring Uncertainty for a Level of Confidence of 95% ($U = 2Uc(y)$)	2.3
---	-----

Uncertainty of Radiated Emission Measurement (30 MHz ~ 1000 MHz)

Measuring Uncertainty for a Level of Confidence of 95% ($U = 2Uc(y)$)	4.9
---	-----

Uncertainty of Radiated Emission Measurement (1000 MHz ~ 18000 MHz)

Measuring Uncertainty for a Level of Confidence of 95% ($U = 2Uc(y)$)	6.7
---	-----

Uncertainty of Radiated Emission Measurement (18000 MHz ~ 40000 MHz)

Measuring Uncertainty for a Level of Confidence of 95% ($U = 2Uc(y)$)	3.9
---	-----

Appendix A. Test Result of Conducted Test Items

Test Engineer:	Hank Hsu	Temperature:	23.1~24.1	°C
Test Date:	2020/5/30~2020/7/8	Relative Humidity:	51~53.8	%

TEST RESULTS DATA **6dB and 99% Occupied Bandwidth**

Mod.	Data Rate	NTX	CH.	Freq. (MHz)	99% Occupied BW (MHz)	6dB BW (MHz)	6dB BW Limit (MHz)	Pass/Fail
Zigbee	250K	1	11	2405	2.308	1.823	0.50	Pass
Zigbee	250K	1	17	2435	2.313	1.813	0.50	Pass
Zigbee	250K	1	25	2475	2.303	1.818	0.50	Pass
Zigbee	250K	1	26	2480	2.313	1.808	0.50	Pass

TEST RESULTS DATA **Average Power Table**

Mod.	Data Rate	NTX	CH.	Freq. (MHz)	Average Conducted Power (dBm)	Conducted Power Limit (dBm)	DG (dBi)	EIRP Power (dBm)	EIRP Power Limit (dBm)	Pass /Fail
Zigbee	250K	1	11	2405	16.40	30.00	2.15	18.55	36.00	Pass
Zigbee	250K	1	17	2435	16.50	30.00	2.15	18.65	36.00	Pass
Zigbee	250K	1	25	2475	16.40	30.00	2.15	18.55	36.00	Pass
Zigbee	250K	1	26	2480	7.20	30.00	2.15	9.35	36.00	Pass

TEST RESULTS DATA **Peak Power Density**

Mod.	Data Rate	NTX	CH.	Freq. (MHz)	Peak PSD (dBm /100kHz)	Peak PSD (dBm /3kHz)	DG (dBi)	Peak PSD Limit (dBm /3kHz)	Pass/Fail
Zigbee	250K	1	11	2405	12.94	1.35	2.15	8.00	Pass
Zigbee	250K	1	17	2435	12.83	1.13	2.15	8.00	Pass
Zigbee	250K	1	25	2475	12.75	1.14	2.15	8.00	Pass
Zigbee	250K	1	26	2480	3.25	-8.36	2.15	8.00	Pass

Note: PSD (dBm/ 100kHz) is a reference level used for Conducted Band Edges and Conducted Spurious Emission 30dBc limit.



Appendix B. AC Conducted Emission Test Results

Test Engineer :	Tom Lee	Temperature :	23~25°C
		Relative Humidity :	42~50%

EUT Information

Report NO : 020110-01
 Test Mode : Mode 2
 Test Voltage : 120Vac/60Hz
 Phase : Line

Full Spectrum

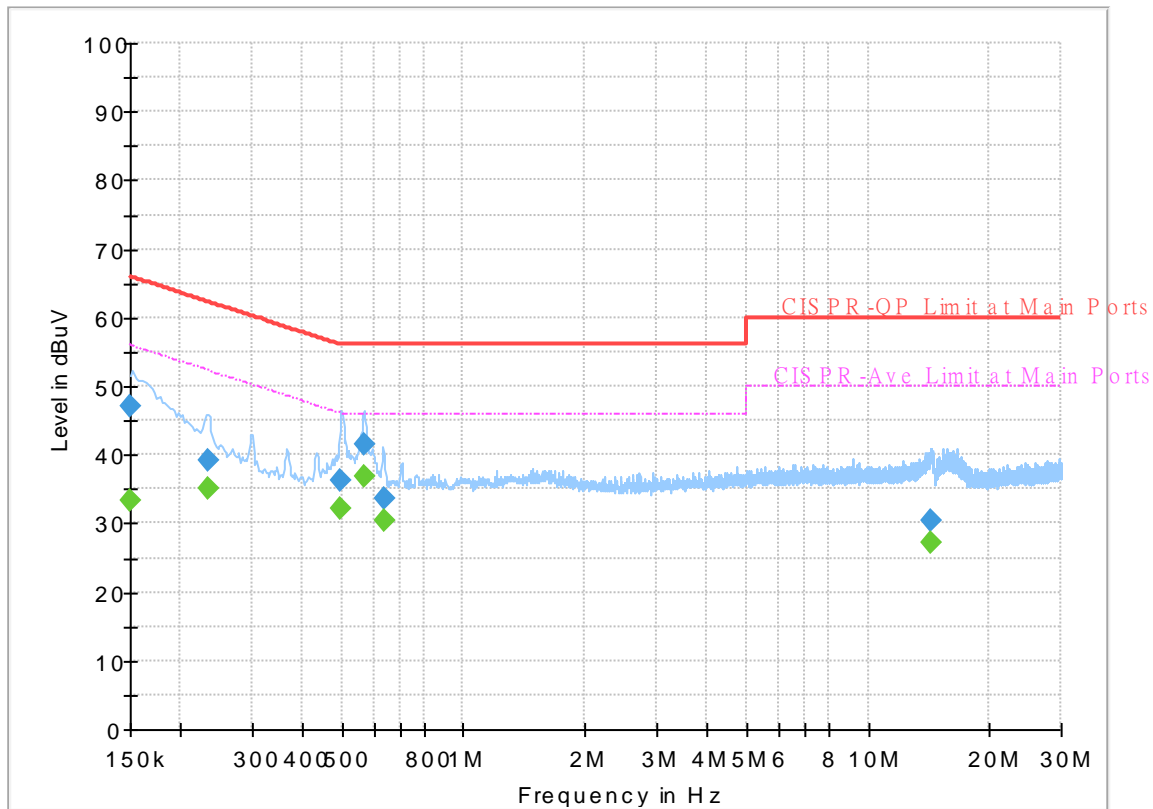

Final_Result

Frequency (MHz)	QuasiPeak (dBuV)	CAverage (dBuV)	Limit (dBuV)	Margin (dB)	Line	Filter	Corr. (dB)
0.150000	---	33.20	56.00	22.80	L1	OFF	19.6
0.150000	46.93	---	66.00	19.07	L1	OFF	19.6
0.233430	---	35.04	52.33	17.29	L1	OFF	19.6
0.233430	39.08	---	62.33	23.25	L1	OFF	19.6
0.498750	---	32.13	46.02	13.89	L1	OFF	19.6
0.498750	36.16	---	56.02	19.86	L1	OFF	19.6
0.566520	---	36.70	46.00	9.30	L1	OFF	19.6
0.566520	41.46	---	56.00	14.54	L1	OFF	19.6
0.634560	---	30.36	46.00	15.64	L1	OFF	19.6
0.634560	33.49	---	56.00	22.51	L1	OFF	19.6
14.364510	---	27.10	50.00	22.90	L1	OFF	20.2
14.364510	30.34	---	60.00	29.66	L1	OFF	20.2

EUT Information

Report NO : 020110-01
 Test Mode : Mode 2
 Test Voltage : 120Vac/60Hz
 Phase : Neutral

Full Spectrum

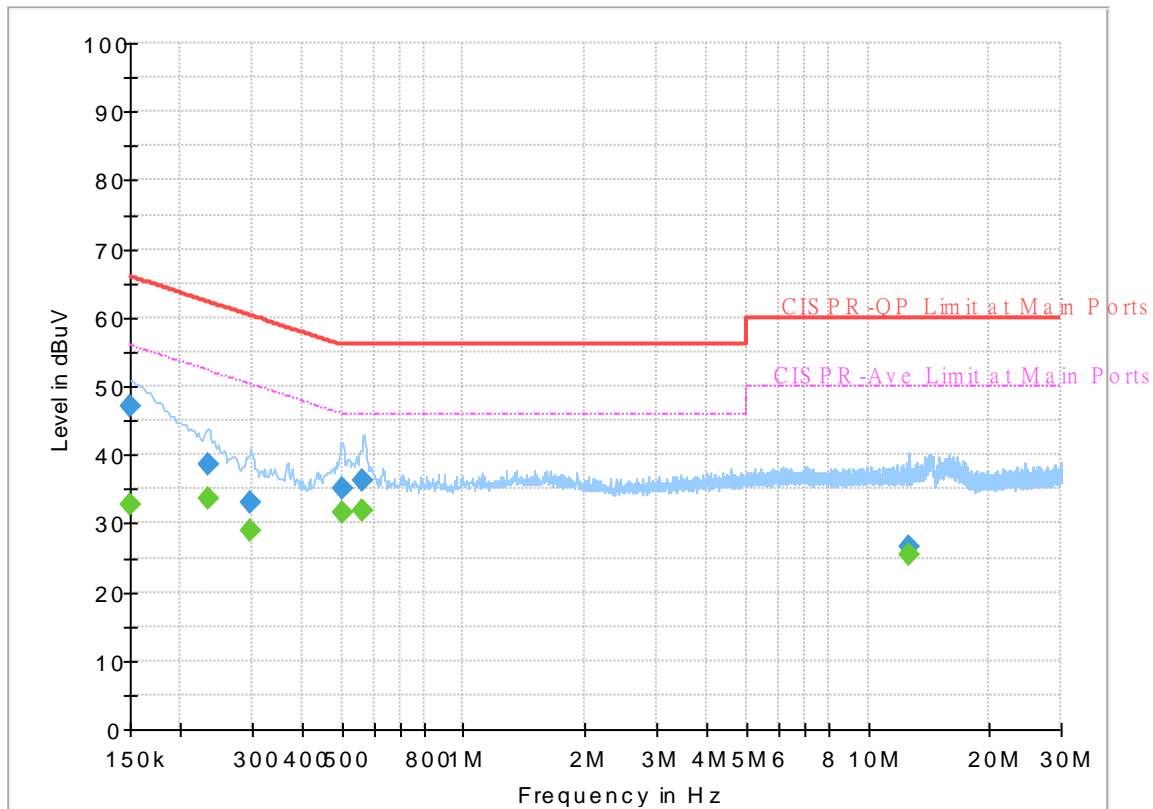

Final Result

Frequency (MHz)	QuasiPeak (dBuV)	CAverage (dBuV)	Limit (dBuV)	Margin (dB)	Line	Filter	Corr. (dB)
0.150000	---	32.84	56.00	23.16	N	OFF	19.6
0.150000	47.00	---	66.00	19.00	N	OFF	19.6
0.233250	---	33.74	52.33	18.59	N	OFF	19.5
0.233250	38.70	---	62.33	23.63	N	OFF	19.5
0.296070	---	28.81	50.35	21.54	N	OFF	19.5
0.296070	33.04	---	60.35	27.31	N	OFF	19.5
0.502620	---	31.54	46.00	14.46	N	OFF	19.5
0.502620	35.19	---	56.00	20.81	N	OFF	19.5
0.561750	---	31.73	46.00	14.27	N	OFF	19.5
0.561750	36.33	---	56.00	19.67	N	OFF	19.5
12.601500	---	25.30	50.00	24.70	N	OFF	19.9
12.601500	26.59	---	60.00	33.41	N	OFF	19.9



Appendix C. Radiated Spurious Emission

Test Engineer :	Karl Hou, Andy Yang and CR Liao	Temperature :	20~25°C
		Relative Humidity :	50~60%

2.4GHz 2400~2483.5MHz

ZIGBEE (Band Edge @ 3m)

Zigbee	Note	Frequency (MHz)	Level (dBμV/m)	Over Limit (dB)	Limit Line (dBμV/m)	Read Level (dBμV)	Antenna Factor (dB/m)	Path Loss (dB)	Preamp Factor (dB)	Ant Pos (cm)	Table Pos (deg)	Peak Avg. (P/A)	Pol. (H/V)
ZIGBEE CH11 2405MHz		2367.225	60.24	-13.76	74	44.22	27.73	18.06	29.77	305	250	P	H
		2366.49	53.12	-0.88	54	37.11	27.73	18.05	29.77	305	250	A	H
	*	2405	117.01	-	-	101.08	27.6	18.12	29.79	305	250	P	H
	*	2405	114.81	-	-	98.88	27.6	18.12	29.79	305	250	A	H
		2366.07	60.54	-13.46	74	44.52	27.74	18.05	29.77	123	336	P	V
		2366.49	53.15	-0.85	54	37.14	27.73	18.05	29.77	123	336	A	V
	*	2405	116.77	-	-	100.84	27.6	18.12	29.79	123	336	P	V
	*	2405	114.58	-	-	98.65	27.6	18.12	29.79	123	336	A	V
ZIGBEE CH17 2435MHz		2384.9	56.59	-17.41	74	40.62	27.66	18.09	29.78	262	253	P	H
		2357.32	44.2	-9.8	54	28.16	27.77	18.04	29.77	262	253	A	H
	*	2435	116.45	-	-	100.48	27.6	18.17	29.8	262	253	P	H
	*	2435	114.31	-	-	98.34	27.6	18.17	29.8	262	253	A	H
		2486.91	56.67	-17.33	74	40.71	27.53	18.25	29.82	262	253	P	H
		2493.49	44.31	-9.69	54	28.37	27.51	18.26	29.83	262	253	A	H
		2319.38	56.72	-17.28	74	40.57	27.92	17.98	29.75	144	338	P	V
		2364.74	44.2	-9.8	54	28.18	27.74	18.05	29.77	144	338	A	V
	*	2435	116.56	-	-	100.59	27.6	18.17	29.8	144	338	P	V
	*	2435	114.42	-	-	98.45	27.6	18.17	29.8	144	338	A	V
		2497.62	56.46	-17.54	74	40.52	27.5	18.27	29.83	144	338	P	V
		2491.53	44.37	-9.63	54	28.42	27.52	18.26	29.83	144	338	A	V



ZIGBEE CH25 2475MHz	*	2475	115.39	-	-	99.43	27.55	18.23	29.82	257	254	P	H
	*	2475	113.25	-	-	97.29	27.55	18.23	29.82	257	254	A	H
		2483.6	62.23	-11.77	74	46.28	27.53	18.24	29.82	257	254	P	H
		2483.52	52.9	-1.1	54	36.95	27.53	18.24	29.82	257	254	A	H
	*	2475	115.79	-	-	99.83	27.55	18.23	29.82	150	331	P	V
	*	2475	113.56	-	-	97.6	27.55	18.23	29.82	150	331	A	V
		2483.52	62.37	-11.63	74	46.42	27.53	18.24	29.82	150	331	P	V
		2483.52	53.24	-0.76	54	37.29	27.53	18.24	29.82	150	331	A	V
ZIGBEE CH26 2480MHz	*	2480	103.22	-	-	87.26	27.54	18.24	29.82	288	258	P	H
	*	2480	101.05	-	-	85.09	27.54	18.24	29.82	288	258	A	H
		2483.6	61.22	-12.78	74	45.27	27.53	18.24	29.82	288	258	P	H
		2483.52	51.9	-2.1	54	35.95	27.53	18.24	29.82	288	258	A	H
	*	2480	103.72	-	-	87.76	27.54	18.24	29.82	128	338	P	V
	*	2480	101.5	-	-	85.54	27.54	18.24	29.82	128	338	A	V
		2483.52	61.68	-12.32	74	45.73	27.53	18.24	29.82	128	338	P	V
		2483.52	52.3	-1.7	54	36.35	27.53	18.24	29.82	128	338	A	V
Remark	1. No other spurious found. 2. All results are PASS against Peak and Average limit line.												



2.4GHz 2400~2483.5MHz
ZIGBEE (Harmonic @ 3m)

Zigbee	Note	Frequency	Level	Over Limit	Limit Line	Read Level	Antenna Factor	Path Loss	Preamp Factor	Ant Pos	Table Pos	Peak Avg.	Pol.
		(MHz)	(dBμV/m)	(dB)	(dBμV/m)	(dBμV)	(dB/m)	(dB)	(dB)	(cm)	(deg)	(P/A)	(H/V)
ZIGBEE CH11 2405MHz		4810	42.26	-31.74	74	57.82	31.12	12.41	59.09	100	0	P	H
		4810	43.95	-30.05	74	59.51	31.12	12.41	59.09	100	0	P	V
ZIGBEE CH17 2435MHz		4870	41.53	-32.47	74	57.06	31.12	12.47	59.12	100	0	P	H
		7305	49.51	-24.49	74	55.98	36.42	15.68	58.57	100	0	P	H
		4870	43.36	-30.64	74	58.89	31.12	12.47	59.12	100	0	P	V
		7305	51.89	-22.11	74	58.36	36.42	15.68	58.57	100	199	P	V
		7305	43.81	-10.19	54	50.28	36.42	15.68	58.57	100	199	A	V
ZIGBEE CH25 2475MHz		4950	41.41	-32.59	74	56.83	31.2	12.55	59.17	100	0	P	H
		7425	47.42	-26.58	74	53.54	36.55	15.73	58.4	100	0	P	H
		4950	43.13	-30.87	74	58.55	31.2	12.55	59.17	100	0	P	V
		7425	49.81	-24.19	74	55.93	36.55	15.73	58.4	100	0	P	V
ZIGBEE CH26 2480MHz		4960	40.75	-33.25	74	56.11	31.26	12.56	59.18	100	0	P	H
		7440	47.83	-26.17	74	53.85	36.58	15.78	58.38	100	0	P	H
		4960	40.67	-33.33	74	56.03	31.26	12.56	59.18	100	0	P	V
		7440	47.13	-26.87	74	53.15	36.58	15.78	58.38	100	0	P	V
Remark	1. No other spurious found. 2. All results are PASS against Peak and Average limit line.												



2.4GHz ZIGBEE (SHF)

Zigbee	Note	Frequency (MHz)	Level (dBμV/m)	Over Limit (dB)	Limit Line (dBμV/m)	Read Level (dBμV)	Antenna Factor (dB/m)	Path Loss (dB)	Preamp Factor (dB)	Ant Pos (cm)	Table Pos (deg)	Peak Avg. (P/A)	Pol. (H/V)
2.4GHz ZIGBEE SHF		20303	37.57	-36.43	74	41.67	37.92	11.6	53.62	150	0	P	H
		23705	40.3	-33.7	74	40.6	39.99	13.01	53.3	150	0	P	V
Remark	1. No other spurious found. 2. All results are PASS against limit line.												



Emission below 1GHz

2.4GHz ZIGBEE (LF)

Zigbee	Note	Frequency	Level	Over	Limit	Read	Antenna	Path	Preamp	Ant	Table	Peak	Pol.
		(MHz)	(dBμV/m)	(dB)	Limit	Level	Factor	Loss	Factor	Pos	Pos	Avg.	
					Line	(dBμV)	(dB/m)	(dB)	(dB)	(cm)	(deg)	(P/A)	(H/V)
2.4GHz ZIGBEE LF		71.71	29.59	-10.41	40	48.19	12.31	1.44	32.35	-	-	P	H
		112.45	35.16	-8.34	43.5	48.61	16.99	1.82	32.26	100	0	P	H
		576.11	27.87	-18.13	46	29.93	25.79	4.11	31.96	-	-	P	H
		679.9	29.23	-16.77	46	30.43	26.43	4.47	32.1	-	-	P	H
		894.27	37.41	-8.59	46	35.24	28.98	5.14	31.95	-	-	P	H
		957.32	34.33	-11.67	46	29.33	30.91	5.33	31.24	-	-	P	H
		42.61	33.38	-6.62	40	46.69	17.95	1.08	32.34	100	0	P	V
		112.45	36.19	-7.31	43.5	49.64	16.99	1.82	32.26	-	-	P	V
		185.2	26.3	-17.2	43.5	41.47	14.78	2.36	32.31	-	-	P	V
		622.67	27.72	-18.28	46	29.55	25.86	4.28	31.97	-	-	P	V
	903	38.03	-7.97	46	35.69	29.06	5.16	31.88	-	-	P	V	
	952.47	33.71	-12.29	46	28.89	30.8	5.32	31.3	-	-	P	V	
Remark	1. No other spurious found. 2. All results are PASS against limit line.												



Note symbol

*	Fundamental Frequency which can be ignored. However, the level of any unwanted emissions shall not exceed the level of the fundamental frequency.
!	Test result is over limit line.
P/A	Peak or Average
H/V	Horizontal or Vertical



A calculation example for radiated spurious emission is shown as below:

Zigbee	Note	Frequency	Level	Over	Limit	Read	Antenna	Path	Preamp	Ant	Table	Peak	Pol.
		(MHz)	(dBμV/m)	(dB)	Line	Level	Factor	Loss	Factor	Pos	Pos	Avg.	
					(dBμV/m)	(dBμV)	(dB/m)	(dB)	(dB)	(cm)	(deg)	(P/A)	(H/V)
ZIGBEE		2390	55.45	-18.55	74	54.51	32.22	4.58	35.86	103	308	P	H
CH 11		2390	43.54	-10.46	54	42.6	32.22	4.58	35.86	103	308	A	H
2405MHz													

1. Path Loss(dB) = Cable loss(dB) + Filter loss(dB) + Attenuator loss(dB)
2. Level(dBμV/m) =
Antenna Factor(dB/m) + Path Loss(dB) + Read Level(dBμV) - Preamp Factor(dB)
3. Over Limit(dB) = Level(dBμV/m) – Limit Line(dBμV/m)

For Peak Limit @ 2390MHz:

1. Level(dBμV/m)
= Antenna Factor(dB/m) + Path Loss(dB) + Read Level(dBμV) - Preamp Factor(dB)
= 32.22(dB/m) + 4.58(dB) + 54.51(dBμV) – 35.86 (dB)
= 55.45 (dBμV/m)
2. Over Limit(dB)
= Level(dBμV/m) – Limit Line(dBμV/m)
= 55.45(dBμV/m) – 74(dBμV/m)
= -18.55(dB)

For Average Limit @ 2390MHz:

1. Level(dBμV/m)
= Antenna Factor(dB/m) + Path Loss(dB) + Read Level(dBμV) - Preamp Factor(dB)
= 32.22(dB/m) + 4.58(dB) + 42.6(dBμV) – 35.86 (dB)
= 43.54 (dBμV/m)
2. Over Limit(dB)
= Level(dBμV/m) – Limit Line(dBμV/m)
= 43.54(dBμV/m) – 54(dBμV/m)
= -10.46(dB)

Both peak and average measured complies with the limit line, so test result is “PASS”.



Appendix D. Radiated Spurious Emission Plots

Test Engineer :	Karl Hou, Andy Yang and CR Liao	Temperature :	20~25°C
		Relative Humidity :	50~60%

Note symbol

-L	Low channel location
-R	High channel location



2.4GHz 2400~2483.5MHz
ZIGBEE (Band Edge @ 3m)

Zigbee	2.4GHz 2400~2483.5MHz Band Edge @ 3m	
	ZIGBEE_CH11 2405MHz	
	Horizontal	Fundamental
Peak	<p>Date: 2020-05-21</p> <p>Site : 03CH16-14Y Condition : PEAK_BE_74 3m 91200_1522 HORIZONTAL RBW:1000.000kHz VBW:3000.000kHz SWT:Auto Detector : Peak Project : 020110-01</p>	<p>Date: 2020-05-21</p> <p>Site : 03CH16-14Y Condition : PEAK_74 3m 91200_1522 HORIZONTAL RBW:1000.000kHz VBW:3000.000kHz SWT:Auto Detector : Peak Project : 020110-01</p>
Avg.	<p>Date: 2020-05-21</p> <p>Site : 03CH16-14Y Condition : AVG_BE_54 3m 91200_1522 HORIZONTAL RBW:1000.000kHz VBW:0.010kHz SWT:Auto Detector : Peak Project : 020110-01</p>	<p>Date: 2020-05-21</p> <p>Site : 03CH16-14Y Condition : AVG_54 3m 91200_1522 HORIZONTAL RBW:1000.000kHz VBW:0.010kHz SWT:Auto Detector : Peak Project : 020110-01</p>

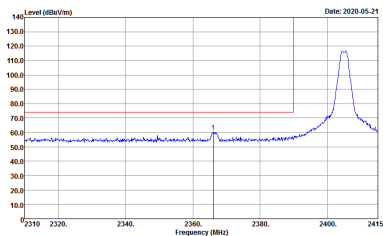
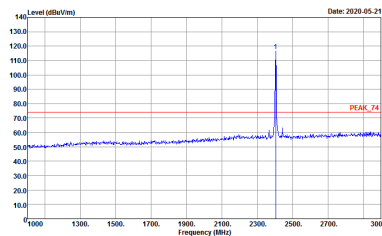
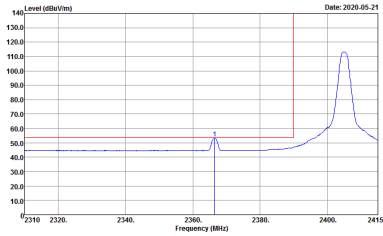
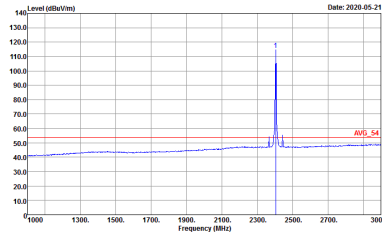

Zigbee	2.4GHz 2400~2483.5MHz Band Edge @ 3m	
	ZIGBEE_CH11 2405MHz	
	Vertical	Fundamental
<p>Peak</p>	 <p>Site : 03CH16-HY Condition : PEAK_BE_74 3m 91200_1522 VERTICAL RBW:1000.000KHz VBW:3000.000KHz SWT:Auto Detector : Peak Project : 020110-01</p>	 <p>Site : 03CH16-HY Condition : PEAK_74 3m 91200_1522 VERTICAL RBW:1000.000KHz VBW:3000.000KHz SWT:Auto Detector : Peak Project : 020110-01</p>
<p>Avg.</p>	 <p>Site : 03CH16-HY Condition : AVG_BE_54 3m 91200_1522 VERTICAL RBW:1000.000KHz VBW:0.010KHz SWT:Auto Detector : Peak Project : 020110-01</p>	 <p>Site : 03CH16-HY Condition : AVG_54 3m 91200_1522 VERTICAL RBW:1000.000KHz VBW:0.010KHz SWT:Auto Detector : Peak Project : 020110-01</p>

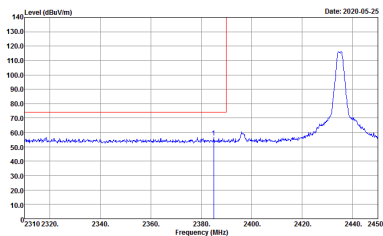
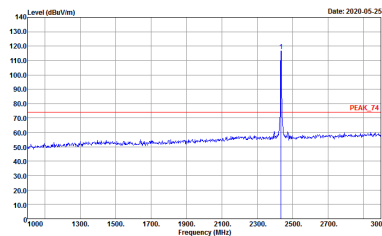
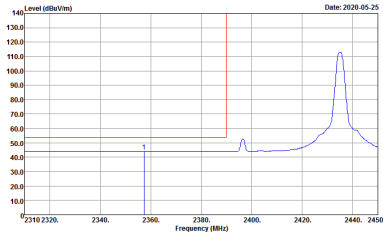
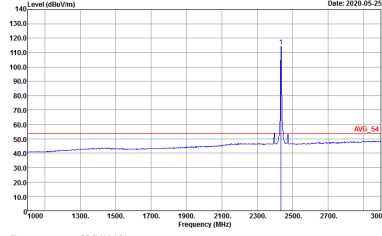

Zigbee	2.4GHz 2400~2483.5MHz Band Edge @ 3m	
	ZIGBEE_CH17 2435MHz	
	Horizontal	Fundamental
Peak	 <p>Site : 03CH16-HY Condition : PEAK_BE_74 3m 91200_1522 HORIZONTAL RBW:1000.000kHz VBW:3000.000kHz SWT:Auto Detector : Peak Project : 020110-01</p>	 <p>Site : 03CH16-HY Condition : PEAK_74 3m 91200_1522 HORIZONTAL RBW:1000.000kHz VBW:3000.000kHz SWT:Auto Detector : Peak Project : 020110-01</p>
Avg.	 <p>Site : 03CH16-HY Condition : AVG_BE_54 3m 91200_1522 HORIZONTAL RBW:1000.000kHz VBW:0.010kHz SWT:Auto Detector : Peak Project : 020110-01</p>	 <p>Site : 03CH16-HY Condition : AVG_54 3m 91200_1522 HORIZONTAL RBW:1000.000kHz VBW:0.010kHz SWT:Auto Detector : Peak Project : 020110-01</p>

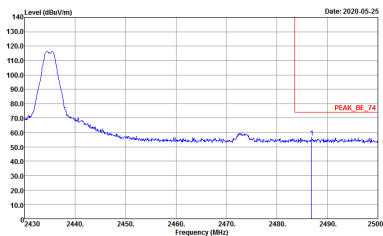
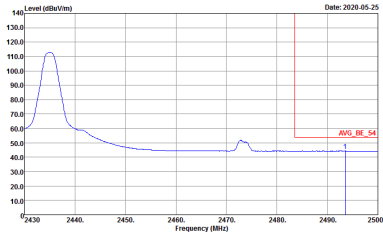

Zigbee	2.4GHz 2400~2483.5MHz Band Edge @ 3m	
	ZIGBEE_CH17 2435MHz	
	Horizontal	Fundamental
<p>Peak</p>	 <p> Site : 03CH16-HY Condition : PEAK_BE_74 3m 91200_1522 HORIZONTAL RBW:1000.000KHz VBW:3000.000KHz SWT:Auto Detector : Peak Project : 020110-01 </p>	<p>Left blank</p>
<p>Avg.</p>	 <p> Site : 03CH16-HY Condition : AVG_BE_54 3m 91200_1522 HORIZONTAL RBW:1000.000KHz VBW:0.010KHz SWT:Auto Detector : Peak Project : 020110-01 </p>	<p>Left blank</p>

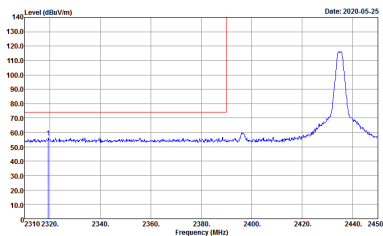
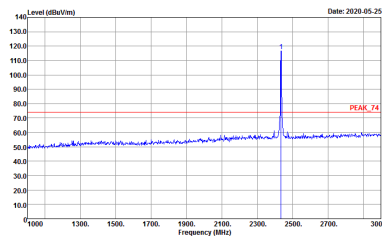
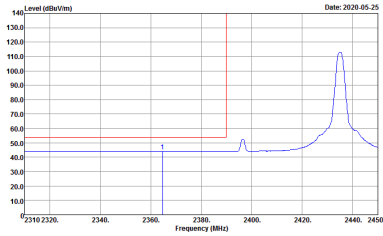
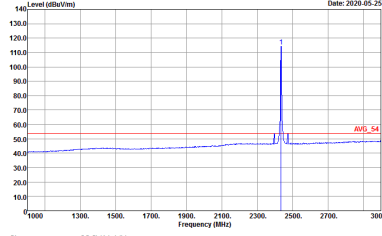

Zigbee	2.4GHz 2400~2483.5MHz Band Edge @ 3m	
	ZIGBEE_CH17 2435MHz	
	Vertical	Fundamental
Peak	 <p>Site : 03CH16-HY Condition : PEAK_BE_74 3m 91200_1522 VERTICAL RBW:1000.000kHz VBW:3000.000kHz SWT:Auto Detector : Peak Project : 020110-01</p>	 <p>Site : 03CH16-HY Condition : PEAK_74 3m 91200_1522 VERTICAL RBW:1000.000kHz VBW:3000.000kHz SWT:Auto Detector : Peak Project : 020110-01</p>
Avg.	 <p>Site : 03CH16-HY Condition : AVG_BE_54 3m 91200_1522 VERTICAL RBW:1000.000kHz VBW:0.010kHz SWT:Auto Detector : Peak Project : 020110-01</p>	 <p>Site : 03CH16-HY Condition : AVG_54 3m 91200_1522 VERTICAL RBW:1000.000kHz VBW:0.010kHz SWT:Auto Detector : Peak Project : 020110-01</p>

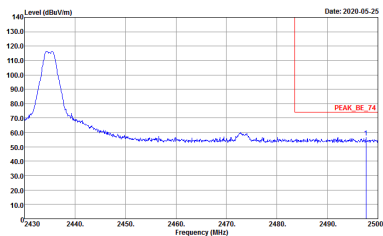
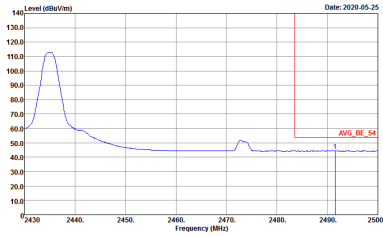

Zigbee	2.4GHz 2400~2483.5MHz Band Edge @ 3m	
	ZIGBEE_CH17 2435MHz	
	Vertical	Fundamental
<p>Peak</p>	 <p> Site : 03CH16-HY Condition : PEAK_BE_74 3m 91200_1522 VERTICAL Detector : Peak Project : 020110-01 </p>	<p>Left blank</p>
<p>Avg.</p>	 <p> Site : 03CH16-HY Condition : AVG_BE_54 3m 91200_1522 VERTICAL Detector : Peak Project : 020110-01 </p>	<p>Left lank</p>

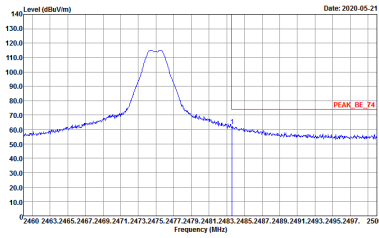
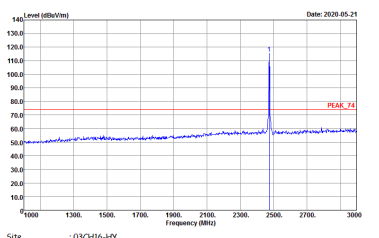
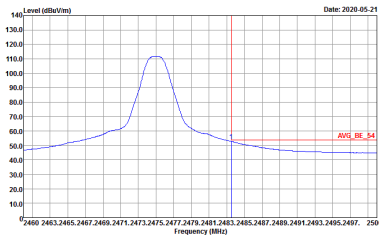
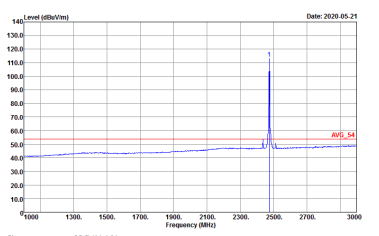

Zigbee	2.4GHz 2400~2483.5MHz Band Edge @ 3m	
ZIGBEE_CH25 2475MHz		
Horizontal		Fundamental
Peak	 <p>Site : 03CH16-HY Condition : PEAK_BE_74 3m 91200_1522 HORIZONTAL : RBW:10000000Hz VBW:30000000Hz SWT:Auto</p>	 <p>Site : 03CH16-HY Condition : PEAK_74 3m 91200_1522 HORIZONTAL : RBW:10000000Hz VBW:30000000Hz SWT:Auto</p>
Avg.	 <p>Site : 03CH16-HY Condition : AVG_BE_54 3m 91200_1522 HORIZONTAL : RBW:10000000Hz VBW:01010KHz SWT:Auto</p>	 <p>Site : 03CH16-HY Condition : AVG_54 3m 91200_1522 HORIZONTAL : RBW:10000000Hz VBW:01010KHz SWT:Auto</p>

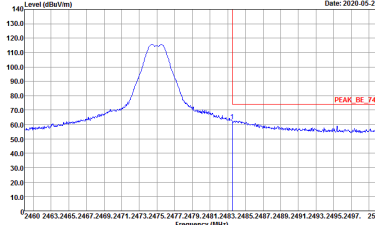
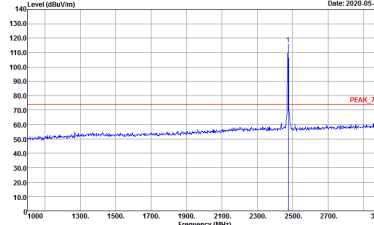
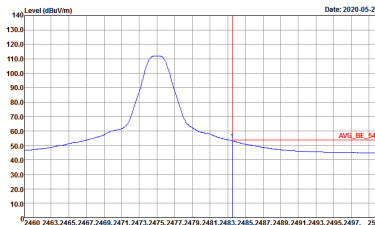
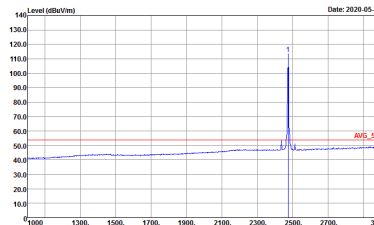

Zigbee	2.4GHz 2400~2483.5MHz Band Edge @ 3m	
	ZIGBEE_CH25 2475MHz	
	Vertical	Fundamental
Peak	 <p>Site : 03CH16-HY Condition : PEAK_BE_74 3m 91200_1522 VERTICAL : RBW:1000.000KHz VBW:3000.000KHz SWT:Auto</p>	 <p>Site : 03CH16-HY Condition : PEAK_74 3m 91200_1522 VERTICAL : RBW:1000.000KHz VBW:3000.000KHz SWT:Auto</p>
Avg.	 <p>Site : 03CH16-HY Condition : AVG_BE_54 3m 91200_1522 VERTICAL : RBW:1000.000KHz VBW:0.010KHz SWT:Auto</p>	 <p>Site : 03CH16-HY Condition : AVG_54 3m 91200_1522 VERTICAL : RBW:1000.000KHz VBW:0.010KHz SWT:Auto</p>

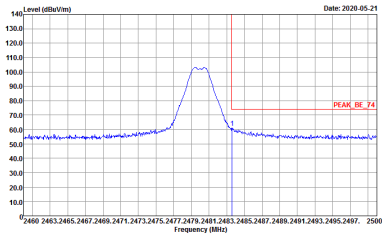
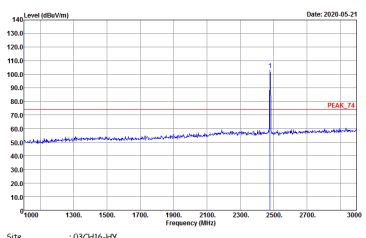
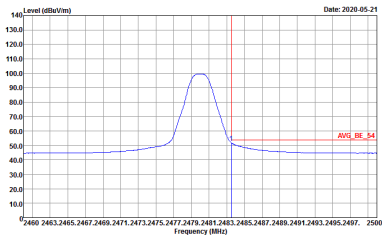
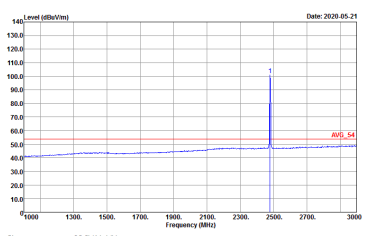

Zigbee	2.4GHz 2400~2483.5MHz Band Edge @ 3m	
ZIGBEE_CH26 2480MHz		
Horizontal		Fundamental
Peak	 <p>Date: 2020-05-21</p> <p>Site : 03CH16-HY Condition : PEAK_BE_74 3m 91200_1522 HORIZONTAL : RBW:10000000Hz VBW:30000000Hz SWT:Auto</p>	 <p>Date: 2020-05-21</p> <p>Site : 03CH16-HY Condition : PEAK_74 3m 91200_1522 HORIZONTAL : RBW:10000000Hz VBW:30000000Hz SWT:Auto</p>
Avg.	 <p>Date: 2020-05-21</p> <p>Site : 03CH16-HY Condition : AVG_BE_54 3m 91200_1522 HORIZONTAL : RBW:10000000Hz VBW:01000Hz SWT:Auto</p>	 <p>Date: 2020-05-21</p> <p>Site : 03CH16-HY Condition : AVG_54 3m 91200_1522 HORIZONTAL : RBW:10000000Hz VBW:01000Hz SWT:Auto</p>



Zigbee	2.4GHz 2400~2483.5MHz Band Edge @ 3m	
	ZIGBEE_CH26 2480MHz	
	Vertical	Fundamental
Peak	<p>Site : 03CH16-HY Condition : PEAK_BE_74 3m 91200_1522 VERTICAL : RBW:1000.000KHz VBW:3000.000KHz SWT:Auto</p>	<p>Site : 03CH16-HY Condition : PEAK_74 3m 91200_1522 VERTICAL : RBW:1000.000KHz VBW:3000.000KHz SWT:Auto</p>
Avg.	<p>Site : 03CH16-HY Condition : AVG_BE_54 3m 91200_1522 VERTICAL : RBW:1000.000KHz VBW:0.010KHz SWT:Auto</p>	<p>Site : 03CH16-HY Condition : AVG_54 3m 91200_1522 VERTICAL : RBW:1000.000KHz VBW:0.010KHz SWT:Auto</p>



2.4GHz 2400~2483.5MHz

ZIGBEE (Harmonic @ 3m)

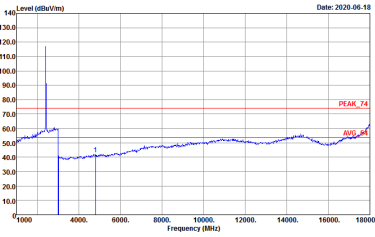
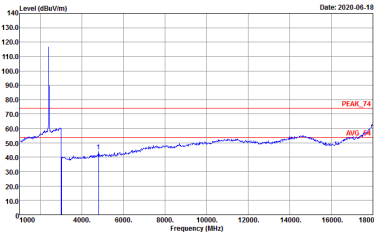
Zigbee	2.4GHz 2400~2483.5MHz Harmonic @ 3m	
	ZIGBEE_CH11 2405MHz	
	Horizontal	Vertical
<p>Peak</p> <p>Avg.</p>	 <p>Site : 03CH16-HY Condition : PEAK_74 3m 91200_1522 HORIZONTAL Detector : Peak Project : 020110-01</p>	 <p>Site : 03CH16-HY Condition : PEAK_74 3m 91200_1522 VERTICAL Detector : Peak Project : 020110-01</p>

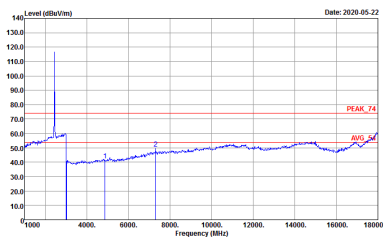
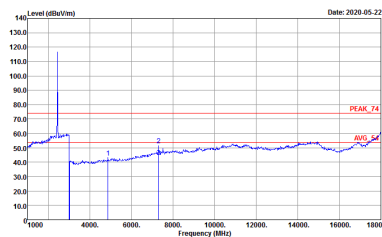

Zigbee	2.4GHz 2400~2483.5MHz Harmonic @ 3m	
	ZIGBEE_CH17 2435MHz	
	Horizontal	Vertical
<p>Peak</p> <p>Avg.</p>	 <p>Site : 03CH16-HY Condition : PEAK_74 3m 91200_1522 HORIZONTAL Detector : Peak Project : 020110-01</p>	 <p>Site : 03CH16-HY Condition : PEAK_74 3m 91200_1522 VERTICAL Detector : Peak Project : 020110-01</p>

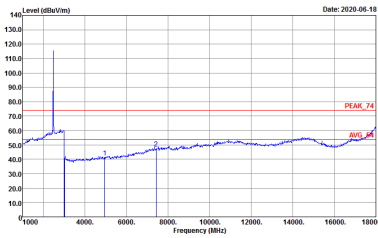
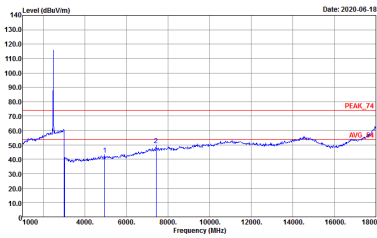

Zigbee	2.4GHz 2400~2483.5MHz Harmonic @ 3m	
	ZIGBEE_CH25 2475MHz	
	Horizontal	Vertical
<p>Peak</p> <p>Avg.</p>	 <p>Site : 03CH16-HY Condition : PEAK_74 3m 91200_1522 HORIZONTAL Detector : Peak</p>	 <p>Site : 03CH16-HY Condition : PEAK_74 3m 91200_1522 VERTICAL Detector : Peak</p>

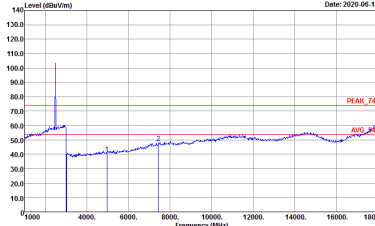
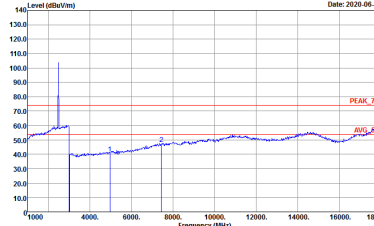

Zigbee	2.4GHz 2400~2483.5MHz Harmonic @ 3m	
	ZIGBEE_CH26 2480MHz	
	Horizontal	Vertical
<p>Peak</p> <p>Avg.</p>	 <p>Site : 03CH16-HY Condition : PEAK_74 3m 91200_1522 HORIZONTAL Detector : Peak</p>	 <p>Site : 03CH16-HY Condition : PEAK_74 3m 91200_1522 VERTICAL Detector : Peak</p>

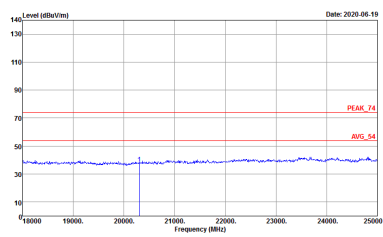
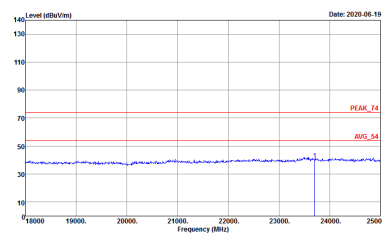

ZIGBEE (SHF)

Zigbee	2.4GHz 2400~2483.5MHz	
	ZIGBEE SHF	
	Horizontal	Vertical
Peak	 <p>Site : 03CH16-HY Condition : PEAK_74 1m SHF HORN BBHA9170584 HORIZONTA Detector : Peak Project : 020110-01</p>	 <p>Site : 03CH16-HY Condition : PEAK_74 1m SHF HORN BBHA9170584 VERTICAL Detector : Peak Project : 020110-01</p>



Emission below 1GHz

2.4GHz ZIGBEE (LF)

Zigbee	2.4GHz 2400~2483.5MHz	
	ZIGBEE LF	
	Horizontal	Vertical
QP / Peak	<p>Site : 03CH16-HY Condition : QP 3m BIL06_47020606 HORIZONTAL Detector : Peak Project : 020110-01</p>	<p>Site : 03CH16-HY Condition : QP 3m BIL06_47020606 VERTICAL Detector : Peak Project : 020110-01</p>



Appendix E. Duty Cycle Plots

Band	Duty Cycle(%)	T(us)	1/T(kHz)	VBW Setting	Duty Factor(dB)
Zigbee	100	-	-	10Hz	0.00

Zigbee

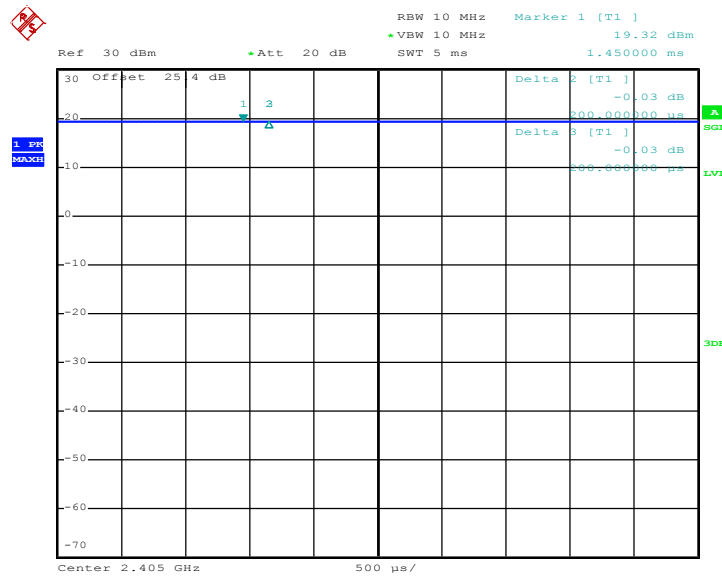

Date: 30.MAY.2020 03:09:27

————THE END————