

# Test Report

FCC ID: 2AUOA-BMCA124A

Date of issue: Oct. 09, 2019

Report number: MTi19072222-4E1

---

Sample description: Wireless Charging Mount With Smart Auto Clamping

---

Model(s): BMCA124A, BMCA125A, BMCA126A, SPH1907

---

Applicant: Dongguan City Fuze Electronic Co., Ltd.

---

Address: No.2, Dongyiheng Road, Huanshidong Road, Tangxia Town,  
Dongguan City, Guangdong Province, China

---

Date of test: Aug. 12, 2019 – Sept. 23, 2019

---

**Shenzhen Microtest Co., Ltd.**  
<http://www.mtitest.com>

## Table of Contents

<b>1</b>	<b>GENERAL INFORMATION .....</b>	<b>4</b>
1.1	FEATURE OF EQUIPMENT UNDER TEST (EUT).....	4
1.2	TEST MODE .....	4
1.3	EUT TEST SETUP.....	5
1.4	ANCILLARY EQUIPMENT .....	5
1.5	MEASUREMENT UNCERTAINTY .....	5
<b>2</b>	<b>SUMMARY OF TEST RESULT .....</b>	<b>6</b>
2.1	OPERATION CHANNEL LIST .....	6
2.2	TEST CHANNEL .....	6
<b>3</b>	<b>TEST FACILITIES AND ACCREDITATIONS .....</b>	<b>7</b>
3.1	TEST LABORATORY .....	7
3.2	ENVIRONMENTAL CONDITIONS .....	7
3.3	MEASUREMENT UNCERTAINTY.....	7
3.4	TEST SOFTWARE .....	7
<b>4</b>	<b>LIST OF TEST EQUIPMENT .....</b>	<b>8</b>
<b>5</b>	<b>TEST RESULTS.....</b>	<b>9</b>
5.1	ANTENNA REQUIREMENT .....	9
5.1.1	<i>Standard requirement</i> .....	9
5.1.2	<i>EUT Antenna</i> .....	9
5.2	CONDUCTED EMISSION .....	10
5.2.1	<i>Limits</i> .....	10
5.2.2	<i>Test Procedures</i> .....	10
5.2.3	<i>Test Setup</i> .....	10
5.2.4	<i>Test Result</i> .....	10
5.3	RADIATED EMISSION.....	15
5.3.1	<i>Limits</i> .....	15
5.3.2	<i>Test Procedures</i> .....	16
5.3.3	<i>Test Setup</i> .....	17
5.3.4	<i>Test Result</i> .....	17
5.4	OCCUPIED BANDWIDTH.....	22
5.4.1	<i>Test method</i> .....	22
5.4.2	<i>Test result</i> .....	22
<b>6</b>	<b>PHOTOGRAPHS OF THE TEST SETUP.....</b>	<b>23</b>
<b>7</b>	<b>PHOTOGRAPHS OF THE EUT.....</b>	<b>25</b>

## Test Result Certification

Applicant's name: Dongguan City Fuze Electronic Co., Ltd.

Address: No.2, Dongyiheng Road, Huanshidong Road, Tangxia Town, Dongguan City, Guangdong Province, China

Manufacture's name: Dongguan City Fuze Electronic Co., Ltd.

Address: No.2, Dongyiheng Road, Huanshidong Road, Tangxia Town, Dongguan City, Guangdong Province, China

Product name: Wireless Charging Mount With Smart Auto Clamping

Trademark: Fuze, MPOW, SIXfeeling

Model name: BMCA124A, BMCA125A, BMCA126A, SPH1907

Standards: FCC Part 15C

Test procedure: ANSI C63.10-2013

This device described above has been tested by Shenzhen Microtest Co., Ltd. and the test results show that the equipment under test (EUT) is in compliance with the FCC requirements. And it is applicable only to the tested sample identified in the report.

Tested by:



Demi Mu

Sept. 23, 2019

Reviewed by:



Blue Zheng

Oct. 09, 2019

Approved by:



Smith Chen

Oct. 09, 2019

## 1 GENERAL INFORMATION

### 1.1 Feature of equipment under test (EUT)

Product name:	Wireless Charging Mount With Smart Auto Clamping
Model name:	BMCA124A, BMCA125A, BMCA126A, SPH1907
Model difference:	All the model are the same circuit and RF module, except the model No. and appearance silk screen.
Operation frequency:	115–205 kHz
Modulation type:	Load modulation
Antenna type:	Coil Antenna
Power supply:	DC 9V from adapter
Battery:	N/A
Adapter information:	N/A

### 1.2 Test mode

To investigate the maximum EMI emission characteristics generates from EUT, the test system was pre-scanning tested base on the consideration of following EUT operation mode or test configuration mode which possible have effect on EMI emission level. Each of these EUT operation mode(s) or test configuration mode(s) mentioned above was evaluated respectively.

Test mode	Description
Mode 1	Wireless charging

Note1: The test modes were carried out for all operation modes. The final test mode of the EUT was the worst test mode for EMI, and its test data was showed.

Note2: EUT is tested under full load and belongs to the worst mode.

### 1.3 EUT test setup

See photographs of the test setup in the report for the actual setup and connections between EUT and support equipment.

### 1.4 Ancillary equipment

Equipment	Model	S/N	Manufacturer
Adapter	EQ-24BCN	/	Huizhou Dongyang Yienbi Electronics Co., Ltd.
Load	/	/	/

### 1.5 Measurement Uncertainty

Measurement Uncertainty for a Level of Confidence of 95 %,  $U=2xUc(y)$

Conducted emission(150kHz~30MHz)	$\pm 2.5$ dB
Radiated emission(30MHz~1GHz)	$\pm 4.2$ dB
Radiated emission (above 1GHz)	$\pm 4.3$ dB
Temperature	$\pm 1$ degree
Humidity	$\pm 5$ %

## 2 Summary of Test Result

Item	FCC Part No.	Description of Test	Result
1	FCC PART 15.203	Antenna requirement	Pass
2	FCC PART 15.207	Conducted emission	Pass
3	FCC PART 15.209	Radiated emission	Pass
4	FCC Part 15.215	20dB bandwidth	Pass

### 2.1 Operation channel list

Channel List

Channel	Frequency (kHz)
Low	115
Middle	128
High	205

### 2.2 Test channel

Channel	Frequency (kHz)
Middle	128

### 3 Test Facilities and Accreditations

#### 3.1 Test laboratory

Test Laboratory	Shenzhen Microtest Co., Ltd
Location	No.102A & 302A, East Block, Hengfang Industrial Park, Xingye Road, Xixiang, Bao'an District, Shenzhen, Guangdong, China
FCC Registration No.:	448573

#### 3.2 Environmental conditions

Temperature:	15°C~35°C
Humidity	20%~75%
Atmospheric pressure	98kPa~101kPa

#### 3.3 Measurement uncertainty

Measurement Uncertainty for a Level of Confidence of 95 %,  $U=2xUc(y)$

RF frequency	$1 \times 10^{-7}$
RF power, conducted	$\pm 1$ dB
Conducted emission(150kHz~30MHz)	$\pm 2.5$ dB
Radiated emission(30MHz~1GHz)	$\pm 4.2$ dB
Radiated emission (above 1GHz)	$\pm 4.3$ dB
Temperature	$\pm 1$ degree
Humidity	$\pm 5$ %

#### 3.4 Test software

Software Name	Manufacturer	Model	Version
RF Test System	Shenzhen JS tonscent co., ltd	JS1120-3	2.5.77.0418

#### 4 List of test equipment

Equipment No.	Equipment Name	Manufacturer	Model	Serial No.	Calibration date	Due date
MTI-E004	EMI Test Receiver	Rohde&schwarz	ESPI7	100314	2018/10/09	2019/10/08
MTI-E006	TRILOG Broadband Antenna	Schwarzbeck	VULB 9163	9163-872	2018/10/15	2020/10/14
MTI-E014	amplifier	Hewlett-Packard	8447D	3113A06150	2018/10/09	2019/10/08
MTI-E036	Single path vehicle AMN(LISN)	Schwarzbeck	NNBM 8124	01175	2018/10/09	2019/10/08
MTI-E038	Low noise active vertical monopole antenna	Schwarzbeck	VAMP 9243	#565	2018/10/16	2019/10/15
MTI-E039	Biconical antenna	Schwarzbeck	BBA 9106	#164	2018/10/15	2019/10/14
MTI-E041	MXG Vector Signal Generator	Agilent	N5182A	MY49060455	2019/04/16	2020/04/15
MTI-E042	ESG Series Analog signal generator	Agilent	E4421B	GB40051240	2019/05/21	2020/05/20
MTI-E044	Thermometer clock humidity monitor	-	HTC-1	/	2019/04/17	2020/04/16
MTI-E062	Log Periodic Antenna	Schwarzbeck	VUSLP 9111B	#312	2018/04/11	2020/04/10
MTI-E063	Log Periodic Dipole Array Antenna	ETS-LINDGREN	3148B	00224524	2018/04/11	2020/04/10
MTI-E065	Amplifier	EMtrace	RP06A	00117	2019/04/29	2020/04/28
MTI-E071	PXA Signal Analyzer	Agilent	N9030A	MY51350296	2018/10/25	2019/10/24
MTI-E076	EMI Test Receiver	Rohde&schwarz	ESIB26	100273	2019/04/16	2020/04/15
MTI-E078	Synthesized Sweeper	Agilent	83752A	3610A01957	2019/04/16	2020/04/15
MTI-E079	DC Power Supply	Agilent	E3632A	MY40027695	2019/04/16	2020/04/15
MTI-E093	Artificial mains network	3ctest	LISN J50	ES3911805	2019/04/16	2020/04/15
MTI-E096	Power amplifier	Space-Dtronics	EWLNA0118G-P40	1852001	2019/04/29	2020/04/28
MTI-E097	Current Probe	SOLAR ELECTRONICS CO.	9207-1	220095-1	2019/04/17	2020/04/16
MTI-E098	Loop Sensor	SOLAR ELECTRONICS CO.	7334-1	220095-2	2019/04/21	2020/04/20

Note: the calibration interval of the above test instruments is 12 or 24 months and the calibrations are traceable to international system unit (SI).



## **5 Test Results**

### **5.1 Antenna requirement**

#### **5.1.1 Standard requirement**

15.203 requirement: For intentional device, according to 15.203: an intentional radiator shall be designed to ensure that no antenna other than that furnished by the responsible party shall be used with the device

#### **5.1.2 EUT Antenna**

The EUT antenna is Coil Antenna. It comply with the standard requirement. In case of replacement of broken antenna the same antenna type must be used.

## 5.2 Conducted emission

### 5.2.1 Limits

For the following equipment, when designed to be connected to the public utility (AC) power line the radio frequency voltage that is conducted back onto the AC power line on any frequency or frequencies shall not exceed the limits in the following tables. Compliance with the provisions of this paragraph shall be based on the measurement of the radio frequency voltage between each power line and ground at the power terminal using a 50  $\mu$ H/50 ohms line impedance stabilization network (LISN).

Frequency (MHz)	Conducted limit (dB $\mu$ V)	
	Quasi-peak	Average
0.15 -0.5	66 - 56 *	56 - 46 *
0.5 -5	56	46
5 -30	60	50

Note: the limit of " \* " marked band means the limitation decreases linearly with the logarithm of the frequency in the range.

### 5.2.2 Test Procedures

The EUT was placed 0.8 meters from the horizontal ground plane with EUT being connected to the power mains through a line impedance stabilization network (LISN). All other support equipment powered from additional LISN(s). The LISN provide 50 Ohm/ 50uH of coupling impedance for the measuring instrument.

Interconnecting cables that hang closer than 40 cm to the ground plane shall be folded back and forth in the center forming a bundle 30 to 40 cm long.

I/O cables that are not connected to a peripheral shall be bundled in the center. The end of the cable may be terminated, if required, using the correct terminating impedance. The overall length shall not exceed 1 m.

LISN is at least 80 cm from nearest part of EUT chassis.

For the actual test configuration, please refer to the related Item – photographs of the test setup.

### 5.2.3 Test Setup

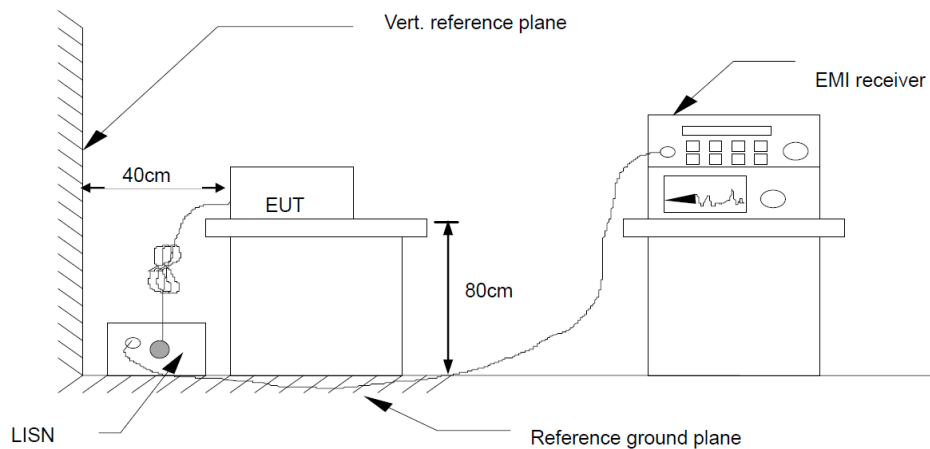

### 5.2.4 Test Result



EUT:	Wireless Charging Mount With Smart Auto Clamping	Model Name:	BMCA124A
Pressure:	101kPa	Phase:	L
Test voltage:	DC 9V from adapter AC 120V/60Hz	Test mode:	Mode 1

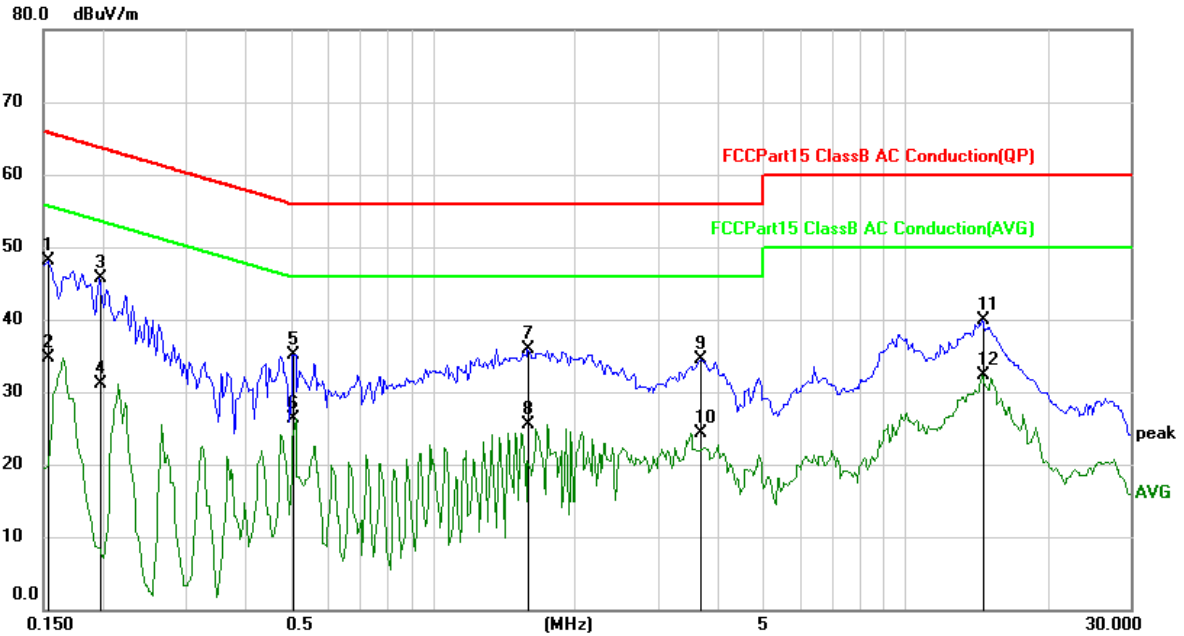

No.	Mk.	Freq. MHz	Reading Level dBuV/m	Correct Factor dB	Measure- ment dBuV/m	Limit dBuV/m	Over dB	Detector
1		0.1539	38.32	9.73	48.05	65.79	-17.74	QP
2		0.1539	24.92	9.73	34.65	55.79	-21.14	AVG
3		0.1969	35.93	9.73	45.66	63.74	-18.08	QP
4		0.1969	21.45	9.73	31.18	53.74	-22.56	AVG
5		0.5055	25.18	9.88	35.06	56.00	-20.94	QP
6		0.5055	16.50	9.88	26.38	46.00	-19.62	AVG
7		1.5875	26.04	9.96	36.00	56.00	-20.00	QP
8		1.5875	15.48	9.96	25.44	46.00	-20.56	AVG
9		3.6812	24.45	10.02	34.47	56.00	-21.53	QP
10		3.6812	14.34	10.02	24.36	46.00	-21.64	AVG
11		14.5797	29.66	10.20	39.86	60.00	-20.14	QP
12	*	14.5797	22.09	10.20	32.29	50.00	-17.71	AVG



EUT:	Wireless Charging Mount With Smart Auto Clamping	Model Name:	BMCA124A
Pressure:	101kPa	Phase:	N
Test voltage:	DC 9V from adapter AC 120V/60Hz	Test mode:	Mode 1

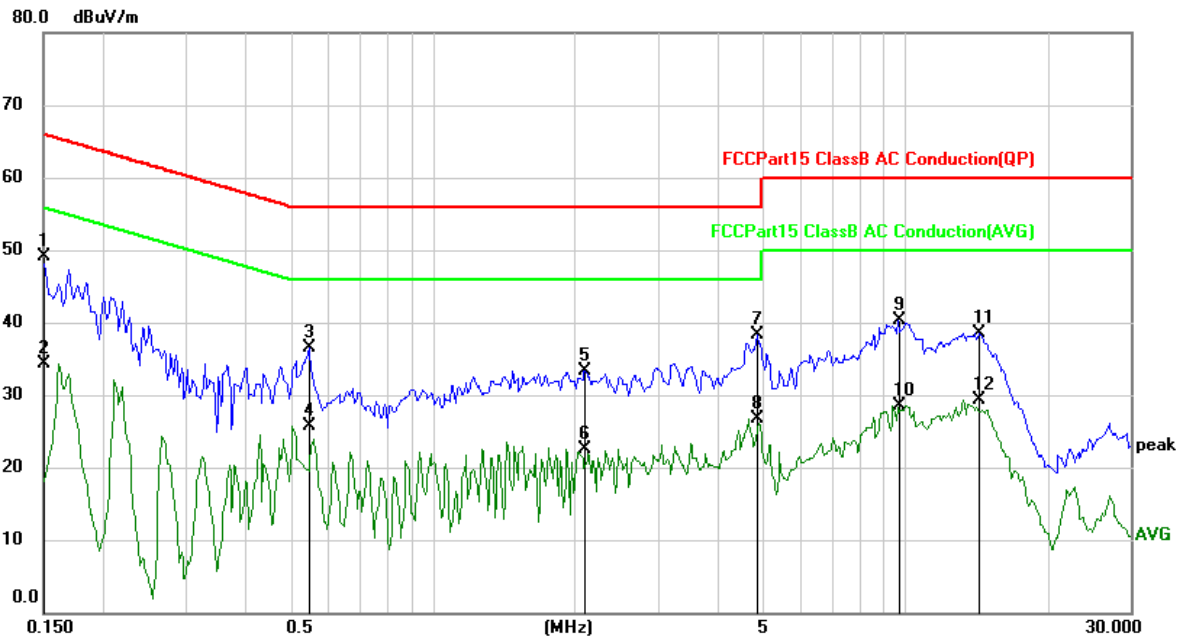

No.	Mk.	Freq.	Reading Level	Correct Factor	Measurement	Limit	Over	Detector
		MHz	dBuV/m	dB	dBuV/m	dBuV/m	dB	
1	*	0.1500	39.42	9.73	49.15	66.00	-16.85	QP
2		0.1500	24.64	9.73	34.37	56.00	-21.63	AVG
3		0.5484	26.61	9.89	36.50	56.00	-19.50	QP
4		0.5484	15.83	9.89	25.72	46.00	-20.28	AVG
5		2.0953	23.30	9.97	33.27	56.00	-22.73	QP
6		2.0953	12.56	9.97	22.53	46.00	-23.47	AVG
7		4.8648	28.20	10.05	38.25	56.00	-17.75	QP
8		4.8648	16.56	10.05	26.61	46.00	-19.39	AVG
9		9.6813	29.95	10.27	40.22	60.00	-19.78	QP
10		9.6813	18.32	10.27	28.59	50.00	-21.41	AVG
11		14.3297	28.39	10.20	38.59	60.00	-21.41	QP
12		14.3297	19.18	10.20	29.38	50.00	-20.62	AVG



EUT:	Wireless Charging Mount With Smart Auto Clamping	Model Name:	BMCA124A
Pressure:	101kPa	Phase:	L
Test voltage:	DC 9V from adapter AC 240V/60Hz	Test mode:	Mode 1

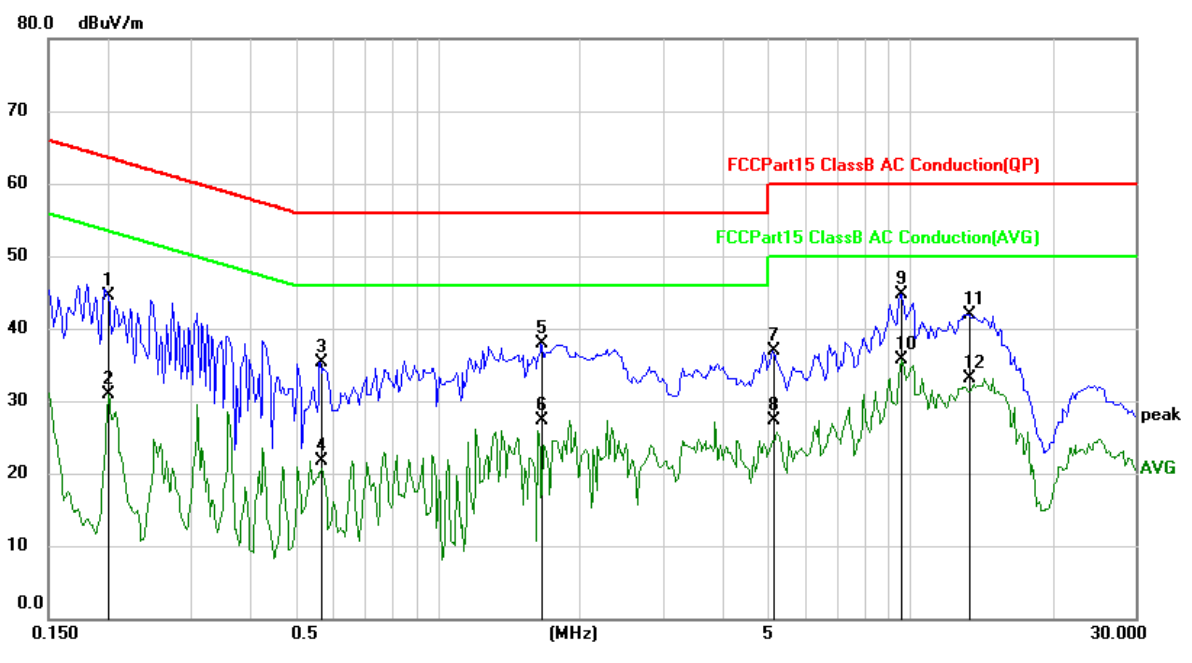

No.	Mk.	Freq. MHz	Reading Level dBuV/m	Correct Factor dB	Measure- ment dBuV/m	Limit dBuV/m	Over dB	Detector
1		0.2007	34.82	9.73	44.55	63.58	-19.03	QP
2		0.2007	21.17	9.73	30.90	53.58	-22.68	AVG
3		0.5641	25.49	9.89	35.38	56.00	-20.62	QP
4		0.5641	11.87	9.89	21.76	46.00	-24.24	AVG
5		1.6617	27.88	9.96	37.84	56.00	-18.16	QP
6		1.6617	17.30	9.96	27.26	46.00	-18.74	AVG
7		5.1383	26.83	10.05	36.88	60.00	-23.12	QP
8		5.1383	17.28	10.05	27.33	50.00	-22.67	AVG
9		9.5484	34.48	10.27	44.75	60.00	-15.25	QP
10	*	9.5484	25.52	10.27	35.79	50.00	-14.21	AVG
11		13.3258	31.75	10.22	41.97	60.00	-18.03	QP
12		13.3258	22.90	10.22	33.12	50.00	-16.88	AVG



EUT:	Wireless Charging Mount With Smart Auto Clamping	Model Name:	BMCA124A
Pressure:	101kPa	Phase:	N
Test voltage:	DC 9V from adapter AC 240V/60Hz	Test mode:	Mode 1

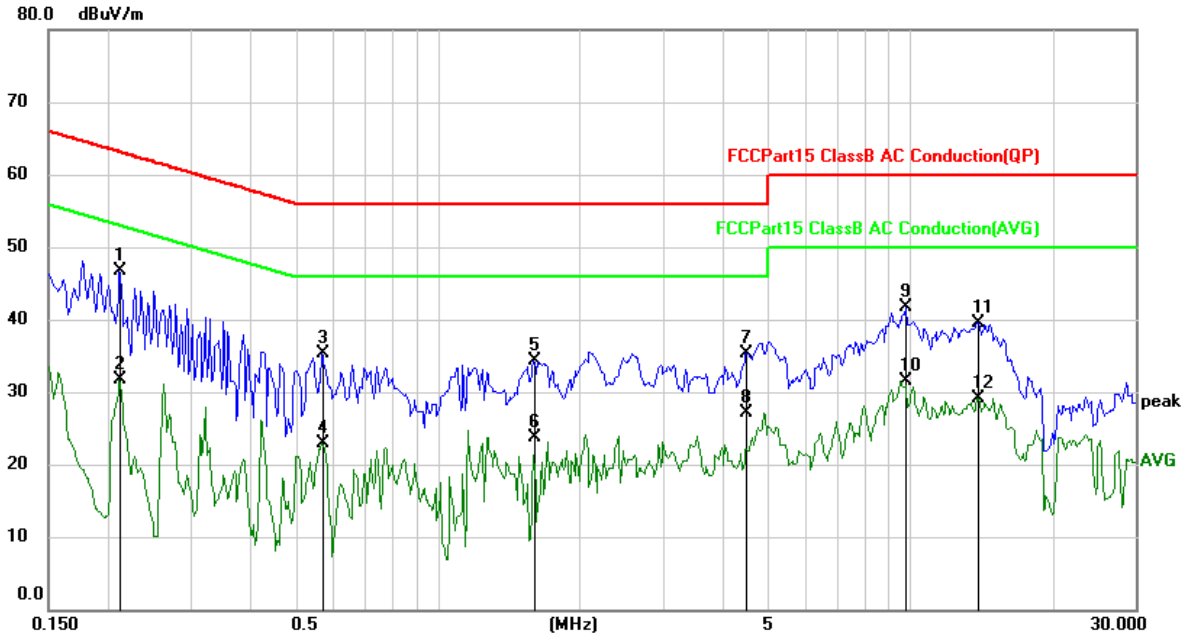

No.	Mk.	Freq. MHz	Reading Level dBuV/m	Correct Factor dB	Measure- ment dBuV/m	Limit dBuV/m	Over dB	Detector
1	*	0.2125	37.05	9.73	46.78	63.11	-16.33	QP
2		0.2125	21.96	9.73	31.69	53.11	-21.42	AVG
3		0.5680	25.47	9.89	35.36	56.00	-20.64	QP
4		0.5680	13.01	9.89	22.90	46.00	-23.10	AVG
5		1.5953	24.41	9.96	34.37	56.00	-21.63	QP
6		1.5953	13.78	9.96	23.74	46.00	-22.26	AVG
7		4.4898	25.31	10.04	35.35	56.00	-20.65	QP
8		4.4898	17.12	10.04	27.16	46.00	-18.84	AVG
9		9.8023	31.40	10.28	41.68	60.00	-18.32	QP
10		9.8023	21.14	10.28	31.42	50.00	-18.58	AVG
11		13.9000	29.30	10.22	39.52	60.00	-20.48	QP
12		13.9000	18.86	10.22	29.08	50.00	-20.92	AVG

### 5.3 Radiated emission

#### 5.3.1 Limits

In case the emission fall within the restricted band specified on 15.205(a), then the 15.209(a) limit in the table below has to be followed.

Frequencies (MHz)	Field Strength (microrvolts/meter)	Measurement Distance (meters)
0.009~0.490	2400/F(KHz)	300
0.490~1.705	24000/F(KHz)	30
1.705~30.0	30	30
30~88	100	3
88~216	150	3
216~960	200	3
Above 960	500	3

#### LIMITS OF RADIATED EMISSION MEASUREMENT (Above 1000MHz)

FREQUENCY (MHz)	Class B (dBuV/m) (at 3M)	
	PEAK	AVERAGE
Above 1000	74	54

Notes:

The limit for radiated test was performed according to FCC PART 15C.

The tighter limit applies at the band edges.

Emission level (dBuV/m)=20log Emission level (uV/m).

#### FREQUENCY RANGE OF RADIATED MEASUREMENT (For unintentional radiators)

Highest frequency generated or Upper frequency of measurement used in the device or on which the device operates or tunes (MHz)	Range (MHz)
Below 1.705	30
1.705 – 108	1000
108 – 500	2000
500 – 1000	5000
Above 1000	5 <sup>th</sup> harmonic of the highest frequency or 40 GHz, whichever is lower

Spectrum Parameter	Setting
Attenuation	Auto
Start Frequency	1000 MHz
Stop Frequency	10th carrier harmonic
RB / VB (emission in restricted band)	1 MHz / 1 MHz for Peak, 1 MHz / 10Hz for Average

Receiver Parameter	Setting
Attenuation	Auto
Start ~ Stop Frequency	9kHz~150kHz / RB 200Hz for QP
Start ~ Stop Frequency	150kHz~30MHz / RB 9kHz for QP

Start ~ Stop Frequency	30MHz~1000MHz / RB 120kHz for QP
------------------------	----------------------------------

### 5.3.2 Test Procedures

- a. The measuring distance of at 3 m shall be used for measurements at frequency up to 25GHz. For frequencies above 1GHz, any suitable measuring distance may be used.
- b. The EUT was placed on the top of a rotating table 0.8 meters above the ground at a 3 meter semi-chamber test. The table was rotated 360 degrees to determine the position of the highest radiation.
- c. The height of the equipment or of the substitution antenna shall be 0.8m; above 1GHz, the height was 1.5m, the height of the test antenna shall vary between 1 m to 4 m. Both horizontal and vertical polarizations of the antenna are set to make the measurement.
- d. The initial step in collecting conducted emission data is a spectrum analyzer peak detector mode pre-scanning the measurement frequency range. Significant peaks are then marked and then Quasi Peak detector mode re-measured.
- e. If the Peak Mode measured value compliance with and lower than Quasi Peak Mode Limit, the EUT shall be deemed to meet QP Limits and then no additional QP Mode measurement performed.
- f. For the actual test configuration, please refer to the related Item –EUT Test Photos.
- g. For the radiated emission test above 1GHz:  
Place the measurement antenna away from each area of the EUT determined to be a source of emissions at the specified measurement distance, while keeping the measurement antenna aimed at the source of emissions at each frequency of significant emissions, with polarization oriented for maximum response.
- h. The measurement antenna may have to be higher or lower than the EUT, depending on the radiation pattern of the emission and staying aimed at the emission source for receiving the maximum signal. The final measurement antenna elevation shall be that which maximizes the emissions. The measurement antenna elevation for maximum emissions shall be restricted to a range of heights of from 1 m to 4 m above the ground or reference ground plane.

Note: Both horizontal and vertical antenna polarities were tested and performed pretest to three orthogonal axis. The worst case emissions were reported.



### 5.3.3 Test Setup

#### Radiated Emission Test-Up Frequency Below 30MHz

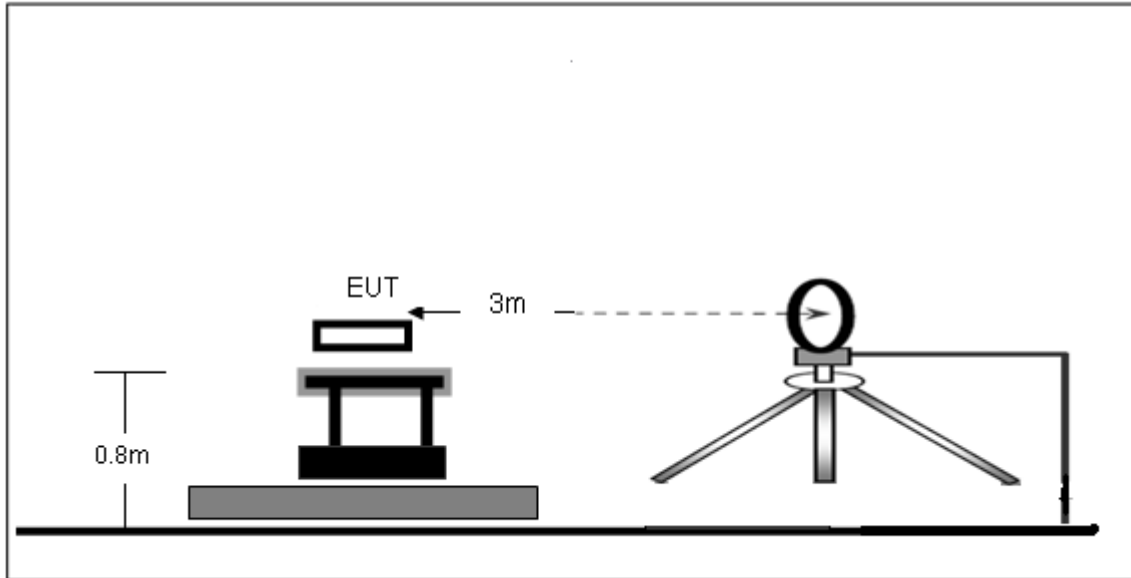

#### Radiated Emission Test-Up Frequency 30MHz~1GHz

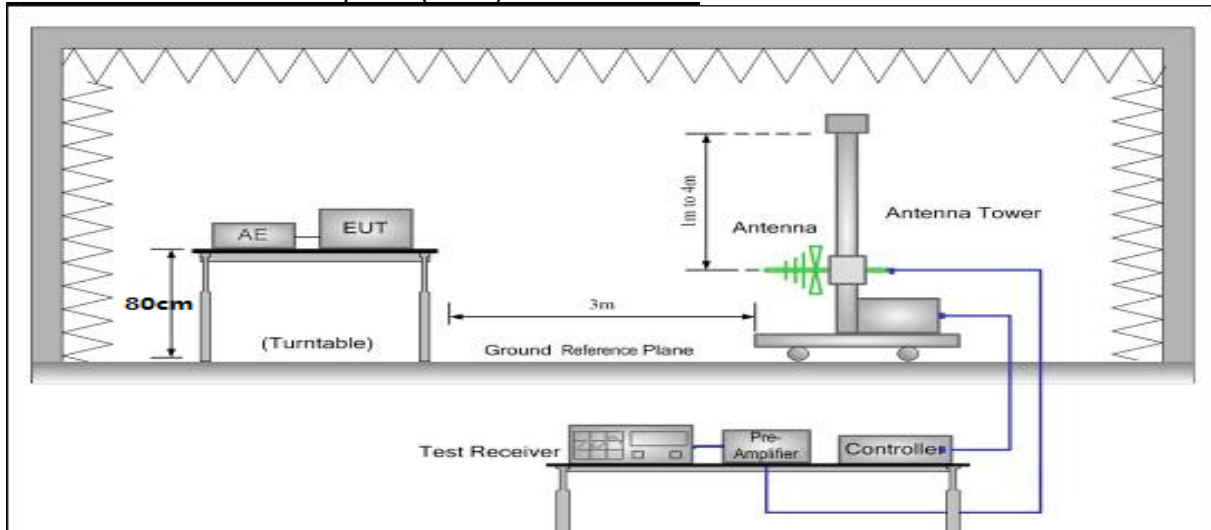

### 5.3.4 Test Result



Frequency range (9kHz – 30MHz)

EUT:	Wireless Charging Mount With Smart Auto Clamping	Model Name:	BMCA124A
Pressure:	101kPa	Test mode:	Mode 1
Test voltage:	DC 9V from adapter AC 120V/60Hz		

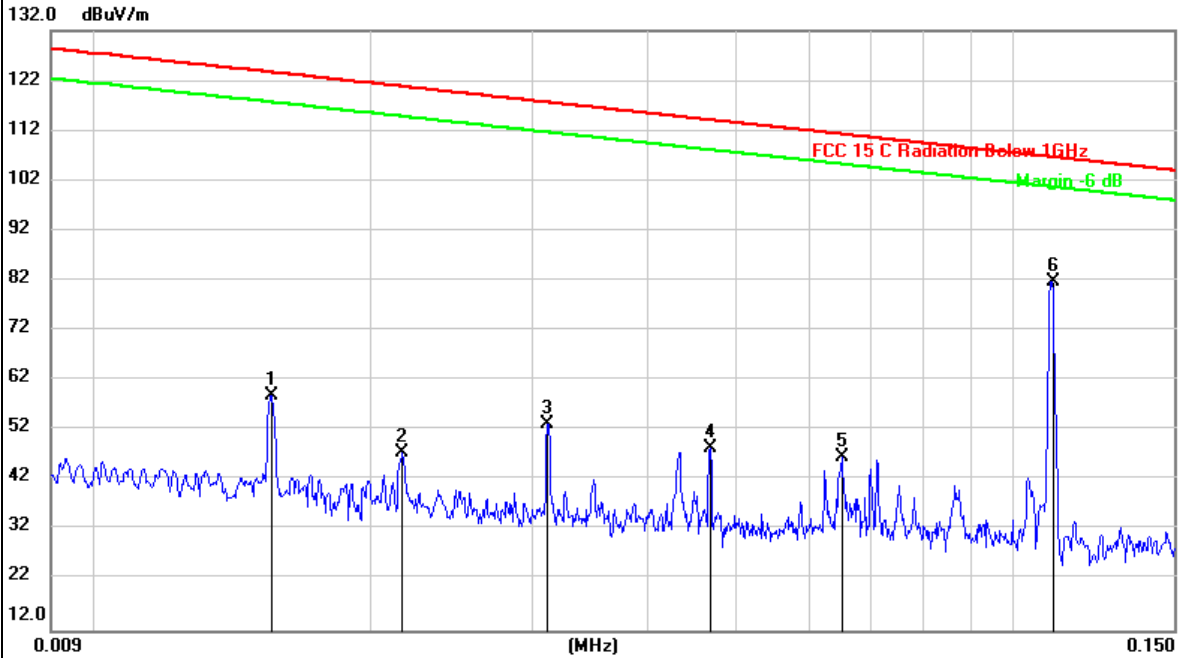

No.	Mk.	Freq. MHz	Reading Level dBuV	Correct Factor dBuV/m	Measure- ment dBuV/m	Limit dBuV/m	Over dB
1		0.0156	38.75	20.33	59.08	123.57	-64.49
2		0.0217	27.24	20.36	47.60	120.72	-73.12
3		0.0312	32.85	20.33	53.18	117.59	-64.41
4		0.0469	28.09	20.28	48.37	114.07	-65.70
5		0.0652	26.41	20.15	46.56	111.22	-64.66
6	*	0.1285	61.93	19.78	81.71	105.36	-23.65



EUT:	Wireless Charging Mount With Smart Auto Clamping	Model Name:	BMCA124A
Pressure:	101kPa	Test mode:	Mode 1
Test voltage:	DC 9V from adapter AC 120V/60Hz		

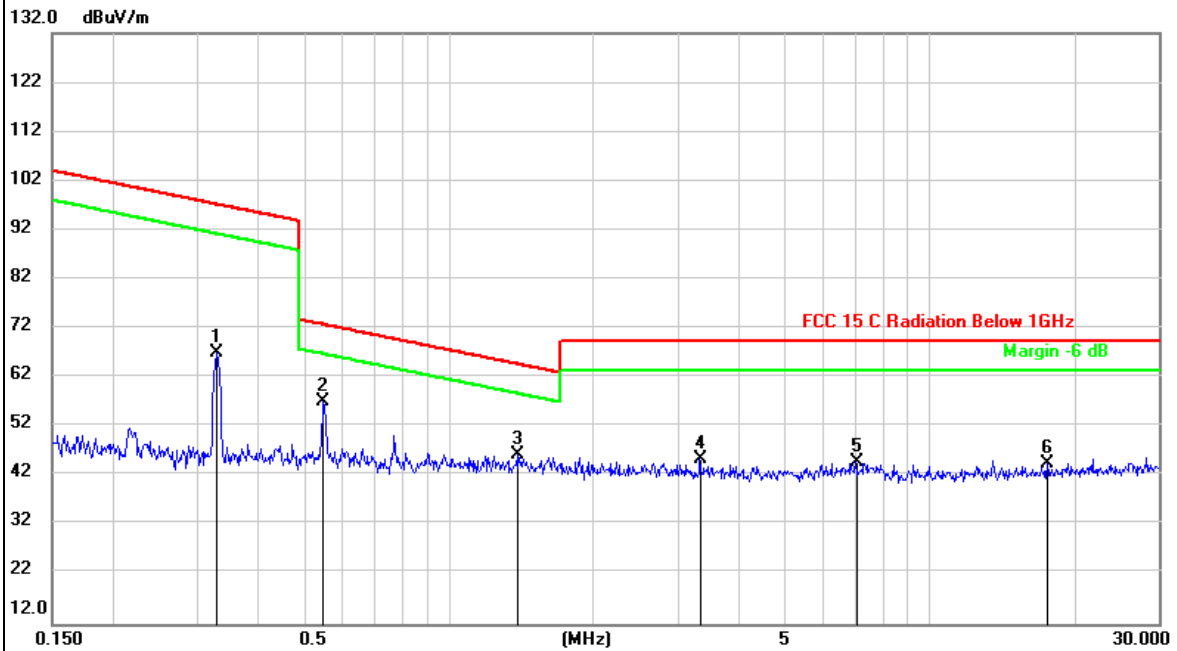

No.	Mk.	Freq.	Reading Level	Correct Factor	Measurement	Limit	Over	
		MHz	dBuV	dBuV/m	dBuV/m	dBuV/m	dB	Detector
1		0.3303	47.11	19.83	66.94	97.22	-30.28	peak
2	*	0.5493	37.07	20.11	57.18	72.81	-15.63	peak
3		1.3884	26.22	20.26	46.48	64.78	-18.30	peak
4		3.3281	25.28	20.12	45.40	69.50	-24.10	peak
5		7.0249	24.70	20.29	44.99	69.50	-24.51	peak
6		17.5677	23.68	20.96	44.64	69.50	-24.86	peak



Frequency range (30MHz – 1GHz)

EUT:	Wireless Charging Mount With Smart Auto Clamping	Model Name:	BMCA124A
Pressure:	101kPa	Polarization:	Vertical
Test voltage:	DC 9V from adapter AC 120V/60Hz	Test mode:	Mode 1

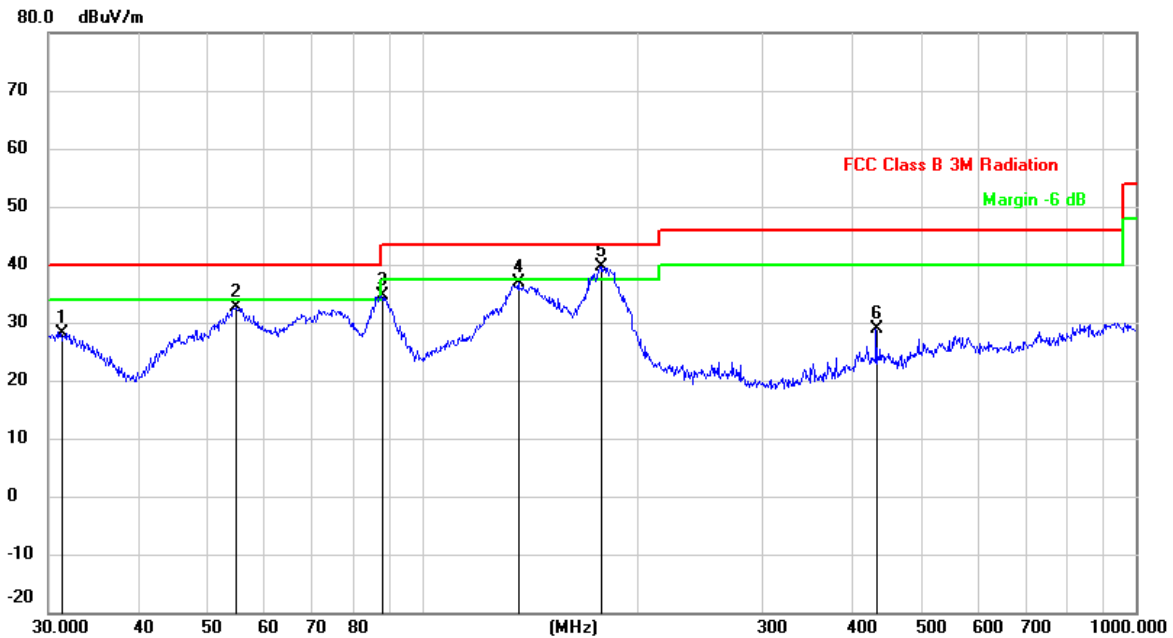

No.	Mk.	Freq. MHz	Reading Level dBuV	Correct Factor dBuV/m	Measure- ment dBuV/m	Limit dBuV/m	Over dB	Detector
1		31.1798	37.16	-9.01	28.15	40.00	-11.85	QP
2		55.0274	40.00	-7.35	32.65	40.00	-7.35	QP
3	!	87.7248	44.89	-10.27	34.62	40.00	-5.38	QP
4		136.4598	47.69	-10.91	36.78	43.50	-6.72	QP
5	*	178.7584	48.94	-9.19	39.75	43.50	-3.75	QP
6		432.5457	31.67	-2.90	28.77	46.00	-17.23	QP



EUT:	Wireless Charging Mount With Smart Auto Clamping	Model Name:	BMCA124A
Pressure:	101kPa	Polarization:	Horizontal
Test voltage:	DC 9V from adapter AC 120V/60Hz	Test mode:	Mode 1

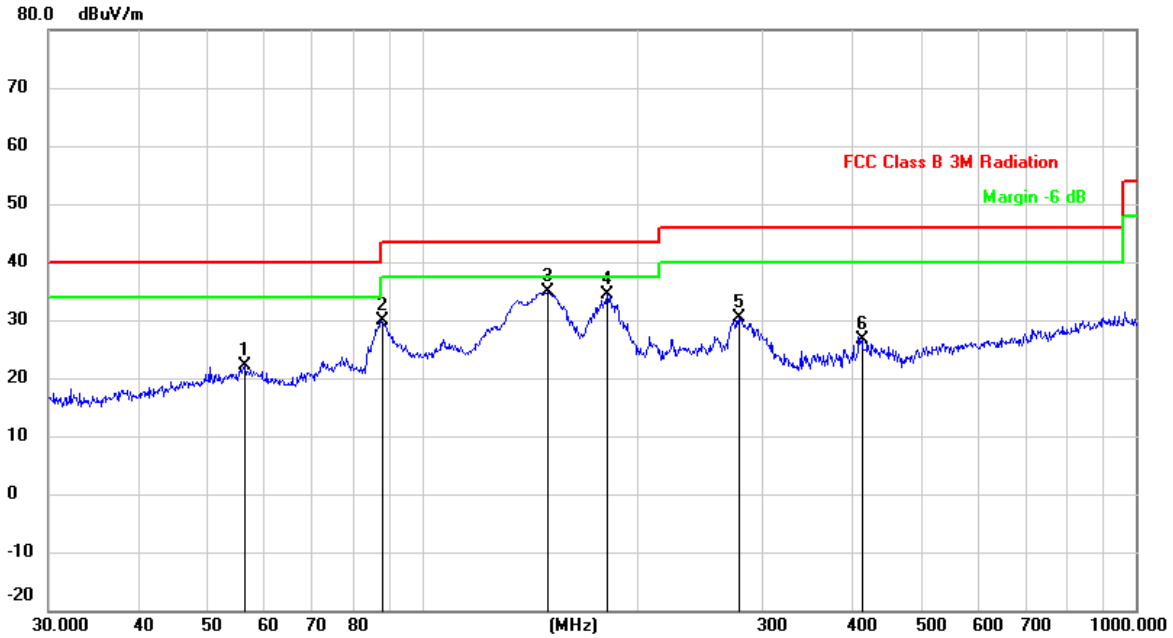

No.	Mk.	Freq. MHz	Reading Level dBuV	Correct Factor dBuV/m	Measure- ment dBuV/m	Limit dBuV/m	Over dB	Detector
1		56.5929	29.68	-7.62	22.06	40.00	-17.94	QP
2		87.7248	40.15	-10.27	29.88	40.00	-10.12	QP
3	*	150.0108	45.46	-10.50	34.96	43.50	-8.54	QP
4		181.9202	43.39	-8.89	34.50	43.50	-9.00	QP
5		278.0668	36.01	-5.71	30.30	46.00	-15.70	QP
6		413.2706	29.92	-3.35	26.57	46.00	-19.43	QP

## 5.4 Occupied bandwidth

### 5.4.1 Test method

Use the following spectrum analyzer settings:

Span = approximately 2 to 3 times the 20 dB bandwidth, centered on a hopping channel

RBW  $\geq 1\%$  of the 20 dB bandwidth

VBW  $\geq$  RBW

Sweep = auto

Detector function = peak

Trace = max hold

The EUT should be transmitting at its maximum data rate. Allow the trace to stabilize. Use the marker-to-peak function to set the marker to the peak of the emission. Use the marker-delta function to measure 20 dB down one side of the emission. Reset the marker-delta function, and move the marker to the other side of the emission, until it is (as close as possible to) even with the reference marker level. The marker-delta reading at this point is the 20 dB bandwidth and 99% occupied bandwidth of the emission.

### 5.4.2 Test result

Frequency (kHz)	20dB emission bandwidth (kHz)	99% occupied bandwidth (kHz)
128	8.170	7.613

Test plots as below:

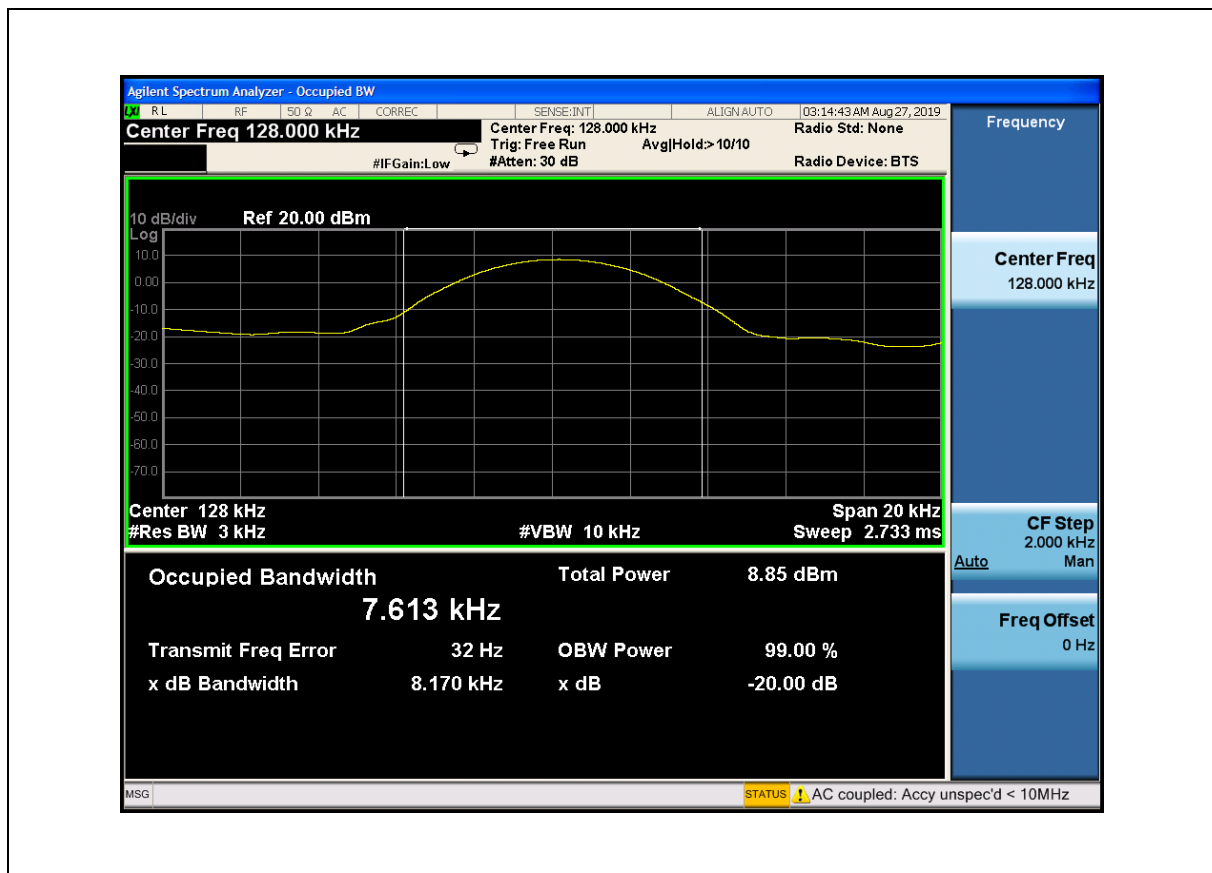

## 6 Photographs of the Test Setup

Radiated emission

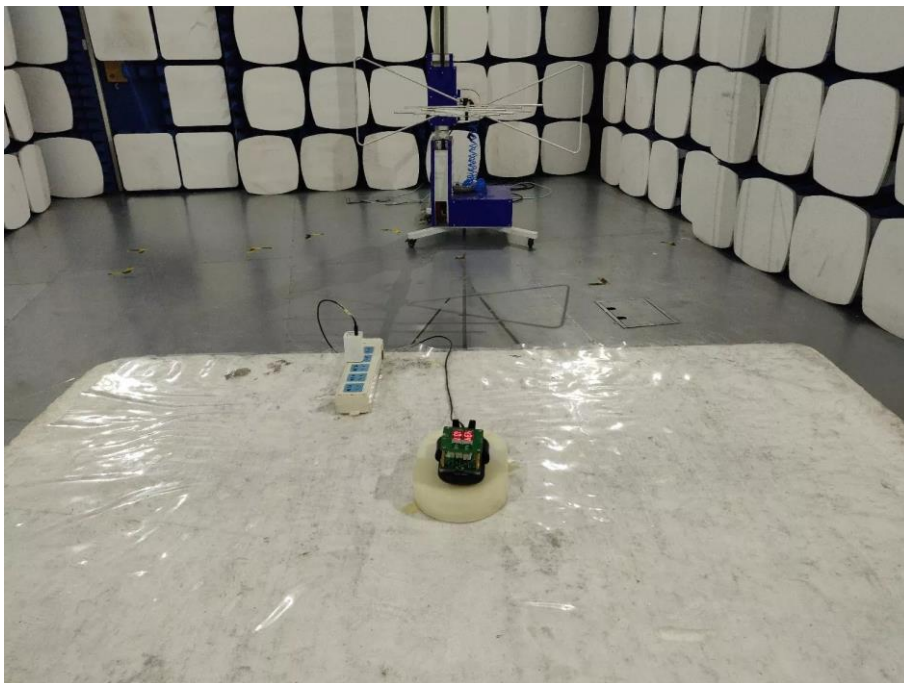
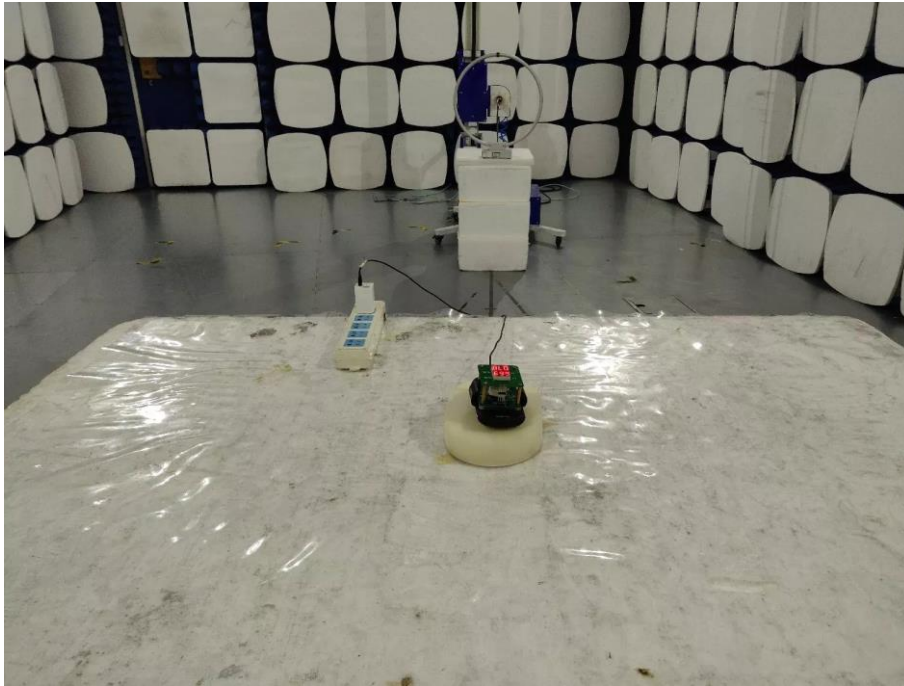



Conducted emission

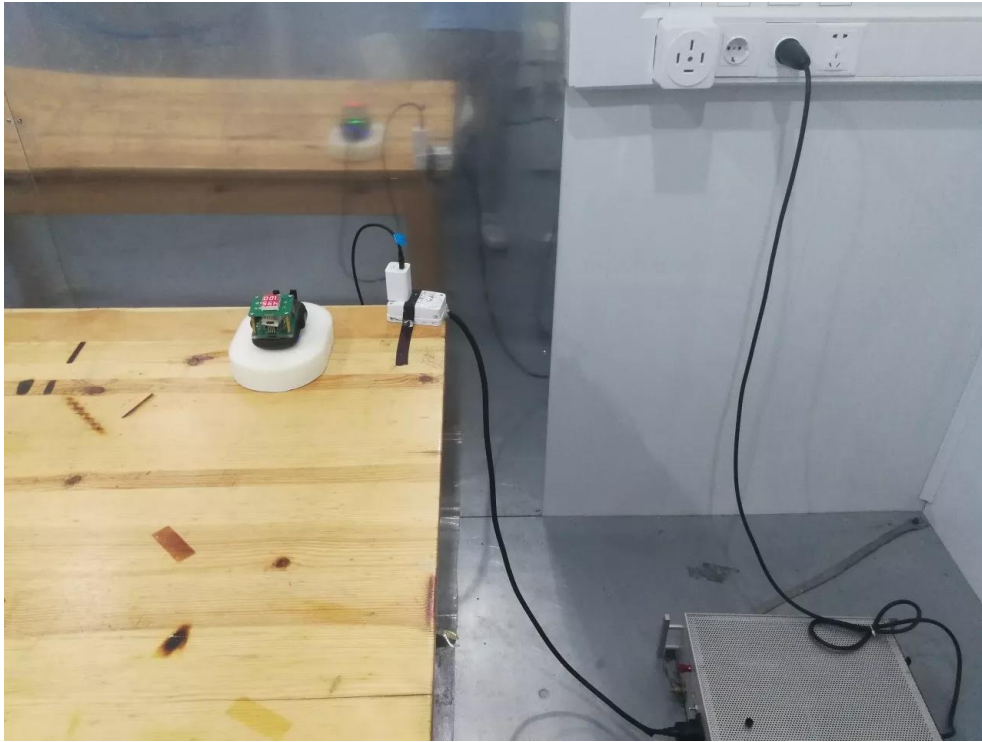



## **7 Photographs of the EUT**

See the APPENDIX 1: EUT PHOTOS in the report No.: MTi19072222-4E1-1.

**----END OF REPORT----**