

TEST REPORT

Report Number: 19100315HKG-002

Application for Original Grant of 47 CFR Part 15 Certification

FCC ID: 2AUNZROTOHT001

Prepared and Checked by:

Approved by:



Kelvin Liang
Assistant Manager
Shenzhen UnionTrust Quality and
Technology Co., Ltd.
Date: November 23, 2019

Wong Kwok Yeung, Kenneth
Senior Lead Engineer
Intertek Testing Services Hong Kong
Date: December 04, 2019

TEST REPORT

GENERAL INFORMATION

Applicant Name:	Roto VR
Applicant Address:	Flat 8, Consort House, 5 Albert House, London NW7 4RX United Kingdom
FCC Specification Standard:	FCC Part 15, October 1, 2018 Edition
FCC ID:	2ANUZROTOHT001
FCC Model(s):	RotoHT001
Type of EUT:	Spread Spectrum Transmitter
Description of EUT:	VR Chair
Serial Number:	N/A
Sample Receipt Date:	October 11, 2019
Date of Test:	October 11, 2019 to November 23, 2019 Shenzhen UnionTrust Quality and Technology Co., Ltd.
Place of Testing:	16/F, Block A, Building 6, Baoneng Science and Technology Park, Qingxiang Road No.1, Longhua New District, Shenzhen, China.
Report Date:	December 04, 2019
Environmental Conditions:	Temperature: +10 to 40°C Humidity: 10 to 90%
Conclusion:	Test was conducted by client submitted sample. The submitted sample as received complied with the 47 CFR Part 15 Certification.

TEST REPORT

TABLE OF CONTENTS

1.0 TEST RESULTS SUMMARY & STATEMENT OF COMPLIANCE 4

 1.1 Summary of Test Results4

 1.2 Statement of Compliance4

2.0 GENERAL DESCRIPTION..... 5

 2.1 Product Description.....5

 2.2 Test Methodology6

 2.3 Test Facility6

 2.4 Related Submittal(s) Grants.....6

3.0 SYSTEM TEST CONFIGURATION..... 7

 3.1 Justification7

 3.2 EUT Exercising Software8

 3.3 Details of EUT and Description of Accessories.....9

 3.4 Measurement Uncertainty9

4.0 TEST RESULTS 10

 4.1 Maximum Conducted Output Power at Antenna Terminals.....10

 4.2 Minimum 6dB RF Bandwidth11

 4.3 Maximum Power Spectral Density.....14

 4.4 Out of Band Conducted Emissions17

 4.5 Field Strength Calculation.....23

 4.6 Transmitter Radiated Emissions in Restricted Bands and Spurious Emissions.....24

 4.6.1 Radiated Emission Configuration Photograph24

 4.6.2 Radiated Emission Data24

 4.6.3 Radiated Emission Test Setup31

 4.6.4 Transmitter Duty Cycle Calculation32

 4.7 AC Power Line Conducted Emission.....33

 4.7.1 AC Power Line Conducted Emission Configuration Photograph33

 4.7.2 AC Power Line Conducted Emission Data.....33

 4.7.3 Conducted Emission Test Setup36

5.0 EQUIPMENT LIST 37

TEST REPORT

1.0 TEST RESULTS SUMMARY & STATEMENT OF COMPLIANCE

1.1 Summary of Test Results

Test Items	FCC Part 15 Section	Results	Details See Section
Antenna Requirement	15.203	Pass	2.1
Max. Conducted Output Power (Peak)	15.247(b)(3)&(4)	Pass	4.1
Min. 6dB RF Bandwidth	15.247(a)(2)	Pass	4.2
Max. Power Density	15.247(e)	Pass	4.3
Out of Band Antenna Conducted Emission	15.247(d)	Pass	4.4
Radiated Emission in Restricted Bands and Spurious Emissions	15.247(d), 15.209 & 15.109	Pass	4.6
AC Power Line Conducted Emission	15.207 & 15.107	Pass	4.7

Note: Pursuant to FCC Part 15 Section 15.215(c), the 20dB bandwidth of the emission was contained within the frequency band designated (mentioned as above) which the EUT operated. The effects, if any, from frequency sweeping, frequency hopping, other modulation techniques and frequency stability over expected variations in temperature and supply voltage were considered.

1.2 Statement of Compliance

The equipment under test is found to be complying with the following standard:

FCC Part 15, October 1, 2018 Edition

TEST REPORT

2.0 GENERAL DESCRIPTION

2.1 Product Description

The RotoHT001 Head Tracker of the VR Chair.

The Equipment Under Test (EUT) operates at frequency range of 2402MHz to 2480MHz with 40 channels.

The EUT was powered by USB port.

The antenna(s) used in the EUT is integral, and the test sample is a prototype.

The circuit description is saved with filename: descri.pdf.

TEST REPORT

2.2 Test Methodology

Both AC power line-conducted and radiated emission measurements were performed according to the procedures in ANSI C63.10 (2013). Preliminary radiated scans and all radiated measurements were performed in radiated emission test sites. All Radiated tests were performed at an antenna to EUT distance of 3 meters, unless stated otherwise in the "**Justification Section**" of this Application. Antenna port conducted measurements were performed according to ANSI C63.10 (2013) and KDB Publication No.558074 D01 v05r01 (11-Feb-2019) All other measurements were made in accordance with the procedures in 47 CFR Part 2.

2.3 Test Facility

The radiated emission test site and antenna port conducted measurement facility used to collect the radiated data and conductive data are at 16/F., Block A, Building 6, Baoneng Science and Technology Park, Qingxiang Road No.1, Longhua New District, Shenzhen, China. This test facility and site measurement data have been fully placed on file with the FCC.

2.4 Related Submittal(s) Grants

This is a single application for certification of a transceiver.

TEST REPORT

3.0 SYSTEM TEST CONFIGURATION

3.1 Justification

For radiated emissions testing, the equipment under test (EUT) was setup to transmit / receive continuously to simplify the measurement methodology. Care was taken to ensure proper power supply voltages during testing. During testing, all cables (if any) were manipulated to produce worst case emissions.

The EUT power was supplied via USB port from Base of VR Chair which was powered by 120VAC.

For the measurements, the EUT was attached to a plastic stand if necessary and placed on the wooden turntable. If the base unit attached to peripherals, they were connected and operational (as typical as possible).

The signal was maximized through rotation and placement in the three orthogonal axes. The antenna height and polarization were varied during the search for maximum signal level. The antenna height was varied from 1 to 4 meters. Radiated emissions were taken at three meters unless the signal level was too low for measurement at that distance. If necessary, a pre-amplifier was used and/or the test was conducted at a closer distance.

For any intentional radiator powered by AC power line, measurements of the radiated signal level of the fundamental frequency component of the emission was performed with the supply voltage varied between 85% and 115% of the nominal rated supply voltage.

Radiated emission measurement for transmitter were performed from the lowest radio frequency signal generated in the device which is greater than 9 kHz to the tenth harmonic of the highest fundamental frequency or to 40 GHz, whichever is lower.

Emission that are directly caused by digital circuits in the transmit path and transmitter portion were measured, and the limit are according to FCC Part 15 Section 15.209. Digital circuitries used to control additional functions other than the operation of the transmitter are subject to FCC Part 15 Section 15.109.

TEST REPORT

3.1 Justification – Cont'd

Detector function for radiated emissions was in peak mode. Average readings, when required, were taken by measuring the duty cycle of the equipment under test and subtracting the corresponding amount in dB from the measured peak readings. A detailed description for the calculation of the average factor can be found in section 4.8.3.

Determination of pulse desensitization was made according to *Hewlett Packard Application Note 150-2, Spectrum Analysis... Pulsed RF*. The effective period (Teff) was referred to Exhibit 4.8.3. With the resolution bandwidth 3MHz and spectrum analyzer IF bandwidth 3dB, the pulse desensitization factor was 0dB.

For AC line conducted emission test, the EUT along with its peripherals were placed on a 1.0m(W)x1.5m(L) and 0.8m in height wooden table and the EUT was adjusted to maintain a 0.4 meter space from a vertical reference plane. The EUT was connected to power mains through a line impedance stabilization network (LISN), which provided 50ohm coupling impedance for measuring instrument. The LISN housing, measuring instrument case, reference ground plane, and vertical ground plane were bounded together. The excess power cable between the EUT and the LISN was bundled.

All connecting cables of EUT and peripherals were manipulated to find the maximum emission.

Different data rates have been tested. Worst case is reported only.

All relevant operation modes have been tested, and the worst case data is included in this report.

All data rates were tested under normal mode of BLE. Only the worst-case data is shown in the report for GFSK.

3.2 EUT Exercising Software

The EUT exercise program (if any) used during radiated and conducted testing was designed to exercise the various system components in a manner similar to a typical use.

TEST REPORT

3.3 Details of EUT and Description of Accessories

Details of EUT:

An AC adaptor (provided with the unit) was used to power the device. Their description are listed below.

- (1) An AC adaptor (100VAC to 240VAC, Model: GST280A24-C6P) (Provided by Client)

Description of Accessories:

- (1) USB3.0 cable (Provided by Applicant)
(2) USB2.0 cable (Provided by Applicant)

3.4 Measurement Uncertainty

When determining of the test conclusion, the Measurement Uncertainty of test at a level of confidence of 95% has been considered. The values of the Measurement uncertainty:

No.	Item	Measurement Uncertainty
1	Conducted emission 9KHz-150KHz	±3.8 dB
2	Conducted emission 150KHz-30MHz	±3.4 dB
3	Radiated emission 9KHz-30MHz	±4.9 dB
4	Radiated emission 30MHz-1GHz	±4.7 dB
5	Radiated emission 1GHz-18GHz	±5.1 dB
6	Radiated emission 18GHz-26GHz	±5.2 dB
7	Radiated emission 26GHz-40GHz	±5.2 dB

Uncertainty and Compliance - Unless the standard specifically states that measured values are to be extended by the measurement uncertainty in determining compliance, all compliance determinations are based on the actual measured value.

TEST REPORT

4.0 TEST RESULTS

4.1 Maximum Conducted (peak) Output Power at Antenna Terminals

RF Conduct Measurement Test Setup

The figure below shows the test setup, which is utilized to make these measurements.

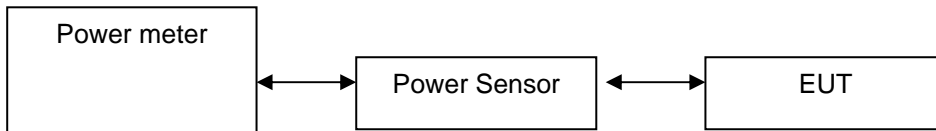

The antenna port of the EUT was connected to the input of a spectrum analyzer.

- The antenna power of the EUT was connected to the input of a power meter. Power was read directly and cable loss correction was added to the reading to the obtain power at the EUT antenna terminals. The measurement procedure 11.9.1.3 was used.
- The EUT should be configured to transmit continuously (at a minimum duty cycle of 98%) at full power over the measurement duration. The measurement procedure AVG1 was used.

BLE (GFSK) Antenna Gain = 0 dBi

Frequency (MHz)	Output in dBm (PEAK)	Output in mWatt
Low Channel: 2402	0.17	1.04
Middle Channel: 2440	0.06	1.01
High Channel: 2480	-0.20	0.95

TEST REPORT

4.2 Minimum 6dB RF Bandwidth

The antenna port of the EUT was connected to the input of a spectrum analyzer. The EBW measurement procedure was used. A PEAK output reading was taken, a DISPLAY line was drawn 6dB lower than PEAK level. The 6dB bandwidth was determined from where the channel output spectrum intersected the display line.

BLE (GFSK)

	Frequency (MHz)	6dB Bandwidth (kHz)
Low Channel:	2402	691.7
Middle Channel:	2440	692.1
High Channel:	2480	695.0

Limits

6 dB bandwidth shall be at least 500kHz

The plots of 6dB RF bandwidth are saved as below.

TEST REPORT

PLOTS OF 6dB RF BANDWIDTH

Lowest Channel

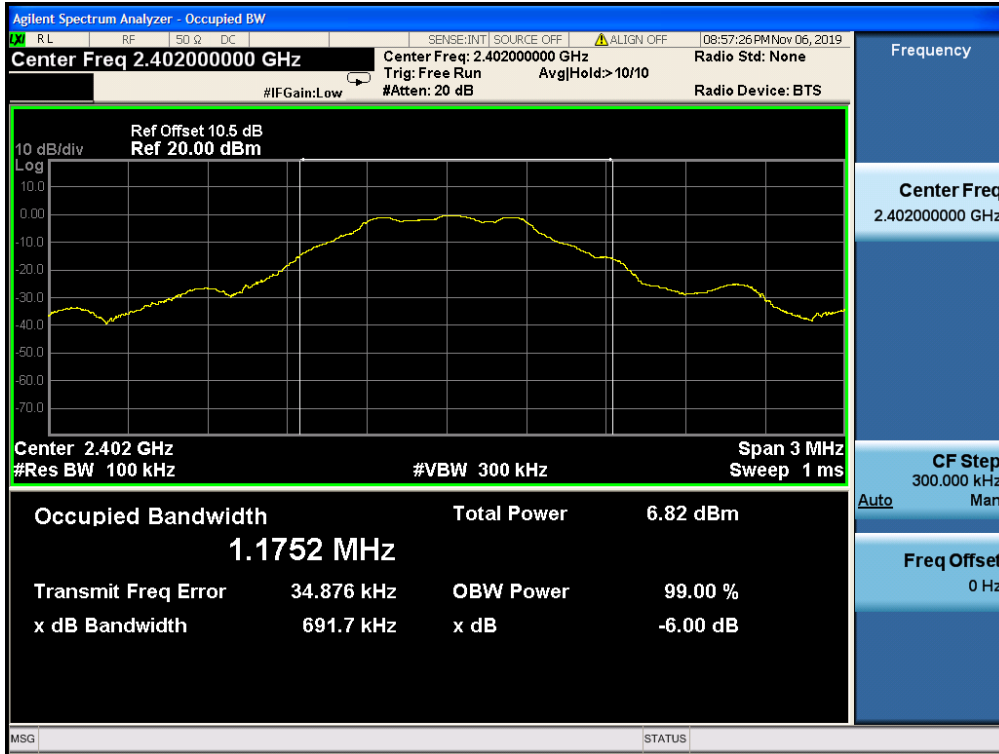

Middle Channel

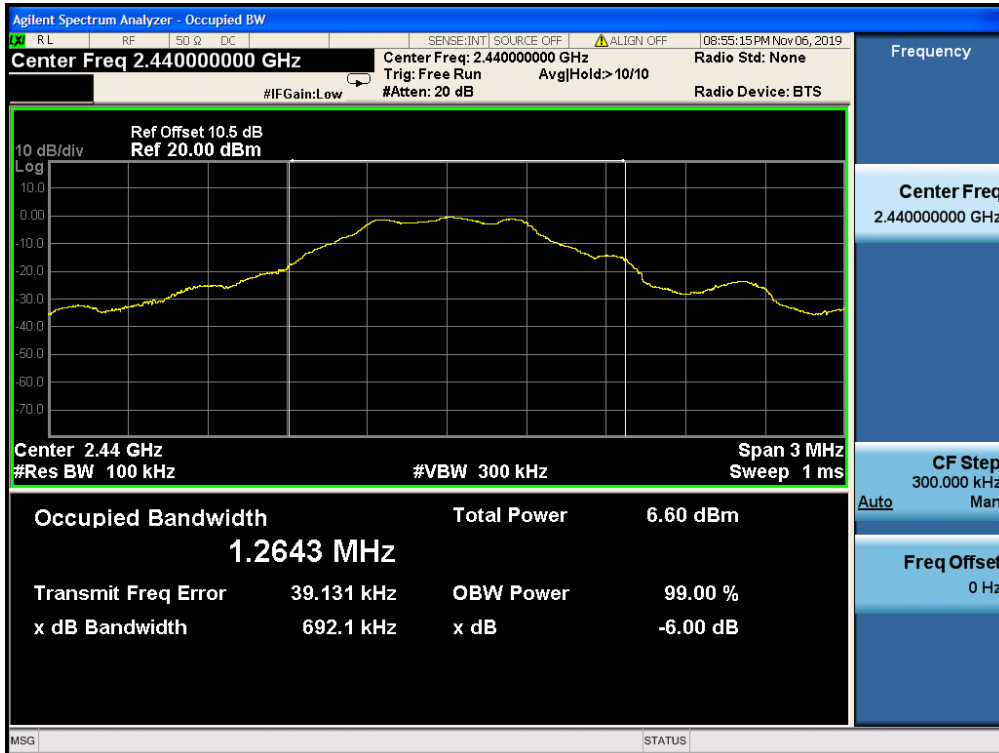

TEST REPORT

PLOTS OF 6dB RF BANDWIDTH

Highest Channel

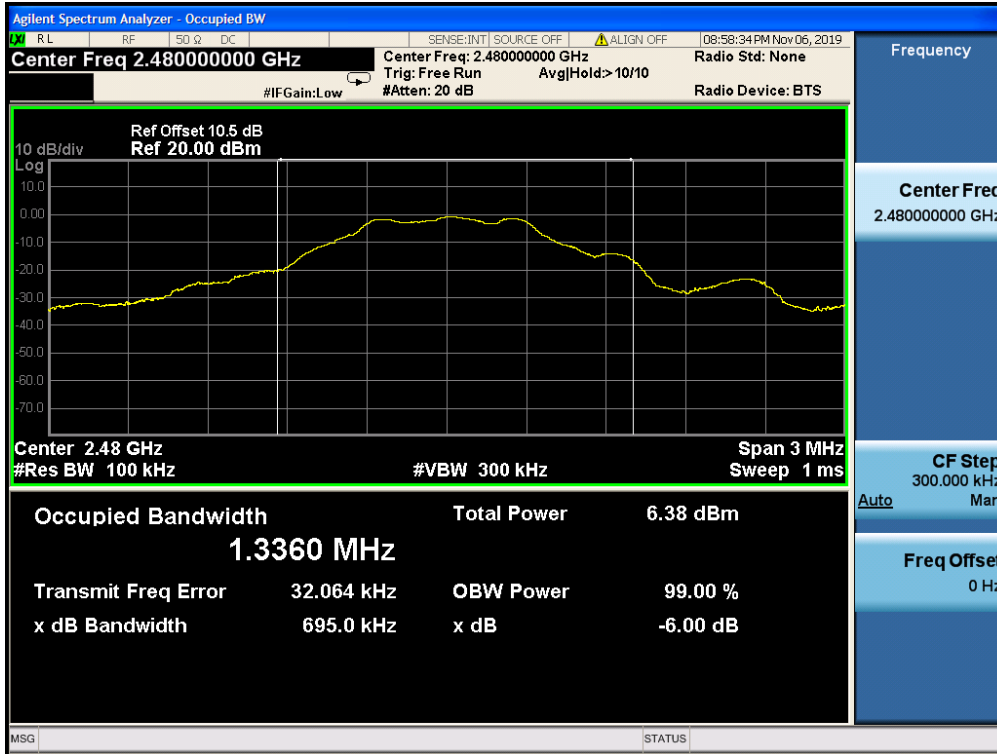

TEST REPORT

4.3 Maximum Power Spectral Density

Antenna output of the EUT was coupled directly to spectrum analyzer. The measurement procedure 11.10 PKPSD was used. If an external attenuator and/or cable was used, these losses are compensated for using the OFFSET function of the analyser.

BLE (GFSK)

Frequency (MHz)	PSD (dBm) @ 3kHz RBW
Low Channel: 2402	-13.813
Middle Channel: 2440	-14.037
High Channel: 2480	-14.480

Cable Loss: 0.5 dB

Limit:
8dBm

The plots of power spectral density are as below.

TEST REPORT

PLOTS OF POWER SPECTRAL DENSITY

Lowest channel



Middle channel



TEST REPORT

PLOTS OF POWER SPECTRAL DENSITY

Highest channel



TEST REPORT

4.4 Out of Band Conducted Emissions

For BLE, the maximum conducted (peak) output power was used to demonstrate compliance as described in 9.1. Then the display line (in red) shown in the following plots denotes the limit at 20dB below maximum measured in-band peak PSD level in 100 KHz bandwidth for BLE.

The measurement procedures under sections 11 of ANSI C63.10-2013 were used.

Furthermore, delta measurement technique for measuring bandedge emissions was incorporated in the test of the edge at 2483.5MHz.

Limits:

All spurious emission and up to the tenth harmonic was measured and they were found to be at least for BLE below the maximum measured in-band peak PSD level.

TEST REPORT

PLOTS OF OUT OF BAND CONDUCTED EMISSIONS

Lowest Channel, Plot A

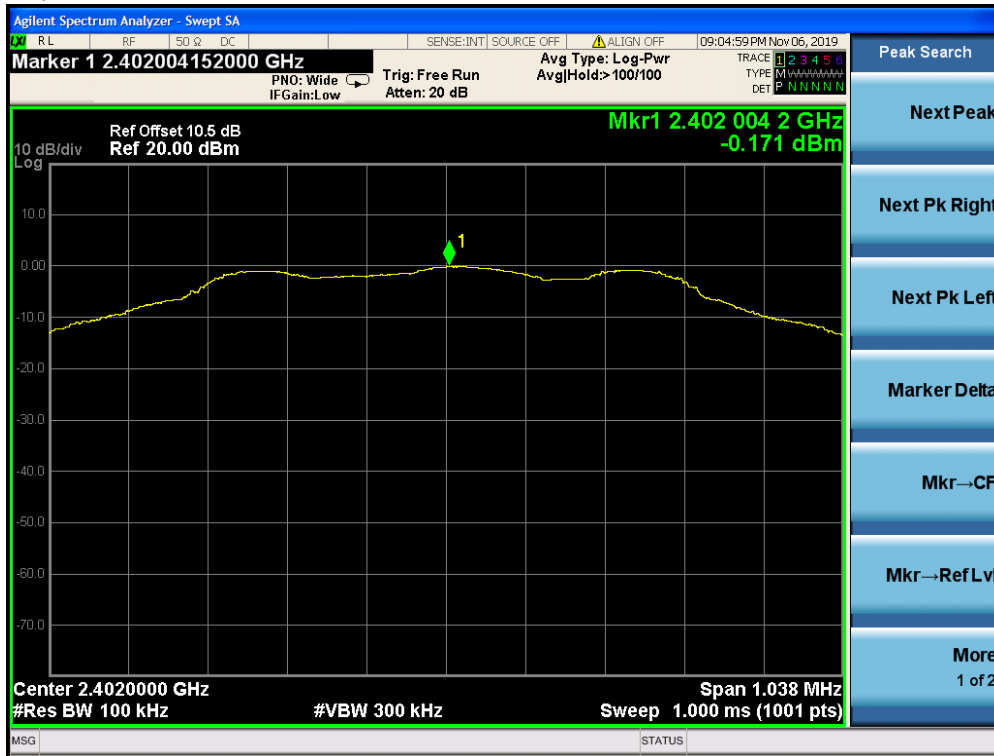

Lowest Channel, Plot B

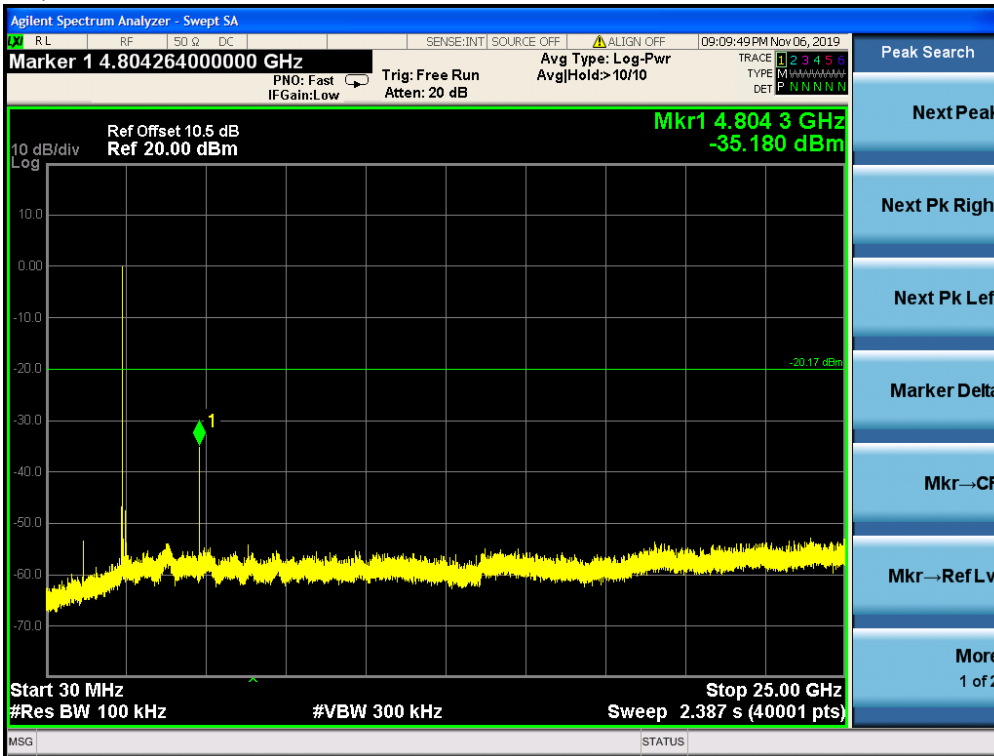

TEST REPORT

PLOTS OF OUT OF BAND CONDUCTED EMISSIONS

Lowest Channel, Bandedge



TEST REPORT

PLOTS OF OUT OF BAND CONDUCTED EMISSIONS

Middle Channel, Plot A



Middle Channel, Plot B

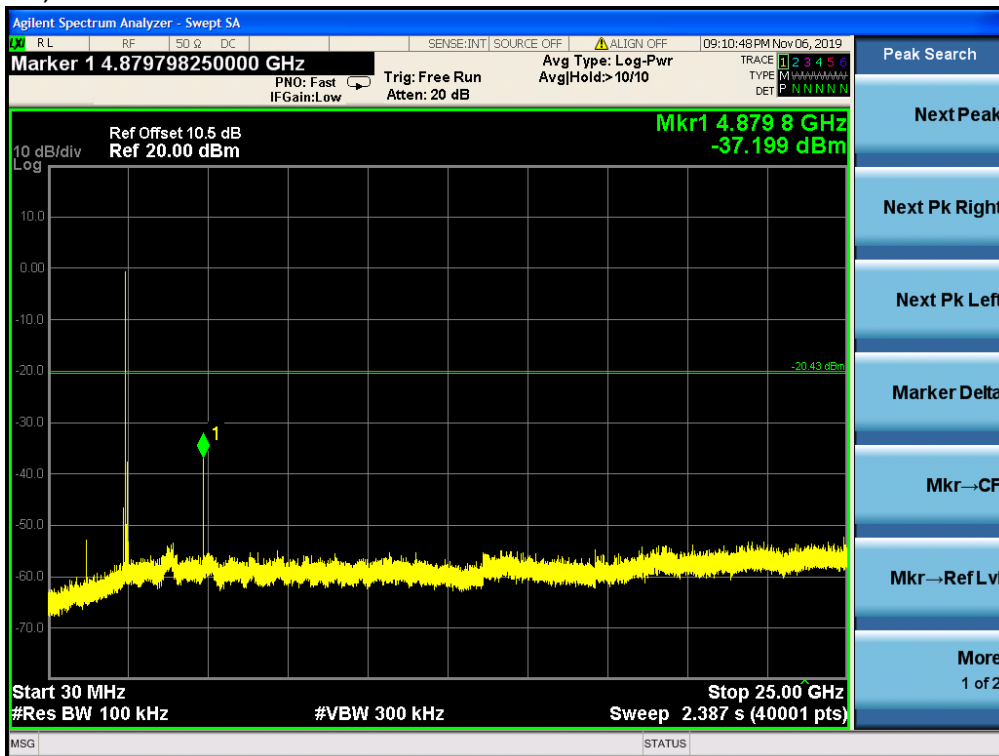

TEST REPORT

PLOTS OF OUT OF BAND CONDUCTED EMISSIONS

Highest Channel, Plot A

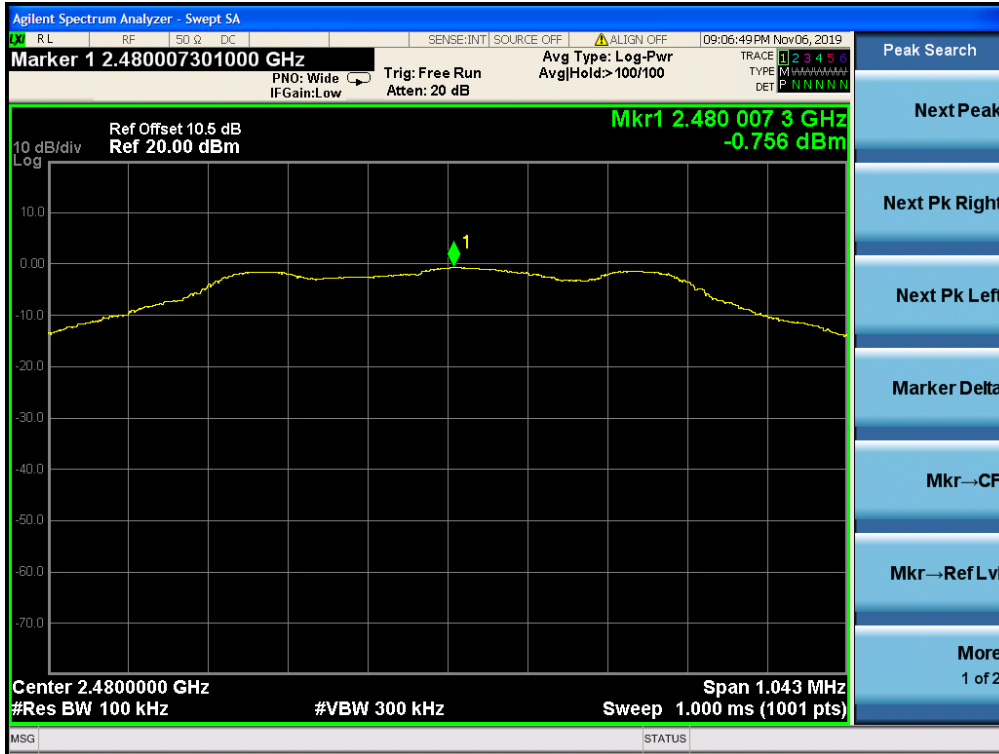

Highest Channel, Plot B

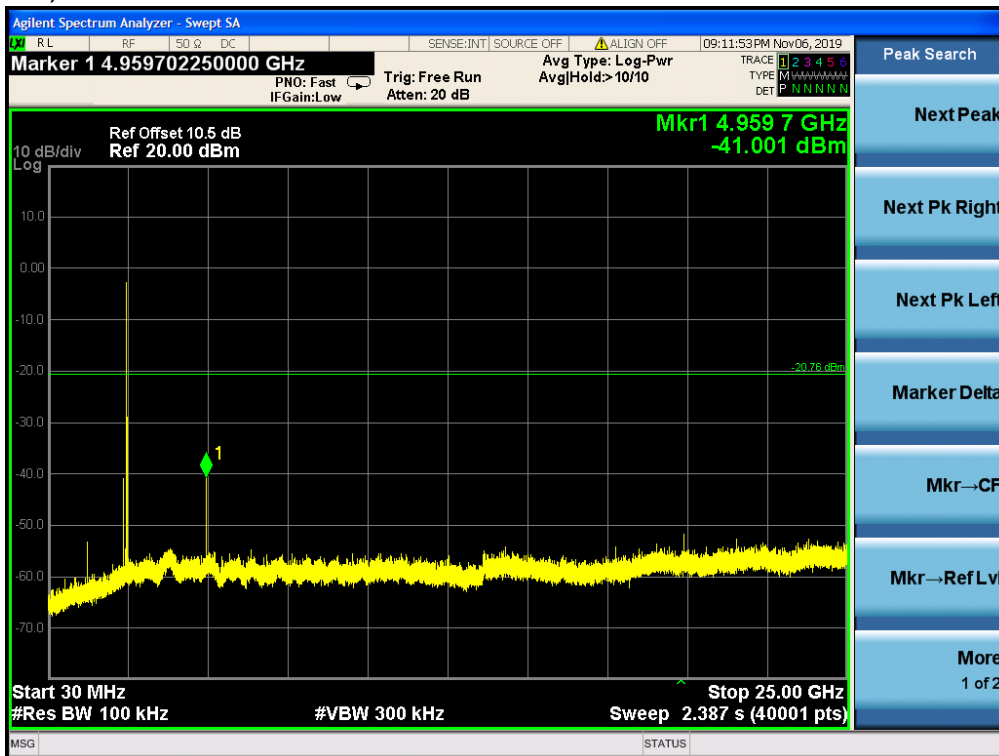

TEST REPORT

PLOTS OF OUT OF BAND CONDUCTED EMISSIONS

Highest Channel, Bandedge



TEST REPORT

4.5 Field Strength Calculation

The field strength is calculated by adding the reading on the Spectrum Analyzer to the factors associated with preamplifiers (if any), antennas, cables, pulse desensitization and average factors (when specified limit is in average and measurements are made with peak detectors). A sample calculation is included below.

$$FS = RA + AF + CF - AG + PD + AV$$

Where FS = Field Strength in dB μ V/m

RA = Receiver Amplitude (including preamplifier) in dB μ V

CF = Cable Attenuation Factor in dB

AF = Antenna Factor in dB

AG = Amplifier Gain in dB

PD = Pulse Desensitization in dB

AV = Average Factor in -dB

In the radiated emission table which follows, the reading shown on the data table may reflect the preamplifier gain. An example of the calculations, where the reading does not reflect the preamplifier gain, follows:

$$FS = RA + AF + CF - AG + PD + AV$$

Example

Assume a receiver reading of 62.0 dB μ V is obtained. The antenna factor of 7.4 dB and cable factor of 1.6 dB is added. The amplifier gain of 29.0 dB is subtracted. The pulse desensitization factor of the spectrum analyzer is 0.0 dB, and the resultant average factor is -10.0 dB. The net field strength for comparison to the appropriate emission limit is 32.0 dB μ V/m. This value in dB μ V/m is converted to its corresponding level in μ V/m.

$$RA = 62.0 \text{ dB}\mu\text{V}$$

$$AF = 7.4 \text{ dB}$$

$$CF = 1.6 \text{ dB}$$

$$AG = 29.0 \text{ dB}$$

$$PD = 0.0 \text{ dB}$$

$$AV = -10 \text{ dB}$$

$$FS = 62.0 + 7.4 + 1.6 - 29.0 + 0.0 + (-10.0) = 32.0 \text{ dB}\mu\text{V/m}$$

$$\text{Level in } \mu\text{V/m} = \text{Common Antilogarithm } [(32.0 \text{ dB}\mu\text{V/m})/20] = 39.8 \mu\text{V/m}$$

TEST REPORT

4.6 Transmitter Radiated Emissions in Restricted Bands and Spurious Emissions

Data is included of the worst case configuration (the configuration which resulted in the highest emission levels). A sample calculation, configuration photographs and data tables of the emissions are included.

The data on the following pages list the significant emission frequencies, the limit and the margin of compliance.

4.6.1 Radiated Emission Configuration Photograph

Worst Case Restricted Band Radiated Emission
at

4960.000 MHz

The worst case radiated emission configuration photographs are saved with filename: config photos.pdf

4.6.2 Radiated Emission Data

The data in tables 1-2 list the significant emission frequencies, the limit and the margin of compliance.

Judgement -

Passed by 15.6 dB margin

TEST REPORT

RADIATED EMISSION DATA

Mode: BLE Transmitting

Table 1
BLE (GFSK)

Radiated Emission Test Data (Above 1GHz):
Lowest Channel:

No.	Frequency (MHz)	Reading (dBuV/m)	Correction factor (dB)	Result (dBuV/m)	Limit (dBuV/m)	Margin (dB)	Detector	Antenna Polaxis
1	4804.00	46.54	3.93	50.47	74.00	-23.53	Peak	Horizontal
2	4804.00	28.80	3.93	32.73	54.00	-21.27	Average	Horizontal
3	7206.00	43.85	6.76	50.61	74.00	-23.39	Peak	Horizontal
4	7206.00	28.90	6.76	35.66	54.00	-18.34	Average	Horizontal
5	4804.00	49.16	4.93	54.09	74.00	-19.91	Peak	Vertical
6	4804.00	32.55	4.93	37.48	54.00	-16.52	Average	Vertical
7	7206.00	47.00	6.34	53.34	74.00	-20.66	Peak	Vertical
8	7206.00	31.05	6.34	37.39	54.00	-16.61	Average	Vertical

Middle Channel:

No.	Frequency (MHz)	Reading (dBuV/m)	Correction factor (dB)	Result (dBuV/m)	Limit (dBuV/m)	Margin (dB)	Detector	Antenna Polaxis
1	4880.00	49.86	4.00	53.86	74.00	-20.14	Peak	Horizontal
2	4880.00	30.48	4.00	34.48	54.00	-19.52	Average	Horizontal
3	7320.00	41.11	6.98	48.09	74.00	-25.91	Peak	Horizontal
4	7320.00	28.54	6.98	35.52	54.00	-18.48	Average	Horizontal
5	4880.00	49.72	5.00	54.72	74.00	-19.28	Peak	Vertical
6	4880.00	32.66	5.00	37.66	54.00	-16.34	Average	Vertical
7	7320.00	44.83	6.48	51.31	74.00	-22.69	Peak	Vertical
8	7320.00	30.52	6.48	37.00	54.00	-17.00	Average	Vertical

Highest Channel:

No.	Frequency (MHz)	Reading (dBuV/m)	Correction factor (dB)	Result (dBuV/m)	Limit (dBuV/m)	Margin (dB)	Detector	Antenna Polaxis
1	4960.00	48.34	4.06	52.40	74.00	-21.60	Peak	Horizontal
2	4960.00	31.69	4.06	35.75	54.00	-18.25	Average	Horizontal
3	7440.00	41.95	7.19	49.14	74.00	-24.86	Peak	Horizontal
4	7440.00	29.79	7.19	36.98	54.00	-17.02	Average	Horizontal
5	4960.00	49.47	5.06	54.53	74.00	-19.47	Peak	Vertical
6	4960.00	33.30	5.06	38.36	54.00	-15.64	Average	Vertical
7	7440.00	43.41	6.63	50.04	74.00	-23.96	Peak	Vertical
8	7440.00	30.81	6.63	37.44	54.00	-16.56	Average	Vertical

Remark: There were no emissions found above system measuring level (at least 20 dB below the limit)

TEST REPORT

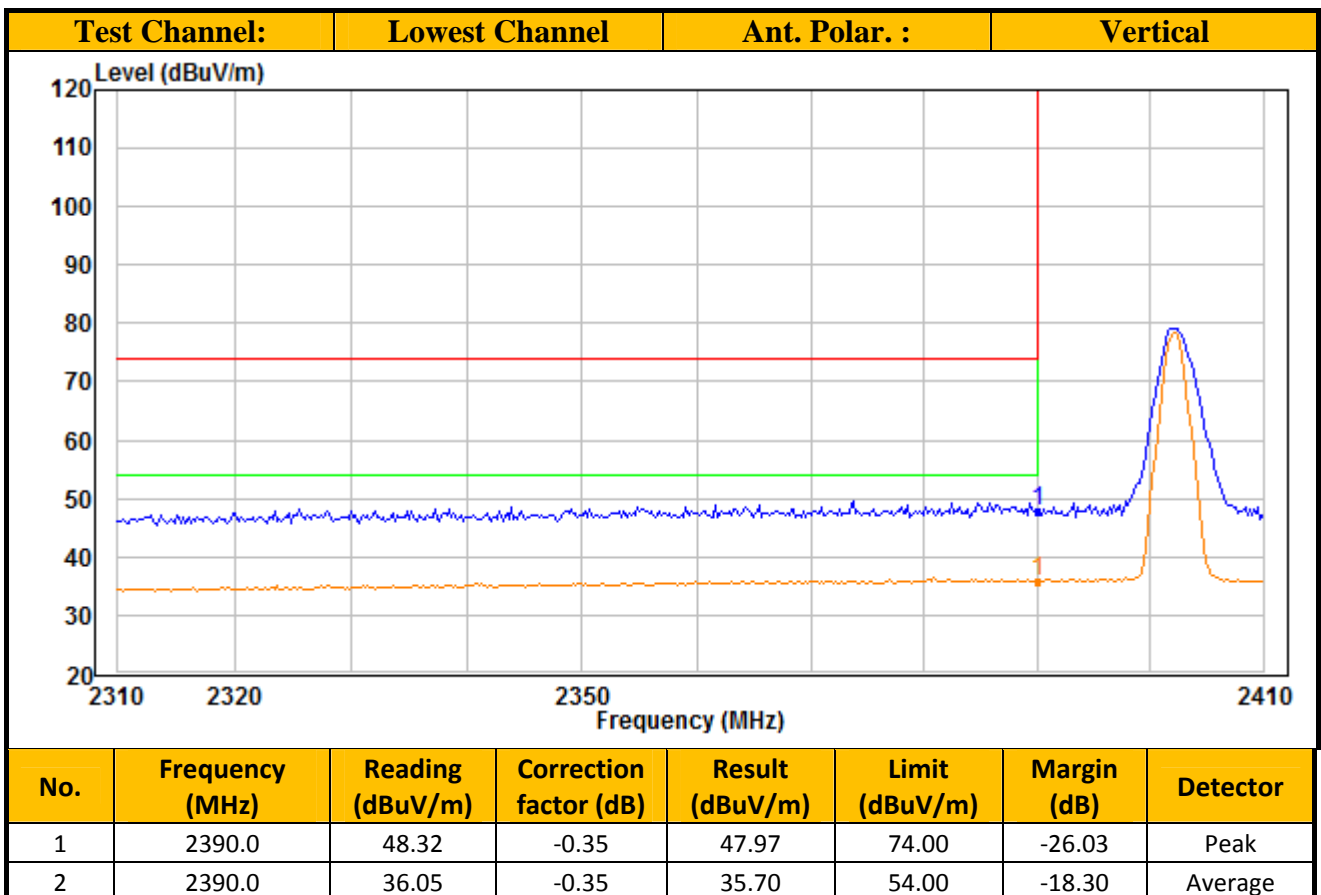
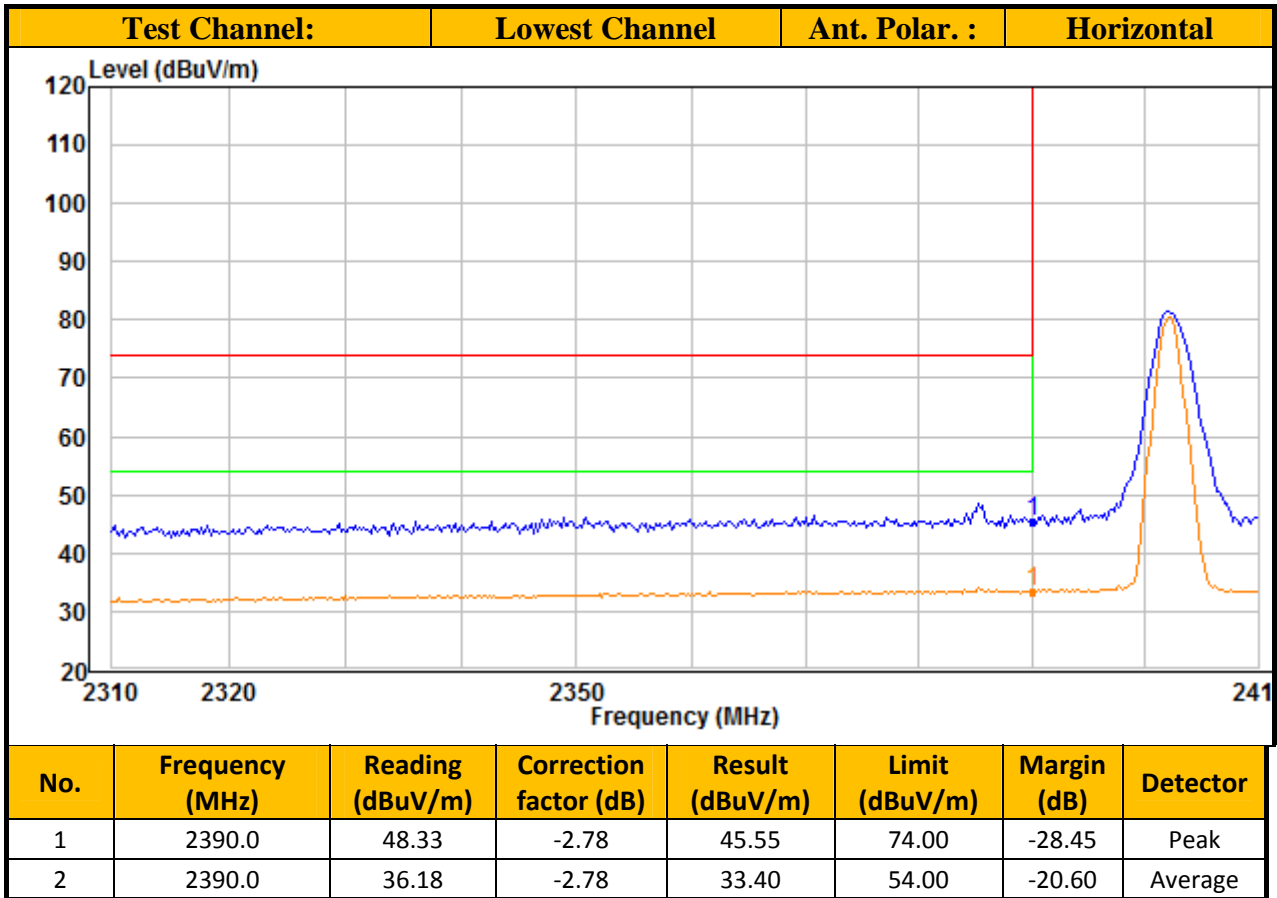

TEST REPORT

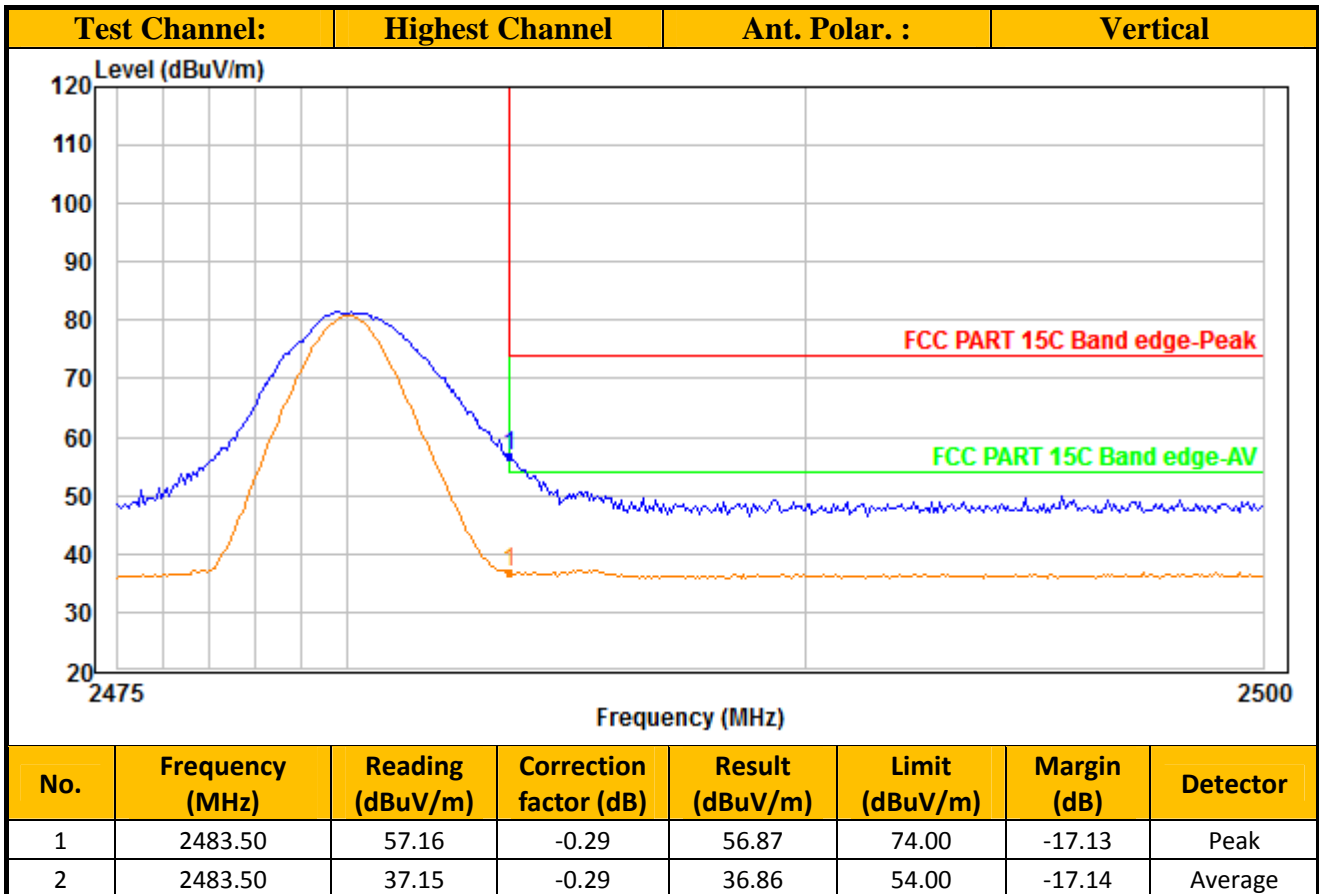
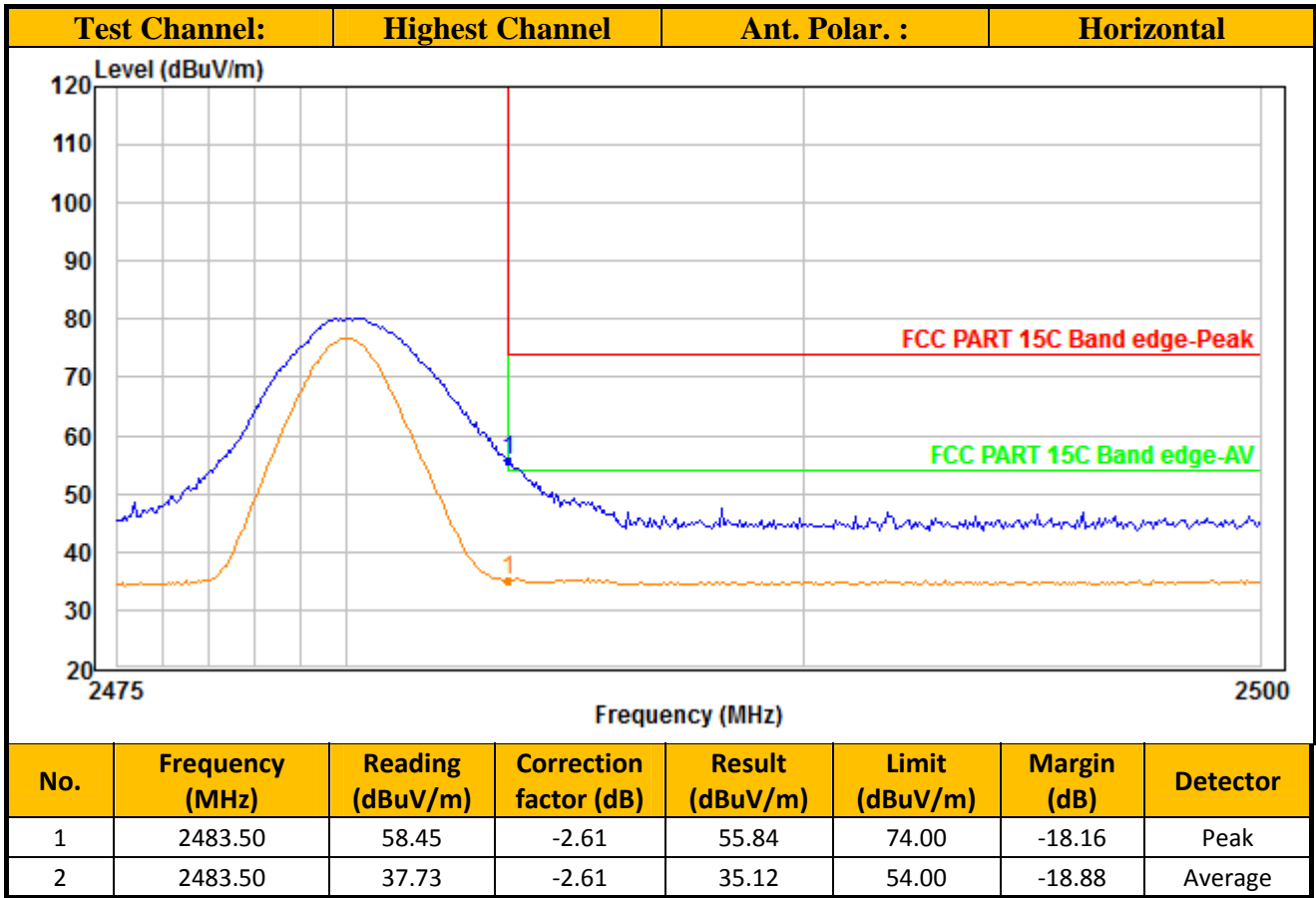

TEST REPORT

- NOTES:
1. Peak detector is used for the emission measurement.
 2. Average measurement is according to C63.10 (2013).
 3. All measurements were made at 3 meters. Radiated emissions not detected at the 3-meter distance were measured at 0.3-meter and an inverse proportional extrapolation was performed to compare the signal level to the 3-meter limit. No other radiated emissions than those reported were detected at a test distance of 0.3-meter.
 4. Negative value in the margin column shows emission below limit.
 5. Horn antenna is used for the emission over 1000MHz.
 6. Emission within the restricted band meets the requirement of FCC Part 15 Section 15.205.

TEST REPORT

Mode: BLE Operating

Table 2
BLE (GFSK)

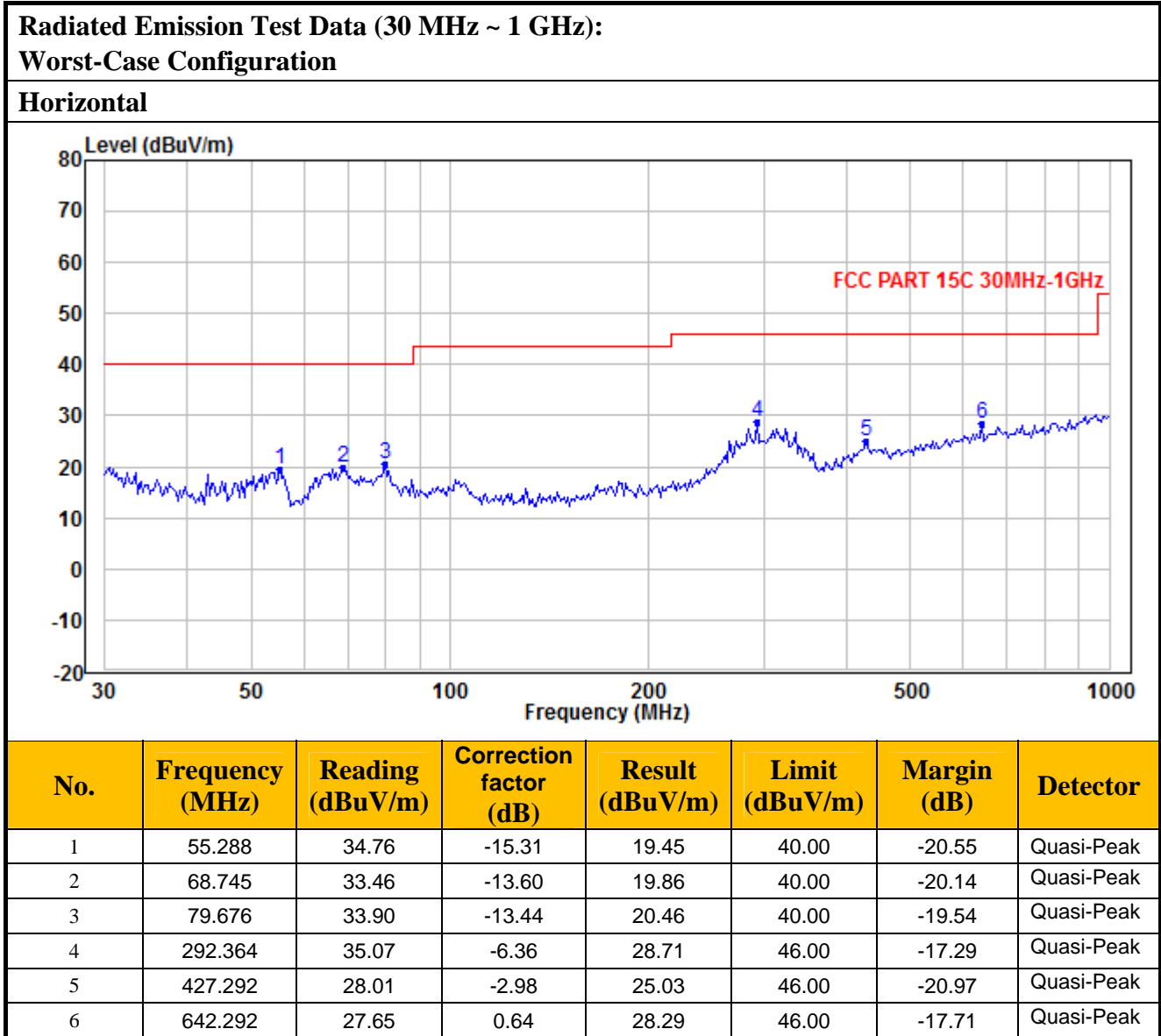

TEST REPORT

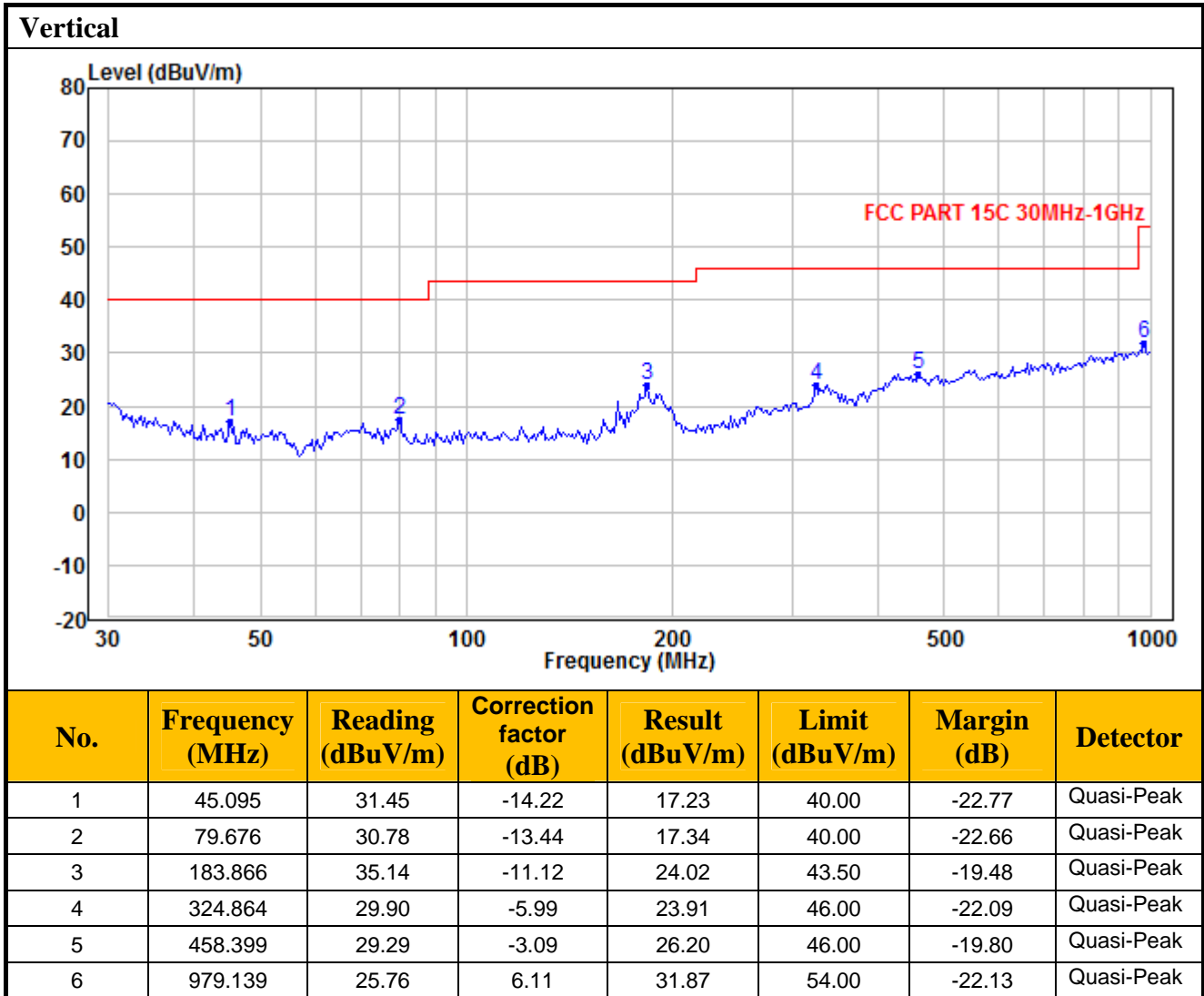

- NOTES:
1. Quasi-Peak detector is used for the emission measurement.
 2. Average detector is used for the average data of emission measurement
 3. All measurements were made at 3 meters. Radiated emissions not detected at the 3-meter distance were measured at 0.3-meter and an inverse proportional extrapolation was performed to compare the signal level to the 3-meter limit. No other radiated emissions than those reported were detected at a test distance of 0.3-meter.
 4. Negative value in the margin column shows emission below limit.
 5. Horn antenna is used for the emission over 1000MHz.
 6. Emission within the restricted band meets the requirement of FCC Part 15 Section 15.205.

TEST REPORT

4.6.3 Radiated Emission Test Setup

The figure below shows the test setup, which is utilized to make these measurements.

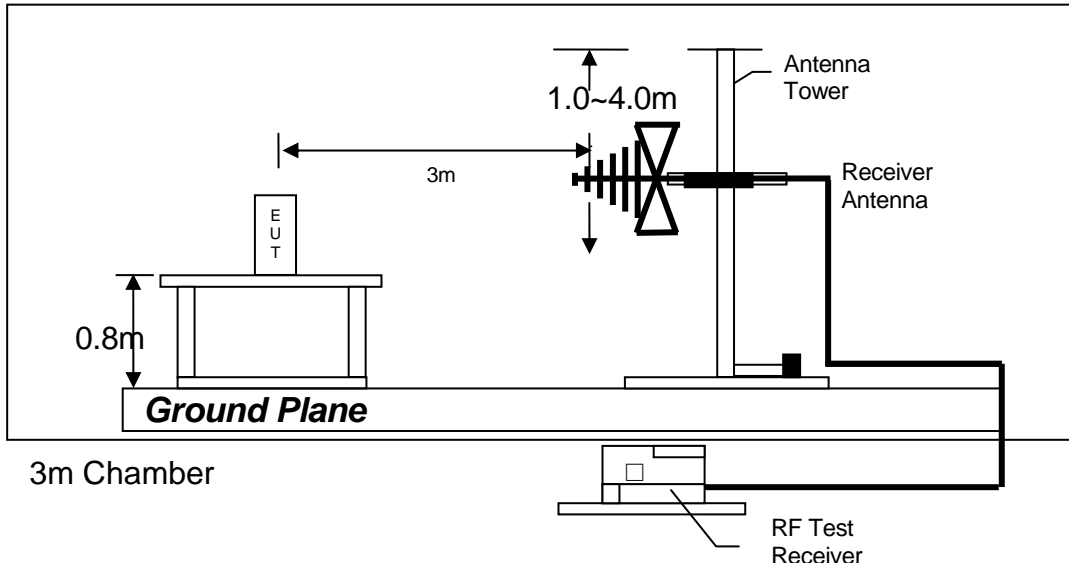

Test setup of radiated emissions up to 1GHz

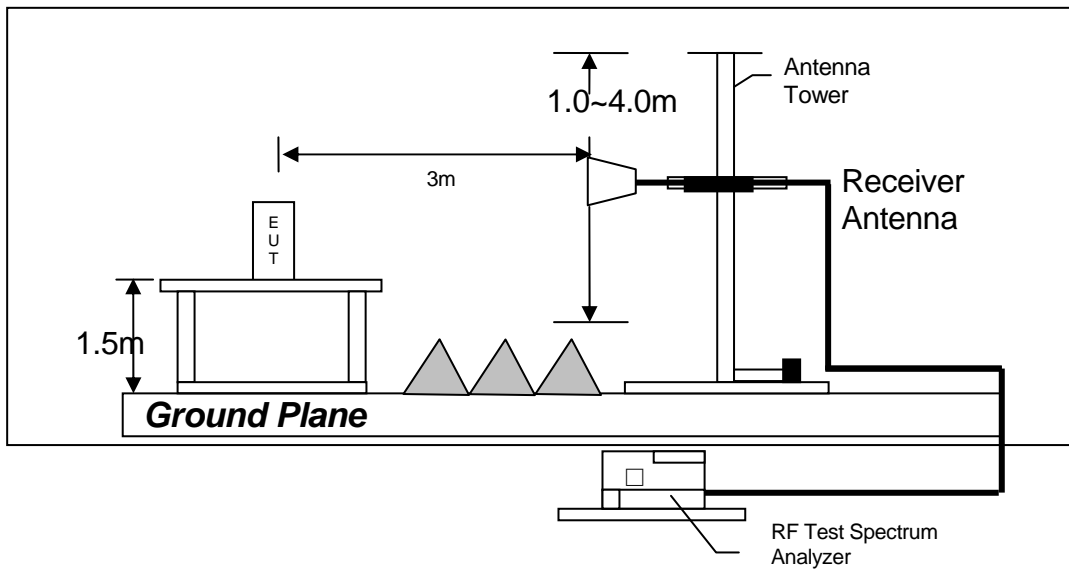

Test setup of radiated emissions above 1GHz

TEST REPORT

4.6.4 Transmitter Duty Cycle Calculation

Not applicable – No average factor is required.

TEST REPORT

4.7 AC Power Line Conducted Emission

- Not applicable – EUT is only powered by battery for operation.
- EUT connects to AC power line. Emission Data is listed in following pages.

- Base Unit connects to AC power line and has transmission. Handset connects to AC power line but has no transmission. Emission Data of Base Unit is listed in following pages.

4.7.1 AC Power Line Conducted Emission Configuration Photograph

Worst Case Line-Conducted Configuration
at

21.297 kHz

The worst case line conducted configuration photographs are attached in the Appendix and saved with filename: config photos.pdf

4.7.2 AC Power Line Conducted Emission Data

The plot(s) and data in the following pages list the significant emission frequencies, the limit and the margin of compliance.

Passed by 9.1 dB margin

TEST REPORT

AC POWER LINE CONDUCTED EMISSION

Worst Case: BLE Operating

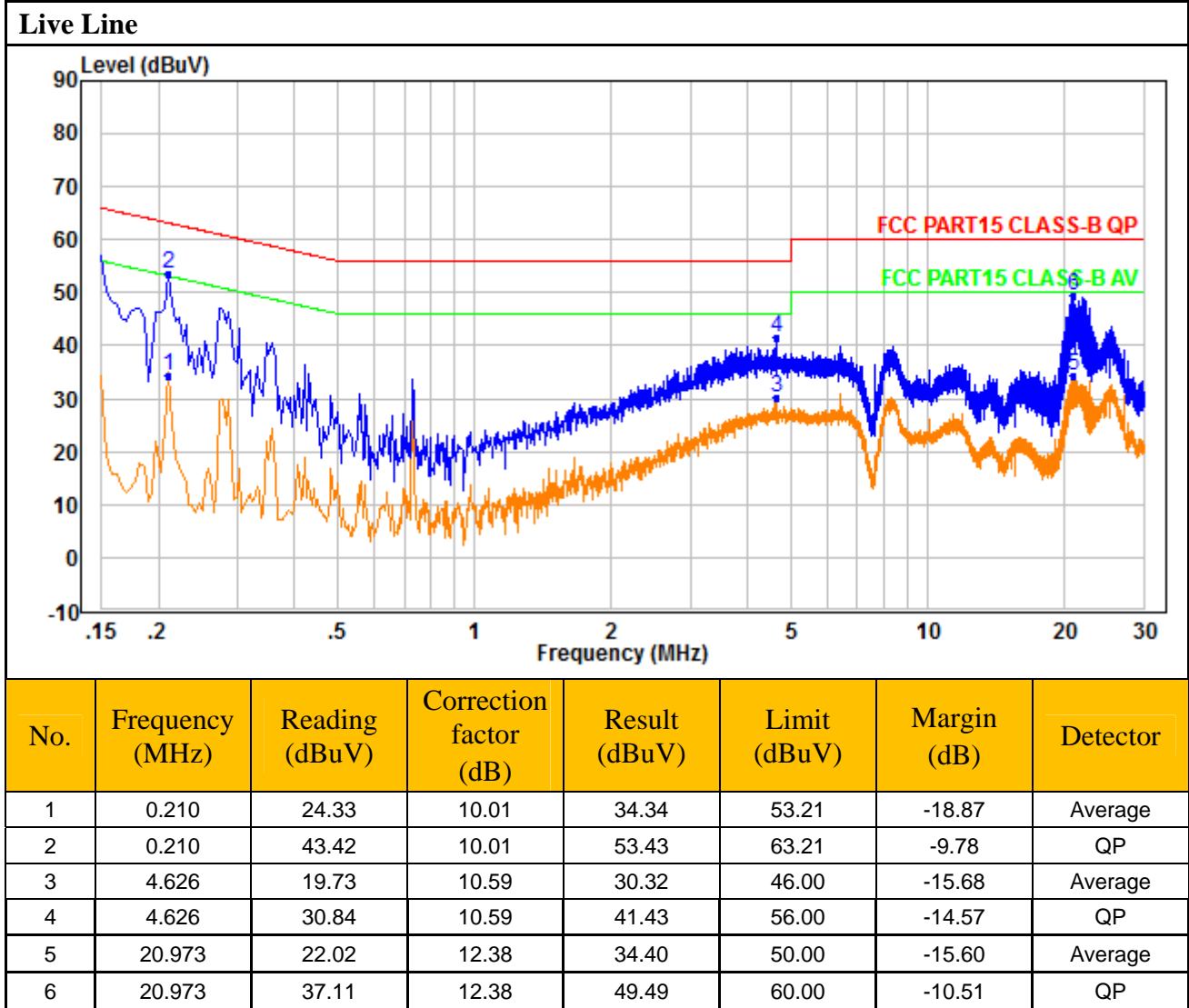

TEST REPORT

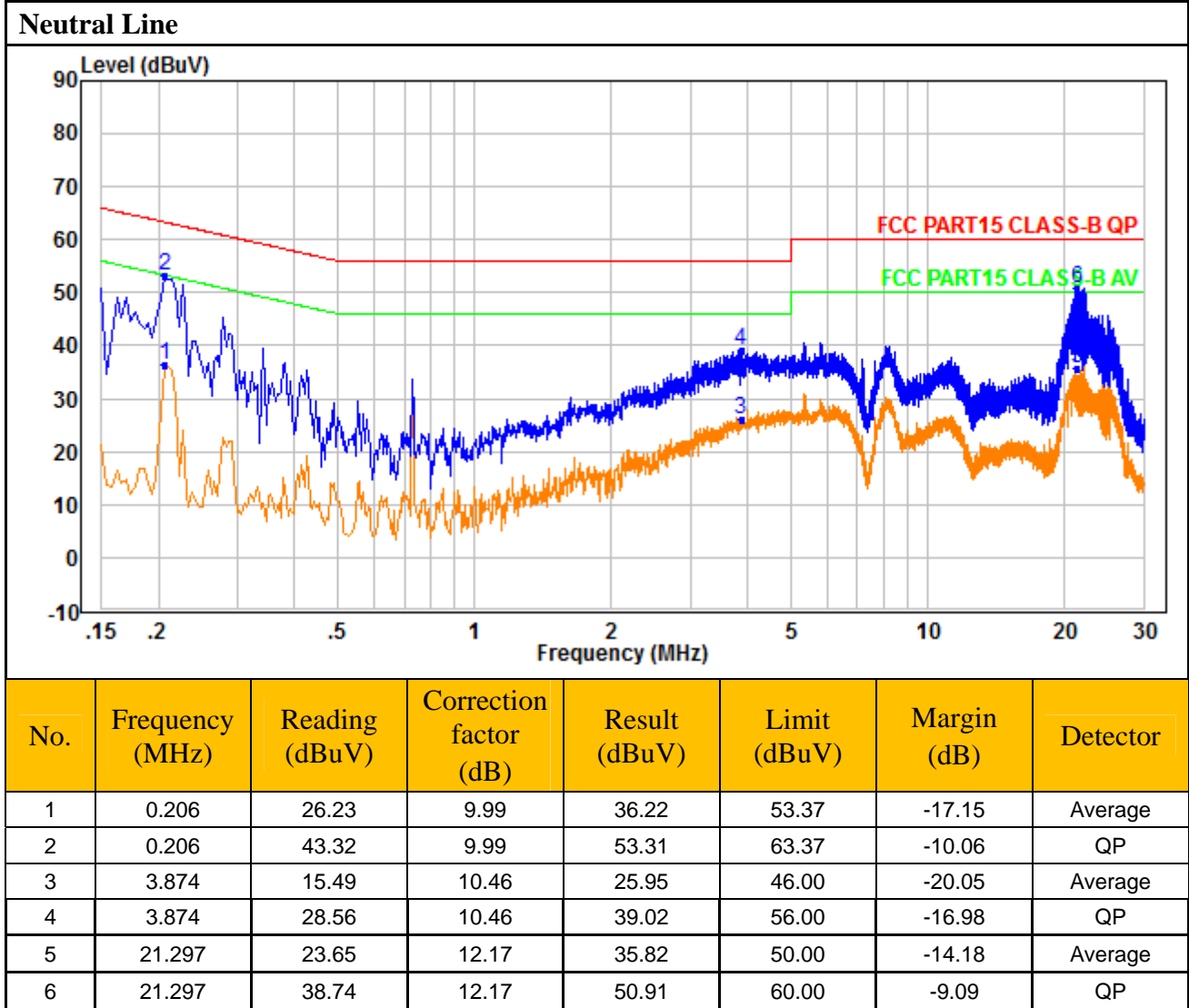

TEST REPORT

4.7.3 Conducted Emission Test Setup

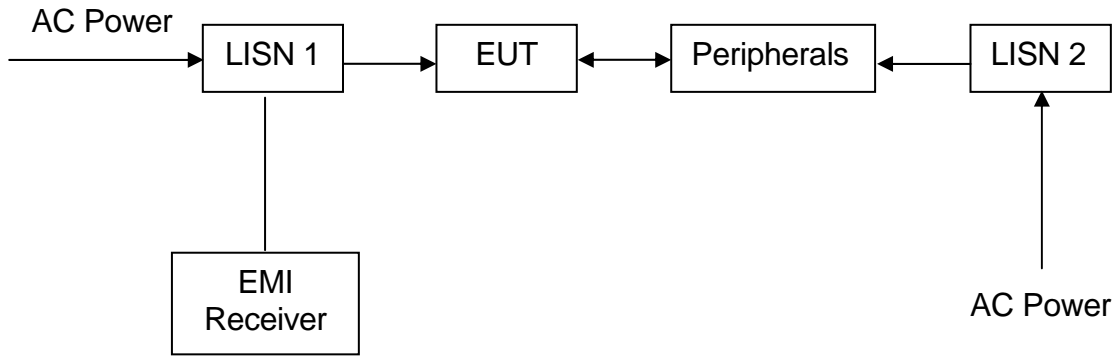

TEST REPORT

5.0 EQUIPMENT LIST

1) Radiated Emissions Test

Equipment	3M Chamber & Accessory Equipment	Receiver	Loop Antenna
Equipment No..	UTTL—E010	UTTL—E026	UTTL—E013
Manufacturer	ETS-LINDGREN	R&S	ETS-LINDGREN
Model No.	3M	ESIB26	6502
Calibration Date	December 03, 2018	November 24, 2018	December 03, 2018
Calibration Due Date	December 03, 2021	November 24, 2019	December 03, 2019

Equipment	Broadband Antenna	6dB Attenuator	Preamplifier
Equipment No..	UTTL—E014	UTTL—E056	UTTL—E043
Manufacturer	ETS-LINDGREN	Talent	HP
Model No.	3142E	RA6A5-N-18	8447F
Calibration Date	December 08, 2018	December 08, 2018	November 24, 2018
Calibration Due Date	December 08, 2019	December 08, 2019	November 24, 2019

Equipment	Horn Antenna (Pre-amplifier)
Equipment No..	UTTL—E017
Manufacturer	ETS-LINDGREN
Model No.	3117-PA
Calibration Date	May 22, 2019
Calibration Due Date	May 22, 2020

2) Conducted Emissions Test

Equipment	Receiver	Pulse Limiter	LISN
Equipment No..	UTTL—E005	UTTL—E007	UTTL—E003
Manufacturer	R&S	R&S	R&S
Model No.	ESR7	ESH3-Z2	ESH2-Z5
Calibration Date	November 24, 2018	November 24, 2018	November 24, 2018
Calibration Due Date	November 24, 2019	November 24, 2019	November 24, 2019

3) Conductive Measurement Test

Equipment	EXA Spectrum Analyzer	USB Wideband Power Sensor
Equipment No..	UTTL—E032	UTTL—E033
Manufacturer	KEYSIGHT	KEYSIGHT
Model No.	N9010A	U2021XA
Calibration Date	November 24, 2018	November 24, 2018
Calibration Due Date	November 24, 2019	November 24, 2019

END OF TEST REPORT