

FCC PART 22/24 TEST REPORT

FCC Part 22 / Part 24

Report Reference No. : LCS191205004AEE

FCC ID..... : 2AUMJEV-07BX-LTE

Date of Issue. : December 23, 2019

Testing Laboratory Name: Shenzhen LCS Compliance Testing Laboratory Ltd.

Address..... : 1/F., Xingyuan Industrial Park, Tongda Road, Bao'an Avenue, Bao'an District, Shenzhen, Guangdong, China

Applicant's name: Shenzhen Eview GPS Technology

Address..... : #1203 Building 2, GuoLe Technology Park, Lirong Road, Dalang, Longhua, Shenzhen, China

Test specification :

Standard : **FCC Part 22: Public Mobile Services**
FCC Part 24: Personal Communication Services

Test Report Form No: LCSEMC-1.0

TRF Originator: Shenzhen LCS Compliance Testing Laboratory Ltd.

Master TRF: Dated 2011-03

Shenzhen LCS Compliance Testing Laboratory Ltd. All rights reserved.

This publication may be reproduced in whole or in part for non-commercial purposes as long as the Shenzhen LCS Compliance Testing Laboratory Ltd. is acknowledged as copyright owner and source of the material. Shenzhen LCS Compliance Testing Laboratory Ltd. takes no responsibility for and will not assume liability for damages resulting from the reader's interpretation of the reproduced material due to its placement and context.

Test item description : **Personal Mobile Alarm System**

Trade Mark: N/A

Test Model: EV-07BX-LTE

Listed Models: N/A

Ratings..... : DC 3.7V by Li-ion battery(800mAh)
 Recharged by DC 5V

Modulation: QPSK

Hardware version.....: EV07B_LTE_V2.0

Software version: V1.0.7.33

Frequency: UMTS Band II / UMTS Band V

Result.....: **PASS**

Compiled by:

Supervised by:

Approved by:

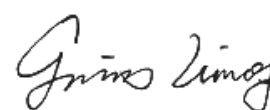
Linda He / Administrators

Jin Wang/ Technique principal

Gavin Liang/ Manager

TEST REPORT

Test Report No. :	LCS191205004AEE	December 23, 2019
		Date of issue

Equipment under Test : Personal Mobile Alarm System

Test Model : EV-07BX-LTE

Listed Models : N/A

Model Declaration : N/A

Applicant : **Shenzhen Eview GPS Technology**

Address : #1203 Building 2, GuoLe Technology Park, Lirong Road, Dalang,
Longhua, Shenzhen, China

Manufacturer : **Shenzhen Eview GPS Technology**

Address : #1203 Building 2, GuoLe Technology Park, Lirong Road, Dalang,
Longhua, Shenzhen, China

Factory : **Shenzhen Eview GPS Technology**

Address : #1203 Building 2, GuoLe Technology Park, Lirong Road, Dalang,
Longhua, Shenzhen, China

Test Result:	PASS
---------------------	-------------

The test report merely corresponds to the test sample.
It is not permitted to copy extracts of these test result without the written permission of the test laboratory.

Revision History

Revision	Issue Date	Revisions	Revised By
000	December 23, 2019	Initial Issue	Gavin Liang

Contents

<u>1</u>	<u>TEST STANDARDS.....</u>	<u>5</u>
<u>2</u>	<u>SUMMARY.....</u>	<u>6</u>
2.1	General Remarks	6
2.2	Product Description	6
2.3	Equipment under Test	7
2.4	Short description of the Equipment under Test (EUT)	7
2.5	Internal Identification of AE used during the test	7
2.6	Normal Accessory setting	7
2.7	EUT configuration	8
2.8	Related Submittal(s) / Grant (s)	8
2.9	Modifications	8
2.10	General Test Conditions/Configurations	8
<u>3</u>	<u>TEST ENVIRONMENT.....</u>	<u>9</u>
3.1	Address of the test laboratory	9
3.2	Test Facility	9
3.3	Environmental conditions	9
3.4	Test Description	9
3.5	Equipments Used during the Test	11
3.6	Measurement uncertainty	12
<u>4</u>	<u>TEST CONDITIONS AND RESULTS.....</u>	<u>13</u>
4.1	Output Power	13
4.2	Radiated Spurious Emssion	16
4.3	Occupied Bandwidth and Emission Bandwith	20
4.4	Band Edge Compliance	22
4.5	Spurious Emssion on Antenna Port	24
4.6	Frequency Stability Test	30
4.7	Peak-to-Average Ratio (PAR)	32
<u>5</u>	<u>TEST SETUP PHOTOS OF THE EUT.....</u>	<u>34</u>
<u>6</u>	<u>EXTERNAL PHOTOS OF THE EUT.....</u>	<u>34</u>
<u>7</u>	<u>INTERNAL PHOTOS OF THE EUT.....</u>	<u>34</u>

1 TEST STANDARDS

The tests were performed according to following standards:

[FCC Part 22 \(10-1-16 Edition\)](#): Private Land Mobile Radio Services.

[FCC Part 24\(10-1-16 Edition\)](#): Public Mobile Services.

[FCC Part 27\(10-1-16 Edition\)](#): Public Mobile Services.

[TIA-603-E March 2016](#): Land Mobile FM or PM Communications Equipment Measurement and Performance Standards.

[47 CFR FCC Part 15 Subpart B](#): Unintentional Radiators.

[FCC Part 2](#): Frequency Allocations And Radio Treaty Matters: General Rules And Regulations.

[ANSI C63.26-2015](#) American National Standard for Compliance Testing of Transmitters Used in Licensed Radio Services.

[FCCKDB971168D01](#) Power Meas License Digital Systems

2 SUMMARY

2.1 General Remarks

Date of receipt of test sample	:	December 09, 2019
Testing commenced on	:	December 09, 2019
Testing concluded on	:	December 23, 2019

2.2 Product Description

The **Shenzhen Eview GPS Technology**'s Model: EV-07BX-LTE or the "EUT" as referred to in this report; more general information as follows, for more details, refer to the user's manual of the EUT.

Name of EUT	Personal Mobile Alarm System
Test Model	EV-07BX-LTE
Modulation Type	QPSK, 16QAM for LTE
Antenna Gain	0.9dBi for WCDMA Band II; -0.3dBi for WCDMA Band V; 0.9dBi for LTE Band 2; 0.7dBi for LTE Band 4; -3.0dBi for LTE Band 12; -0.87dBi (max.) for BT and WLAN
Hardware version	EV07B_LTE_V2.0
Software version	V1.0.7.33
GSM/EDGE/GPRS Operation Frequency Band	Not Supported
UMTS Operation Frequency Band	UMTS FDD Band II / V
LTE Operation Frequency Band	LTE FDD band 2, 4, 12
GSM/EDGE/GPRS	Not Supported
GSM Release Version	Not Supported
GSM/EDGE/GPRS Power Class	Not Supported
GPRS/EDGE Multislot Class	Not Supported
GPRS operation mode	Not Supported
WCDMA Release Version	R8
HSDPA Release Version	Release 8
HSUPA Release Version	Release 6
DC-HSUPA Release Version	Not Supported
LTE Release Version	R9
LTE/UMTS Power Class	Class 3
WLAN FCC Modulation Type	IEEE 802.11b: DSSS(CCK,DQPSK,DBPSK) IEEE 802.11g/n: OFDM(64QAM, 16QAM, QPSK, BPSK)
WLAN FCC Operation frequency	IEEE 802.11b:2412-2462MHz IEEE 802.11g/n20:2412-2462MHz
Antenna Type	PIFA Antenna
BT Modulation Type	GFSK (BT V4.0)
Extreme temp. Tolerance	-20°C to +55°C
GPS function	Support and only RX
FM function	Not Supported
NFC Function	Not Supported
Extreme vol. Limits	3.40VDC to 4.20VDC (nominal: 3.70VDC)

2.3 Equipment under Test

Power supply system utilised

Power supply voltage	<input type="radio"/> 120V / 60 Hz	<input type="radio"/> 115V / 60Hz
	<input type="radio"/> 12 V DC	<input type="radio"/> 24 V DC
	<input checked="" type="radio"/> Other (specified in blank below) DC 3.70V	

Test frequency list

Test Mode	TX/RX	RF Channel		
		Low(L)	Middle (M)	High (H)
WCDMA Band V	TX	Channel 4132	Channel 4182	Channel 4233
		826.4 MHz	836.4 MHz	846.6 MHz
	RX	Channel 4357	Channel 4407	Channel 4458
		871.4 MHz	881.4 MHz	891.6 MHz
Test Mode	TX/RX	RF Channel		
		Low(L)	Middle (M)	High (H)
WCDMA Band II	TX	Channel 9262	Channel 9400	Channel 9538
		1852.4 MHz	1880.0 MHz	1907.6 MHz
	RX	Channel 9662	Channel 9800	Channel 9938
		1932.4 MHz	1960.0 MHz	1987.6 MHz

2.4 Short description of the Equipment under Test (EUT)

2.4.1 General Description

EV-07BX-LTE is subscriber equipment in the WCDMA/LTE system. The HSPA/UMTS frequency band is Band II/V. LTE frequency band is band 2, band 4, band 12. The Personal Mobile Alarm System implements such functions as RF signal receiving/transmitting, HSPA/UMTS/LTE protocol processing, and etc. Externally it provides SIM card interface.

NOTE: Unless otherwise noted in the report, the functional boards installed in the units shall be selected from the below list, but not means all the functional boards listed below shall be installed in one unit.

2.5 Internal Identification of AE used during the test

AE ID*	Description
AE1	Rechargeable Li-ion Battery
AE2	/

AE2

Model: /

INPUT: /

OUTPUT: /

*AE ID: is used to identify the test sample in the lab internally.

2.6 Normal Accessory setting

Fully charged battery was used during the test.

2.7 EUT configuration

The following peripheral devices and interface cables were connected during the measurement:

● - supplied by the manufacturer

○ - supplied by the lab

<input type="checkbox"/>	Power Cable	Length (m) :	/
		Shield :	/
		Detachable :	/
<input type="checkbox"/>	Multimeter	Manufacturer :	/
		Model No. :	/

2.8 Related Submittal(s) / Grant (s)

This submittal(s) (test report) is intended for **FCC ID: 2AUMJEV-07BX-LTE** filing to comply with FCC Part 22 and Part 24 Rules.

2.9 Modifications

No modifications were implemented to meet testing criteria.

2.10 General Test Conditions/Configurations

2.10.1 Test Modes

NOTE: The test mode(s) are selected according to relevant radio technology specifications.

Test Mode	Test Modes Description
UMTS/TM1	WCDMA system, QPSK modulation
UMTS/TM2	HSDPA system, QPSK modulation
UMTS/TM3	HSUPA system, QPSK modulation

Note:

1. This EUT owns one SIM cards, and the result is recorded;
2. As WCDMA, HSDPA and HSUPA with the same emission designator, test result recorded in this report at the worst case UMTS/TM1 only after exploratory scan.

2.10.2 Test Environment

Environment Parameter	Selected Values During Tests	
Relative Humidity	Ambient	
Temperature	TN	Ambient
Voltage	VL	3.40V
	VN	3.70V
	VH	4.20V

NOTE: VL=lower extreme test voltage VN=nominal voltage
VH=upper extreme test voltage TN=normal temperature

3 TEST ENVIRONMENT

3.1 Address of the test laboratory

Shenzhen LCS Compliance Testing Laboratory Ltd

1/F., Xingyuan Industrial Park, Tongda Road, Bao'an Avenue, Bao'an District, Shenzhen, Guangdong, China

The sites are constructed in conformance with the requirements of ANSI C63.4 (2014) and CISPR Publication 22.

3.2 Test Facility

The test facility is recognized, certified, or accredited by the following organizations:

FCC Registration Number is 254912.
 Industry Canada Registration Number is 9642A-1.
 EMSD Registration Number is ARCB0108.
 UL Registration Number is 100571-492.
 TUV SUD Registration Number is SCN1081.
 TUV RH Registration Number is UA 50296516-001.
 NVLAP Accreditation Code is 600167-0.
 FCC Designation Number is CN5024.
 CAB identifier: CN0071

3.3 Environmental conditions

During the measurement the environmental conditions were within the listed ranges:

Temperature:	15-35 ° C
Humidity:	30-60 %
Atmospheric pressure:	950-1050mbar

(1)expressed at approximately the 95% confidence level using a coverage factor of k=1.96.

3.4 Test Description

3.4.1 Cellular Band (824-849MHz paired with 869-894MHz) (Band V)

Test Item	FCC Rule No.	Requirements	Verdict
Effective(Isotropic) Radiated Output Power	§2.1046, §22.913	FCC: ERP ≤ 7W.	Pass
Modulation Characteristics	§2.1047	Digital modulation	N/A
Bandwidth	§2.1049	OBW: No limit. EBW: No limit.	Pass
Band Edges Compliance	§2.1051, §22.917	≤-13dBm/1%*EBW, in 1MHz bands immediately outside and adjacent to The frequency block.	Pass
Spurious Emission at Antenna Terminals	§2.1051, §22.917	≤ -13dBm/100kHz, from 9kHz to 10 th harmonics but outside authorized operating frequency ranges.	Pass
Field Strength of Spurious Radiation	§2.1053, §22.917	≤ -13dBm/100kHz.	Pass
Frequency Stability	§2.1055, §22.355	≤ ±2.5ppm.	Pass
Peak-Average Ratio	§22.913	≤13dB	Pass

NOTE 1: For the verdict, the "N/A" denotes "not applicable", the "N/T" de notes "not tested".

3.4.2 PCS Band (1850-1915MHz paired with 1930-1995MHz) (Band II)

Test Item	FCC Rule No.	Requirements	Verdict
Effective(Isotropic) Radiated Output Power	§2.1046, §24.232	EIRP ≤ 2W	Pass
Peak-Average Ratio	§2.1046, §24.232	≤13dB	Pass
Modulation Characteristics	§2.1047	Digital modulation	N/A
Bandwidth	§2.1049	OBW: No limit. EBW: No limit.	Pass
Band Edges Compliance	§2.1051, §24.238	≤ -13dBm/1%*EBW, In 1MHz bands immediately outside and adjacent to The frequency block.	Pass
Spurious Emission at Antenna Terminals	§2.1051, §24.238	≤-13dBm/1MHz, from 9kHz to10 th harmonics but outside authorized operating frequency ranges.	Pass
Field Strength of Spurious Radiation	§2.1053, §24.238	≤ -13dBm/1MHz.	Pass
Frequency Stability	§2.1055, §24.235	≤ ±2.5ppm.	Pass
NOTE 1: For the verdict, the "N/A" denotes "not applicable", the "N/T" de notes "not tested".			

Remark: 1.The measurement uncertainty is not included in the test result.

3.5 Equipments Used during the Test

Item	Equipment	Manufacturer	Model No.	Serial No.	Cal Date	Due Date
1	Power Meter	R&S	NRVS	100444	2019-06-11	2020-06-10
2	Power Sensor	R&S	NRV-Z81	100458	2019-06-11	2020-06-10
3	Power Sensor	R&S	NRV-Z32	10057	2019-06-11	2020-06-10
4	LTE Test Software	Tonscend	JS1120-1	N/A	N/A	N/A
5	RF Control Unit	Tonscend	JS0806	158060009	2019-06-11	2020-06-10
6	MXA Signal Analyzer	Agilent	N9020A	MY51250905	2019-11-12	2020-11-21
7	WIDEBAND RADIO COMMUNICATION TESTER	R&S	CMW 500	103818	2019-06-11	2020-06-10
8	DC Power Supply	Agilent	E3642A	N/A	2019-11-14	2020-11-13
9	EMI Test Software	AUDIX	E3	N/A	N/A	N/A
10	3m Full Anechoic Chamber	MRDIANZI	FAC-3M	MR009	2019-09-27	2020-09-26
11	Positioning Controller	MF	MF-7082	N/A	2019-06-12	2020-06-11
12	Active Loop Antenna	SCHWARZBECK	FMZB 1519B	00005	2019-07-25	2020-07-24
13	By-log Antenna	SCHWARZBECK	VULB9163	9163-470	2019-07-25	2020-07-24
14	By-log Antenna	SCHWARZBECK	VULB9163	5094	2019-07-25	2020-07-24
15	Horn Antenna	SCHWARZBECK	BBHA 9120D	9120D-1925	2019-07-01	2020-06-30
16	Horn Antenna	SCHWARZBECK	BBHA 9120D	9120D-1924	2019-07-01	2020-06-30
17	Broadband Horn Antenna	SCHWARZBECK	BBHA 9170	791	2017-09-21	2020-09-20
18	Broadband Preampfier	SCHWARZBECK	BBV 9719	9719-025	2019-06-17	2020-06-16
19	EMI Test Receiver	R&S	ESR 7	101181	2019-06-12	2020-06-11
20	RS SPECTRUM ANALYZER	R&S	FSP40	100503	2019-11-14	2020-11-13
21	Broadband Preampfier	/	BP-01M18G	P190501	2019-07-01	2020-06-30
22	RF Cable-R03m	Jye Bao	RG142	CB021	2019-06-12	2020-06-11
23	RF Cable-HIGH	SUHNER	SUCOFLEX 106	03CH03-HY	2019-06-12	2020-06-11
24	6dB Attenuator	/	100W/6dB	1172040	2019-06-11	2020-06-10
25	3dB Attenuator	/	2N-3dB	/	2019-06-11	2020-06-10
26	Temperature & Humidity Chamber	GUANGZHOU GOGNWEN	GDS-100	70932	2019-10-09	2020-10-08
27	EMI Test Receiver	R&S	ESPI	101840	2019-06-11	2020-06-10
28	Artificial Mains	R&S	ENV216	101288	2019-06-12	2020-06-11
29	10dB Attenuator	SCHWARZBECK	MTS-IMP-136	261115-001-0032	2019-06-11	2020-06-10
30	Wireless Communication Test Set	R & S	CMU200	105988	2019-11-22	2020-11-21

Note: All equipment is calibrated through CHINA CEPREI LABORATORY and GUANGZHOU LISAI CALIBRATION AND TEST CO., LTD.

3.6 Measurement uncertainty

The data and results referenced in this document are true and accurate. The reader is cautioned that there may be errors within the calibration limits of the equipment and facilities. The measurement uncertainty was calculated for all measurements listed in this test report acc. to ETSI TR 100 028 “ Electromagnetic compatibility and Radio spectrum Matters (ERM); Uncertainties in the measurement of mobile radio equipment characteristics” and is documented in the Shenzhen LCS Compliance Testing Laboratory Ltd. quality system acc. to DIN EN ISO/IEC 17025. Furthermore, component and process variability of devices similar to that tested may result in additional deviation. The manufacturer has the sole responsibility of continued compliance of the device.

Hereafter the best measurement capability for Shenzhen LCS Compliance Testing Laboratory Ltd. is reported:

Test	Range	Measurement Uncertainty	Notes
Radiated Emission	30~1000MHz	3.10 dB	(1)
Radiated Emission	1~18GHz	3.80 dB	(1)
Radiated Emission	18-40GHz	3.90 dB	(1)
Conducted Disturbance	0.15~30MHz	1.63 dB	(1)
Conducted Power	9KHz~18GHz	0.61 dB	(1)
Spurious RF Conducted Emission	9KHz~40GHz	1.22 dB	(1)
Band Edge Compliance of RF Emission	9KHz~40GHz	1.22 dB	(1)
Occupied Bandwidth	9KHz~40GHz	-	(1)

(1) This uncertainty represents an expanded uncertainty expressed at approximately the 95% confidence level using a coverage factor of k=1.96.

4 TEST CONDITIONS AND RESULTS

4.1 Output Power

TEST APPLICABLE

During the process of testing, the EUT was controlled via R&S Digital Radio Communication tester (CMU200) to ensure max power transmission and proper modulation. This result contains output power and EIRP measurements for the EUT. In all cases, output power is within the specified limits.

4.1.1. Conducted Output Power

TEST CONFIGURATION

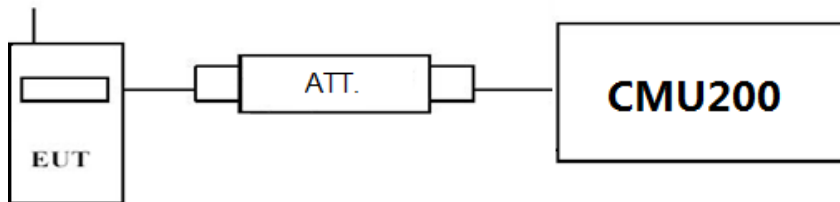

TEST PROCEDURE

Conducted Power Measurement:

- Place the EUT on a bench and set it in transmitting mode.
- Connect a low loss RF cable from the antenna port to a CMU200 by an Att.
- EUT Communicate with CMU200 then selects a channel for testing.
- Add a correction factor to the display CMU200, and then test.

TEST RESULTS

Item	band	WCDMA Band II result (dBm)			WCDMA Band V result (dBm)		
		Channel/Frequency(MHz)			Channel/Frequency(MHz)		
	sub-test	9262/ 1852.4	9400/ 1880	9538/ 1907.6	4132/ 826.4	4182/ 836.4	4233/ 846.6
RMC	12.2kbps RMC	22.82	22.32	22.97	22.94	22.89	22.97
HSDPA	Sub –Test 1	22.07	21.46	22.04	22.29	22.26	22.45
	Sub –Test 2	21.49	21.03	21.62	22.08	22.13	22.04
	Sub –Test 3	21.49	20.49	21.05	21.03	21.57	21.47
	Sub –Test 4	20.93	20.49	20.66	21.88	21.58	21.68
HSUPA	Sub –Test 1	22.68	22.21	22.21	22.14	22.55	22.02
	Sub –Test 2	21.70	21.34	21.98	22.29	22.44	21.76
	Sub –Test 3	21.47	21.68	21.45	21.11	21.64	21.09
	Sub –Test 4	21.05	21.08	21.03	21.08	21.17	21.25
	Sub –Test 5	20.50	20.74	20.51	20.95	20.64	20.55

4.1.1 Radiated Output Power

TEST DESCRIPTION

This is the test for the maximum radiated power from the EUT.

Rule Part 27.232(c) specifies, "Mobile/portable stations are limited to 2 watts e.i.r.p. Peak power" and 24.232(e) specifies that "Peak transmit power must be measured over any interval of continuous transmission using instrumentation calibrated in terms of an rms-equivalent voltage."

Rule Part 22.913(a) specifies "The ERP of mobile transmitters and auxiliary test transmitters must not exceed 7 Watts."

Per Part 27.50(d) (4) specifies, Fixed, mobile, and portable (hand-held) stations operating in the 1710-1755MHz band are limited to 1W EIRP. Fixed stations operating in this band are limited to a maximum antenna height of 10 meters above ground. Mobile and portable stations operating in this band must employ a means for limiting power to the minimum necessary for successful communications.

TEST CONFIGURATION

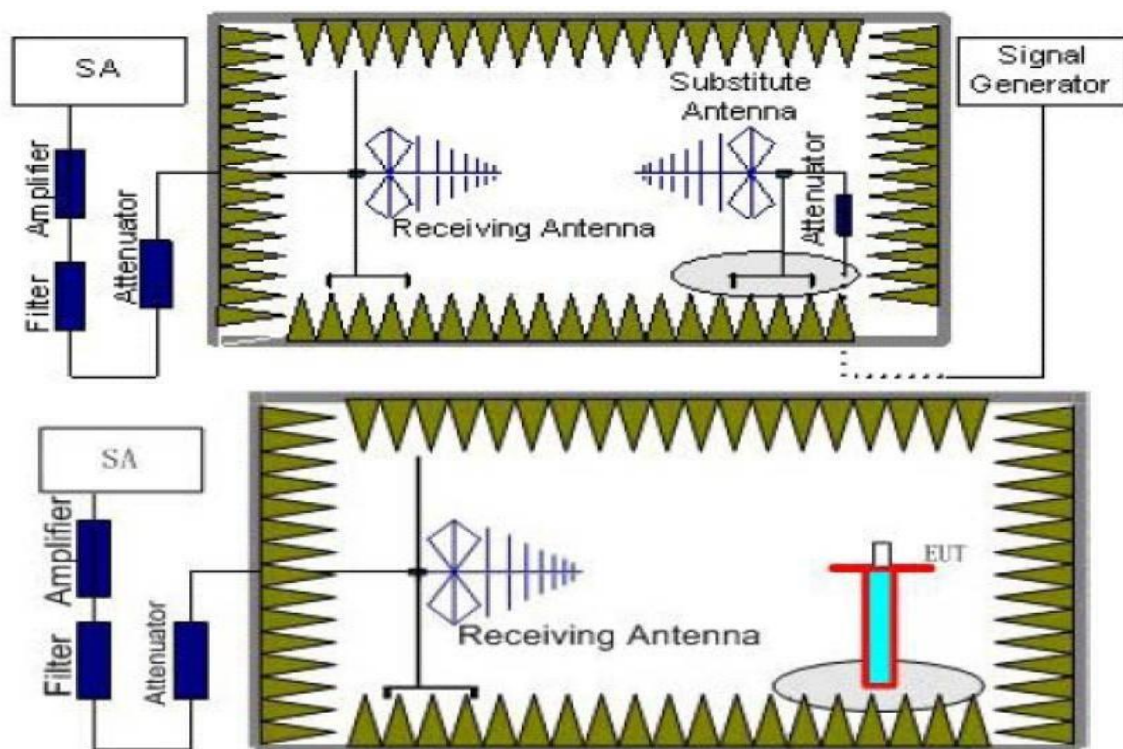

TEST PROCEDURE

1. EUT was placed on a 1.50 meter high non-conductive stand at a 3 meter test distance from the receive antenna. A receiving antenna was placed on the antenna mast 3 meters from the EUT for emission measurements. The height of receiving antenna is 1.50m. Detected emissions were maximized at each frequency by rotating the EUT through 360° and adjusting the receiving antenna polarization. The radiated emission measurements of all transmit frequencies in three channels (High, Middle, Low) were measured with peak detector.
2. A log-periodic antenna or double-ridged waveguide horn antenna shall be substituted in place of the EUT. The log-periodic antenna will be driven by a signal generator and the level will be adjusted till the same power value on the spectrum analyzer or receiver. The level of the spurious emissions can be calculated through the level of the signal generator, cable loss, the gain of the substitution antenna and the reading of the spectrum analyzer or receiver.
3. The EUT is then put into continuously transmitting mode at its maximum power level during the test. Set Test Receiver or Spectrum RBW=10MHz,VBW=10MHz, And the maximum value of the receiver should be recorded as (P_r).
4. The EUT shall be replaced by a substitution antenna. In the chamber, an substitution antenna for the frequency band of interest is placed at the reference point of the chamber. An RF Signal source for the frequency band of interest is connected to the substitution antenna with a cable that has been constructed

to not interfere with the radiation pattern of the antenna. A power (P_{Mea}) is applied to the input of the substitution antenna, and adjust the level of the signal generator output until the value of the receiver reach the previously recorded (P_r). The power of signal source (P_{Mea}) is recorded. The test should be performed by rotating the test item and adjusting the receiving antenna polarization.

5. A amplifier should be connected to the Signal Source output port. And the cable should be connect between the Amplifier and the Substitution Antenna. The cable loss (P_{cl}), the Substitution Antenna Gain (G_a) and the Amplifier Gain (P_{Ag}) should be recorded after test.

The measurement results are obtained as described below:

$$\text{Power(EIRP)} = P_{Mea} + P_{Ag} - P_{cl} + G_a$$

6. This value is EIRP since the measurement is calibrated using an antenna of known gain (2.15 dBi) and known input power.
7. ERP can be calculated from EIRP by subtracting the gain of the dipole, $ERP = EIRP - 2.15\text{dBi}$.

TEST LIMIT

According to 22.913(a)(5), 24.232(c), the ERP(EIRP) should be not exceeding following table limits:

Burst Average EIRP	
UMTS Band II	FCC: $\leq 33.01\text{dBm}$ (2W)

Burst Average ERP	
UMTS Band V	FCC: $\leq 38.45\text{dBm}$ (7W)

TEST RESULTS

Remark:

1. We were tested all Configuration refer 3GPP TS134 121.
2. $EIRP = P_{Mea}(\text{dBm}) - P_{cl}(\text{dB}) + P_{Ag}(\text{dB}) + G_a(\text{dBi})$
3. $ERP = EIRP - 2.15\text{dBi}$ as EIRP by subtracting the gain of the dipole.
4. Margin = Emission Level - Limit
5. We test the H direction and V direction recorded worst case.

UMTS/TM1/UMTS Band II

Frequency (MHz)	P_{Mea} (dBm)	P_{cl} (dB)	G_a Antenna Gain (dB)	P_{Ag} (dB)	Burst Average EIRP (dBm)	Limit (dBm)	Margin (dB)	Polarization
1852.40	-17.12	4.03	8.38	35.51	22.74	33.01	-10.27	V
1880.00	-16.25	4.08	8.33	35.56	23.56	33.01	-9.45	V
1907.60	-17.19	4.14	8.26	35.63	22.56	33.01	-10.45	V

UMTS/TM1/UMTS Band V

Frequency (MHz)	P_{Mea} (dBm)	P_{cl} (dB)	G_a Antenna Gain (dB)	Correction (dB)	P_{Ag} (dB)	Burst Average ERP (dBm)	Limit (dBm)	Margin (dB)	Polarization
826.40	-13.75	3.45	8.45	2.15	33.79	22.89	38.45	-15.56	V
836.40	-13.35	3.49	8.45	2.15	33.85	23.31	38.45	-15.14	V
846.60	-13.27	3.55	8.36	2.15	33.88	23.27	38.45	-15.18	V

4.2 Radiated Spurious Emission

TEST APPLICABLE

According to the TIA-603-E:2016 and FCC Part 2.1033 test method, The Receiver or Spectrum was scanned from lowest frequency frequency generated within the equipment to the 10th harmonic of the highest frequency generated within the equipment, which is the transmitted carrier that can be as high as 1910 MHz. The resolution bandwidth is set as outlined in Part 27.238, Part 24.238, Part 22.917, RSS-132 §5.5 and RSS-133 §6.5. The spectrum is scanned with the mobile station transmitting at carrier frequencies that pertain to low, mid and high channels of WCDMA Band II, WCDMA Band IV and WCDMA Band V.

TEST CONFIGURATION

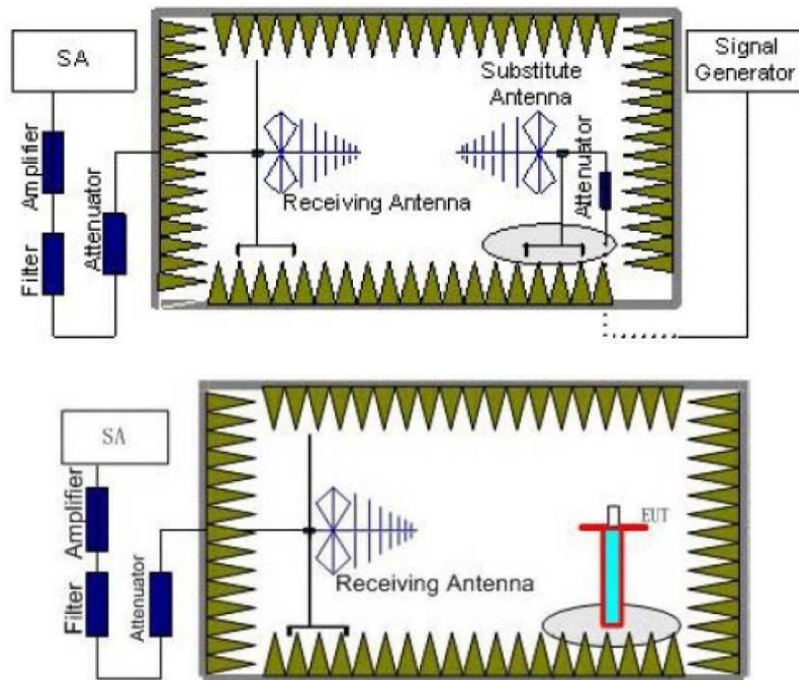

TEST PROCEDURE

1. EUT was placed on a 1.50 meter high non-conductive stand at a 3 meter test distance from the receive antenna. A receiving antenna was placed on the antenna mast 3 meters from the EUT for emission measurements. The height of receiving antenna is 1.50 m. Detected emissions were maximized at each frequency by rotating the EUT through 360° and adjusting the receiving antenna polarization. The radiated emission measurements of all transmit frequencies in three channels (High, Middle, Low) were measured with peak detector.
2. A log-periodic antenna or double-ridged waveguide horn antenna shall be substituted in place of the EUT. The log-periodic antenna will be driven by a signal generator and the level will be adjusted till the same power value on the spectrum analyzer or receiver. The level of the spurious emissions can be calculated through the level of the signal generator, cable loss, the gain of the substitution antenna and the reading of the spectrum analyzer or receiver.
3. The EUT is then put into continuously transmitting mode at its maximum power level during the test. Set Test Receiver or Spectrum RBW=1MHz, VBW=3MHz, And the maximum value of the receiver should be recorded as (P_r).
4. The EUT shall be replaced by a substitution antenna. In the chamber, an substitution antenna for the frequency band of interest is placed at the reference point of the chamber. An RF Signal source for the frequency band of interest is connected to the substitution antenna with a cable that has been constructed to not interfere with the radiation pattern of the antenna. A power (P_{Mea}) is applied to the input of the substitution antenna, and adjust the level of the signal generator output until the value of the receiver reach the previously recorded (P_r). The power of signal source (P_{Mea}) is recorded. The test should be performed by rotating the test item and adjusting the receiving antenna polarization.

5. A amplifier should be connected to the Signal Source output port. And the cable should be connect between the Amplifier and the Substitution Antenna. The cable loss (P_{cl}), the Substitution Antenna Gain (G_a) and the Amplifier Gain (P_{Ag}) should be recorded after test.
The measurement results are obtained as described below:
Power(EIRP)= $P_{Mea} + P_{Ag} - P_{cl} + G_a$
6. This value is EIRP since the measurement is calibrated using an antenna of known gain (2.15 dBi) and known input power.
7. ERP can be calculated from EIRP by subtracting the gain of the dipole, ERP = EIRP -2.15dBi.
8. In order to make sure test results more clearly, we set frequency range and sweep time for difference frequency range as follows table:

Working Frequency	Subrange (GHz)	RBW	VBW	Sweep time (s)
UMTS/TM1/ WCDMA Band V	0.00009~0.15	1KHz	3KHz	30
	0.00015~0.03	10KHz	30KHz	10
	0.03~1	100KHz	300KHz	10
	1~2	1 MHz	3 MHz	2
	2~5	1 MHz	3 MHz	3
	5~8	1 MHz	3 MHz	3
	8~10	1 MHz	3 MHz	3
UMTS/TM1/ WCDMA Band II	0.00009~0.15	1KHz	3KHz	30
	0.00015~0.03	10KHz	30KHz	10
	0.03~1	100KHz	300KHz	10
	1~2	1 MHz	3 MHz	2
	2~5	1 MHz	3 MHz	3
	5~8	1 MHz	3 MHz	3
	8~11	1 MHz	3 MHz	3
	11~14	1 MHz	3 MHz	3
	14~18	1 MHz	3 MHz	3
18~20	1 MHz	3 MHz	2	

TEST LIMITS

According to 24.238, 22.917 and 27.54 specify that the power of any emission outside of the authorized operating frequency ranges must be attenuated below the transmitting power (P) by a factor of at least 43 + 10 log(P) dB.

The specification that emissions shall be attenuated below the transmitter power (P) by at least 43 + 10 log (P) dB, translates in the relevant power range (1 to 0.001 W) to -13 dBm. At 1 W the specified minimum attenuation becomes 43 dB and relative to a 30 dBm (1 W) carrier becomes a limit of -13 dBm. At 0.001 W (0 dBm) the minimum attenuation is 13 dB, which again yields a limit of -13 dBm. In this way a translation of the specification from relative to absolute terms is carried out.

Frequency	Channel	Frequency Range	Verdict
UMTS/TM1/ WCDMA Band V	Low	9KHz - 10GHz	PASS
	Middle	9KHz - 10GHz	PASS
	High	9KHz - 10GHz	PASS
UMTS/TM1/ WCDMA Band II	Low	9KHz - 20GHz	PASS
	Middle	9KHz - 20GHz	PASS
	High	9KHz - 20GHz	PASS

TEST RESULTS

Remark:

1. We were tested all Configuration refer 3GPP TS134 121.
2. $EIRP = P_{Mea}(dBm) - P_{cl}(dB) + P_{Ag}(dB) + G_a(dBi)$
3. $ERP = EIRP - 2.15dBi$ as EIRP by subtracting the gain of the dipole.
4. $Margin = EIRP - Limit$
5. The data of below 1G are attenuated more than 20dB below the permissible limits or the field strength is too small to be measured, So it's not recorded.

UMTS/TM1/ WCDMA Band II _ Low Channel

Frequency (MHz)	P _{Mea} (dBm)	P _{cl} (dB)	Diatance	G _a Antenna Gain(dB)	Peak EIRP (dBm)	Limit (dBm)	Margin (dB)	Polarization
3704.8	-40.32	5.26	3.00	9.88	-35.70	-13.00	-22.70	H
5557.2	-45.47	6.11	3.00	11.36	-40.22	-13.00	-27.22	H
3704.8	-44.80	5.26	3.00	9.88	-40.18	-13.00	-27.18	V
5557.2	-48.19	6.11	3.00	11.36	-42.94	-13.00	-29.94	V

UMTS/TM1/ WCDMA Band II _ Middle Channel

Frequency (MHz)	P _{Mea} (dBm)	P _{cl} (dB)	Diatance	G _a Antenna Gain(dB)	Peak EIRP (dBm)	Limit (dBm)	Margin (dB)	Polarization
3760.0	-38.22	5.32	3.00	10.03	-33.51	-13.00	-20.51	H
5640.0	-43.66	6.19	3.00	11.41	-38.44	-13.00	-25.44	H
3760.0	-43.65	5.32	3.00	10.03	-38.94	-13.00	-25.94	V
5640.0	-48.22	6.19	3.00	11.41	-43.00	-13.00	-30.00	V

UMTS/TM1/ WCDMA Band II _ High Channel

Frequency (MHz)	P _{Mea} (dBm)	P _{cl} (dB)	Diatance	G _a Antenna Gain(dB)	Peak EIRP (dBm)	Limit (dBm)	Margin (dB)	Polarization
3815.2	-42.90	5.36	3.00	9.62	-38.64	-13.00	-25.64	H
5722.8	-51.51	6.24	3.00	11.46	-46.29	-13.00	-33.29	H
3815.2	-46.35	5.36	3.00	9.62	-42.09	-13.00	-29.09	V
5722.8	-53.83	6.24	3.00	11.46	-48.61	-13.00	-35.61	V

UMTS/TM1/ WCDMA Band V _ Low Channel

Frequency (MHz)	P _{Mea} (dBm)	P _{cl} (dB)	Diatance	G _a Antenna Gain(dB)	Peak EIRP (dBm)	Limit (dBm)	Margin (dB)	Polarization
1652.8	-48.03	3.86	3.00	8.56	-43.33	-13.00	-30.33	H
2479.2	-48.88	4.29	3.00	6.98	-46.19	-13.00	-33.19	H
1652.8	-44.14	3.86	3.00	8.56	-39.44	-13.00	-26.44	V
2479.2	-45.07	4.29	3.00	6.98	-42.38	-13.00	-29.38	V

UMTS/TM1/ WCDMA Band V _ Middle Channel

Frequency (MHz)	P _{Mea} (dBm)	P _{cl} (dB)	Diatance	G _a Antenna Gain(dB)	Peak EIRP (dBm)	Limit (dBm)	Margin (dB)	Polarization
1672.8	-49.53	3.90	3.00	8.58	-44.85	-13.00	-31.85	H
2509.2	-50.84	4.32	3.00	6.80	-48.36	-13.00	-35.36	H
1672.8	-45.35	3.90	3.00	8.58	-40.67	-13.00	-27.67	V
2509.2	-45.01	4.32	3.00	6.80	-42.53	-13.00	-29.53	V

UMTS/TM1/ WCDMA Band V _ High Channel

Frequency (MHz)	P _{Mea} (dBm)	P _{cl} (dB)	Diatance	G _a Antenna Gain(dB)	Peak EIRP (dBm)	Limit (dBm)	Margin (dB)	Polarization
1693.2	-52.08	3.91	3.00	9.06	-46.93	-13.00	-33.93	H
2539.8	-54.33	4.32	3.00	6.65	-52.00	-13.00	-39.00	H
1693.2	-49.64	3.91	3.00	9.06	-44.49	-13.00	-31.49	V
2539.8	-51.02	4.32	3.00	6.65	-48.69	-13.00	-35.69	V

4.3 Occupied Bandwidth and Emission Bandwidth

TEST APPLICABLE

Similar to conducted emissions; occupied bandwidth measurements are only provided for selected frequencies in order to reduce the amount of submitted data. The table below lists the measured 99% Bandwidth and -26dBc Bandwidth.

TEST CONFIGURATION

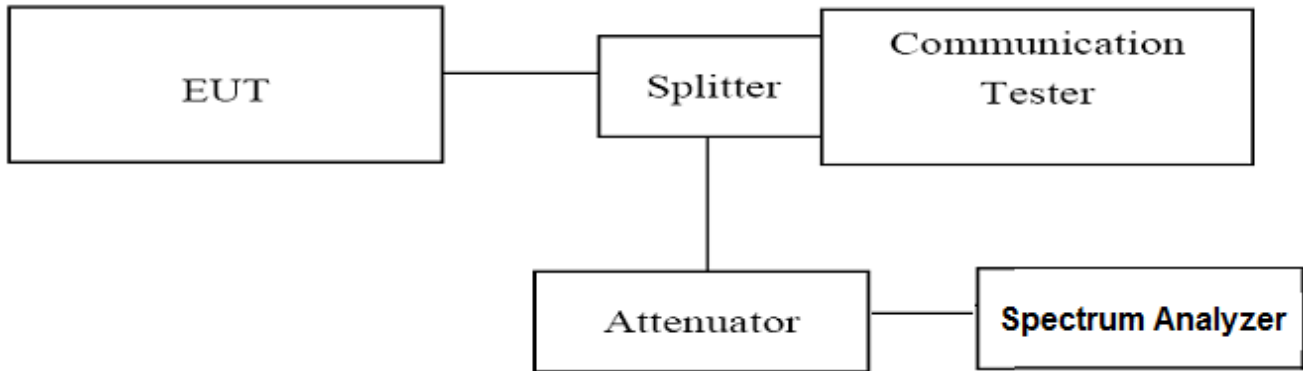

TEST PROCEDURE

1. The EUT was set up for the max output power with pseudo random data modulation;
2. The Occupied bandwidth and Emission Bandwidth were measured with Agilent Spectrum Analyzer N9020A (peak);
3. Set RBW=100KHz,VBW=300KHz,Span=10MHz,SWT=Auto;
4. Set SPA Max hold and View, Set 99% Occupied Bandwidth/ Set -26dBc Occupied Bandwidth
5. These measurements were done at 3 frequencies for WCDMA band II/IV/V. (low, middle and high of operational frequency range).

TEST RESULTS

Test Mode	Channel	Frequency (MHz)	Occupied Bandwidth (99% BW) (MHz)	Emission Bandwidth (-26 dBc BW) (MHz)	Verdict
UMTS/TM1/ WCDMA Band II	9262	1852.40	4.1969	4.749	PASS
	9400	1880.00	4.1911	4.768	PASS
	9538	1907.60	4.2499	4.962	PASS
UMTS/TM1/ WCDMA Band V	4132	826.40	4.1694	4.694	PASS
	4182	836.40	4.1921	4.668	PASS
	4233	846.60	4.1719	4.689	PASS

Remark:

1. Test results including cable loss;
2. Please refer to following plots;

Occupied Bandwidth and Emission Bandwidth

UMTS/TM1/ WCDMA Band II

UMTS/TM1/ WCDMA Band V

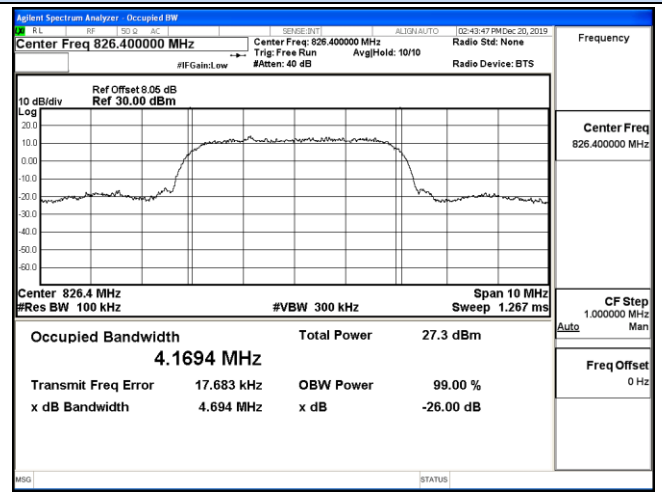
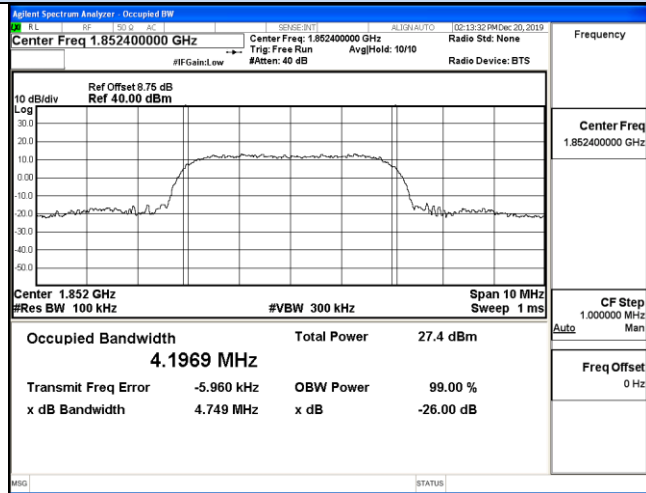

Channel 9262 / 1852.4 MHz

Channel 4132 / 826.4 MHz

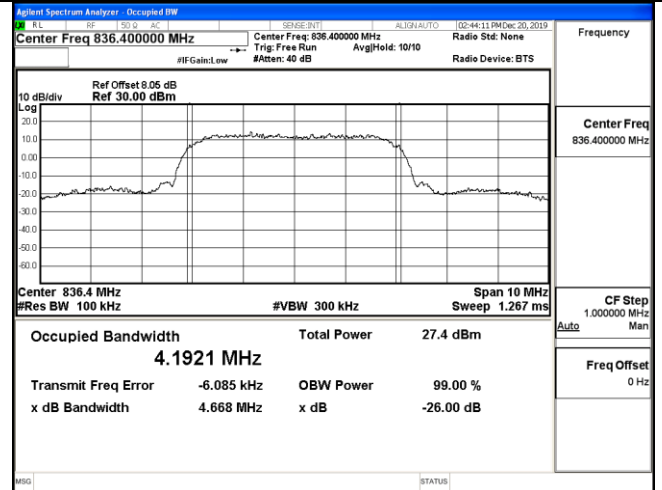
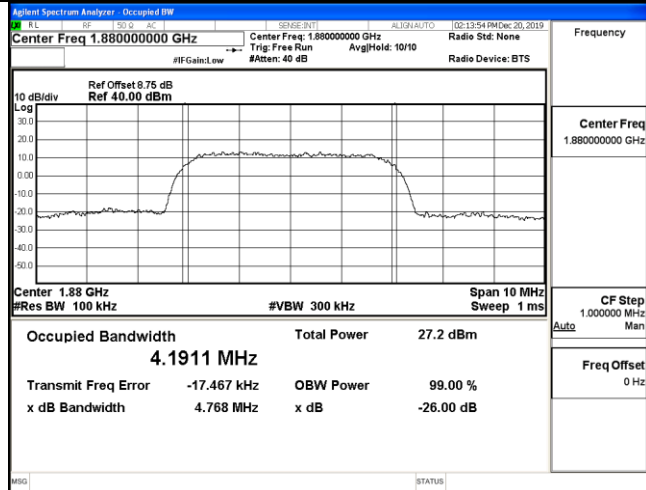

Channel 9400 / 1880.0 MHz

Channel 4182 / 836.4 MHz

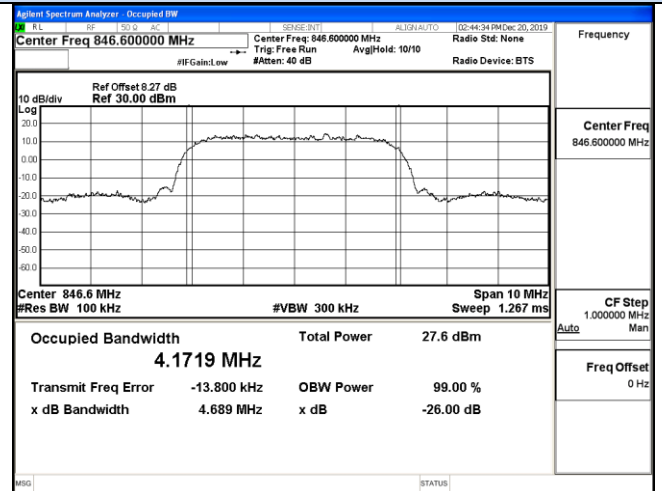
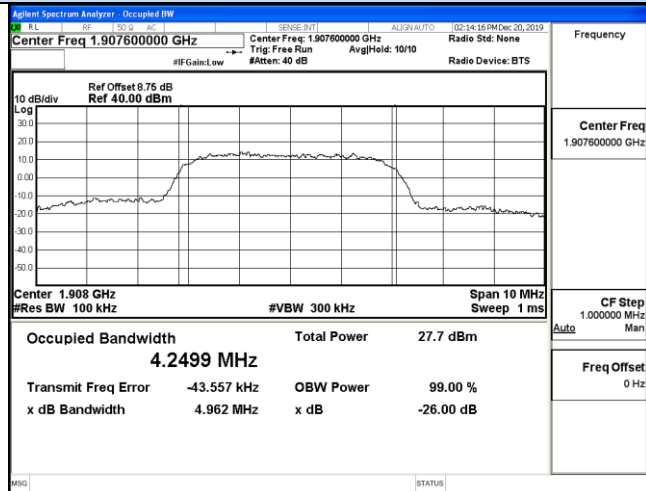

Channel 9538 / 1907.6 MHz

Channel 4233 / 846.6 MHz

4.4 Band Edge Compliance

TEST APPLICABLE

During the process of testing, the EUT was controlled via Digital Radio Communication tester (CMU200) to ensure max power transmission and proper modulation.

TEST CONFIGURATION

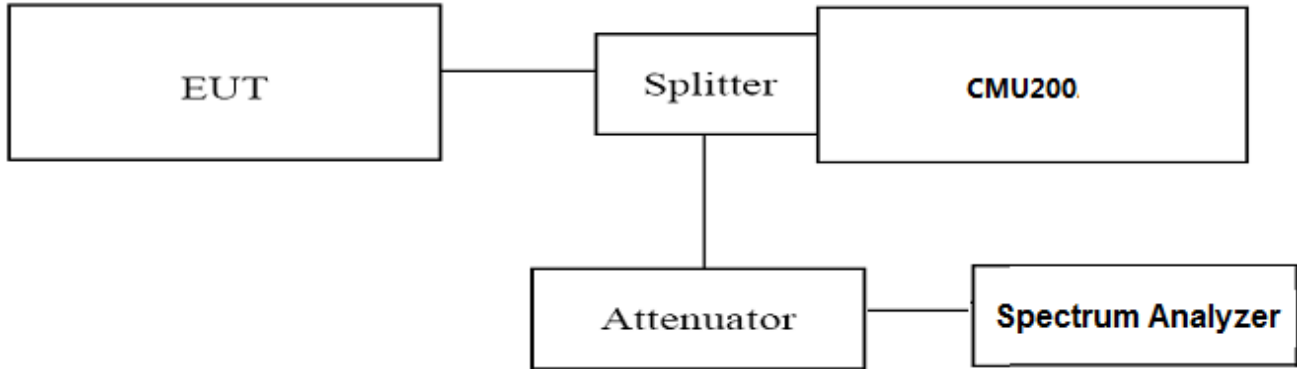

TEST PROCEDURE

1. The EUT was set up for the max output power with pseudo random data modulation;
 2. The power was measured with Spectrum Analyzer N9020A;
 3. Set RBW=51KHz,VBW=200KHz,Span=10MHz,SWT=Auto,Detector: RMS;
- These measurements were done at 2 frequencies for WCDMA Band II/IV/V. (low and high of operational frequency range).

TEST RESULTS

UMTS/TM1/WCDMA Band II					
Test Mode	Channel	Frequency (MHz)	Band Edg Compliance (dBm)	Limits (dBm)	Verdict
UMTS/TM1/WCDMA Band II	9262	1852.40	<-13dBm	-13dBm	PASS
	9538	1907.60	<-13dBm	-13dBm	
UMTS/TM1/WCDMA Band V					
Test Mode	Channel	Frequency (MHz)	Band Edg Compliance (dBm)	Limits (dBm)	Verdict
UMTS/TM1/WCDMA Band V	4132	826.40	<-13dBm	-13dBm	PASS
	4233	846.60	<-13dBm	-13dBm	

Remark:

1. Test results including cable loss;
2. Please refer to following plots;

Band-edge Compliance UMTS/TM1/WCDMA Band II

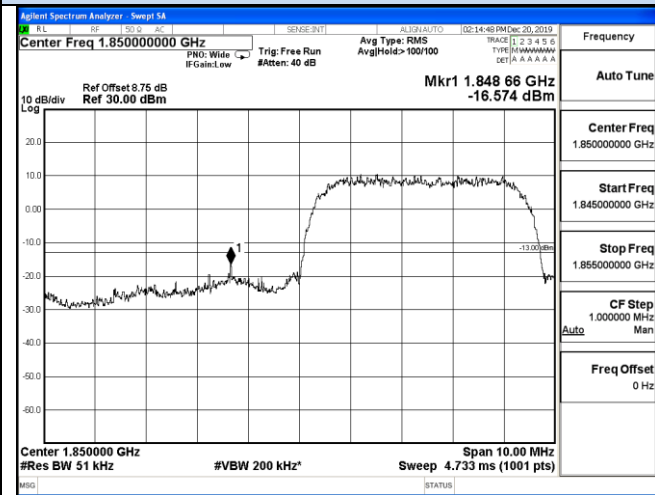

Channel 9262 / 1852.4 MHz

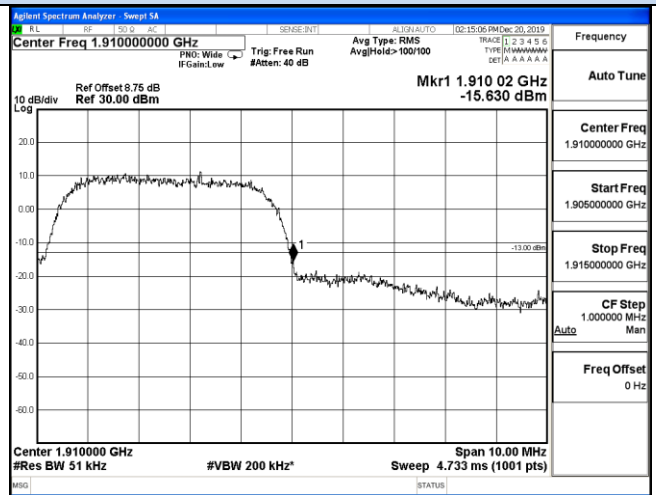

Channel 9538 / 1907.6 MHz

UMTS/TM1/WCDMA Band V

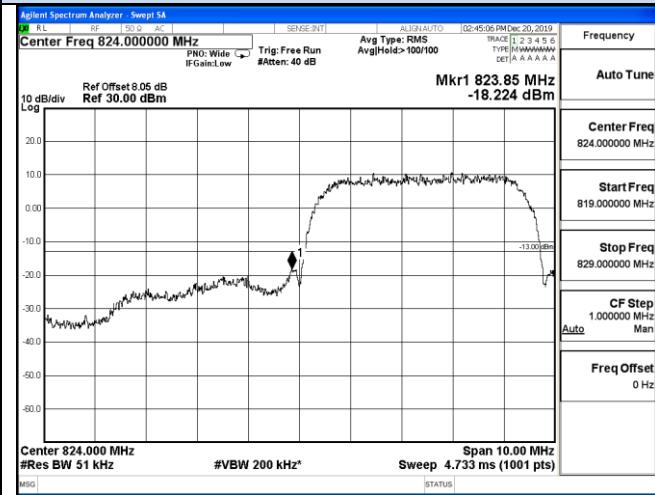

Channel 4132 / 826.4 MHz

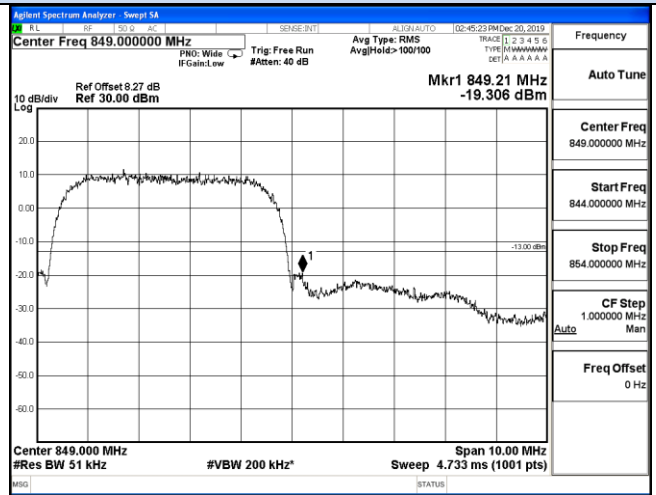

Channel 4233 / 846.6 MHz

4.5 Spurious Emission on Antenna Port

TEST APPLICABLE

The following steps outline the procedure used to measure the conducted emissions from the EUT.

1. Determine frequency range for measurements: From CFR 2.1057 the spectrum should be investigated from the lowest radio frequency generated in the equipment up to at least the 10th harmonic of the carrier frequency. For the equipment of WCDMA band II/IV, this equates to a frequency range of 9 KHz to 20GHz, data taken from 30 MHz to 20 GHz. For WCDMA Band V, this equates to a frequency range of 9 KHz to 20 GHz, data taken from 30 MHz to 20 GHz.
2. The sweep time is set automatically by instrument itself. That should be the optimal sweep time for the span and the RBW. If the sweep time is too short, that is sweep is too fast, the sweep result is not accurate; if the sweep time is too long, that is sweep is too low, some frequency components may be lost. The instrument will give an optimal sweep time according the selected span and RBW.
3. The procedure to get the conducted spurious emission is as follows:
The trace mode is set to MaxHold to get the highest signal at each frequency;
Wait 25 seconds;
Get the result.
4. Determine EUT transmit frequencies: below outlines the band edge frequencies pertinent to conducted emissions testing.

TEST CONFIGURATION

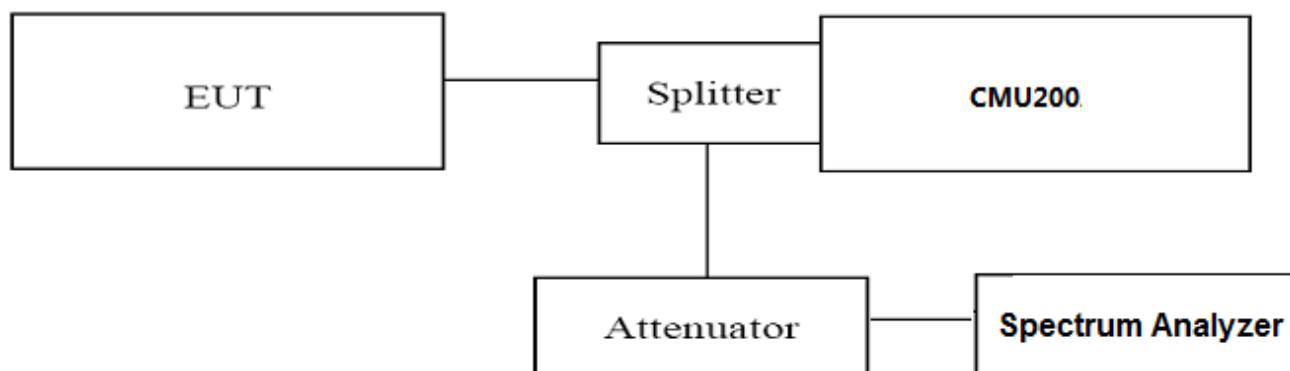

TEST PROCEDURE

1. The EUT was set up for the max output power with pseudo random data modulation;
2. The power was measured with Spectrum Analyzer N9020A;
3. These measurements were done at 3 frequencies for WCDMA band II/IV/V. (low, middle and high of operational frequency range).

TEST LIMIT

Part 24.238, Part 22.917 and Part 27.54 specify that the power of any emission outside of the authorized operating frequency ranges must be attenuated below the transmitting power (P) by a factor of at least $43 + 10 \log(P)$ dB.

The specification that emissions shall be attenuated below the transmitter power (P) by at least $43 + 10 \log(P)$ dB, translates in the relevant power range (1 to 0.001 W) to -13 dBm. At 1 W the specified minimum attenuation becomes 43 dB and relative to a 30 dBm (1 W) carrier becomes a limit of -13 dBm. At 0.001 W (0 dBm) the minimum attenuation is 13 dB, which again yields a limit of -13 dBm. In this way a translation of the specification from relative to absolute terms is carried out.

TEST RESULTS

Test Mode	Channel	Frequency (MHz)	Spurious RF Conducted Emission (dBm)	Limits (dBm)	Verdict
UMTS/TM1/WCDMA Band II	9262	1852.40	<-13dBm	-13dBm	PASS
	9400	1880.00	<-13dBm	-13dBm	
	9538	1907.60	<-13dBm	-13dBm	
UMTS/TM1/WCDMA Band V	4132	826.40	<-13dBm	-13dBm	PASS
	4182	836.40	<-13dBm	-13dBm	
	4233	846.60	<-13dBm	-13dBm	

Remark:

1. Test results including cable loss;
2. Please refer to following plots;
3. Not reorded test plots from 9 KHz to 30 MHz as emission levels 20dB lower than emission limit;

Spurious Emission on Antenna Port
UMTS/TM1/WCDMA Band II
Channel 9262 / 1852.4 MHz

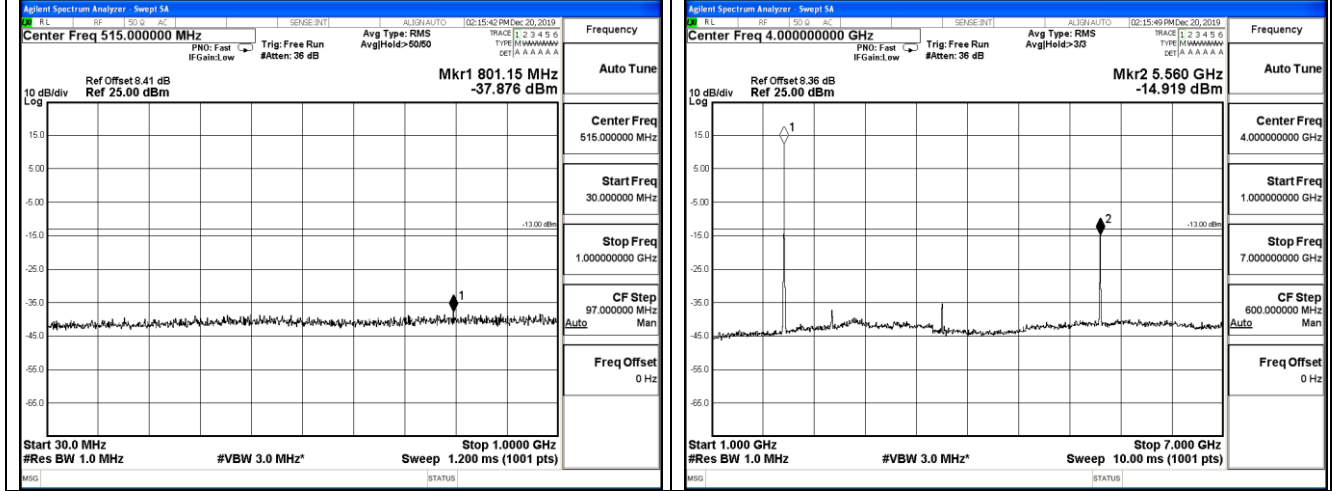

30 MHz – 1000 MHz

1 GHz – 7 GHz

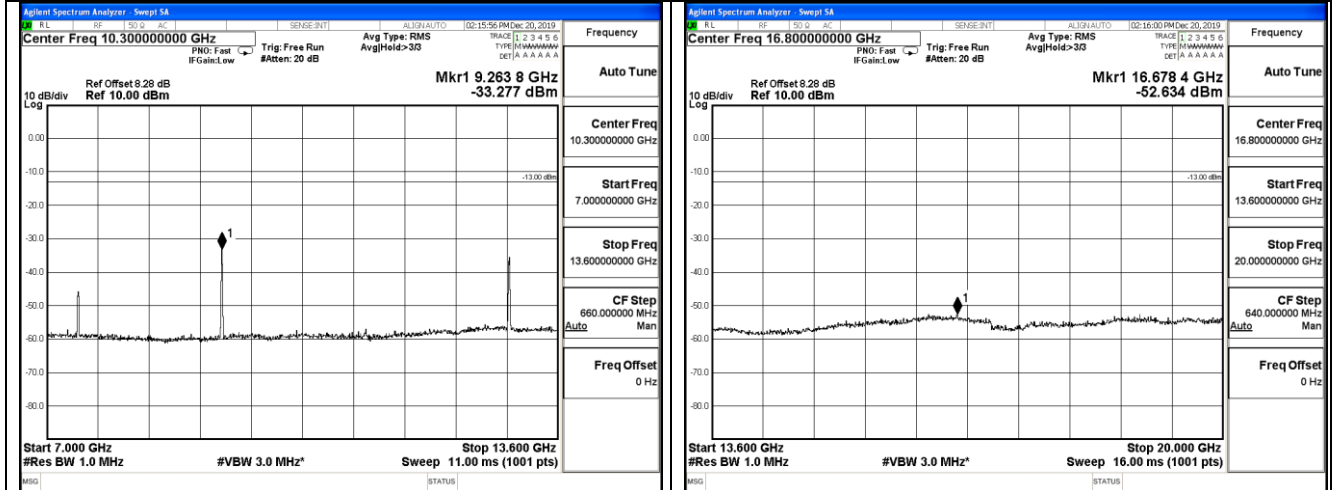

7 GHz – 13.6 GHz

13.6 GHz – 20 GHz

Spurious Emssion on Antenna Port
UMTS/TM1/WCDMA Band II
Channel 9400 / 1880 MHz

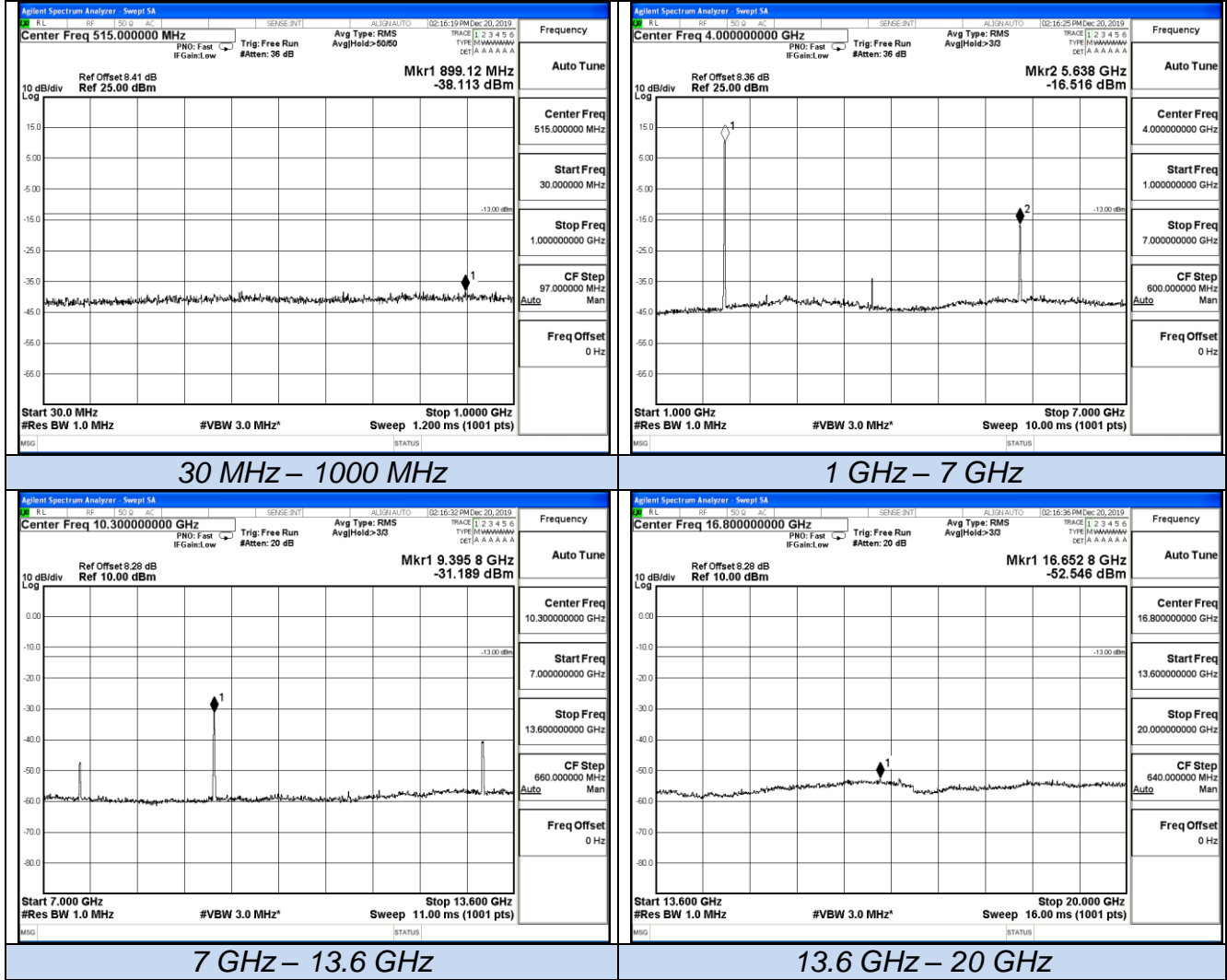

Spurious Emission on Antenna Port
UMTS/TM1/WCDMA Band II
Channel 9538 / 1907.6 MHz

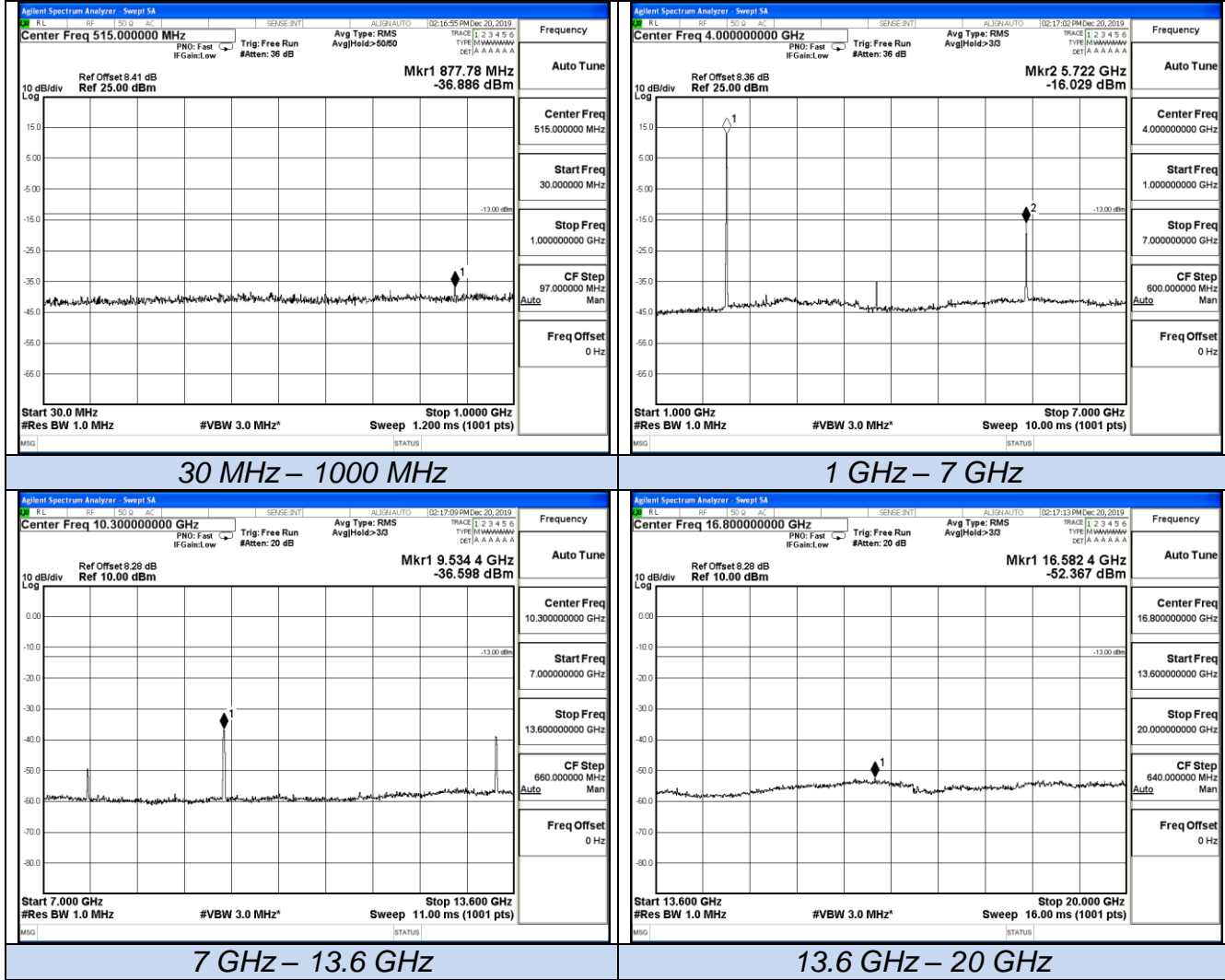

Spurious Emission on Antenna Port
UMTS/TM1/WCDMA Band V

Channel 4132 / 826.4 MHz

Channel 4182 / 836.4 MHz

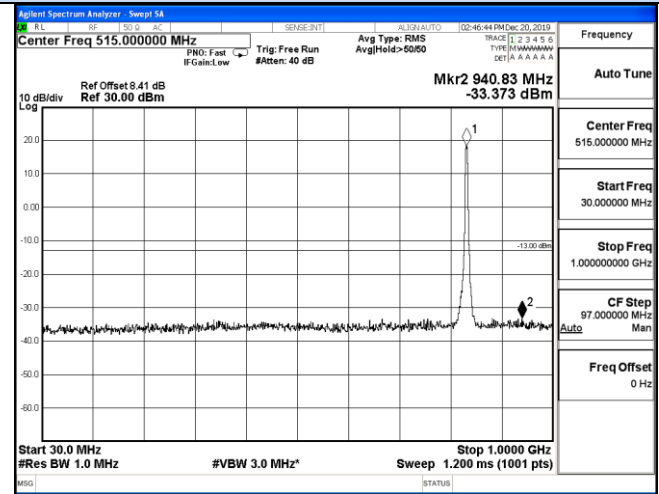
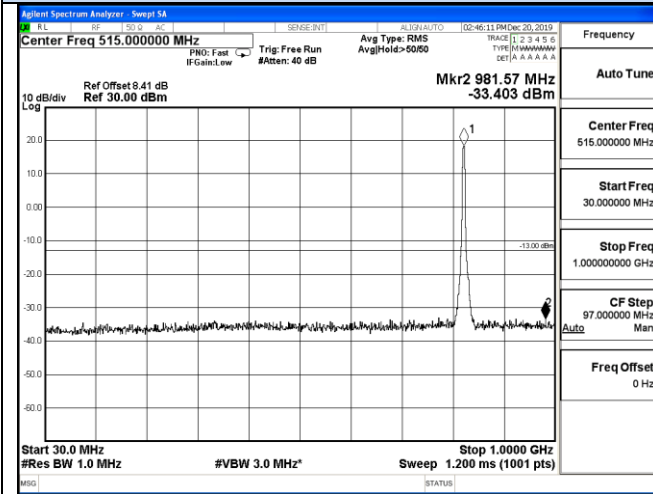

30 MHz – 1000 MHz

30 MHz – 1000 MHz

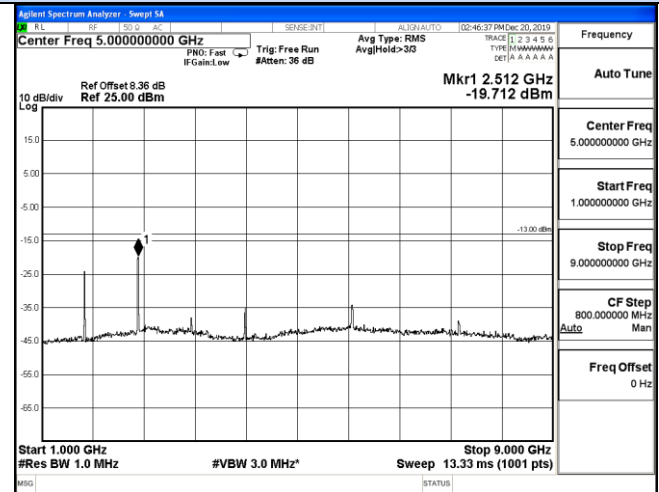
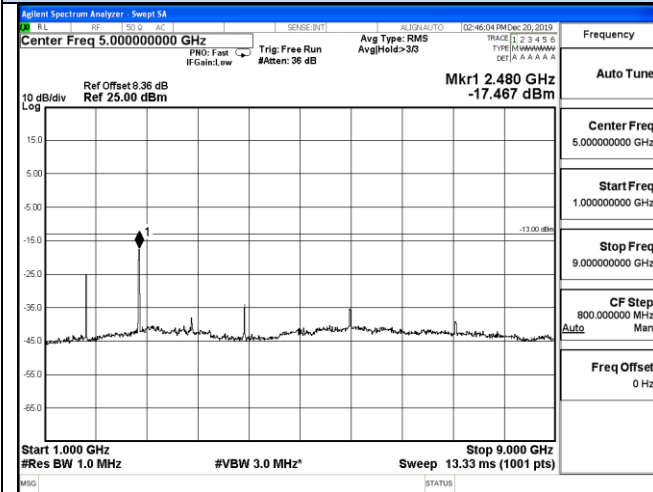

1 GHz – 9 GHz

1 GHz – 9 GHz

UMTS/TM1/WCDMA Band V

Channel 4233 / 846.6 MHz

Channel 4233 / 846.6 MHz

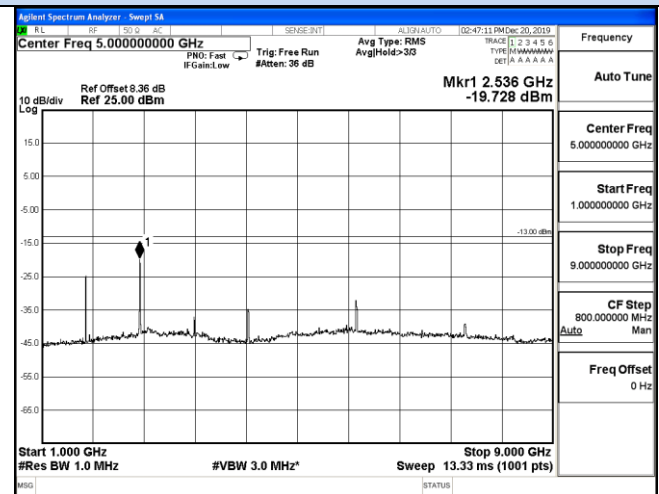
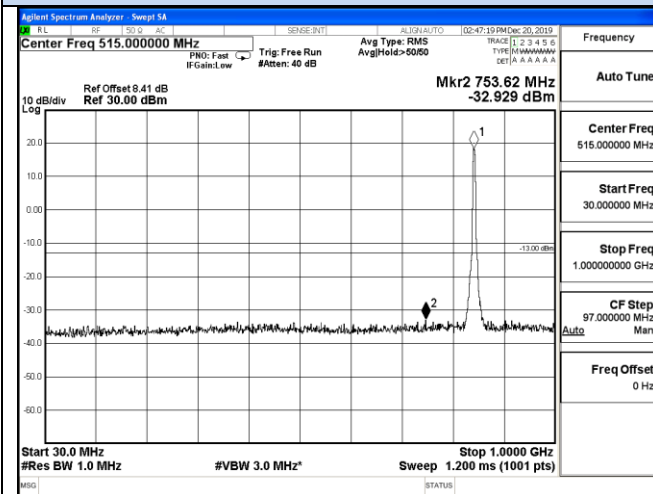

30 MHz – 1000 MHz

1 GHz – 9 GHz

4.6 Frequency Stability Test

TEST APPLICABLE

1. According to FCC Part 2 Section 2.1055 (a)(1), the frequency stability shall be measured with variation of ambient temperature from -30°C to +50°C centigrade.
2. According to FCC Part 2 Section 2.1055 (e)(2) and RSS-GEN, for battery powered equipment, the frequency stability shall be measured with reducing primary supply voltage to the battery operating end point, which is specified by the manufacture.
3. Vary primary supply voltage from 85 to 115 percent of the nominal value for other than hand carried voltage equipment and the end voltage point was 3.40V.

TEST PROCEDURE

In order to measure the carrier frequency under the condition of AFC lock, it is necessary to make measurements with the EUT in a "call mode". This is accomplished with the use of R&S CMU200 DIGITAL RADIO COMMUNICATION TESTER.

1. Measure the carrier frequency at room temperature;
2. Subject the EUT to overnight soak at -30°C;
3. With the EUT, powered via nominal voltage, connected to the CMU200 and in a simulated call on middle channel of WCDMA Band II/IV/V, measure the carrier frequency. These measurements should be made within 2 minutes of Powering up the EUT, to prevent significant self-warming;
4. Repeat the above measurements at 10°C increments from -30°C to +50°C. Allow at least 0.5 hours at each temperature, unpowered, before making measurements;
5. Remeasure carrier frequency at room temperature with nominal voltage. Vary supply voltage from minimum voltage to maximum voltage, in 0.1Volt increments remeasuring carrier frequency at each voltage. Pause at nominal voltage for 0.5 hours unpowered, to allow any self-heating to stabilize, before continuing;
6. Subject the EUT to overnight soak at +50°C;
7. With the EUT, powered via nominal voltage, connected to the CMU200 and in a simulated call on the centre channel, measure the carrier frequency. These measurements should be made within 2 minutes of Powering up the EUT, to prevent significant self-warming;
8. Repeat the above measurements at 10°C increments from +50°C to -30°C. Allow at least 0.5 hours at each temperature, unpowered, before making measurements;
9. At all temperature levels hold the temperature to +/- 0.5°C during the measurement procedure;

TEST CONFIGURATION

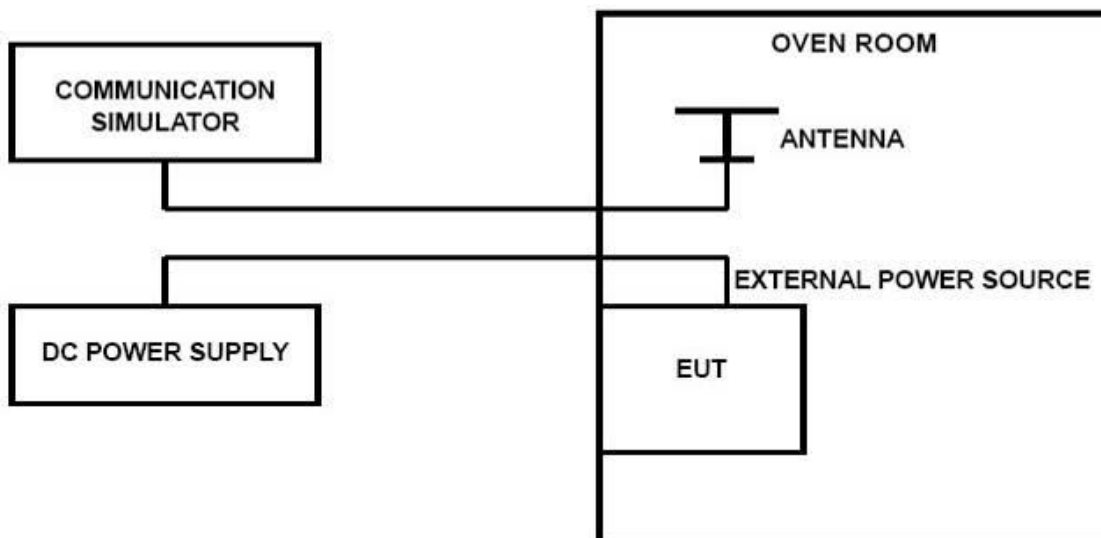

TEST LIMITS**For Hand carried battery powered equipment**

According to the JTC standard the frequency stability of the carrier shall be accurate to within 0.1 ppm of the received frequency from the base station. This accuracy is sufficient to meet Sec. 24.235, Frequency Stability. The frequency stability shall be sufficient to ensure that the fundamental emission stays within the authorized frequency block. As this transceiver is considered "Hand carried, battery powered equipment" Section 2.1055(d)(2) applies. This requires that the lower voltage for frequency stability testing be specified by the manufacturer. This transceiver is specified to operate with an input voltage of between 3.40VDC and 4.30VDC, with a nominal voltage of 3.80VDC. Operation above or below these voltage limits is prohibited by transceiver software in order to prevent improper operation as well as to protect components from overstress. These voltages represent a tolerance of -10 % and +12.5 %. For the purposes of measuring frequency stability these voltage limits are to be used.

For equipment powered by primary supply voltage

According to the JTC standard the frequency stability of the carrier shall be accurate to within 0.1 ppm of the received frequency from the base station. This accuracy is sufficient to meet Sec. 24.235, Frequency Stability. The frequency stability shall be sufficient to ensure that the fundamental emission stays within the authorized frequency block. For this EUT section 2.1055(d)(1) applies. This requires varying primary supply voltage from 85 to 115 percent of the nominal value for other than hand carried battery equipment.

TEST RESULTS

UMTS/TM1/WCDMA Band II					
DC Power	Temperature (°C)	Frequency error(Hz)	Frequency error(ppm)	Limit (ppm)	Verdict
3.40	25	21	0.011	±2.50	PASS
3.70	25	-25	-0.013	±2.50	PASS
4.20	25	-16	-0.009	±2.50	PASS
3.70	-30	18	0.010	±2.50	PASS
3.70	-20	-11	-0.006	±2.50	PASS
3.70	-10	17	0.009	±2.50	PASS
3.70	0	-22	-0.012	±2.50	PASS
3.70	10	30	0.016	±2.50	PASS
3.70	20	-19	-0.010	±2.50	PASS
3.70	30	10	0.005	±2.50	PASS
3.70	40	-14	-0.007	±2.50	PASS
3.70	50	-17	-0.009	±2.50	PASS

UMTS/TM1/WCDMA Band V					
DC Power	Temperature (°C)	Frequency error(Hz)	Frequency error(ppm)	Limit (ppm)	Verdict
3.40	25	-26	-0.031	±2.50	PASS
3.70	25	33	0.039	±2.50	PASS
4.20	25	-12	-0.014	±2.50	PASS
3.70	-30	9	0.011	±2.50	PASS
3.70	-20	-17	-0.020	±2.50	PASS
3.70	-10	18	0.022	±2.50	PASS
3.70	0	13	0.016	±2.50	PASS
3.70	10	-20	-0.024	±2.50	PASS
3.70	20	-16	-0.019	±2.50	PASS
3.70	30	-18	-0.022	±2.50	PASS
3.70	40	-12	-0.014	±2.50	PASS
3.70	50	13	0.016	±2.50	PASS

4.7 Peak-to-Average Ratio (PAR)

LIMIT

The Peak-to-Average Ratio (PAR) of the transmission may not exceed 13 dB.

TEST CONFIGURATION

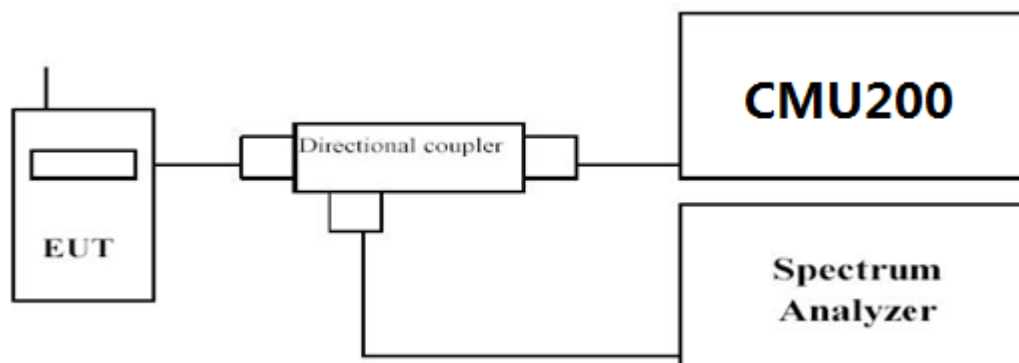

TEST PROCEDURE

1. Refer to instrument's analyzer instruction manual for details on how to use the power statistics/CCDF function;
2. Set resolution/measurement bandwidth \geq signal's occupied bandwidth;
3. Set the number of counts to a value that stabilizes the measured CCDF curve;
4. Set the measurement interval as follows:
 - 1). for continuous transmissions, set to 1 ms,
 - 2). for burst transmissions, employ an external trigger that is synchronized with the EUT burst timing sequence, or use the internal burst trigger with a trigger level that allows the burst to stabilize and set the measurement interval to a time that is less than or equal to the burst duration.
5. Record the maximum PAPR level associated with a probability of 0.1%.

TEST RESULTS

Test Mode	Channel	Frequency (MHz)	PAPR Value (dB)	Limits (dB)	Verdict
UMTS/TM1/ WCDMA Band II	9262	1852.40	3.63	13.0	PASS
	9400	1880.00	3.45	13.0	PASS
	9538	1907.60	3.26	13.0	PASS
UMTS/TM1/ WCDMA Band V	4132	826.40	4.02	13.0	PASS
	4182	836.40	3.90	13.0	PASS
	4233	846.60	4.44	13.0	PASS

Remark:

1. Test results including cable loss;
2. Please refer to following plots;

Peak-to-Average Ratio (PAR)

UMTS/TM1/ WCDMA Band II

UMTS/TM1/ WCDMA Band V

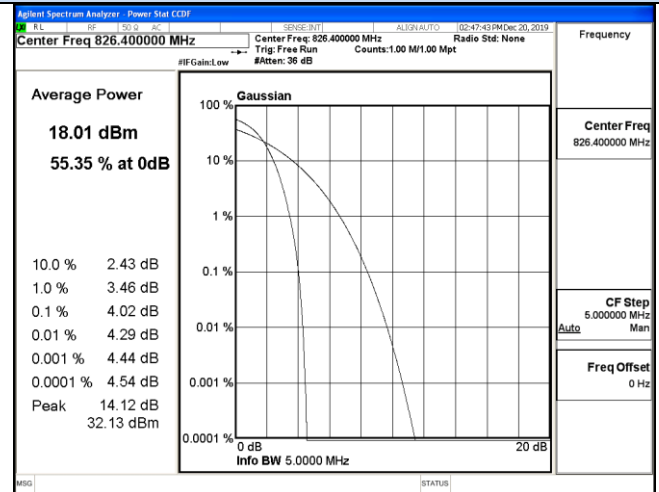
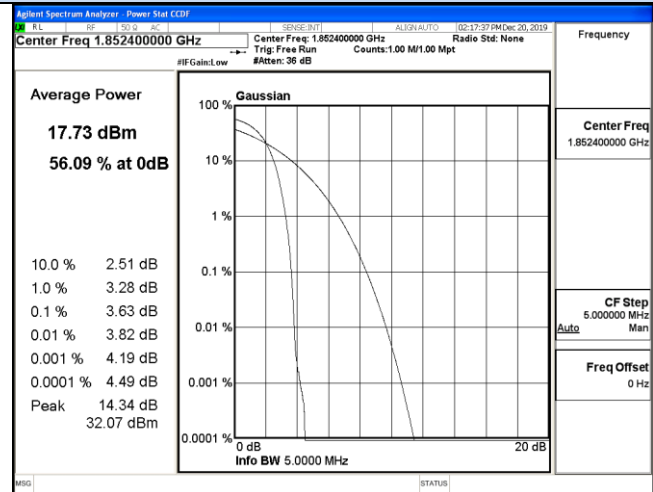

Channel 9262 / 1852.4 MHz

Channel 4132/ 826.4 MHz

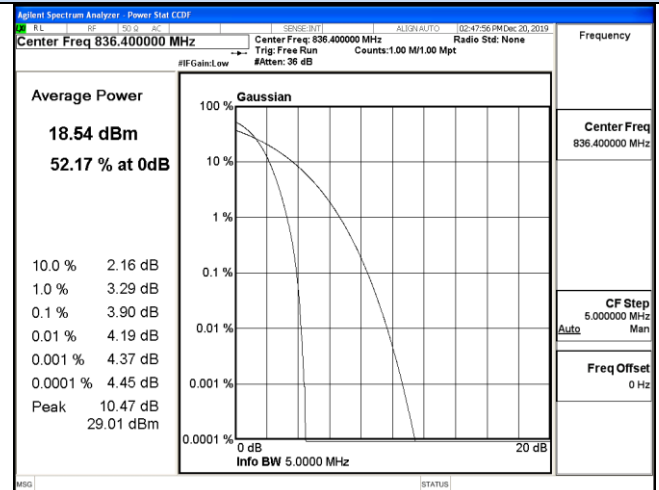
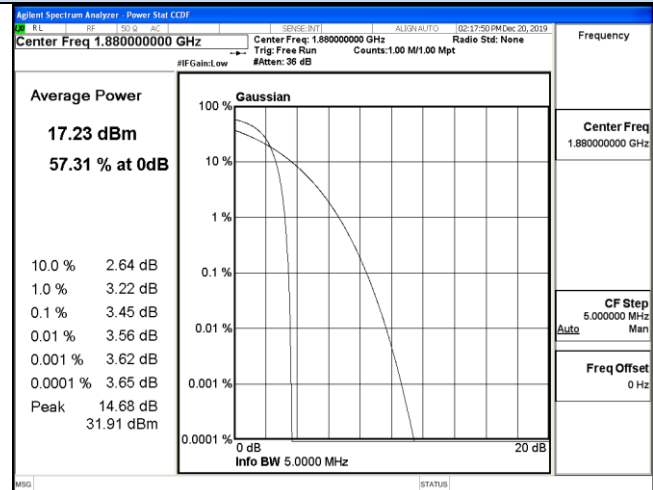

Channel 9400 / 1880.0 MHz

Channel 4182/ 836.4 MHz

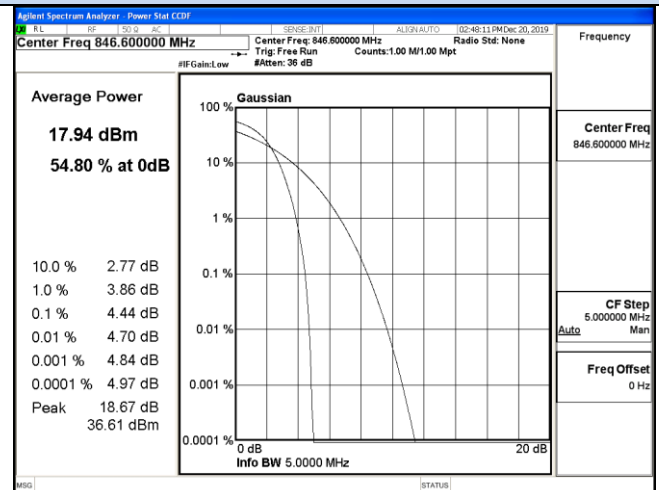
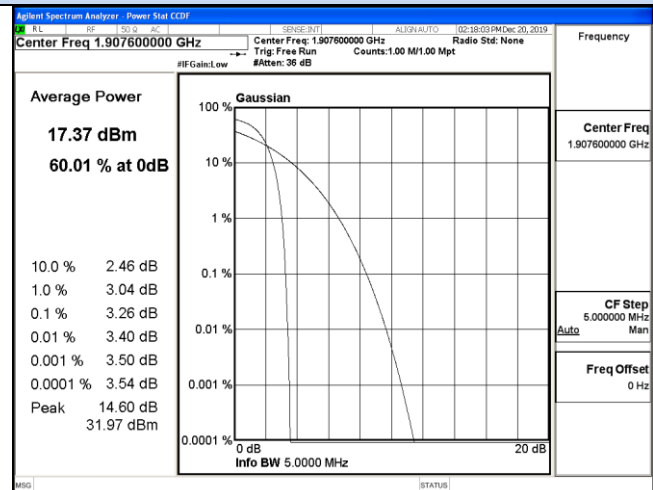

Channel 9538 / 1907.6 MHz

Channel 4233/ 846.6 MHz

5 Test Setup Photos of the EUT

Please refer to separated files for Test Setup Photos of the EUT.

6 External Photos of the EUT

Please refer to separated files for External Photos of the EUT.

7 Internal Photos of the EUT

Please refer to separated files for Internal Photos of the EUT.

.....**End of Report**.....