



FCC - TEST REPORT

Report Number : **68.910.19.0068.01** Date of Issue: June 15, 2020

Model : ST100

Product Type : Mini Stepper

Applicant : Qingdao Triple Master health technologies Co., LTD.

Address : No.3 Road, Qingda Industrial District, ChengYang, Qingdao, China

Factory : Qingdao Triple Master health technologies Co., LTD..

Address : No.3 Road, Qingda Industrial District, ChengYang, Qingdao, China

Test Result : Positive Negative

Total pages including Appendices : 39

TÜV SÜD Certification and Testing (China) Co., Ltd. Shenzhen Branch is a subcontractor to TÜV SÜD Product Service GmbH according to the principles outlined in ISO 17025.

TÜV SÜD Certification and Testing (China) Co., Ltd. Shenzhen Branch reports apply only to the specific samples tested under stated test conditions. Construction of the actual test samples has been documented. It is the manufacturer's responsibility to assure that additional production units of this model are manufactured with identical electrical and mechanical components. The manufacturer/importer is responsible to the Competent Authorities in Europe for any modifications made to the production units which result in non-compliance to the relevant regulations. TÜV SÜD Certification and Testing (China) Co., Ltd. Shenzhen Branch shall have no liability for any deductions, inferences or generalizations drawn by the client or others from TÜV SÜD Certification and Testing (China) Co., Ltd. Shenzhen Branch issued reports.

This report is the confidential property of the client. As a mutual protection to our clients, the public and ourselves, extracts from the test report shall not be reproduced except in full without our written approval.



1 Table of Contents

1	Table of Contents.....	2
2	Details about the Test Laboratory	3
3	Description of the Equipment Under Test.....	4
4	Summary of Test Standards	5
5	Summary of Test Results.....	6
6	General Remarks.....	7
7	Test Setups	8
8	Systems test configuration.....	9
9	Technical Requirement.....	10
9.1	Conducted peak output power.....	10
9.2	Power spectral density	13
9.3	6 dB Bandwidth and 99% Occupied Bandwidth.....	16
9.4	Spurious RF conducted emissions.....	20
9.5	Band edge.....	24
9.6	Spurious radiated emissions for transmitter	26
10	Test Equipment List.....	38
11	System Measurement Uncertainty	39



2 Details about the Test Laboratory

Details about the Test Laboratory

Test Site 1

Company name: TÜV SÜD Certification and Testing (China) Co., Ltd. Shenzhen Branch
Building 12 & 13, Zhiheng Wisdomland Business Park, Nantou Checkpoint
Road 2, Nanshan District
Shenzhen 518052
P.R. China

Telephone: 86 755 8828 6998

Fax: 86 755 8288 5299

FCC Registration No.: 514049



3 Description of the Equipment Under Test

Product:	Mini Stepper
Model no.:	ST100
FCC ID:	2AULA-ST100
Options and accessories:	N/A
Rating:	3.0VDC(Supplied by 2*1.5V battery)
RF Transmission Frequency:	2402MHz-2480MHz
No. of Operated Channel:	40
Modulation:	GFSK
Antenna Type:	PCB Antenna
Antenna Gain:	-3dBi
Description of the EUT:	The Equipment Under Test (EUT) is Mini Stepper operated at 2.4GHz



4 Summary of Test Standards

Test Standards	
FCC Part 15 Subpart C 10-1-2019 Edition	PART 15 - RADIO FREQUENCY DEVICES Subpart C - Intentional Radiators

All the test methods were according to KDB558074 D01 v05r02 DTS Measurement Guidance and ANSI C63.10 (2013).

5 Summary of Test Results

Technical Requirements						
FCC Part 15 Subpart C						
Test Condition		Page s	Test Site	Test Result		
				Pass	Fail	N/A
§15.207	Conducted emission AC power port	--	--	<input type="checkbox"/>	<input type="checkbox"/>	<input checked="" type="checkbox"/>
§15.247 (b) (1)	Conducted peak output power	10	Site 1	<input checked="" type="checkbox"/>	<input type="checkbox"/>	<input type="checkbox"/>
§15.247(a)(1)	20dB bandwidth	---	---	<input type="checkbox"/>	<input type="checkbox"/>	<input checked="" type="checkbox"/>
§15.247(a)(1)	Carrier frequency separation	---	---	<input type="checkbox"/>	<input type="checkbox"/>	<input checked="" type="checkbox"/>
§15.247(a)(1)(iii)	Number of hopping frequencies	---	---	<input type="checkbox"/>	<input type="checkbox"/>	<input checked="" type="checkbox"/>
§15.247(a)(1)(iii)	Dwell Time	---	---	<input type="checkbox"/>	<input type="checkbox"/>	<input checked="" type="checkbox"/>
§15.247(a)(2)	6dB bandwidth and 99% Occupied Bandwidth	13	Site 1	<input checked="" type="checkbox"/>	<input type="checkbox"/>	<input type="checkbox"/>
§15.247(e)	Power spectral density	16	Site 1	<input checked="" type="checkbox"/>	<input type="checkbox"/>	<input type="checkbox"/>
§15.247(d)	Spurious RF conducted emissions	20	Site 1	<input checked="" type="checkbox"/>	<input type="checkbox"/>	<input type="checkbox"/>
§15.247(d)	Band edge	24	Site 1	<input checked="" type="checkbox"/>	<input type="checkbox"/>	<input type="checkbox"/>
§15.247(d) & §15.209 & §15.205	Spurious radiated emissions for transmitter	26	Site 1	<input checked="" type="checkbox"/>	<input type="checkbox"/>	<input type="checkbox"/>
§15.203	Antenna requirement	See note 1		<input checked="" type="checkbox"/>	<input type="checkbox"/>	<input type="checkbox"/>

Note 1: N/A=Not Applicable.

Note 2: The EUT uses a PCB Antenna, which gain is -3dBi. In accordance to §15.203, it is considered sufficiently to comply with the provisions of this section.



6 General Remarks

Remarks

This submittal(s) (test report) is intended for FCC ID: 2AULA-ST100 complies with Section 15.205, 15.209, 15.247 of the FCC Part 15, Subpart C.

SUMMARY:

All tests according to the regulations cited on page 5 were

n - Performed

o - **Not** Performed

The Equipment under Test

n - **Fulfills** the general approval requirements.

o - **Does not** fulfill the general approval requirements.

Sample Received Date: August 22, 2019

Testing Start Date: August 22, 2019

Testing End Date: February 29, 2020

- TÜV SÜD Certification and Testing (China) Co., Ltd. Shenzhen Branch -

Reviewed by:

Prepared by:

Tested by:

John Zhi
EMC Project Manager

Mark Chen
EMC Project Engineer

Tree Zhan
EMC Test Engineer

7 Test Setups

Below 1GHz

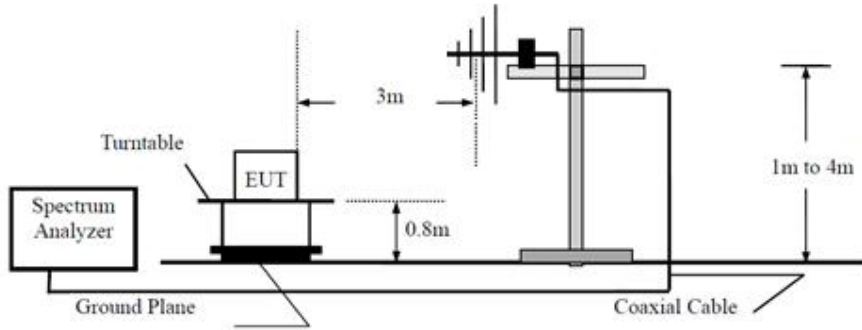

Above 1GHz

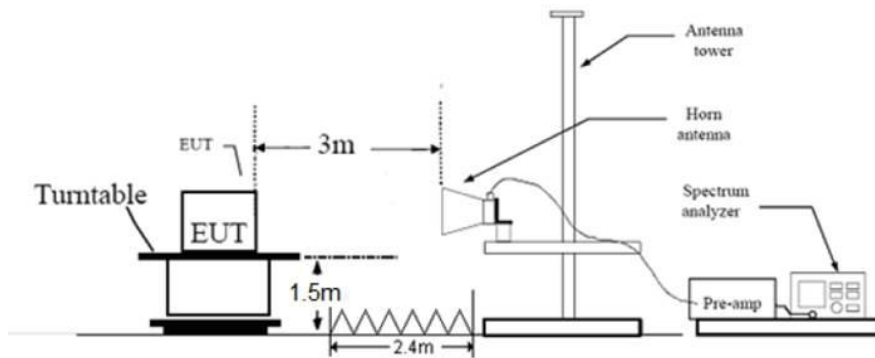

Conducted RF test setups

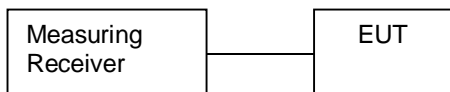

8 Systems test configuration

Auxiliary Equipment Used during Test:

DESCRIPTION	MANUFACTURER	MODEL NO.(SHIELD)	S/N(LENGTH)
Notebook	Lenovo	X220	---
Adapter	---	---	---

Test software: nRFgo Test Tool, which used to control the EUT in continues transmitting mode.

The system was configured to channel 0, 19, and 39 for the test.



9 Technical Requirement

9.1 Conducted peak output power

Test Method

1. Use the following spectrum analyzer settings:
 RBW > the 6dB bandwidth of the emission being measured, VBW≥3RBW, Span≥3RBW
 Sweep = auto, Detector function = peak, Trace = max hold.
2. Add a correction factor to the display.
3. Allow the trace to stabilize. Use the marker-to-peak function to set the marker to the peak of the emission. The indicated level is the peak output power.

Limits

According to §15.247 (b) (1), conducted peak output power limit as below:

Frequency Range MHz	Limit W	Limit dBm
2400-2483.5	≤1	≤30

Test result as below table

Frequency MHz	Conducted Peak Output Power dBm	Result
Low channel 2402MHz	1.05	Pass
Middle channel 2440MHz	0.89	Pass
High channel 2480MHz	0.07	Pass



Low channel 2402MHz

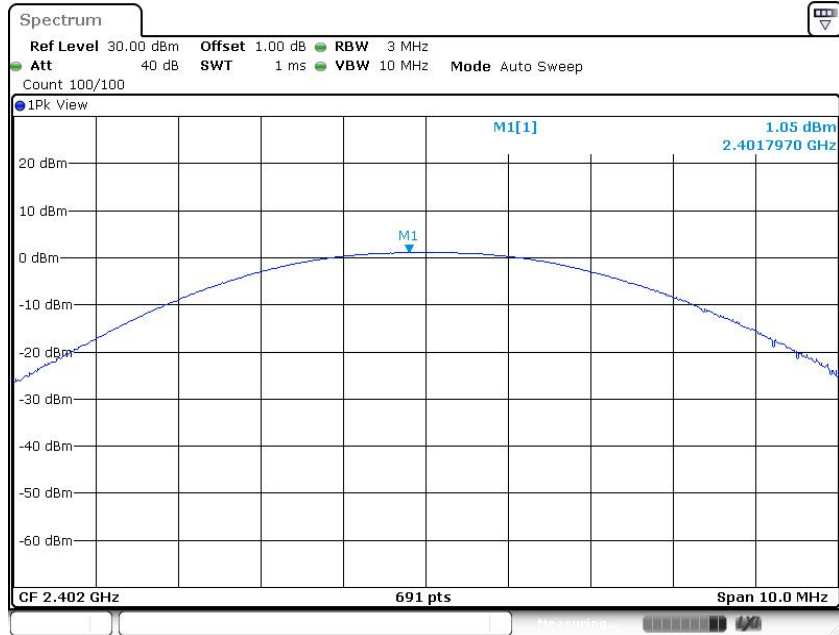

Date: 8 JAN 2020 09:59:11

Middle channel 2440MHz

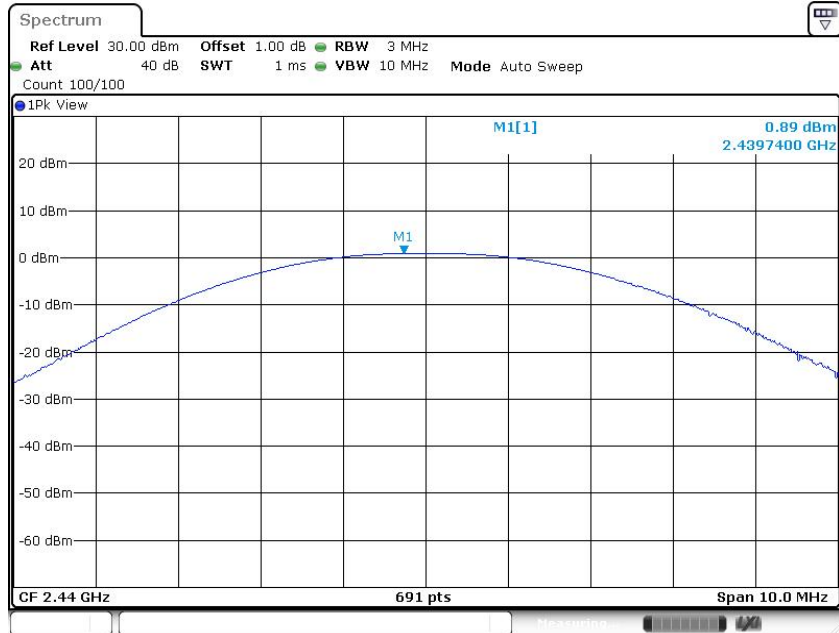

Date: 8 JAN 2020 10:01:12



High channel 2480MHz

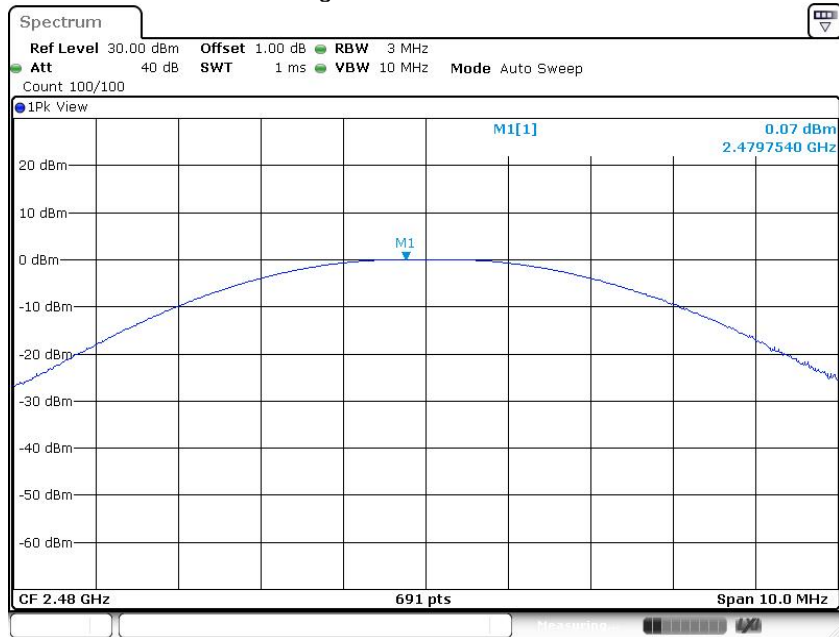

Date: 8 JAN 2020 10:04:06



9.2 Power spectral density

Test Method

This procedure shall be used if maximum peak conducted output power was used to demonstrate compliance:

1. Set analyzer center frequency to DTS channel center frequency. RBW=3kHz, VBW≥3RBW, Span=1.5 times DTS bandwidth, Detector=Peak, Sweep=auto, Trace= max hold.
2. Allow trace to fully stabilize, use the peak marker function to determine the maximum amplitude level within the RBW.
3. Repeat above procedures until other frequencies measured were completed.

Limit

Limit [dBm]

≤8dBm/3KHz

Test result

Frequency MHz	Power spectral density dBm/3KHz	Result
Top channel 2402MHz	-13.07	Pass
Middle channel 2440MHz	-13.88	Pass
Bottom channel 2480MHz	-14.77	Pass



Low channel 2402MHz

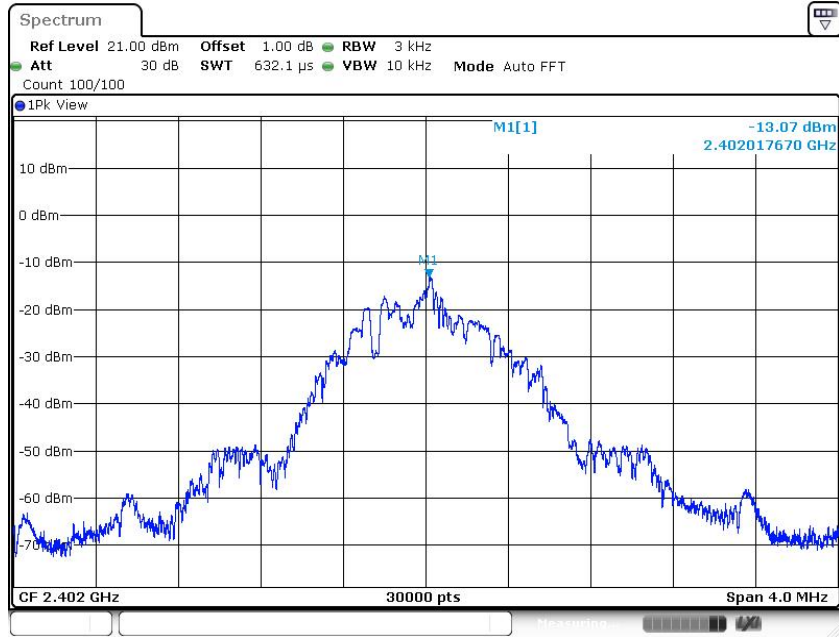

Date: 8 JAN 2020 09:59:17

Middle channel 2440MHz

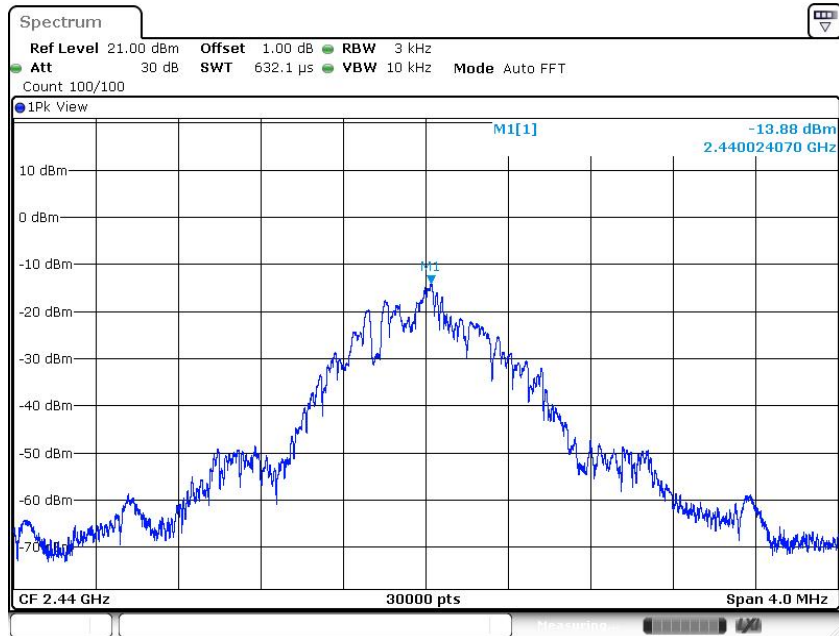

Date: 8 JAN 2020 10:01:18



High channel 2480MHz



Date: 8 JAN 2020 10:04:12



9.3 6 dB Bandwidth and 99% Occupied Bandwidth

Test Method

1. Use the following spectrum analyzer settings:
RBW=100K, VBW≥3RBW, Sweep = auto, Detector function = peak, Trace = max hold
2. Use the automatic bandwidth measurement capability of an instrument, may be employed using the X dB bandwidth mode with X set to 6 dB, care shall be taken so that the bandwidth measurement is not influenced by any intermediate power nulls in the fundamental emission that might be ≥ 6 dB.
3. Allow the trace to stabilize, record the X dB Bandwidth value.

Limit

Limit [kHz]

≥500

Test result

Frequency MHz	6dB bandwidth kHz	99 bandwidth kHz	Result
Bottom channel 2402MHz	684	1019	Pass
Middle channel 2440MHz	672	1015	Pass
Top channel 2480MHz	680	1027	Pass



6 dB Bandwidth

Low channel 2402MHz

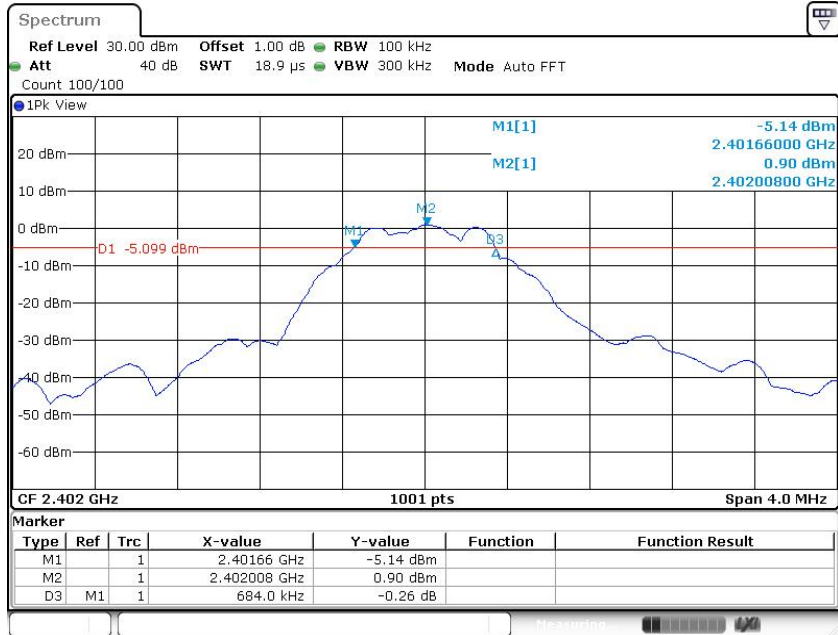

Date: 8 JAN 2020 09:58:53



Date: 8 JAN 2020 09:59:04



Middle channel 2440MHz

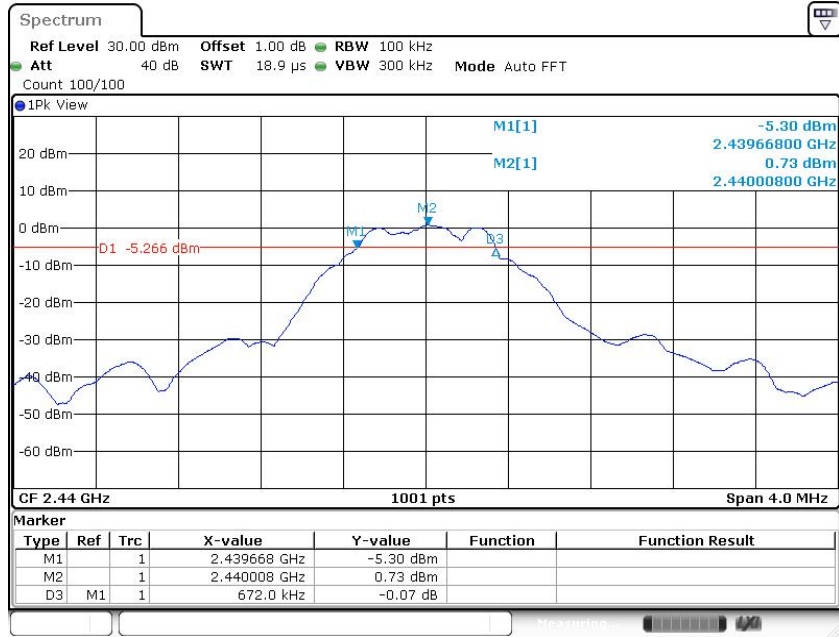

Date: 8 JAN 2020 10:00:54



Date: 8 JAN 2020 10:01:06



High channel 2480MHz

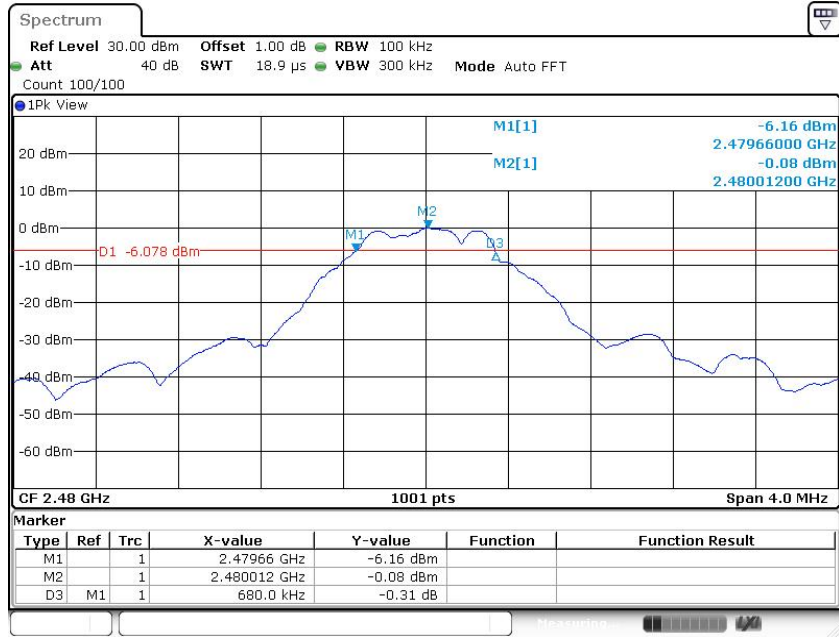

Date: 8 JAN 2020 10:03:48

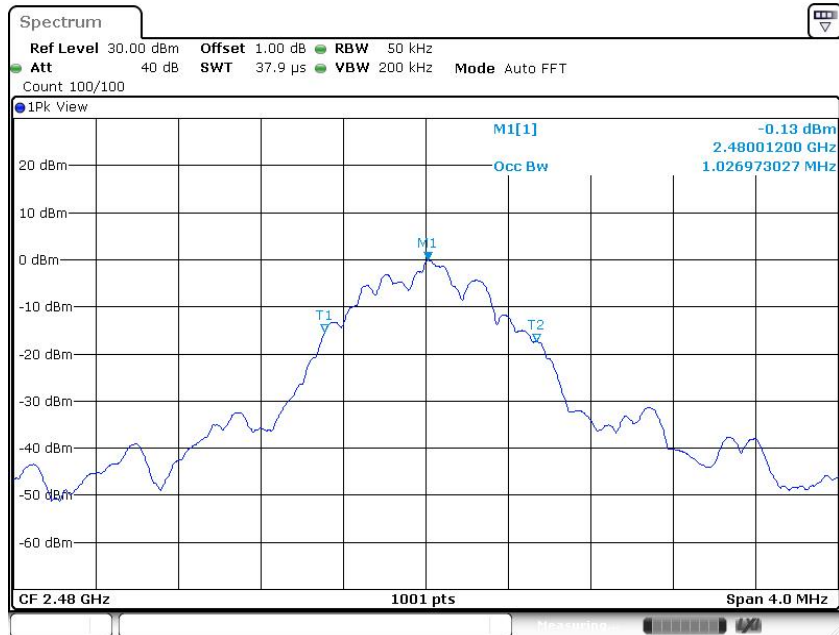

Date: 8 JAN 2020 10:03:59



9.4 Spurious RF conducted emissions

Test Method

1. Establish a reference level by using the following procedure:
 - a. Set RBW=100 kHz. VBW≥3RBW. Detector =peak, Sweep time = auto couple, Trace mode = max hold.
 - b. Allow trace to fully stabilize, use the peak marker function to determine the maximum PSD level.
2. Use the maximum PSD level to establish the reference level.
 - a. Set the center frequency and span to encompass frequency range to be measured.
 - b. Use the peak marker function to determine the maximum amplitude level. Ensure that the amplitude of all unwanted emissions outside of the authorized frequency band (excluding restricted frequency bands) are attenuated by at least the minimum requirements, report the three highest emissions relative to the limit.
3. Repeat above procedures until other frequencies measured were completed.

Limit

Frequency Range MHz	Limit (dBc)
30-25000	-20



Spurious RF conducted emissions

2402MHz

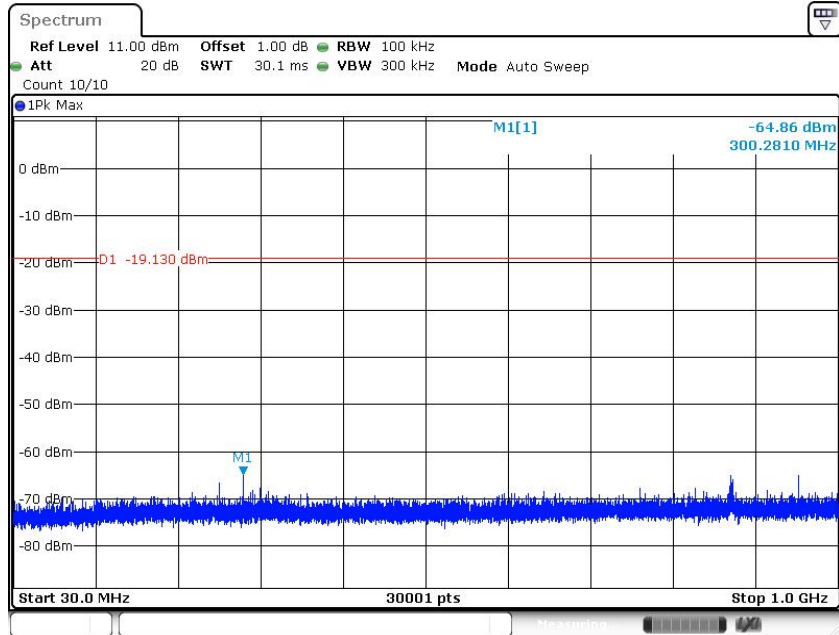

Date: 8 JAN 2020 09:59:43

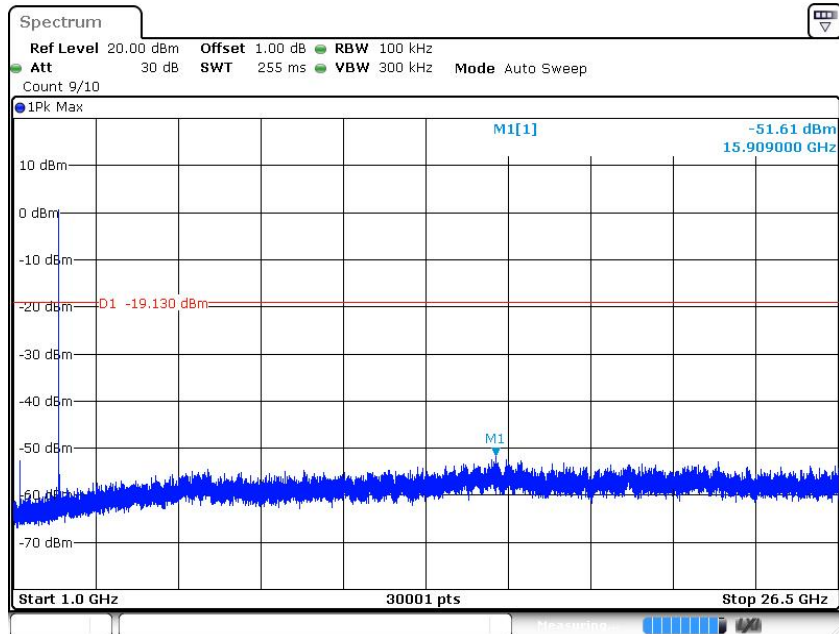

Date: 8 JAN 2020 09:59:54



2440MHz

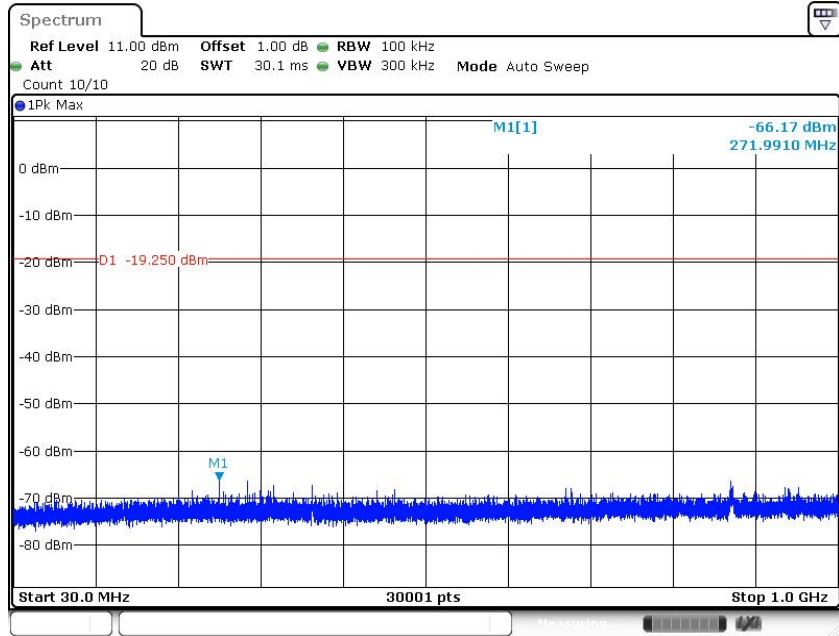

Date: 8 JAN 2020 10:01:34

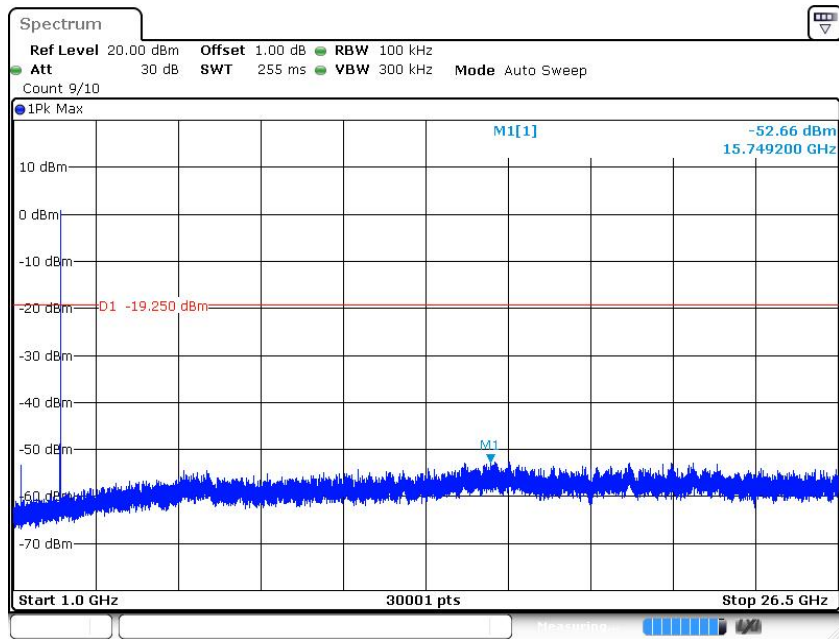

Date: 8 JAN 2020 10:01:45



2480MHz

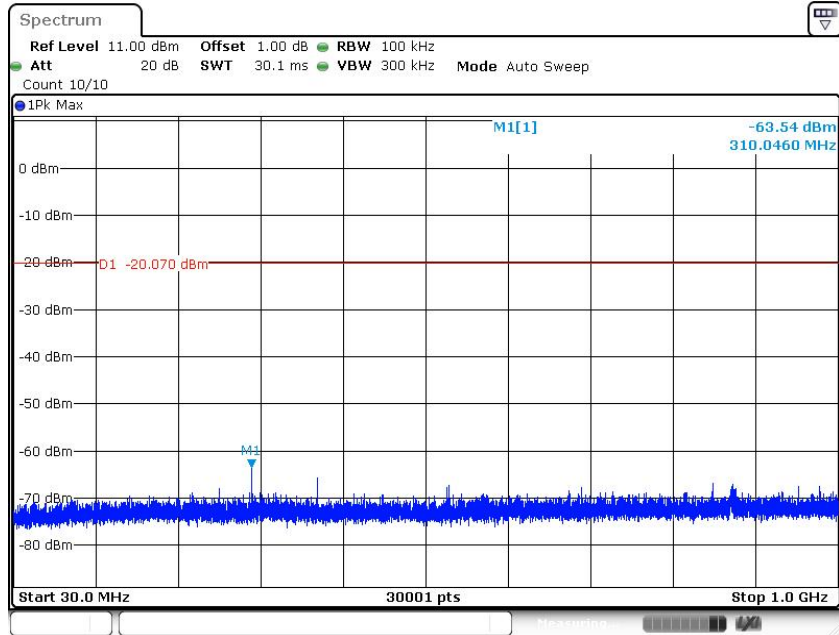

Date: 8 JAN 2020 10:04:37

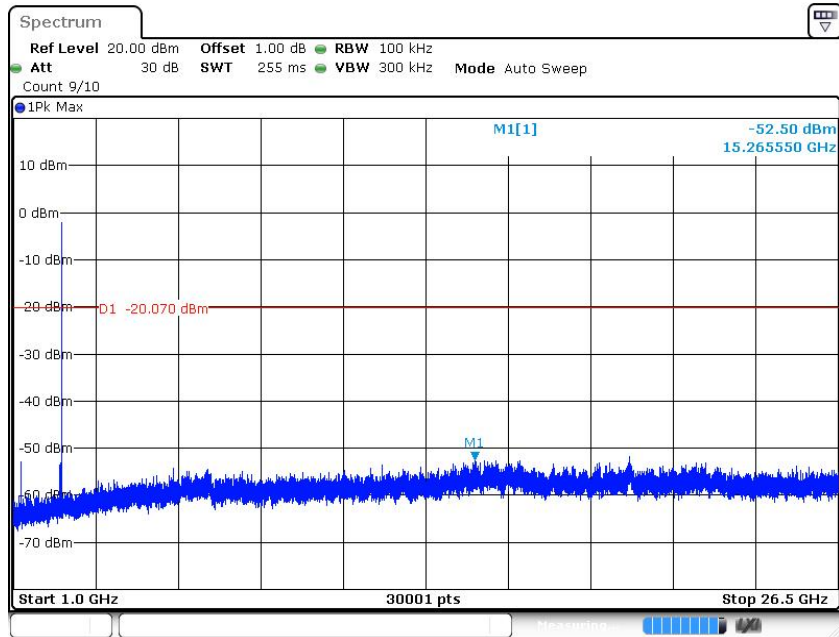

Date: 8 JAN 2020 10:04:49

9.5 Band edge

Test Method

- 1 Use the following spectrum analyzer settings:
Span = wide enough to capture the peak level of the in-band emission and all spurious
RBW = 100 kHz, VBW \geq RBW, Sweep = auto, Detector function = peak, Trace = max hold.
- 2 Allow the trace to stabilize, use the peak and delta measurement to record the result.
- 3 The level displayed must comply with the limit specified in this Section.

Limit

Frequency Range MHz	Limit (dBc)
30-25000	-20

Band edge testing

2402MHz

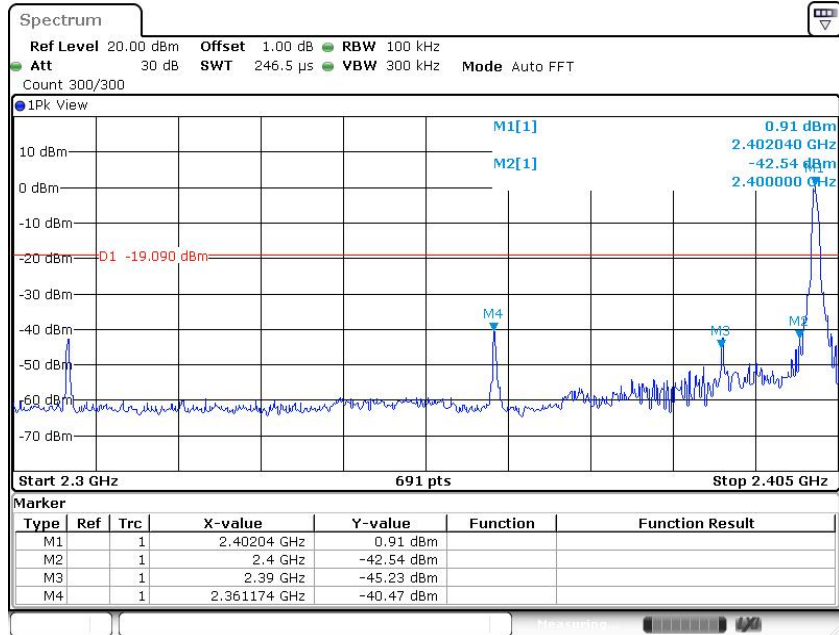

Date: 8 JAN 2020 09:59:27

2480MHz

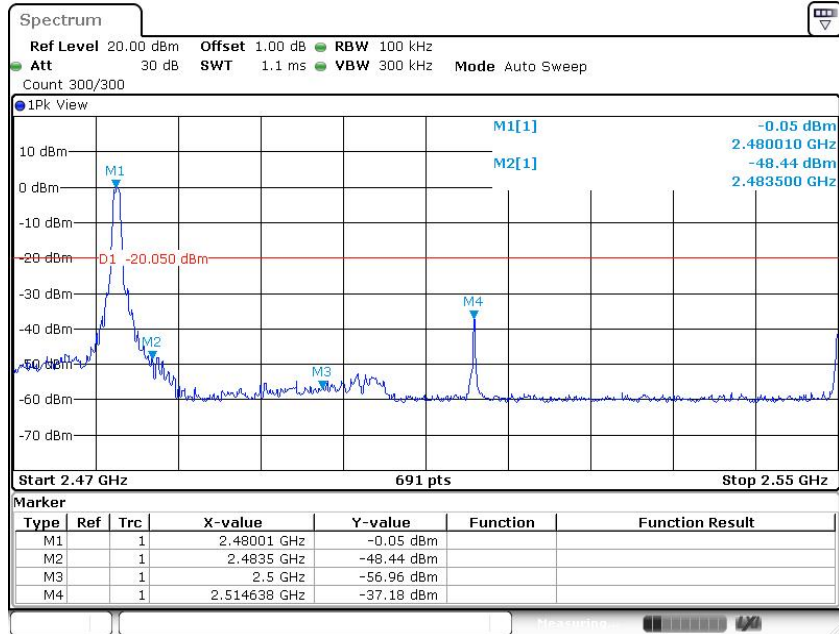

Date: 8 JAN 2020 10:04:22

9.6 Spurious radiated emissions for transmitter

Test Method

- 1: The EUT was placed on a turn table which is 1.5m above ground plane for above 1GHz and 0.8m above ground for below 1GHz at 3 meter chamber room for test. The table was rotated 360 degrees to determine the position of the highest radiation.
- 2: The EUT was set 3 meters away from the interference – receiving antenna, which was mounted on the top of a variable – height antenna tower.
- 3: The height of antenna is varied from one meter to four meters above the ground to determine the maximum value of the field strength. Both horizontal and vertical polarizations of the antenna are set to make the measurement.
- 4: For each suspected emission, the EUT was arranged to its worst case and then the antenna was tuned to heights from 1 meter to 4 meters and the rotatable table was turned from 0 degrees to 360 degrees to find the maximum reading.
- 5: Use the following spectrum analyzer settings According to C63.10:

For Below 1GHz

Use the following spectrum analyzer settings:

Span = wide enough to capture the peak level of the in-band emission and all spurious
 RBW = 100 KHz to 120KHz, VBW ≥ RBW for peak measurement, Sweep = auto, Detector function = peak, Trace = max hold.

For Peak unwanted emissions Above 1GHz:

Span = wide enough to capture the peak level of the in-band emission and all spurious
 RBW = 1MHz, VBW ≥ RBW for peak measurement, Sweep = auto, Detector function = peak, Trace = max hold.

Procedures for average unwanted emissions measurements above 1000 MHz

- a) RBW = 1 MHz.
- b) VBW ≥ [3 × RBW].
- c) Detector = RMS (power averaging), if $[\text{span} / (\# \text{ of points in sweep})] \setminus \text{RBW} / 2$. Satisfying this condition can require increasing the number of points in the sweep or reducing the span. If the condition is not satisfied, then the detector mode shall be set to peak.
- d) Averaging type = power (i.e., rms) (As an alternative, the detector and averaging type may be set for linear voltage averaging. Some instruments require linear display mode to use linear voltage averaging. Log or dB averaging shall not be used.)
- e) Sweep time = auto.
- f) Perform a trace average of at least 100 traces if the transmission is continuous. If the transmission is not continuous, then the number of traces shall be increased by a factor of $1 / D$, where D is the duty cycle. For example, with 50% duty cycle, at least 200 traces shall be averaged. (If a specific emission is demonstrated to be continuous—i.e., 100% duty cycle—then rather than turning ON and OFF with the transmit cycle, at least 100 traces shall be averaged.)
- g) If tests are performed with the EUT transmitting at a duty cycle less than 98%, then a correction factor shall be added to the measurement results prior to comparing with the emission limit, to compute the emission level that would have been measured had the test been performed at 100% duty cycle. The correction factor is computed as follows:
 - 1) If power averaging (rms) mode was used in the preceding step e), then the correction factor is $[10 \log (1 / D)]$, where D is the duty cycle. For example, if the transmit duty



cycle was 50%, then 3 dB shall be added to the measured emission levels.

2) If linear voltage averaging mode was used in the preceding step e), then the correction factor is $[20 \log (1 / D)]$, where D is the duty cycle. For example, if the transmit duty cycle was 50%, then 6 dB shall be added to the measured emission levels.

3) If a specific emission is demonstrated to be continuous (100% duty cycle) rather than turning ON and OFF with the transmit cycle, then no duty cycle correction is required for that emission.

Limit

The radio emission outside the operating frequency band shall be at least 20 dB below that in the 100 kHz bandwidth within the band that contains the highest level of the desired power. Radiated emissions which fall in the restricted bands, as defined in section 15.205, must comply with the radiated emission limits specified in section 15.209.

Frequency MHz	Field Strength uV/m	Field Strength dBµV/m	Detector
30-88	100	40	QP
88-216	150	43.5	QP
216-960	200	46	QP
960-1000	500	54	QP
Above 1000	500	54	AV
Above 1000	5000	74	PK

Spurious radiated emissions for transmitter

According to C63.10, if the peak (or quasi-peak) measured value complies with the average limit, it is unnecessary to perform an average measurement, so AV emission value did not show in below table if the peak value complies with average limit.

Transmitting spurious emission test result as below:

Low channel 2402MHz Test Result

Frequency Band	Frequency	Emission Level	Polarization	Limit	Detector	Margin	Correct factor	Result
	MHz	dBuV/m		dBμV/m		dBuV/m		
30-1000MHz	930.59	930.59	H	46	QP	13.60	24.0	Pass
	718.27	30.70	V	46	QP	15.30	21.6	Pass
1000-25000MHz	4804*	55.47	H	74	PK	18.53	2.5	Pass
	4804*	48.49	H	54	AV	5.51	2.5	Pass
	4804*	53.86	V	74	PK	20.14	2.5	Pass
	4804*	45.62	V	54	AV	8.38	2.5	Pass

Middle channel 2440MHz Test Result

Frequency Band	Frequency	Emission Level	Polarization	Limit	Detector	Margin	Correct factor	Result
	MHz	dBuV/m		dBμV/m		dBuV/m		
30-1000MHz	--	--	H	43.5	QP	--	--	Pass
	--	--	H	46	QP	--	--	Pass
1000-25000MHz	9760*	53.71	H	74	PK	20.29	7.7	Pass
	9760*	45.68	H	54	AV	8.32	7.7	Pass
	7320*	54.93	V	74	PK	19.07	7.7	Pass
	7320*	41.25	V	54	AV	12.75	7.7	Pass

High channel 2480MHz Test Result

Frequency Band	Frequency	Emission Level	Polarization	Limit	Detector	Margin	Correct factor (dB/m)	Result
	MHz	dBuV/m		dBμV/m		dBuV/m		
30-1000MHz	--	--	H	43.5	QP	--	--	Pass
	--	--	H	46	QP	--	--	Pass
1000-25000MHz	7440*	56.75	H	74	PK	17.25	5.9	Pass
	7440*	43.51	H	54	AV	10.49	5.9	Pass
	7440*	52.38	V	74	PK	21.62	5.9	Pass
	7440*	41.01	V	54	AV	12.99	5.9	Pass

Remark:

- (1) "*" means the emission(s) appear within the restrict bands shall follow the requirement of section 15.205.
- (2) Data of measurement within this frequency range shown "--" in the table above means the reading of emissions are the noise floor or attenuated more than 10dB below the permissible limits or the field strength is too small to be measured.
- (3) Level=Reading Level + Correction Factor
 Above 1GHz: Corrector factor = Antenna Factor + Cable Loss- Amplifier Gain
 Below 1GHz: Corrector factor = Antenna Factor + Cable Loss
 (The Reading Level is recorded by software which is not shown in the sheet)

Remark: No emissions above 18GHz, so no test plots above 18GHz in report.

EUT: Mini Stepper
 M/N: ST100
 Operating Condition: BLE (Tx 2402MHz, lowest Channel), Below 1GHz

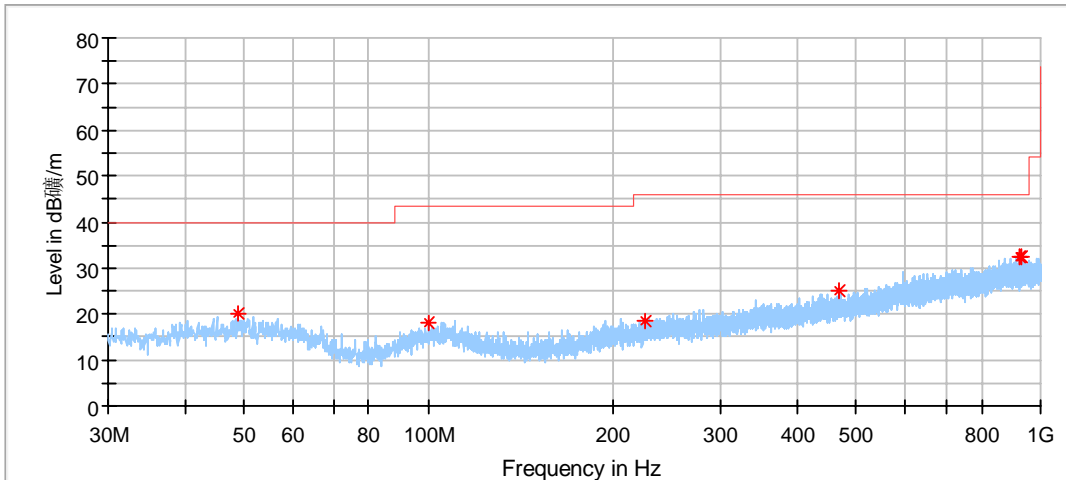

Critical Freqs

Frequency (MHz)	MaxPeak (dBµV/m)	Limit (dBµV/m)	Margin (dB)	Height (cm)	Pol	Azimuth (deg)	Corr. (dB/m)
48.861111	20.28	40.00	19.72	150.0	H	0.0	14.7
99.947778	17.85	43.50	25.65	150.0	H	315.0	12.9
226.586667	18.51	46.00	27.49	150.0	H	261.0	12.7
469.302222	25.03	46.00	20.97	150.0	H	213.0	17.5
926.010556	32.26	46.00	13.74	150.0	H	0.0	24.0
930.591111	32.40	46.00	13.60	150.0	H	129.0	24.0



EUT: Mini Stepper
 M/N: ST100
 Operating Condition: BLE (Tx 2402MHz, lowest Channel), Below 1GHz

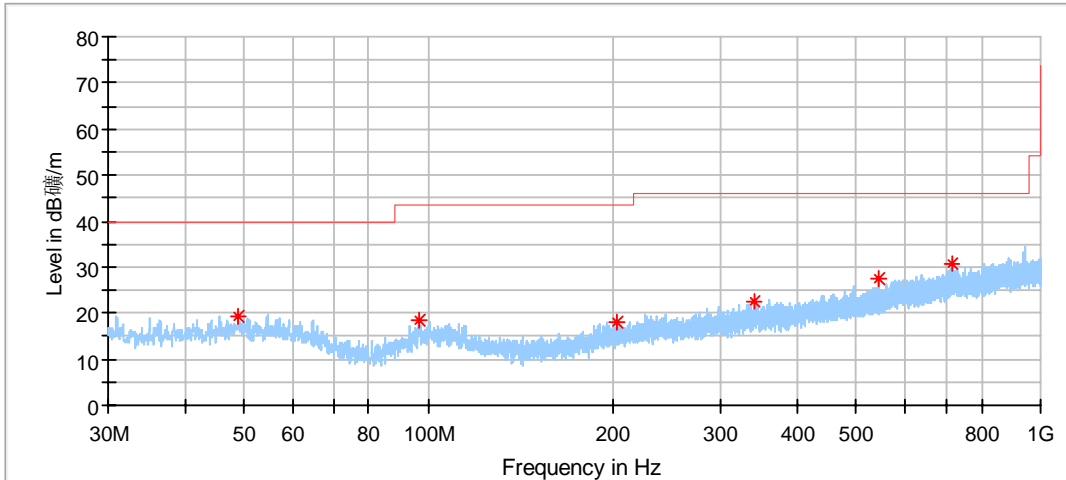

Critical_Freqs

Frequency (MHz)	MaxPeak (dBµV/m)	Limit (dBµV/m)	Margin (dB)	Height (cm)	Pol	Azimuth (deg)	Corr. (dB/m)
48.807222	19.37	40.00	20.63	150.0	V	254.0	14.7
96.337222	18.45	43.50	25.05	150.0	V	281.0	12.3
202.660000	17.93	43.50	25.57	150.0	V	229.0	12.1
341.316111	22.49	46.00	23.51	150.0	V	139.0	15.5
542.160000	27.36	46.00	18.64	150.0	V	281.0	18.7
718.268889	30.70	46.00	15.30	150.0	V	76.0	21.6



EUT: Mini Stepper
 M/N: ST100
 Operating Condition: BLE (Tx 2402MHz, lowest Channel), 1GHz-18GHz

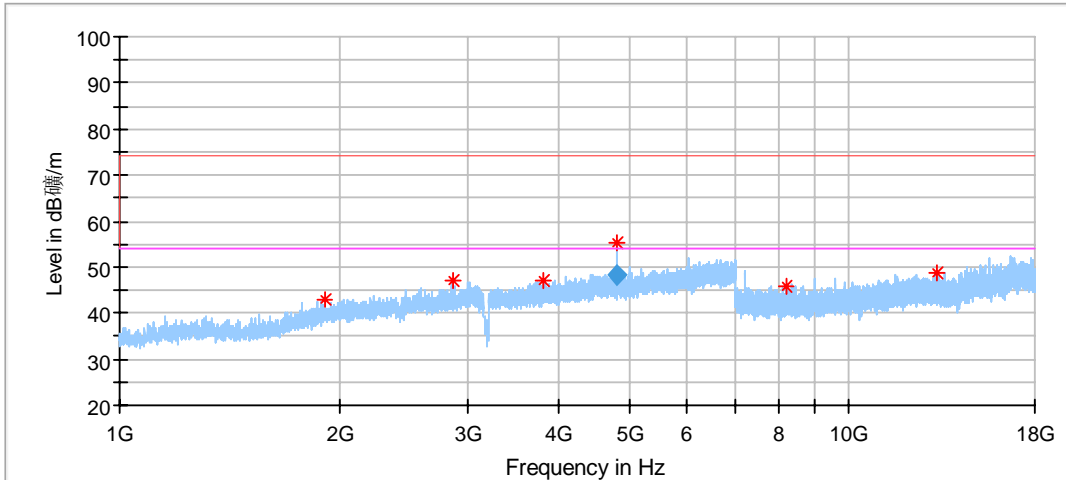

Critical Freqs

Frequency (MHz)	MaxPeak (dBµV/m)	Limit (dBµV/m)	Margin (dB)	Height (cm)	Pol	Azimuth (deg)	Corr. (dB/m)
1911.500000	42.97	74.00	31.03	150.0	H	0.0	-5.4
2857.000000	47.28	74.00	26.72	150.0	H	0.0	-2.9
3821.500000	47.08	74.00	26.92	150.0	H	166.0	0.7
4804.500000	55.47	74.00	18.53	150.0	H	356.0	2.5
8202.500000	45.76	74.00	28.24	150.0	H	95.0	6.9
13233.000000	48.92	74.00	25.08	150.0	H	221.0	9.9

Final Result

Frequency (MHz)	Average (dBµV/m)	Limit (dBµV/m)	Margin (dB)	Height (cm)	Pol	Azimuth (deg)	Corr. (dB/m)
4804.500000	48.49	54.00	5.51	150.0	H	356.0	2.5



EUT: Mini Stepper
 M/N: ST100
 Operating Condition: BLE (Tx 2402MHz, lowest Channel), 1GHz-18GHz

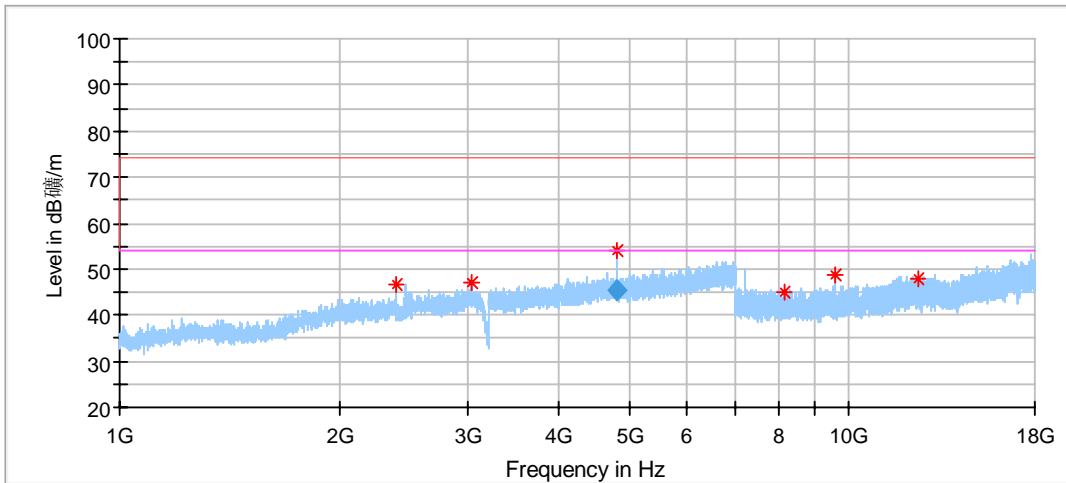

Critical_Freqs

Frequency (MHz)	MaxPeak (dBµV/m)	Limit (dBµV/m)	Margin (dB)	Height (cm)	Pol	Azimuth (deg)	Corr. (dB/m)
2391.500000	46.86	74.00	27.14	150.0	V	156.0	-3.9
3047.500000	47.20	74.00	26.80	150.0	V	210.0	-1.1
4804.000000	53.86	74.00	20.14	150.0	V	169.0	2.5
8178.500000	44.87	74.00	29.13	150.0	V	174.0	6.5
9607.500000	48.61	74.00	25.39	150.0	V	174.0	7.5
12462.000000	47.74	74.00	26.26	150.0	V	92.0	9.9

Final_Result

Frequency (MHz)	Average (dBµV/m)	Limit (dBµV/m)	Margin (dB)	Height (cm)	Pol	Azimuth (deg)	Corr. (dB/m)
4804.000000	45.62	54.00	8.38	150.0	V	169.0	2.5



EUT: Mini Stepper
 M/N: ST100
 Operating Condition: BLE (Tx 2440MHz, Middle Channel), 1GHz-18GHz

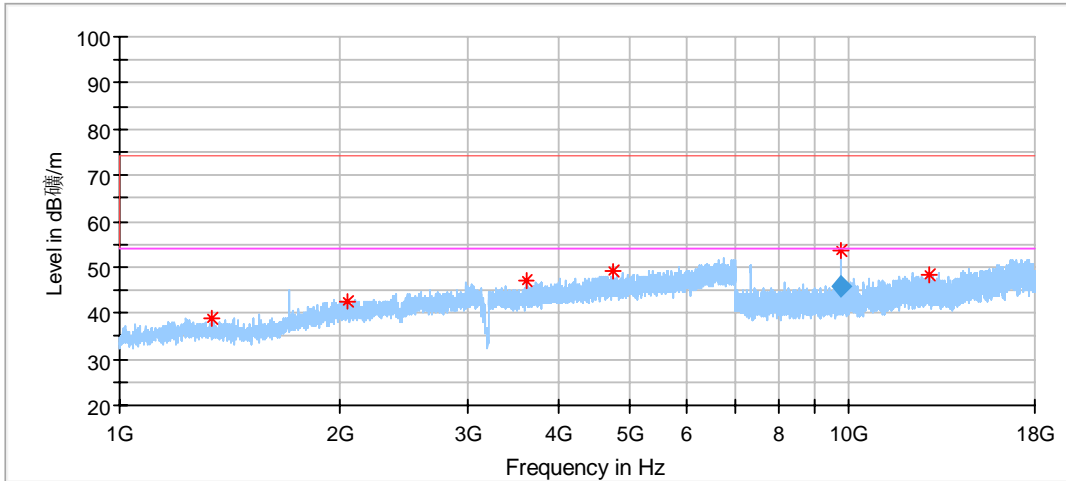

Critical_Freqs

Frequency (MHz)	MaxPeak (dBµV/m)	Limit (dBµV/m)	Margin (dB)	Height (cm)	Pol	Azimuth (deg)	Corr. (dB/m)
1341.000000	38.81	74.00	35.19	150.0	H	310.0	-8.7
2058.000000	42.57	74.00	31.43	150.0	H	194.0	-5.2
3617.500000	47.22	74.00	26.78	150.0	H	332.0	-0.6
4744.000000	49.16	74.00	24.84	150.0	H	354.0	3.0
9759.500000	53.71	74.00	20.29	150.0	H	250.0	7.7
12893.500000	48.21	74.00	25.79	150.0	H	351.0	10.0

Final_Result

Frequency (MHz)	Average (dBµV/m)	Limit (dBµV/m)	Margin (dB)	Height (cm)	Pol	Azimuth (deg)	Corr. (dB/m)
9759.500000	45.68	54.00	8.32	150.0	H	250.0	7.7



EUT: Mini Stepper
 M/N: ST100
 Operating Condition: BLE (Tx 2440MHz, Middle Channel), 1GHz-18GHz

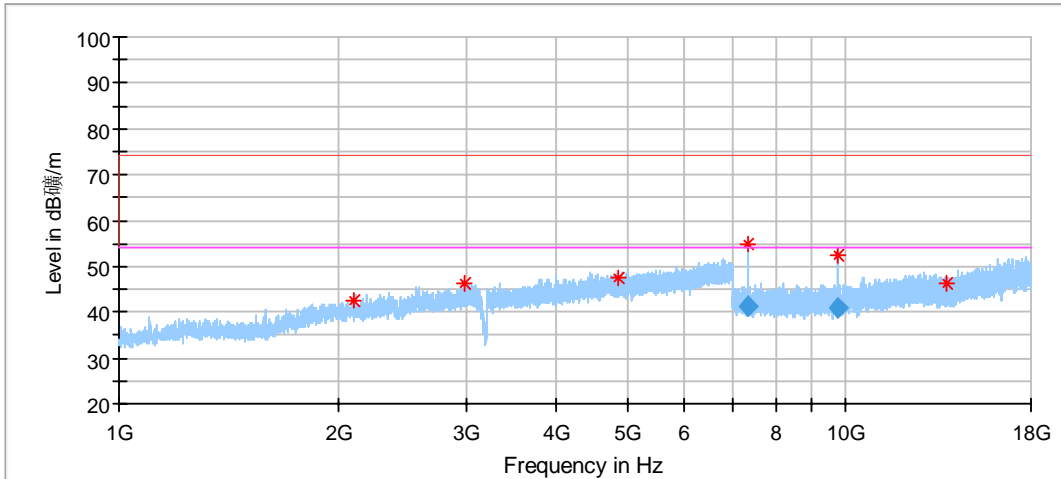

Critical Freqs

Frequency (MHz)	MaxPeak (dBµV/m)	Limit (dBµV/m)	Margin (dB)	Height (cm)	Pol	Azimuth (deg)	Corr. (dB/m)	Corr. (dB)
2104.000000	42.60	74.00	31.40	150.0	V	105.0	-4.8	---
2985.000000	46.44	74.00	27.56	150.0	V	66.0	-2.1	---
4876.500000	47.43	74.00	26.57	150.0	V	183.0	2.5	---
7320.500000	54.93	74.00	19.07	150.0	V	14.0	6.5	---
9759.500000	52.54	74.00	21.47	150.0	V	136.0	7.7	---
13767.000000	46.31	74.00	27.69	150.0	V	262.0	9.5	---

Final Result

Frequency (MHz)	Average (dBµV/m)	Limit (dBµV/m)	Margin (dB)	Height (cm)	Pol	Azimuth (deg)	Corr. (dB/m)	Corr. (dB)
7320.500000	41.25	54.00	12.75	150.0	V	14.0	6.5	---
9759.500000	40.98	54.00	13.02	150.0	V	136.0	7.7	---



EUT: Mini Stepper
 M/N: ST100
 Operating Condition: BLE (Tx 2480MHz, High Channel), 1GHz-18GHz

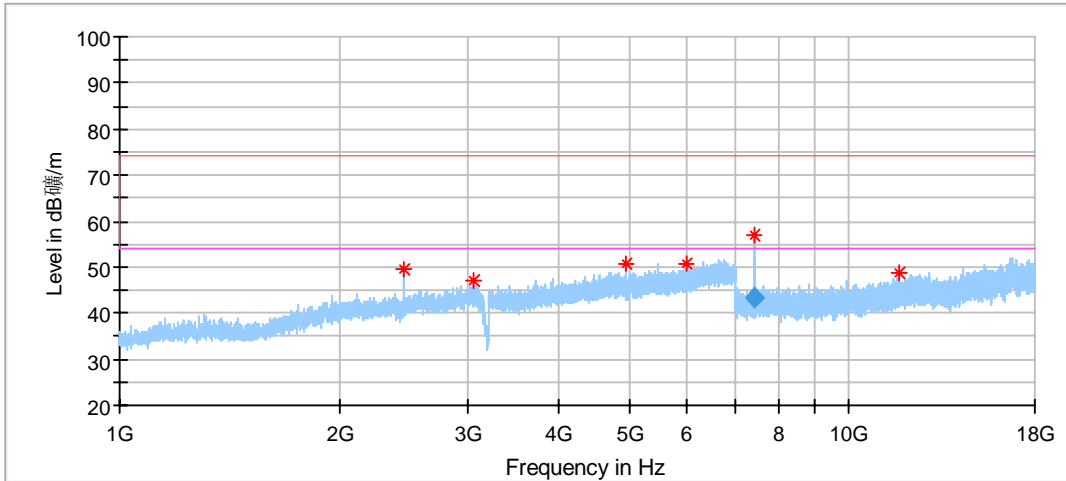

Critical_Freqs

Frequency (MHz)	MaxPeak (dBµV/m)	Limit (dBµV/m)	Margin (dB)	Height (cm)	Pol	Azimuth (deg)	Corr. (dB/m)
2458.500000	49.54	74.00	24.46	150.0	H	23.0	-3.4
3060.000000	47.20	74.00	26.80	150.0	H	95.0	-1.1
4960.500000	50.66	74.00	23.34	150.0	H	75.0	1.5
6001.000000	50.88	74.00	23.12	150.0	H	202.0	4.9
7439.500000	56.75	74.00	17.25	150.0	H	74.0	5.9
11737.500000	48.67	74.00	25.33	150.0	H	331.0	9.1

Final_Result

Frequency (MHz)	Average (dBµV/m)	Limit (dBµV/m)	Margin (dB)	Height (cm)	Pol	Azimuth (deg)	Corr. (dB/m)
7439.500000	43.51	54.00	10.49	150.0	H	74.0	5.9



EUT: Mini Stepper
 M/N: ST100
 Operating Condition: BLE (Tx 2480MHz, High Channel), 1GHz-18GHz

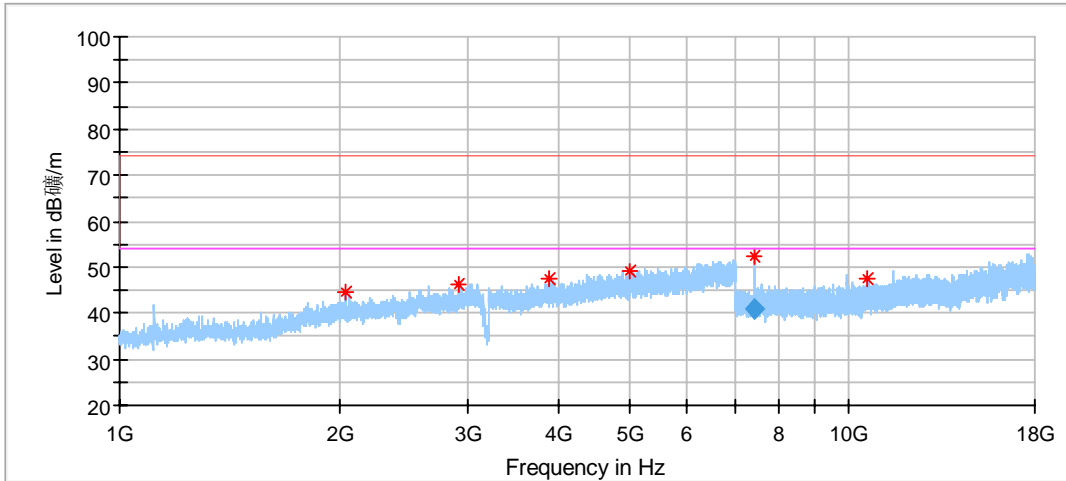

Critical_Freqs

Frequency (MHz)	MaxPeak (dBµV/m)	Limit (dBµV/m)	Margin (dB)	Height (cm)	Pol	Azimuth (deg)	Corr. (dB/m)
2036.500000	44.57	74.00	29.43	150.0	V	216.0	-5.0
2914.500000	46.27	74.00	27.73	150.0	V	236.0	-2.7
3892.000000	47.35	74.00	26.65	150.0	V	241.0	0.8
5026.000000	49.11	74.00	24.89	150.0	V	162.0	2.9
7440.500000	52.38	74.00	21.62	150.0	V	153.0	5.9
10616.000000	47.47	74.00	26.53	150.0	V	153.0	8.2

Final_Result

Frequency (MHz)	Average (dBµV/m)	Limit (dBµV/m)	Margin (dB)	Height (cm)	Pol	Azimuth (deg)	Corr. (dB/m)
7440.500000	41.01	54.00	12.99	150.0	V	153.0	5.9

10 Test Equipment List

List of Test Instruments

Radiated Spurious Emission Test

Description	Manufacturer	Model no.	Equipment ID	Serial no.	cal. due date
Signal Analyzer	Rohde & Schwarz	FSV40	68-4-74-14-003	101031	2020-6-28
Trilog Super Broadband Test Antenna	Schwarzbeck	VULB 9163	68-4-80-14-003	708	2020-7-5
Horn Antenna	Rohde & Schwarz	HF907	68-4-80-14-004	102295	2020-7-5
Wideband Horn Antenna	Q-PAR	QWH-SL-18-40-K-SG	68-4-80-14-008	12827	2020-7-5
Loop Antenna	Rohde & Schwarz	HFH2-Z2	68-4-80-14-006	100398	2020-7-7
Pre-amplifier	Rohde & Schwarz	SCU 18	68-4-29-14-001	102230	2020-6-28
Pre-amplifier	Rohde & Schwarz	SCU 40A	68-4-29-14-002	100432	2020-7-16
Fully Anechoic Chamber	TDK	8X4X4	68-4-90-14-002	--	2020-7-7
Test software	Rohde & Schwarz	EMC32	68-4-90-14-002-A10	Version 9.15.00	N/A

RF Conducted

Description	Manufacturer	Model no.	Equipment ID	Serial no.	cal. due date
Signal Analyzer	Rohde & Schwarz	FSV40	68-4-74-14-004	101030	2020-6-28

11 System Measurement Uncertainty

For a 95% confidence level, the measurement expanded uncertainties for defined systems, in accordance with the recommendations of ISO 17025 were:

System Measurement Uncertainty	
Test Items	Extended Uncertainty
Uncertainty for Radiated Spurious Emission 25MHz-3000MHz	Horizontal: 4.81dB; Vertical: 4.89dB;
Uncertainty for Radiated Spurious Emission 3000MHz-18000MHz	Horizontal: 4.69dB; Vertical: 4.68dB;
Uncertainty for Radiated Spurious Emission 18000MHz-40000MHz	Horizontal: 4.89dB; Vertical: 4.87dB;
Uncertainty for Conducted RF test with TS 8997	RF Power Conducted: 1.16dB Frequency test involved: 0.6×10 ⁻⁷ or 1%