

Cat Radio Control 1:16 Scale 28007
Diecast Cat 272D3 Skid Steer Loader With Bucket, Auger, Forks, and Broom



OPERATING INSTRUCTIONS



ITEM NUMBER:
28007
SCALE:1:16

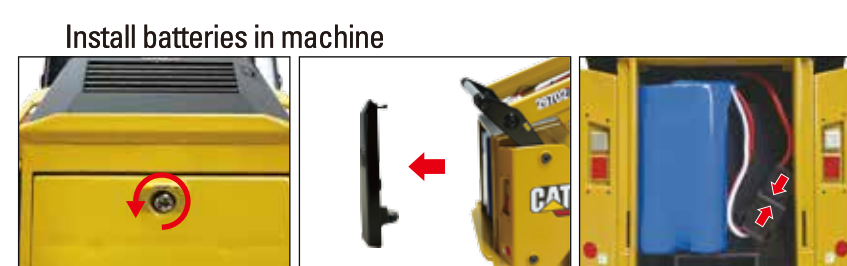

Cat Radio Control 1:16 Scale 28007
Diecast Cat 272D3 Skid Steer Loader With Bucket, Auger, Forks, and Broom



OPERATING INSTRUCTIONS (CONT.)



Package includes: Skid Steer Loader, include 4 interchangeable work tools - bucket, auger, forks, and broom, Controller, USB cable, Two AAA batteries, Lithium battery, plastic fixed package window box

Product Information

Frequency	2.4 GHz
Maximum number of users/machines without interference	12
Controller Working Range	15m/82ft
Max. speed (km/h)	0.8
Scale	1/16
Max. play time	60 min.
Charging time	180 min.
Charger	1A, USB cable
Rechargeable Battery	1 x 7.4V 600mAh 2S
Controller Battery	AAA size x2(not included)
Product Weight	1.13kg

CAT official licensed product realistic full working functions (individual operability functions of bucket, screw, fork, broom), high quality steel gears for durable life.



The wheeble bin symbol indicates the product and batteries must not be disposed of in domestic waste as they contain substances damaging to the environment and health. Please use collection points or recycling facilities.



©2021 Caterpillar, CAT, CATERPILLAR, their respective logos, "Caterpillar Yellow," the "Power Edge" trade dress as well as corporate and product identity used herein, are trademarks of Caterpillar and may not be used without permission. Diecast Masters Company Limited, a licensee of Caterpillar Inc.

BATTERY CHARGING INSTRUCTIONS

CHARGING METHODS

Connect the white port of Li-Po to USB charging port, as shown in the Figure, and ensure port can be connected tightly and correctly, then insert the USB charging plug into power adapter, and perform charging.

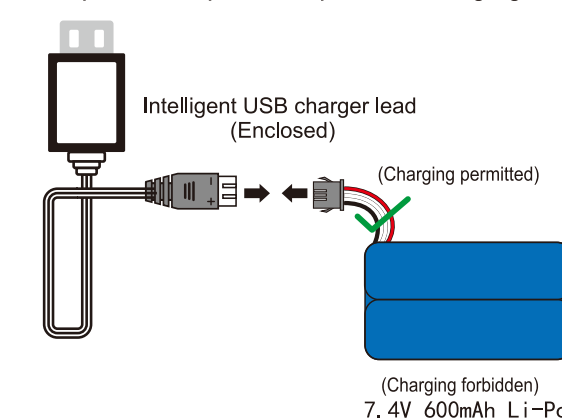

BATTERY/USB PARAMETERS

Battery specifications:	14500 7.4V 600mAh Li-Po
Intelligent USB balance charger with overcharge protection	
Input:	5.0V 1-2A
Output:	7.4V 1000mAh x2

Precautions Of Li-Po Batteries

1. Battery can be charged only by originally configured USB charger lead.
2. Be sure to charge with the white Big socket port, not the yellow socket.
3. 7.4V Li-Po must be equipped with 5V USB charging plug.
4. Any Li-Po battery with a damaged appearance should NOT be charged to avoid fire hazards from spontaneous combustion.
5. The battery should be charged according to the specified charging time period.

Safe Usage Instructions for Li-Po Batteries

- Li-Po batteries pose a higher danger compared with other batteries.
- This company does not bear any responsibility resulting from improper usage.
- DO NOT attempt to charge the Li-Po battery with any charger other than the included original charger. Failure to do so may result in an explosion or fire. DO NOT dismantle, subject to impact, incinerate or reverse the connections of the battery. Avoid metal objects impacting the positive and negative polarities of the battery. Please prevent sharp objects from penetrating the battery to avoid the potential of fire.
- Please use caution when charging the battery and ensure charging occurs in a visible area. DO NOT leave battery unattended while charging.
- Battery should be kept out of reach of children to avoid any injury.
- A degraded battery should not be attempted to be recharged. Battery expansion, deformation, explosion or fire may occur.
- Degraded batteries should be disposed of properly following regional or national disposal guidelines to ensure protection of the environment.

INDICATOR LIGHT STATUS AT THE TIME OF CHARGING:

Uncharged state: red light always lit
Charged state: Red light always lit + Green light flashes
Full charging state: Red and green light always lit
Charging period: 2-3 hours
When the battery is fully charged, please remove the USB charger lead promptly

WARNING

- This product contains small parts and is not intended for children under the age of 14.
- The remote control requires 2 X 1.5V AAA non-rechargeable batteries and the RC excavator requires a 7.4V 600mAh Li-Po battery (included)
- The RC excavator motor can generate heat and should not be touched to avoid possible burns.
- Periodically check the wire, plug, shell and other parts of the charger for wear or damage and discontinue use if detected until repaired or replaced.
- The RC excavator should only be charged using the recommended guidelines.
- The LEDs (Light Emitting Diodes) can emit radiation and should not be pointed directly at the eyes.
- Aviation restrictions forbid the use of Radio Control devices within a radius of ISCED Warning(statement): This device contains licence-exempt transmitter(s) that comply with Innovation, Science and Economic Development Canada's licence-exempt Rss(s). Operation is subject to the following two Conditions: (1) This device may not cause interference. (2) This device must accept any interference, including interference that may cause undesired operation of the device. For RF exposure: This equipment complies with IC RSS-102 radiation exposure limits set forth for uncontrolled environment. This equipment should be installed and operated with unrestricted. L'émetteur/récepteur exempt de licence contenu dans le présent appareil est conforme aux CNR d'Innovation, Sciences et Développement économique Canada applicables aux appareils radio exempts de licence. L'exploitation est autorisée aux deux conditions suivantes: 1. L'appareil ne doit pas produire de brouillage; 2. L'appareil doit accepter tout brouillage radioélectrique subi, même si le brouillage est susceptible d'en compromettre le fonctionnement. Déclaration d'exposition RF: L'équipement est conforme à la limite d'exposition aux radiations de la IC établie pour un environnement non contrôlé. Cet équipement doit être installé et utilisé avec une distance minimale de 5mm entre le radiateur et votre corps.

IMPROPER USE OF THIS PRODUCT

Do not dismantle, modify or otherwise alter the operation of this product in any manner. Do not operate this product in an unlawful or illegal manner or as to jeopardize the safety of the operator or others.

IMPORTANT NOTICES

Please note: This product has been manufactured under strict performance guidelines and tested to meet safety standards and requirements. This product is not intended for operators under the age of 14. The manufacturer bears no responsibility for injury or accidents resulting from the use of abnormal parts, excessive wear, improper assembly or operation. Please operate this product in a safe and responsible manner.

FUNCTION INTRODUCTION OF REMOTE CONTROL

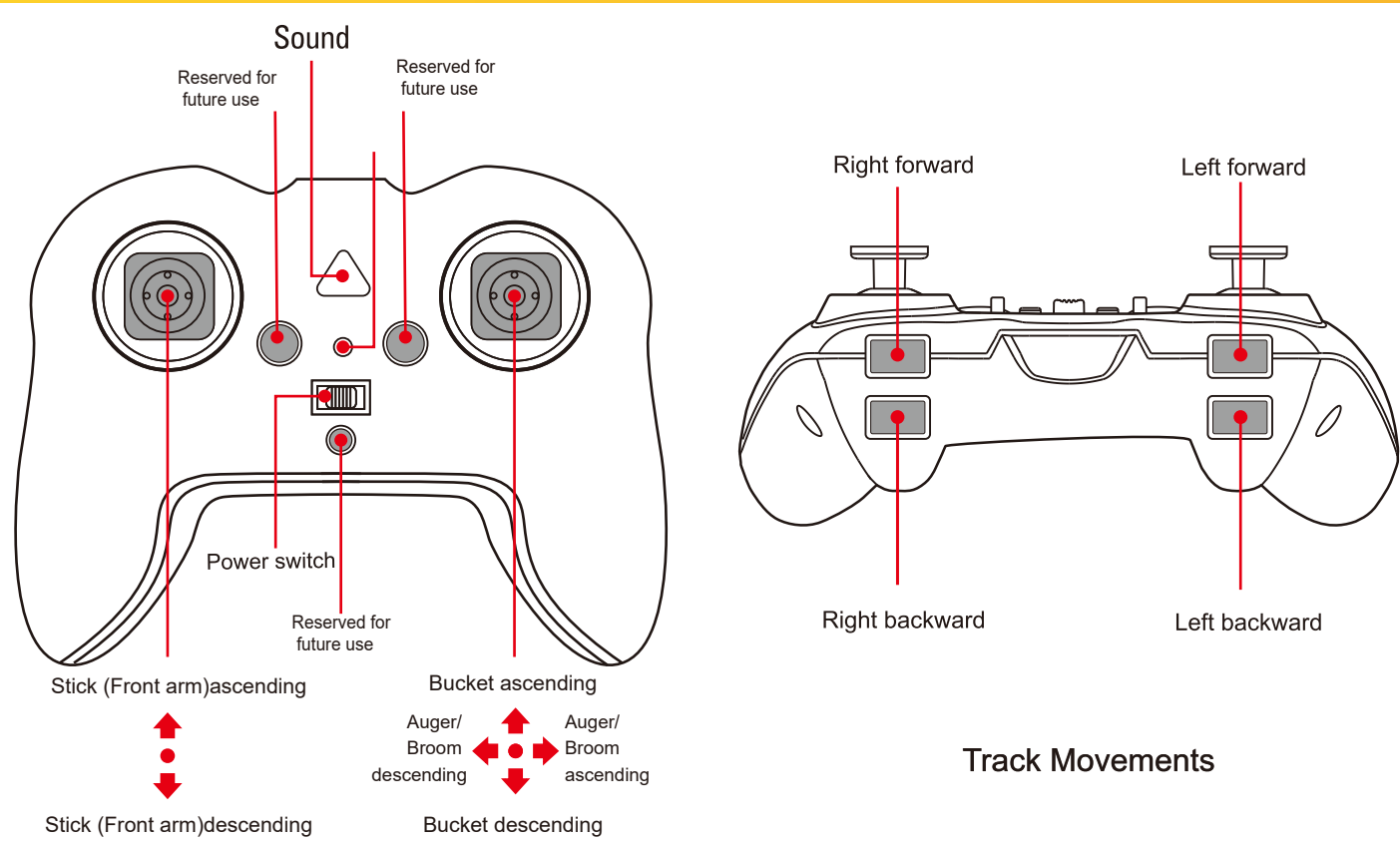

INSTALLATION OF REMOTE-CONTROL MODEL BATTERY

Model is equipped with a 7.4V 600mAh Li-Po battery (included). First, twist the buckle to open the battery cover, then correctly connect the battery following the diagram. Place the battery into the compartment. Close the battery cover and twist the buckle to lock the cover.

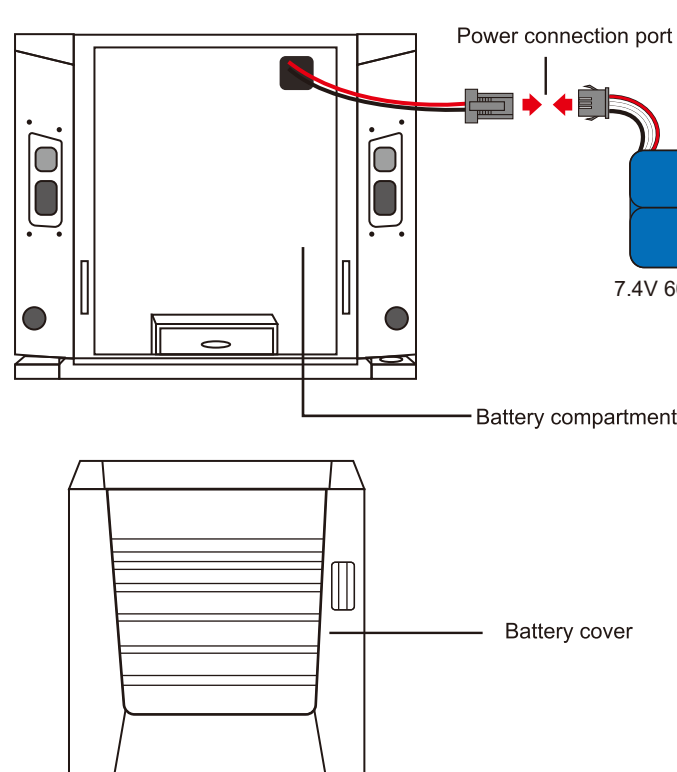

INSTALLATION OF REMOTE CONTROL BATTERY

The remote control requires 2 X 1.5V AAA non-rechargeable batteries. Open the battery cover by loosening the cover screw. Place the batteries into the compartment observing the correct polarity. Replace the battery cover and tighten the cover screw.

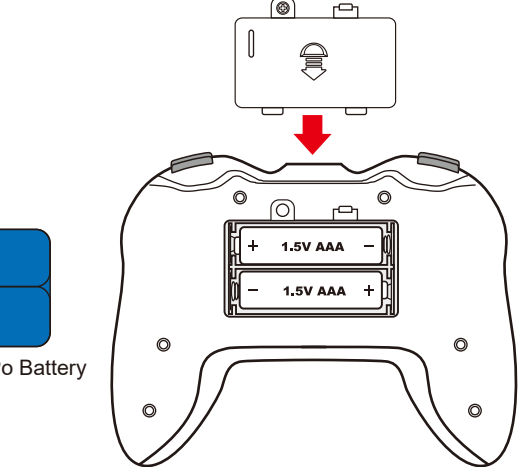

Battery Installation Instructions:

1. Remove rechargeable battery from package and install correctly in machine following included guidelines.
2. The rechargeable battery should be removed from the machine before recharging.
3. Recharge battery only under adult supervision.
4. Do not use rechargeable AAA batteries in the remote control.
5. Do not combine old and new AAA batteries in the remote control.
6. Use the same type or brand of new AAA batteries in the remote control.
7. Place AAA batteries in the remote control observing the correct polarity.
8. Use caution to avoid short-circuit of the battery terminals in the remote control.

Cat Radio Control 1:16 Scale 28007
Diecast Cat 272D3 Skid Steer Loader With Bucket, Auger, Forks, and Broom



OPERATING INSTRUCTIONS (CONT.)

DIGGING ARM AND PLATFORM CONTROL

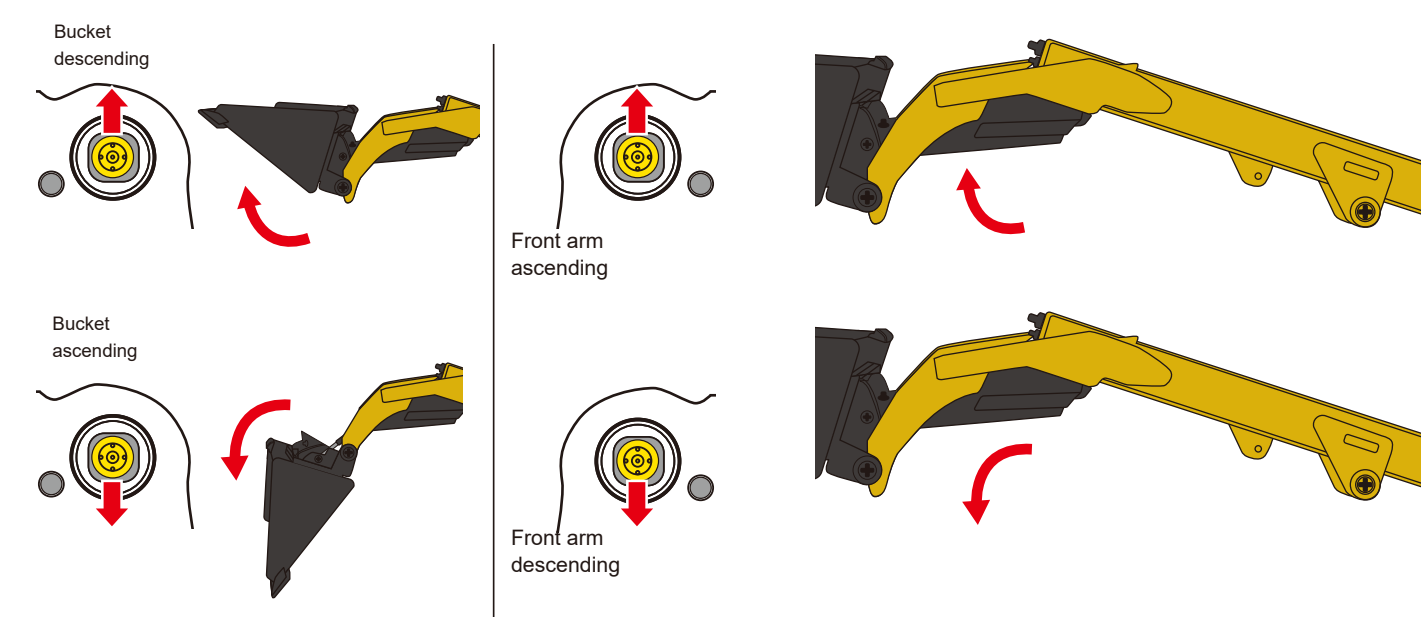

MODEL DRIVING CONTROL

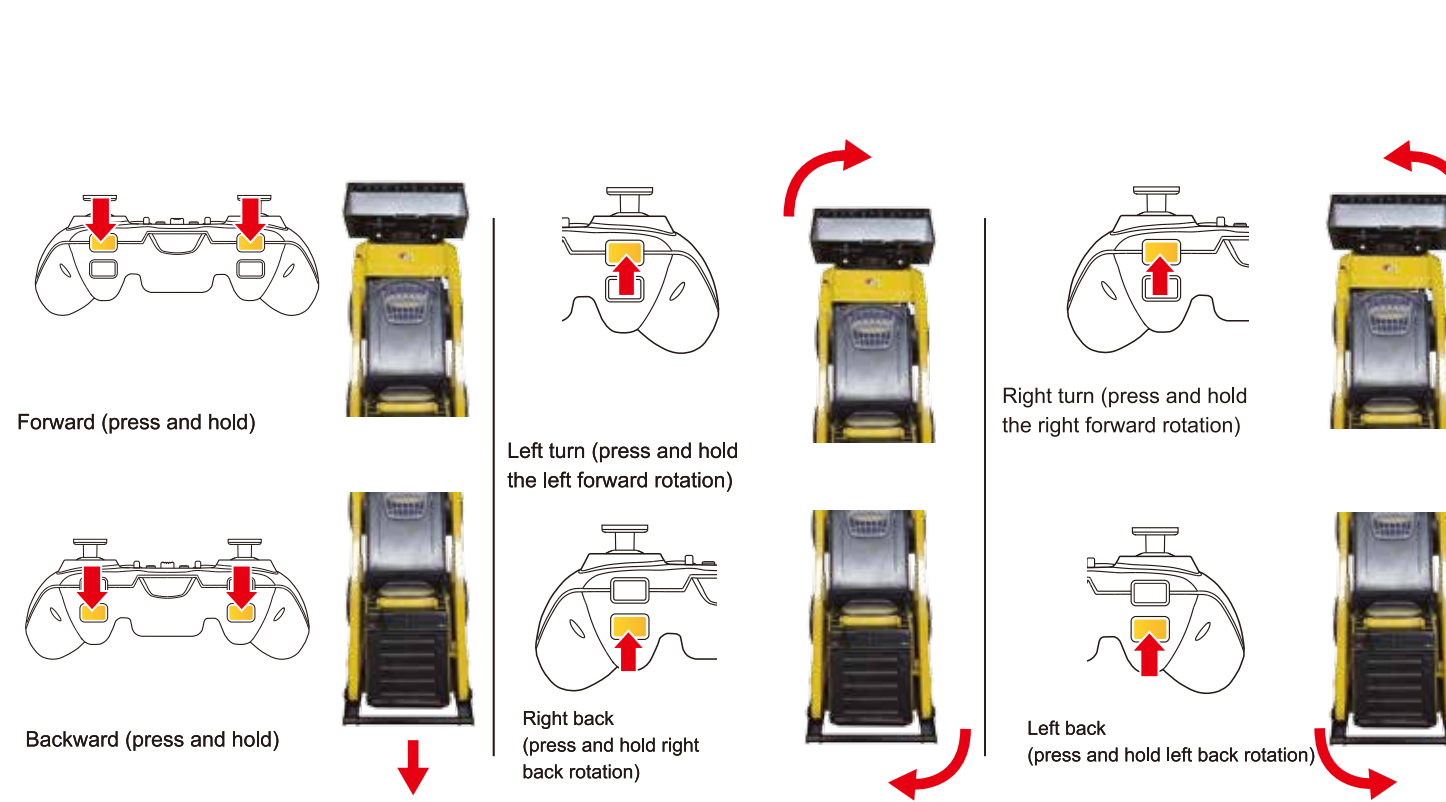

Cat Radio Control 1:16 Scale 28007
Diecast Cat 272D3 Skid Steer Loader With Bucket, Auger, Forks, and Broom



OPERATING INSTRUCTIONS (CONT.)

MODEL DRIVING CONTROL

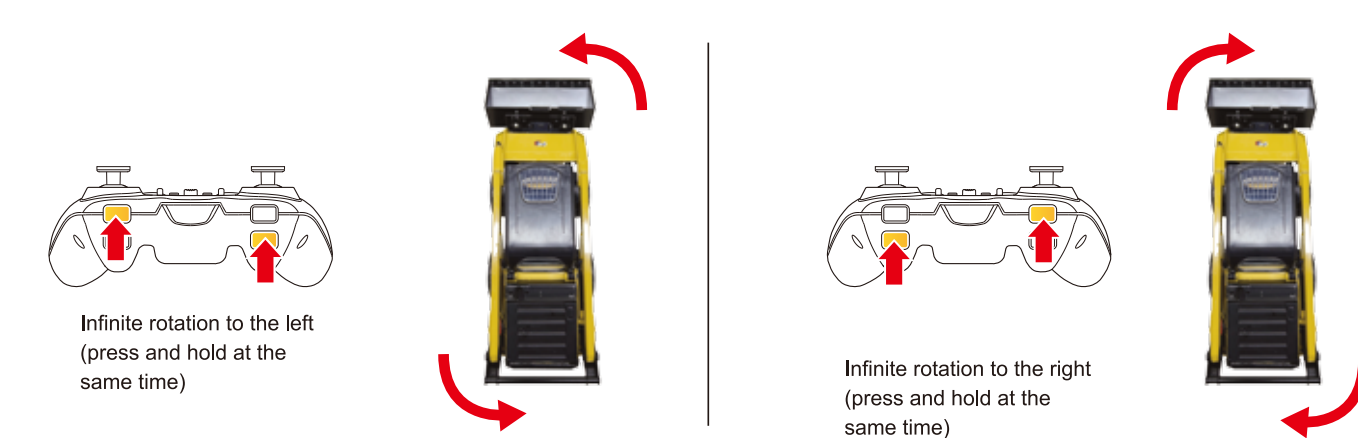

REPLACEMENT PARTS

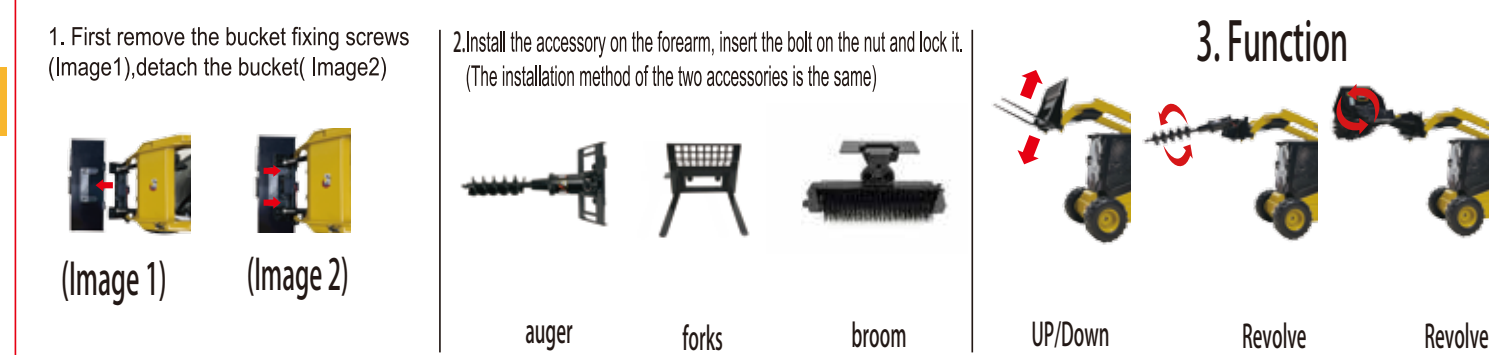

REMOTE CONTROL FREQUENCY PAIRING AND POWER ON

This product is equipped with a remote control with a frequency of 2.4GHz. When a user operates the product for the first time, please install batteries into the model and the remote control. Then power on the unit, then the remote control. A series of beeps will indicate that the frequency pairing has been completed and the model is ready to operate.

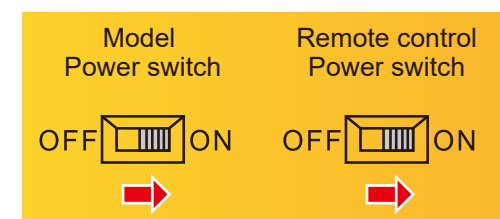

LIGHT AND SOUND CONTROL

The operating model can generate lights and sounds. Press the sound switch to turn on the lights and sounds, press the switch again to turn them off.



We reserve the right to make technical and design-related changes



FCC statement

This device complies with Part 15 of the FCC rules. Operation is subject to the following two conditions:

- 1) This device may not cause interference.
- 2) This device must accept any interference, including interference that may cause undesired operation of the device.

Note: This equipment has been tested and found to comply with the limits for a Class B digital device, pursuant to part 15 of the FCC Rules. These limits are designed to provide reasonable protection against harmful interference in a residential installation. This equipment generates uses and can radiate radio frequency energy and, if not installed and used in accordance with the instructions, may cause harmful interference to radio communications. However, there is no guarantee that interference will not occur in particular installation. If this equipment does cause harmful interference to radio or television reception, which can be determined by turning the equipment off and on, the user is encouraged to try to correct the interference by one or more of the following measures:

- Reorient or relocate the receiving antenna.
- Increase the separation between the equipment and receiver.
- Connect the equipment into an outlet on a circuit different from that to which the receiver is connected.
- Consult the dealer or an experienced radio/TV technician for help.

Changes or modifications not expressly approved by the party responsible for compliance could void the user's authority to operate the equipment.

FCC Radiation Exposure Statement

This device complies with FCC RF radiation exposure limits set forth for an uncontrolled environment. This transmitter must not be co-located or operating in conjunction with any other antenna or transmitter.