



# Western Star Radio Control 1:16 Scale 49X Dump Truck



## BATTERY CHARGING INSTRUCTIONS

# Western Star Radio Control 1:16 Scale 49X Dump Truck OPERATING INSTRUCTIONS

## OPERATING INSTRUCTIONS (CONT.)

### Package includes:

Truck, Controller, USB charger with cable, Two AA batteries, Lithium battery, Window box package



### Product Information

Frequency	2.4 GHz
Maximum number of users/machines without interference	12
Controller Working Range	35m / 98.4ft
Max. speed (km/h)	5 km/h
Scale	1:16
Max. play time	45 - 70 min.
Charging time	210 min.
Charger	1A, USB cable
Rechargeable Battery	1 x 7.4V 2000mAh 2S
Controller Battery	AA size x 2
Product Weight (truck, exclude battery)	3.05kg / 6.71lbs
Truck Loading	max. 5kg / 11lbs

### Western Star Trucks

4747 N. Channel Ave.  
Portland, OR 97217  
(803) 578-3000

[www.westernstartrucks.com/](http://www.westernstartrucks.com/)



### CHARGING METHODS

Connect the white port of Li-Po to USB charging port, as shown in the Figure, and ensure port can be connected tightly and correctly, then insert the USB charging plug into power adapter, and perform charging.

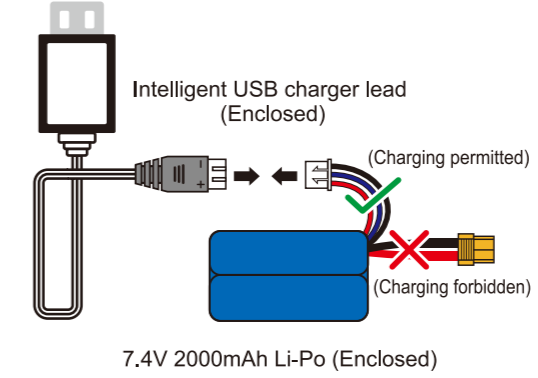

### INDICATOR LIGHT STATUS AT THE TIME OF CHARGING:

Uncharged state: red light always lit  
Charged state:  
Red light always lit + Green light flashes  
Full charging state:  
Red and green light always lit

When the battery is fully charged, please remove the USB charger lead promptly

### BATTERY/USB PARAMETERS

Battery specifications: 18650 7.4V 2000mAh Li-Po
Intelligent USB balance charger with overcharge protection Input: 5.0V 1-2A Data change in Battery/USB PARAMETERS: Output: DC 7.4V, 800mA

### Precautions Of Li-Po Batteries

1. Battery can be charged only by originally configured USB charger lead.
2. Be sure to charge with the white Big socket port, not the yellow socket.
3. 7.4V Li-Po must be equipped with 5V USB charging plug.
4. Any Li-Po battery with a damaged appearance should NOT be charged to avoid fire hazards from spontaneous combustion.
5. The battery should be charged according to the specified charging time period.

### Safe Usage Instructions for Li-Po Batteries

- Li-Po batteries pose a higher danger compared with other batteries.
- This company does not bear any responsibility resulting from improper usage.
- DO NOT attempt to charge the Li-Po battery with any charger other than the included original charger. Failure to do so may result in an explosion or fire. DO NOT dismantle, subject to impact, incinerate or reverse the connections of the battery. Avoid metal objects impacting the positive and negative polarities of the battery. Please prevent sharp objects from penetrating the battery to avoid the potential of fire.
- Please use caution when charging the battery and ensure charging occurs in a visible area. DO NOT leave battery unattended while charging.
- Battery should be kept out of reach of children to avoid any injury.
- A degraded battery should not be attempted to be recharged. Battery expansion, deformation, explosion or fire may occur.
- Degraded batteries should be disposed of properly following regional or national disposal guidelines to ensure protection of the environment.

### WARNING

This product contains small parts and is not intended for children under the age of 14. The remote control requires 2 X 1.5V AA non-rechargeable batteries and the RC model requires a 7.4 V 2000mAh Li-Po battery (included). The RC model motor can generate heat and should not be touched to avoid possible burns. Periodically check the wire, plug, shell and other parts of the charger for wear or damage and discontinue use if detected until repaired or replaced. The RC model should only be charged using the recommended guidelines. The LEDs (Light Emitting Diodes) can emit radiation and should not be pointed directly at the eyes. Aviation restrictions forbid the use of Radio Control devices within a radius of 3 miles or 5000 meters from any airport runway or facility.

### IMPROPER USE OF THIS PRODUCT

Do not dismantle, modify or otherwise alter the operation of this product in any manner. Do not operate this product in an unlawful or illegal manner or as to jeopardize the safety of the operator or others.

### IMPORTANT NOTICES

Please note: This product has been manufactured under strict performance guidelines and tested to meet safety standards and requirements. This product is not intended for operators under the age of 14. The manufacturer bears no responsibility for injury or accidents resulting from the use of abnormal parts, excessive wear, improper assembly or operation. Please operate this product in a safe and responsible manner.



Forward and Backward Movements

Power (On/Off)

Dump Bed Up and Down Movements



Sound

Left-turn and Right-turn Movements

Steering Trim



Install batteries in machine



14+ Diecast Masters scale models are adult collectibles, not toys. Not intended for children under 14.

WESTERN STAR®, emblems, logos, and body designs are trademarks of Daimler Trucks North America LLC and are used under license by Yu Lee Company Limited.

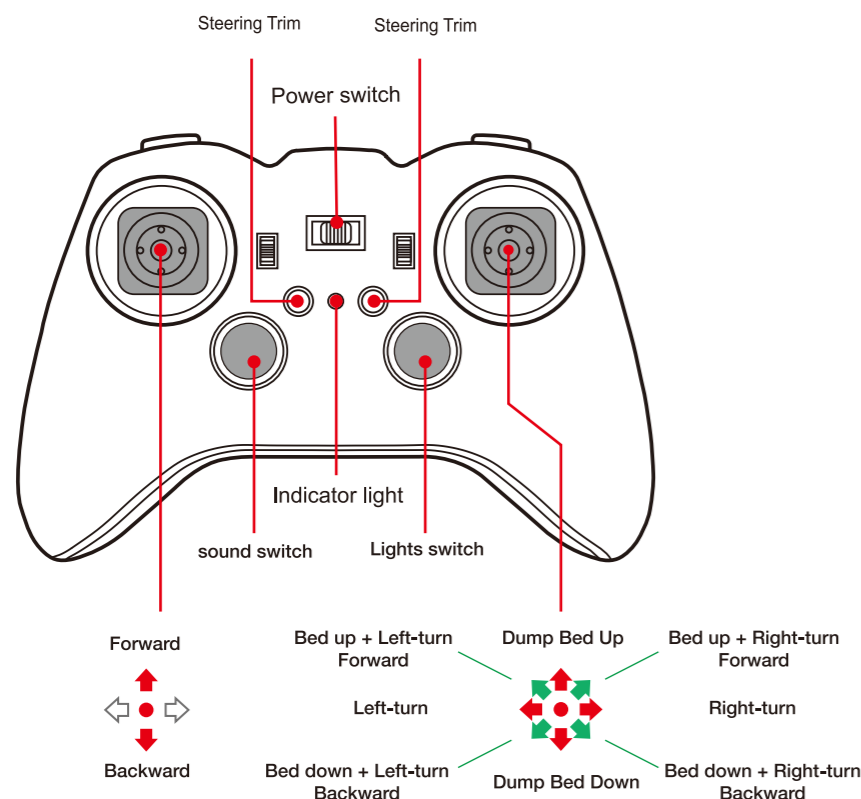

INSTALLATION OF REMOTE-CONTROL MODEL BATTERY

Model is equipped with a 7.4V 2000m Ah Li-Po battery (included). First, twist the buckle to open the battery cover, then correctly connect the battery following the diagram. Place the battery into the compartment. Close the battery cover and twist the buckle to lock the cover. Tighten the cover screw to avoid children easy access.

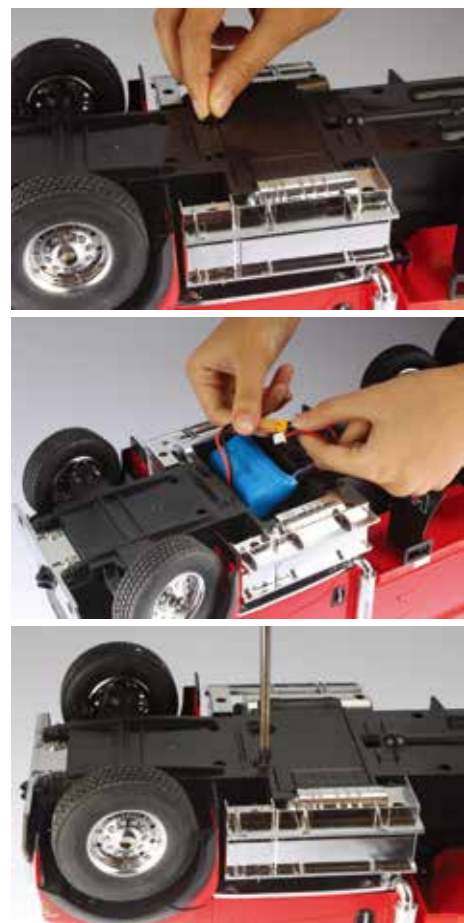

INSTALLATION OF REMOTE CONTROL BATTERY

The remote control requires 2 X 1.5V AA non-rechargeable batteries. Open the battery cover by loosening the cover screw. Place the batteries into the compartment observing the correct polarity. Replace the battery cover and tighten the cover screw.

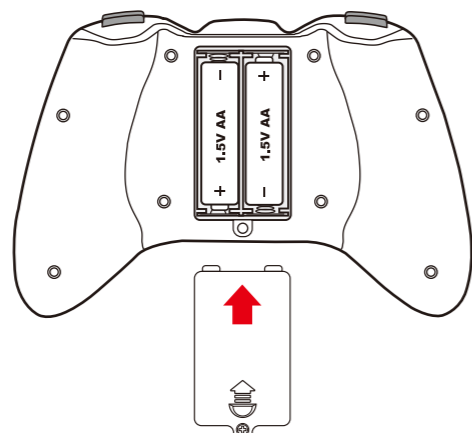

Battery Installation Instructions:

1. Remove rechargeable battery from package and install correctly in machine following included guidelines.
2. The rechargeable battery should be removed from the machine before recharging.
3. Recharge battery only under adult supervision.
4. Do not use rechargeable AA batteries in the remote control
5. Do not combine old and new AA batteries in the remote control
6. Use the same type or brand of new AA batteries in the remote control
7. Place AA batteries in the remote control observing the correct polarity
8. Use caution to avoid short-circuit of the battery terminals in the remote control

OPERATING INSTRUCTIONS (CONT.)



OPERATING INSTRUCTIONS (CONT.)



MODEL DRIVING CONTROL



DIGITAL PROPORTIONAL FORWARD, BACKWARD, TURN LEFT, TURN RIGHT

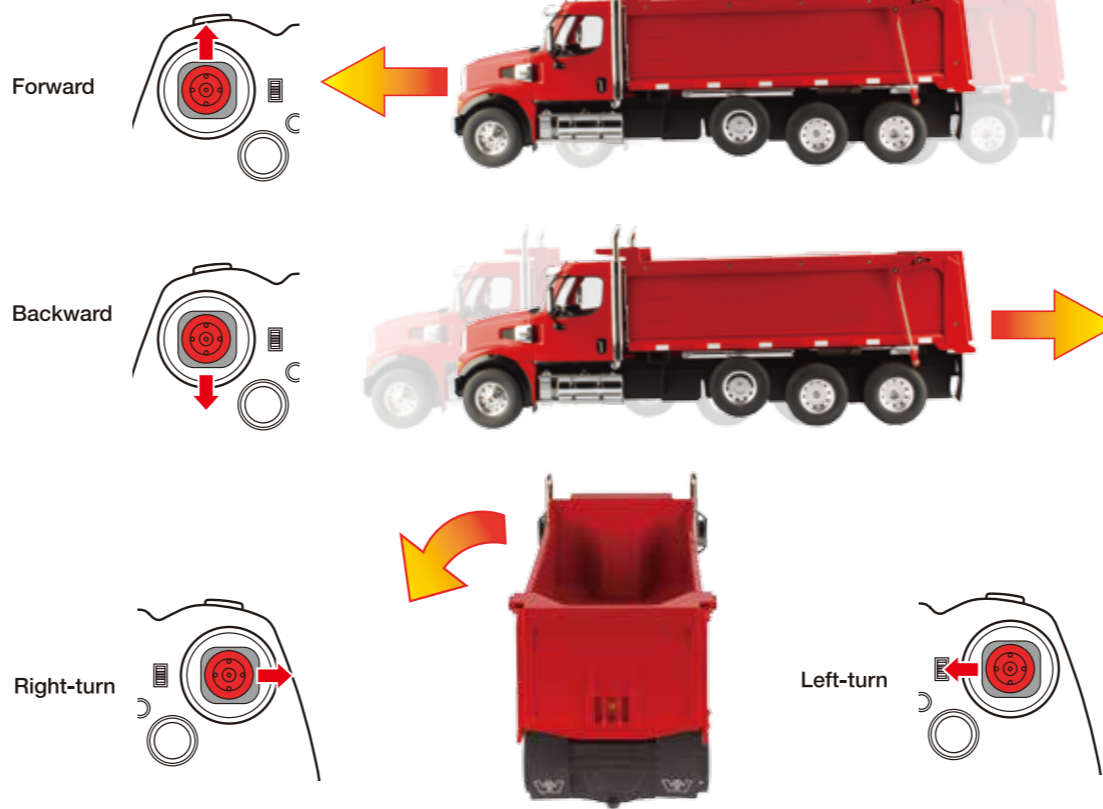

DUMP BED UP AND DOWN

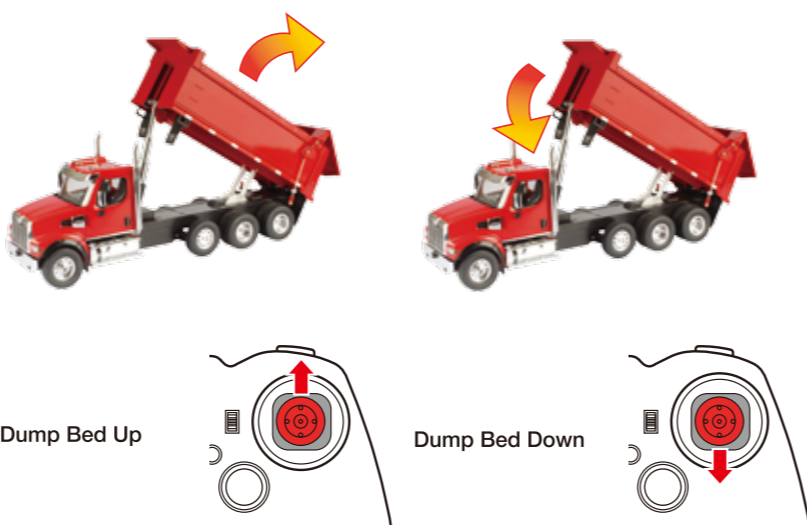

MODEL DRIVING CONTROL

MANUAL CONTROL

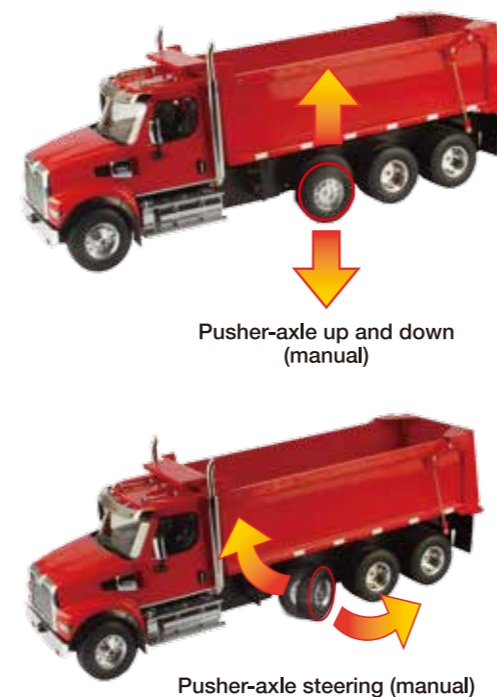

LIGHT AND SOUND CONTROL



FUNCTIONAL HEADLIGHTS, TURN-SIGNAL LIGHTS, BRAKE LIGHT, BACK LIGHT

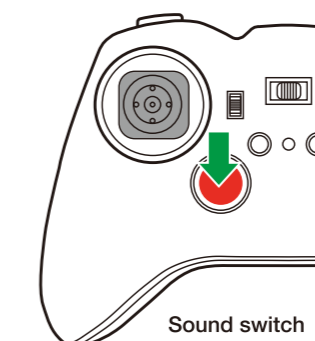

The operating model can generate lights and sounds. Press the sound switch to turn on the lights and sounds, press the switch again to turn them off.



REALISTIC SOUND

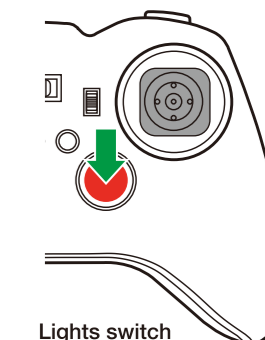

REMOTE CONTROL FREQUENCY PAIRING AND POWER ON

This product is equipped with a remote control with a frequency of 2.4GHz. When a user operates the product for the first time, please install batteries into the model and the remote control. Then power on the unit, then the remote control. A series of beeps will indicate that the frequency pairing has been completed and the model is ready to operate.

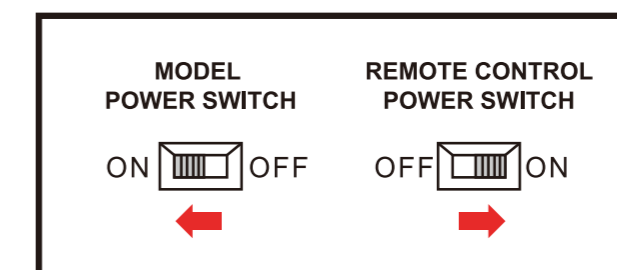

Requirement for FCC Part 15

**Warning:** Changes or modifications not expressly approved by the party responsible for compliance could void the user's authority to operate the equipment.

**Note:** This equipment has been tested and found to comply with the limits for a Class B digital device, pursuant to Part 15 of the FCC Rules. These limits are designed to provide reasonable protection against harmful interference in a residential installation.

This equipment generates, uses and can radiate radio frequency energy and, if not installed and used in accordance with the instructions, may cause harmful interference to radio communications. However, there is no guarantee that interference will not occur in a particular installation.

If this equipment does cause harmful interference to radio or television reception, which can be determined by turning the equipment off and on, the user is encouraged to try to correct the interference by one or more of the following measures:

- Reorient or relocate the receiving antenna.
- Increase the separation between the equipment and receiver,
- Connect the equipment into an outlet on a circuit different from that to which the receiver is connected.
- Consult the dealer or an experienced radio/TV technician for help.

This device complies with FCC RF radiation exposure limits set forth for an uncontrolled environment. This transmitter must not be co-located or operating in conjunction with any other antenna or transmitter.