

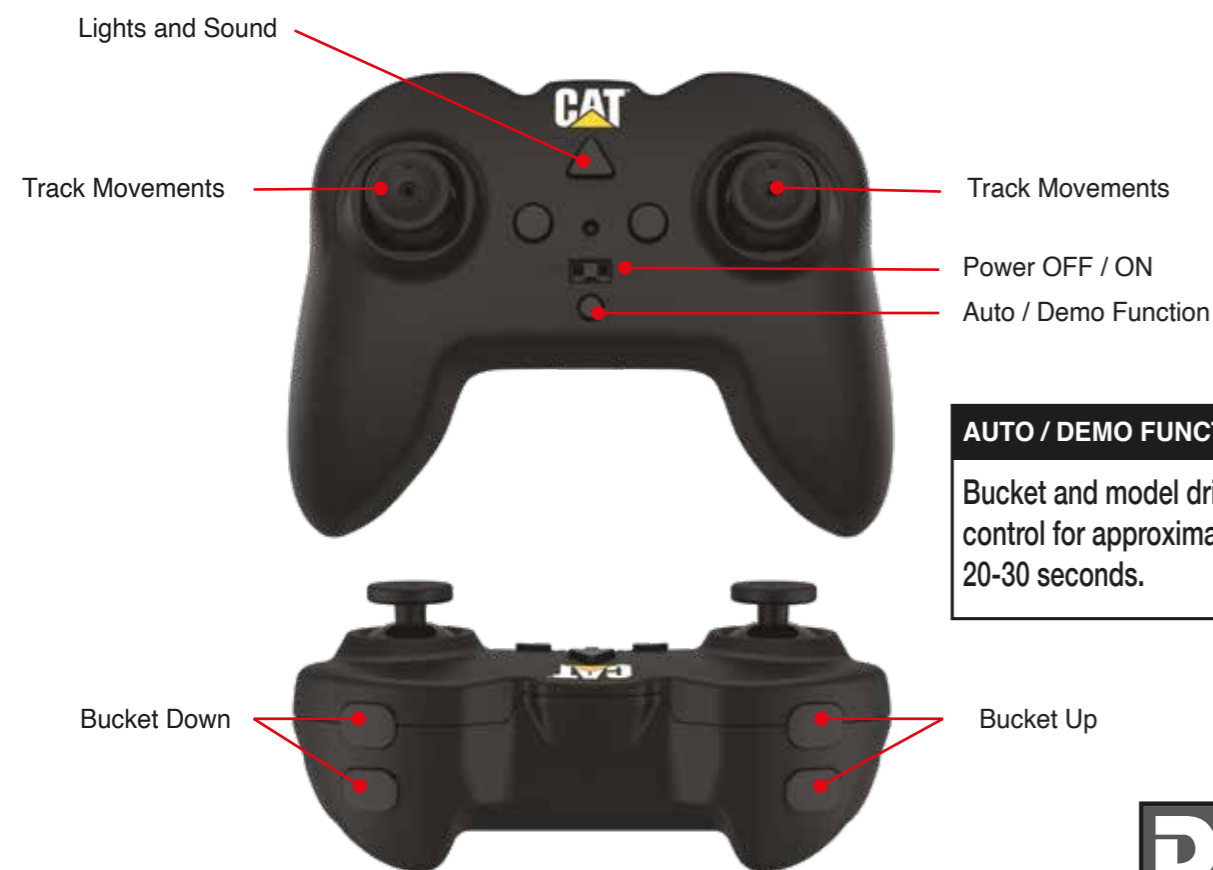

745 Articulated Truck OPERATING INSTRUCTIONS

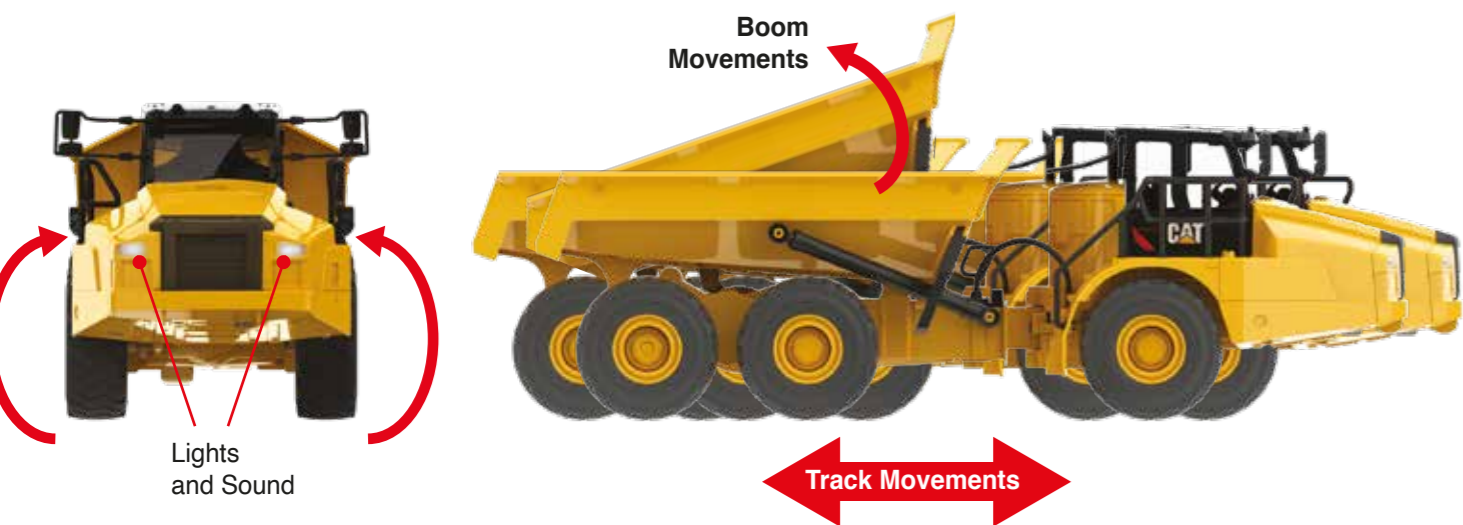

AUTO / DEMO FUNCTION

Bucket and model driving control for approximate 20-30 seconds.



745 Articulated Truck OPERATING INSTRUCTIONS



Package includes:

Truck, Controller,
USB charger with cable,
Two AAA batteries, Lithium battery,
Window box package



Frequency	2.4 GHz
Maximum number of users/machines without interference	12
Controller Working Range	35M
Max. speed (km/h)	3 km/h
Scale	1:24
Max. play time	40 min.
Charging time	120 min.
Charger	1A, USB cable
Rechargeable Battery	1x7.4V 600mAh
Controller Battery	AAA size x 2
Product Weight (Boom, exclude battery)	1035 g
Truck Bed Loading	max. 1 kg / 2.2 lbs

CAT official licensed product, realistic full working functions (individual operations of bucket, stick-arm & boom-arm, powerful excavation actions by leadscrew transmission), high quality steel gears for durable life, realistic light & sound effect, upper-body can rotate 360 degrees.



8+ Diecast Masters scale models are adult collectibles, not toys. Not intended for children under 8.

www.cat.com / www.caterpillar.com

©2020 Caterpillar. CAT, CATERPILLAR, their respective logos, "Caterpillar Yellow," the "Power Edge" trade dress as well as corporate and product identity used herein, are trademarks of Caterpillar and may not be used without permission.

Diecast Masters Company Limited, a licensee of Caterpillar Inc.

©2020 Diecast Masters Company Limited Room 1801-5, 18/F King Palace Plaza 52A Sha Tsui Road Tsuen Wan, N.T., Hong Kong www.diecastmasters.com

BATTERY CHARGING INSTRUCTIONS

CHARGING METHODS

Connect the white port of Li-Po to USB charging port, as shown in the Figure, and ensure port can be connected tightly and correctly, then insert the USB charging plug into power adapter, and perform charging.

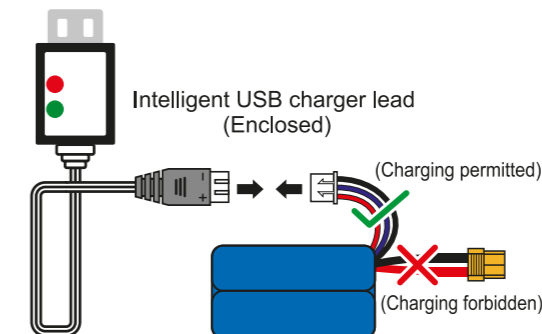

7.4V 600mAh Li-Po (Enclosed)

BATTERY / USB PARAMETERS

Battery specifications:
18650
7.4V 600mAh Li-Po

Intelligent USB balance charger with overcharge protection
Input: 5.0V 1-2A
Data change in Battery/USB
PARAMETERS:
Output: DC 4.2V, 800mA

INDICATOR LIGHT STATUS AT THE TIME OF CHARGING:

Uncharged state:



red light always lit

Charged state:



Red light always lit & Green light flashes

Full charging state:



Red and green light always lit

When the battery is fully charged, please remove the USB charger lead promptly

Precautions Of Li-Po Batteries

1. Battery can be charged only by originally configured USB charger lead.
2. Be sure to charge with the white Big socket port, not the yellow socket.
3. 7.4V 600mAh Li-Po must be equipped with 5V USB charging plug.
4. Any Li-Po battery with a damaged appearance should NOT be charged to avoid fire hazards from spontaneous combustion.
5. The battery should be charged according to the specified charging time period.

Safe Usage Instructions for Li-Po Batteries

- Li-Po batteries pose a higher danger compared with other batteries.
- This company does not bear any responsibility resulting from improper usage.
- DO NOT attempt to charge the Li-Po battery with any charger other than the included original charger. Failure to do so may result in an explosion or fire. DO NOT dismantle, subject to impact, incinerate or reverse the connections of the battery. Avoid metal objects impacting the positive and negative polarities of the battery. Please prevent sharp objects from penetrating the battery to avoid the potential of fire.
- Please use caution when charging the battery and ensure charging occurs in a visible area. DO NOT leave battery unattended while charging.
- Battery should be kept out of reach of children to avoid any injury.
- A degraded battery should not be attempted to be recharged. Battery expansion, deformation, explosion or fire may occur.
- Degraded batteries should be disposed of properly following regional or national disposal guidelines to ensure protection of the environment.

WARNING

This product contains small parts and is not intended for children under the age of 8. The remote control requires 2 X 1.5V AAA non-rechargeable batteries and the RC model requires a 7.4 V 600mAh Li-Po battery (included) The RC model motor can generate heat and should not be touched to avoid possible burns. Periodically check the wire, plug, shell and other parts of the charger for wear or damage and discontinue use if detected until repaired or replaced. The RC model should only be charged using the recommended guidelines. The LEDs (Light Emitting Diodes) can emit radiation and should not be pointed directly at the eyes. Aviation restrictions forbid the use of Radio Control devices within a radius of 3 miles or 5000 meters from any airport runway or facility.

IMPROPER USE OF THIS PRODUCT

Do not dismantle, modify or otherwise alter the operation of this product in any manner. Do not operate this product in an unlawful or illegal manner or as to jeopardize the safety of the operator or others.

IMPORTANT NOTICES

FCC Statement
This device complies with part 15 of the FCC rules. Operation is subject to the following two conditions: (1) this device may not cause harmful interference, and (2) this device must accept any interference received, including interference that may cause undesired operation.
Changes or modifications not expressly approved by the party responsible for compliance could void the user's authority to operate the equipment.
NOTE: This equipment has been tested and found to comply with the limits for a Class B digital device, pursuant to part 15 of the FCC Rules. These limits are designed to provide reasonable protection against harmful interference in a residential installation. This equipment generates uses and can radiate radio frequency energy and, if not installed and used in accordance with the instructions, may cause harmful interference to radio communications. However, there is no guarantee that interference will not occur in a particular installation. If this equipment does cause harmful interference to radio or television reception, which can be determined by turning the equipment off and on, the user is encouraged to try to correct the interference by one or more of the following measures:
-Reorient or relocate the receiving antenna.
-Increase the separation between the equipment and receiver.
-Connect the equipment into an outlet on a circuit different from that to which the receiver is connected.
-Consult the dealer or an experienced radio/TV technician for help.
The device has been evaluated to meet general RF exposure requirement. The device can be used in portable exposure condition without restriction.

ISED Statement
- English: This device complies with Industry Canada license exempt RSS standard(s). Operation is subject to the following two conditions: (1) This device may not cause interference, and (2) This device must accept any interference, including interference that may cause undesired operation of the device. The digital apparatus complies with Canadian CAN ICESy3 (B)/NMB3(B).
- French: Le présent appareil est conforme aux CNR d'Industrie Canada applicables aux appareils radio exempts de licence. L'exploitation est autorisée aux deux conditions suivantes: (1) l'appareil ne doit pas produire de brouillage, et (2) l'utilisateur de l'appareil doit accepter tout brouillage radioélectrique subi, même si le brouillage est susceptible d'en compromettre le fonctionnement.

This radio transmitter (ISED certification number: 25977-25004) has been approved by Industry Canada to operate with the antenna types listed with the maximum permissible gain indicated. Antenna types not included in this list, having a gain greater than the maximum gain indicated for that type, are strictly prohibited for use with this device. Le présent émetteur radio (ISED certification number: 25977-25004) a été approuvé par Industrie Canada pour fonctionner avec les types d'antenne énumérés ci-dessous et ayant un gain admissible maximal. Les types d'antenne non inclus dans cette liste, et dont le gain est supérieur au gain maximal indiqué, sont strictement interdits pour l'exploitation de l'émetteur.

1:24 SCALE | 25004



FUNCTION INTRODUCTION OF REMOTE CONTROL

745 Articulated Truck OPERATING INSTRUCTIONS



745 Articulated Truck OPERATING INSTRUCTIONS



FULL FUNCTION RADIO CONTROL

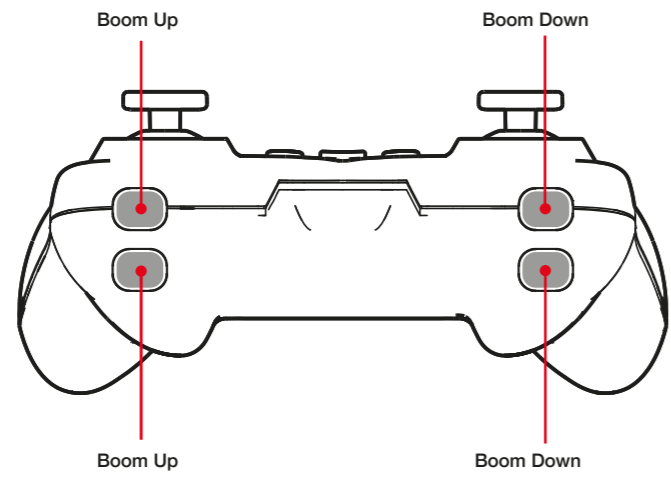
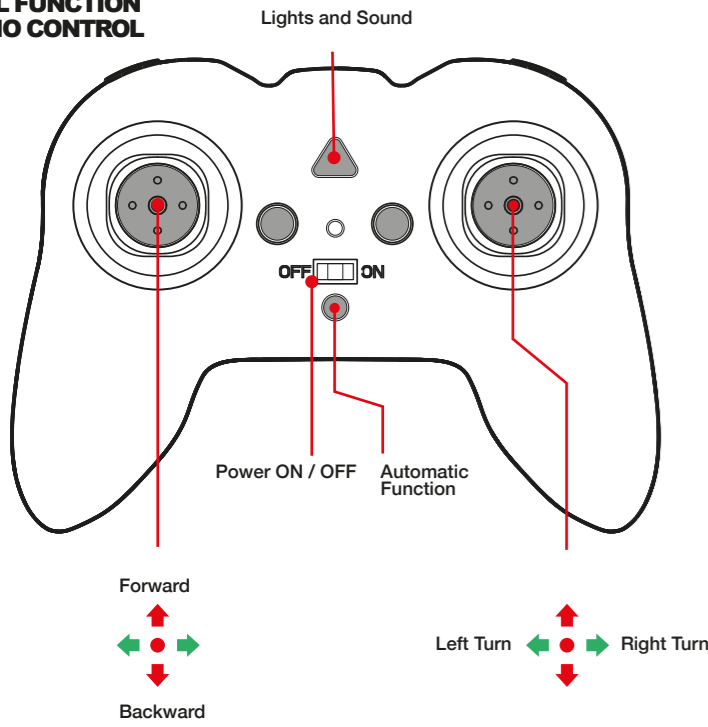

INDIVIDUAL MOVEMENT

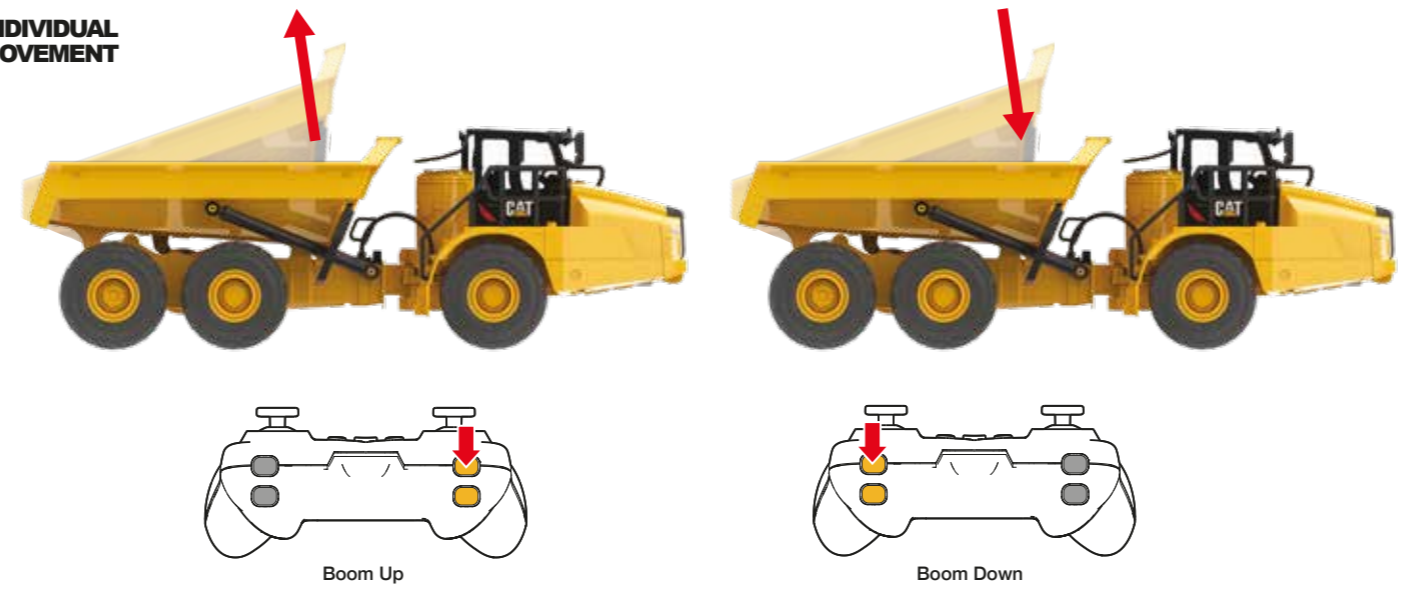

MODEL DRIVING CONTROL



REMOTE CONTROL FREQUENCY PAIRING AND POWER ON

This product is equipped with a remote control with a frequency of 2.4GHz. When a user operates the product for the first time, please install batteries into the model and the remote control. Then power on the unit, then the remote control. A series of beeps will indicate that the frequency pairing has been completed and the model is ready to operate.

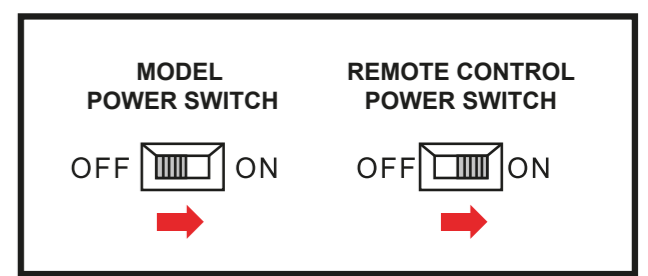

INSTALLATION OF REMOTE CONTROL MODEL BATTERY

Model is equipped with a 7.4V 600m Ah Li-Po battery (included). First, twist the buckle to open the battery cover, then correctly connect the battery following the diagram. Place the battery into the compartment. Close the battery cover and twist the buckle to lock the cover. Tighten the cover screw to avoid children easy access.

INSTALLATION OF REMOTE CONTROL BATTERY

The remote control requires 2 X 1.5V AAA non-rechargeable batteries. Open the battery cover by loosening the cover screw. Place the batteries into the compartment observing the correct polarity. Replace the battery cover and tighten the cover screw.

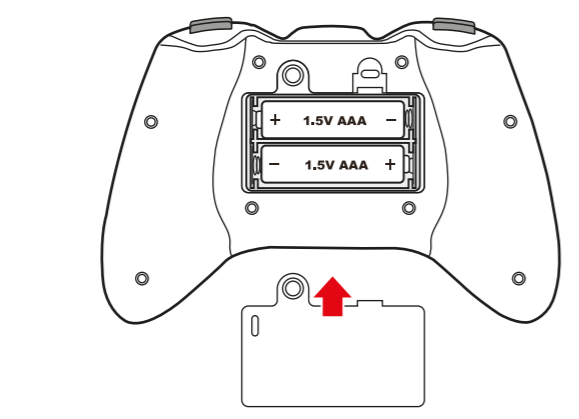
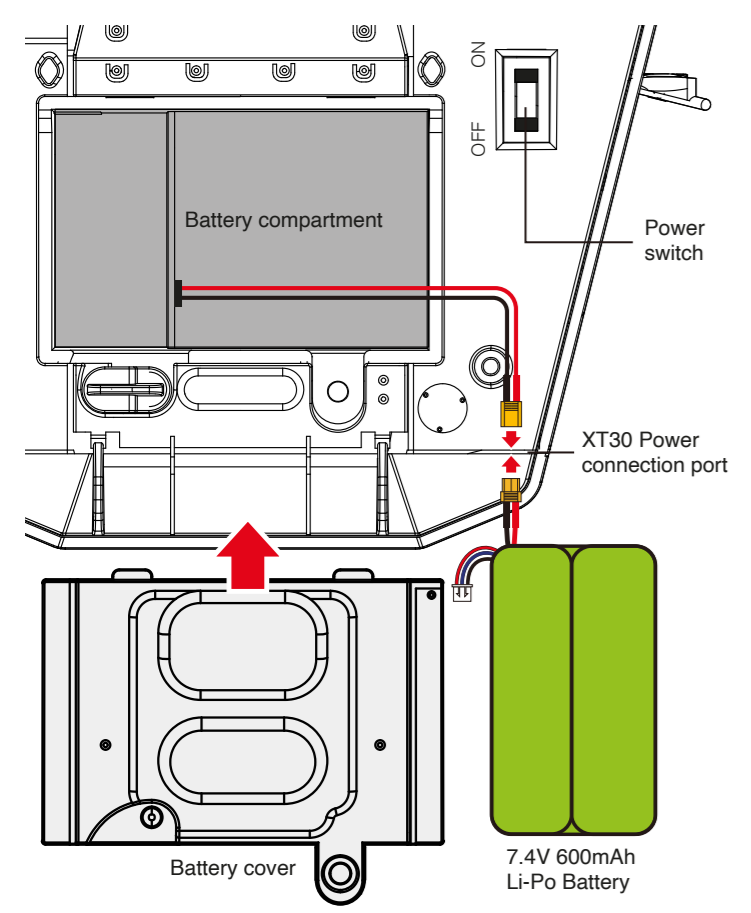

- Battery Installation Instructions:**
1. Remove rechargeable battery from package and install correctly in machine following included guidelines.
 2. The rechargeable battery should be removed from the machine before recharging.
 3. Recharge battery only under adult supervision.
 4. Do not use rechargeable AAA batteries in the remote control
 5. Do not combine old and new AAA batteries in the remote control.
 6. Use the same type or brand of new AAA batteries in the remote control
 7. Place AAA batteries in the remote control observing the correct polarity
 8. Use caution to avoid short-circuit of the battery terminals in the remote control

MODEL DRIVING CONTROL

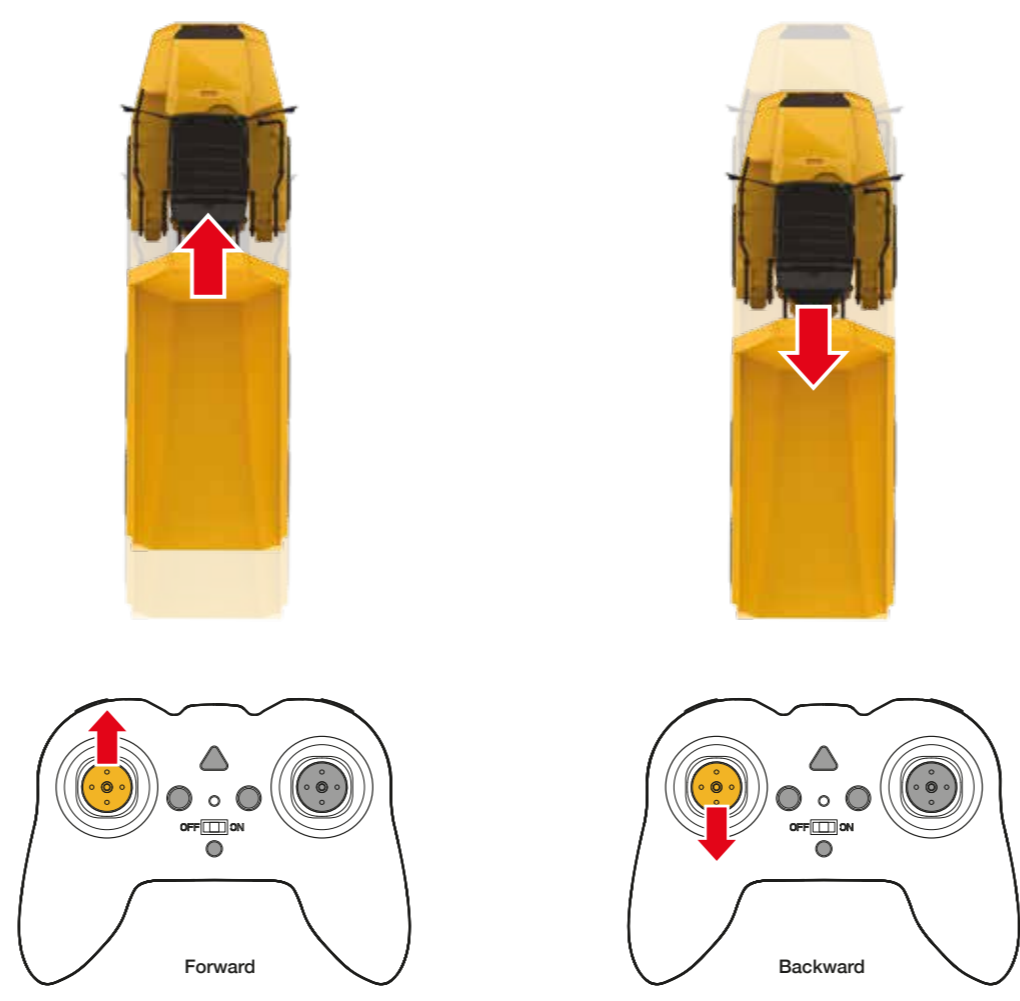

LIGHT AND SOUND CONTROL



LIGHT FUNCTIONS



SOUND FUNCTIONS

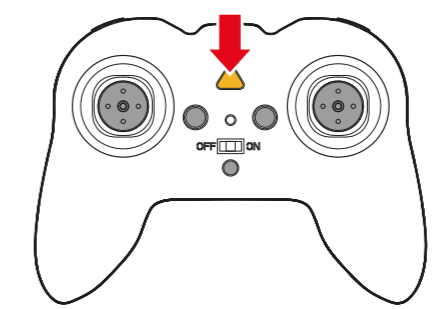

The operating model can generate lights and sounds. Press the sound switch to turn on the lights and sounds, press the switch again to turn them off.

We reserve the right to make technical and design-related changes

