

FCC AND IC CERTIFICATION TEST REPORT

Report No.: DDT-B22060716-2E01

Applicant	:	Wyze Labs, Inc.
Address	:	5808 Lake Washington Blvd NE Ste 300 Kirkland, WA 98033, United States
Equipment under Test	:	WYZE BULB COLOR BR30
Model No.	:	WLPBR30C
Trade Mark	:	WYZE
FCC ID	:	2AUIUWLPBR30C
IC	:	25466-WLPBR30C
Manufacturer	:	Wyze Labs, Inc.
Address	:	5808 Lake Washington Blvd NE Ste 300 Kirkland, WA 98033, United States

Issued By: Tianjin Dongdian Testing Service Co., Ltd.

Address: Building D-1, No. 19, Weisi Road, Microelectronics Industrial Park Development Area, Tianjin, China

Tel: +86-22-58038033, E-mail: ddt@dgddt.com, <http://www.ddttest.com>



REPORT

TABLE OF CONTENTS

	Test report declares.....	3
1.	Summary of Test Results	6
2.	General Test Information	7
2.1.	Description of EUT.....	7
2.2.	Accessories of EUT	7
2.3.	Assistant equipment used for test.....	7
2.4.	Block diagram of EUT configuration for test	8
2.5.	Deviations of test standard	8
2.6.	Test environment conditions	9
2.7.	Test laboratory.....	9
2.8.	Measurement uncertainty	10
3.	Equipment Used During Test.....	11
4.	6 dB Bandwidth and 99% Bandwidth.....	12
4.1.	Block diagram of test setup	12
4.2.	Limits	12
4.3.	Test procedure.....	12
4.4.	Test result.....	13
4.5.	Original test data.....	13
5.	Maximum Peak Output Power	17
5.1.	Block diagram of test setup	17
5.2.	Limits	17
5.3.	Test procedure.....	17
5.4.	Test result.....	17
5.5.	Original test data.....	18
6.	Power Spectral Density	20
6.1.	Block diagram of test setup	20
6.2.	Limits	20
6.3.	Test procedure.....	20
6.4.	Test result.....	21
6.5.	Original test data.....	21
7.	Band Edge Compliance (Conducted Method).....	23
7.1.	Block diagram of test setup	23
7.2.	Limits	23
7.3.	Test procedure.....	23
7.4.	Test result.....	24
7.5.	Original test data.....	24
8.	Radiated Emission.....	27

8.1.	Block diagram of test setup	27
8.2.	Limit	28
8.3.	Test Procedure	30
8.4.	Test result	31
9.	RF Conducted Spurious Emissions	45
9.1.	Block diagram of test setup	45
9.2.	Limits	45
9.3.	Test procedure.....	45
9.4.	Test result.....	46
9.5.	Original test data.....	46
10.	Band Edge Compliance (Radiated Method)	50
10.1.	Block diagram of test setup	50
10.2.	Limit	50
10.3.	Test Procedure	50
10.4.	Test result.....	50
11.	Power Line Conducted Emission	55
11.1.	Block diagram of test setup	55
11.2.	Power line conducted emission limits	55
11.3.	Test procedure.....	55
11.4.	Test result.....	56
12.	Antenna Requirements	58
12.1.	Limit	58
12.2.	Result	58
13.	Test Setup Photograph.....	59
14.	Photos of the EUT	61

Test Report Declare

Applicant	:	Wyze Labs, Inc.
Address	:	5808 Lake Washington Blvd NE Ste 300 Kirkland, WA 98033, United States
Equipment under Test	:	WYZE BULB COLOR BR30
Model No.	:	WLPBR30C
Trade Mark	:	WYZE
Manufacturer	:	Wyze Labs, Inc.
Address	:	5808 Lake Washington Blvd NE Ste 300 Kirkland, WA 98033, United States

Test Standard Used:

FCC Rules and Regulations Part 15 Subpart C, RSS-247 Issue 2 February 2017.

Test Procedure Used:

ANSI C63.10:2020, RSS-Gen Issue 5, Apr. 2018.

We Declare:

The equipment described above is tested by Tianjin Dongdian Testing Service Co., Ltd. and in the configuration tested the equipment complied with the standards specified above. The test results are contained in this test report and Tianjin Dongdian Testing Service Co., Ltd. is assumed of full responsibility for the accuracy and completeness of these tests.

After test and evaluation, our opinion is that the equipment provided for test compliance with the requirement of the above FCC&IC standards.

Report No.:	DDT-B22060716-2E01		
Date of Receipt:	Aug. 17, 2022	Date of Test:	Aug. 17, 2022 ~ Sep. 09, 2022

Prepared By:

Sunny Zhang

Sunny Zhang/Engineer

Approved By:

Leon Li/RF Manager

Note: This report applies to above tested sample only. This report shall not be reproduced in parts without written approval of Tianjin Dongdian Testing Service Co., Ltd.

The report must not be used by the client to claim product certification, approval, or endorsement by NVLAP, NIST, or any agency of the U.S. Government.

Revision History

Rev.	Revisions	Issue Date	Revised By
---	Initial issue	Sep. 09, 2022	

1. Summary of Test Results

Description of Test Item	Standard	Verdict
6dB Bandwidth and 99% Bandwidth	FCC 15.247 (a) (2) RSS-247 Clause 5.2 (a)	Pass
Maximum Conducted Output Power	FCC 15.247 (b) (3) RSS-247 Clause 5.4 (e)	Pass
Power Spectral Density	FCC 15.247 (e) RSS-247 Clause 5.2 (b)	Pass
Band-edge and Spurious Emissions (Conducted)	FCC 15.247 (d) RSS-247 Clause 5.5	Pass
Radiated Spurious Emissions	FCC 15.247 (d) FCC 15.209 FCC 15.205 RSS-247 Clause 5.5 RSS-GEN Clause 8.9	Pass
Radiated Band Edge Compliance	FCC 15.247 (d) FCC 15.209 FCC 15.205 RSS-247 Clause 5.5 RSS-GEN Clause 8.9	Pass
Power Line Conducted Emission	FCC 15.207 RSS-GEN Clause 8.8	Pass
Antenna Requirement	FCC 15.203 RSS-GEN Clause 6.8	Pass

2. General Test Information

2.1. Description of EUT

EUT* Name	: WYZE BULB COLOR BR30
Model Number	: WLPBR30C
EUT Function Description	: Please reference user manual of this device
Power Supply	: AC 120V/60Hz
Radio Specification	: Bluetooth V5.0
Operation Frequency	: 2402 MHz - 2480 MHz
Modulation	: GFSK
Data Rate	: 1 Mbps
Antenna Type	: Integrated antenna, maximum PK gain: 2.28 dBi
Sample Number	: N/A

Note: EUT is the ab. of equipment under test.

Channel information					
Channel	Frequency (MHz)	Channel	Frequency (MHz)	Channel	Frequency (MHz)
0	2402	14	2430	28	2458
1	2404	15	2432	29	2460
2	2406	16	2434	30	2462
3	2408	17	2436	31	2464
4	2410	18	2438	32	2466
5	2412	19	2440	33	2468
6	2414	20	2442	34	2470
7	2416	21	2444	35	2472
8	2418	22	2446	36	2474
9	2420	23	2448	37	2476
10	2422	24	2450	38	2478
11	2424	25	2452	39	2480
12	2426	26	2454		
13	2428	27	2456		

2.2. Accessories of EUT

Description of Accessories	Manufacturer	Model number	Description	SN
N/A	N/A	N/A	N/A	N/A

2.3. Assistant equipment used for test

Assistant equipment	Manufacturer	Model number	Description	SN
Notebook	Lenovo Beijing Co. Ltd.	ThinkPad E450c	N/A	TP00067A

2.4. Block diagram of EUT configuration for test

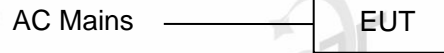

Test software: EspRFTTestTool_v2.8_Manual.EXE

The test software was used to control EUT work in Continuous Tx mode, and select test channel, wireless mode as below table.

Tested mode, channel, information			
Mode	Setting Tx Power	Channel	Frequency (MHz)
GFSK	12	CH0	2402
	12	CH19	2440
	12	CH39	2480

2.5. Deviations of test standard

No deviation.

2.6. Test environment conditions

During the measurement the environmental conditions were within the listed ranges:

Temperature range:	21-25 °C
Humidity range:	25-75%
Pressure range:	86-106 kPa

2.7. Test laboratory

Tianjin Dongdian Testing Service Co., Ltd.

Address: Building D-1, No. 19, Weisi Road, Microelectronics Industrial Park Development Area, Tianjin, China.

Tel: +86-22-58038033, <http://www.ddttest.com>, Email: ddt@dqddt.com

NVLAP (National Voluntary Laboratory Accreditation Program) CODE: 500036-0

CNAS (China National Accreditation Service for Conformity Assessment) CODE: L13402

FCC Designation Number: CN5004; FCC Test Firm Registration Number: 368676

ISED (Innovation, Science and Economic Development Canada) Company Number: 27768

Conformity Assessment Body Identifier: CN0125

VCCI Facility Registration Number: C-20089, T-20093, R-20125, G-20122

2.8. Measurement uncertainty

Test Item	Uncertainty
Bandwidth	0.14%
Peak Output Power (Conducted) (Spectrum Analyzer)	0.12 dB (10 MHz ≤ f < 3.6 GHz);
	0.32 dB (3.6 GHz ≤ f < 8 GHz)
Peak Output Power (Conducted) (Power Sensor)	0.51 dB
Power Spectral Density	0.12 dB (10 MHz ≤ f < 3.6 GHz);
	0.32 dB (3.6 GHz ≤ f < 8 GHz)
Frequencies Stability	6.7 × 10 ⁻⁸ (Antenna couple method)
	3.4 × 10 ⁻⁸ (Conducted method)
Conducted Spurious Emissions	0.12 dB (10 MHz ≤ f < 3.6 GHz);
	0.32 dB (3.6 GHz ≤ f < 8 GHz)
	0.52 dB (8 GHz ≤ f < 22 GHz)
Uncertainty for Radio Frequency (RBW < 20 kHz)	3×10 ⁻⁷
Temperature	±2°C
Humidity	±1%
Uncertainty for Radiation Emission Test (30 MHz - 1 GHz)	2.72 dB (Antenna Polarize: V)
	2.72 dB (Antenna Polarize: H)
Uncertainty for Radiation Emission Test (1 GHz - 40 GHz)	2.74 dB (1 - 6 GHz)
	2.72 dB (6 GHz - 18 GHz)
	3.54 dB (18 GHz - 26 GHz)
	4.30 dB (26 GHz - 40 GHz)
Uncertainty for Power Line Conduction Emission Test	3.40 dB (150 kHz - 30 MHz)
Note: This uncertainty represents an expanded uncertainty expressed at approximately the 95% confidence level using a coverage factor of k=2.	

3. Equipment Used During Test

Equipment	Manufacturer	Model No.	Serial No.	Last Cal.	Cal. Interval
RF Connected Test (MWRFtest system)					
Microwave Signal Generator	R&S	SMF100A	101396	2022/05/26	1 Year
MXG Vector Signal Generator	Keysight	N5182A	MY50143288	2022/03/07	1 Year
EMI Test Receiver	R&S	ESU26	100243	2022/03/03	1 Year
Wideband Radio Communication Tester	R&S	CMW500	158800	2022/06/11	1 Year
Power Sensor	KEYSIGHT	U2021XA	MY59150007	2022/03/23	1 Year
DC Power Supply	inSTEK	PSP-2010	EN122317	2022/02/12	1 Year
Test Software	MWRFtest	MTS8310	V03	N/A	N/A
Radiated Emission -10m EMI Chamber					
Broadband Horn Antenna	TESEQ	BHA 9118	31754	2021/10/12	1 Year
Broad Band Horn Antenna	Schwarzbeck	BBHA 9170	790	2022/05/06	1 Year
Active Loop Antenna	R&S	HFH2-Z2	100269	2022/05/08	1 Year
Low noise amplifier	MITEQ	TPA0118-36	0914	2022/02/16	1 Year
EMI Test Receiver	R&S	ESCI	101024	2022/03/03	1 Year
EMI Test Receiver	R&S	ESCI	101030	2022/03/29	1 Year
EMI Test Receiver	R&S	ESU26	100244	2022/03/03	1 Year
Bilog Antenna	TESEQ	CBL6112D	29068	2020/10/12	2 Year
Bilog Antenna	TESEQ	CBL6112D	29069	2020/10/12	2 Year
Amplifier	Sonoma	310N	300913	2022/02/15	1 Year
Amplifier	Sonoma	310N	300914	2022/02/15	1 Year
Ant Mast	Innco	MA4000	N/A	N/A	N/A
Ant Mast	Innco	MA4000	N/A	N/A	N/A
Mast Controller	Innco	CO2000	N/A	N/A	N/A
Mast Controller	Innco	CO2000	N/A	N/A	N/A
RF Selector 4CH	TOYO	NS4904N	Selector1	N/A	N/A
RF Selector 4CH	TOYO	NS4904N	Selector2	N/A	N/A
Test software	TOYO	EP5/RSE	Ver 1.9.1	N/A	N/A
Test software	Audix	E3	V 6.11111b	N/A	N/A
Power Line Conducted Emissions Test					
Test Receiver	R&S	ESCI	101397	2022/03/03	1 Year
LISN	R&S	ENV216	101122	2022/03/31	1 Year
Test software	TOYO	EP5/CE	V 5.4.40	N/A	N/A

4. 6 dB Bandwidth and 99% Bandwidth

4.1. Block diagram of test setup

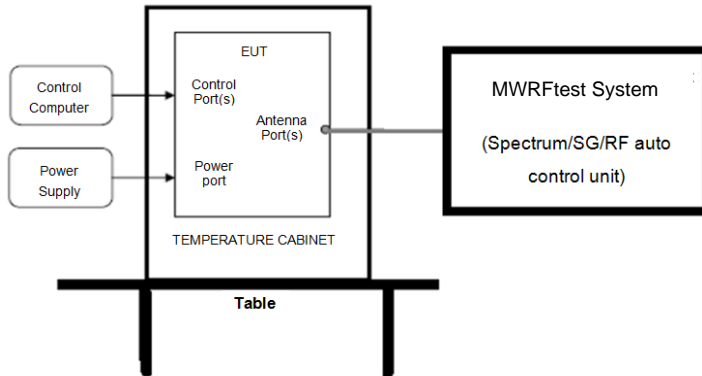

4.2. Limits

For direct sequence systems, the minimum 6 dB bandwidth shall be at least 500 kHz

4.3. Test procedure

(1) Connect EUT's antenna output to spectrum analyzer by RF cable.

(2) 99% Bandwidth set the spectrum analyzer as follows:

RBW:	30 kHz
VBW:	100 kHz
Detector Mode:	Peak
Sweep time:	auto
Trace mode	Max hold

(3) 6 dB Bandwidth set the spectrum analyzer as follows:

RBW:	100 kHz
VBW:	300 kHz
Detector Mode:	Peak
Sweep time:	auto
Trace mode	Max hold

(4) Allow the trace to stabilize, measure the 6 dB and 99% bandwidth of signal.

4.4. Test result

Mode	Channel	99% bandwidth Result (MHz)	6 dB bandwidth Result (MHz)	6 dB width Limit (MHz)	Verdict
BLE 1M	CH0	1.024	0.633	>0.5	Pass
	CH19	1.025	0.631	>0.5	Pass
	CH39	1.026	0.632	>0.5	Pass

4.5. Original test data

99% bandwidth

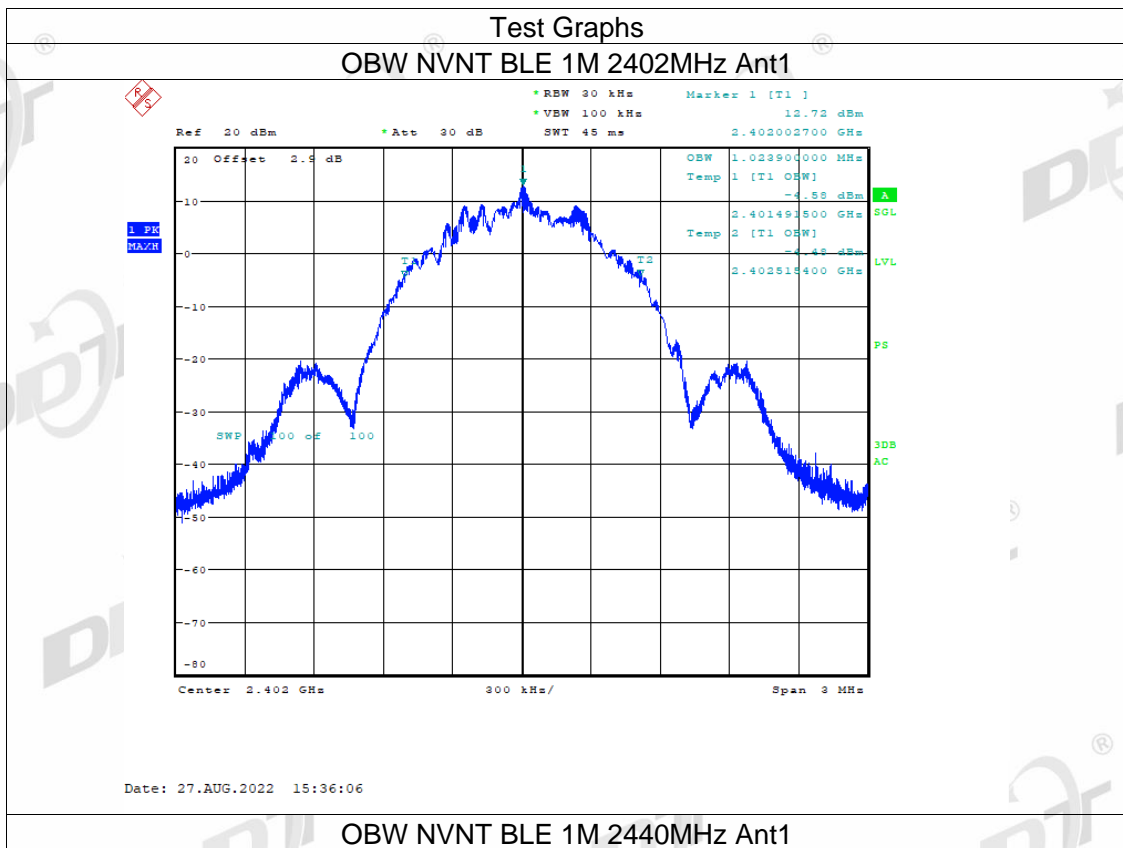

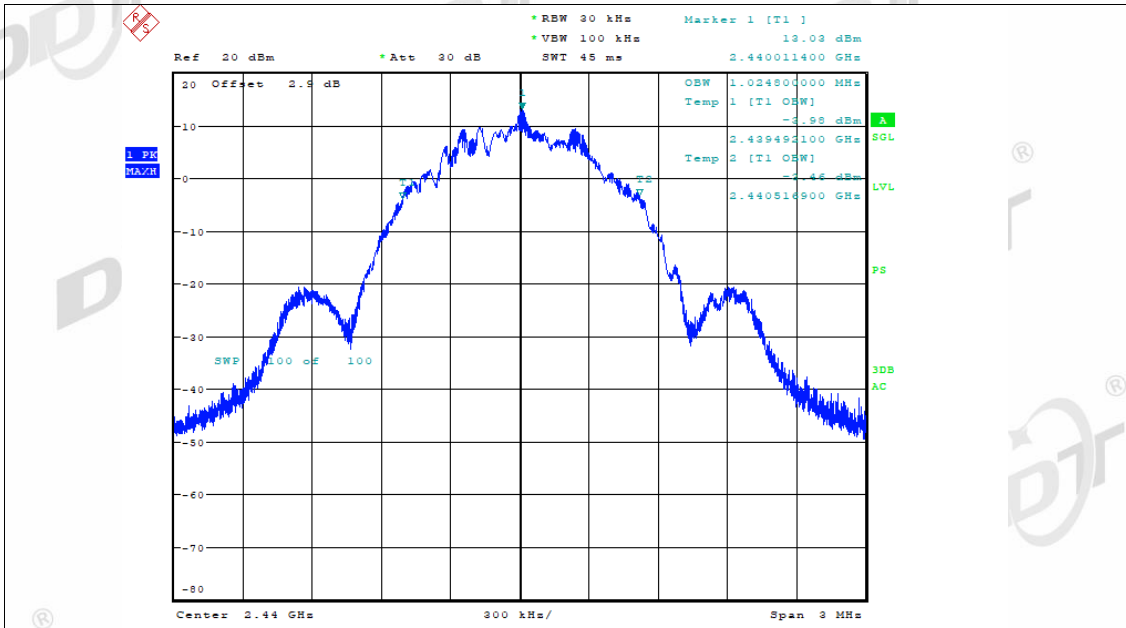

Date: 27.AUG.2022 15:38:59

OBW NVNT BLE 1M 2480MHz Ant1

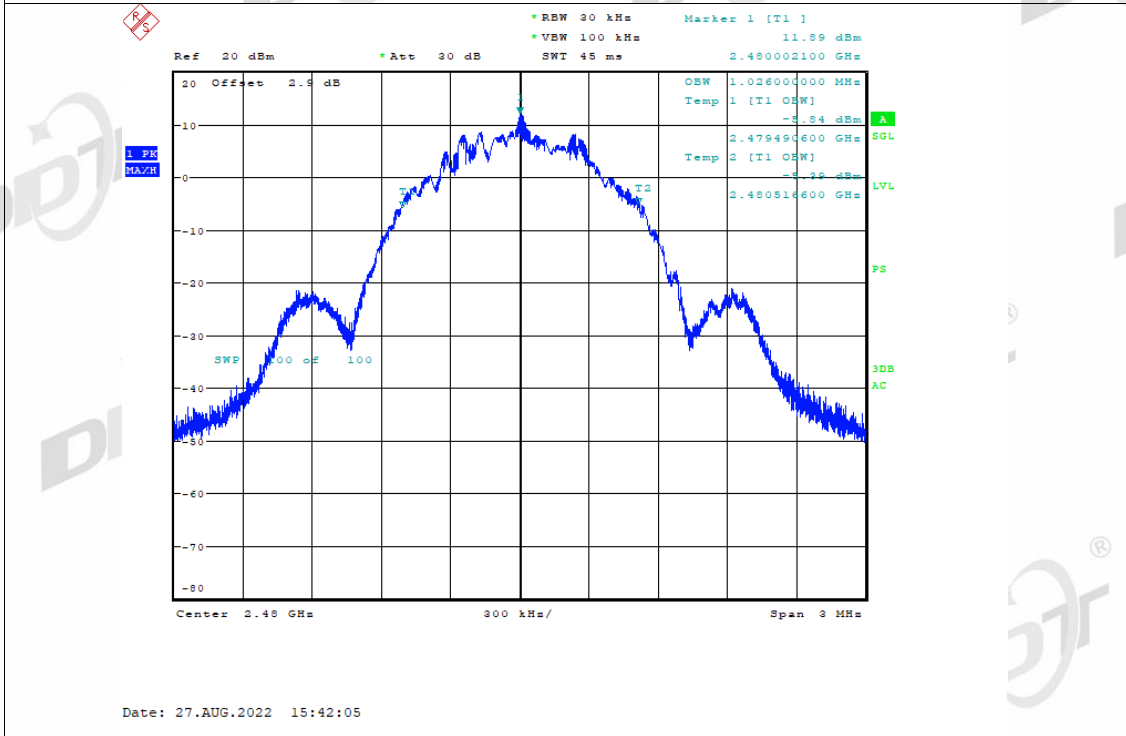

Date: 27.AUG.2022 15:42:05

6 dB bandwidth

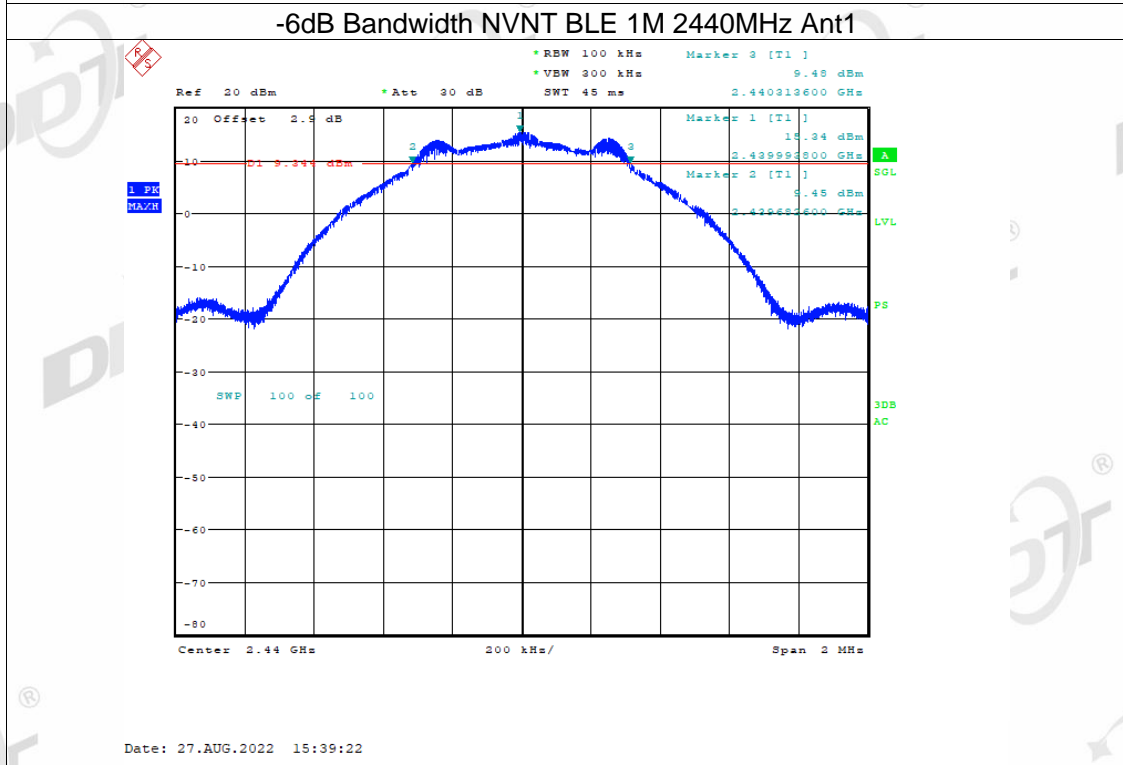
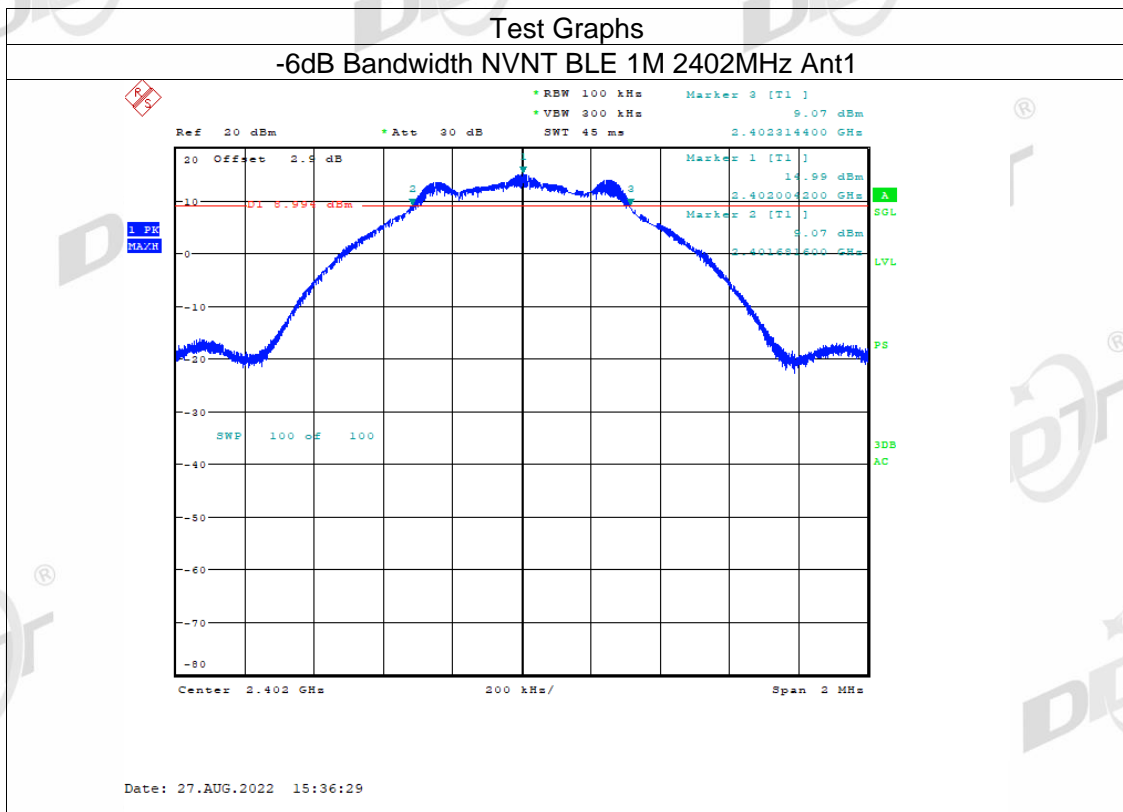

-6dB Bandwidth NVNT BLE 1M 2480MHz Ant1

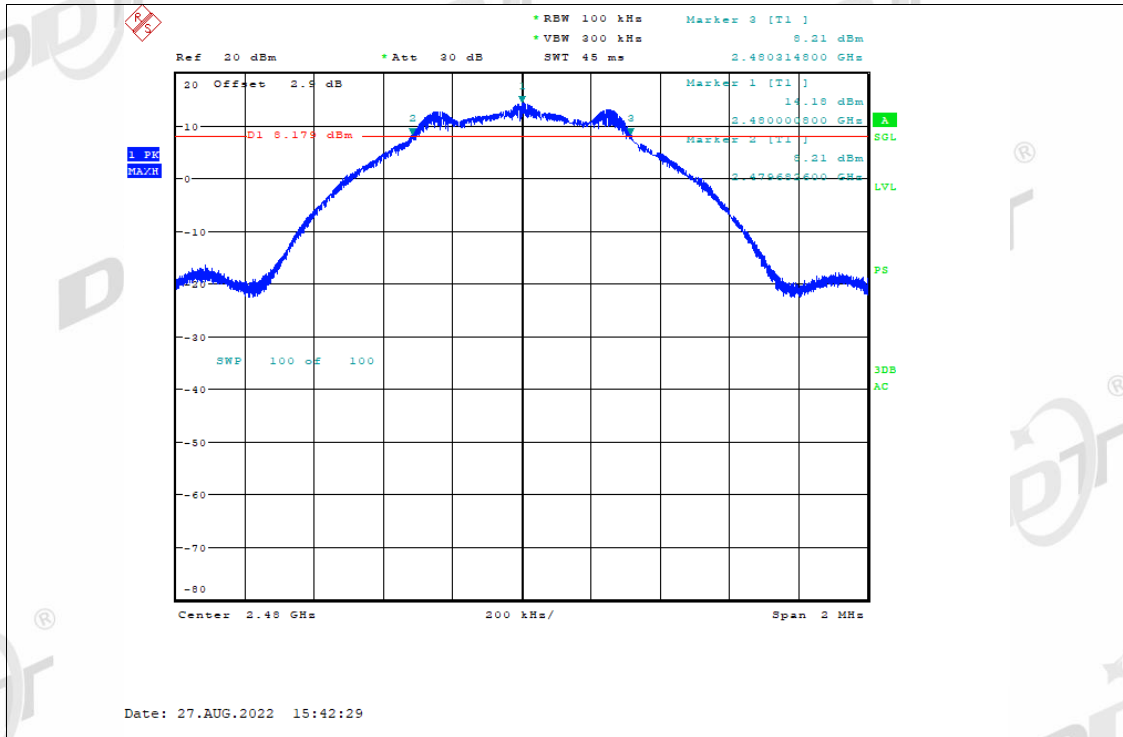

5. Maximum Peak Output Power

5.1. Block diagram of test setup

Same with 4.1

5.2. Limits

For systems using digital modulation in the 902-928 MHz, 2400-2483.5 MHz, and 5725-5850 MHz bands: 1 Watt. If transmitting antennas of directional gain greater than 6dBi are used, the conducted output power from the intentional radiator shall be reduced below the stated values as appropriate, by the amount in dB that the directional gain of the antenna exceeds 6 dBi.

5.3. Test procedure

- (1) Connect EUT's antenna output to spectrum analyzer by RF cable.
- (2) Set the spectrum analyzer as follows:

RBW:	≥DTS bandwidth
VBW:	≥3 x RBW
Span	≥3 x RBW
Detector Mode:	Peak
Sweep time:	auto
Trace mode	Max hold
- (3) Allow the trace to stabilize, Use the instrument's band/channel power measurement function with the band limits set equal to the DTS bandwidth edges measure out the PK output power.

5.4. Test result

Mode	Freq. (MHz)	Peak Output Power (dBm)	Limit (dBm)	EIRP (dBm)	EIRP Limit (dBm)	Verdict
BLE 1M	2402	15.67	30	17.95	36	Pass
	2440	16.35	30	18.63	36	Pass
	2480	14.99	30	17.27	36	Pass

5.5.Original test data

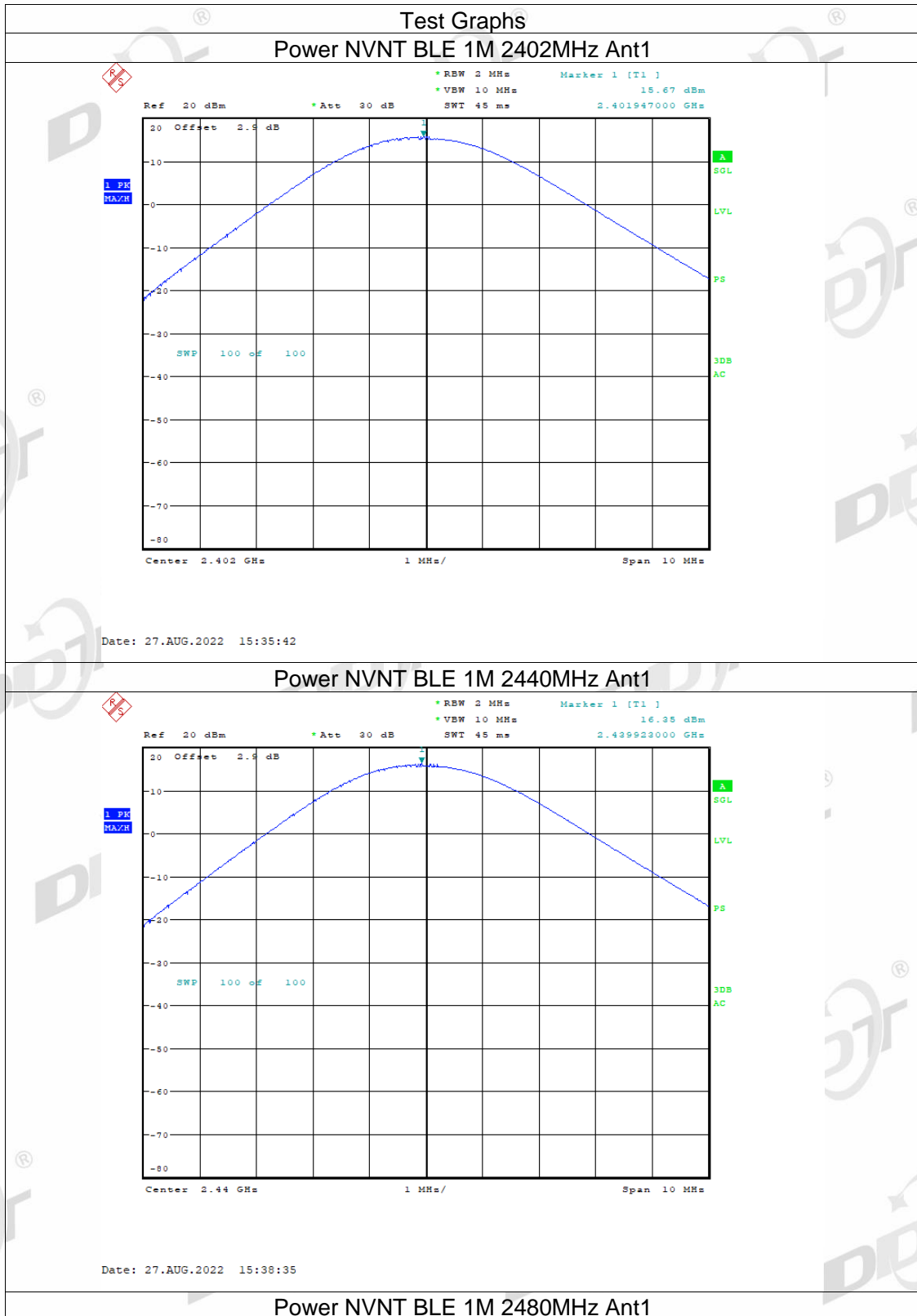

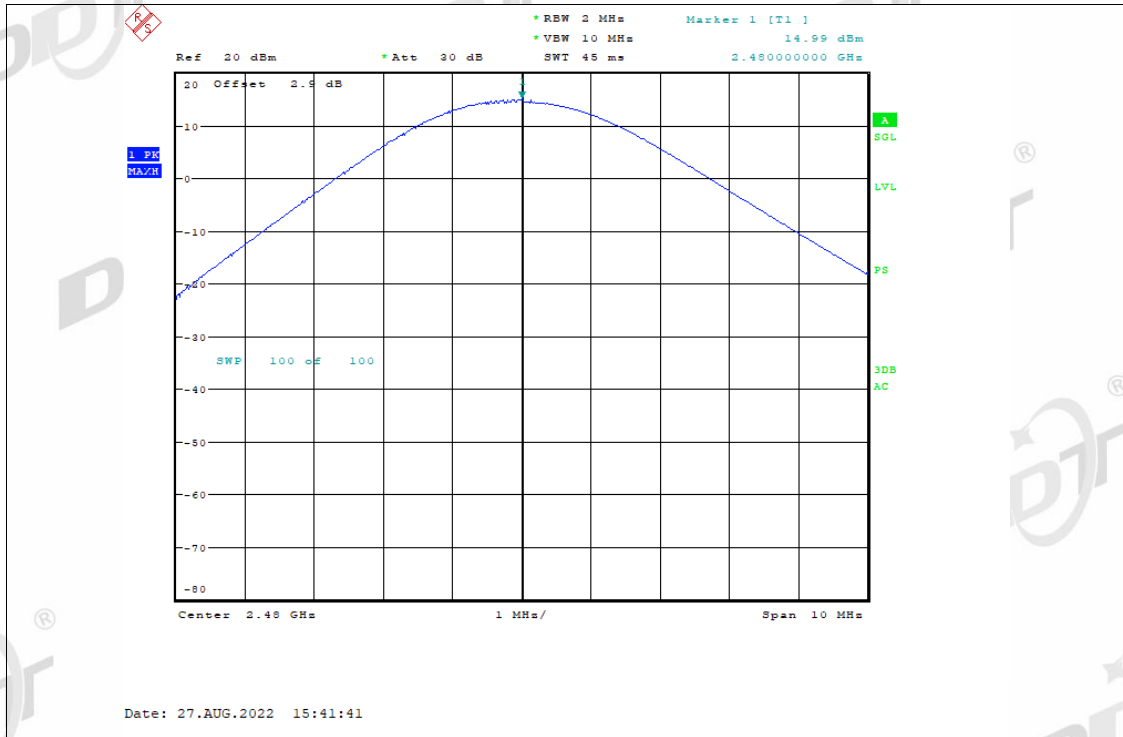

6. Power Spectral Density

6.1. Block diagram of test setup

Same with 4.1

6.2. Limits

For digitally modulated systems, the power spectral density conducted from the intentional radiator to the antenna shall not be greater than 8 dBm in any 3 kHz band during any time interval of continuous transmission.

6.3. Test procedure

(1) Connect EUT's antenna output to spectrum analyzer by RF cable.

(2) Set the spectrum analyzer as follows:

Center frequency	DTS Channel center frequency
RBW:	$3 \text{ kHz} \leq \text{RBW} \leq 100 \text{ kHz}$
VBW:	$\geq 3\text{RBW}$
Span	1.5 times the DTS bandwidth
Detector Mode:	Peak
Sweep time:	auto
Trace mode	Max hold

(3) Allow the trace to stabilize, use the peak marker function to determine the maximum amplitude level within the RBW.

(4) If measured value exceeds limit, reduce RBW (no less than 3 kHz) and repeat.

6.4. Test result

EUT Set Mode	Antenna	Channel	Result (dBm/3 kHz)
BLE 1M	ANT1	CH0	-0.37
	ANT1	CH19	-0.19
	ANT1	CH39	-1.15
Limit: <8 dBm/3 kHz			Verdict: Pass

6.5. Original test data

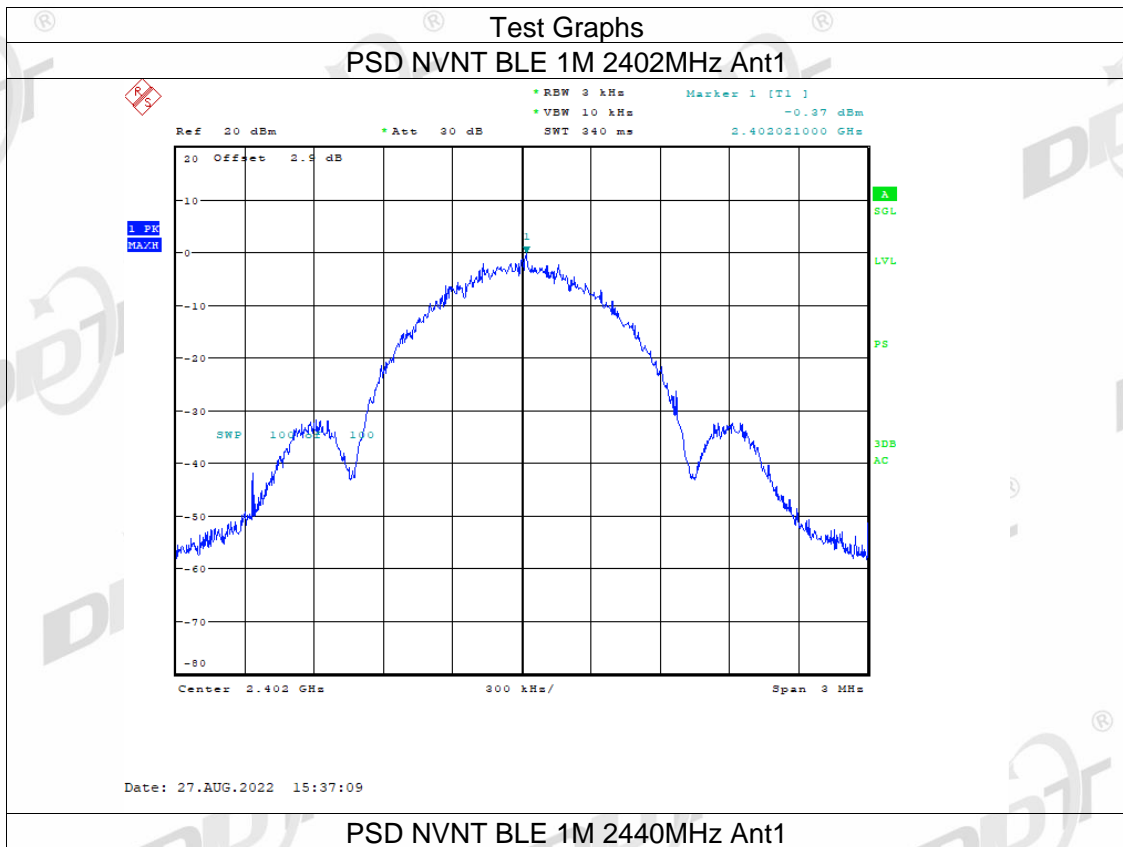

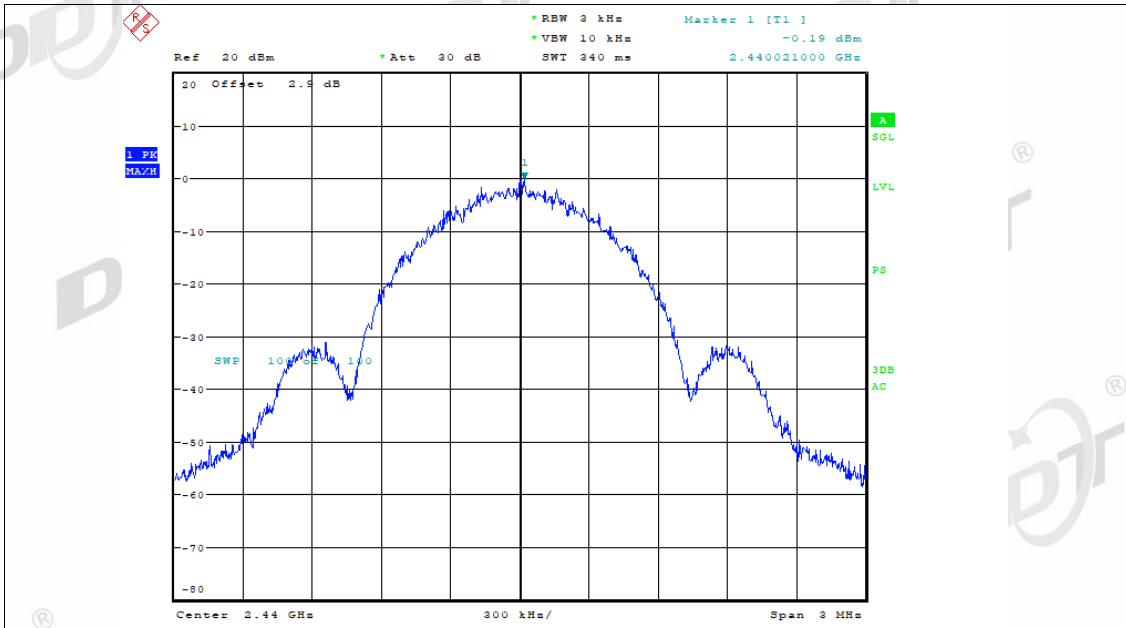

Date: 27.AUG.2022 15:40:02

PSD NVNT BLE 1M 2480MHz Ant1

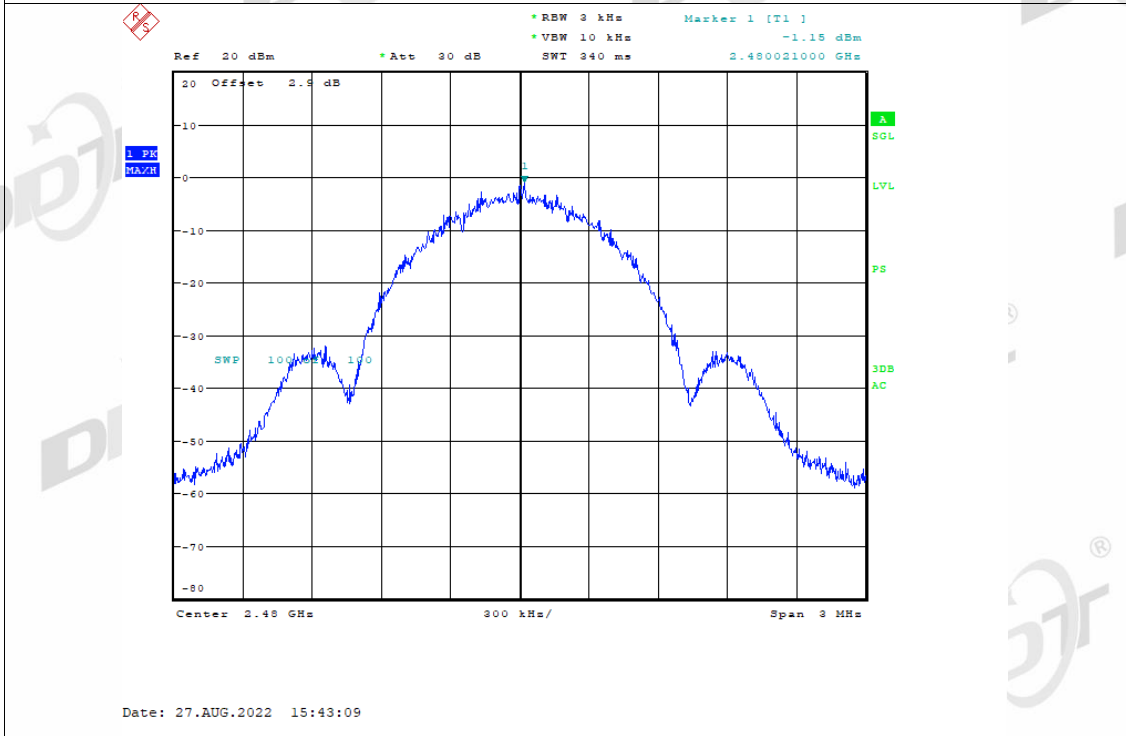

Date: 27.AUG.2022 15:43:09

7. Band Edge Compliance (Conducted Method)

7.1. Block diagram of test setup

Same with 4.1

7.2. Limits

In any 100 kHz bandwidth outside the frequency bands in which the spread spectrum intentional radiator is operating, the radio frequency power that is produced by the intentional radiator shall be at least 20 dB below that in the 100 kHz bandwidth within the band that contains the highest level of the desired power.

7.3. Test procedure

(1) Connect EUT's antenna output to spectrum analyzer by RF cable.

(2) Establish a reference level by using the following procedure:

Center frequency	DTS Channel center frequency
RBW:	100 kHz
VBW:	300 kHz
Span	1.5 times the DTS bandwidth
Detector Mode:	Peak
Sweep time:	auto
Trace mode	Max hold

(3) Allow the trace to stabilize, use the peak marker function to determine the maximum peak power level to establish the reference level.

(4) Set the spectrum analyzer as follows:

RBW:	100 kHz
VBW:	300 kHz
Span	Encompass frequency range to be measured
Number of measurement points	$\geq \text{span}/\text{RBW}$
Detector Mode:	Peak
Sweep time:	auto
Trace mode	Max hold

(5) Allow the trace to stabilize, use the peak marker function to determine the maximum amplitude of all unwanted emissions outside of the authorized frequency band

7.4. Test result

EUT Set Mode	CH or Frequency	Measured Range	Verdict
GFSK 1M	CH0	2.306 GHz - 2.406 GHz	Pass
	CH39	2.476 GHz - 2.576 GHz	Pass
GFSK 2M	CH0	2.306 GHz - 2.406 GHz	Pass
	CH39	2.476 GHz - 2.576 GHz	Pass

7.5. Original test data

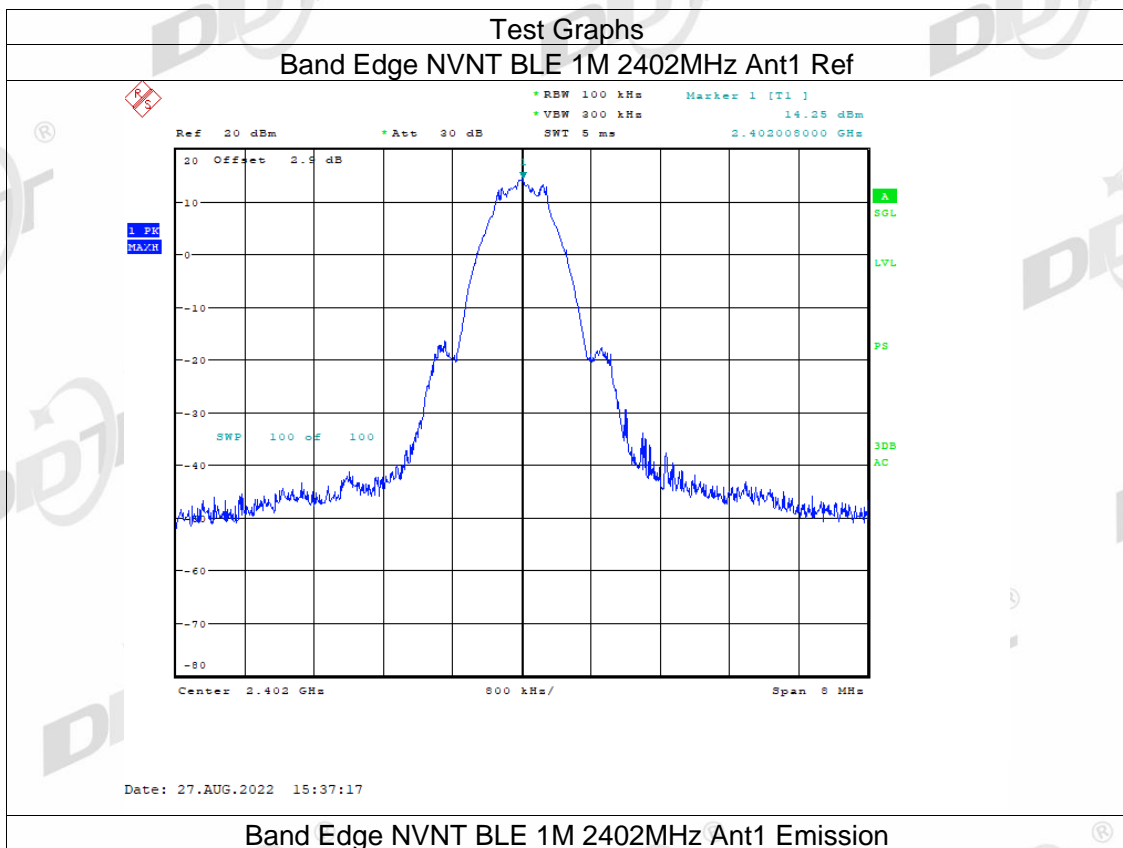

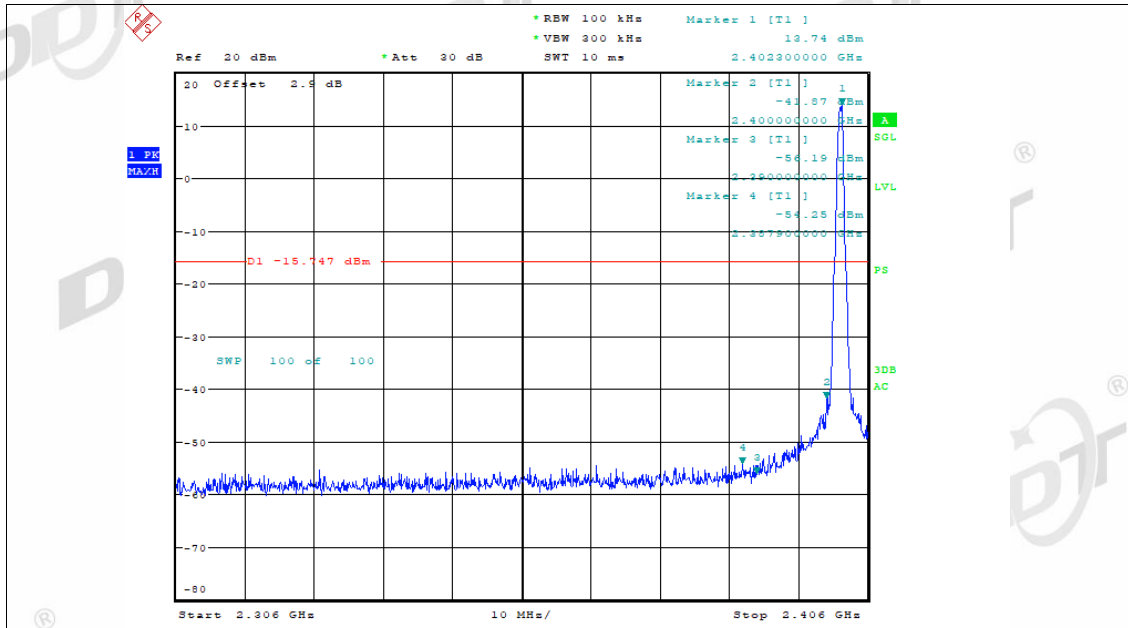

Date: 27.AUG.2022 15:37:21

Band Edge NVNT BLE 1M 2480MHz Ant1 Ref

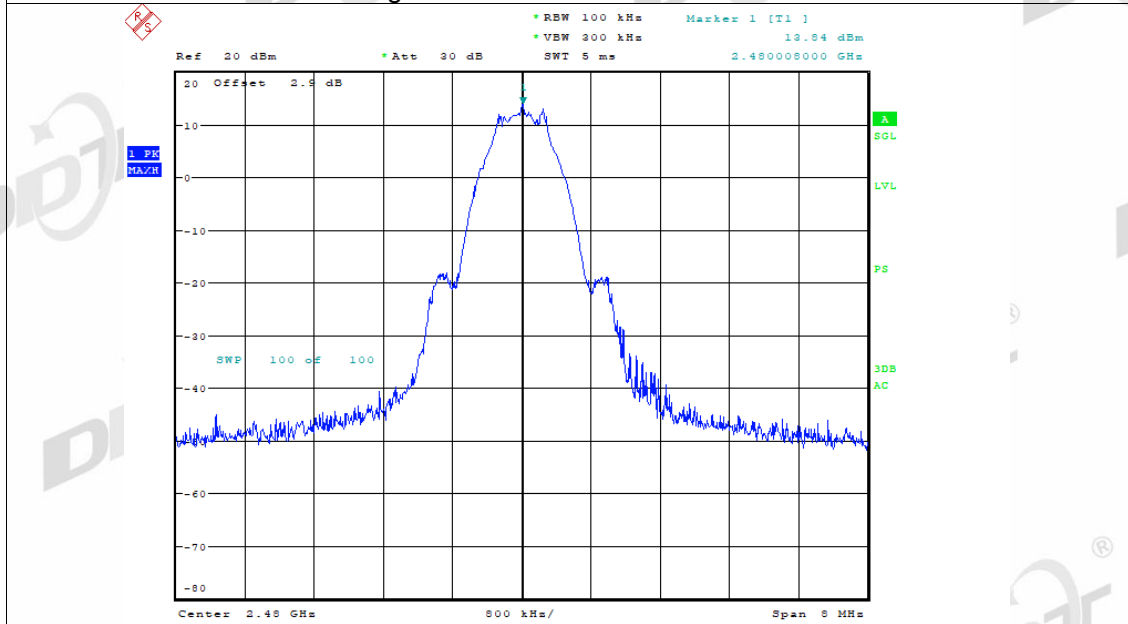

Date: 27.AUG.2022 15:43:19

Band Edge NVNT BLE 1M 2480MHz Ant1 Emission

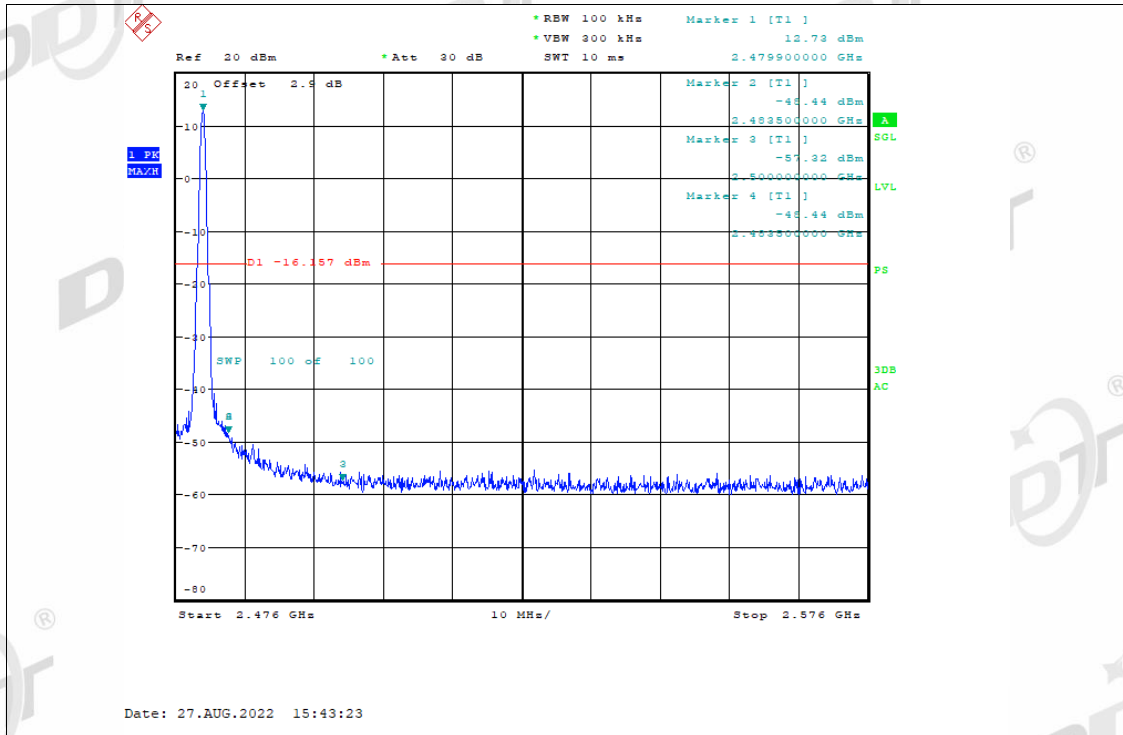

8. Radiated Emission

8.1. Block diagram of test setup

Anechoic Chamber, test setup diagram for 9 kHz - 30 MHz:

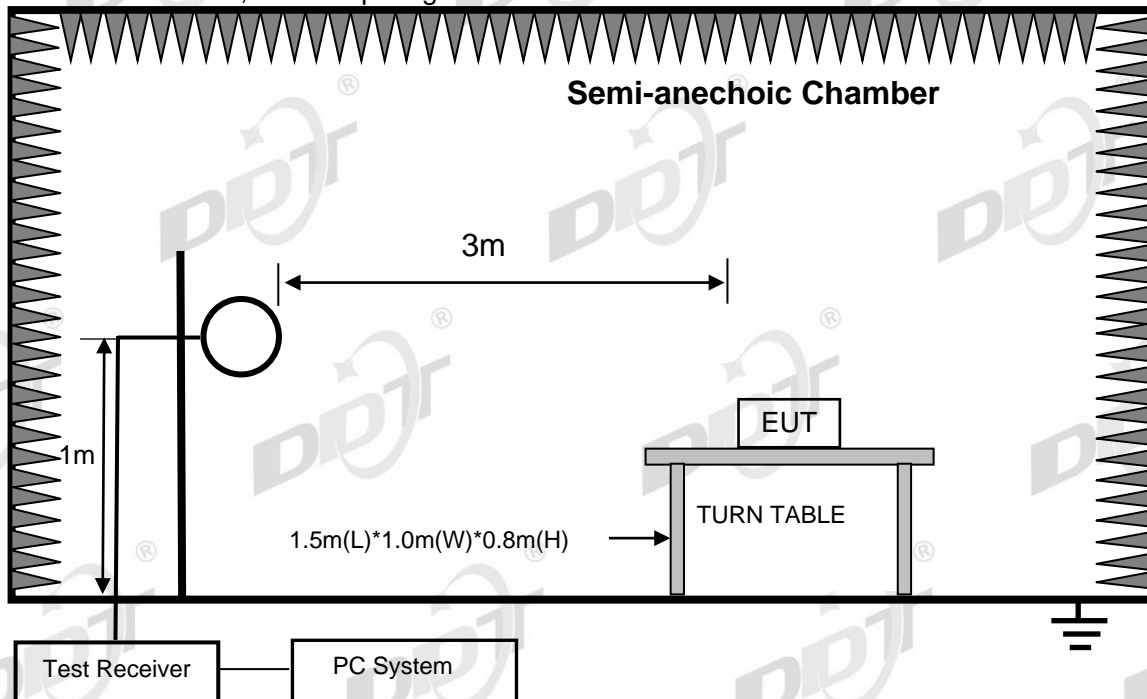

Anechoic Chamber, test setup diagram for 30 MHz - 1 GHz:

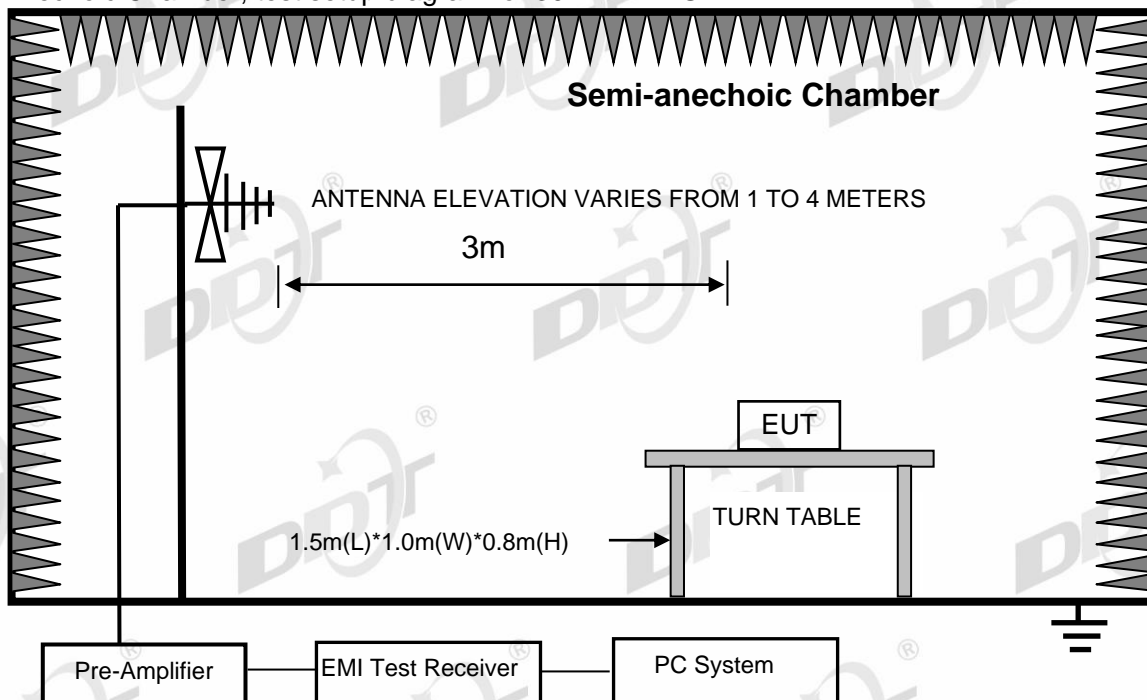

Anechoic Chamber, test setup diagram for frequency above 1 GHz:

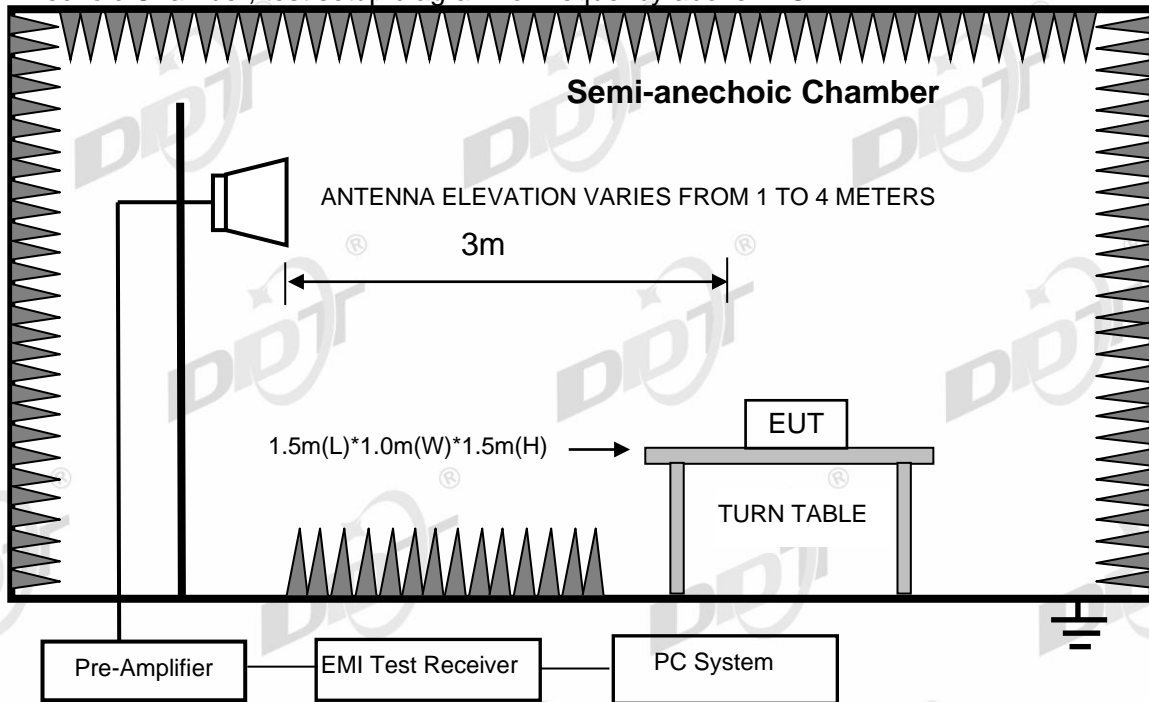

Note: For harmonic emissions test an appropriate high pass filter was inserted in the input port of AMP.

8.2. Limit

(1) FCC 15.205 Restricted frequency band

MHz	MHz	MHz	GHz
0.090-0.110	16.42-16.423	399.9-410	4.5-5.15
¹ 0.495-0.505	16.69475-16.69525	608-614	5.35-5.46
2.1735-2.1905	16.80425-16.80475	960-1240	7.25-7.75
4.125-4.128	25.5-25.67	1300-1427	8.025-8.5
4.1772&4.17775	37.5-38.25	1435-1626.5	9.0-9.2
4.2072&4.20775	73-74.6	1645.5-1646.5	9.3-9.5
6.215-6.218	74.8-75.2	1660-1710	10.6-12.7
6.26775-6.26825	108-121.94	1718.8-1722.2	13.25-13.4
6.31175-6.31225	123-138	2200-2300	14.47-14.5
8.291-8.294	149.9-150.05	2310-2390	15.35-16.2
8.362-8.366	156.52475-156.52525	2483.5-2500	17.7-21.4
8.37625-8.38675	156.7-156.9	2690-2900	22.01-23.12
8.41425-8.41475	162.0125-167.17	3260-3267	23.6-24.0
12.29-12.293	167.72-173.2	3332-3339	31.2-31.8
12.51975-12.52025	240-285	3345.8-3358	36.43-36.5
12.57675-12.57725	322-335.4	3600-4400	(²)
13.36-13.41			

¹Until February 1, 1999, this restricted band shall be 0.490-0.510 MHz.

²Above 38.6

(2) RSS-GEN Restricted frequency band*

MHz	MHz	MHz	GHz
0.090-0.110	12.57675-12.57725	399.9-410	7.25-7.75
0.495-0.505	13.36-13.41	608-614	8.025-8.5
2.1735-2.1905	16.42-16.423	960-1427	9.0-9.2
3.020-3.026	16.69475-16.69525	1435-1626.5	9.3-9.5
4.125-4.128	16.80425-16.80475	1645.5-1646.5	10.6-12.7
4.17725-4.17775	25.5-25.67	1660-1710	13.25-13.4
4.20725-4.20775	37.5-38.25	1718.8-1722.2	14.47-14.5
5.677-5.683	73-74.6	2200-2300	15.35-16.2
6.215-6.218	74.8-75.2	2310-2390	17.7-21.4
6.26775-6.26825	108-138	2483.5-2500	22.01-23.12
6.31175-6.31225	149.9-150.05	2655-2900	23.6-24.0
8.291-8.294	156.52475-156.52525	3260-3267	31.2-31.8
8.362-8.366	156.7-156.9	3332-3339	36.43-36.5
8.37625-8.38675	162.0125-167.17	3345.8-3358	Above 38.6
8.41425-8.41475	167.72-173.2	3500-4400	
12.29-12.293	240-285	4.5-5.15	
12.51975-12.52025	322-335.4	5.35-5.46	

* Certain frequency bands listed in table 7 and in bands above 38.6 GHz are designated for licence-exempt applications. These frequency bands and the requirements that apply to related devices are set out in the 200 and 300 series of RSSs.

(3) FCC 15.209 & RSS-GEN Limit.

FREQUENCY MHz [®]	DISTANCE Meters [®]	FIELD STRENGTHS LIMIT	
		μV/m	dB(μV)/m
0.009 ~ 0.490	300	2400/F(kHz)	67.6-20log(F)
0.490 ~ 1.705	30	24000/F(kHz)	87.6-20log(F)
1.705 ~ 30.0	30	30	29.54
30 ~ 88	3	100	40.0
88 ~ 216	3	150	43.5
216 ~ 960	3	200	46.0
960 ~ 1000	3	500	54.0
Above 1000	3	74.0 dB(μV)/m (Peak) 54.0 dB(μV)/m (Average)	

Note: (1) The emission limits shown in the above table are based on measurements employing a CISPR QP detector except for the frequency bands 9 - 90 kHz, 110 - 490 kHz and above 1000 MHz, radiated emissions limits in these three bands are based on measurements employing an average detector.

(2) At frequencies below 30 MHz, measurement may be performed at a distance closer than that specified, and the limit at closer measurement distance can be extrapolated by below formula:

$$\text{Limit}_{3m}(\text{dBuV}/\text{m}) = \text{Limit}_{30m}(\text{dBuV}/\text{m}) + 40\text{Log}(30\text{m}/3\text{m})$$

(4) Limit for this EUT

All the emissions appearing within 15.205 & RSS-GEN restricted frequency bands shall not exceed the limits shown in 15.209 & RSS-GEN, all the other emissions shall be at least 20dB below the fundamental emissions or comply with 15.209 & RSS-GEN limits.

8.3. Test Procedure

- (1) EUT was placed on a non-metallic table, 80 cm above the ground plane inside a semi-anechoic chamber for below 1G and 150 cm above the ground plane inside a fully-anechoic chamber for above 1G.
- (2) Test antenna was located 3 m from the EUT on an adjustable mast, and the antenna used as below table.

Test frequency range	Test antenna used	Test antenna distance
9 kHz - 30 MHz	Active Loop antenna	3 m
30 MHz - 1 GHz	Trilog Broadband Antenna	3 m
1 GHz - 18 GHz	Double Ridged Horn Antenna (1 GHz - 18 GHz)	3 m
18 GHz - 40 GHz	Horn Antenna (18 GHz - 40 GHz)	3 m

According to ANSI C63.10:2013 clause 6.4.4.2 and 6.5.3, for measurements below 30 MHz, the loop antenna was positioned with its plane vertical from the EUT and rotated about its vertical axis for maximum response at each azimuth position around the EUT. And the loop antenna also is positioned with its plane horizontal at the specified distance from the EUT. The center of the loop is 1 m above the ground. For measurement above 30 MHz, the trilog Broadband Antenna or Horn Antenna was located 3 m from EUT, Measurements were made with the antenna positioned in both the horizontal and vertical planes of Polarization, and the measurement antenna was varied from 1 m to 4 m. in height above the reference ground plane to obtain the maximum signal strength.

- (3) Below pre-scan procedure was first performed in order to find prominent frequency spectrum radiated emissions from 9 kHz to 25 GHz:

- (a) Scanning the peak frequency spectrum with the antenna specified in step (3), and the EUT was rotated 360 degree, the antenna height was varied from 1 m to 4 m (Except loop antenna, it's fixed 1 m above ground.)

- (b) Change work frequency or channel of device if practicable.

- (c) Change modulation type of device if practicable.

- (d) Change power supply range from 85% to 115% of the rated supply voltage

- (e) Rotated EUT through three orthogonal axes to determine the attitude of EUT arrangement produces highest emissions.

Spectrum frequency from 9 kHz to 25 GHz (tenth harmonic of fundamental frequency) was investigated, and no any obvious emission were detected from 18 GHz to 25 GHz, so below final test was performed with frequency range from 9 kHz to 18 GHz.

- (4) For final emissions measurements at each frequency of interest, the EUT was rotated and the antenna height was varied between 1 m and 4 m in order to maximize the emission. Measurements in both horizontal and vertical polarities were made and the data was recorded. In order to find the maximum emission, the relative positions of equipment and all of the interface cables were changed according to ANSI C63.10:2020 on Radiated Emission test.
- (5) The emissions from 9 kHz to 1 GHz were measured based on CISPR QP detector except for the frequency bands 9 - 90 kHz, 110 - 490 kHz, for emissions from 9 kHz - 90 kHz, 110 kHz - 490 kHz and above 1 GHz were measured based on average detector, for emissions above 1 GHz, peak emissions also be measured and need comply with Peak limit.
- (6) The emissions from 9 kHz to 1 GHz, QP or average values were measured with EMI receiver with below RBW.

Frequency band	RBW
9 kHz - 150 kHz	200 Hz
150 kHz - 30 MHz	9 kHz
30 MHz - 1 GHz	120 kHz

- (7) For emissions above 1GHz, both Peak and Average level were measured with Spectrum Analyzer, and the RBW is set at 1 MHz, VBW is set at 3 MHz for Peak measure; According ANSI C63.10:2020 clause 4.1.4.2.2 procedure for average measure.
- (8) X axis, Y axis, Z axis are tested, and worse setup X axis is reported.

8.4. Test result

Pass. (See below detailed test result)

All the emissions except fundamental emission from 9 kHz to 25 GHz were comply with 15.209 limits.

Note1: According exploratory test, the emission levels are 20 dB below the limit detected from 9 kHz to 30 MHz and 18 GHz to 25 GHz, so the final test was performed with frequency range from 30 MHz to 18 GHz and recorded in below.

Note2: For emissions below 1 GHz, according exploratory explorer test, when change Tx mode and channel, have no distinct influence on emissions level, so for emissions below 1 GHz, the final test was only performed with EUT working in BLE transmitting mode.

Note3: For emissions above 1 GHz. If peak results comply with AV limit, AV Result is deemed to comply with AV limit.

Radiated Emission test (below 1 GHz)

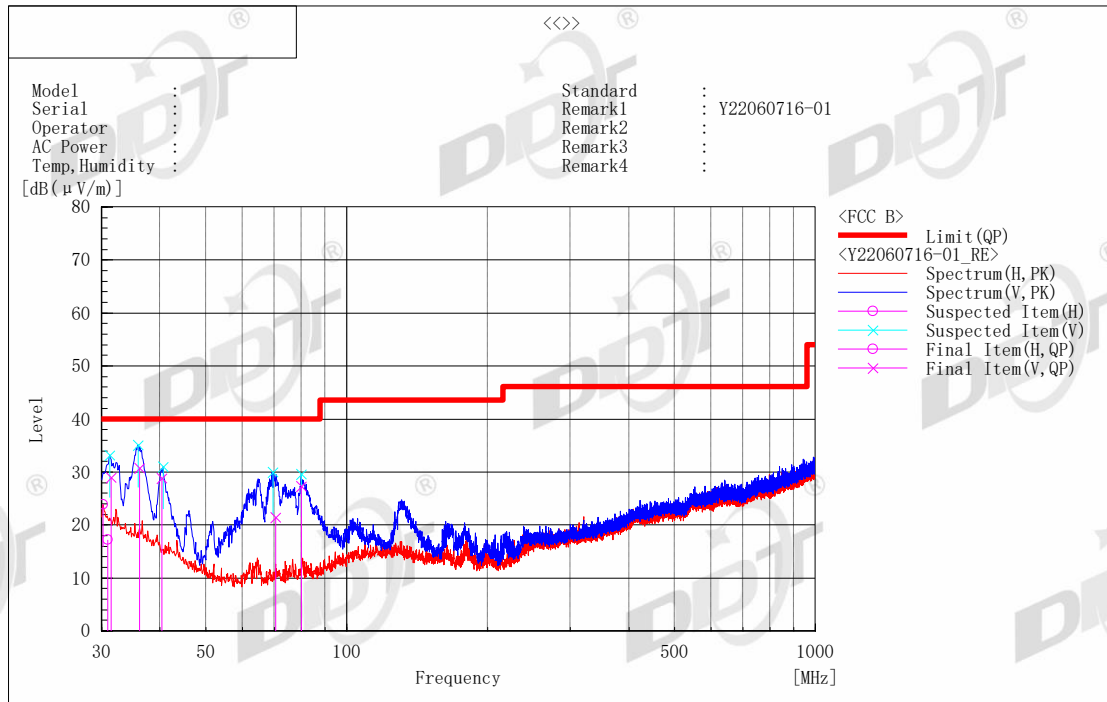

Final Result

No.	Frequency [MHz]	(P)	Reading [dB (µV)]	c. f	Result QP [dB (µV/m)]	Limit QP [dB (µV/m)]	Margin [dB]	Height [cm]	Angle [°]	System	Remark
1	31.413	V	33.6	-4.6	29.0	40.0	11.0	104.0	155.6	2	
2	36.153	V	38.1	-7.3	30.8	40.0	9.2	130.0	85.7	2	
3	40.287	V	38.3	-9.5	28.8	40.0	11.2	118.0	74.5	2	
4	70.578	V	37.2	-15.8	21.4	40.0	18.6	124.0	11.0	2	
5	80.005	V	42.3	-15.0	27.3	40.0	12.7	110.0	151.6	2	
6	30.874	H	22.4	-5.2	17.2	40.0	22.8	306.0	301.4	1	

Note) Receiving antenna polarization: Horizontal and/or Vertical

Test Distance: 3 m, Antenna Height: 1 m to 4 m

Level QP (Quasi-Peak) = Reading QP + Factor (Antenna Factor + Cable Loss - Amp. Gain)

Margin QP (Quasi-Peak) = Limit - Level QP

Radiated Emission test (1 GHz – 3GHz) Radiated Emission Test Result

Test Site : 10m Chamber
Test Date : 08-25-2022 **Tested By** : Sunny
EUT : WYZE BULB COLOR BR30 **Model Number** : WLPBR30C
Power Supply : AC 120V/60Hz **Test Mode** : Tx Mode
Memo : BLE 2402MHz

Data: 123

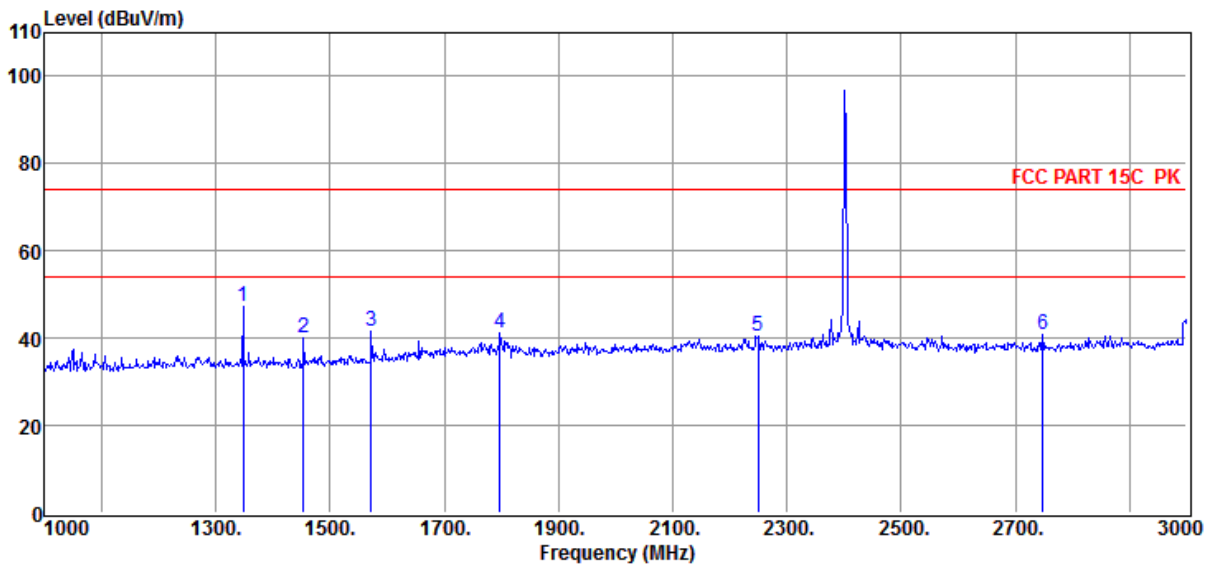

Item (Mark)	Freq. (MHz)	Read Level (dBμV)	Antenna Factor (dB/m)	Cable Loss (dB)	Result Level (dBμV/m)	Limit Line (dBμV/m)	Over Limit (dB)	Detector	Polarization
1	1348.00	57.20	24.89	-34.86	47.23	74.00	-26.77	Peak	HORIZONTAL
2	1454.00	49.52	25.32	-34.61	40.23	74.00	-33.77	Peak	HORIZONTAL
3	1572.00	50.24	25.95	-34.58	41.61	74.00	-32.39	Peak	HORIZONTAL
4	1798.00	48.16	27.35	-34.40	41.11	74.00	-32.89	Peak	HORIZONTAL
5	2250.00	46.60	28.25	-34.22	40.63	74.00	-33.37	Peak	HORIZONTAL
6	2748.00	45.82	28.54	-33.46	40.90	74.00	-33.10	Peak	HORIZONTAL

- Note: 1. Result Level = Read Level + Antenna Factor + Cable loss.
 2. If Peak Result complies with AV limit, AV Result is deemed to comply with AV limit.
 3. Test setup: RBW: 1 MHz, VBW: 3 MHz, Sweep time: auto.
 4. Margin = Result Level - Limit.

Radiated Emission Test Result

Test Site : 10m Chamber

Test Date : 08-25-2022

Tested By : Sunny

EUT : WYZE BULB COLOR BR30

Model Number : WLPBR30C

Power Supply : AC 120V/60Hz

Test Mode : Tx Mode

Memo : BLE 2402MHz

Data: 124

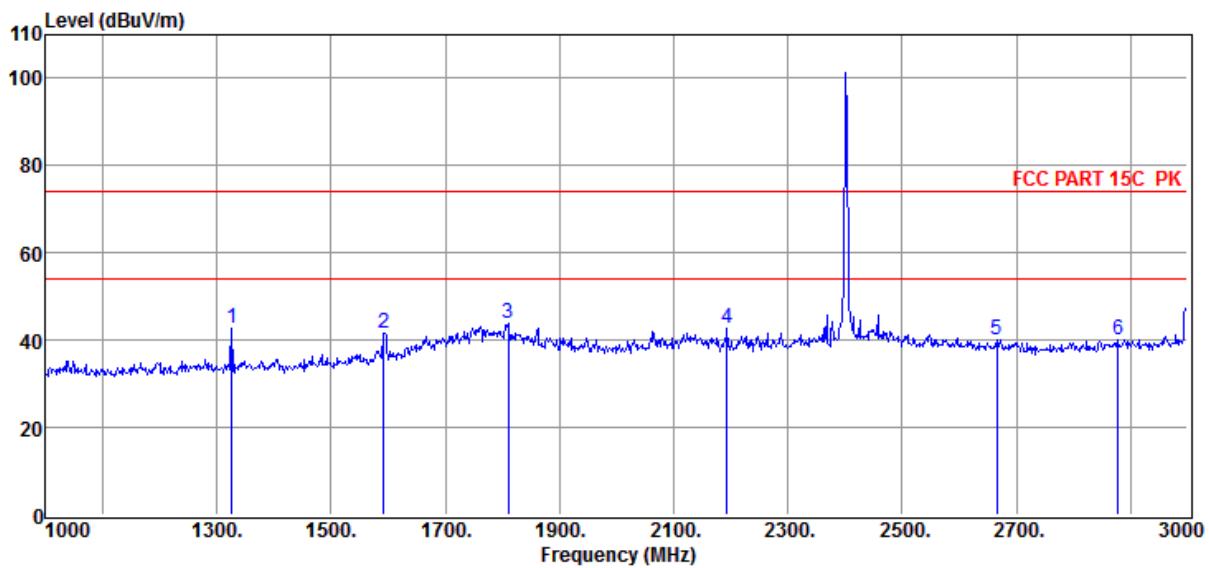

Item (Mark)	Freq. (MHz)	Read Level (dB μ V)	Antenna Factor (dB/m)	Cable Loss dB	Result Level (dB μ V/m)	Limit Line (dB μ V/m)	Over Limit (dB)	Detector	Polarization
1	1326.00	53.02	24.80	-34.94	42.88	74.00	-31.12	Peak	VERTICAL
2	1592.00	49.95	26.07	-34.57	41.45	74.00	-32.55	Peak	VERTICAL
3	1810.00	50.65	27.42	-34.35	43.72	74.00	-30.28	Peak	VERTICAL
4	2194.00	48.70	28.33	-34.14	42.89	74.00	-31.11	Peak	VERTICAL
5	2666.00	45.13	28.33	-33.28	40.18	74.00	-33.82	Peak	VERTICAL
6	2878.00	44.51	28.88	-33.35	40.04	74.00	-33.96	Peak	VERTICAL

Note: 1. Result Level = Read Level + Antenna Factor + Cable loss.

2. If Peak Result complies with AV limit, AV Result is deemed to comply with AV limit.

3. Test setup: RBW: 1 MHz, VBW: 3 MHz, Sweep time: auto.

4. Margin = Result Level - Limit.

Radiated Emission Test Result

Test Site : 10m Chamber

Test Date : 08-25-2022

Tested By : Sunny

EUT : WYZE BULB COLOR BR30

Model Number : WLPBR30C

Power Supply : AC 120V/60Hz

Test Mode : Tx Mode

Memo : BLE 2440MHz

Data: 125

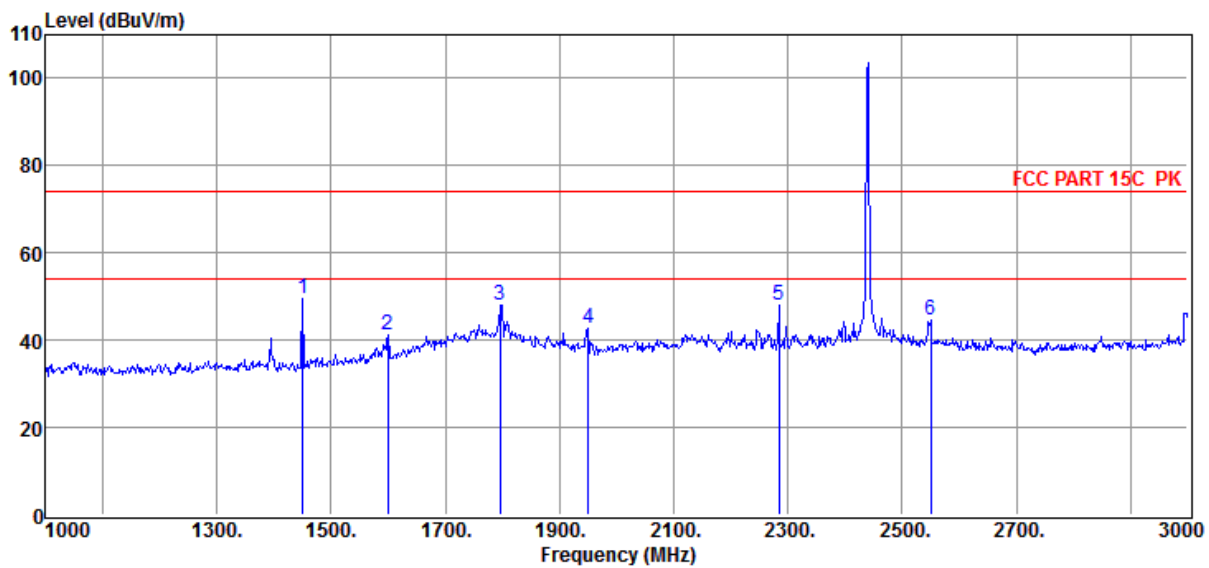

Item (Mark)	Freq. (MHz)	Read Level (dB μ V)	Antenna Factor (dB/m)	Cable Loss dB	Result Level (dB μ V/m)	Limit Line (dB μ V/m)	Over Limit (dB)	Detector	Polarization
1	1450.00	58.79	25.30	-34.63	49.46	74.00	-24.54	Peak	VERTICAL
2	1600.00	49.68	26.12	-34.59	41.21	74.00	-32.79	Peak	VERTICAL
3	1796.00	55.21	27.34	-34.42	48.13	74.00	-25.87	Peak	VERTICAL
4	1950.00	48.70	28.29	-34.28	42.71	74.00	-31.29	Peak	VERTICAL
5	2284.00	53.83	28.20	-34.16	47.87	74.00	-26.13	Peak	VERTICAL
6	2550.00	50.21	28.03	-33.54	44.70	74.00	-29.30	Peak	VERTICAL

Note: 1. Result Level = Read Level + Antenna Factor + Cable loss.

2. If Peak Result complies with AV limit, AV Result is deemed to comply with AV limit.

3. Test setup: RBW: 1 MHz, VBW: 3 MHz, Sweep time: auto.

4. Margin = Result Level - Limit.

Radiated Emission Test Result

Test Site : 10m Chamber

Test Date : 08-25-2022

Tested By : Sunny

EUT : WYZE BULB COLOR BR30

Model Number : WLPBR30C

Power Supply : AC 120V/60Hz

Test Mode : Tx Mode

Memo : BLE 2440MHz

Data: 126

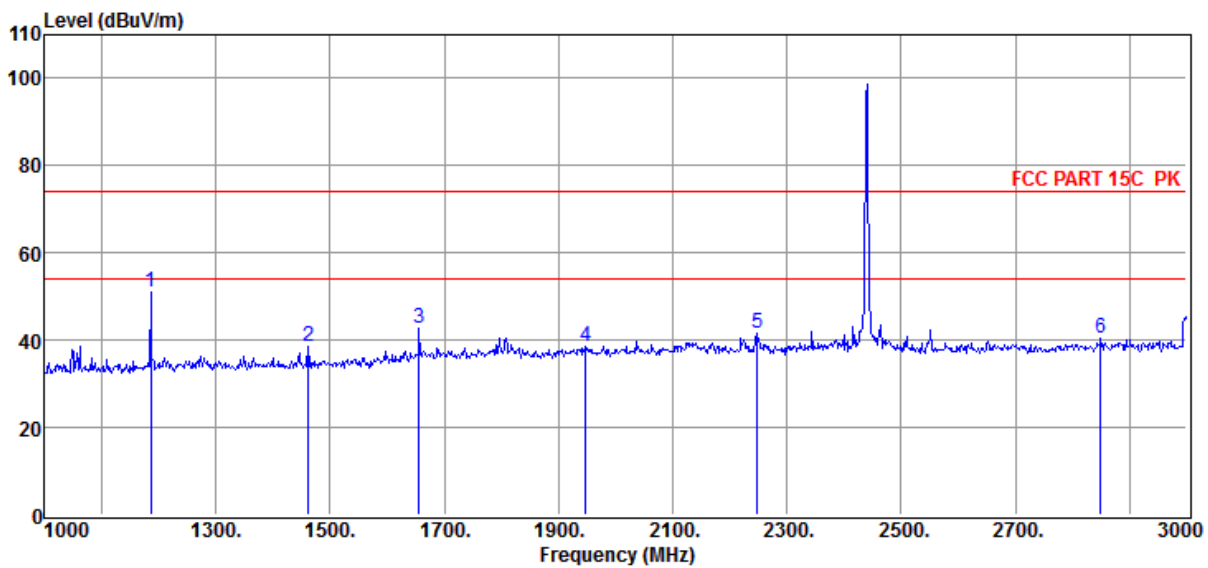

Item (Mark)	Freq. (MHz)	Read Level (dB μ V)	Antenna Factor (dB/m)	Cable Loss dB	Result Level (dB μ V/m)	Limit Line (dB μ V/m)	Over Limit (dB)	Detector	Polarization
1	1186.00	61.82	24.24	-35.12	50.94	74.00	-23.06	Peak	HORIZONTAL
2	1462.00	47.92	25.35	-34.59	38.68	74.00	-35.32	Peak	HORIZONTAL
3	1656.00	50.63	26.47	-34.56	42.54	74.00	-31.46	Peak	HORIZONTAL
4	1948.00	44.68	28.28	-34.29	38.67	74.00	-35.33	Peak	HORIZONTAL
5	2248.00	47.56	28.25	-34.22	41.59	74.00	-32.41	Peak	HORIZONTAL
6	2850.00	45.08	28.81	-33.45	40.44	74.00	-33.56	Peak	HORIZONTAL

Note: 1. Result Level = Read Level + Antenna Factor + Cable loss.

2. If Peak Result complies with AV limit, AV Result is deemed to comply with AV limit.

3. Test setup: RBW: 1 MHz, VBW: 3 MHz, Sweep time: auto.

4. Margin = Result Level - Limit.

Radiated Emission Test Result

Test Site : 10m Chamber

Test Date : 08-26-2022

Tested By : Sunny

EUT : WYZE BULB COLOR BR30

Model Number : WLPBR30C

Power Supply : AC 120V/60Hz

Test Mode : Tx Mode

Memo : BLE 2480MHz

Data: 127

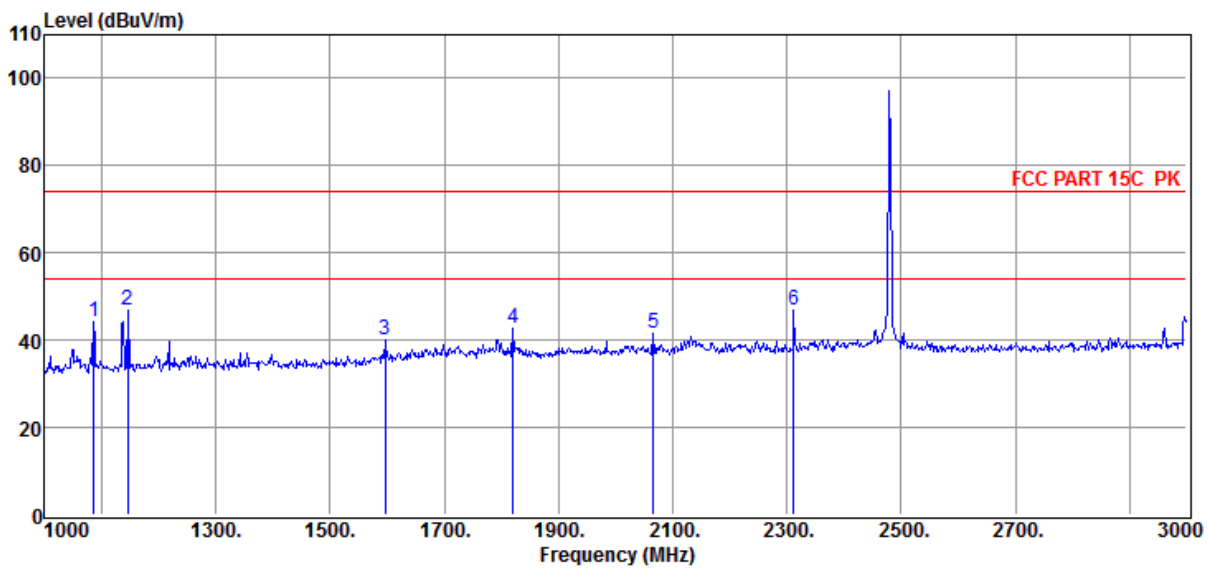

Item (Mark)	Freq. (MHz)	Read Level (dBuV)	Antenna Factor (dB/m)	Cable Loss dB	Result Level (dBuV/m)	Limit Line (dBuV/m)	Over Limit (dB)	Detector	Polarization
1	1086.00	55.61	23.84	-35.24	44.21	74.00	-29.79	Peak	HORIZONTAL
2	1146.00	57.74	24.08	-35.06	46.76	74.00	-27.24	Peak	HORIZONTAL
3	1596.00	48.48	26.10	-34.58	40.00	74.00	-34.00	Peak	HORIZONTAL
4	1820.00	49.37	27.48	-34.30	42.55	74.00	-31.45	Peak	HORIZONTAL
5	2066.00	47.46	28.51	-34.39	41.58	74.00	-32.42	Peak	HORIZONTAL
6	2312.00	52.89	28.16	-34.08	46.97	74.00	-27.03	Peak	HORIZONTAL

Note: 1. Result Level = Read Level + Antenna Factor + Cable loss.

2. If Peak Result complies with AV limit, AV Result is deemed to comply with AV limit.

3. Test setup: RBW: 1 MHz, VBW: 3 MHz, Sweep time: auto.

4. Margin = Result Level - Limit.

Radiated Emission Test Result

Test Site : 10m Chamber

Test Date : 08-26-2022

Tested By : Sunny

EUT : WYZE BULB COLOR BR30

Model Number : WLPBR30C

Power Supply : AC 120V/60Hz

Test Mode : Tx Mode

Memo : BLE 2480MHz

Data: 128

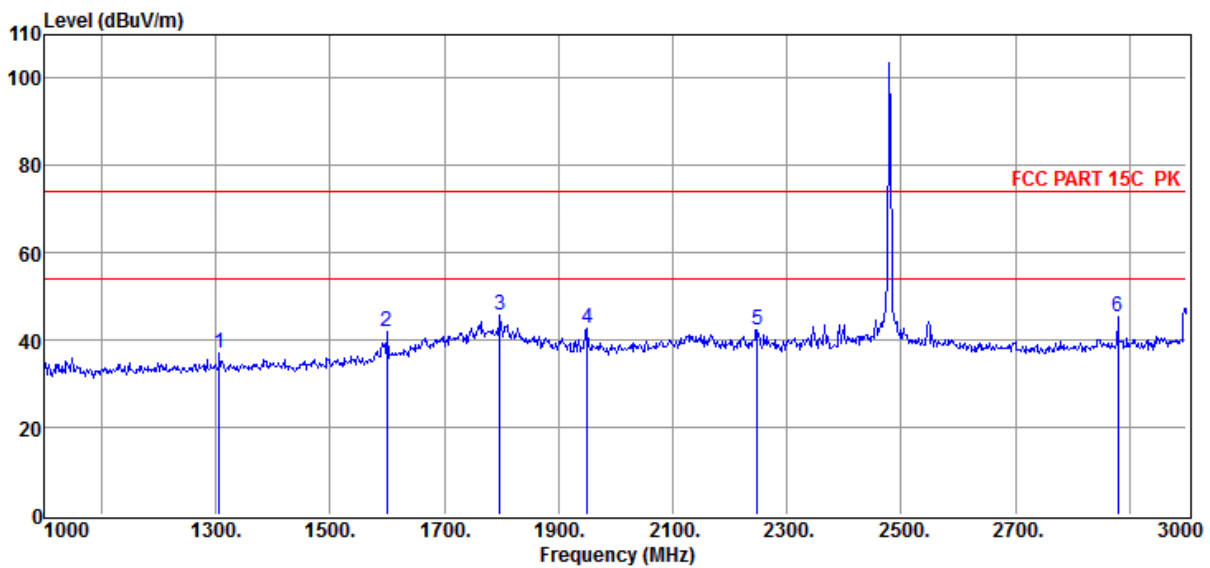

Item (Mark)	Freq. (MHz)	Read Level (dBuV)	Antenna Factor (dB/m)	Cable Loss (dB)	Result Level (dBuV/m)	Limit Line (dBuV/m)	Over Limit (dB)	Detector	Polarization
1	1306.00	47.21	24.72	-34.88	37.05	74.00	-36.95	Peak	VERTICAL
2	1600.00	50.61	26.12	-34.59	42.14	74.00	-31.86	Peak	VERTICAL
3	1798.00	52.76	27.35	-34.40	45.71	74.00	-28.29	Peak	VERTICAL
4	1950.00	48.56	28.29	-34.28	42.57	74.00	-31.43	Peak	VERTICAL
5	2248.00	48.45	28.25	-34.22	42.48	74.00	-31.52	Peak	VERTICAL
6	2880.00	49.77	28.89	-33.35	45.31	74.00	-28.69	Peak	VERTICAL

Note: 1. Result Level = Read Level + Antenna Factor + Cable loss.

2. If Peak Result complies with AV limit, AV Result is deemed to comply with AV limit.

3. Test setup: RBW: 1 MHz, VBW: 3 MHz, Sweep time: auto.

4. Margin = Result Level - Limit.

Radiated Emission test (3 GHz – 18GHz) Radiated Emission Test Result

Test Site : 10m Chamber
Test Date : 08-25-2022 **Tested By** : Sunny
EUT : WYZE BULB COLOR BR30 **Model Number** : WLPBR30C
Power Supply : AC 120V/60Hz **Test Mode** : Tx Mode
Memo : BLE 2402MHz

Data: 131

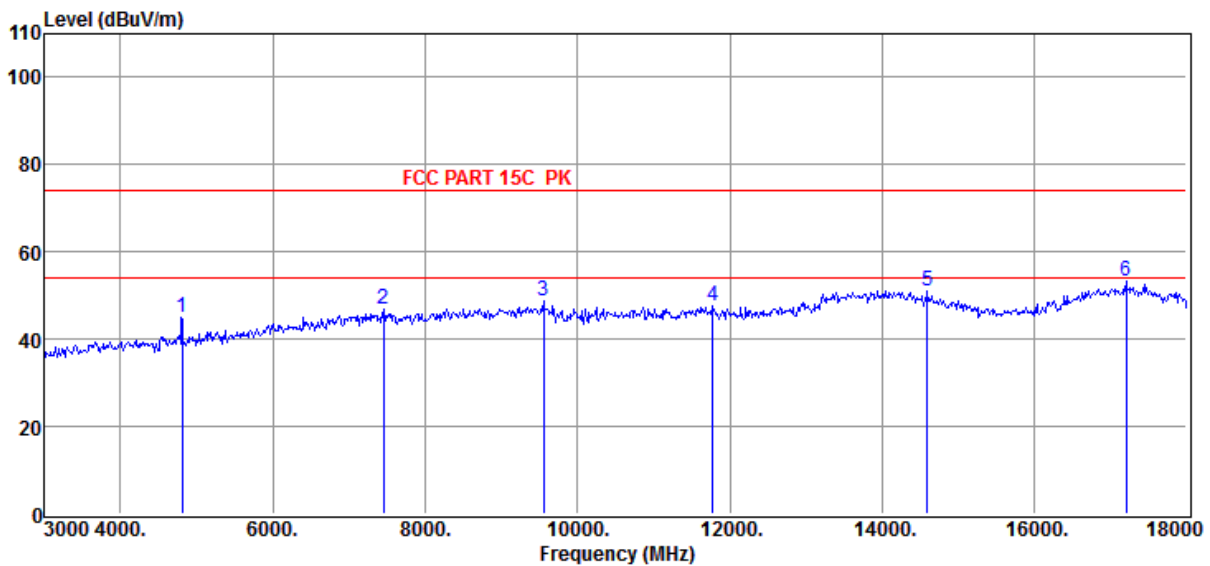

Item (Mark)	Freq. (MHz)	Read Level (dB μ V)	Antenna Factor (dB/m)	Cable Loss (dB)	Result Level (dB μ V/m)	Limit Line (dB μ V/m)	Over Limit (dB)	Detector	Polarization
1	4804.00	44.34	32.51	-31.73	45.12	74.00	-28.88	Peak	HORIZONTAL
2	7455.00	40.41	37.33	-30.82	46.92	74.00	-27.08	Peak	HORIZONTAL
3	9555.00	40.99	38.03	-30.08	48.94	74.00	-25.06	Peak	HORIZONTAL
4	11775.00	37.46	38.65	-28.62	47.49	74.00	-26.51	Peak	HORIZONTAL
5	14595.00	37.64	40.38	-26.84	51.18	74.00	-22.82	Peak	HORIZONTAL
6	17205.00	37.63	42.49	-26.92	53.20	74.00	-20.80	Peak	HORIZONTAL

- Note: 1. Result Level = Read Level + Antenna Factor + Cable loss.
 2. If Peak Result complies with AV limit, AV Result is deemed to comply with AV limit.
 3. Test setup: RBW: 1 MHz, VBW: 3 MHz, Sweep time: auto.
 4. Margin = Result Level - Limit.

Radiated Emission Test Result

Test Site : 10m Chamber

Test Date : 08-25-2022

Tested By : Sunny

EUT : WYZE BULB COLOR BR30

Model Number : WLPBR30C

Power Supply : AC 120V/60Hz

Test Mode : Tx Mode

Memo : BLE 2402MHz

Data: 132

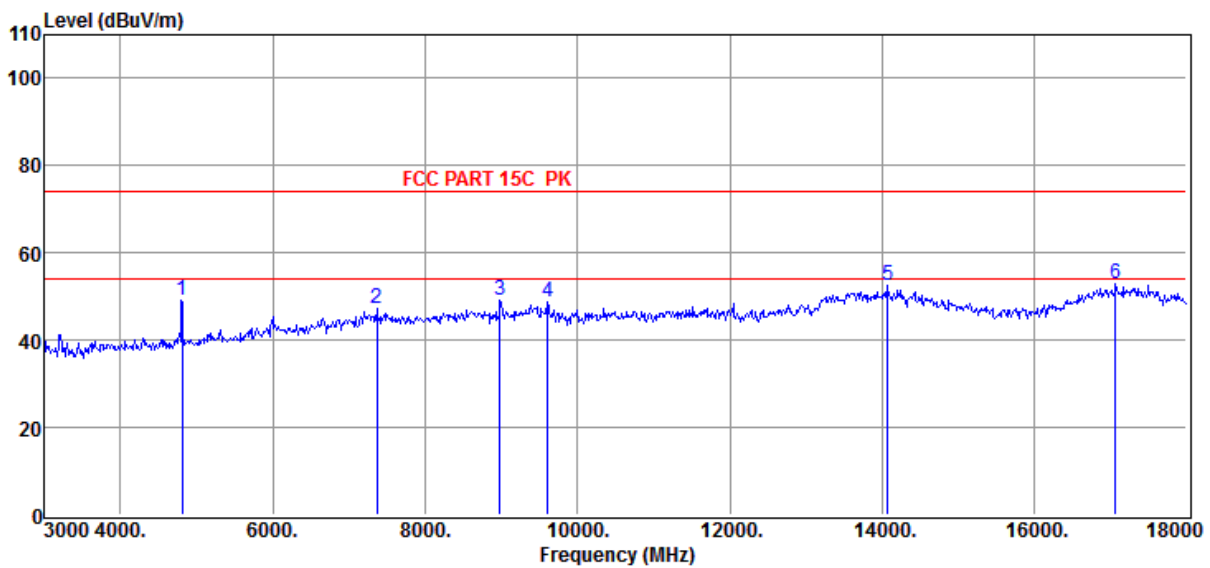

Item (Mark)	Freq. (MHz)	Read Level (dBμV)	Antenna Factor (dB/m)	Cable Loss dB	Result Level (dBμV/m)	Limit Line (dBμV/m)	Over Limit (dB)	Detector	Polarization
1	4804.00	48.35	32.51	-31.73	49.13	74.00	-24.87	Peak	VERTICAL
2	7365.00	40.86	37.18	-30.75	47.29	74.00	-26.71	Peak	VERTICAL
3	8985.00	42.01	37.69	-30.62	49.08	74.00	-24.92	Peak	VERTICAL
4	9608.00	40.58	38.06	-29.98	48.66	74.00	-25.34	Peak	VERTICAL
5	14070.00	39.45	41.30	-28.25	52.50	74.00	-21.50	Peak	VERTICAL
6	17070.00	37.03	42.30	-26.51	52.82	74.00	-21.18	Peak	VERTICAL

Note: 1. Result Level = Read Level + Antenna Factor + Cable loss.

2. If Peak Result complies with AV limit, AV Result is deemed to comply with AV limit.

3. Test setup: RBW: 1 MHz, VBW: 3 MHz, Sweep time: auto.

4. Margin = Result Level - Limit.

Radiated Emission Test Result

Test Site : 10m Chamber

Test Date : 08-25-2022

Tested By : Sunny

EUT : WYZE BULB COLOR BR30

Model Number : WLPBR30C

Power Supply : AC 120V/60Hz

Test Mode : Tx Mode

Memo : BLE 2440MHz

Data: 133

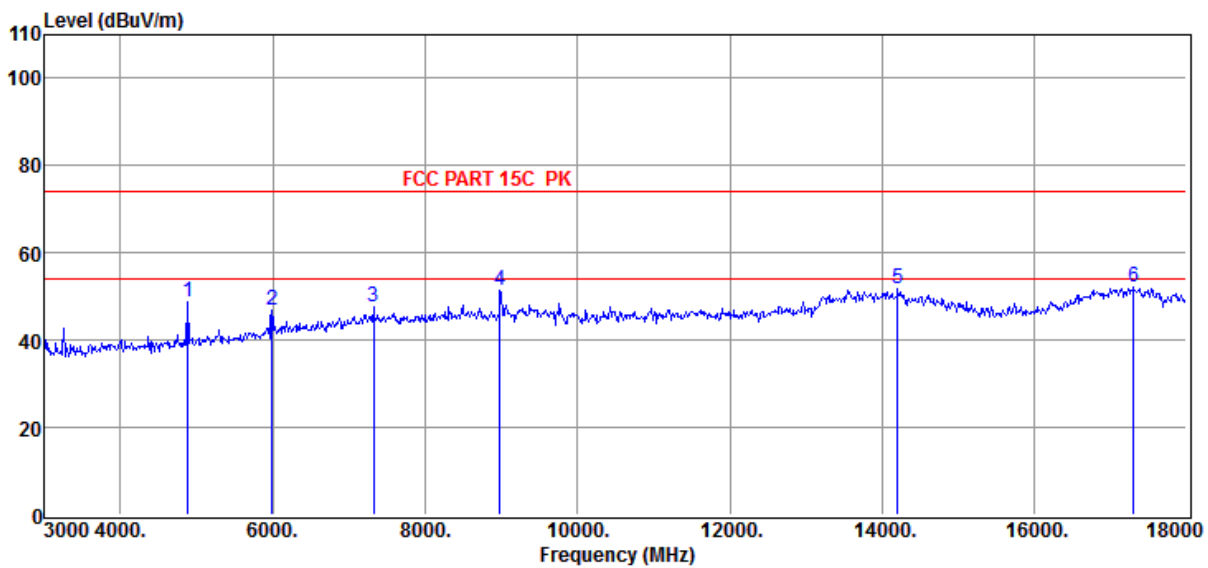

Item (Mark)	Freq. (MHz)	Read Level (dBuV)	Antenna Factor (dB/m)	Cable Loss dB	Result Level (dBuV/m)	Limit Line (dBuV/m)	Over Limit (dB)	Detector	Polarization
1	4880.00	48.01	32.66	-31.74	48.93	74.00	-25.07	Peak	VERTICAL
2	5985.00	43.65	35.26	-31.86	47.05	74.00	-26.95	Peak	VERTICAL
3	7320.00	41.23	37.11	-30.72	47.62	74.00	-26.38	Peak	VERTICAL
4	8985.00	44.39	37.69	-30.62	51.46	74.00	-22.54	Peak	VERTICAL
5	14205.00	37.87	41.11	-27.10	51.88	74.00	-22.12	Peak	VERTICAL
6	17310.00	36.51	42.63	-26.83	52.31	74.00	-21.69	Peak	VERTICAL

Note: 1. Result Level = Read Level + Antenna Factor + Cable loss.

2. If Peak Result complies with AV limit, AV Result is deemed to comply with AV limit.

3. Test setup: RBW: 1 MHz, VBW: 3 MHz, Sweep time: auto.

4. Margin = Result Level - Limit.

Radiated Emission Test Result

Test Site : 10m Chamber

Test Date : 08-25-2022

Tested By : Sunny

EUT : WYZE BULB COLOR BR30

Model Number : WLPBR30C

Power Supply : AC 120V/60Hz

Test Mode : Tx Mode

Memo : BLE 2440MHz

Data: 134

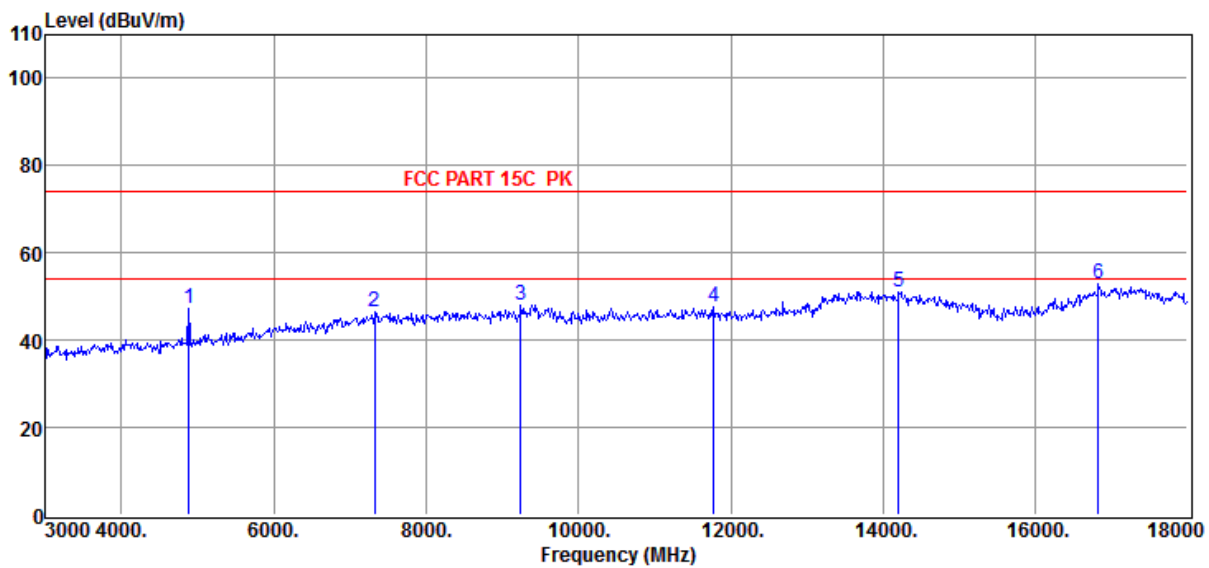

Item (Mark)	Freq. (MHz)	Read Level (dBμV)	Antenna Factor (dB/m)	Cable Loss dB	Result Level (dBμV/m)	Limit Line (dBμV/m)	Over Limit (dB)	Detector	Polarization
1	4880.00	46.37	32.66	-31.74	47.29	74.00	-26.71	Peak	HORIZONTAL
2	7320.00	40.09	37.11	-30.72	46.48	74.00	-27.52	Peak	HORIZONTAL
3	9240.00	40.67	37.84	-30.41	48.10	74.00	-25.90	Peak	HORIZONTAL
4	11775.00	37.43	38.65	-28.62	47.46	74.00	-26.54	Peak	HORIZONTAL
5	14205.00	37.00	41.11	-27.10	51.01	74.00	-22.99	Peak	HORIZONTAL
6	16830.00	37.56	41.38	-26.11	52.83	74.00	-21.17	Peak	HORIZONTAL

Note: 1. Result Level = Read Level + Antenna Factor + Cable loss.

2. If Peak Result complies with AV limit, AV Result is deemed to comply with AV limit.

3. Test setup: RBW: 1 MHz, VBW: 3 MHz, Sweep time: auto.

4. Margin = Result Level - Limit.

Radiated Emission Test Result

Test Site : 10m Chamber

Test Date : 08-25-2022

Tested By : Sunny

EUT : WYZE BULB COLOR BR30

Model Number : WLPBR30C

Power Supply : AC 120V/60Hz

Test Mode : Tx Mode

Memo : BLE 2480MHz

Data: 129

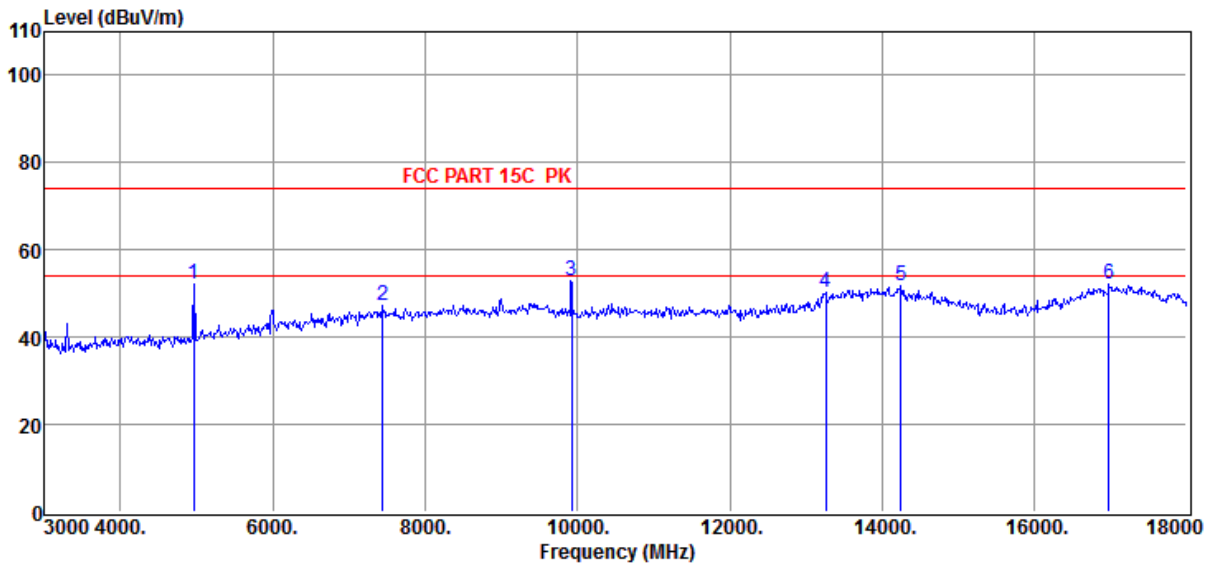

Item (Mark)	Freq. (MHz)	Read Level (dBμV)	Antenna Factor (dB/m)	Cable Loss dB	Result Level (dBμV/m)	Limit Line (dBμV/m)	Over Limit (dB)	Detector	Polarization
1	4960.00	50.86	32.82	-31.63	52.05	74.00	-21.95	Peak	VERTICAL
2	7440.00	41.00	37.30	-30.87	47.43	74.00	-26.57	Peak	VERTICAL
3	9920.00	44.72	38.25	-30.02	52.95	74.00	-21.05	Peak	VERTICAL
4	13260.00	39.47	39.97	-29.31	50.13	74.00	-23.87	Peak	VERTICAL
5	14250.00	38.17	41.05	-27.59	51.63	74.00	-22.37	Peak	VERTICAL
6	16980.00	36.06	42.10	-26.07	52.09	74.00	-21.91	Peak	VERTICAL

Note: 1. Result Level = Read Level + Antenna Factor + Cable loss.

2. If Peak Result complies with AV limit, AV Result is deemed to comply with AV limit.

3. Test setup: RBW: 1 MHz, VBW: 3 MHz, Sweep time: auto.

4. Margin = Result Level - Limit.

Radiated Emission Test Result

Test Site : 10m Chamber

Test Date : 08-25-2022

Tested By : Sunny

EUT : WYZE BULB COLOR BR30

Model Number : WLPBR30C

Power Supply : AC 120V/60Hz

Test Mode : Tx Mode

Memo : BLE 2480MHz

Data: 130

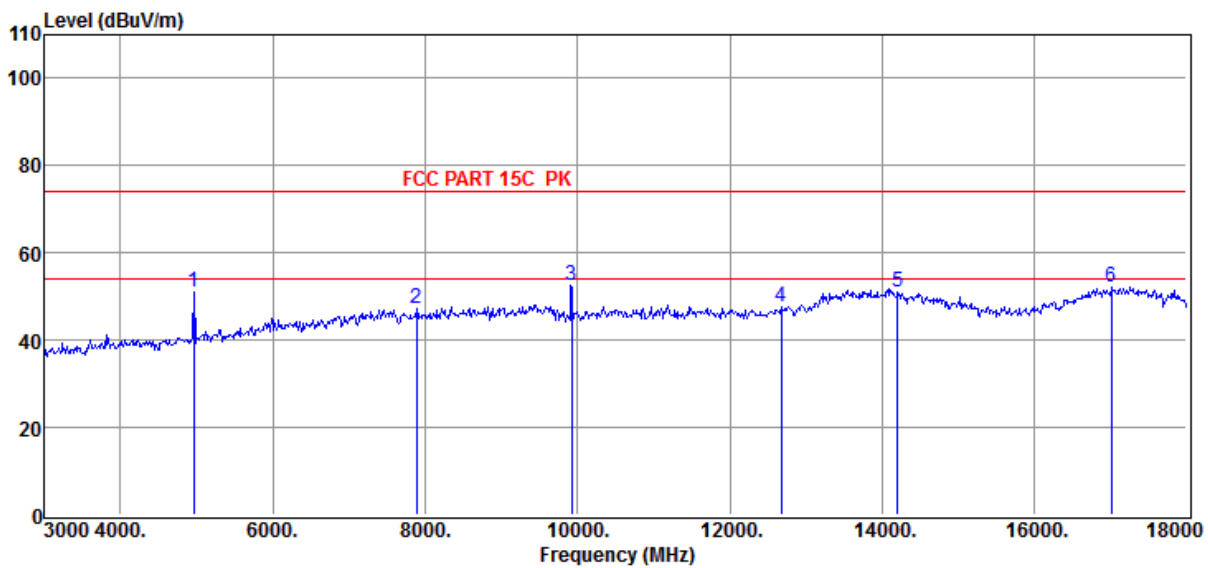

Item (Mark)	Freq. (MHz)	Read Level (dBuV)	Antenna Factor (dB/m)	Cable Loss dB	Result Level (dBuV/m)	Limit Line (dBuV/m)	Over Limit (dB)	Detector	Polarization
1	4965.00	49.92	32.83	-31.65	51.10	74.00	-22.90	Peak	HORIZONTAL
2	7890.00	41.49	37.09	-31.25	47.33	74.00	-26.67	Peak	HORIZONTAL
3	9920.00	44.27	38.25	-30.02	52.50	74.00	-21.50	Peak	HORIZONTAL
4	12675.00	37.85	38.92	-29.05	47.72	74.00	-26.28	Peak	HORIZONTAL
5	14205.00	36.92	41.11	-27.10	50.93	74.00	-23.07	Peak	HORIZONTAL
6	17010.00	35.83	42.21	-25.97	52.07	74.00	-21.93	Peak	HORIZONTAL

Note: 1. Result Level = Read Level + Antenna Factor + Cable loss.

2. If Peak Result complies with AV limit, AV Result is deemed to comply with AV limit.

3. Test setup: RBW: 1 MHz, VBW: 3 MHz, Sweep time: auto.

4. Margin = Result Level - Limit.

9. RF Conducted Spurious Emissions

9.1. Block diagram of test setup

Same as section 4.1

9.2. Limits

In any 100 kHz bandwidth outside the frequency bands in which the spread spectrum intentional radiator is operating, the radio frequency power that is produced by the intentional radiator shall be at least 20 dB below that in the 100 kHz bandwidth within the band that contains the highest level of the desired power.

9.3. Test procedure

(1) Connect EUT's antenna output to spectrum analyzer by RF cable.

(2) Establish a reference level by using the following procedure:

Center frequency	Test frequency
RBW:	100 kHz
VBW:	300 kHz
Span	Wide enough to capture the peak level of the in-band emission
Detector Mode:	Peak
Sweep time:	auto
Trace mode	Max hold

(3) Allow the trace to stabilize, use the peak marker function to determine the maximum peak power level to establish the reference level.

(4) Set the spectrum analyzer as follows:

RBW:	100 kHz
VBW:	300 kHz
Span	Encompass frequency range to be measured
Number of measurement points	$\geq \text{span}/\text{RBW}$
Detector Mode:	Peak
Sweep time:	auto
Trace mode	Max hold

(5) Allow the trace to stabilize, use the peak marker function to determine the maximum amplitude of all unwanted emissions outside of the authorized frequency band

9.4. Test result

Mode	Freq. (MHz)	Verdict
BLE 1M	2402	Pass
	2440	Pass
	2480	Pass

9.5. Original test data

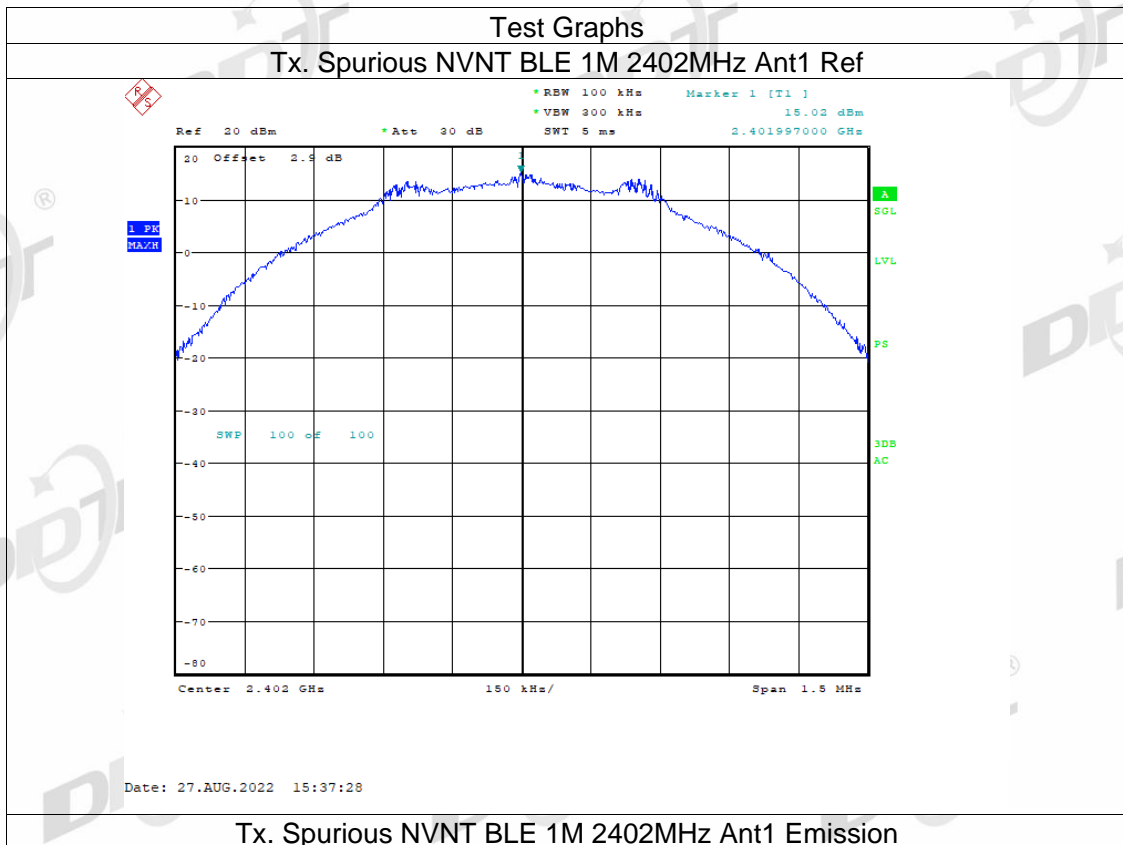

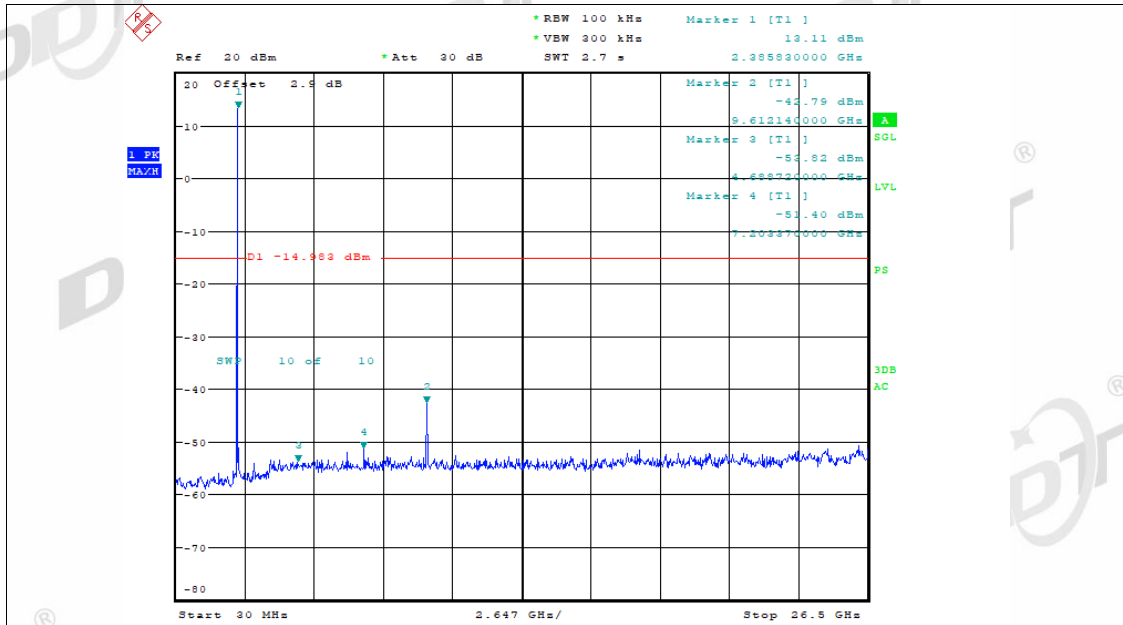

Date: 27.AUG.2022 15:38:01

Tx. Spurious NVNT BLE 1M 2440MHz Ant1 Ref

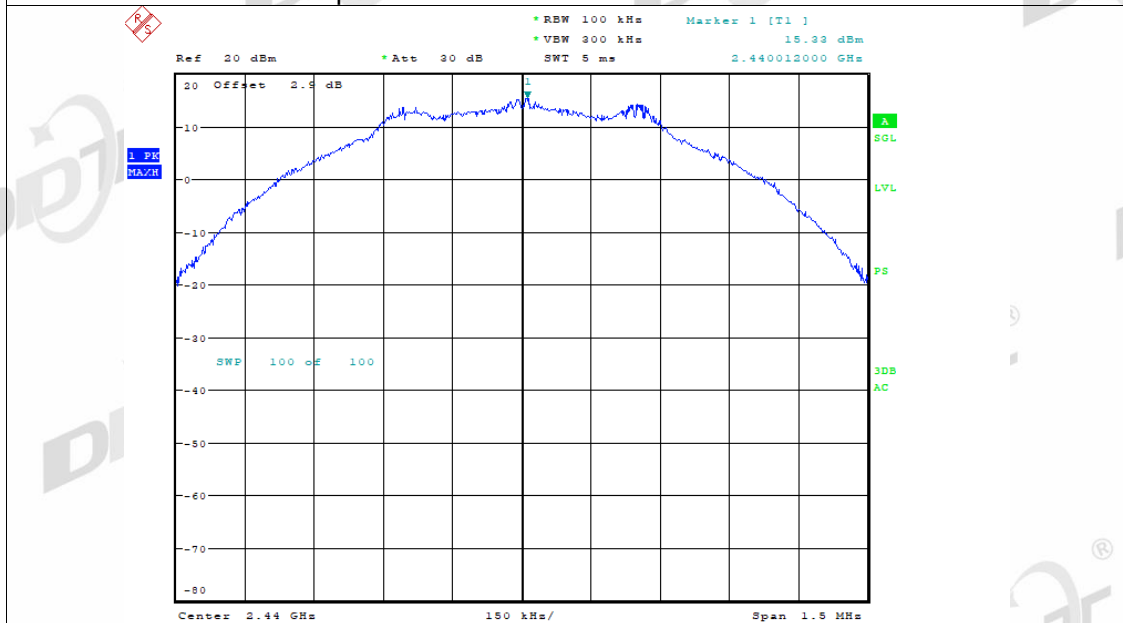

Date: 27.AUG.2022 15:40:10

Tx. Spurious NVNT BLE 1M 2440MHz Ant1 Emission

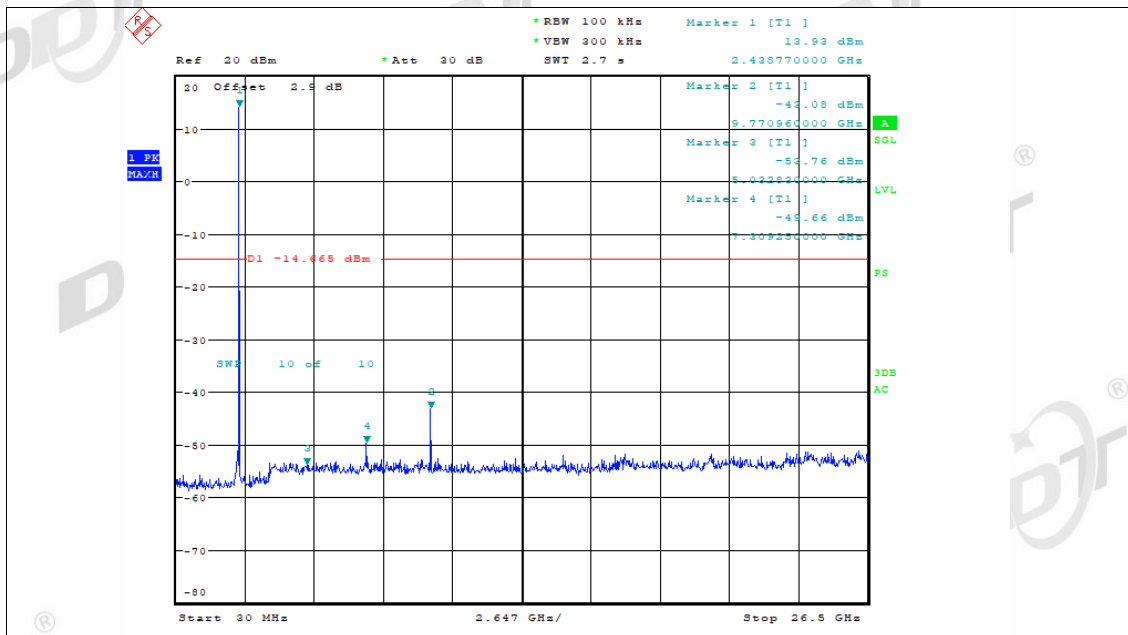

Date: 27.AUG.2022 15:40:43

Tx. Spurious NVNT BLE 1M 2480MHz Ant1 Ref

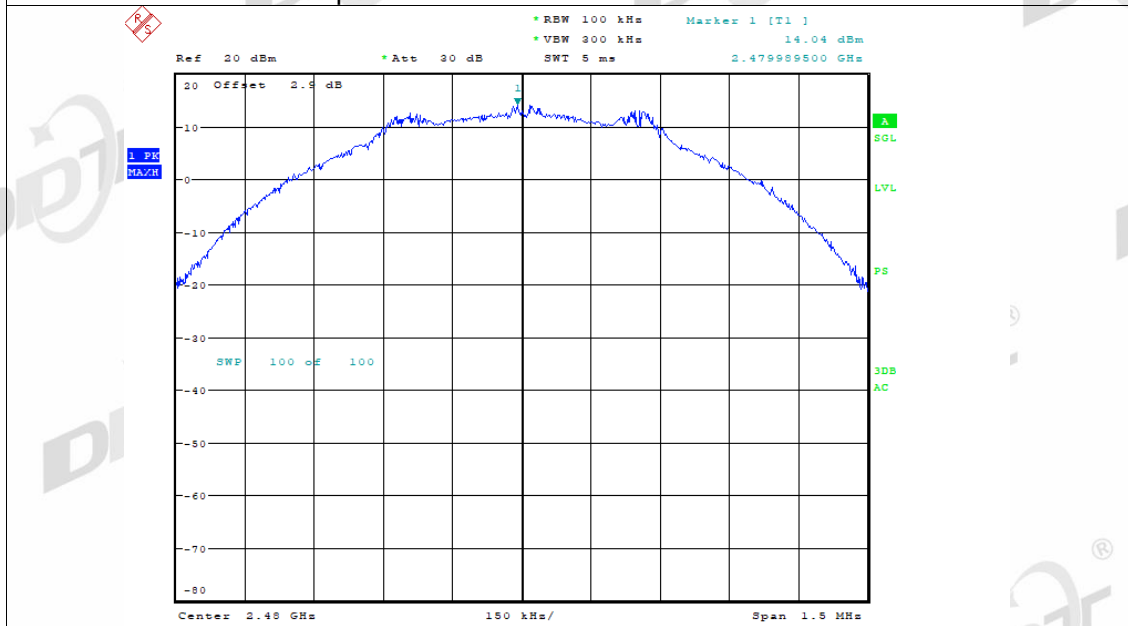

Date: 27.AUG.2022 15:43:31

Tx. Spurious NVNT BLE 1M 2480MHz Ant1 Emission

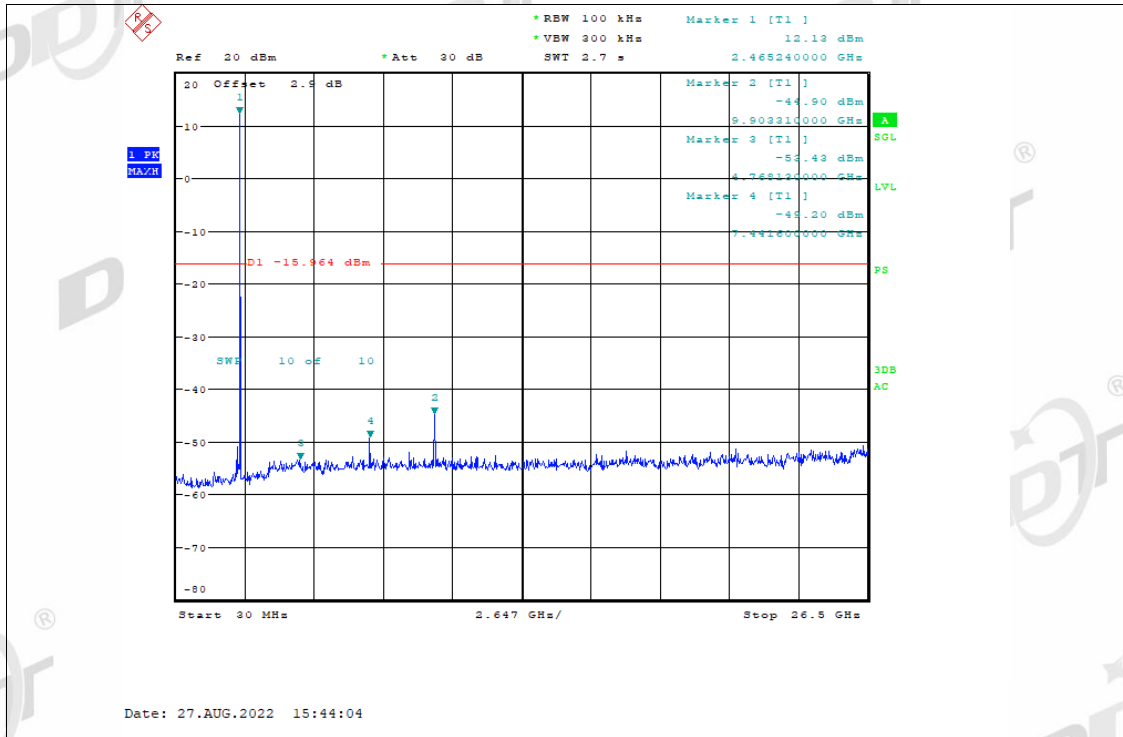

10. Band Edge Compliance (Radiated Method)

10.1. Block diagram of test setup

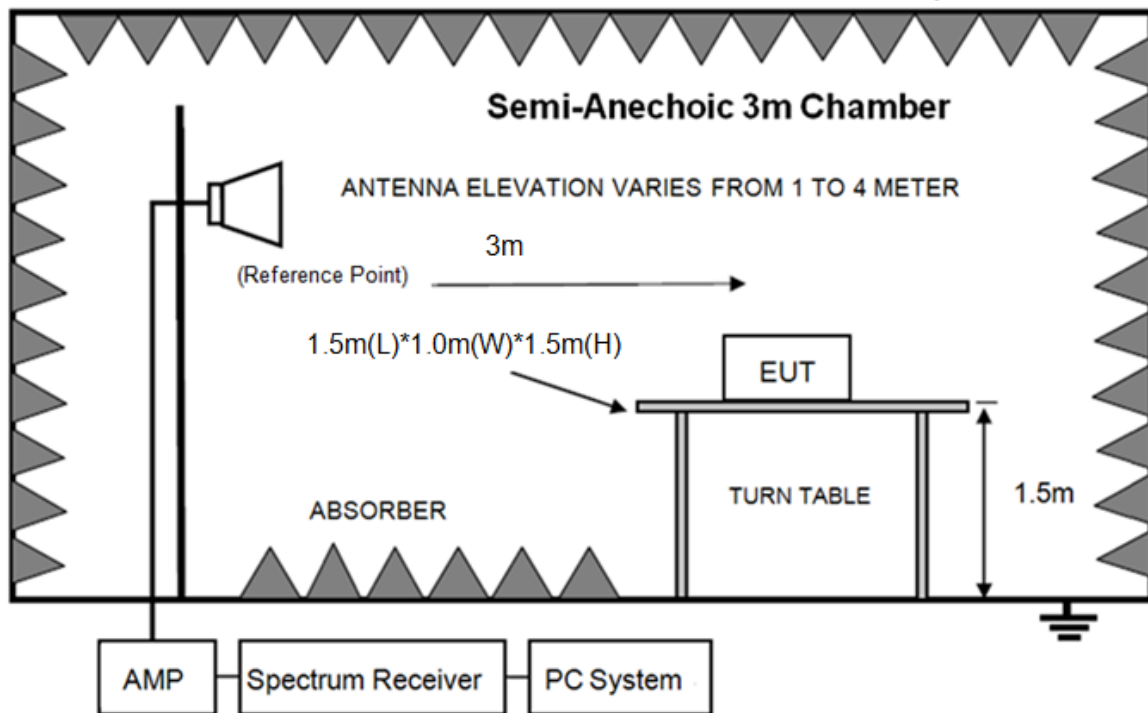

10.2. Limit

All restricted frequency bands shall not exceed the limits shown in 15.209, all the other emissions outside operation frequency band 2400 MHz to 2483.5 MHz shall be at least 20dB below the fundamental emissions or comply with RSS-Gen Issue 3 clause 7.2.5 (Same as FCC 15.209) limits.

10.3. Test Procedure

Same with clause 8.3 except change investigated frequency range.

Remark: All restriction band have been tested, and only the worst case is shown in report.

10.4. Test result

Pass. (See below detailed test result)

Radiated Emission Test Result

Test Site : 10m Chamber

Test Date : 08-25-2022

Tested By : Sunny

EUT : WYZE BULB COLOR BR30

Model Number : WLPBR30C

Power Supply : AC 120V/60Hz

Test Mode : Tx Mode

Memo : BLE 2402MHz

Data: 119

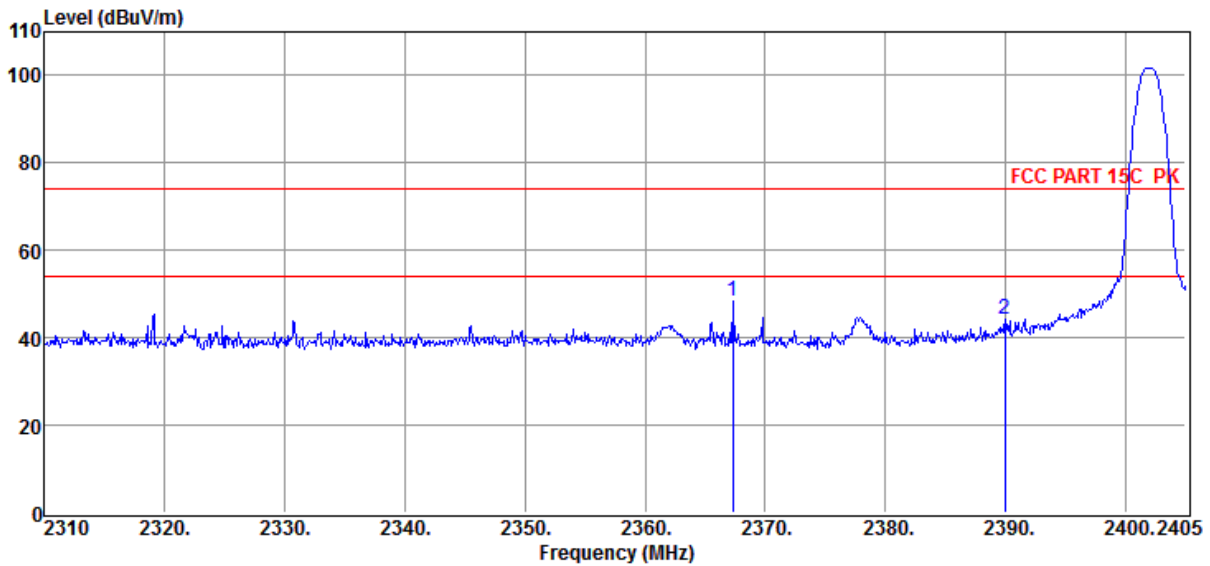

Item (Mark)	Freq. (MHz)	Read Level (dBuV)	Antenna Factor (dB/m)	Cable Loss (dB)	Result Level (dBuV/m)	Limit Line (dBuV/m)	Over Limit (dB)	Detector	Polarization
1	2367.29	54.09	28.09	-33.98	48.20	74.00	-25.80	Peak	VERTICAL
2	2389.99	50.19	28.05	-34.02	44.22	74.00	-29.78	Peak	VERTICAL

Note: 1. Result Level = Read Level + Antenna Factor + Cable loss.

2. If Peak Result complies with AV limit, AV Result is deemed to comply with AV limit.

3. Test setup: RBW: 1 MHz, VBW: 3 MHz, Sweep time: auto.

4. Margin = Result Level - Limit.

Radiated Emission Test Result

Test Site : 10m Chamber

Test Date : 08-25-2022

Tested By : Sunny

EUT : WYZE BULB COLOR BR30

Model Number : WLPBR30C

Power Supply : AC 120V/60Hz

Test Mode : Tx Mode

Memo : BLE 2402MHz

Data: 120

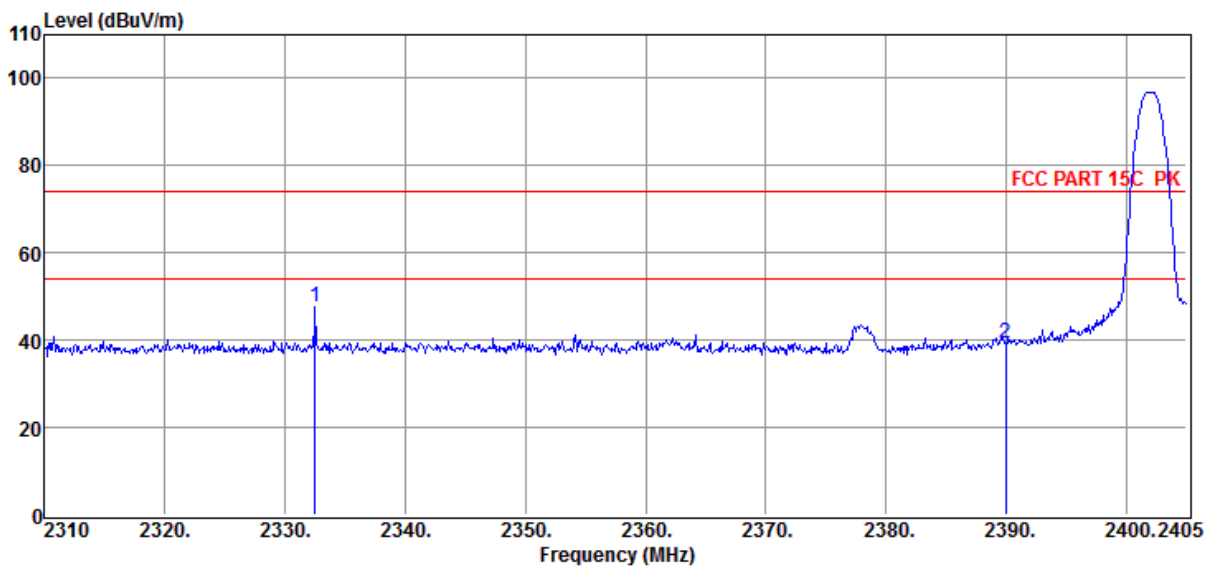

Item (Mark)	Freq. (MHz)	Read Level (dBμV)	Antenna Factor (dB/m)	Cable Loss dB	Result Level (dBμV/m)	Limit Line (dBμV/m)	Over Limit (dB)	Detector	Polarization
1	2332.52	53.49	28.13	-33.99	47.63	74.00	-26.37	Peak	HORIZONTAL
2	2389.99	45.43	28.05	-34.02	39.46	74.00	-34.54	Peak	HORIZONTAL

- Note: 1. Result Level = Read Level + Antenna Factor + Cable loss.
 2. If Peak Result complies with AV limit, AV Result is deemed to comply with AV limit.
 3. Test setup: RBW: 1 MHz, VBW: 3 MHz, Sweep time: auto.
 4. Margin = Result Level - Limit.

Radiated Emission Test Result

Test Site : 10m Chamber

Test Date : 08-25-2022

Tested By : Sunny

EUT : WYZE BULB COLOR BR30

Model Number : WLPBR30C

Power Supply : AC 120V/60Hz

Test Mode : Tx Mode

Memo : BLE 2480MHz

Data: 121

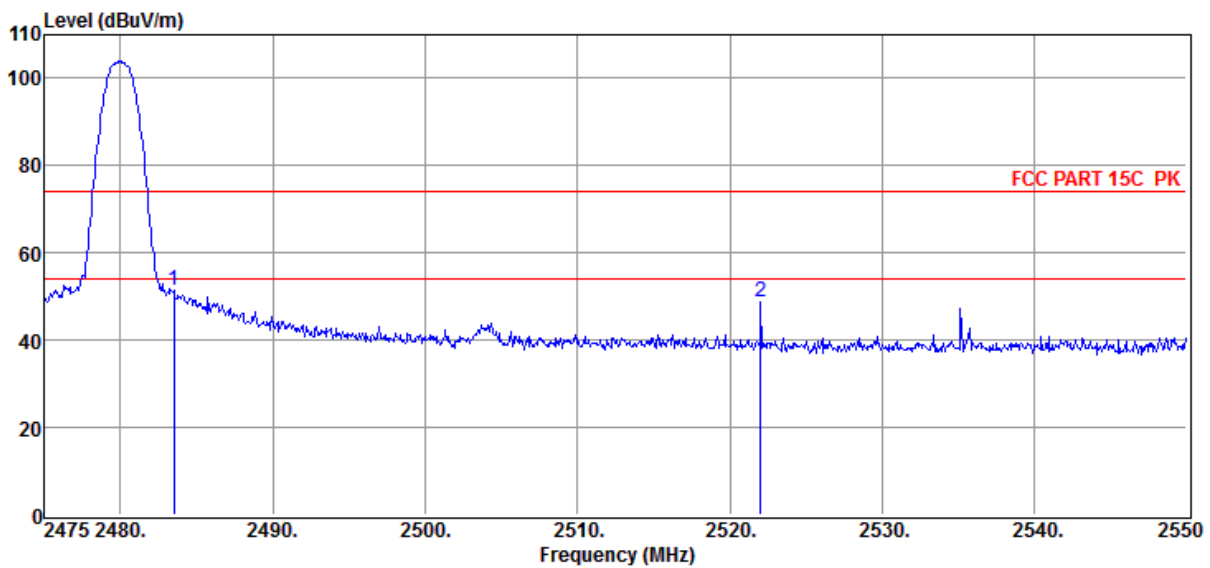

Item (Mark)	Freq. (MHz)	Read Level (dBuV)	Antenna Factor (dB/m)	Cable Loss dB	Result Level (dBuV/m)	Limit Line (dBuV/m)	Over Limit (dB)	Detector	Polarization
1	2483.48	57.21	27.92	-33.79	51.34	74.00	-22.66	Peak	VERTICAL
2	2522.03	54.16	27.96	-33.53	48.59	74.00	-25.41	Peak	VERTICAL

- Note: 1. Result Level = Read Level + Antenna Factor + Cable loss.
 2. If Peak Result complies with AV limit, AV Result is deemed to comply with AV limit.
 3. Test setup: RBW: 1 MHz, VBW: 3 MHz, Sweep time: auto.
 4. Margin = Result Level - Limit.

Radiated Emission Test Result

Test Site : 10m Chamber

Test Date : 08-25-2022

Tested By : Sunny

EUT : WYZE BULB COLOR BR30

Model Number : WLPBR30C

Power Supply : AC 120V/60Hz

Test Mode : Tx Mode

Memo : BLE 2480MHz

Data: 122

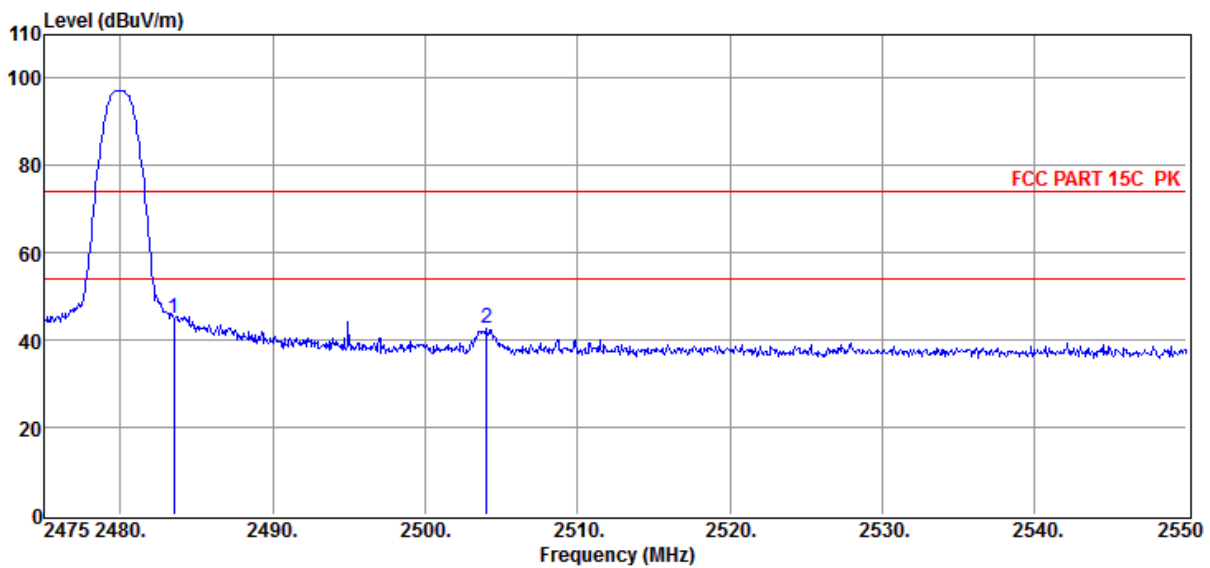

Item (Mark)	Freq. (MHz)	Read Level (dBuV)	Antenna Factor (dB/m)	Cable Loss dB	Result Level (dBuV/m)	Limit Line (dBuV/m)	Over Limit (dB)	Detector	Polarization
1	2483.48	50.90	27.92	-33.79	45.03	74.00	-28.97	Peak	HORIZONTAL
2	2504.03	48.42	27.91	-33.53	42.80	74.00	-31.20	Peak	HORIZONTAL

Note: 1. Result Level = Read Level + Antenna Factor + Cable loss.

2. If Peak Result complies with AV limit, AV Result is deemed to comply with AV limit.

3. Test setup: RBW: 1 MHz, VBW: 3 MHz, Sweep time: auto.

4. Margin = Result Level - Limit.

11. Power Line Conducted Emission

11.1. Block diagram of test setup

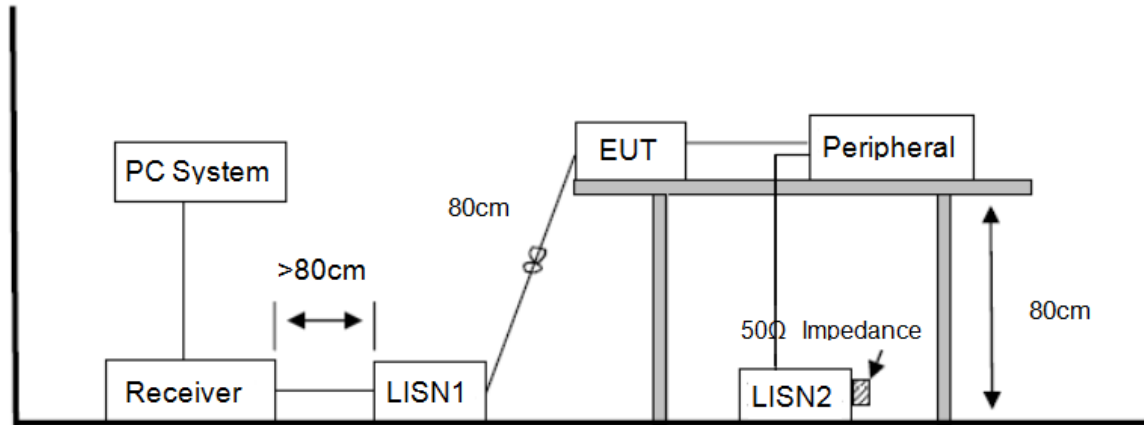

11.2. Power line conducted emission limits

Frequency	Quasi-Peak Level dB(μ V)	Average Level dB(μ V)
150 kHz ~ 500 kHz	66 ~ 56*	56 ~ 46*
500 kHz ~ 5 MHz	56	46
5 MHz ~ 30 MHz	60	50

Note 1: * Decreasing linearly with logarithm of frequency.

Note 2: The lower limit shall apply at the transition frequencies.

11.3. Test procedure

The EUT and Support equipment, if needed, were put placed on a non-metallic table, 80 cm above the ground plane.

Configuration EUT to simulate typical usage as described in clause 2.4 and test equipment as described in clause 3.0 of this report.

All I/O cables were positioned to simulate typical actual usage as per ANSI C63.10.

All support equipment power received from a second LISN.

Emissions were measured on each current carrying line of the EUT using an EMI Test Receiver connected to the LISN powering the EUT.

The Receiver scanned from 150 kHz to 30 MHz for emissions in each of the test modes.

During the above scans, the emissions were maximized by cable manipulation.

The test mode(s) described in clause 2.4 were scanned during the preliminary test.

After the preliminary scan, we found the test mode producing the highest emission level.

The EUT configuration and worse cable configuration of the above highest emission levels were recorded for reference of the final test.

EUT and support equipment were set up on the test bench as per the configuration with highest emission level in the preliminary test.

A scan was taken on both power lines, Neutral and Line, recording at least the six highest emissions.

Emission frequency and amplitude were recorded into a computer in which correction factors were used to calculate the emission level and compare reading to the applicable limit.

The test data of the worst-case condition(s) was recorded.

The bandwidth of test receiver is set at 9 kHz.

11.4. Test result

PASS. (See below detailed test result)

Note1: All emissions not reported below are too low against the prescribed limits.

Conducted Emission Test Result

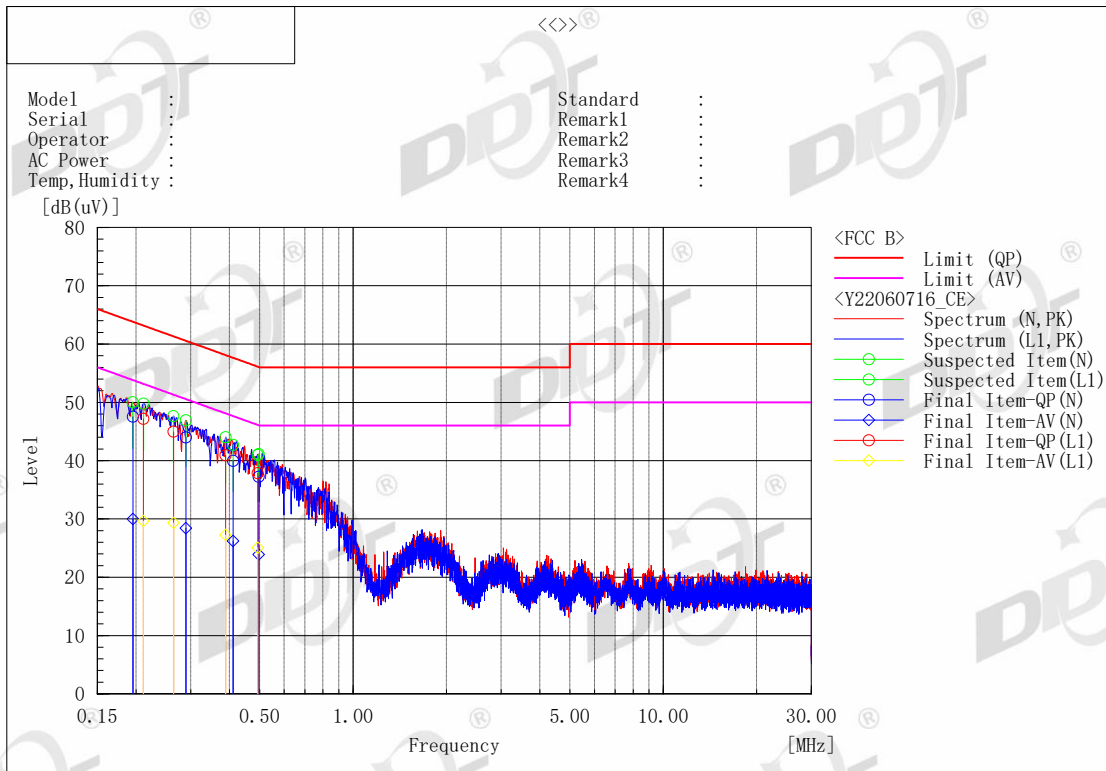

Final Result

--- N Phase ---

No.	Frequency [MHz]	Reading QP [dB(uV)]	Reading CAV [dB(uV)]	c. f [dB]	Result QP [dB(uV)]	Result CAV [dB(uV)]	Limit QP [dB(uV)]	Limit AV [dB(uV)]	Margin QP [dB]	Margin CAV [dB]
1	0.28923	34.3	18.7	9.7	44.0	28.4	60.5	50.5	16.5	22.1
2	0.1952	37.7	20.2	9.8	47.5	30.0	63.8	53.8	16.3	23.8
3	0.41056	30.2	16.5	9.7	39.9	26.2	57.6	47.6	17.7	21.4
4	0.49662	27.5	14.2	9.7	37.2	23.9	56.1	46.1	18.9	22.2

--- L1 Phase ---

No.	Frequency [MHz]	Reading QP [dB(uV)]	Reading CAV [dB(uV)]	c. f [dB]	Result QP [dB(uV)]	Result CAV [dB(uV)]	Limit QP [dB(uV)]	Limit AV [dB(uV)]	Margin QP [dB]	Margin CAV [dB]
1	0.21116	37.4	19.8	9.8	47.2	29.6	63.2	53.2	16.0	23.6
2	0.26392	35.2	19.5	9.8	45.0	29.3	61.3	51.3	16.3	22.0
3	0.38867	31.1	17.4	9.8	40.9	27.2	58.1	48.1	17.2	20.9
4	0.49345	28.1	15.3	9.8	37.9	25.1	56.1	46.1	18.2	21.0

Note1) Level (Quasi-Peak and/or C/Average) = Meter Reading + Factor

Note2) Line = Polarity of input power (Live or Neutral)

N : Abbreviation of Neutral Polarity, L1 : Abbreviation of Live Polarity,

Note3) Factor = LISN Insertion Loss + Cable Loss

Note4) Margin = Limit – Level (Quasi-Peak and/or C/Average)

Note5) C/Average : Abbreviation of CISPR Average

12. Antenna Requirements

12.1. Limit

For intentional device, according to FCC 47 CFR Section 15.203, an intentional radiator shall be designed to ensure that no antenna other than that furnished by the responsible party shall be used with the device. And according to FCC 47 CFR Section 15.247 (b), if transmitting antennas of directional gain greater than 6dBi are used, the power shall be reduced by the amount in dB that the directional gain of the antenna exceeds 6dBi.

12.2. Result

The antenna used for this product is Integrated antenna and no antenna other than that furnished by the responsible party shall be used with the device, maximum antenna gain is 2.28 dBi.