

FCC and IC Test Report for Parts 15.247, 15.207, 15.209 (DTS) 15.107 and 15.109 and RSS-247, RSS Gen

Product name	LM2
Applicant	RATIONAL AG
FCC ID	2AUI6-LM2
IC ID	25504-LM2

Test report No. : 180300268 009 v1.00

Laboratory information

Accreditation

Telefication complies with the accreditation criteria for test laboratories as laid down in ISO/IEC 17025:2005. The accreditation covers the quality system of the laboratory as well as the specific activities as described in the authorized annex bearing the accreditation number L021 and is granted on 30 November 1990 by the Dutch Council For Accreditation (RvA: Raad voor Accreditatie).

Telefication is designated by the FCC as an Accredited Test Firm for compliance testing of equipment subject to Certification under Parts 15 & 18. The Designation number is: NL0001.

Telefication is a Wireless Device Testing laboratory recognized by Innovation, Science and Economic Development Canada to test to Canadian radio equipment requirements. The Industry Canada registration number for the 3 meter test chamber of Telefication is: 4173A-1.

Telefication is a registered Conformity Assessment body (CAB) under the Japan-EC MRA (Agreement on Mutual Recognition between Japan and the European Community). The registration number is: 201.

Documentation

The test report must always be reproduced in full; reproduction of an excerpt only is subject to written approval of the testing laboratory. The documentation of the testing performed on the tested devices is archived for 10 years at Telefication Netherlands.

Testing Location

Test Site	Telefication BV
Test Site location	Edisonstraat 12a 6902 PK Zevenaar The Netherlands Tel. +31889983600 Fax. +31316583189
Test Site FCC	NL0001

Revision History

Version	Date	Remarks	By
v0.50	23-08-2019	First draft	RvB
v1.00	28-11-2019	Initial release	RvB

Table of Contents

Revision History	2
Summary of Test results	5
1 General Description	6
1.1 Applicant	6
1.2 Manufacturer	6
1.3 Tested Equipment Under Test (EUT).....	6
1.4 Product specifications of Equipment under test.....	7
1.5 Modification of the Equipment Under Test (EUT)	7
1.6 Observations and remarks	7
1.7 Environmental conditions	7
1.8 Measurement Standards.....	7
1.9 Applicable Standards.....	7
1.10 Conclusions	8
2 Test configuration of the Equipment Under Test	9
2.1 Test mode	9
2.2 Tested channels and Data rates	9
2.3 Test setups	9
2.4 Equipment used in the test configuration	11
2.5 Sample calculation	11
3 Test results	12
3.1 6dB bandwidth Measurement	12
3.1.1 Limit	12
3.1.2 Measurement instruments	12
3.1.3 Test setup	12
3.1.4 Test procedure.....	12
3.1.5 Test Results of the 6 dB bandwidth Measurement	12
3.1.6 Plots of the 6 dB bandwidth Measurement.....	13
3.2 99% Occupied Bandwidth	16
3.2.1 Limit	16
3.2.2 Measurement instruments	16
3.2.3 Test setup	16
3.2.4 Test procedure.....	16
3.2.5 Test results of the 99% occupied bandwidth measurement	16
3.2.6 Plots of the 99% Occupied Bandwidth Measurement.....	17
3.3 Output Power Measurement	20
3.3.1 Limit	20
3.3.2 Measurement instruments	20

3.3.3	Test setup	20
3.3.4	Test procedure.....	20
3.3.5	Test results of Output Power Measurement	20
3.3.6	Plots of the output power measurement	21
3.4	Power Spectral Density	24
3.4.1	Limit	24
3.4.2	Measurement instruments	24
3.4.3	Test setup	24
3.4.4	Test procedure.....	24
3.4.5	Spectral Density Measurement	24
3.4.6	Plots of the Power Spectral Density Measurements	25
3.5	Band edge Measurement.....	28
3.5.1	Limit	28
3.5.2	Measurement instruments	28
3.5.3	Test setup	28
3.5.4	Test procedure.....	28
3.5.5	Test results the Band edge Measurements	28
3.5.6	Plots of the Conducted Spurious an Band edge Measurements	29
3.6	Radiated Spurious Emissions Measurement.....	32
3.6.1	Limit	32
3.6.2	Measurement instruments	32
3.6.3	Test setup	32
3.6.4	Test procedure.....	32
3.6.5	Notes.....	32
3.6.6	Plots of the Radiated Spurious Emissions.....	33
3.6.7	Measurement Uncertainty	55
3.7	AC conducted mains measurement	56
3.7.1	Limit	56
3.7.2	Measurement instruments	56
3.7.3	Test setup	56
3.7.4	Test procedure.....	56
3.7.5	Test results and plots of the AC conducted mains measurement	56
3.7.6	Measurement uncertainty	56
3.7.7	Plots of the AC conducted spurious measurement	57

Summary of Test results

FCC	ISED	Description	Section in report	Verdict
15.203	--	Antenna requirements	1.4	Pass
15.247 (a)	RSS-247 5.2(a)	6dB Bandwidth	3.1	Pass
--	RSS-Gen 6.7	99% Bandwidth	3.2	Pass
15.247 (b)	RSS-247 5.1 (b)	RF output power	3.3	Pass
15.247 (e)	RSS-247 5.2 (b)	Power spectral density	3.4	Pass
15.247 (d)	RSS-247 5.5	Band edge	3.5	Pass
15.209 (a)	RSS-247 5.4	Radiated Spurious emissions	3.6	Pass
15.205 (a)	RSS Gen 8.10	Spurious emissions in the restricted bands	3.6	Pass
15.207(c)/ 15.247(d)	RSS-GEN 8.8	Conducted spurious emission on AC mains	3.7	Pass

1 General Description

1.1 Applicant

Client name: RATIONAL AG
Address Siegfried-Meister-Straße 1, Landsberg am Lech,
Bavaria, Germany
Zip code: 86899
E-mail: r.hegmann@rational-online.com
Contact name: Mr. R. Hegmann

1.2 Manufacturer

Client name: RATIONAL AG
Address Celsiusstraße 6, Landsberg am Lech, Bavaria,
Germany
Zip code: 86899
E-mail: p.buhl@rational-online.com
Contact name: Mr. P. Bühl

1.3 Tested Equipment Under Test (EUT)

Product name: LM2
Brand name: RATIONAL
Product type: Oven controller with Wifi
FCC ID: 2AUI6-LM2
IC ID 25504-LM2
Software version: --
Hardware version: --
Date of receipt 19-02-2019
Tests started: 26-07-2019
Testing ended: 23-08-2019

1.4 Product specifications of Equipment under test

TX Frequency range (MHz)	2400 – 2483.5
RX frequency range (MHz)	2400 – 2483.5
Maximum output power to antenna (dBm)	16.68
Antenna type	PCB antenna
Antenna gain (dBi)	3.1
Type of modulation	Acc. to IEEE 802.11b/g/n
Emission designator	802.11b: 11M1G1D 802.11g: 15M7G1D 802.11n: 15M5G1D

1.5 Modification of the Equipment Under Test (EUT)

None.

1.6 Observations and remarks

The EUT is an oven controller with a WIFI module inside.

1.7 Environmental conditions

Test date	19-02-2019	26-07-2019	23-08-2019
Ambient temperature	21.8°C	27.4°C	23.8°C
Humidity	35.5	48.1%	47.5%

1.8 Measurement Standards

- ANSI C63.10:2013
- FCC KDB Publication No. 558074 D01 DTS Meas. Guidance v05

1.9 Applicable Standards

According to the specifications of the manufacturer, the EUT must comply with the requirements of the following standards:

- FCC Part 15 Subpart C §15.247, §15.209, §15.207 and §15.109
- RSS-247 Issue 2, RSS-Gen Issue 5

1.10 Conclusions

The sample of the product showed **NO NON-COMPLIANCES** to the specifications stated in paragraph 1.9 of this report.

The results of the test as stated in this report, are exclusively applicable to the product items as identified in this report. Telefication accepts no responsibility for any properties of product items in this test report, which are not supported by the tests as specified in paragraph 1.9 "*Applicable standards*".

All tests are performed by:

Name : ing. R. van Barneveld

Review of test methods and report by:

Name : P. van Wanrooij, BASc

The above conclusions have been verified by the following signatory:

Date :

Name : ing. K.A. Roes

Function : Coordinator Radio Laboratory

Signature :

2 Test configuration of the Equipment Under Test

2.1 Test mode

The applicant provided test mode software called “Hterm” for the EUT, in which it was possible to configure the EUT into different test channels. For all the tests in this report the following power settings are used
 802.11b = “15”, 802.11g/n=“21”

The applicant also provided both a radiated sample and a conducted sample for radio testing.

2.2 Tested channels and Data rates

Technology	Channels	Data rate	Frequency (MHz)
IEEE 802.11b/g/n	1 (Low)	1/6Mbps and MCS0	2412
	6(Mid)	1/6Mbps and MCS0	2437
	11 (High)	1/6Mbps and MCS0	2462

2.3 Test setups

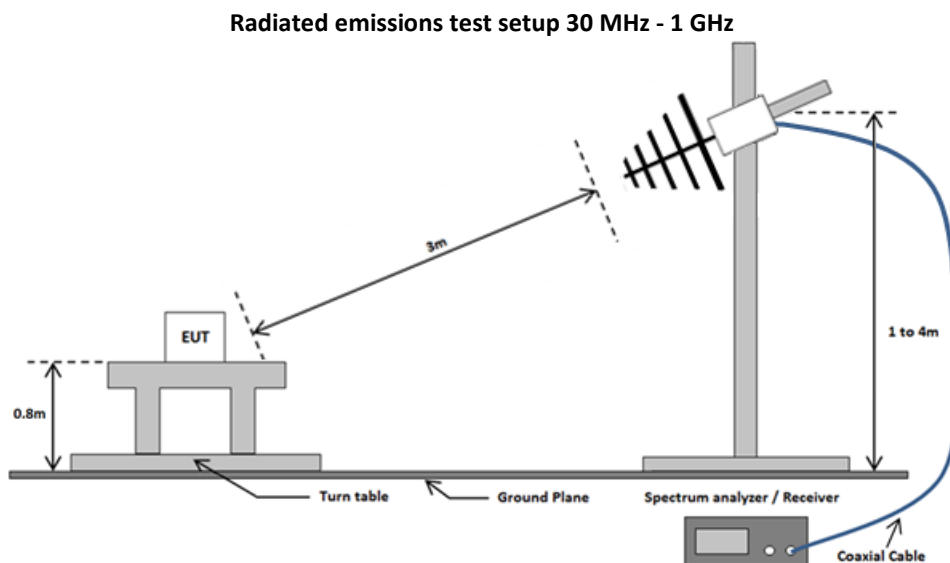
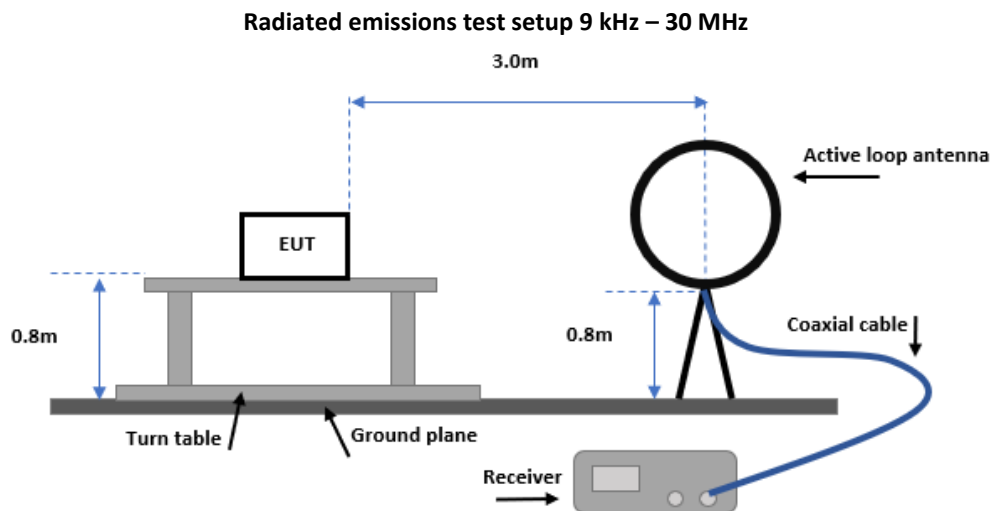

Radiated emissions test setup above 1 GHz

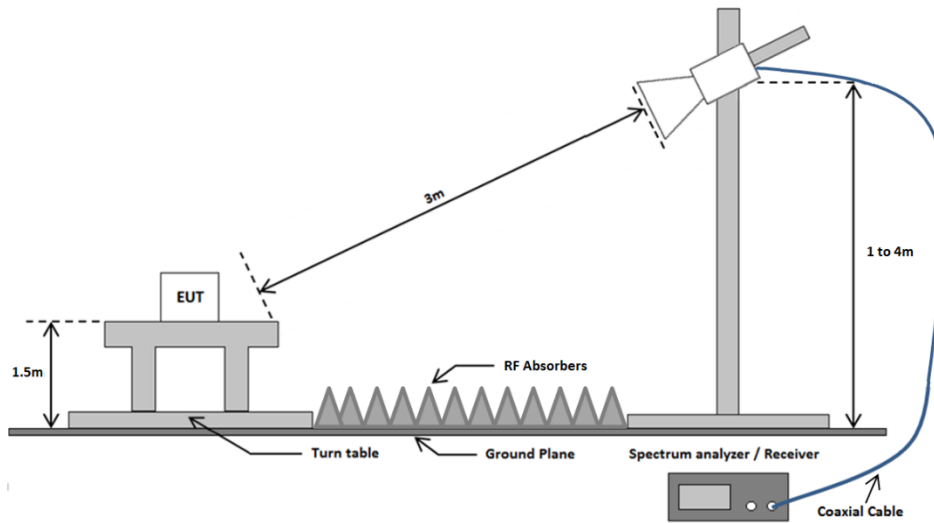

Conducted test setup

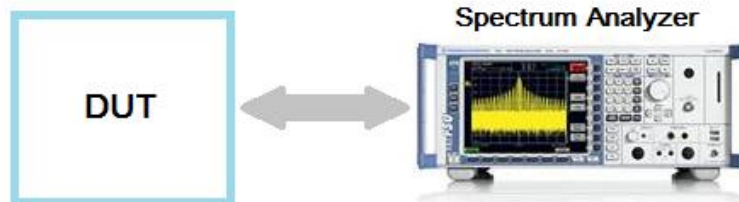

Conducted Emissions on the AC mains test setup

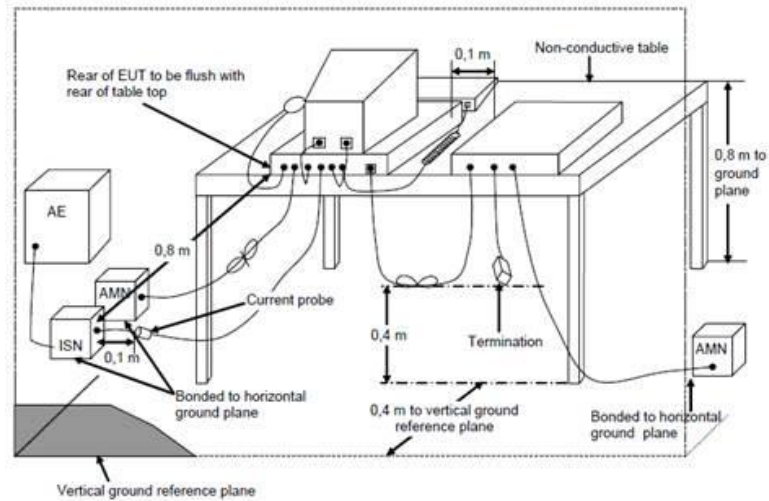

2.4 Equipment used in the test configuration

Description	Manufacturer	Model	ID	Used at Par.
Spectrum Analyzer	Rohde & Schwarz	FSV40	TE01269	3.1 – 3.5
Spectrum Analyzer	Rohde & Schwarz	FSP40	TE11125	3.6
Spectrum Analyzer	Rohde & Schwarz	ESR7	TE01220	3.6-3.7
Biconilog Antenna	Chase	CBL6112A	TE00967	3.6
Horn Antenna	EMCO The Electro – Mechanics Co	3115	TE00531	3.6
Horn Antenna	Flann Microwave	20240-25	TE00818	3.6
SAC Chamber	Comtest Engineering BV	-	TE00861	3.6
Band reject filter	5N45-2441/T83-0/0	WHK3.0/18G-10EF	TE00932	3.6
Pre-amplifier	Miteq	Js4-18004000-30-8P-A1	TE11131	3.6
Pre-amplifier	Miteq	AFS42-041001800-29-OP-42	TE00092	3.6
Software	DARE Instruments	Radimation 2018.3.8	--	3.6
Software	DARE Instruments	Radimation 2016.2.8	--	3.7
Artificial Mains Network (AMN)	Rohde & Schwarz	ESH3-Z5	TE00208	3.7
Pulse Limiter	Rohde & Schwarz	ESH3-Z2	TE00756	3.7
Active loop antenna	Rohde & Schwarz	HFH2-z2	TE00747	3.6

2.5 Sample calculation

Field Strength Measurement **example:**

Frequency (GHz)	Polarization	Height(m)	Peak (dB μ V/m)
7,236	Horizontal	2	52.5

The following relation applies:

$$E \text{ (dB}\mu\text{V/m)} = U \text{ (dB}\mu\text{V)} + AF \text{ (dB/m)} - G \text{ (dB)} + CL \text{ (dB)}$$

Where:

E = Electric field strength

U = Measuring receiver voltage

AF = Antenna factor

G = Gain of the pre-amplifier

CL = Cable loss

$$(52.5 = 48.12 + 36.1 - 37.42 + 5.7)$$

3 Test results

3.1 6dB bandwidth Measurement

3.1.1 Limit

The minimum 6 dB Bandwidth shall be at least 500 kHz.

3.1.2 Measurement instruments

The measurement instruments are listed in chapter 2.4 of this report.

3.1.3 Test setup

The test setup is as shown in chapter 2.3 of this report.

3.1.4 Test procedure

Tests according to ANSI C63.10

IRN 017 - Occupied bandwidth (Hz) Method 4 – DTS Bandwidth.

3.1.5 Test Results of the 6 dB bandwidth Measurement

Technology Std.	Channel	Frequency (MHz)	Data rate	6dB bandwidth (MHz)
802.11b	1	2412	1 Mbps	11.02
	6	2437	1 Mbps	11.14
	11	2462	1 Mbps	11.02
Uncertainty	± 39 kHz			

Technology Std.	Channel	Frequency (MHz)	Data rate	6dB bandwidth (MHz)
802.11g	1	2412	6 Mbps	15.60
	6	2437	6 Mbps	15.37
	11	2462	6 Mbps	15.67
Uncertainty	± 39 kHz			

Technology Std.	Channel	Frequency (MHz)	Data rate	6dB bandwidth (MHz)
802.11n	1	2412	MCS0	15.60
	6	2437	MCS0	15.37
	11	2462	MCS0	15.49
Uncertainty	± 39 kHz			

3.1.6 Plots of the 6 dB bandwidth Measurement

802.11b 6dB Bandwidth (Channel 1)

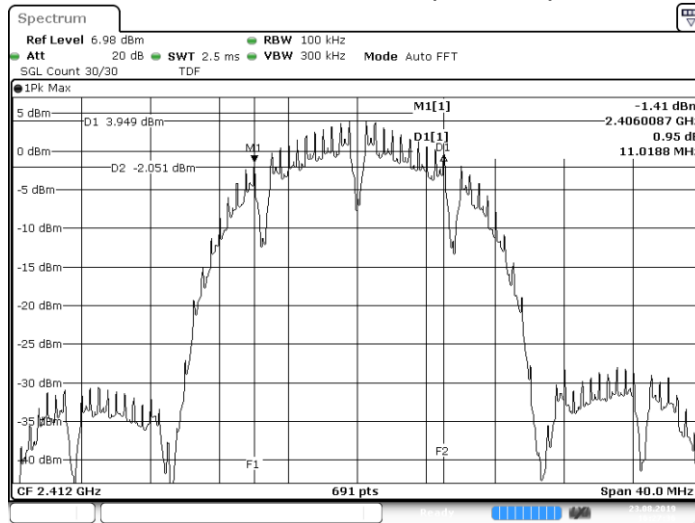

802.11b 6dB Bandwidth (Channel 6)

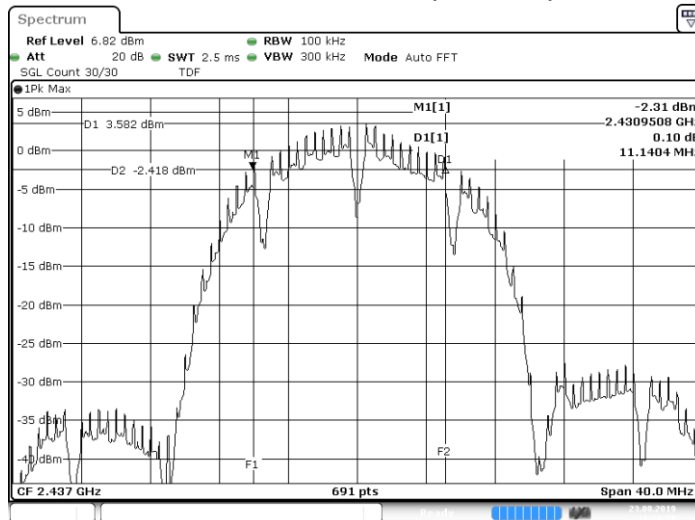

802.11b 6dB Bandwidth (Channel 11)

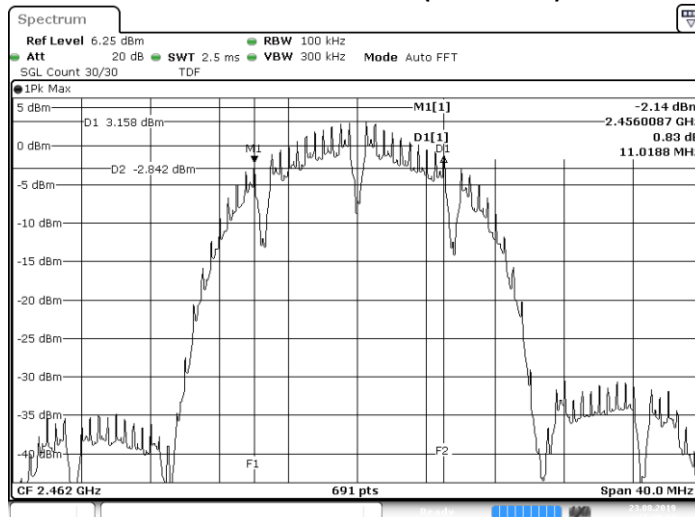

802.11g 6dB Bandwidth (Channel 1)

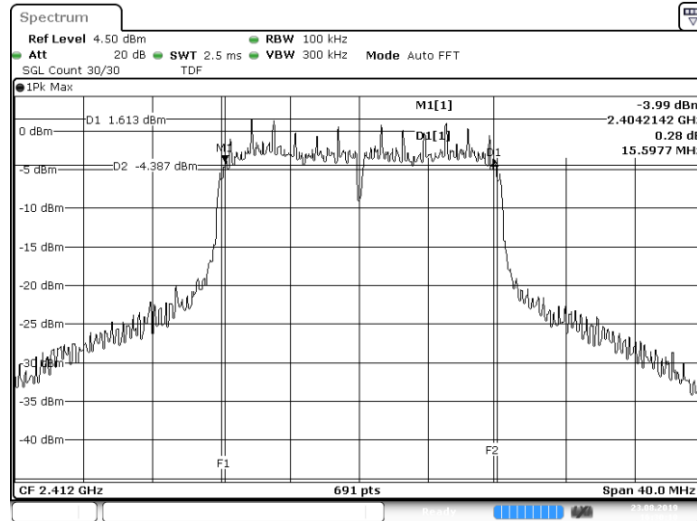

802.11g 6dB Bandwidth (Channel 6)

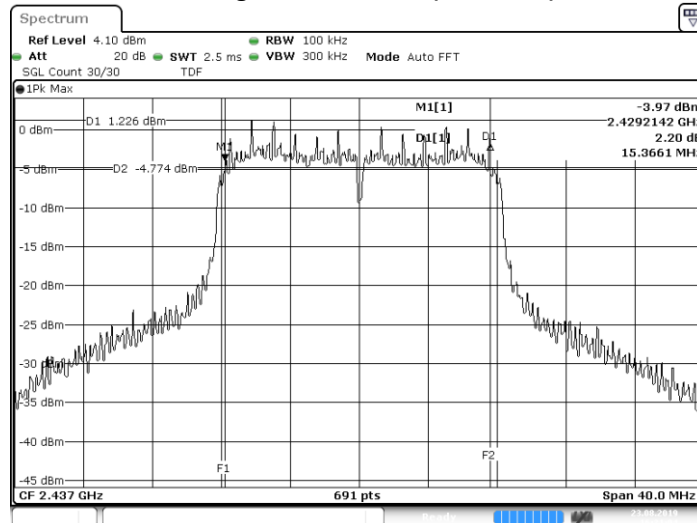

802.11g 6dB Bandwidth (Channel 11)

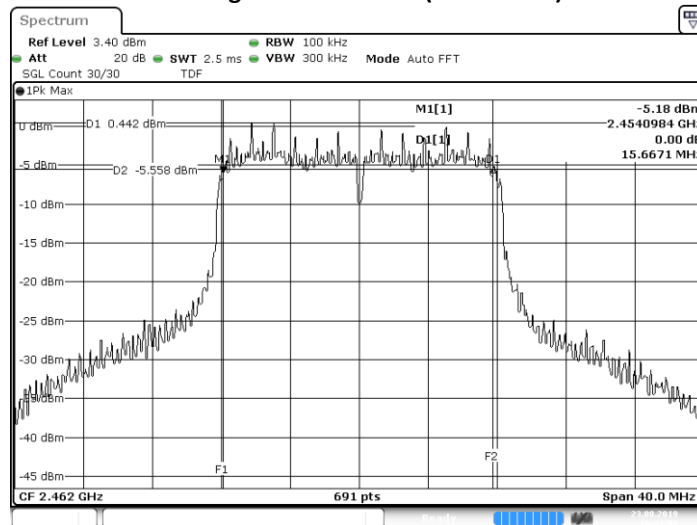

802.11n 6dB Bandwidth (Channel 1)

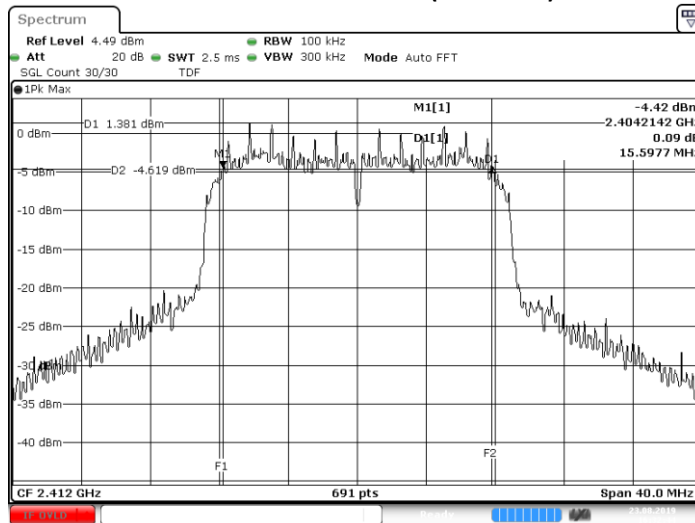

802.11n 6dB Bandwidth (Channel 6)

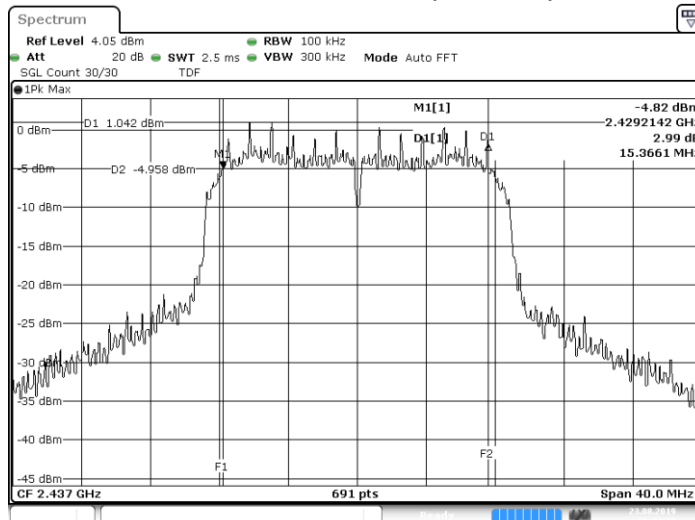

802.11n 6dB Bandwidth (Channel 11)

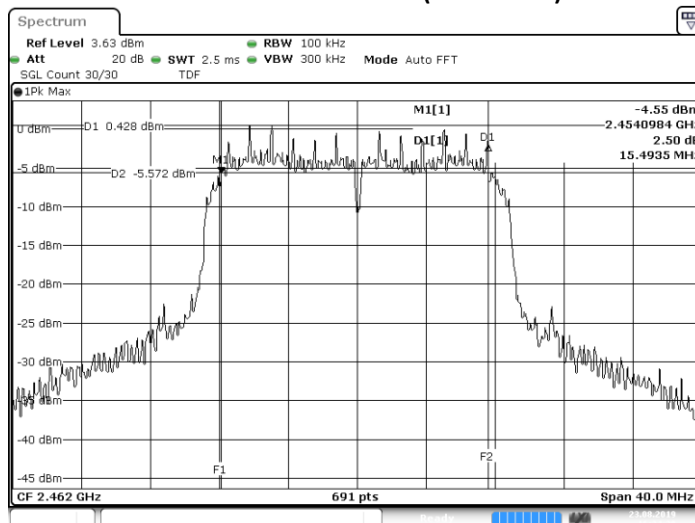

3.2 99% Occupied Bandwidth

3.2.1 Limit

According to RSS-Gen 6.7

3.2.2 Measurement instruments

The measurement instruments are listed in chapter 2.4 of this report.

3.2.3 Test setup

The test setup is as shown in chapter 2.3 of this report.

3.2.4 Test procedure

IRN 017 - Occupied bandwidth (Hz) Method 1 – XX % power bandwidth.

1. Set the centre frequency to the nominal EUT channel centre frequency
2. Set span = 1.5 times to 0.5 times the Occupied Bandwidth
3. Set VBW \geq 3x RBW
4. Video averaging is not permitted. Where practical, detection and single sweep mode shall be used. Otherwise, peak detection and max hold mode (until the trace stabilizes) shall be used.

3.2.5 Test results of the 99% occupied bandwidth measurement

Technology Std.	Channel	Frequency (MHz)	Data rate	99% bandwidth (MHz)
IEEE 802.11b	1(Low)	2412	1 Mbps	16.06
	6(Mid)	2437	1 Mbps	16.11
	11 (High)	2462	1 Mbps	16.06
IEEE 802.11g	1(Low)	2412	6 Mbps	16.58
	6(Mid)	2437	6 Mbps	16.54
	11 (High)	2462	6 Mbps	16.45
IEEE 802.11n	1(Low)	2412	MCS0	17.58
	6(Mid)	2437	MCS0	17.54
	11 (High)	2462	MCS0	17.50
Uncertainty	± 39 kHz			

3.2.6 Plots of the 99% Occupied Bandwidth Measurement

802.11b 99% Occupied Bandwidth (Channel 1)

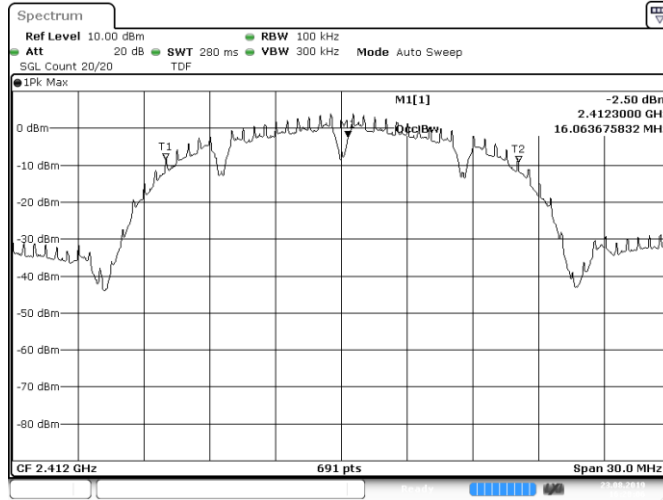

802.11b 99% Occupied Bandwidth (Channel 6)

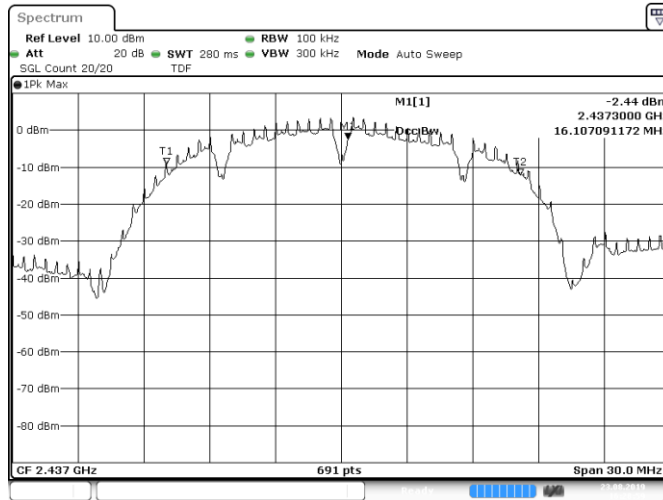

802.11b 99% Occupied Bandwidth (Channel 11)

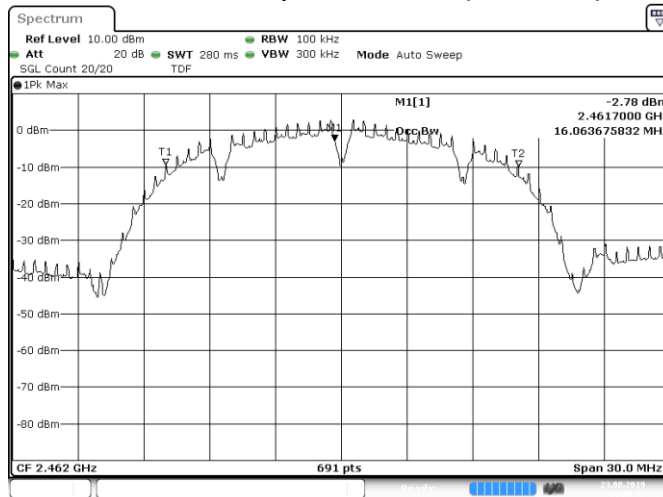

802.11g 99% Occupied Bandwidth (Channel 1)

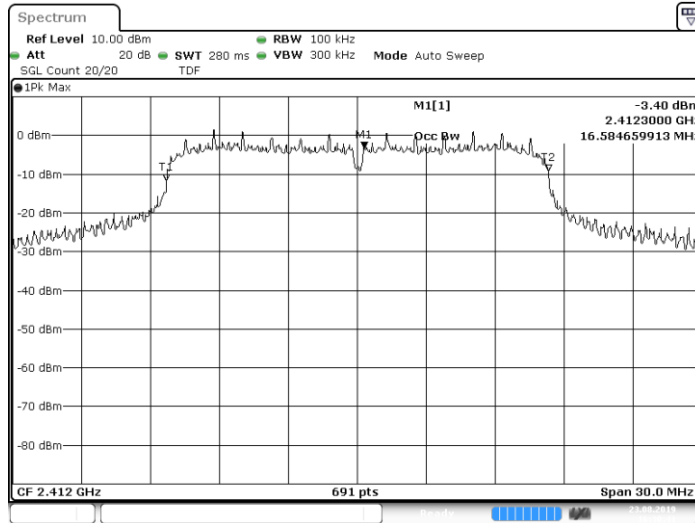

802.11g 99% Occupied Bandwidth (Channel 6)

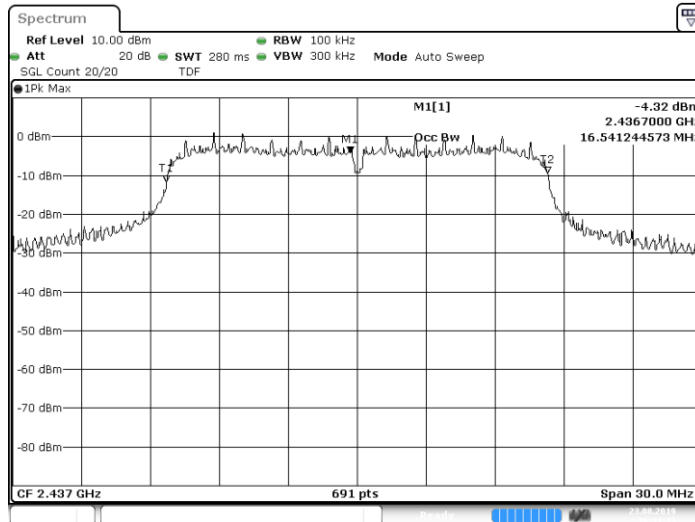

802.11g 99% Occupied Bandwidth (Channel 11)

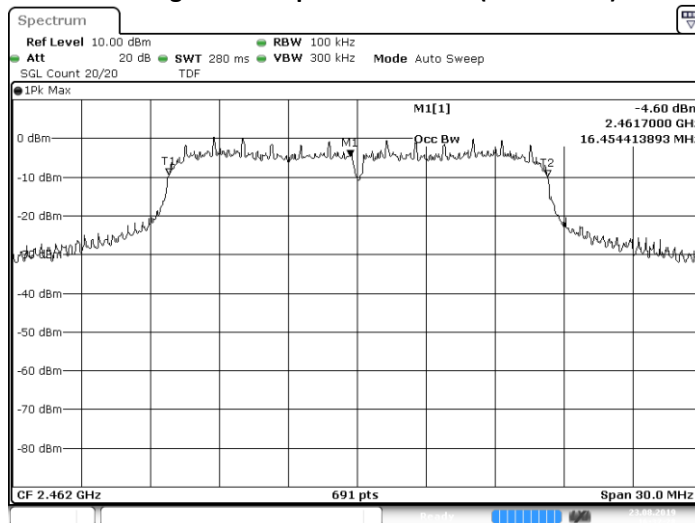

802.11n 99% Occupied Bandwidth (Channel 1)

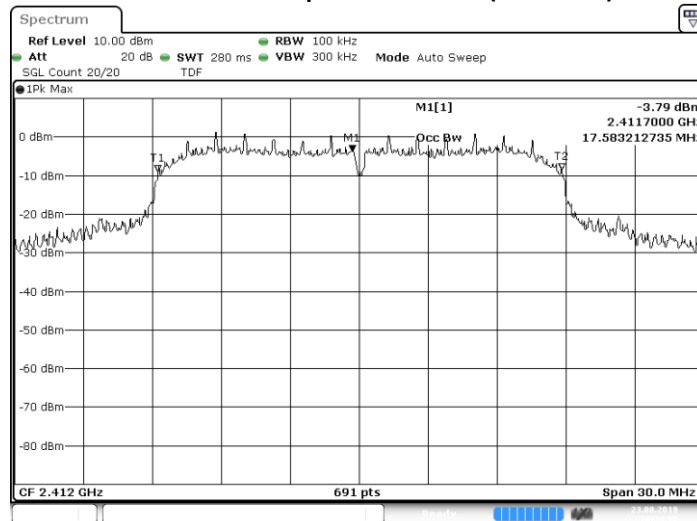

802.11n 99% Occupied Bandwidth (Channel 6)

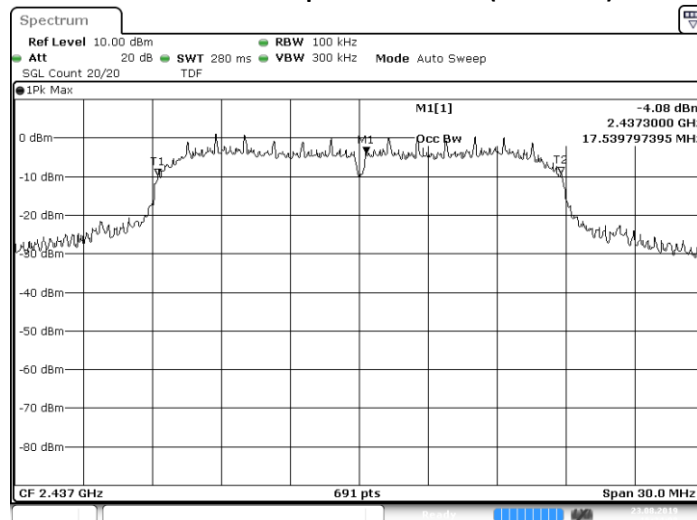

802.11n 99% Occupied Bandwidth (Channel 11)

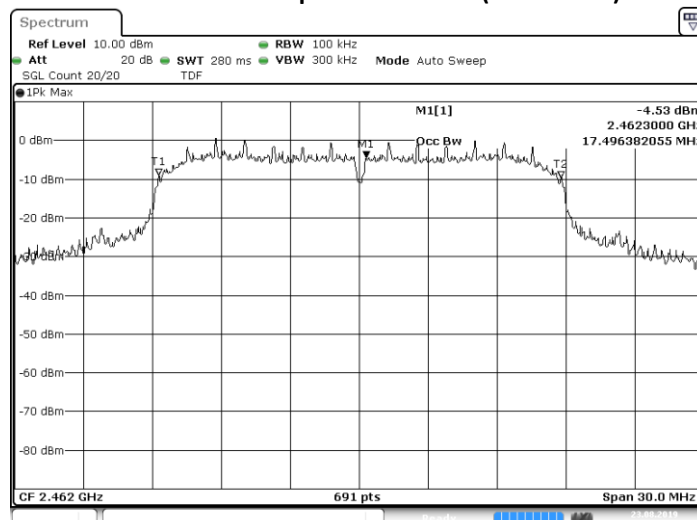

3.3 Output Power Measurement

3.3.1 Limit

For systems using digital modulation in the 2400-2483.5 MHz, the limit for the peak output power is 30 dBm. If transmitting antenna of directional gain greater than 6 dBi is used, the peak output power from the intentional radiator shall be reduced below the above stated value by the amount in dB that the directional gain of the antenna exceeds 6 dBi. In case of point to point operation, the limit has to be reduced by 1 dB for every 3 dB that the directional gain of the antenna exceeds 6 dBi.

3.3.2 Measurement instruments

The measurement instruments are listed in chapter 2.4 of this report.

3.3.3 Test setup

The test setup is as shown in chapter 2.3 of this report.

3.3.4 Test procedure

The testing follows FCC KDB Publication No. 558074 D01 DTS Meas. Guidance v05.
 IRN 014 - RF power (W) - Method 1 – AVGSA (DTS) according to ANSI C63.10.

3.3.5 Test results of Output Power Measurement

Technology Std.	Channel	Frequency (MHz)	Data rate	Peak output power (dBm)
802.11b	1	2412	11 Mbps	16.77
	6	2437	11 Mbps	16.49
	11	2462	11 Mbps	15.90
Uncertainty	±0.71 dB			

Technology Std.	Channel	Frequency (MHz)	Data rate	Peak output power (dBm)
802.11g	1	2412	54 Mbps	19.42
	6	2437	54 Mbps	19.35
	11	2462	54 Mbps	19.33
Uncertainty	±0.71 dB			

Technology Std.	Channel	Frequency (MHz)	Data rate	Peak output power (dBm)
802.11n	1	2412	MCS7	19.27
	6	2437	MCS7	19.57
	11	2462	MCS7	19.78
Uncertainty	±0.71 dB			

Note: conducted output power (dBm) + antenna gain (dBi) = peak output power (dBm)

3.3.6 Plots of the output power measurement

802.11b Peak Output Power (Channel 1)

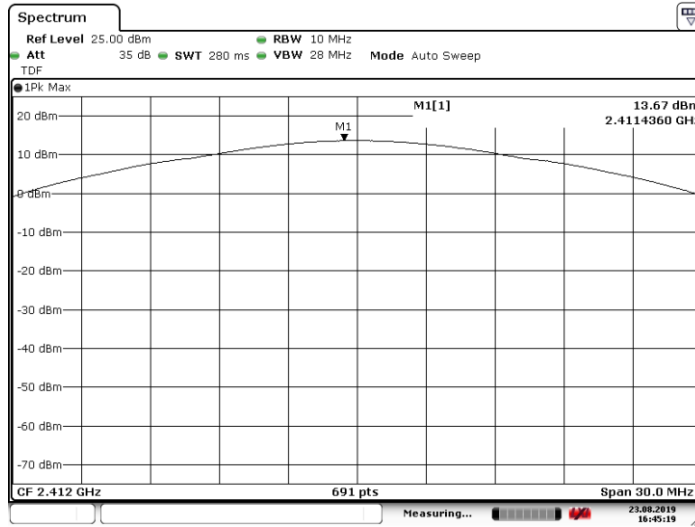

802.11b Peak Output Power (Channel 6)

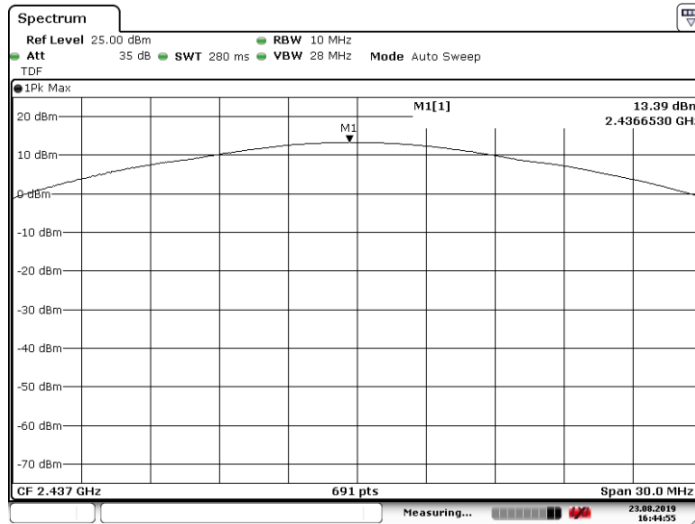

802.11b Peak Output Power (Channel 11)

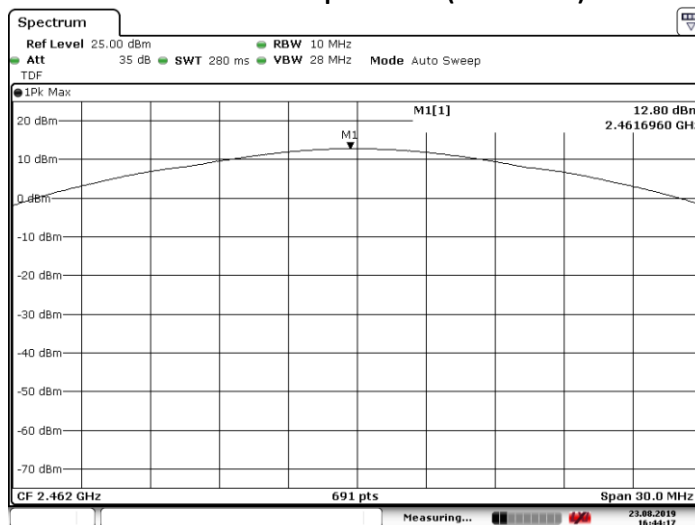

802.11g Peak Output Power (Channel 1)

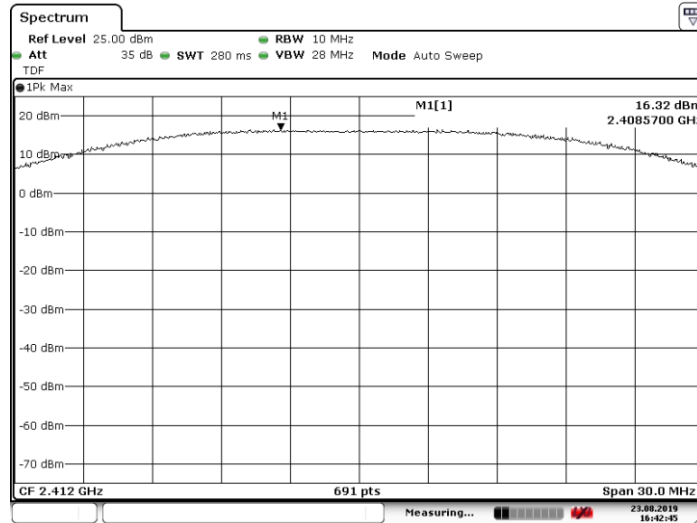

802.11g Peak Output Power (Channel 6)

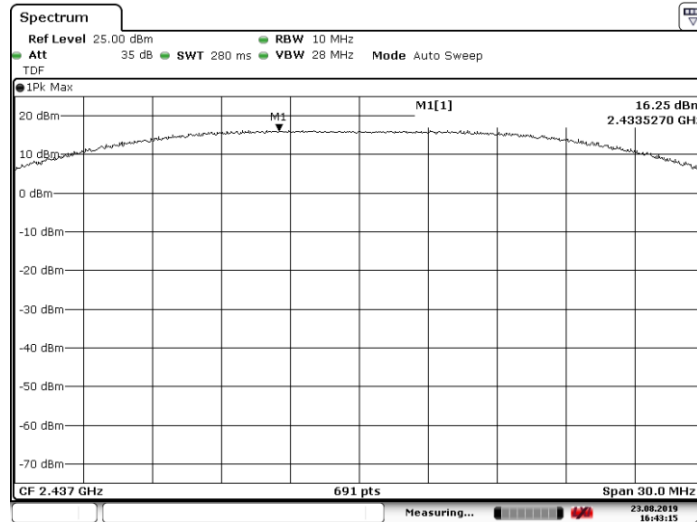

802.11g Peak Output Power (Channel 11)

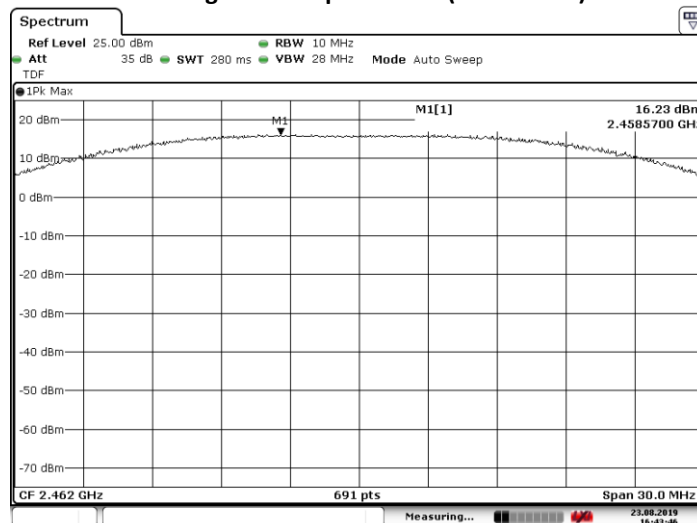

802.11n Peak Output Power (Channel 1)

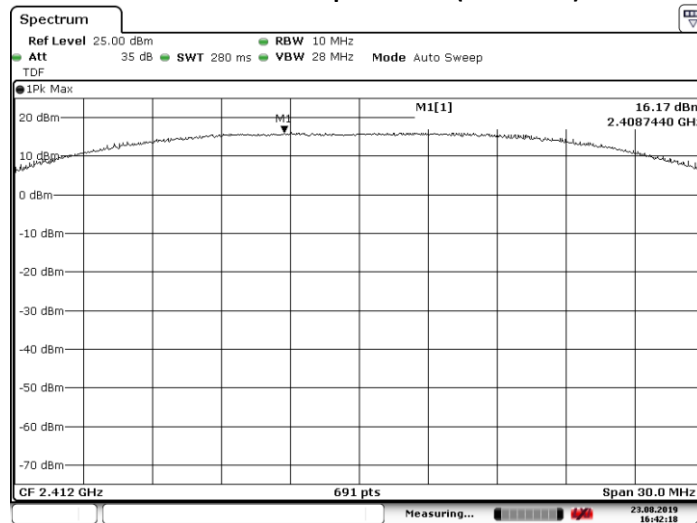

802.11n Peak Output Power (Channel 6)

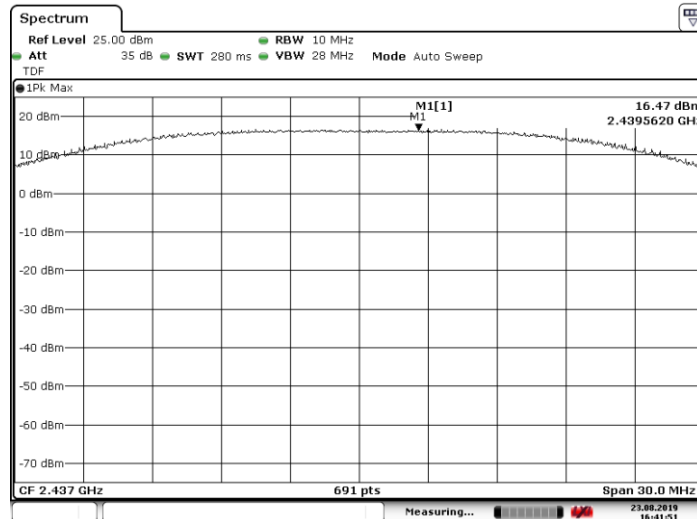

802.11n Peak Output Power (Channel 11)

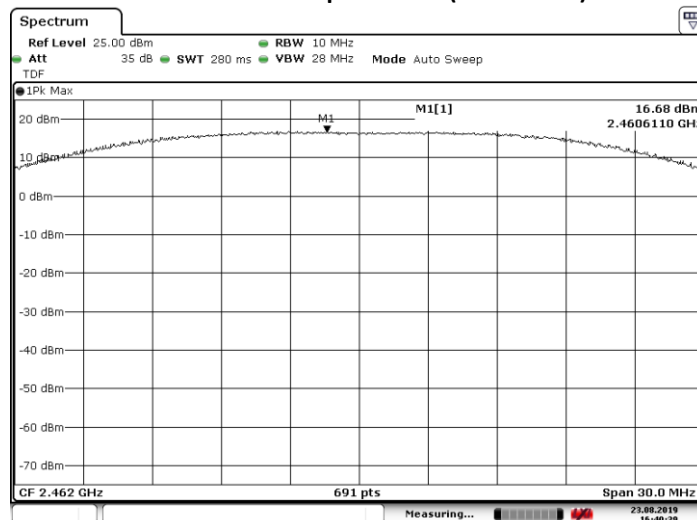

3.4 Power Spectral Density

3.4.1 Limit

The peak power spectral density shall not be greater than 8 dBm in any 3 kHz band at any time interval of continuous transmission.

3.4.2 Measurement instruments

The measurement instruments are listed in chapter 2.4 of this report.

3.4.3 Test setup

The test setup is as shown in chapter 2.3 of this report.

3.4.4 Test procedure

The testing follows FCC KDB Publication No. 558074 D01 DTS Meas. Guidance v05.

IRN 030 - Spectral power density (W per n.Hz) - Method 5 – Peak method PKPSD (PSD in 3 kHz band)

3.4.5 Spectral Density Measurement

Technology Std.	Channel	Frequency (MHz)	Data rate	PSD/3 kHz (dBm)
IEEE 802.11b	1(Low)	2412	1 Mbps	-6.71
	6(Mid)	2437	1 Mbps	-7.26
	11 (High)	2462	1 Mbps	-7.55
Uncertainty	±2 dB			

Technology Std.	Channels	Frequency (MHz)	Data rate	PSD/3 kHz (dBm)
IEEE 802.11g	1(Low)	2412	6 Mbps	-9.47
	6(Mid)	2437	6 Mbps	-9.94
	11 (High)	2462	6 Mbps	-10.46
Uncertainty	±2 dB			

Technology Std.	Channels	Frequency (MHz)	Data rate	PSD/3 kHz (dBm)
IEEE 802.11n	1(Low)	2412	MCS0	-9.94
	6(Mid)	2437	MCS0	9.40
	11 (High)	2462	MCS0	-11.13
Uncertainty	±2 dB			

PSD= conducted value(dBm)+antenna gain(dBi)

3.4.6 Plots of the Power Spectral Density Measurements

802.11b Power Spectral Density 3 kHz (channel 1)

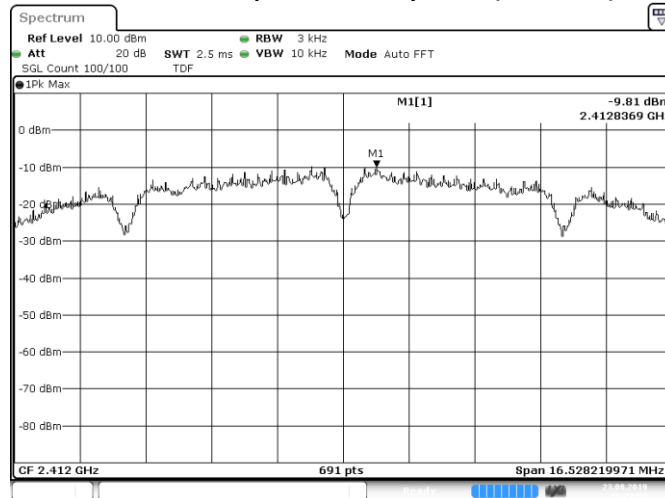

802.11b Power Spectral Density 3 kHz (channel 6)

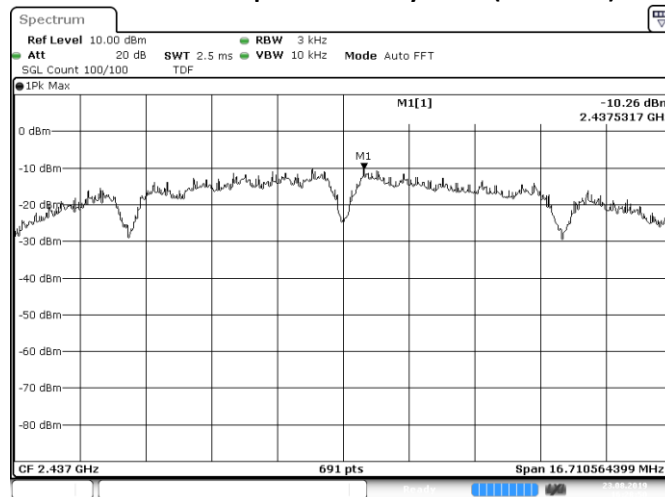

802.11b Power Spectral Density 3 kHz (channel 11)

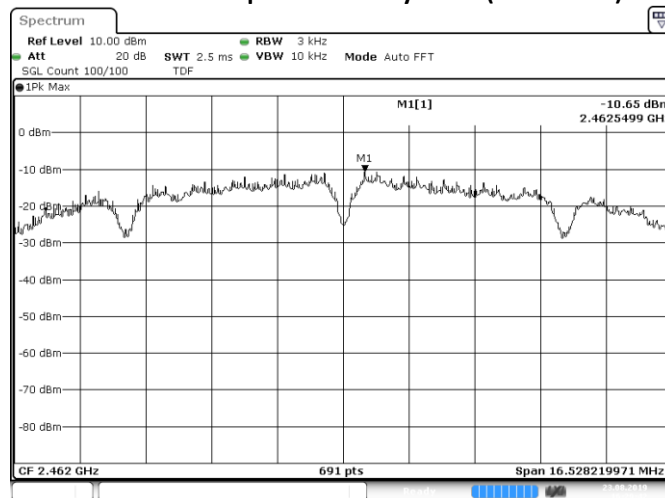

802.11g Power Spectral Density 3 kHz (channel 1)

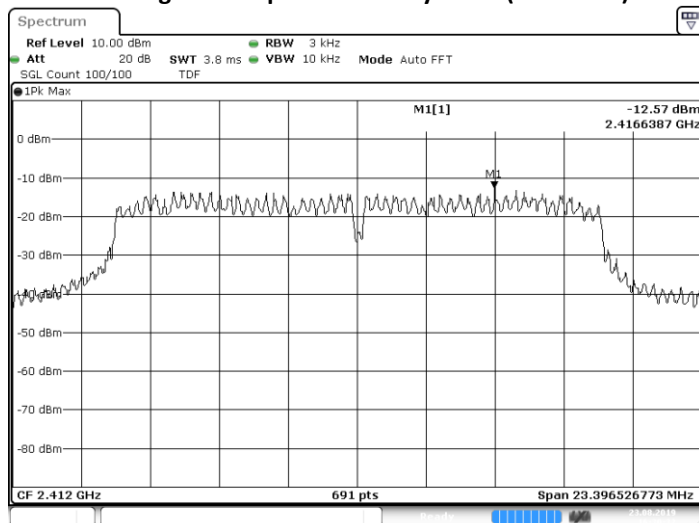

802.11g Power Spectral Density 3 kHz (channel 6)

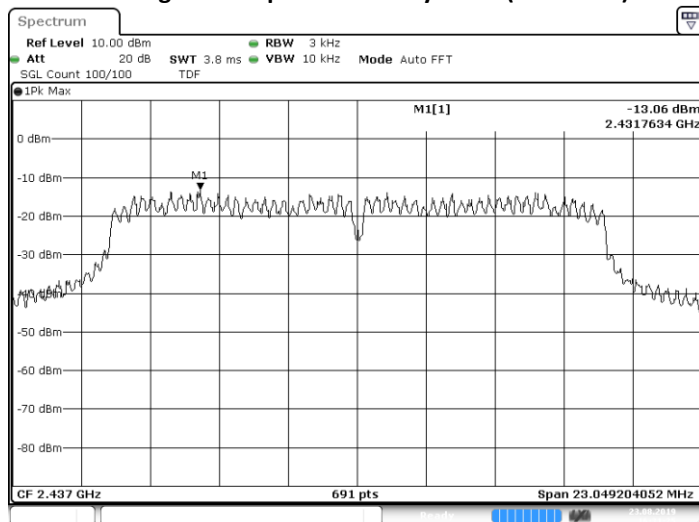

802.11g Power Spectral Density 3 kHz (channel 11)

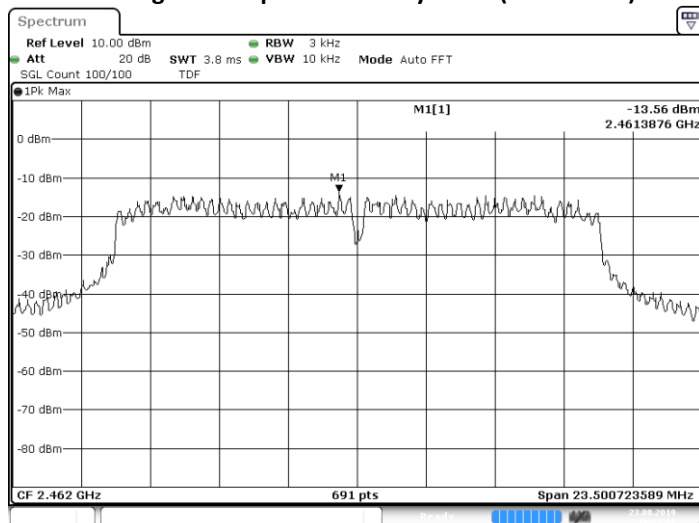

802.11n Power Spectral Density 3 kHz (channel 1)

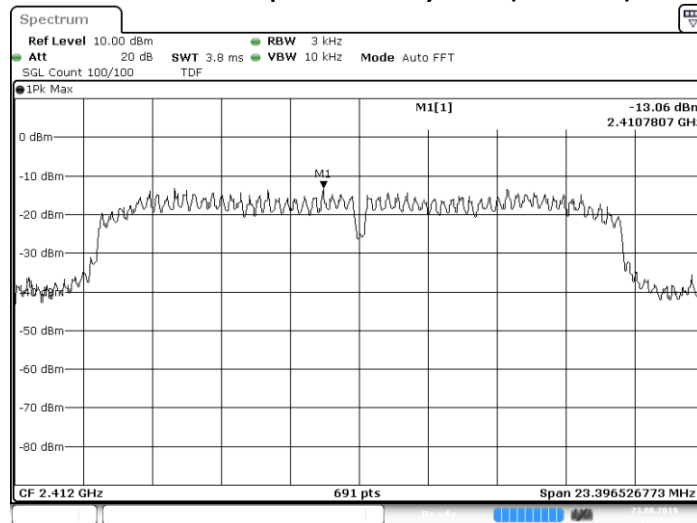

802.11n Power Spectral Density 3 kHz (channel 6)

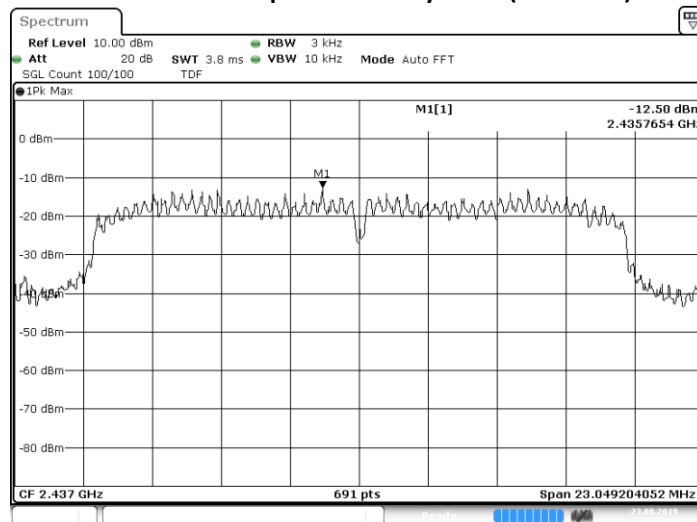

802.11n Power Spectral Density 3 kHz (channel 11)

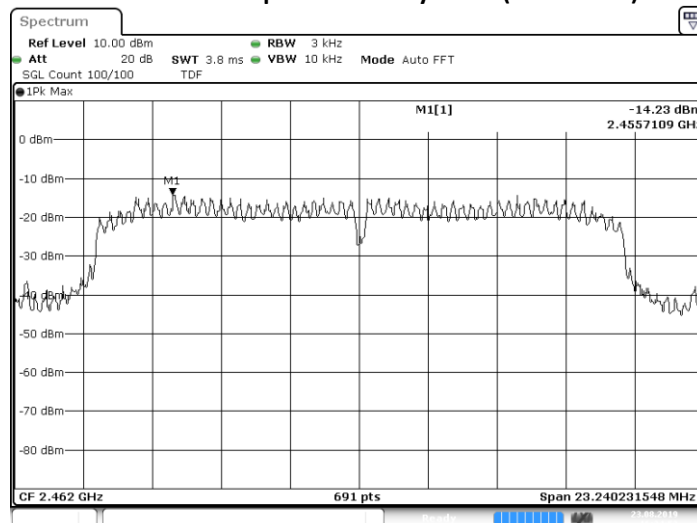

3.5 Band edge Measurement

3.5.1 Limit

Band edge:

At the edge of the authorized band the RF power shall be at least 20 dB down.

3.5.2 Measurement instruments

The measurement instruments are listed in chapter 2.4 of this report.

3.5.3 Test setup

The test setup is as shown in chapter 2.3 of this report.

3.5.4 Test procedure

According to KDB Publication 558074 V05

IRN 026 - Radiated electrical disturbance (V per m) Method 6 – Radiated electrical disturbance at the Authorized band edge.

3.5.5 Test results the Band edge Measurements

Band edge

Technology Std.	Channels	Frequency (MHz)	Data rate	Band edge (dBm)	Limit (dBm)
IEEE 802.11b	1(Low)	2412	1 Mbps	-31.57	-15.26
	11(high)	2462	1 Mbps	-47.63	-15.78
Uncertainty	±2 dB				

Technology Std.	Channels	Frequency (MHz)	Data rate	Band edge (dBm)	Limit (dBm)
IEEE 802.11g	1(Low)	2412	6 Mbps	-23.05	-16.92
	11(high)	2462	6 Mbps	-39.49	-17.62
Uncertainty	±2 dB				

Technology Std.	Channels	Frequency (MHz)	Data rate	Band edge (dBm)	Limit (dBm)
IEEE 802.11n	1(Low)	2412	MCS0	-26.21	-17.29
	11(high)	2462	MCS0	-37.01	-17.89
Uncertainty	±2 dB				

3.5.6 Plots of the Conducted Spurious an Band edge Measurements

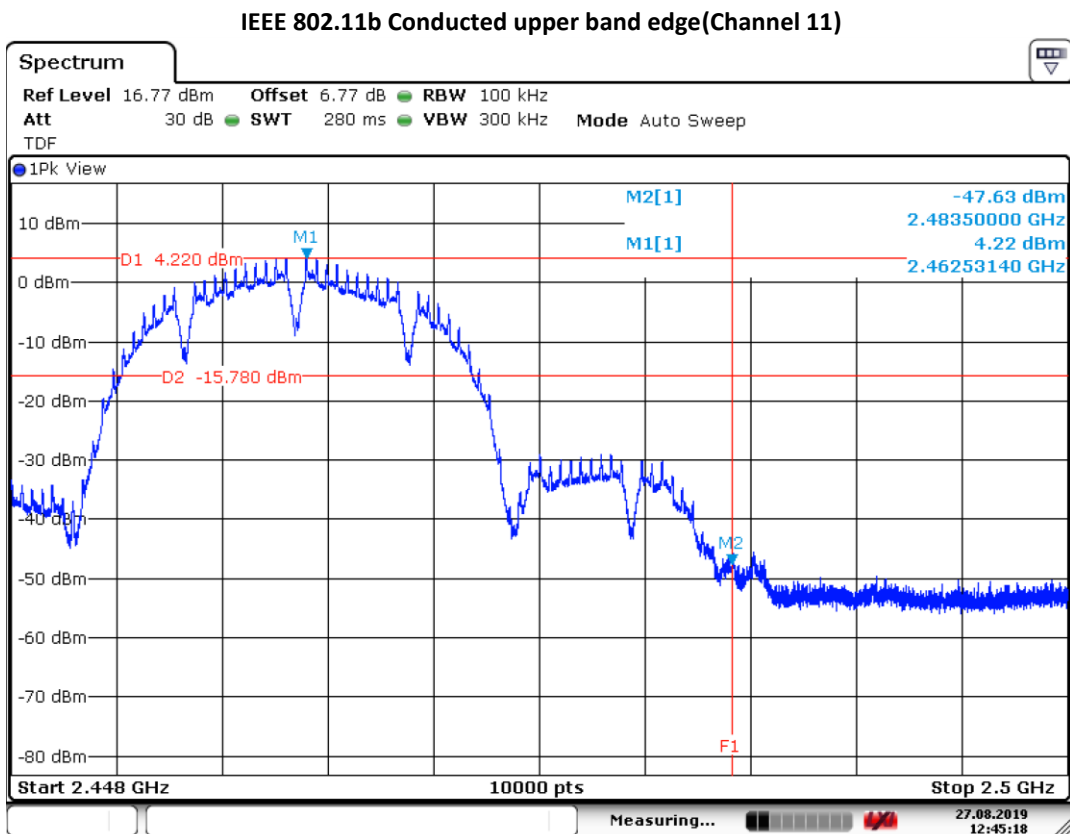
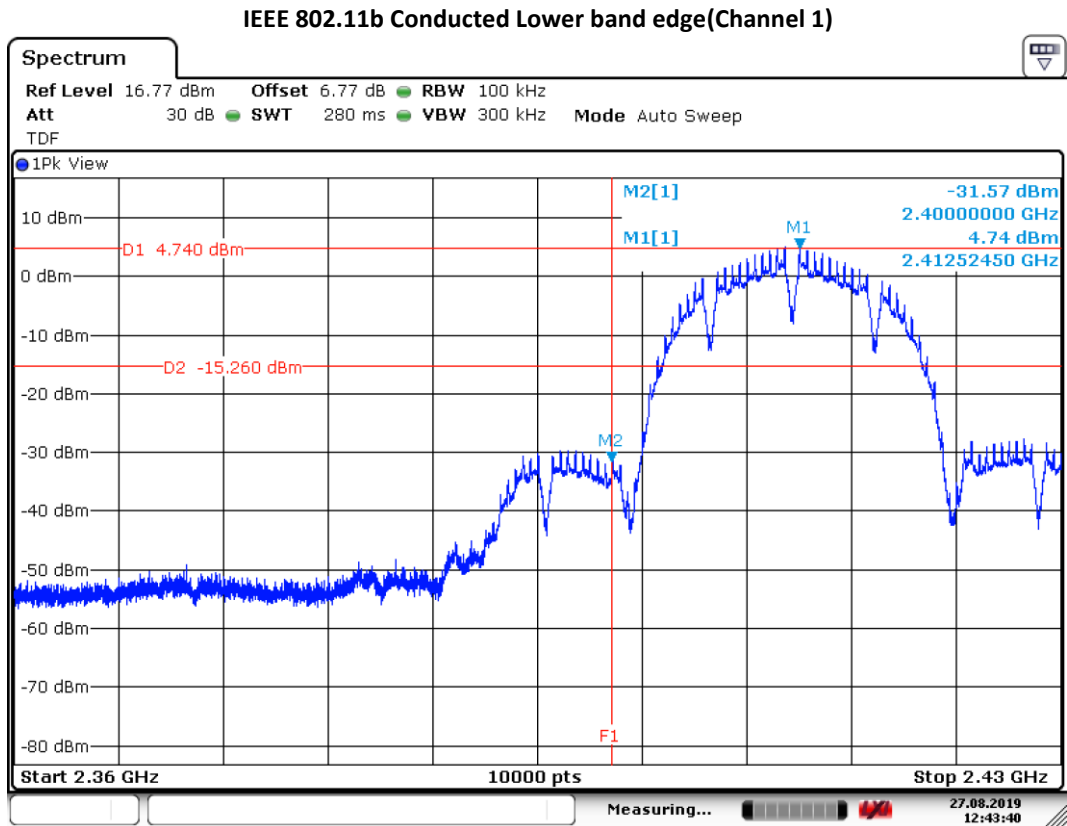

IEEE 802.11g Conducted Lower band edge(Channel 1)

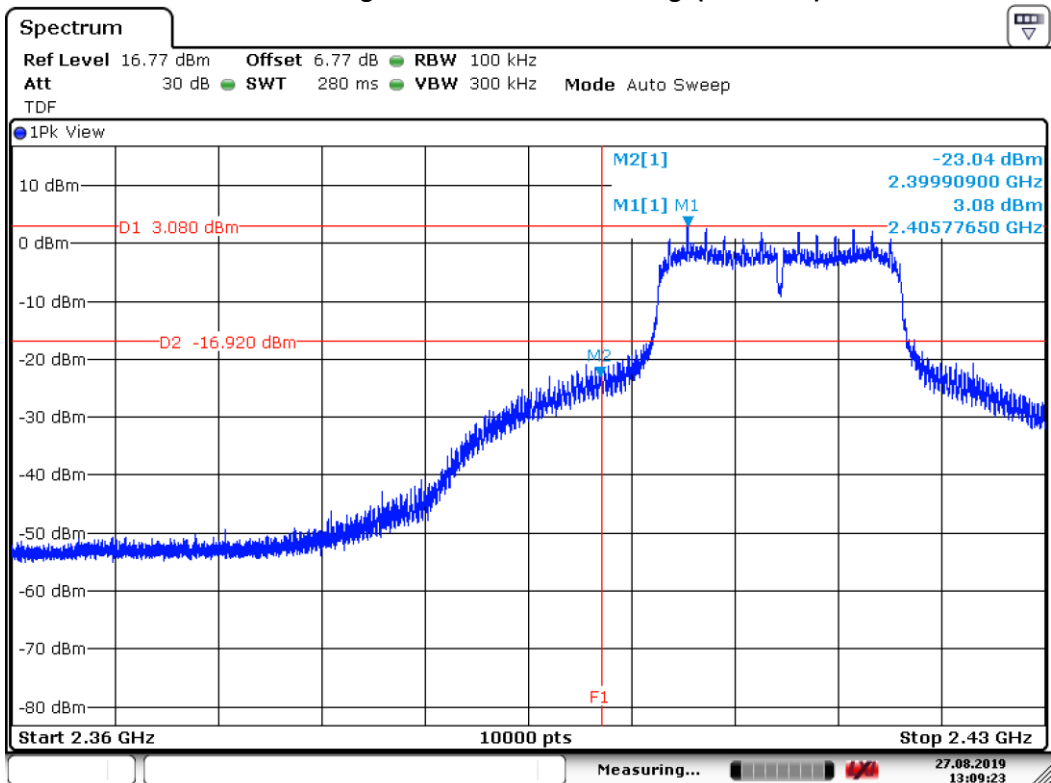

IEEE 802.11g Conducted upper band edge(Channel 11)

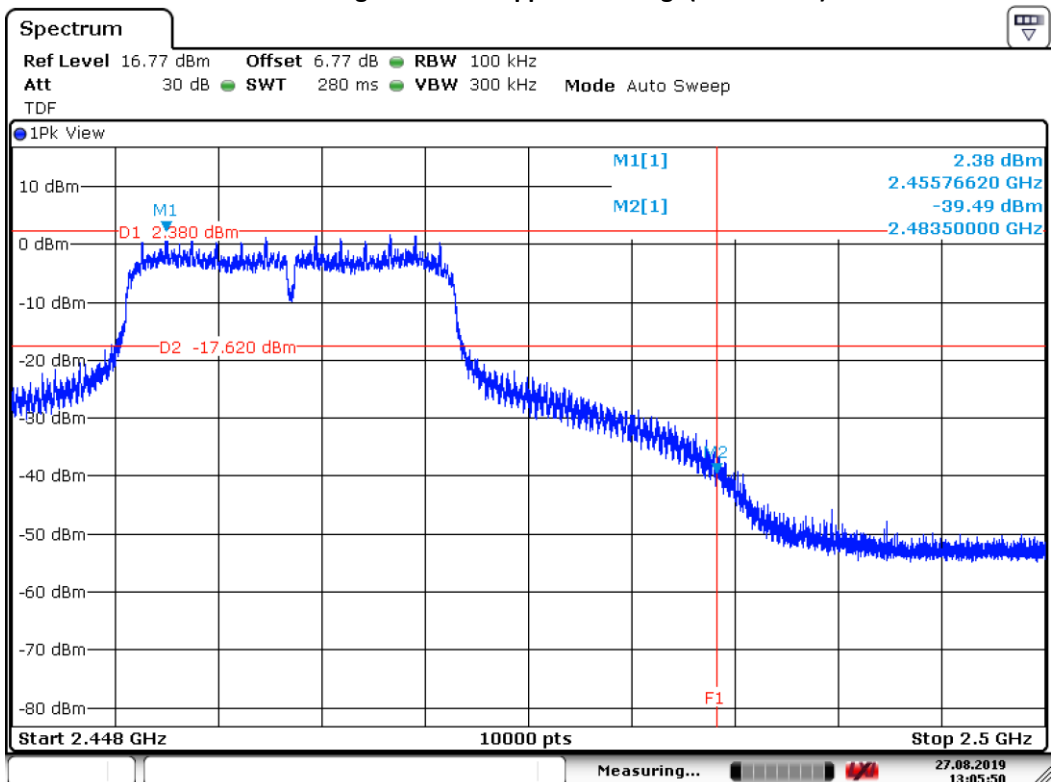

IEEE 802.11n Conducted Lower band edge(Channel 1)

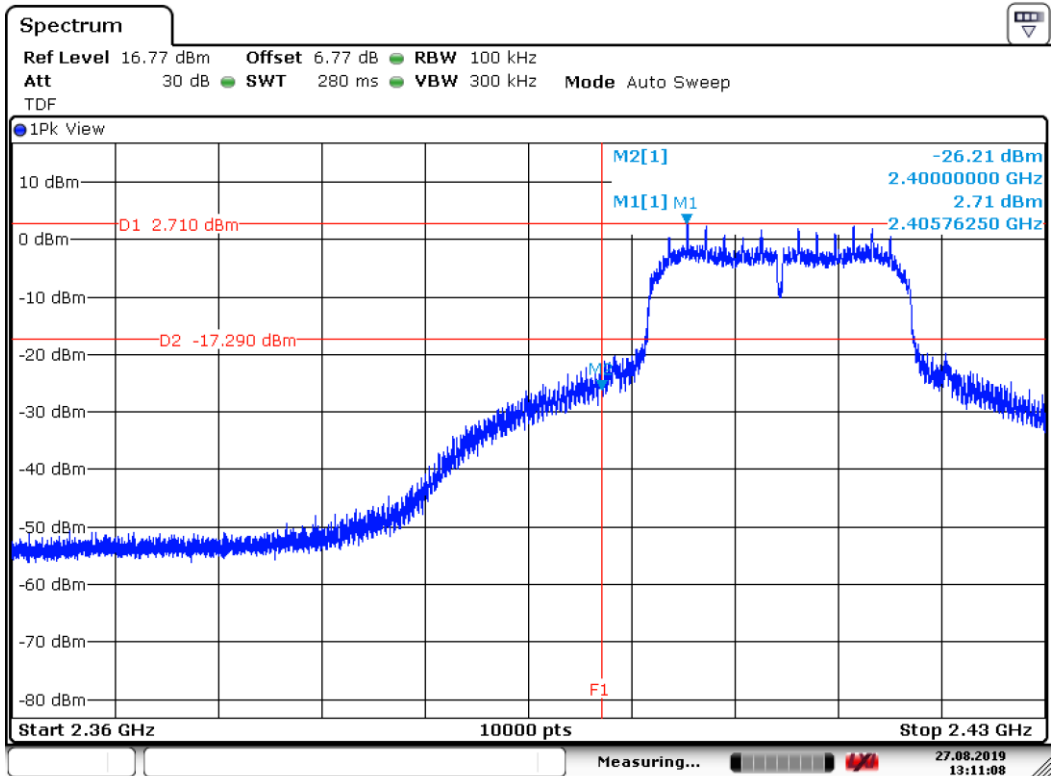

IEEE 802.11n Conducted Upper band edge(Channel 11)

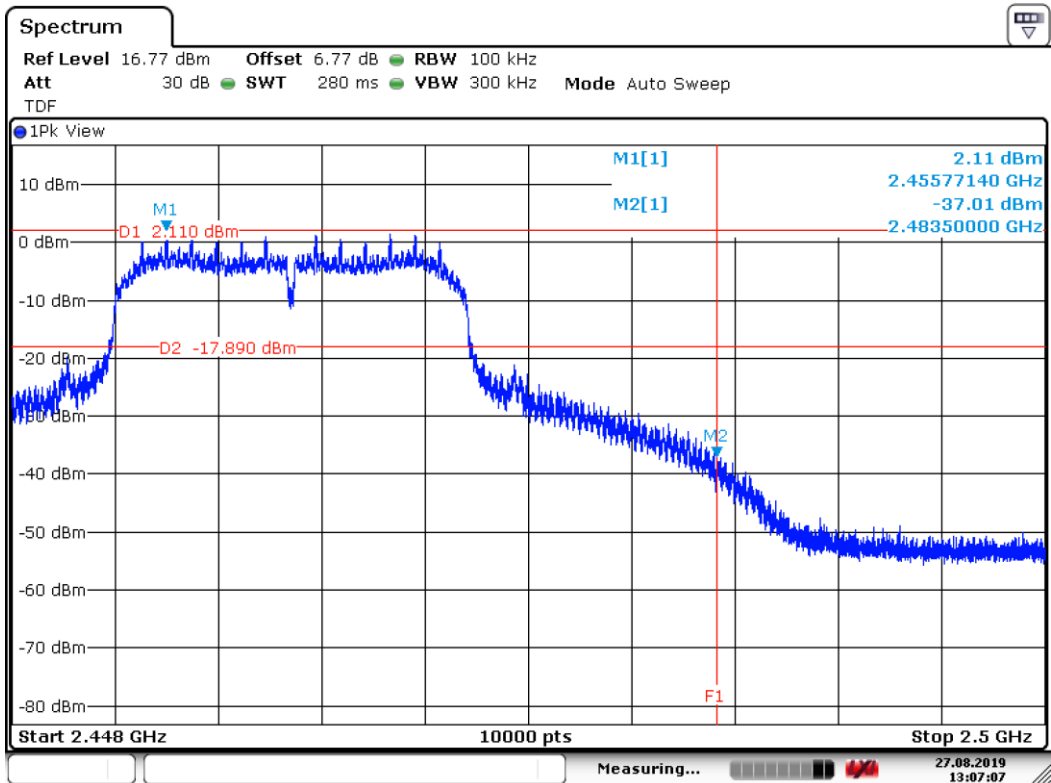

3.6 Radiated Spurious Emissions Measurement

3.6.1 Limit

The emissions from an intentional radiator shall not exceed the field strength levels specified in the following table:

15.209

Frequency (MHz)	Field strength ($\mu\text{V/m}$)	Measurement distance(m)
0.009 – 0.490	2400/F(kHz)	300
0.490 – 1.705	24000/F(kHz)	30
1.705 - 30	30	30
30 -88	100	3
88 - 216	150	3
216-960	200	3
Above 960	500	3

3.6.2 Measurement instruments

The measurement instruments are listed in chapter 2.4 of this report.

3.6.3 Test setup

The test setup is as shown in chapter 2.3 of this report.

3.6.4 Test procedure

The emission limits shown in the above table are based on measurements employing a CISPR quasi-peak detector except for the frequency bands 9–90 kHz, 110–490 kHz and above 1000 MHz. Radiated emission limits in these three bands are based on measurements employing an average detector.

Other details are according to KDB Publication 558074 V05

IRN 026 - Radiated electrical disturbance (V per m) Method 1 – 30 MHz – 1 GHz in SAR.

IRN 026 - Radiated electrical disturbance (V per m) Method 2 – 1 - 18 GHz in SAR.

IRN 026 - Radiated electrical disturbance (V per m) Method 3 – 18 - 26.5 GHz in SAR.

IRN 027 - Radiated magnetic disturbance Method 1 – Loop antenna

3.6.5 Notes

- In the frequency range of 1 – 26 GHz the green trace is measured using a peak detector and the red trace is measured using an average detector. The top limit line represent the peak limit and the bottom limit represents the average limit
- in the frequency range of 9 kHz to 30 MHz all emissions are 20 dB below the limit and are therefore not reported.

3.6.6 Plots of the Radiated Spurious Emissions

802.11b

30 MHz to 1 GHz

Vertical polarization

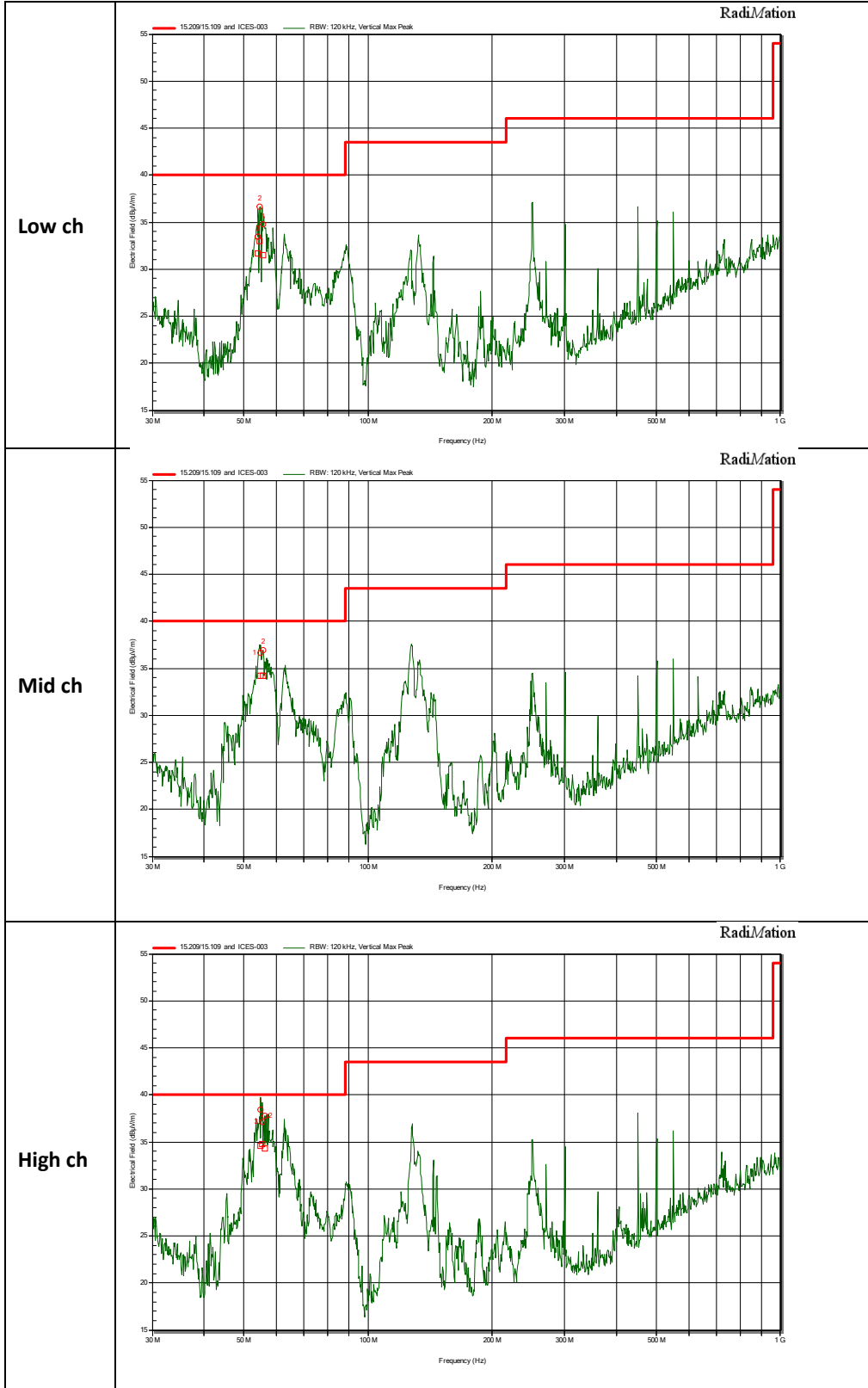

Measured peaks vertical low channel

Frequency	Peak	Quasi-Peak	Quasi-Peak Limit	Angle	Height
54,149 MHz	33,5 dB μ V/m	31,6 dB μ V/m	40 dB μ V/m	115 degrees	1,5 m
54,667 MHz	36,6 dB μ V/m	33 dB μ V/m	40 dB μ V/m	314 degrees	1,5 m
55,616 MHz	34,7 dB μ V/m	31,5 dB μ V/m	40 dB μ V/m	314 degrees	1,5 m

Measured peaks vertical mid channel

Frequency	Peak	Quasi-Peak	Quasi-Peak Limit	Angle	Height
54,798 MHz	36,6 dB μ V/m	34,2 dB μ V/m	40 dB μ V/m	267 degrees	1 m
55,638 MHz	36,9 dB μ V/m	34,2 dB μ V/m	40 dB μ V/m	267 degrees	1 m

Measured vertical high channel

Frequency	Peak	Quasi-Peak	Quasi-Peak Limit	Angle	Height
54,767 MHz	38,4 dB μ V/m	34,6 dB μ V/m	40 dB μ V/m	238 degrees	1,01 m
55,45 MHz	37,1 dB μ V/m	34,7 dB μ V/m	40 dB μ V/m	238 degrees	1,01 m

802.11b
30 MHz to 1 GHz

Horizontal polarization

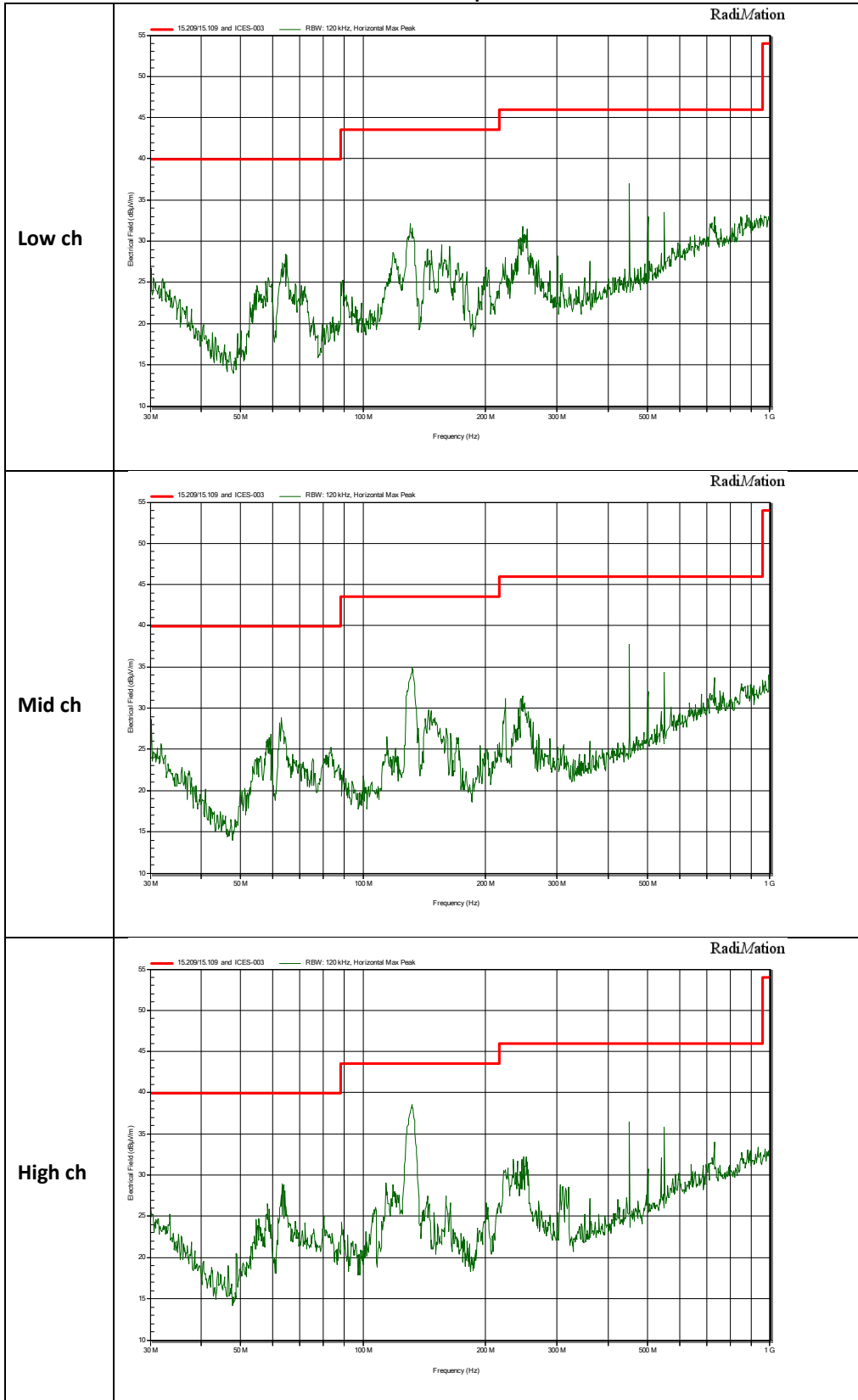

802.11g
30 MHz to 1 GHz

Vertical polarization

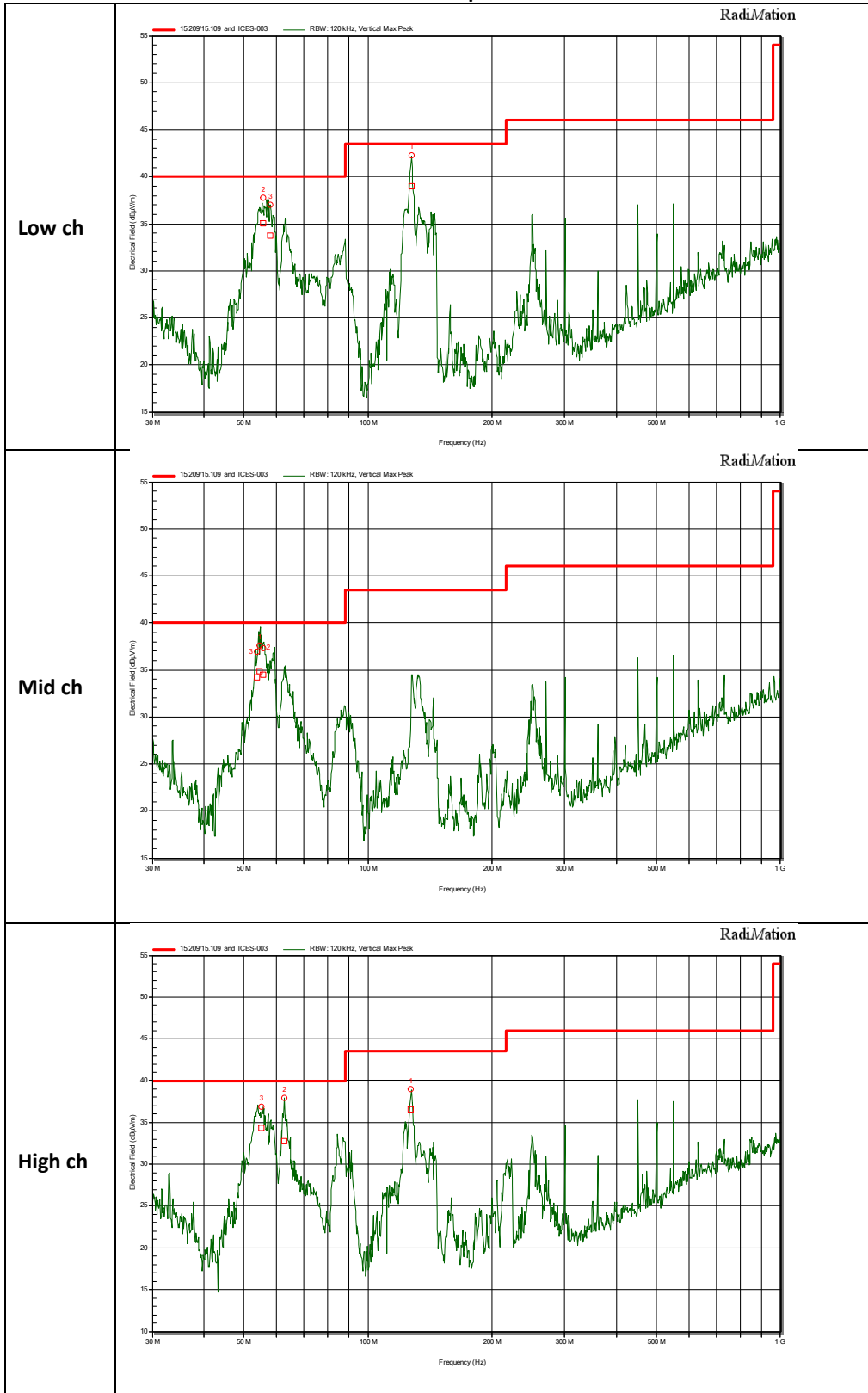

Measured peaks Vertical low channel

Frequency	Peak	Quasi-Peak	Quasi-Peak Limit	Angle	Height
55,713 MHz	37,8 dB μ V/m	35 dB μ V/m	40 dB μ V/m	221 degrees	1 m
57,863 MHz	37 dB μ V/m	33,7 dB μ V/m	40 dB μ V/m	221 degrees	1 m
127,454 MHz	42,2 dB μ V/m	39 dB μ V/m	43,5 dB μ V/m	14 degrees	1 m

Measured peaks Vertical mid channel

Frequency	Peak	Quasi-Peak	Quasi-Peak Limit	Angle	Height
53,853 MHz	37 dB μ V/m	34,2 dB μ V/m	40 dB μ V/m	217 degrees	1 m
54,58 MHz	37,6 dB μ V/m	34,9 dB μ V/m	40 dB μ V/m	217 degrees	1 m
55,701 MHz	37,3 dB μ V/m	34,4 dB μ V/m	40 dB μ V/m	217 degrees	1 m

Measured peaks Vertical high channel

Frequency	Peak	Quasi-Peak	Quasi-Peak Limit	Angle	Height
55,219 MHz	36,9 dB μ V/m	34,4 dB μ V/m	40 dB μ V/m	201 degrees	1 m
62,574 MHz	38 dB μ V/m	32,8 dB μ V/m	40 dB μ V/m	201 degrees	1 m
126,998 MHz	39 dB μ V/m	36,5 dB μ V/m	43,5 dB μ V/m	47 degrees	1,5 m

802.11g
30 MHz to 1 GHz

Horizontal polarization

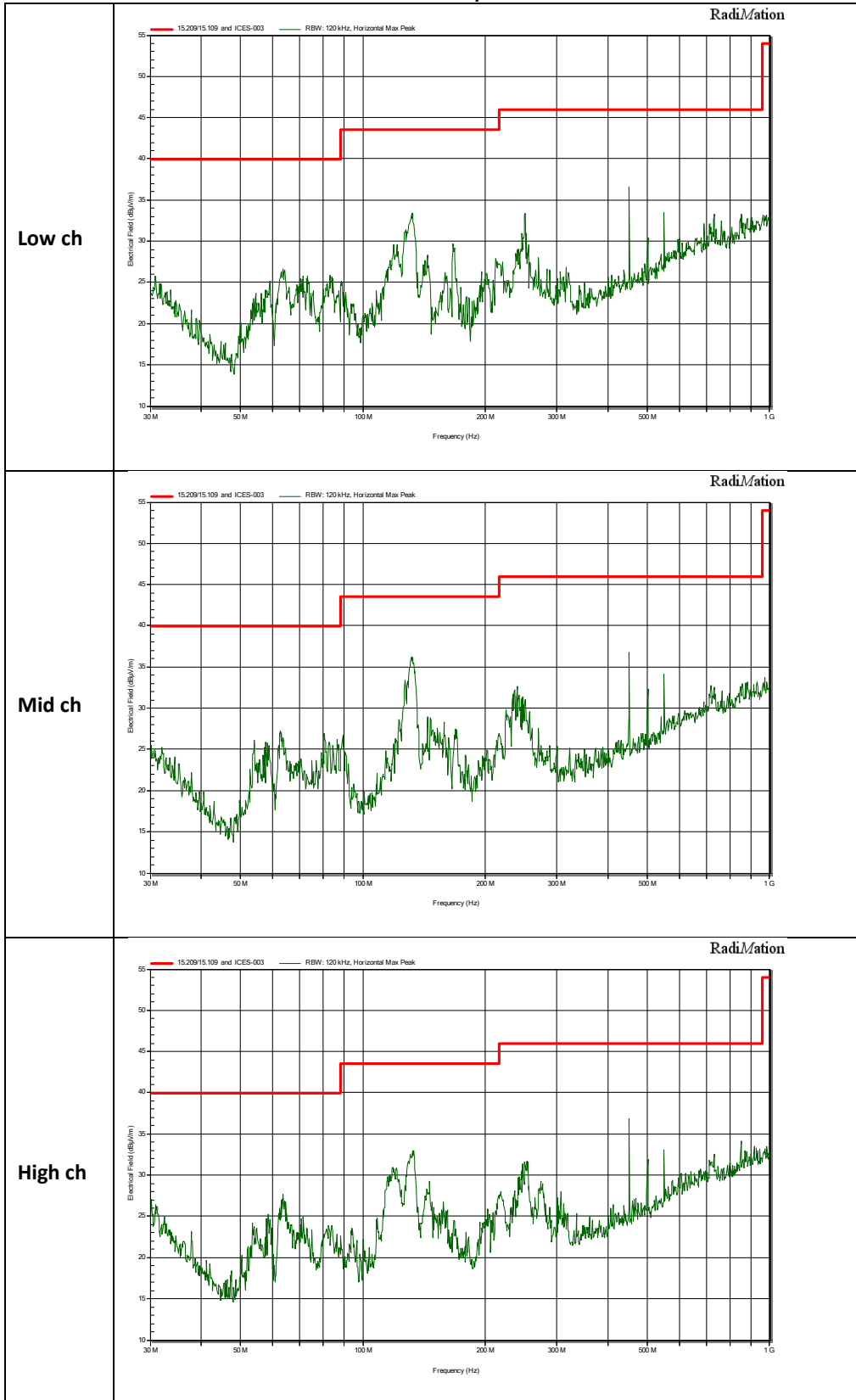

802.11n
30 MHz to 1 GHz

Vertical polarization

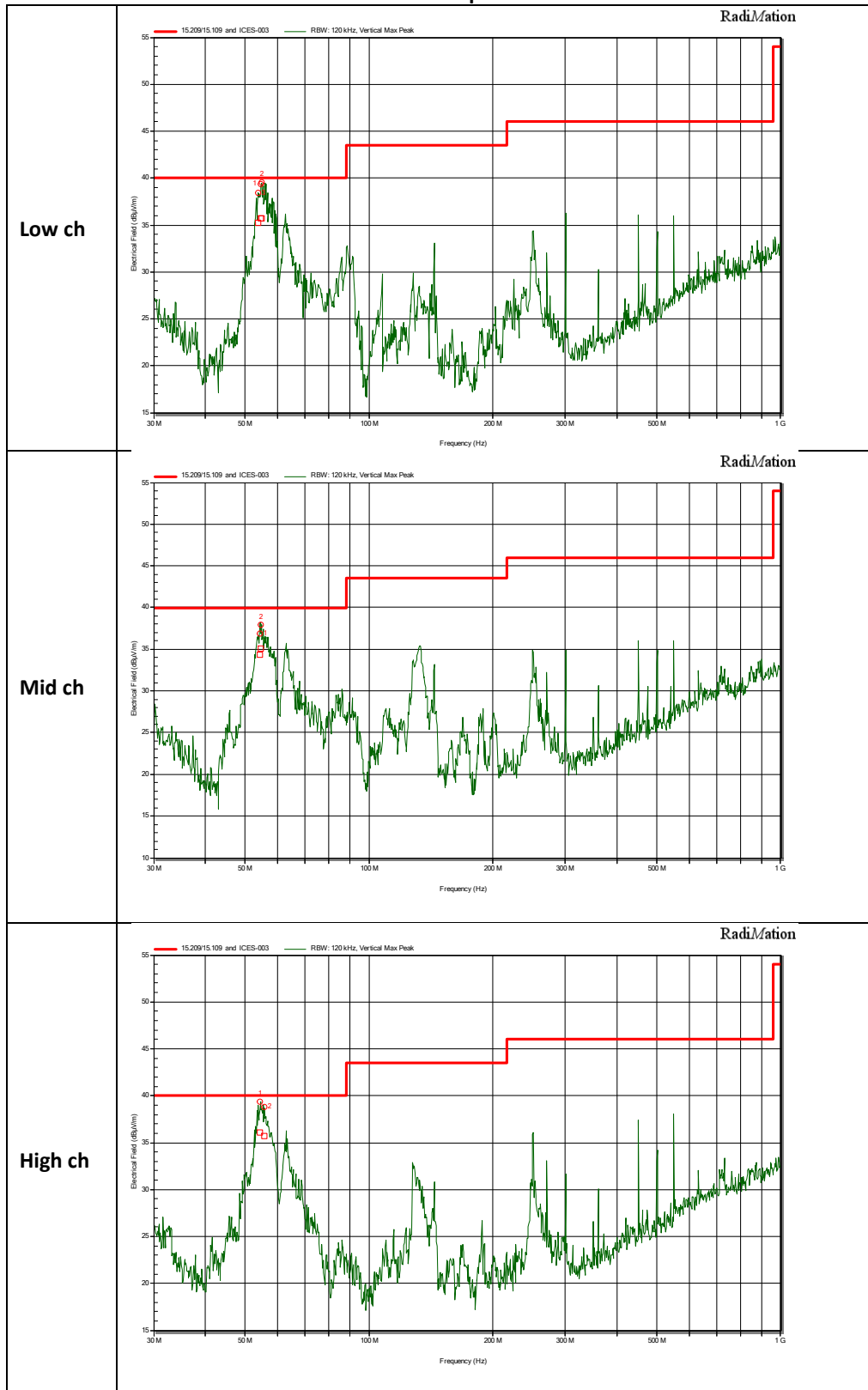

Measured peaks vertical low channel

Frequency	Peak	Quasi-Peak	Quasi-Peak Limit	Angle	Height
53,709 MHz	38,4 dB μ V/m	35,2 dB μ V/m	40 dB μ V/m	223 degrees	1 m
54,565 MHz	39,4 dB μ V/m	35,7 dB μ V/m	40 dB μ V/m	189 degrees	1 m
54,968 MHz	39,5 dB μ V/m	35,7 dB μ V/m	40 dB μ V/m	189 degrees	1 m

Measured peaks vertical mid channel

Frequency	Peak	Quasi-Peak	Quasi-Peak Limit	Angle	Height
54,31 MHz	36,9 dB μ V/m	34,4 dB μ V/m	40 dB μ V/m	175 degrees	1,5 m
54,706 MHz	37,9 dB μ V/m	35,1 dB μ V/m	40 dB μ V/m	208 degrees	1,5 m

Measured peaks vertical high channel

Frequency	Peak	Quasi-Peak	Quasi-Peak Limit	Angle	Height
54,402 MHz	39,4 dB μ V/m	36 dB μ V/m	40 dB μ V/m	179 degrees	1 m
55,592 MHz	38,8 dB μ V/m	35,7 dB μ V/m	40 dB μ V/m	195 degrees	1 m

802.11n
30 MHz to 1 GHz

Horizontal polarization

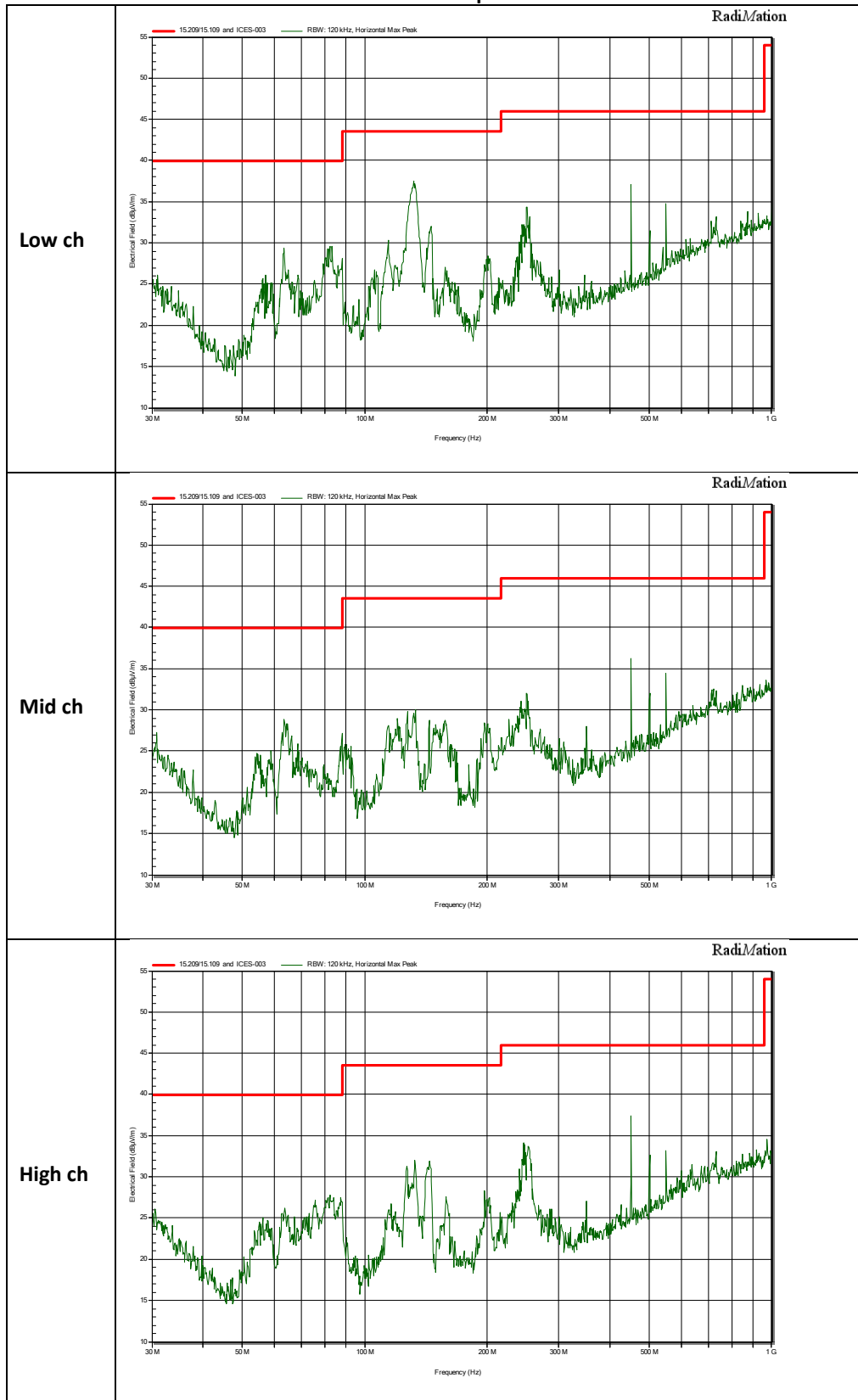

802.11b
1 GHz to 18 GHz

Vertical polarization

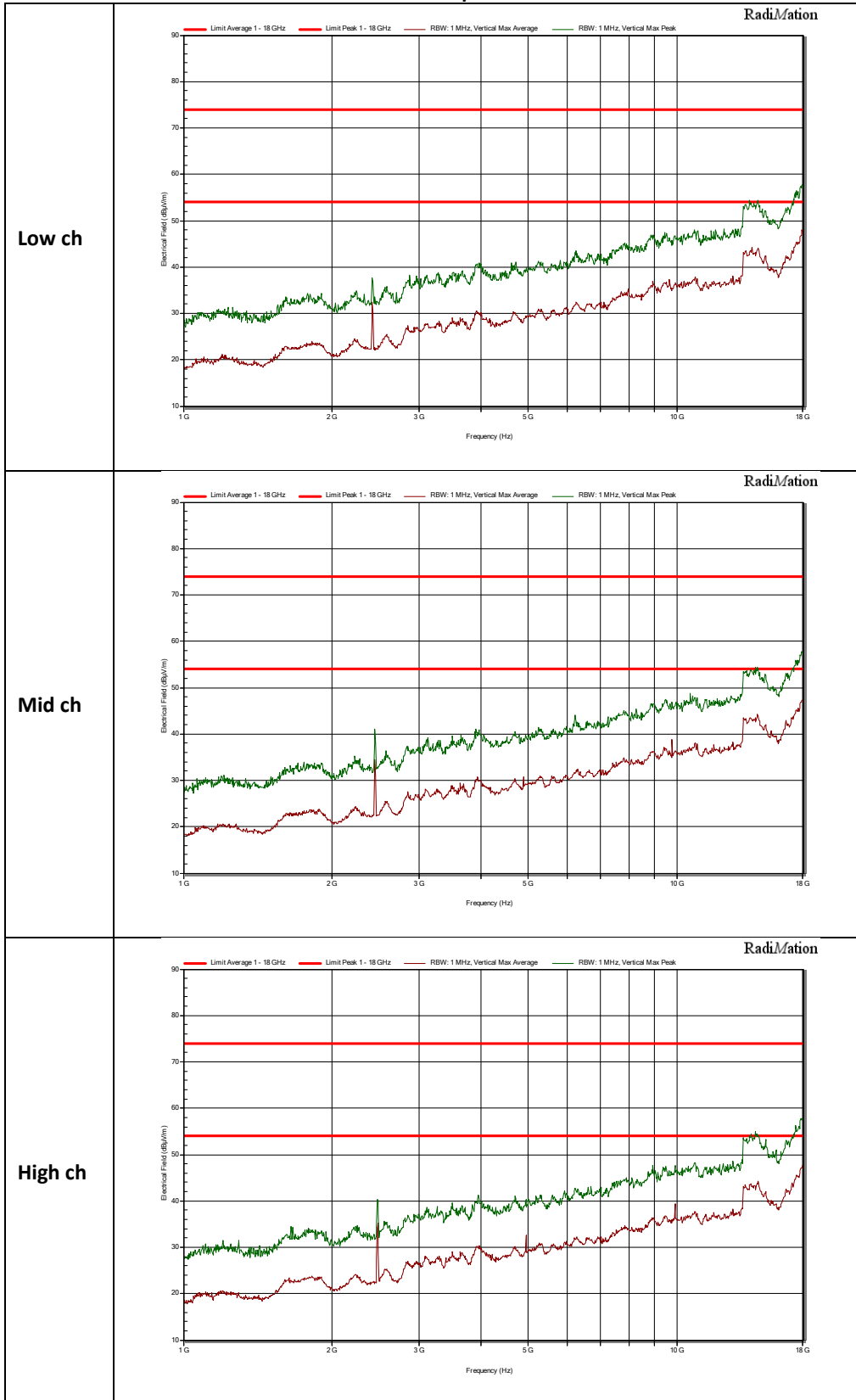

1 GHz to 18 GHz

Horizontal polarization

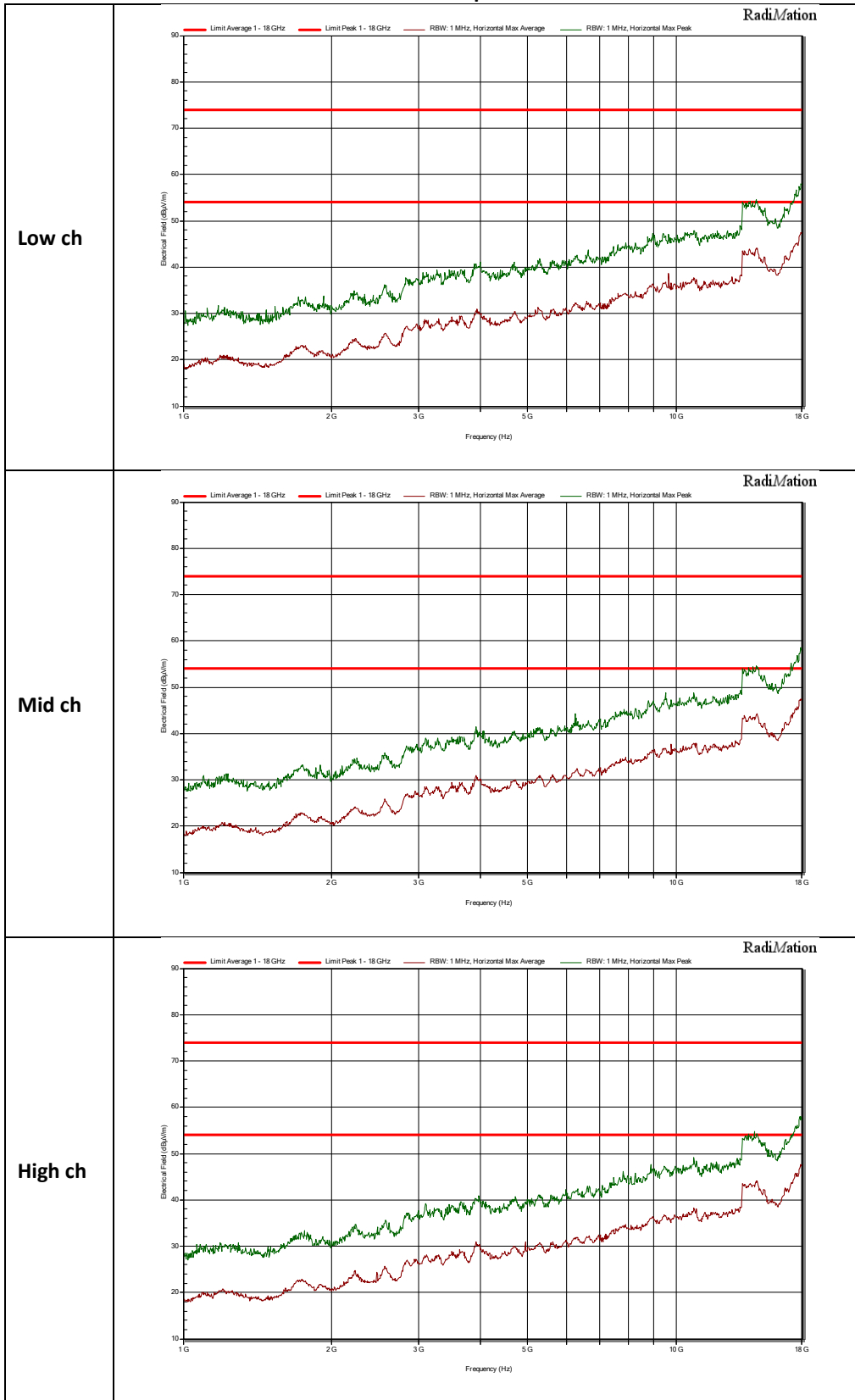

802.11g
1 GHz to 18 GHz

Vertical polarization

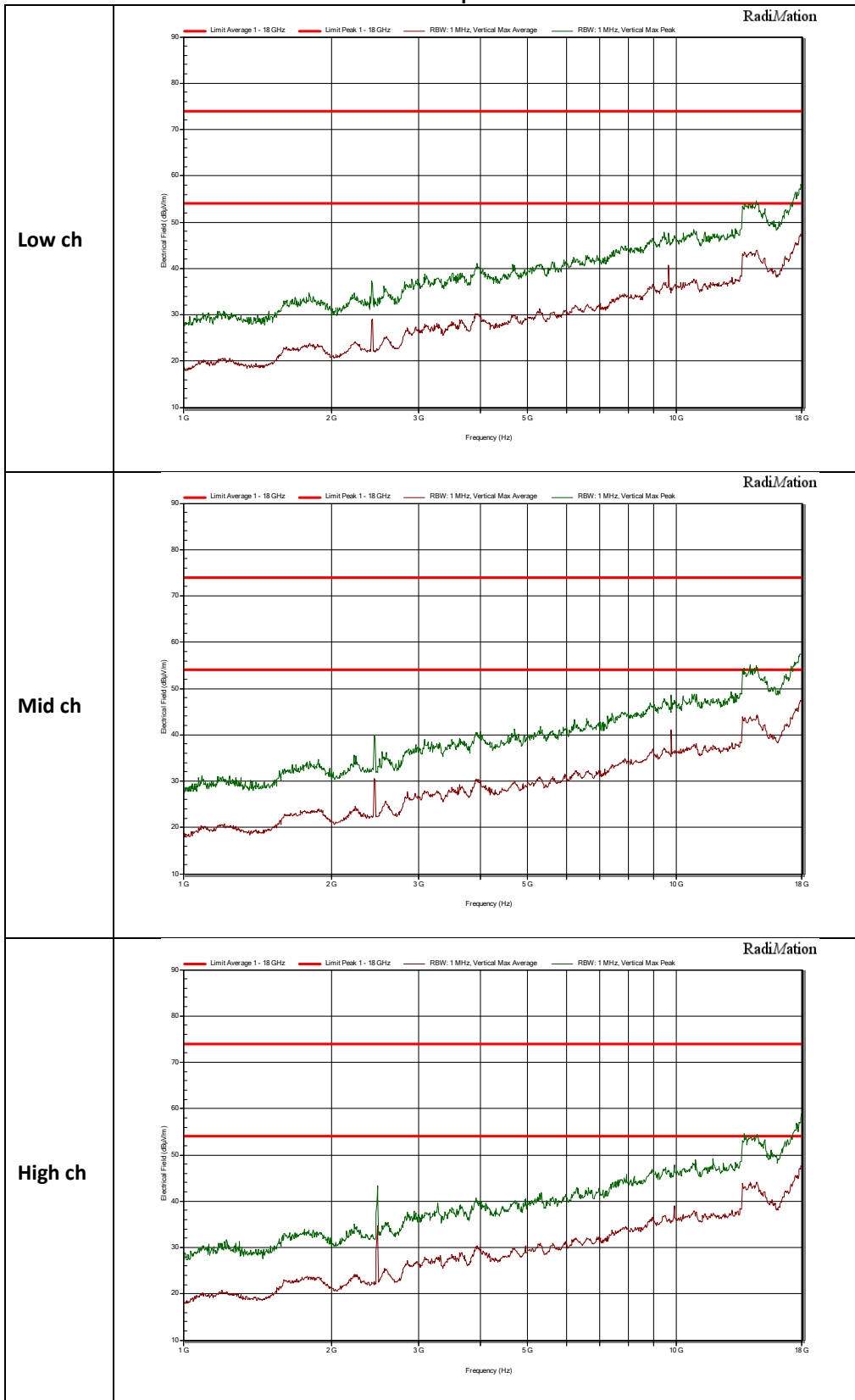

802.11g
1 GHz to 18 GHz

Horizontal polarization

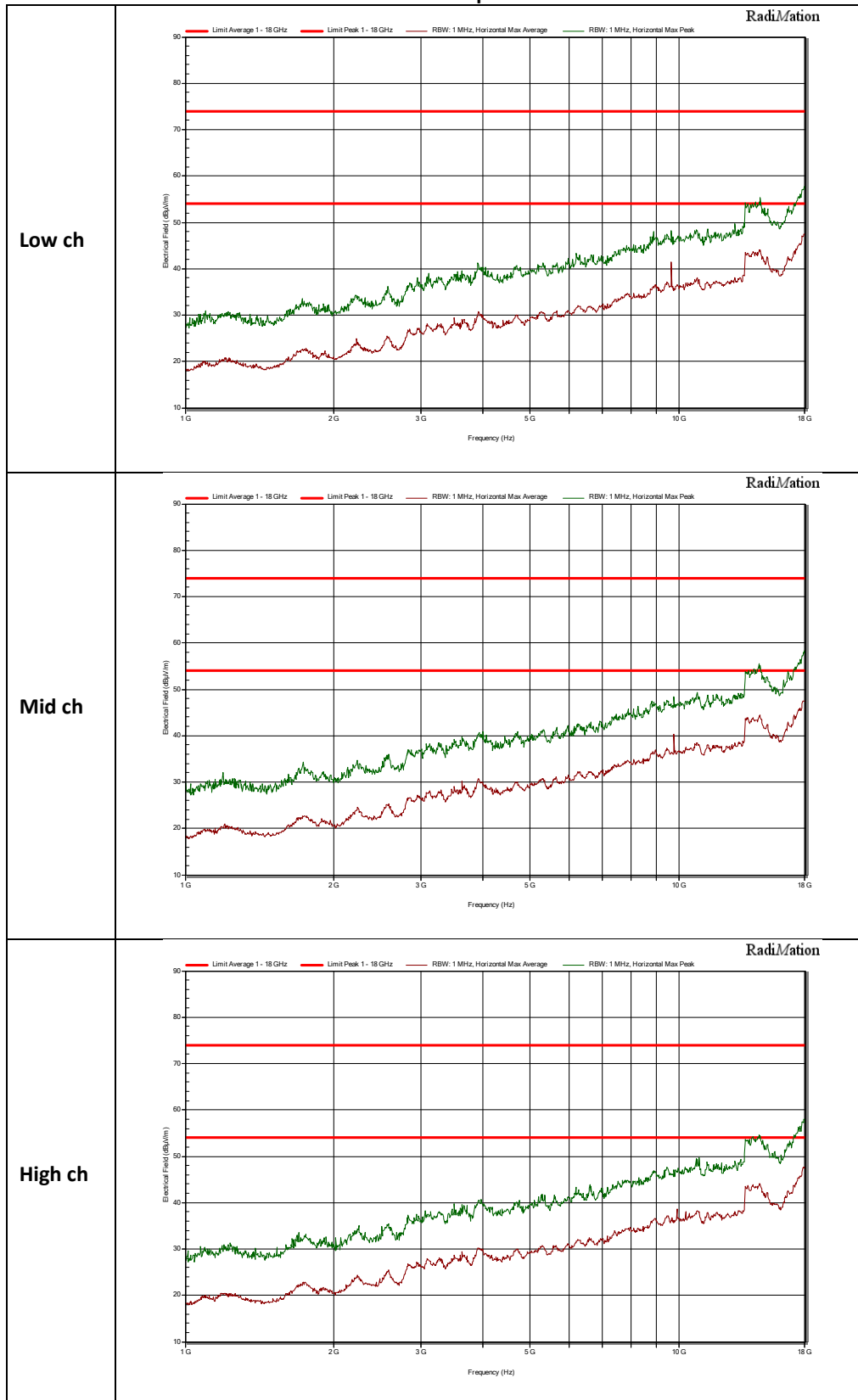

802.11n
1 GHz to 18 GHz

Vertical polarization

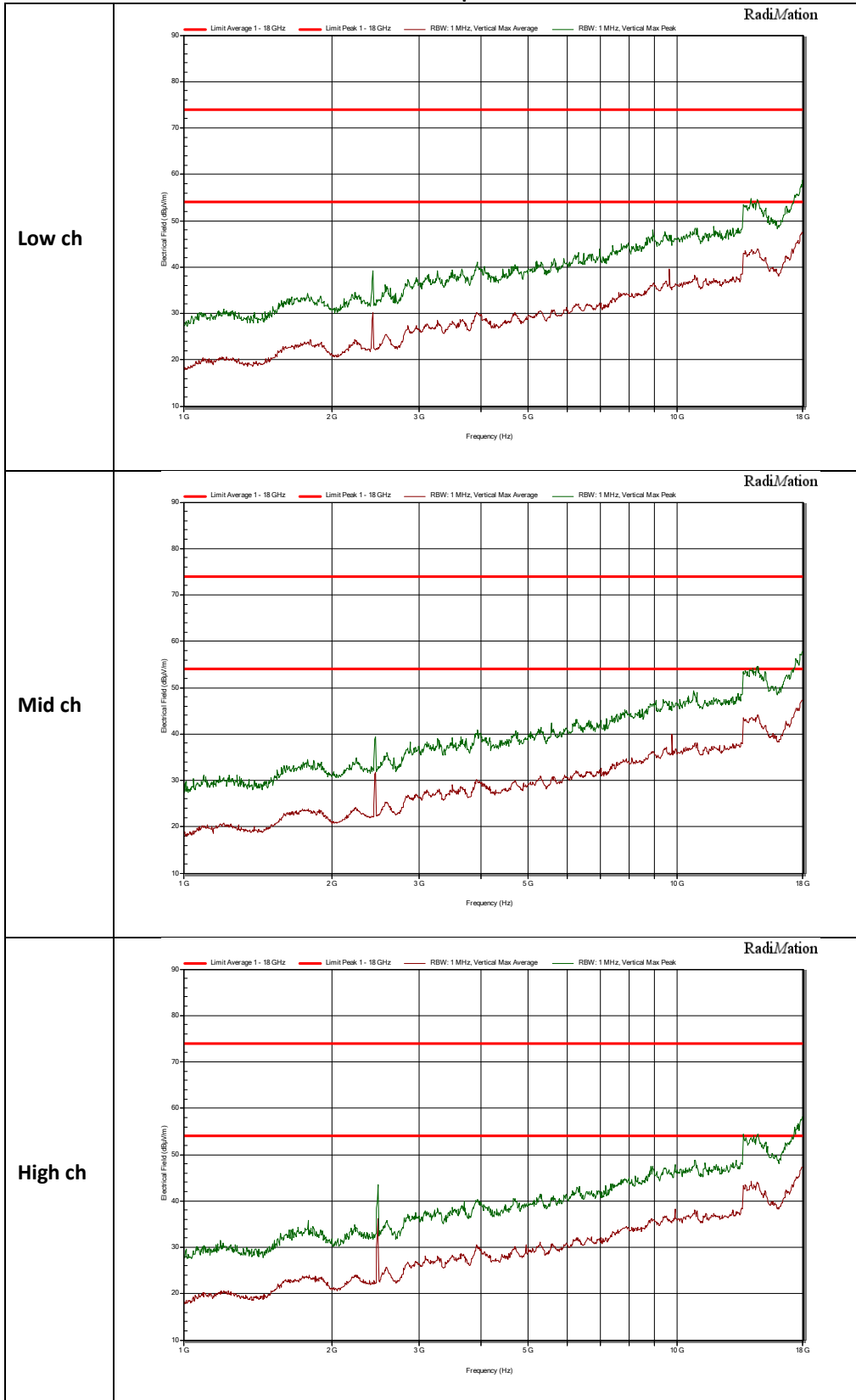

802.11n
1 GHz to 18 GHz

Horizontal polarization

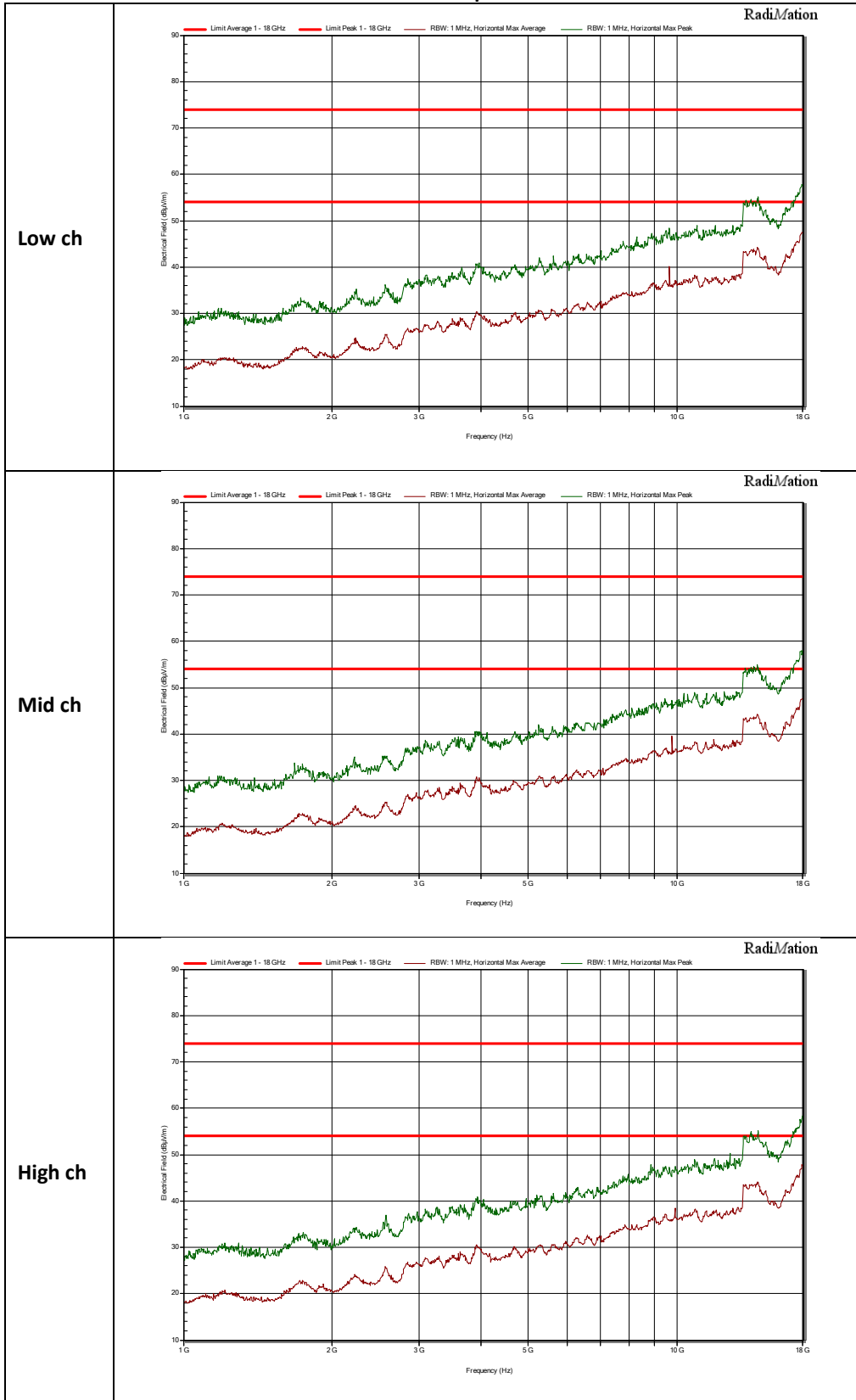

802.11b
18 GHz to 26 GHz

Vertical polarization

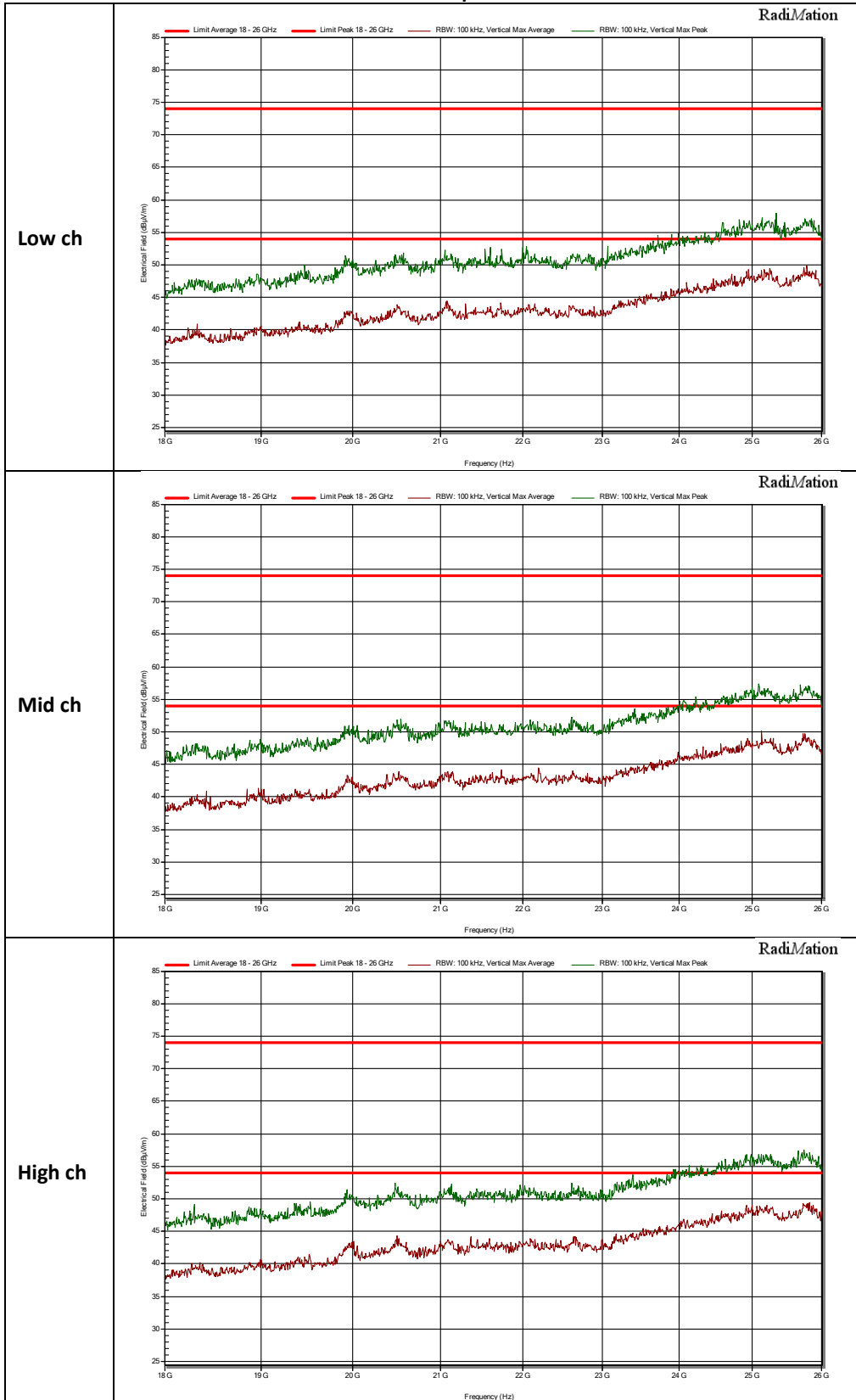

802.11b
18 GHz to 26 GHz

Vertical polarization

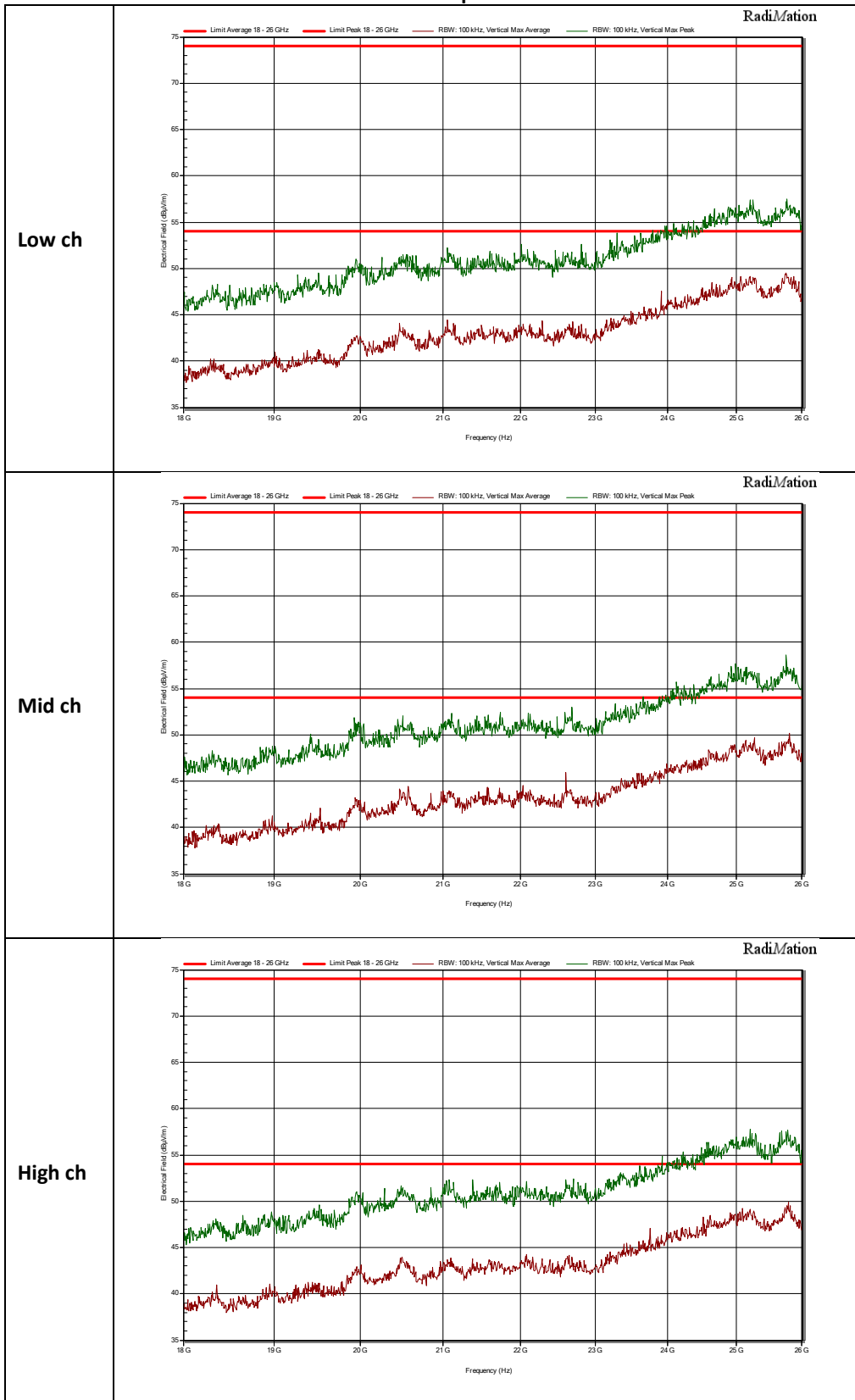

802.11b
18 GHz to 26 GHz

Horizontal polarization

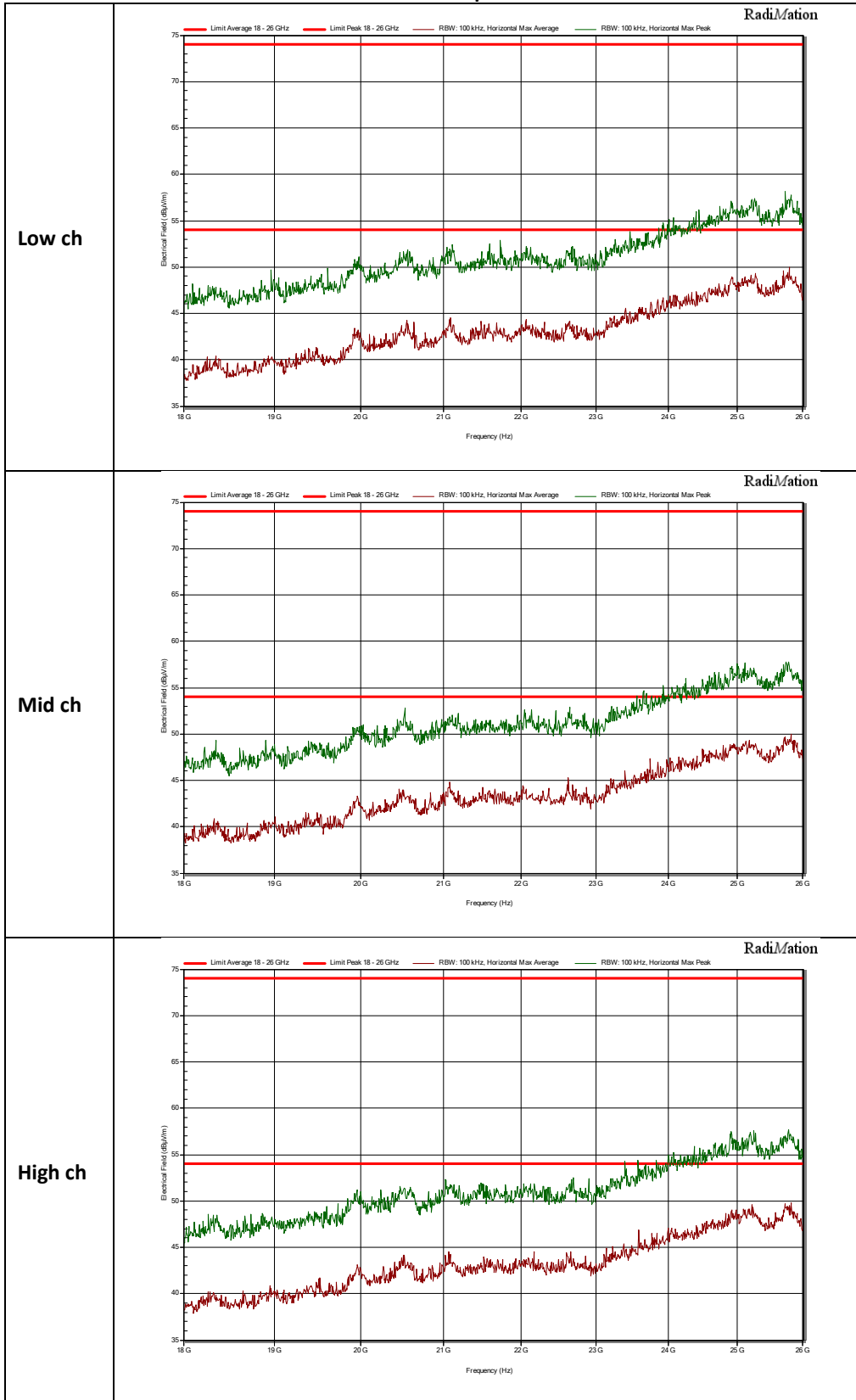

802.11g
18 GHz to 26 GHz

Vertical polarization

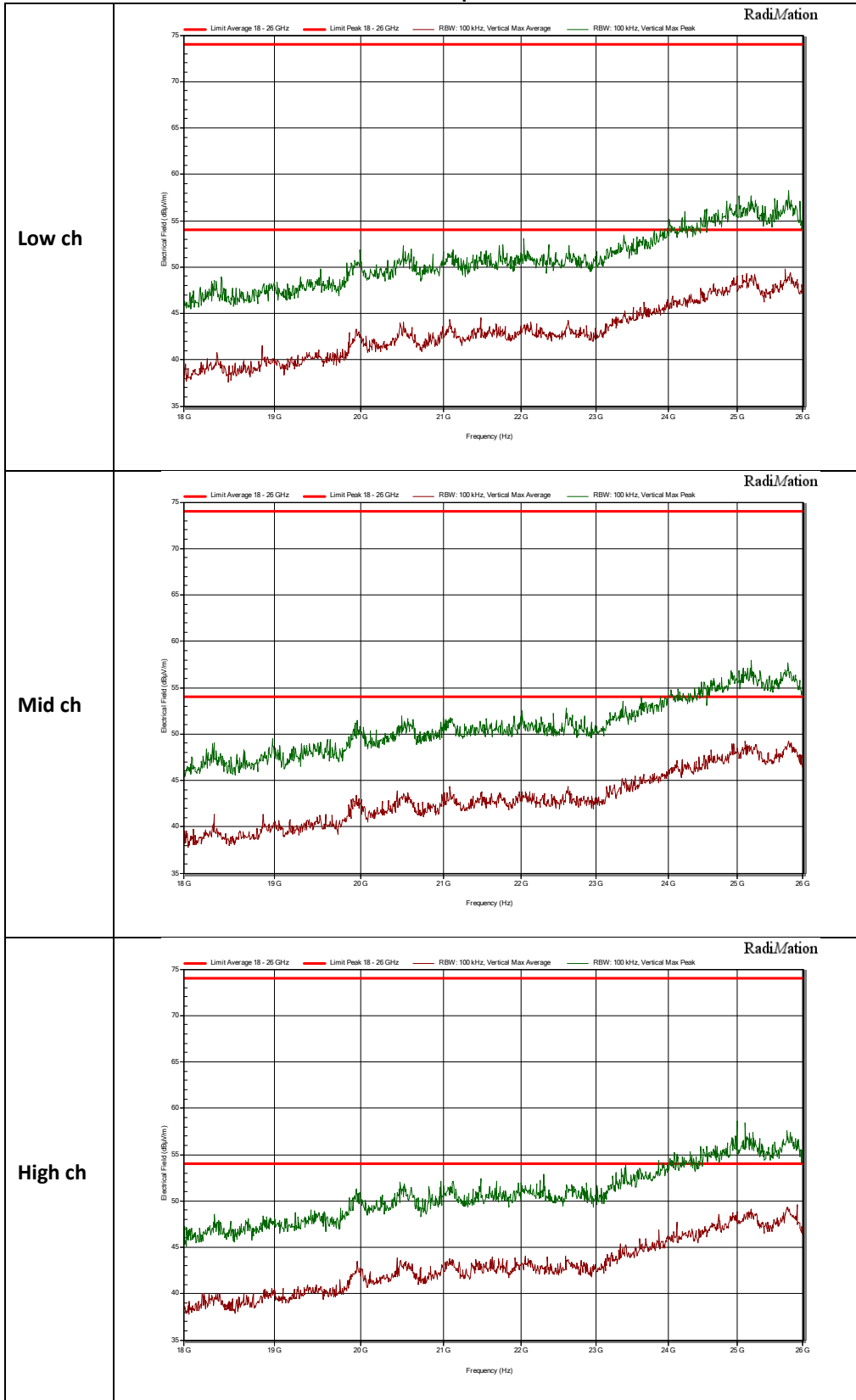

802.11g
18 GHz to 26 GHz

Horizontal polarization

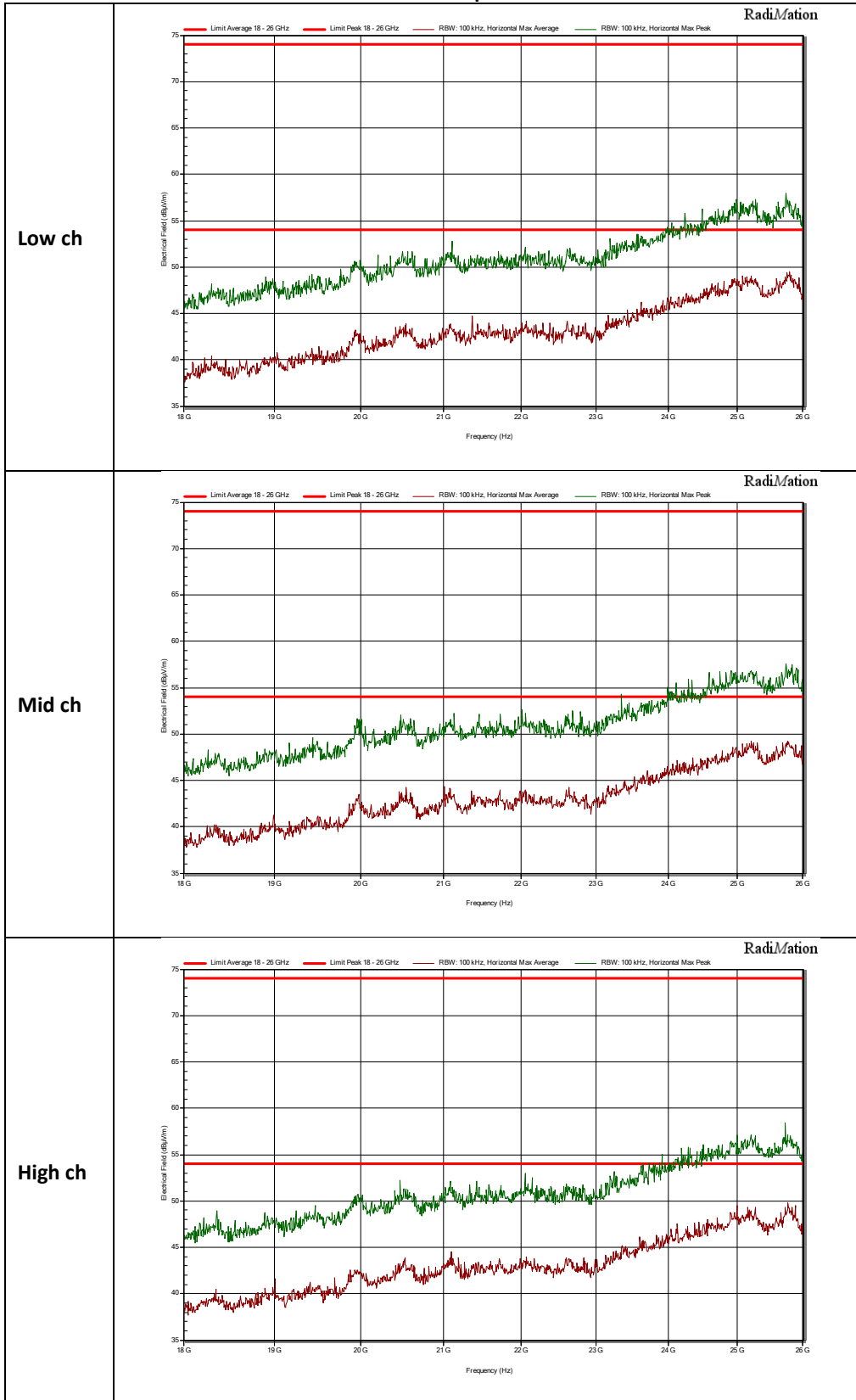

802.11n
18 GHz to 26 GHz

Vertical polarization

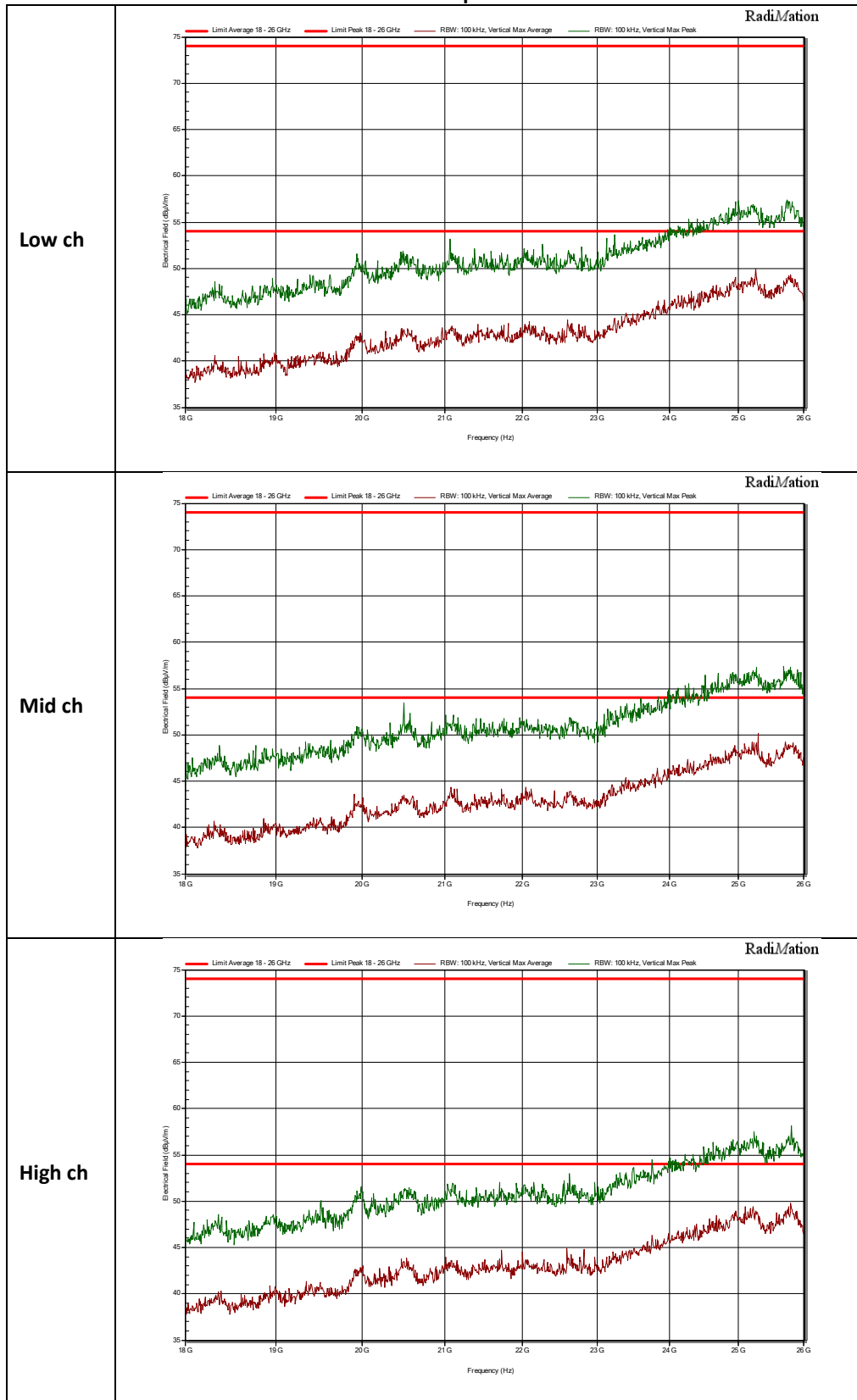

802.11n
18 GHz to 26 GHz

Horizontal polarization

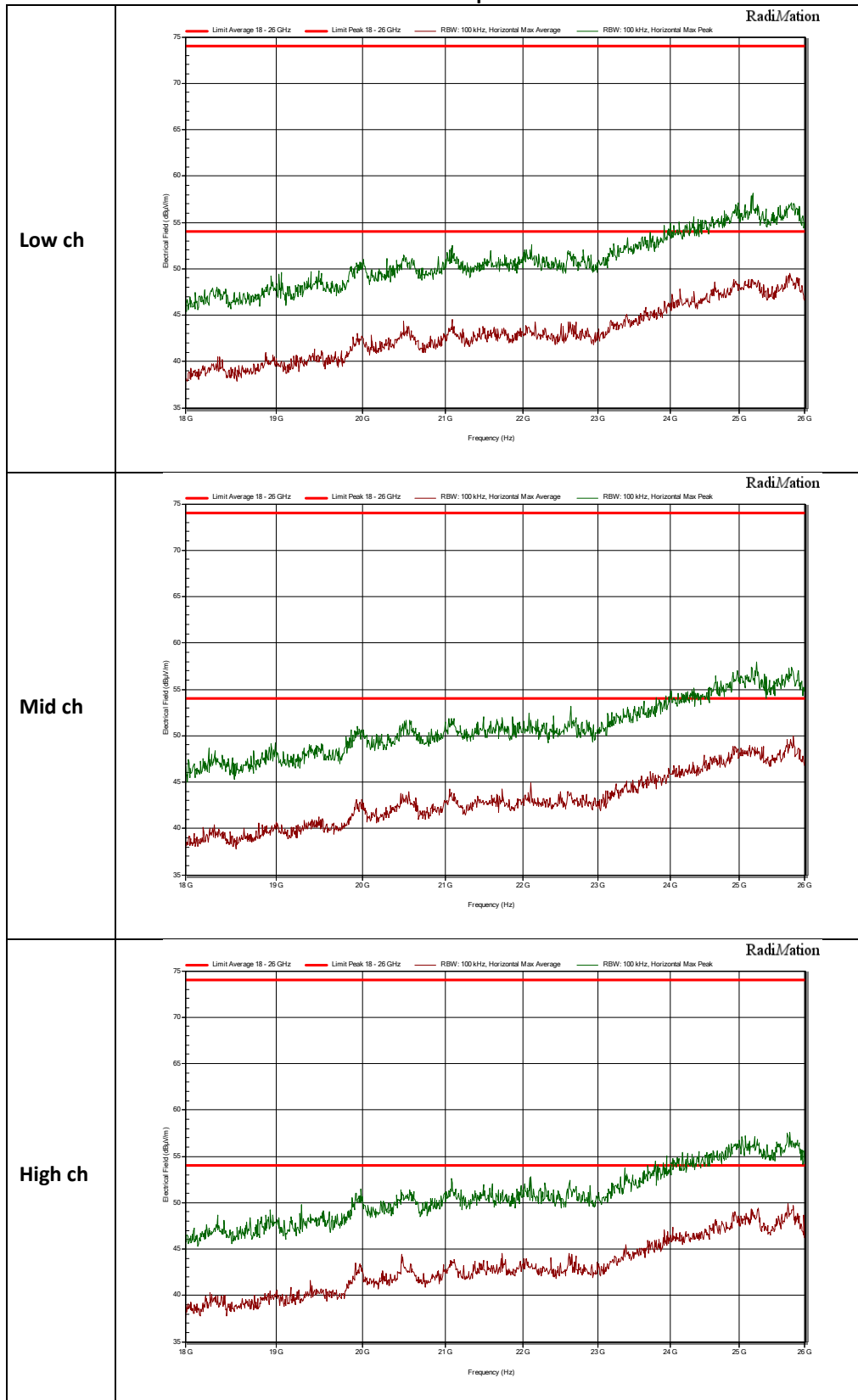

3.6.7 Measurement Uncertainty

Measurement uncertainty Radiated emissions below 1 GHz

Horizontal polarization	
9 kHz – 30 MHz	+1.5 dB/-1.6dB
30 – 200 MHz	4.5 dB
200 – 1000 MHz	3.6 dB
Vertical polarization	
9 kHz – 30 MHz	+1.5 dB/-1.6dB
30 – 200 MHz	5.4 dB
200 – 1000 MHz	4.6 dB

Measurement uncertainty Radiated emissions above 1 GHz

1000- 18000 MHz	5.7 dB
18000 – 26000 MHz	4.9 dB

3.7 AC conducted mains measurement

3.7.1 Limit

According to 15.207 (c).

An intentional radiator that is designed to be connected to the public utility (AC) power line, the radio frequency voltage that is conducted back onto the AC power line on any frequency or frequencies, within the band 150 kHz to 30 MHz, shall not exceed the limits in the following table.

Frequency of emission (MHz)	Conducted limit (dB μ V)	
	Quasi-peak	Average
0.15–0.5	66 to 56*	56 to 46*
0.5–5	56	46
5–30	60	50

*Decreases with the logarithm of the frequency.

3.7.2 Measurement instruments

The measurement instruments are listed in chapter 2.4 of this report.

3.7.3 Test setup

The test setup is as shown in chapter 2.3 of this report.

3.7.4 Test procedure

According to ANSI C63.4: 2014, section 13.3.

IRN 029 - Conducted disturbance (V) Method 1 – AC mains conducted disturbance.

3.7.5 Test results and plots of the AC conducted mains measurement

The test results can be found on the next page.

3.7.6 Measurement uncertainty

+/- 3.6 dB.

3.7.7 Plots of the AC conducted spurious measurement

Phase

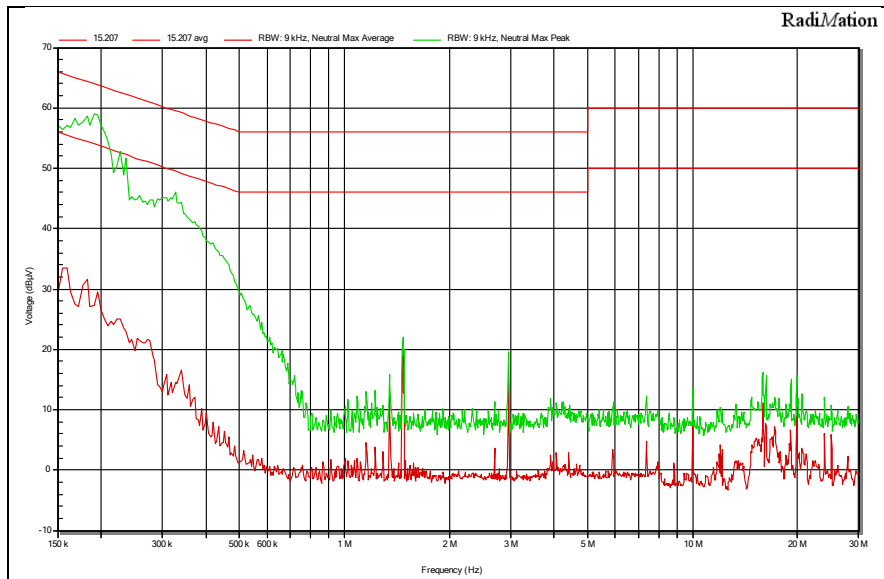

Neutral

