

Uface 1

(OS-K21-11901)



Please read this manual carefully before use

Device Appearance Unit: mm

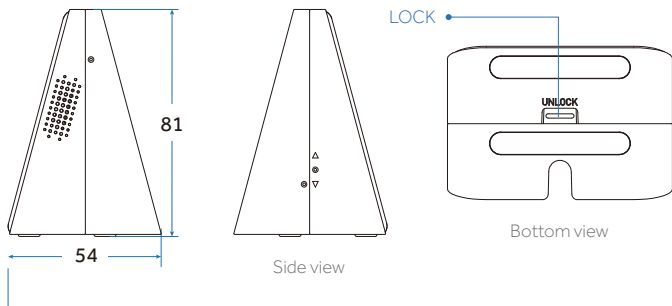
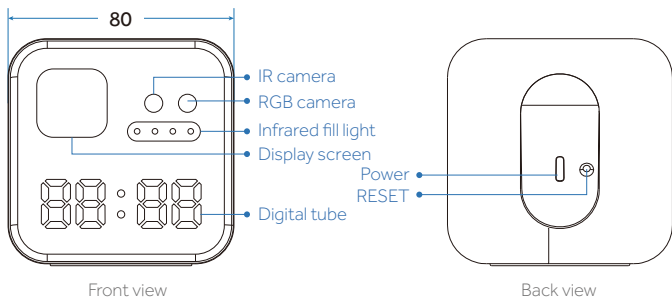

Product List

- 1 Device
- 2 Support
- 3 Power cable
- 4 Rubber foot
- 5 User guide
- 6 Screws
- 7 Expansion pipes
- 8 Power adapter (optional)

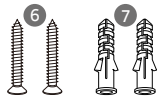
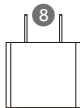
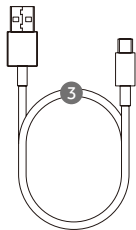
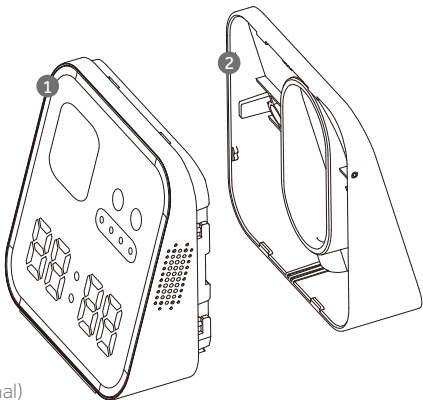

Fastening Method

Method 1

Put the bottom side of device and support down, move the support to align the round icon with the device, gather up the two parts and push the support downside to fasten.

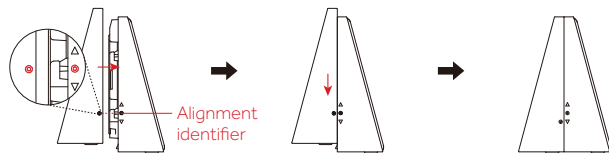

Method 2

Put the bottom side of support up, move the support to align the round icon with the device, gather up the two parts and push the support downside to fasten.

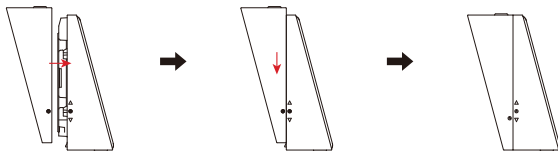

Unlock Method

Toggle the hasp on the device bottom outwards, hold the two main parts together to push and unlock.

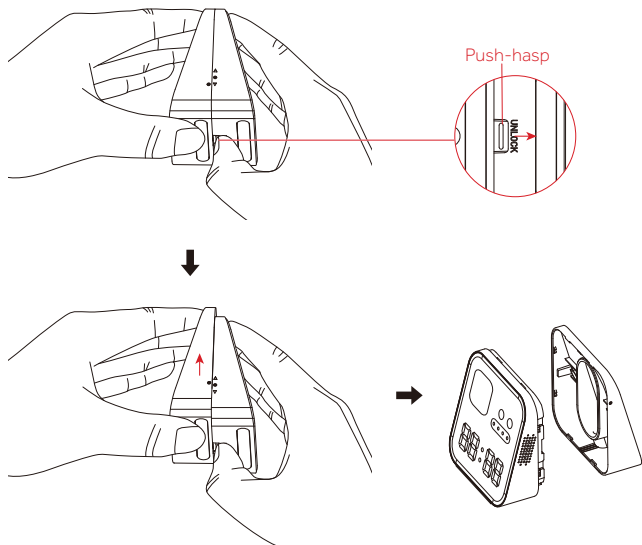
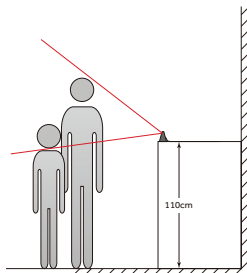
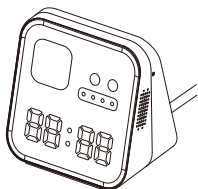
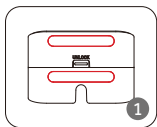

Table-installation-Flat view

Position: Around 1.1m-high table



Installation guidance:



- 1 Stick the rubber foot on the bottom of device and support respectively, assemble the device with support following **Fastening method 1**

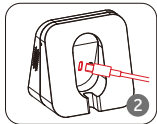

- 2 Thread the power cable through the hole, to connect the power interface on the device

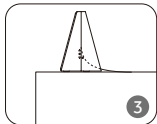

- 3 Put the device on suitable place, and connect the other side of power cable with the power adaptor and then power it on

Table-installation-Elevation view

Position: Around 0.7m-high table

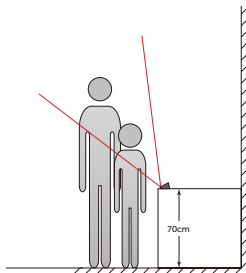
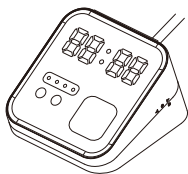

Installation guidance:

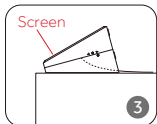
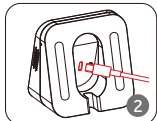

- 1 Stick the rubber foot on 2 sides of the support back respectively, assemble the device with support following **Fastening method 1**
- 2 Thread the power cable through the hole, to connect the power interface on the device
- 3 Put the device flat up on suitable place, and connect the other side of power cable with the power adaptor and then power it on

Wall-mounting-Flat view (cables upwards)

Position: On the wall, with the camera 1.5m distance from the ground

Installation guidance:

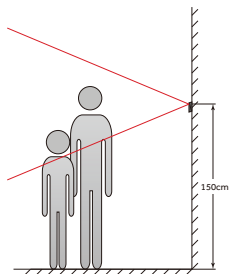
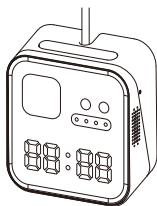
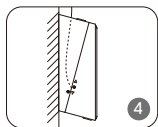
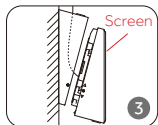
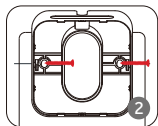
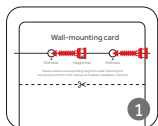

- 1 Cut out the positioning card on package box, drill holes on the wall with appropriate height, put plastic expansion pipes into the holes
- 2 Drill the plastic holes on support, thread the power cable through the support hole and embed it into the slot
- 3 Move the support to align with holes, fix the support with self-tapping screws on the wall
- 4 Connect the cable with power interface on device, assemble the device with support following [Fastening method 2](#), connect the other side of power cable with the power adaptor and then power it on

Wall-mounting-Flat view (cables downwards)

Position: On the wall, with the camera 1.5m distance from the ground

Installation guidance:

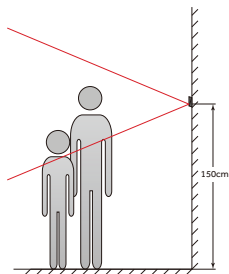
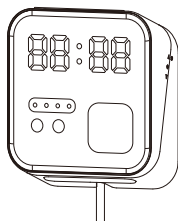
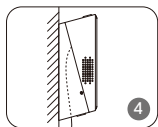
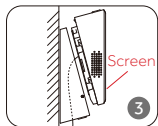
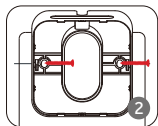
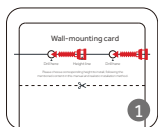

- 1 Cut out the positioning card on package box, drill holes on the wall with appropriate height, put plastic expansion pipes into the holes
- 2 Drill the plastic holes on support, thread the power cable through the support hole and embed it into the slot
- 3 Move the support to align with holes, fix the support with self-tapping screws on the wall
- 4 Connect the cable with power interface on device, assemble the device with support following [Fastening method 2](#), connect the other side of power cable with the power adaptor and then power it on

Wall-mounting-Top view (cables upwards)

Position: On the wall, with the camera 1.8m distance from the ground

Installation guidance:

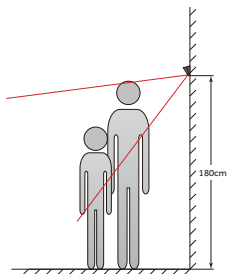
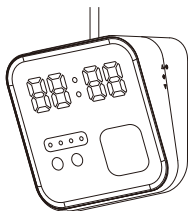
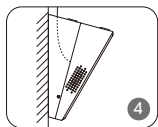
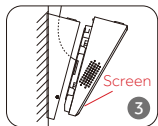
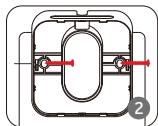
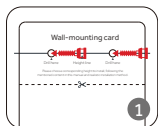

- 1 Cut out the positioning card on package box, drill holes on the wall with appropriate height, put plastic expansion pipes into the holes
- 2 Drill the plastic holes on support, thread the power cable through the support hole and embed it into the slot
- 3 Move the support to align with holes, fix the support with self-tapping screws on the wall
- 4 Connect the cable with power interface on device, assemble the device with support following **Fastening method 1**, connect the other side of power cable with the power adaptor and then power it on

Wall-mounting-Elevation view (cables downwards)

Position: On the wall, with the camera 1.0m distance from the ground

Installation guidance:

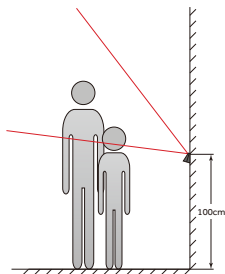
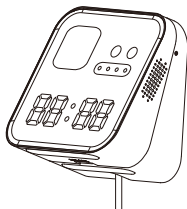
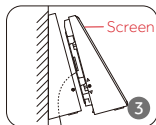
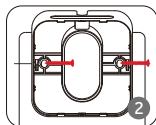
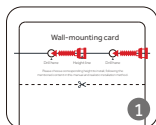

- 1 Cut out the positioning card on package box, drill holes on the wall with appropriate height, put plastic expansion pipes into the holes
- 2 Drill the plastic holes on support, thread the power cable through the support hole and embed it into the slot
- 3 Move the support to align with holes, fix the support with self-tapping screws on the wall
- 4 Connect the cable with power interface on device, assemble the device with support following **Fastening method 1**, connect the other side of power cable with the power adaptor and then power it on

Instructions

Reset the Device

1. With the device power-on, press RESET for 5s and release
2. During the process, "0000" will be shown on the digital tube and "Resetting device..." on display screen
3. After resetting, the device will auto restart and enter the state of to be activated

*Resetting the device will clear all data and restore to factory settings, the process is irreversible, please operate with care

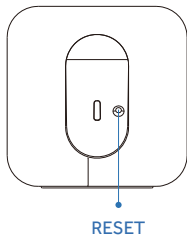

Other Matters

- Power cables should be used together with USB power adaptor (output DC 5V/2A)
- Portable power can be used in case of emergence
- The product can auto judge the installation angle to complete the self-adaptation configuration

Warranty

Warranty Service

If the device, following the user manual and operating instruction, still breaks down, contact after-sales staff at once, as they will judge the causes on basis of customer description and give remote guidance; if the guidance does not work, then the customer can send back the device for maintenance and test; if the device is unable to be sent back, contact after-sales staff in advance and ask them to head for the site to do the field maintenance. However, if the device problems found are not resulted by hardware or software system of our company after the field maintenance, then customer shall pay the extra fee incurred by the onsite service.

Warranty Period

All products carry a 1-year guarantee period since the delivery date.

Warranty Scope

Device breakdown caused by following conditions is not included within the warranty scope:

- Any damages caused by incorrect use, maintenance or storage, as not follow the user manual;
- Damages caused by falling, water intaking, improper storage or any other man-made malicious damages;
- Malfunction caused by force majeure such as natural disasters and external causes such as abnormal voltage;
- Damages caused by shipment, please contact the department of transportation;
- Malfunction or damages caused by unfavorable operating environment, such as too high or too low temperature, poor condition, abnormal power system and so on;
- Accessories are not within the warranty scope. If lost or damaged, please contact our staff to purchase.



uni-ubi



UFACE

www.uni-ubi.com/en

CE Caution:

Use the Product in the environment with the temperature Between -10 C and 40 C ; Otherwise, it may damage your product. Products can only be used below 2000m altitude

For the following equipment:

Product Name: Face recognition terminal

Brand Name:  宇泛智能

Model No.: OS-K21-11901

Universal Ubiquitous Co.,Ltd.

E-mail: wangjianhao@uni-ubi.com

hereby declares that this [Name: Face recognition terminal, OS-K21-11901] is in compliance with the essential requirements and other relevant provisions of Directive 2014/53/EU.



Adapter shall be installed near the equipment and shall be easily accessible.

Only can use adapter as below:

Power Adapter Model: XED-CE050200CU

Input: AC100-240V, 50/60Hz, 0.3A Output: DC5V, 2.0A

SHENZHEN XED POWER SUPPLY CO., LTD

Universal Ubiquitous Co., Ltd.

The plug considered as disconnect device of adapter.

This product is intended for sale and application in a business environment.

RED Article 10 2

-This product can be used across EU member states

RED Article 10 10

-The product is class 1 product, No restrictions

The RF distance between body and product is 20cm.

Frequency Range:

WIFI:

2412-2472MHz for 802.11b/g/n(HT20)

2422-2462MHz for 802.11b/g/n(HT40)

Max.RF Output Power: 15.92dBm (EIRP)

Bluetooth:

2402-2480MHz

Max.RF Output Power: 7.83dBm (EIRP)

FCC Warning

This device complies with Part 15 of the FCC Rules. Operation is subject to the following two conditions:

(1) This device may not cause harmful interference, and (2) this device must accept any interference received, including interference that may cause undesired operation.

NOTE 1: This equipment has been tested and found to comply with the limits for a Class B digital device, pursuant to part 15 of the FCC Rules. These limits are designed to provide reasonable protection against harmful interference in a residential installation. This equipment generates uses and can radiate radio frequency energy and, if not installed and used in accordance with the instructions, may cause harmful interference to radio communications. However, there is no guarantee that interference will not occur in a particular installation. If this equipment does cause harmful interference to radio or television reception, which can be determined by turning the equipment off and on, the user is encouraged to try to correct the interference by one or more of the following measures:

- Reorient or relocate the receiving antenna.
- Increase the separation between the equipment and receiver.
- Connect the equipment into an outlet on a circuit different from that to which the receiver is connected.
- Consult the dealer or an experienced radio/TV technician for help.

NOTE 2: Any changes or modifications to this unit not expressly approved by the party responsible for compliance could void the user's authority to operate the equipment.

RF exposure statement

This equipment complies with the FCC RF radiation exposure limits set forth for an uncontrolled environment. This equipment should be installed and operated with a minimum distance of 20cm between the radiator and any part of your body.