

FCC TEST REPORT

For

HAOLIYUAN(SHENZHEN) ELECTRONIC CO.,LTD

Mini 802.11ac Wireless USB Adapter

Test Model: 0611

Additional Model No. : WU650S

Prepared for : HAOLIYUAN(SHENZHEN) ELECTRONIC CO.,LTD
Address : 4F, Building7, District3, Cuigang industrial park, Rd zhengfengnan, Fuyong,Baoan, shenzhen

Prepared by : Shenzhen LCS Compliance Testing Laboratory Ltd.
Address : 101, 201 Bldg A & 301 Bldg C, Juji Industrial Park Shajing Street, Baoan District, Shenzhen, China

Tel : (+86)755-82591330
Fax : (+86)755-82591332
Web : www.LCS-cert.com
Mail : webmaster@LCS-cert.com

Date of receipt of test sample : Aug 11, 2020
Number of tested samples : 1
Serial number : Prototype
Date of Test : Aug 12, 2020 ~ Aug 18, 2020
Date of Report : Aug 19, 2020

FCC TEST REPORT
FCC CFR 47 PART 15 E (15.407)**Report Reference No.** : **LCS200810087AED**

Date of Issue..... : Aug 19, 2020

Testing Laboratory Name..... : **Shenzhen LCS Compliance Testing Laboratory Ltd.**Address..... : 101, 201 Bldg A & 301 Bldg C, Juji Industrial Park Shajing Street,
Baoan District, Shenzhen, ChinaTesting Location/ Procedure..... : Full application of Harmonised standards
Partial application of Harmonised standards
Other standard testing method **Applicant's Name**..... : **HAOLIYUAN(SHENZHEN) ELECTRONIC CO.,LTD**Address..... : 4F, Building7, District3, Cuigang industrial park, Rd zhengfengnan,
Fuyong,Baoan, shenzhen**Test Specification**

Standard..... : FCC CFR 47 PART 15 E (15.407)

Test Report Form No..... : LCSEMC-1.0

TRF Originator..... : Shenzhen LCS Compliance Testing Laboratory Ltd.

Master TRF..... : Dated 2011-03

Shenzhen LCS Compliance Testing Laboratory Ltd. All rights reserved.

This publication may be reproduced in whole or in part for non-commercial purposes as long as the Shenzhen LCS Compliance Testing Laboratory Ltd. is acknowledged as copyright owner and source of the material. Shenzhen LCS Compliance Testing Laboratory Ltd. takes no responsibility for and will not assume liability for damages resulting from the reader's interpretation of the reproduced material due to its placement and context.

EUT Description..... : **Mini 802.11ac Wireless USB Adapter**

Trade Mark..... : N/A

Test Model..... : 0611

Ratings..... : DC 5.0V

Result : **Positive****Supervised by:**

Jack Liu/ File administrators

Compiled by:

Jin Wang/ Technique principal

Approved by:

Gavin Liang/ Manager

FCC -- TEST REPORT

Test Report No. : LCS200810087AED	<u>Aug 19, 2020</u> Date of issue
--	--------------------------------------

EUT.....	: Mini 802.11ac Wireless USB Adapter
Test Model.....	: 0611
Applicant.....	: HAOLIYUAN(SHENZHEN) ELECTRONIC CO.,LTD
Address.....	: 4F, Building7, District3, Cuigang industrial park, Rd zhengfengnan, Fuyong,Baoan, shenzhen
Telephone.....	: /
Fax.....	: /
Manufacturer.....	: HAOLIYUAN(SHENZHEN) ELECTRONIC CO.,LTD
Address.....	: 4F, Building7, District3, Cuigang industrial park, Rd zhengfengnan, Fuyong,Baoan, shenzhen
Telephone.....	: /
Fax.....	: /
Factory.....	: HAOLIYUAN(SHENZHEN) ELECTRONIC CO.,LTD
Address.....	: 4F, Building7, District3, Cuigang industrial park, Rd zhengfengnan, Fuyong,Baoan, shenzhen
Telephone.....	: /
Fax.....	: /

Test Result:	Positive
---------------------	-----------------

The test report merely corresponds to the test sample.
 It is not permitted to copy extracts of these test result without the written permission of the test laboratory.

Revision History

Revision	Issue Date	Revisions	Revised By
000	Aug 19, 2020	Initial Issue	Gavin Liang

TABLE OF CONTENTS

1. GENERAL INFORMATION.....	6
1.1. DESCRIPTION OF DEVICE (EUT).....	6
1.2. HOST SYSTEM CONFIGURATION LIST AND DETAILS.....	6
1.3. EXTERNAL I/O PORT.....	7
1.4. DESCRIPTION OF TEST FACILITY.....	7
1.5. STATEMENT OF THE MEASUREMENT UNCERTAINTY.....	7
1.6. MEASUREMENT UNCERTAINTY.....	8
1.7. DESCRIPTION OF TEST MODES.....	8
1.8. CHANNEL LIST AND FREQUENCY.....	9
2. TEST METHODOLOGY.....	10
2.1. EUT CONFIGURATION.....	10
2.2. EUT EXERCISE.....	10
2.3. GENERAL TEST PROCEDURES.....	10
3. SYSTEM TEST CONFIGURATION.....	11
3.1. JUSTIFICATION.....	11
3.2. EUT EXERCISE SOFTWARE.....	11
3.3. SPECIAL ACCESSORIES.....	11
3.4. BLOCK DIAGRAM/SCHEMATICS.....	11
3.5. EQUIPMENT MODIFICATIONS.....	11
3.6. TEST SETUP.....	11
4. SUMMARY OF TEST RESULTS.....	12
5. TEST RESULT.....	13
5.1. ON TIME AND DUTY CYCLE.....	13
5.2. MAXIMUM CONDUCTED OUTPUT POWER MEASUREMENT.....	14
5.3. POWER SPECTRAL DENSITY MEASUREMENT.....	16
5.4. 6DB OCCUPIED BANDWIDTH MEASUREMENT.....	18
5.5. 99% OCCUPIED BANDWIDTH MEASUREMENT.....	19
5.6. RADIATED EMISSIONS MEASUREMENT.....	20
5.7. POWER LINE CONDUCTED EMISSIONS.....	32
5.8 UNDESIRABLE EMISSIONS MEASUREMENT.....	35
5.9. FREQUENCY STABILITY.....	37
5.10. ANTENNA REQUIREMENTS.....	39
6. LIST OF MEASURING EQUIPMENTS.....	40
7. TEST SETUP PHOTOGRAPHS OF EUT.....	41
8. EXTERIOR PHOTOGRAPHS OF THE EUT.....	41
9. INTERIOR PHOTOGRAPHS OF THE EUT.....	41

1. GENERAL INFORMATION

1.1. Description of Device (EUT)

EUT	: Mini 802.11ac Wireless USB Adapter
Test Model	: 0611
Additional Model No.	: WU650S
Model declaration	: PCB board, structure and internal of these model(s) are the same, : So no additional models were tested.
Power Supply	: DC 5.0V
Hardware Version	: V1.1
Software Version	: 1030.28
2.4G WLAN	:
Frequency Range	: 2412MHz ~ 2472 MHz
Channel Spacing	: 5MHz
Channel Number	: 13 channels for 20MHz bandwidth (2412~2472MHz) : 9 Channels for 40MHz bandwidth(2422~2462MHz)
Modulation Type	: IEEE 802.11b: DSSS (CCK,DQPSK,DBPSK); : IEEE 802.11g/n: OFDM (64QAM, 16QAM, QPSK, BPSK)
5G WLAN	:
Frequency Range	: 5180-5240MHz, 5260-5320MHz, 5500-5700MHz, 5745-5825MHz 4 Channels for 20MHz bandwidth(5180-5240MHz) 4 Channels for 20MHz bandwidth(5260-5320MHz) 11 Channels for 20MHz bandwidth(5500-5700MHz) 5 channels for 20MHz bandwidth(5745-5825MHz)
Channel Number	: 2 channels for 40MHz bandwidth(5190~5230MHz) : 2 channels for 40MHz bandwidth(5270~5310MHz) : 5 Channels for 40MHz bandwidth(5510-5670MHz) : 2 channels for 40MHz bandwidth(5755~5795MHz) : 1 Channels for 80MHz bandwidth(5210MHz) : 1 channels for 80MHz bandwidth(5290MHz) : 2 Channels for 80MHz bandwidth(5530-5610MHz) : 1 channels for 80MHz bandwidth(5775MHz)
Modulation Type	: IEEE 802.11a/n/ac: OFDM (256QAM,64QAM,16QAM,QPSK BPSK)
Antenna Description	: Internal Antenna, 2.0dBi(Max.)

1.2. Host System Configuration List and Details

Manufacturer	Description	Model	Serial Number	Certificate
DELL	Adapter for Notebook	LA130PM121	--	CE
DELL	Notebook	Vostro 15-7570		CE

Note: Support equipment is provided by the laboratory

1.3. External I/O Port

I/O Port Description	Quantity	Cable
--	--	N/A

1.4. Description of Test Facility

NVLAP Accreditation Code is 600167-0.

FCC Designation Number is CN5024.

CAB identifier is CN0071.

CNAS Registration Number is L4595.

The 3m-Semi anechoic test site fulfils CISPR 16-1-4 according to ANSI C63.4:2014 and CISPR 16-1-4:2010 SVSWR requirement for radiated emission above 1GHz.

1.5. Statement of the Measurement Uncertainty

The data and results referenced in this document are true and accurate. The reader is cautioned that there may be errors within the calibration limits of the equipment and facilities. The measurement uncertainty was calculated for all measurements listed in this test report acc. To CISPR 16 – 4 “Specification for radio disturbance and immunity measuring apparatus and methods – Part 4: Uncertainty in EMC Measurements” and is documented in the LCS quality system acc. To DIN EN ISO/IEC 17025. Furthermore, component and process variability of devices similar to that tested may result in additional deviation. The manufacturer has the sole responsibility of continued compliance of the device.

1.6. Measurement Uncertainty

Test Item	Frequency Range	Uncertainty	Note
Radiation Uncertainty	9KHz~30MHz	±3.10dB	(1)
	30MHz~200MHz	±2.96dB	(1)
	200MHz~1000MHz	±3.10dB	(1)
	1GHz~26.5GHz	±3.80dB	(1)
	26.5GHz~40GHz	±3.90dB	(1)
Conduction Uncertainty	150kHz~30MHz	±1.63dB	(1)
Power disturbance	30MHz~300MHz	±1.60dB	(1)

(1). This uncertainty represents an expanded uncertainty expressed at approximately the 95% confidence level using a coverage factor of k=2.

1.7. Description of Test Modes

The EUT has been tested under operating condition.

This test was performed with EUT in X, Y, Z position and the worst case was found when EUT in X position.

Worst-case mode and channel used for 150 KHz-30 MHz power line conducted emissions was the mode and channel with the highest output power that was determined to be IEEE 802.11ac VHT20 mode (High Channel).

Worst-case mode and channel used for 9 KHz-1000 MHz radiated emissions was the mode and channel with the highest output power, that was determined to be IEEE 802.11ac VHT20 mode (High Channel).

Pre-test AC conducted emission at both voltage AC 120V/60Hz and AC 240V/50Hz, recorded worst case.

Worst-Case data rates were utilized from preliminary testing of the Chipset, worst-case data rates used during the testing are as follows:

IEEE 802.11a Mode: 6 Mbps, OFDM.

IEEE 802.11ac VHT20 Mode: MCS0

IEEE 802.11n HT20 Mode: MCS0, OFDM.

IEEE 802.11ac VHT40 Mode: MCS0, OFDM.

IEEE 802.11n HT40 Mode: MCS0, OFDM.

IEEE 802.11ac VHT80 Mode: MCS0, OFDM.

Antenna & Bandwidth

Antenna	Ant_Chain			
	Bandwidth Mode	20MHz	40MHz	80MHz
IEEE 802.11a		<input checked="" type="checkbox"/>	<input type="checkbox"/>	<input type="checkbox"/>
IEEE 802.11n		<input checked="" type="checkbox"/>	<input checked="" type="checkbox"/>	<input type="checkbox"/>
IEEE 802.11ac		<input checked="" type="checkbox"/>	<input checked="" type="checkbox"/>	<input checked="" type="checkbox"/>

1.8. Channel List and Frequency

U-NI-3

Frequency Band	Channel No.	Frequency (MHz)	Channel No.	Frequency (MHz)
5745~5825MHz	149	5745	155	5775
	151	5755	159	5795
	153	5765	161	5805
	157	5785	165	5825

For IEEE 802.11a/n HT20/ac VHT20, Channel 149, 157 and 165 were tested.

For IEEE 802.11n HT40/ac VHT40, Channel 151 and 159 were tested.

For IEEE 802.11ac VHT80, Channel 155 was tested.

2. TEST METHODOLOGY

All measurements contained in this report were conducted with ANSI C63.10-2013, American National Standard of Procedures for Compliance Testing of Unlicensed Wireless Devices.

The radiated testing was performed at an antenna-to-EUT distance of 3 meters. All radiated and conducted emissions measurement was performed at Shenzhen LCS Compliance Testing Laboratory Ltd.

2.1. EUT Configuration

The EUT configuration for testing is installed on RF field strength measurement to meet the Commissions requirement and operating in a manner that intends to maximize its emission characteristics in a continuous normal application.

2.2. EUT Exercise

The EUT was operated in the engineering mode to fix the TX frequency that was for the purpose of the measurements.

According to FCC's request, Test Procedure KDB789033 D02 General UNII Test Procedures New Rules v02r01 and KDB 662911 D01 Multiple Transmitter Output v02r01 is required to be used for this kind of FCC 15.407 UII device.

According to its specifications, the EUT must comply with the requirements of the Section 15.203, 15.205, 15.207, 15.209 and 15.407 under the FCC Rules Part 15 Subpart E

2.3. General Test Procedures

2.3.1 Conducted Emissions

The EUT is placed on the turntable, which is 0.8 m above ground plane. According to the requirements in Section 6.2.1 of ANSI C63.10-2013 Conducted emissions from the EUT measured in the frequency range between 0.15 MHz and 30MHz using Quasi-peak and average detector modes.

2.3.2 Radiated Emissions

The EUT is placed on a turn table, which is 0.8 m above ground plane below 1GHz and 1.5 m above ground plane above 1GHz. The turntable shall rotate 360 degrees to determine the position of maximum emission level. EUT is set 3m away from the receiving antenna, which varied from 1m to 4m to find out the highest emission. And also, each emission was to be maximized by changing the polarization of receiving antenna both horizontal and vertical. In order to find out the maximum emissions, exploratory radiated emission measurements were made according to the requirements in Section 6.3 of ANSI C63.10-2013.

3. SYSTEM TEST CONFIGURATION

3.1. Justification

The system was configured for testing in a continuous transmits condition.

3.2. EUT Exercise Software

The system was configured for 5.8G WLAN testing in a continuous transmits condition and change test channels by software (MTool_REL_2_0_1_8) provided by application.

3.3. Special Accessories

N/A

3.4. Block Diagram/Schematics

Please refer to the related document

3.5. Equipment Modifications

Shenzhen LCS Compliance Testing Laboratory Ltd. has not done any modification on the EUT.

3.6. Test Setup

Please refer to the test setup photo.

4. SUMMARY OF TEST RESULTS

Applied Standard: FCC Part 15 Subpart E			
FCC Rules	Description of Test	Result	Remark
/	On Time and Duty Cycle	/	Appendix E.1
§15.407(a)	Maximum Conducted Output Power	Compliant	Appendix E.2
§15.407(a)	Power Spectral Density	Compliant	Appendix E.3
§15.407(e)	6dB Bandwidth	Compliant	Appendix E.4
§15.209, §15.407(b)	Radiated Emissions	Compliant	Note 1
§15.209, §15.407(b)	Band edge Emissions	Compliant	Appendix E.5
§15.407(g)	Frequency Stability	Compliant	Note 1
§15.207(a)	AC Conducted Emissions	Compliant	Note 1
§15.203	Antenna Requirements	Compliant	Note 1
§15.407 §2.1093	RF Exposure	Compliant	Note 2

Remark:

1. Note 1 – Test results inside test report;
2. Note 2 – Test results in other test report (SAR Report).

5. TEST RESULT

5.1. On Time and Duty Cycle

5.1.1. Standard Applicable

None; for reporting purpose only.

5.1.2. Measuring Instruments and Setting

Please refer to equipment list in this report. The following table is the setting of the spectrum analyzer.

5.1.3. Test Procedures

1. Set the Centre frequency of the spectrum analyzer to the transmitting frequency;
2. Set the span=0MHz, RBW=8MHz, VBW=50MHz, Sweep time=10.13ms;
3. Detector = peak;
4. Trace mode = Single hold.

5.1.4. Test Setup Layout

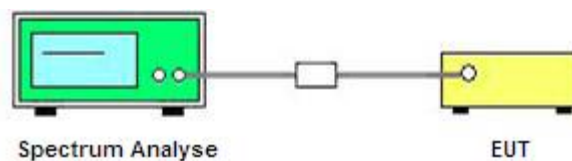

5.1.5. EUT Operation during Test

The EUT was programmed to be in continuously transmitting mode.

5.1.6. Test result

For reporting purpose only.

Please refer to Appendix E.1

5.2. Maximum Conducted Output Power Measurement

5.2.1. Standard Applicable

For 5725~5850MHz

For the band 5.725-5.85 GHz, the maximum conducted output power over the frequency band of operation shall not exceed 1 W. In addition, the maximum power spectral density shall not exceed 30 dBm in any 500-kHz band. If transmitting antennas of directional gain greater than 6 dBi are used, both the maximum conducted output power and the maximum power spectral density shall be reduced by the amount in dB that the directional gain of the antenna exceeds 6 dBi. However, fixed point-to-point U-NII devices operating in this band may employ transmitting antennas with directional gain greater than 6 dBi without any corresponding reduction in transmitter conducted power. Fixed, point-to-point operations exclude the use of point-to-multipoint systems, omnidirectional applications, and multiple collocated transmitters transmitting the same information. The operator of the U-NII device, or if the equipment is professionally installed, the installer, is responsible for ensuring that systems employing high gain directional antennas are used exclusively for fixed, point-to-point operations.

5.2.2. Measuring Instruments and Setting

Please refer to equipment list in this report. The following table is the setting of the power meter.

5.2.3. Test Procedures

The transmitter output (antenna port) was connected to the power meter.

According to KDB789033 D02 General UNII Test Procedures New Rules v02r01 Section 3 (a) Method PM (Measurement using an RF average power meter):

- (i) Measurements may be performed using a wideband RF power meter with a thermocouple detector or equivalent if all of the conditions listed below are satisfied.
 - The EUT is configured to transmit continuously or to transmit with a constant duty cycle.
 - At all times when the EUT is transmitting, it must be transmitting at its maximum power control level.
 - The integration period of the power meter exceeds the repetition period of the transmitted signal by at least a factor of five.
- (ii) If the transmitter does not transmit continuously, measure the duty cycle, x , of the transmitter output signal as described in section II.B.
- (iii) Measure the average power of the transmitter. This measurement is an average over both the on and off periods of the transmitter.

5.2.4. Test Setup Layout

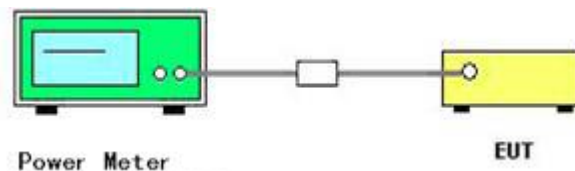

5.2.5. EUT Operation during Test

The EUT was programmed to be in continuously transmitting mode.

PASS

Please refer to Appendix E.2

Remark:

1. Measured output power at difference data rate for each mode and recorded worst case for each mode.
2. Test results including cable loss;
3. Worst case data at 6Mbps at IEEE 802.11a; MCS0 at IEEE 802.11n HT20, IEEE 802.11n HT40, IEEE 802.11a VHT20, IEEE 802.11ac VHT40 and IEEE 802.11ac VHT80;
4. Report conducted power = Measured conducted average power + Duty Cycle factor;
5. The EUT used two same PIFA antenna for WIFI TX/RX, the directional gain= $2.04+10*\log(2)=5.05\text{dBi}$.
6. For power measurements on IEEE 802.11 devices;
Array Gain = 0 dB (i.e., no array gain) for $\text{NANT} \leq 4$;
Array Gain = 0 dB (i.e., no array gain) for channel widths ≥ 40 MHz for any NANT;
Array Gain = $5 \log(\text{NANT}/\text{NSS})$ dB or 3 dB, whichever is less, for 20-MHz channel widths with $\text{NANT} \geq 5$.

5.3. Power Spectral Density Measurement

5.3.1. Standard Applicable

For 5725~5850MHz

For the band 5.725-5.85 GHz, the maximum conducted output power over the frequency band of operation shall not exceed 1 W. In addition, the maximum power spectral density shall not exceed 30 dBm in any 500-kHz band. If transmitting antennas of directional gain greater than 6 dBi are used, both the maximum conducted output power and the maximum power spectral density shall be reduced by the amount in dB that the directional gain of the antenna exceeds 6 dBi. However, fixed point-to-point U-NII devices operating in this band may employ transmitting antennas with directional gain greater than 6 dBi without any corresponding reduction in transmitter conducted power. Fixed, point-to-point operations exclude the use of point-to-multipoint systems, omnidirectional applications, and multiple collocated transmitters transmitting the same information. The operator of the U-NII device, or if the equipment is professionally installed, the installer, is responsible for ensuring that systems employing high gain directional antennas are used exclusively for fixed, point-to-point operations.

5.3.2. Measuring Instruments and Setting

Please refer to equipment list in this report. The following table is the setting of Spectrum Analyzer.

5.3.3. Test Procedures

- 1). The transmitter was connected directly to a Spectrum Analyzer through a directional couple.
- 2). The power was monitored at the coupler port with a Spectrum Analyzer. The power level was set to the maximum level.
- 3). Set the RBW = 300 kHz
- 4). Set the VBW $\geq 3 \times$ RBW
- 5). Span=Encompass the entire emissions bandwidth (EBW) of the signal
- 6). Detector = RMS.
- 7). Sweep time = auto couple.
- 8). Trace mode = max hold.
- 9). Allow trace to fully stabilize.
- 10). If measurement bandwidth of Maximum PSD is specified in 500 kHz, add $10 \log (500 \text{ kHz}/\text{RBW})$ to the measured result, whereas RBW ($< 500 \text{ kHz}$) is the reduced resolution bandwidth of the spectrum analyzer set during measurement.
- 11). If measurement bandwidth of Maximum PSD is specified in 1 MHz, add $10 \log (1\text{MHz}/\text{RBW})$ to the measured result, whereas RBW ($< 1 \text{ MHz}$) is the reduced resolution bandwidth of spectrum analyzer set during measurement.
- 12). Care must be taken to ensure that the measurements are performed during a period of continuous transmission or are corrected upward for duty cycle.

5.3.4. Test Setup Layout

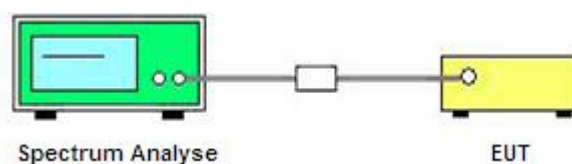

5.3.5. EUT Operation during Test

The EUT was programmed to be in continuously transmitting mode.

5.3.6. Test Result of Power Spectral Density

PASS.

Please refer to Appendix E.3.

Remark:

1. Measured power spectrum density at difference data rate for each mode and recorded worst case for each mode.
2. Test results including cable loss;
3. Worst case data at 6Mbps at IEEE 802.11a; MCS0 at IEEE 802.11n HT20, IEEE 802.11n HT40, IEEE 802.11a VHT20, IEEE 802.11ac VHT40 and IEEE 802.11ac VHT80;
4. Report conducted PSD = measured conducted PSD + Duty Cycle factor + RBW factor;
5. RBW factor = $10 \log (500 \text{ KHz} / 300 \text{ KHz}) = 2.218 \text{ dB}$;
6. The EUT used two same PIFA antenna for WIFI TX/RX, the directional gain= $2.04+10*\log (2)=5.05\text{dBi}$. So the power spectrum density limits of IEEE 802.11n HT20, IEEE 802.11 n HT40, IEEE 802.11 ac VHT20, IEEE 802.11 ac VHT40 and IEEE 802.11 ac VHT80 for MIMO with CDD technology should be reduced.
7. For MIMO with CCD technology device, The Directional Gain= Gain of individual transmit antennas (dBi) + Array gain;
Array gain = $10 \log (N_{ant})$, where N_{ant} is the number of transmit antennas

5.4. 6dB Occupied Bandwidth Measurement

5.4.1. Standard Applicable

Within the 5.725-5.85 GHz band, the minimum 6 dB bandwidth of U-NII devices shall be at least 500 kHz.

5.4.2. Measuring Instruments and Setting

Please refer to equipment list in this report. The following table is the setting of the Spectrum Analyzer.

Spectrum Parameter	Setting
Attenuation	Auto
Span	> 26dB Bandwidth
Detector	Peak
Trace	Max Hold
Sweep Time	Auto

5.4.3. Test Procedures

1. The transmitter output (antenna port) was connected to the spectrum analyzer in peak hold mode.
2. The resolution bandwidth of 100 KHz and the video bandwidth of 300 KHz were used.
3. Measured the spectrum width with power higher than 6dB below carrier.

5.4.4. Test Setup Layout

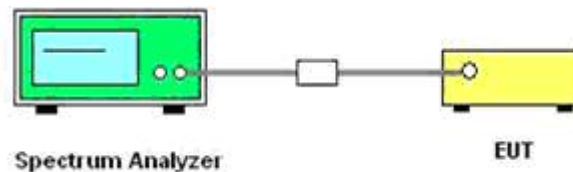

5.4.5. EUT Operation during Test

The EUT was programmed to be in continuously transmitting mode.

5.4.6. Test Result of 6dB Occupied Bandwidth

PASS.

Please refer to Appendix E.4.

Remark:

1. Measured 6dB bandwidth at difference data rate for each mode and recorded worst case for each mode.
2. Test results including cable loss;
3. Worst case data at 6Mbps at IEEE 802.11a; MCS0 at IEEE 802.11n HT20, IEEE 802.11n HT40, IEEE 802.11a VHT20, IEEE 802.11ac VHT40 and IEEE 802.11ac VHT80;

5.5. 99% Occupied Bandwidth Measurement

5.5.1. Standard Applicable

According to §2.1049: The occupied bandwidth, that is the frequency bandwidth such that, below its lower and above its upper frequency limits, the mean powers radiated are each equal to 0.5 percent of the total mean power radiated by a given emission shall be measured under the following conditions as applicable.

5.5.2. Measuring Instruments and Setting

Please refer to equipment list in this report. The following table is the setting of the Spectrum Analyzer.

Spectrum Parameter	Setting
Attenuation	Auto
Span Frequency	> RBW
Detector	Peak
Trace	Max Hold
Sweep Time	Auto

5.5.3. Test Procedures

1. The transmitter output (antenna port) was connected to the spectrum analyzer in peak hold mode.
2. Set RBW = 1%~5% OBW; VBW \geq 3*RBW;
3. Measured the 99% occupied bandwidth by related function of the spectrum analyzer.

5.5.4. Test Setup Layout

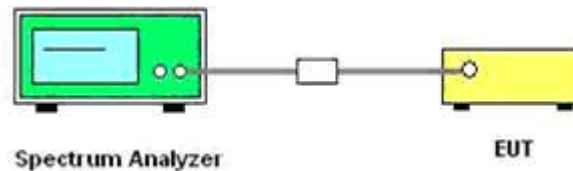

5.5.5. EUT Operation during Test

The EUT was programmed to be in continuously transmitting mode.

5.5.6. Test Result of 99% Occupied Spectrum Bandwidth

Not Applicable

Remark:

1. Measured 6dB bandwidth at difference data rate for each mode and recorded worst case for each mode.
2. Test results including cable loss;
3. Worst case data at 6Mbps at IEEE 802.11a; MCS0 at IEEE 802.11n HT20, IEEE 802.11n HT40, IEEE 802.11a VHT20, IEEE 802.11ac VHT40 and IEEE 802.11ac VHT80;

5.6. Radiated Emissions Measurement

5.6.1. Standard Applicable

15.205 (a) Except as shown in paragraph (d) of this section, only spurious emissions are permitted in any of the frequency bands listed below:

MHz	MHz	MHz	GHz
0.090-0.110	16.42-16.423	399.9-410	4.5-5.15
\1\ 0.495-0.505	16.69475-16.69525	608-614	5.35-5.46
2.1735-2.1905	16.80425-16.80475	960-1240	7.25-7.75
4.125-4.128	25.5-25.67	1300-1427	8.025-8.5
4.17725-4.17775	37.5-38.25	1435-1626.5	9.0-9.2
4.20725-4.20775	73-74.6	1645.5-1646.5	9.3-9.5
6.215-6.218	74.8-75.2	1660-1710	10.6-12.7
6.26775-6.26825	108-121.94	1718.8-1722.2	13.25-13.4
6.31175-6.31225	123-138	2200-2300	14.47-14.5
8.291-8.294	149.9-150.05	2310-2390	15.35-16.2
8.362-8.366	156.52475-156.52525	2483.5-2500	17.7-21.4
8.37625-8.38675	156.7-156.9	2690-2900	22.01-23.12
8.41425-8.41475	162.0125-167.17	3260-3267	23.6-24.0
12.29-12.293	167.72-173.2	3332-3339	31.2-31.8
12.51975-12.52025	240-285	3345.8-3358	36.43-36.5
12.57675-12.57725	322-335.4	3600-4400	(\2\)
13.36-13.41			

\1\ Until February 1, 1999, this restricted band shall be 0.490-0.510 MHz.

\2\ Above 38.6

For transmitters operating in the 5.725-5.85 GHz band:

All emissions shall be limited to a level of -27 dBm/MHz(68.2dBuV/m at 3m) at 75 MHz or more above or below the band edge increasing linearly to 10 dBm/MHz(105.2dBuV/m at 3m) at 25 MHz above or below the band edge, and from 25 MHz above or below the band edge increasing linearly to a level of 15.6(110.8dBuV/m at 3m) dBm/MHz at 5 MHz above or below the band edge, and from 5 MHz above or below the band edge increasing linearly to a level of 27 dBm/MHz(122.2dBuV/m at 3m) at the band edge.

In addition, In case the emission fall within the restricted band specified on 15.205(a), then the 15.209(a) limit in the table below has to be followed.

Frequencies (MHz)	Field Strength (microvolts/meter)	Measurement Distance (meters)
0.009~0.490	2400/F(KHz)	300
0.490~1.705	24000/F(KHz)	30
1.705~30.0	30	30
30~88	100	3
88~216	150	3
216~960	200	3
Above 960	500	3

5.6.2. Measuring Instruments and Setting

Please refer to equipment list in this report. The following table is the setting of spectrum analyzer and receiver.

Spectrum Parameter	Setting
Attenuation	Auto
Start Frequency	1000 MHz
Stop Frequency	10 th carrier harmonic
RB / VB (Emission in restricted band)	1MHz / 1MHz for Peak, 1 MHz / 1/B kHz for Average
RB / VB (Emission in non-restricted band)	1MHz / 1MHz for Peak, 1 MHz / 1/B kHz for Average

Receiver Parameter	Setting
Attenuation	Auto
Start ~ Stop Frequency	9kHz~150kHz / RB/VB 200Hz/1KHz for QP/AVG
Start ~ Stop Frequency	150kHz~30MHz / RB/VB 9kHz/30KHz for QP/AVG
Start ~ Stop Frequency	30MHz~1000MHz / RB/VB 120kHz/300kHz for QP

5.6.3. Test Procedures

1) Sequence of testing 9 kHz to 30 MHz

Setup:

- The equipment was set up to simulate a typical usage like described in the user manual or described by manufacturer.
- If the EUT is a tabletop system, a rotatable table with 0.8 m height is used.
- If the EUT is a floor standing device, it is placed on the ground.
- Auxiliary equipment and cables were positioned to simulate normal operation conditions.
- The AC power port of the EUT (if available) is connected to a power outlet below the turntable.
- The measurement distance is 3 meter.
- The EUT was set into operation.

Premeasurement:

- The turntable rotates from 0° to 315° using 45° steps.
- The antenna height is 0.8 meter.
- At each turntable position the analyzer sweeps with peak detection to find the maximum of all emissions

Final measurement:

- Identified emissions during the premeasurement the software maximizes by rotating the turntable position (0° to 360°) and by rotating the elevation axes (0° to 360°).
- The final measurement will be done in the position (turntable and elevation) causing the highest emissions with QPK detector.
- The final levels, frequency, measuring time, bandwidth, turntable position, correction factor, margin to the limit and limit will be recorded. Also a plot with the graph of the premeasurement and the limit will be stored.

2) Sequence of testing 30 MHz to 1 GHz

Setup:

- The equipment was set up to simulate a typical usage like described in the user manual or described by manufacturer.
- If the EUT is a tabletop system, a table with 0.8 m height is used, which is placed on the ground plane.
- If the EUT is a floor standing device, it is placed on the ground plane with insulation between both.
- Auxiliary equipment and cables were positioned to simulate normal operation conditions
- The AC power port of the EUT (if available) is connected to a power outlet below the turntable.
- The measurement distance is 3 meter.
- The EUT was set into operation.

Premeasurement:

- The turntable rotates from 0° to 315° using 45° steps.
- The antenna is polarized vertical and horizontal.
- The antenna height changes from 1 to 3 meter.
- At each turntable position, antenna polarization and height the analyzer sweeps three times in peak to find the maximum of all emissions.

Final measurement:

- The final measurement will be performed with minimum the six highest peaks.
- According to the maximum antenna and turntable positions of premeasurement the software maximize the peaks by changing turntable position ($\pm 45^\circ$) and antenna movement between 1 and 4 meter.
- The final measurement will be done with QP detector with an EMI receiver.
- The final levels, frequency, measuring time, bandwidth, antenna height, antenna polarization, turntable angle, correction factor, margin to the limit and limit will be recorded. Also a plot with the graph of the premeasurement with marked maximum final measurements and the limit will be stored.

3) Sequence of testing 1 GHz to 18 GHz

Setup:

- The equipment was set up to simulate a typical usage like described in the user manual or described by manufacturer.
- If the EUT is a tabletop system, a rotatable table with 1.5 m height is used.
- If the EUT is a floor standing device, it is placed on the ground plane with insulation between both.
- Auxiliary equipment and cables were positioned to simulate normal operation conditions
- The AC power port of the EUT (if available) is connected to a power outlet below the turntable.
- The measurement distance is 3 meter.
- The EUT was set into operation.

Premeasurement:

- The turntable rotates from 0° to 315° using 45° steps.
- The antenna is polarized vertical and horizontal.
- The antenna height scan range is 1 meter to 2.5 meter.
- At each turntable position and antenna polarization the analyzer sweeps with peak detection to find the maximum of all emissions.

Final measurement:

- The final measurement will be performed with minimum the six highest peaks.
- According to the maximum antenna and turntable positions of premeasurement the software maximize the peaks by changing turntable position ($\pm 45^\circ$) and antenna movement between 1 and 4 meter. This procedure is repeated for both antenna polarizations.
- The final measurement will be done in the position (turntable, EUT-table and antenna polarization) causing the highest emissions with Peak and Average detector.
- The final levels, frequency, measuring time, bandwidth, turntable position, EUT-table position, antenna polarization, correction factor, margin to the limit and limit will be recorded. Also a plot with the graph of the premeasurement with marked maximum final measurements and the limit will be stored.

4) Sequence of testing above 18 GHz

Setup:

--- The equipment was set up to simulate a typical usage like described in the user manual or described by manufacturer.

--- If the EUT is a tabletop system, a rotatable table with 1.5 m height is used.

--- If the EUT is a floor standing device, it is placed on the ground plane with insulation between both.

--- Auxiliary equipment and cables were positioned to simulate normal operation conditions

--- The AC power port of the EUT (if available) is connected to a power outlet below the turntable.

--- The measurement distance is 1 meter.

--- The EUT was set into operation.

Premeasurement:

--- The antenna is moved spherical over the EUT in different polarizations of the antenna.

Final measurement:

--- The final measurement will be performed at the position and antenna orientation for all detected emissions that were found during the premeasurements with Peak and Average detector.

--- The final levels, frequency, measuring time, bandwidth, correction factor, margin to the limit and limit will be recorded. Also a plot with the graph of the premeasurement and the limit will be stored.

5.6.4. Test Setup Layout

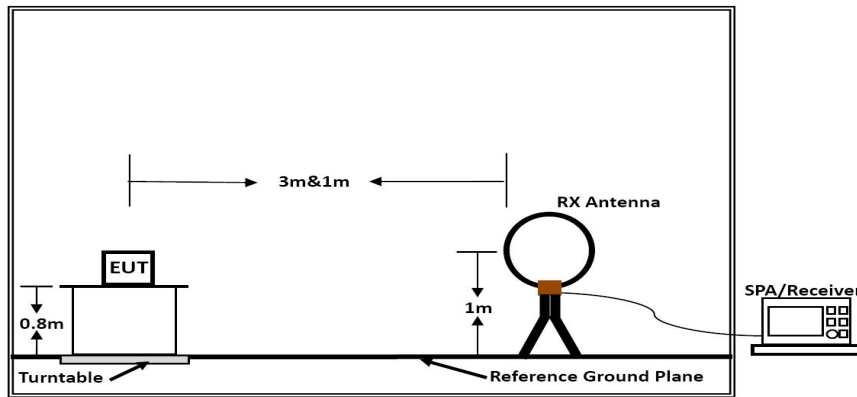

Below 30MHz

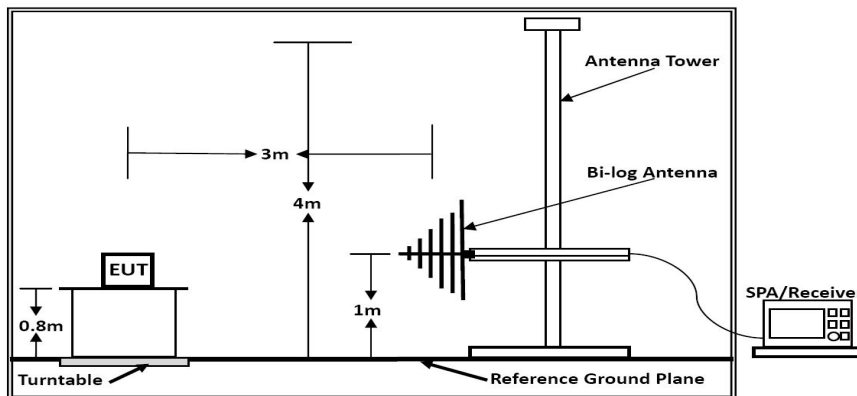

Below 1GHz

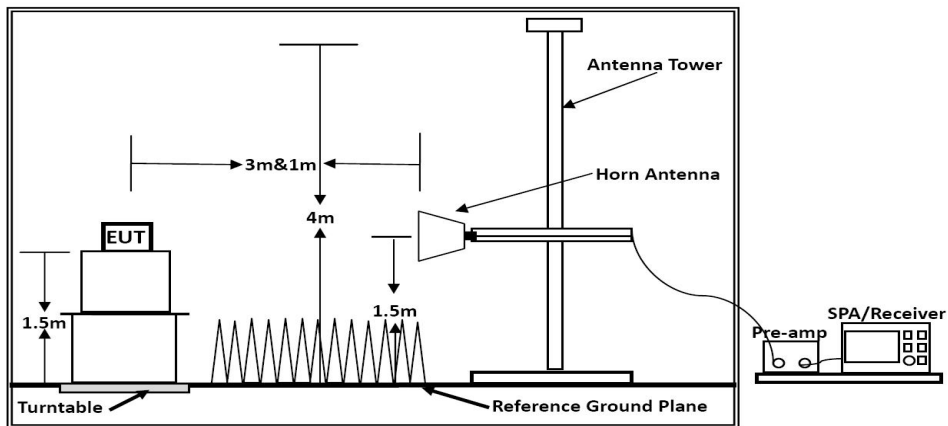

Above 1GHz

Above 18 GHz shall be extrapolated to the specified distance using an extrapolation factor of 20 dB/decade from 3m to 1m.

Distance extrapolation factor = $20 \log(\text{specific distance [3m]} / \text{test distance [1.5m]})$ (dB);

Limit line = specific limits (dBuV) + distance extrapolation factor [6 dB].

5.6.5. EUT Operation during Test

The EUT was programmed to be in continuously transmitting mode.

5.6.6. Results of Radiated Emissions (9 KHz~30 MHz)

Temperature	24.6°C	Humidity	54.1%
Test Engineer	Diamond Lu	Configurations	IEEE 802.11b/g/n

Freq. (MHz)	Level (dBuV)	Over Limit (dB)	Over Limit (dB)	Remark
-	-	-	-	See Note

Note:

The amplitude of spurious emissions which are attenuated by more than 20 dB below the permissible value has no need to be reported.

Distance extrapolation factor = $40 \log(\text{specific distance} / \text{test distance})$ (dB);

Limit line = specific limits (dBuV) + distance extrapolation factor.

5.6.7. Results of Radiated Emissions (30 MHz~1 GHz)

Temperature	24.6°C	Humidity	54.1%
Test Engineer	Diamond Lu	Configurations	IEEE 802.11b (Middle Channel)

Test result for IEEE 802.11ac VHT20 mode

Horizontal

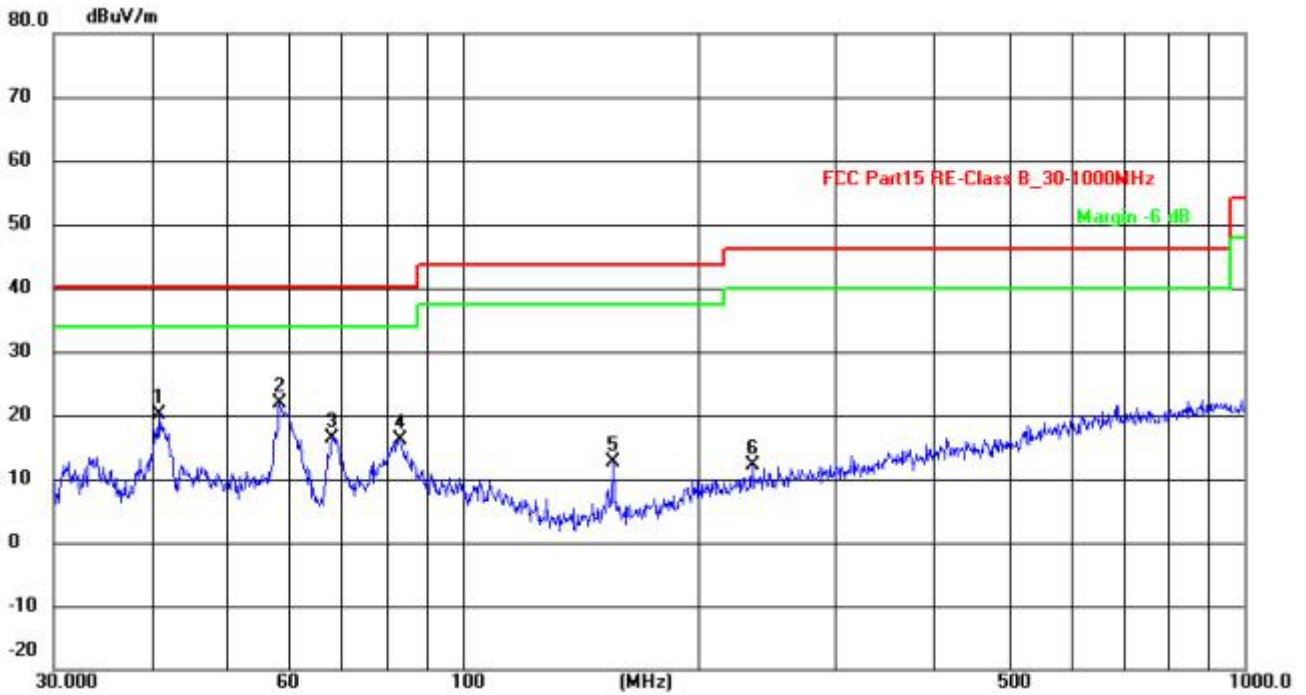

No.	Frequency (MHz)	Reading (dBuV)	Factor (dB/m)	Level (dBuV/m)	Limit (dBuV/m)	Margin (dB)	Detector
1	40.8446	35.90	-15.85	20.05	40.00	-19.95	QP
2	58.4074	38.34	-16.55	21.79	40.00	-18.21	QP
3	68.1514	35.65	-19.24	16.41	40.00	-23.59	QP
4	82.9385	37.09	-21.03	16.06	40.00	-23.94	QP
5	155.9101	33.33	-20.74	12.59	43.50	-30.91	QP
6	234.9909	28.10	-16.08	12.02	46.00	-33.98	QP

Vertical

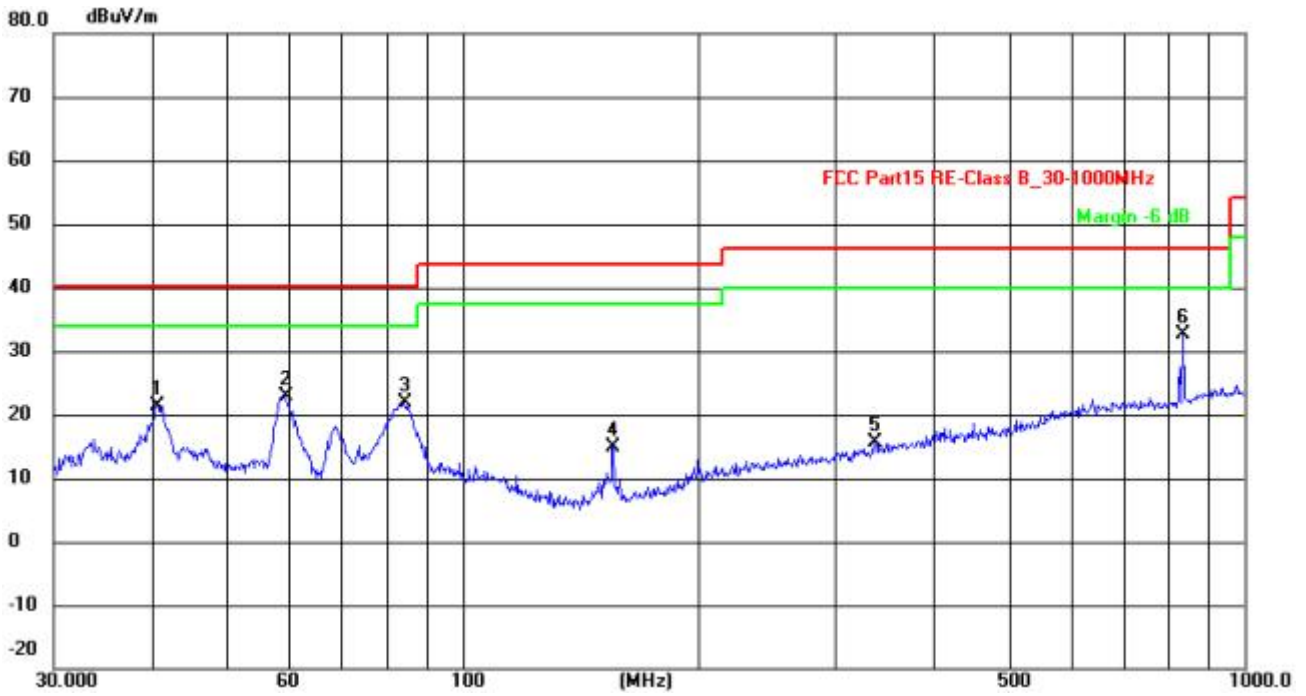

No.	Frequency (MHz)	Reading (dBuV)	Factor (dB/m)	Level (dBuV/m)	Limit (dBuV/m)	Margin (dB)	Detector
1	40.7016	37.32	-15.87	21.45	40.00	-18.55	QP
2	59.2325	39.59	-16.68	22.91	40.00	-17.09	QP
3	84.1100	42.53	-20.73	21.80	40.00	-18.20	QP
4	155.3644	35.77	-20.78	14.99	43.50	-28.51	QP
5	336.0352	29.40	-13.74	15.66	46.00	-30.34	QP
6	836.2443	39.17	-6.62	32.55	46.00	-13.45	QP

Note:

- (1). Pre-scan all modes and recorded the worst case results in this report (IEEE 802.11ac VHT20 mode).
- 2). Emission level (dBuV/m) = 20 log Emission level (uV/m). Margin= Level-limit;
- 3). Factor=Antenan Factor+Cable Loss-Pre Factor;Level=Reading+Factor.

5.6.8. Results for Radiated Emissions (Above 1GHz)

IEEE 802.11a

Channel 149 / 5745 MHz

Freq GHz	Read Level dBuV	Ant. Fac dB/m	Pre. Fac dB	Cab.Los dB	Measured Level dBuV	Limit Line dBuV/m	Over limit dB	Remark	Pol/Phase
17.235	48.04	33.21	35.82	9.52	54.95	68.20	-13.25	Peak	Horizontal
17.235	33.39	33.21	35.82	9.52	40.30	54.00	-13.70	Average	Horizontal
17.235	42.15	32.82	35.82	9.52	48.67	68.20	-19.53	Peak	Vertical
17.235	30.56	32.82	35.82	9.52	37.08	54.00	-16.92	Average	Vertical

Channel 157 / 5785 MHz

Freq GHz	Read Level dBuV	Ant. Fac dB/m	Pre. Fac dB	Cab.Los dB	Measured Level dBuV	Limit Line dBuV/m	Over limit dB	Remark	Pol/Phase
17.355	47.61	33.21	35.82	9.52	54.52	68.20	-13.68	Peak	Horizontal
17.355	38.07	33.21	35.82	9.52	44.98	54.00	-9.02	Average	Horizontal
17.355	40.93	32.82	35.82	9.52	47.45	68.20	-20.75	Peak	Vertical
17.355	33.46	32.82	35.82	9.52	39.98	54.00	-14.02	Average	Vertical

Channel 163 / 5825 MHz

Freq GHz	Read Level dBuV	Ant. Fac dB/m	Pre. Fac dB	Cab.Los dB	Measured Level dBuV	Limit Line dBuV/m	Over limit dB	Remark	Pol/Phase
17.475	44.80	33.21	35.82	9.52	51.71	68.20	-16.49	Peak	Horizontal
17.475	40.44	33.21	35.82	9.52	47.35	54.00	-6.65	Average	Horizontal
17.475	46.44	32.82	35.82	9.52	52.96	68.20	-15.24	Peak	Vertical
17.475	30.66	32.82	35.82	9.52	37.18	54.00	-16.82	Average	Vertical

IEEE 802.11n HT20

Channel 149 / 5745 MHz

Freq GHz	Read Level dBuV	Ant. Fac dB/m	Pre. Fac dB	Cab.Los dB	Measured Level dBuV	Limit Line dBuV/m	Over limit dB	Remark	Pol/Phase
17.235	49.12	33.21	35.82	9.52	56.03	68.20	-12.17	Peak	Horizontal
17.235	36.51	33.21	35.82	9.52	43.42	54.00	-10.58	Average	Horizontal
17.235	44.78	32.82	35.82	9.52	51.30	68.20	-16.90	Peak	Vertical
17.235	40.73	32.82	35.82	9.52	47.25	54.00	-6.75	Average	Vertical

Channel 157 / 5785 MHz

Freq GHz	Read Level dBuV	Ant. Fac dB/m	Pre. Fac dB	Cab.Los dB	Measured Level dBuV	Limit Line dBuV/m	Over limit dB	Remark	Pol/Phase
17.355	48.94	33.21	35.82	9.52	55.85	68.20	-12.35	Peak	Horizontal
17.355	35.86	33.21	35.82	9.52	42.77	54.00	-11.23	Average	Horizontal
17.355	41.23	32.82	35.82	9.52	47.75	68.20	-20.45	Peak	Vertical
17.355	35.39	32.82	35.82	9.52	41.91	54.00	-12.09	Average	Vertical

Channel 163 / 5825 MHz

Freq GHz	Read Level dBuV	Ant. Fac dB/m	Pre. Fac dB	Cab.Los dB	Measured Level dBuV	Limit Line dBuV/m	Over limit dB	Remark	Pol/Phase
17.475	43.33	33.21	35.82	9.52	50.24	68.20	-17.96	Peak	Horizontal
17.475	33.21	33.21	35.82	9.52	40.12	54.00	-13.88	Average	Horizontal
17.475	40.35	32.82	35.82	9.52	46.87	68.20	-21.33	Peak	Vertical
17.475	38.43	32.82	35.82	9.52	44.95	54.00	-9.05	Average	Vertical

IEEE 802.11ac VHT20

Channel 149 / 5745 MHz

Freq GHz	Read Level dBuV	Ant. Fac dB/m	Pre. Fac dB	Cab.Los dB	Measured Level dBuV	Limit Line dBuV/m	Over limit dB	Remark	Pol/Phase
17.235	49.42	33.21	35.82	9.52	56.33	68.20	-11.87	Peak	Horizontal
17.235	39.21	33.21	35.82	9.52	46.12	54.00	-7.88	Average	Horizontal
17.235	42.27	32.82	35.82	9.52	48.79	68.20	-19.41	Peak	Vertical
17.235	31.10	32.82	35.82	9.52	37.62	54.00	-16.38	Average	Vertical

Channel 157 / 5785 MHz

Freq GHz	Read Level dBuV	Ant. Fac dB/m	Pre. Fac dB	Cab.Los dB	Measured Level dBuV	Limit Line dBuV/m	Over limit dB	Remark	Pol/Phase
17.355	49.89	33.21	35.82	9.52	56.80	68.20	-11.40	Peak	Horizontal
17.355	32.28	33.21	35.82	9.52	39.19	54.00	-14.81	Average	Horizontal
17.355	47.52	32.82	35.82	9.52	54.04	68.20	-14.16	Peak	Vertical
17.355	40.89	32.82	35.82	9.52	47.41	54.00	-6.59	Average	Vertical

Channel 163 / 5825 MHz

Freq GHz	Read Level dBuV	Ant. Fac dB/m	Pre. Fac dB	Cab.Los dB	Measured Level dBuV	Limit Line dBuV/m	Over limit dB	Remark	Pol/Phase
17.475	40.18	33.21	35.82	9.52	47.09	68.20	-21.11	Peak	Horizontal
17.475	30.34	33.21	35.82	9.52	37.25	54.00	-16.75	Average	Horizontal
17.475	40.92	32.82	35.82	9.52	47.44	68.20	-20.76	Peak	Vertical
17.475	39.14	32.82	35.82	9.52	45.66	54.00	-8.34	Average	Vertical

IEEE 802.11n HT40

Channel 151 / 5755 MHz

Freq GHz	Read Level dBuV	Ant. Fac dB/m	Pre. Fac dB	Cab.Los dB	Measured Level dBuV	Limit Line dBuV/m	Over limit dB	Remark	Pol/Phase
17.265	40.51	33.21	35.82	9.52	47.42	68.20	-20.78	Peak	Horizontal
17.265	40.56	33.21	35.82	9.52	47.47	54.00	-6.53	Average	Horizontal
17.265	49.09	32.82	35.82	9.52	55.61	68.20	-12.59	Peak	Vertical
17.265	32.66	32.82	35.82	9.52	39.18	54.00	-14.82	Average	Vertical

Channel 159 / 5795 MHz

Freq GHz	Read Level dBuV	Ant. Fac dB/m	Pre. Fac dB	Cab.Los dB	Measured Level dBuV	Limit Line dBuV/m	Over limit dB	Remark	Pol/Phase
17.385	46.31	33.21	35.82	9.52	53.22	68.20	-14.98	Peak	Horizontal
17.385	39.96	33.21	35.82	9.52	46.87	54.00	-7.13	Average	Horizontal
17.385	42.55	32.82	35.82	9.52	49.07	68.20	-19.13	Peak	Vertical
17.385	31.70	32.82	35.82	9.52	38.22	54.00	-15.78	Average	Vertical

IEEE 802.11ac VHT40

Channel 151 / 5755 MHz

Freq GHz	Read Level dBuV	Ant. Fac dB/m	Pre. Fac dB	Cab.Los dB	Measured Level dBuV	Limit Line dBuV/m	Over limit dB	Remark	Pol/Phase
17.265	49.70	33.21	35.82	9.52	56.61	68.20	-11.59	Peak	Horizontal
17.265	38.22	33.21	35.82	9.52	45.13	54.00	-8.87	Average	Horizontal
17.265	47.03	32.82	35.82	9.52	53.55	68.20	-14.65	Peak	Vertical
17.265	33.75	32.82	35.82	9.52	40.27	54.00	-13.73	Average	Vertical

Channel 159 / 5795 MHz

Freq GHz	Read Level dBuV	Ant. Fac dB/m	Pre. Fac dB	Cab.Los dB	Measured Level dBuV	Limit Line dBuV/m	Over limit dB	Remark	Pol/Phase
17.385	41.32	33.21	35.82	9.52	48.23	68.20	-19.97	Peak	Horizontal
17.385	40.73	33.21	35.82	9.52	47.64	54.00	-6.36	Average	Horizontal
17.385	46.10	32.82	35.82	9.52	52.62	68.20	-15.58	Peak	Vertical
17.385	37.55	32.82	35.82	9.52	44.07	54.00	-9.93	Average	Vertical

IEEE 802.11ac VHT80

Channel 155 / 5775 MHz

Freq GHz	Read Level dBuV	Ant. Fac dB/m	Pre. Fac dB	Cab.Los dB	Measured Level dBuV	Limit Line dBuV/m	Over limit dB	Remark	Pol
17.325	42.91	33.21	35.82	9.52	49.82	68.20	-18.38	Peak	Horizontal
17.325	35.46	33.21	35.82	9.52	42.37	54.00	-11.63	Average	Horizontal
17.325	41.00	32.82	35.82	9.52	47.52	68.20	-20.68	Peak	Vertical
17.325	32.22	32.82	35.82	9.52	38.74	54.00	-15.26	Average	Vertical

Notes:

- 1). Measuring frequencies from 9 KHz ~ 40GHz, emissions are attenuated more than 20dB below the permissible limits generated frequency to 30MHz.
- 2). Radiated emissions measured in frequency range from 9 KHz ~ 40GHz were made with an instrument using Peak detector mode.
- 3). 18~40GHz at least have 20dB margin. No recording in the test report.
- 4). Worst case data at 6Mbps at IEEE 802.11a; MCS0 at IEEE 802.11n HT20, IEEE 802.11n HT40, IEEE 802.11a VHT20, IEEE 802.11ac VHT40, IEEE 802.11ac VHT80;
- 5). Data of measurement within this frequency range shown "---" in the table above means the reading of emissions are attenuated more than 20dB below the permissible limits or the field strength is too small to be measured.
- 6). Margin=Reading level+Cab loss+Ant Fac-Pre Fac-Limit

5.7. Power Line Conducted Emissions

5.7.1 Standard Applicable

According to §15.207 (a): For an intentional radiator which is designed to be connected to the public utility (AC) power line, the radio frequency voltage that is conducted back onto the AC power line on any frequency or frequencies within the band 150 kHz to 30 MHz shall not exceed 250 microvolts (The limit decreases linearly with the logarithm of the frequency in the range 0.15 MHz to 0.50 MHz). The limits at specific frequency range are listed as follows:

Frequency Range (MHz)	Limits (dBµV)	
	Quasi-peak	Average
0.15 to 0.50	66 to 56*	56 to 46*
0.50 to 5	56	46
5 to 30	60	50

* Decreasing linearly with the logarithm of the frequency

5.7.2 Block Diagram of Test Setup

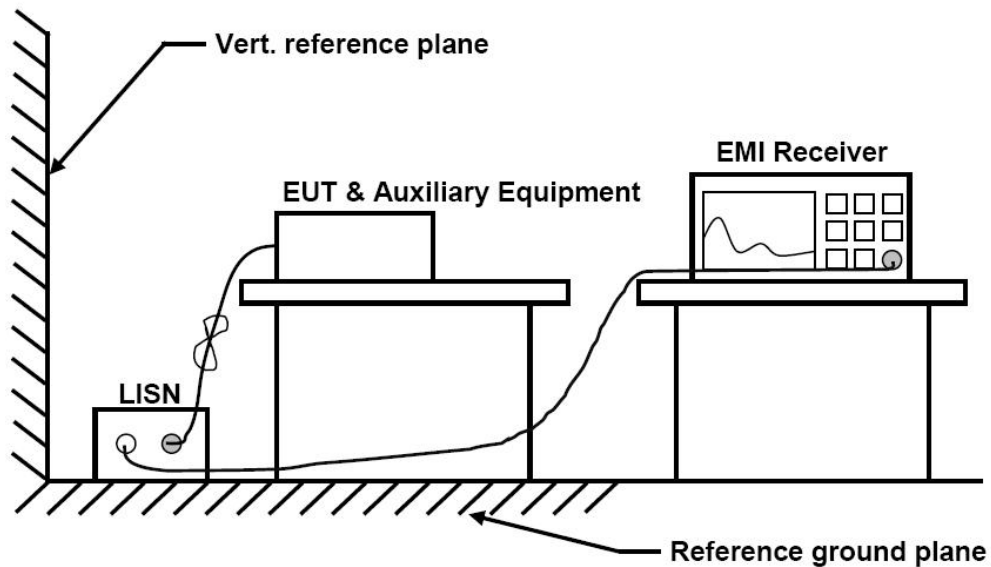

5.7.3 Test Results

PASS.

The test data please refer to following page.

AC Conducted Emission of charge from adapter mode @ AC 120V/60Hz @ (IEEE 802.11ac VHT20 mode) (worst case)

Line

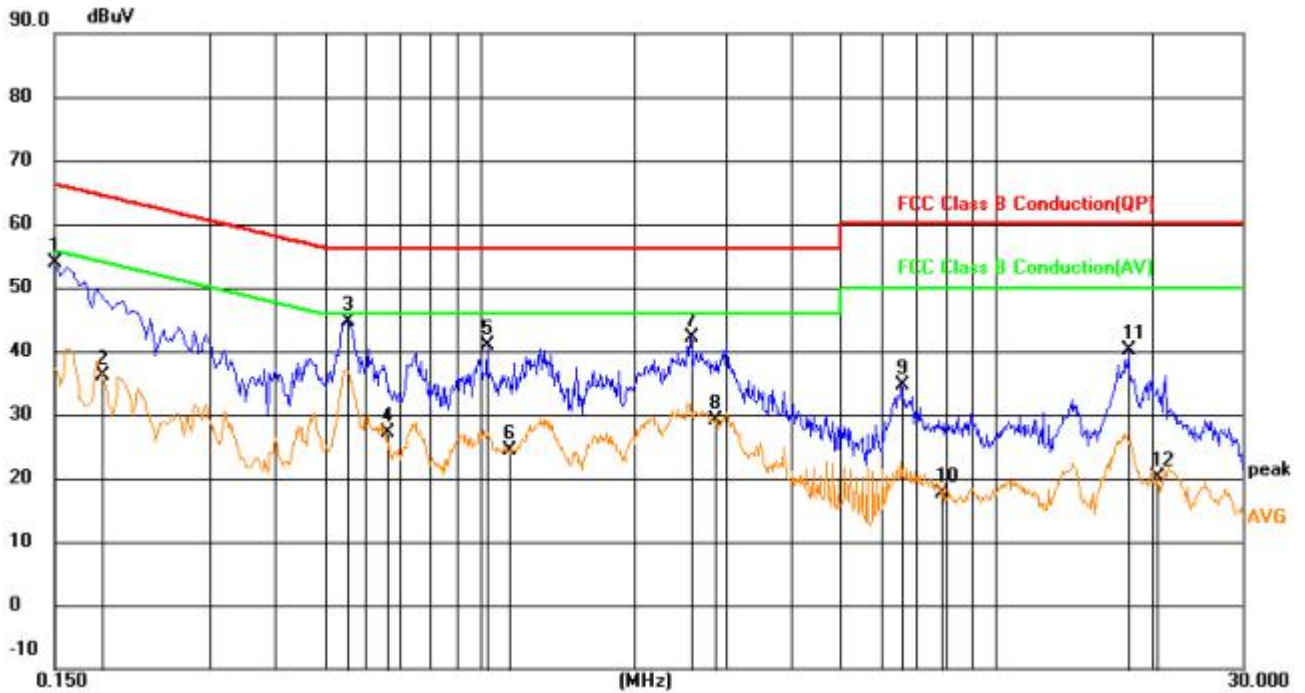

No.	Mk.	Freq. MHz	Reading Level dBuV	Correct Factor dB	Measure- ment dBuV	Limit dBuV	Margin dB	Detector	Comment
1		0.1500	34.80	19.14	53.94	66.00	-12.06	QP	
2		0.1862	17.02	19.17	36.19	54.20	-18.01	AVG	
3	*	0.5548	25.27	19.32	44.59	56.00	-11.41	QP	
4		0.6583	7.96	19.25	27.21	46.00	-18.79	AVG	
5		1.0319	21.58	19.26	40.84	56.00	-15.16	QP	
6		1.1400	5.09	19.28	24.37	46.00	-21.63	AVG	
7		2.5619	22.68	19.45	42.13	56.00	-13.87	QP	
8		2.8500	9.62	19.46	29.08	46.00	-16.92	AVG	
9		6.5849	15.00	19.56	34.56	60.00	-25.44	QP	
10		7.8315	-2.12	19.63	17.51	50.00	-32.49	AVG	
11		18.0419	19.77	20.27	40.04	60.00	-19.96	QP	
12		20.5710	-0.22	20.30	20.08	50.00	-29.92	AVG	

Neutral

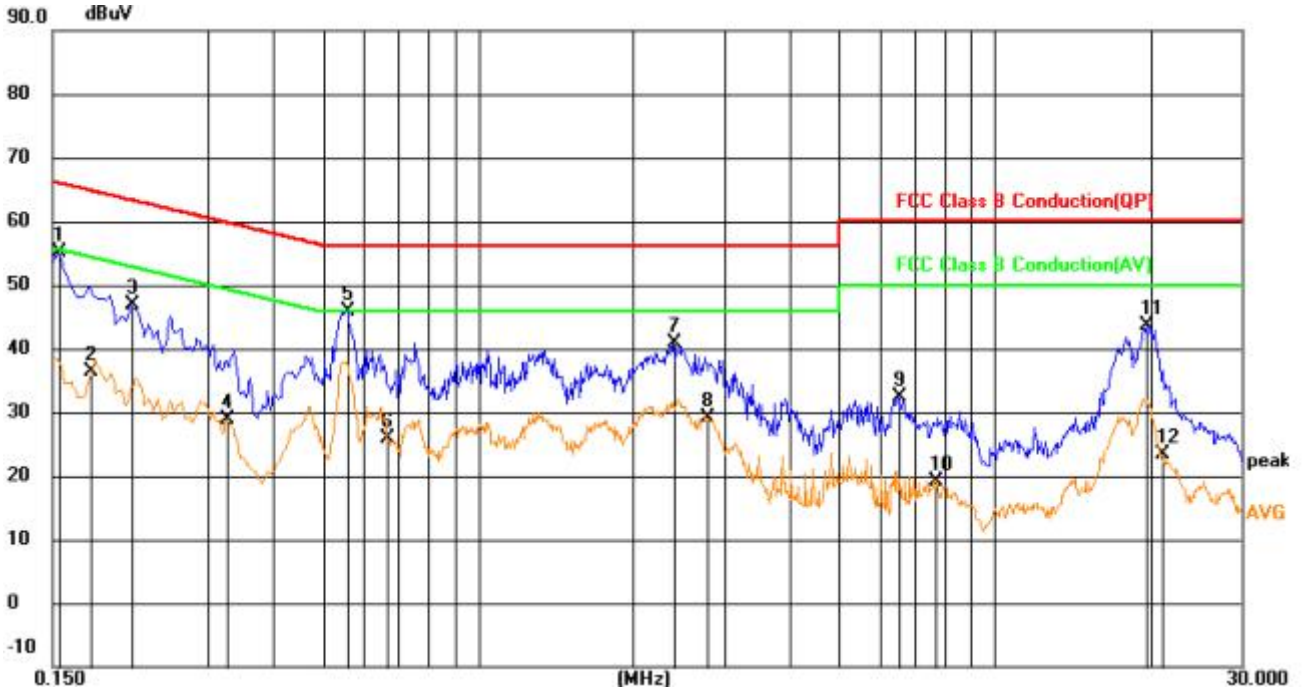

No.	Mk.	Freq. MHz	Reading Level dBuV	Correct Factor dB	Measure- ment dBuV	Limit dBuV	Margin dB	Detector	Comment
1		0.1544	36.07	19.14	55.21	65.76	-10.55	QP	
2		0.1785	17.22	19.17	36.39	54.56	-18.17	AVG	
3		0.2129	27.67	19.19	46.86	63.09	-16.23	QP	
4		0.3255	9.53	19.29	28.82	49.57	-20.75	AVG	
5	*	0.5594	26.49	19.31	45.80	56.00	-10.20	QP	
6		0.6673	6.58	19.24	25.82	46.00	-20.18	AVG	
7		2.3864	21.56	19.43	40.99	56.00	-15.01	QP	
8		2.7734	9.62	19.45	29.07	46.00	-16.93	AVG	
9		6.5038	12.79	19.55	32.34	60.00	-27.66	QP	
10		7.6695	-0.36	19.61	19.25	50.00	-30.75	AVG	
11		19.6980	23.60	20.06	43.66	60.00	-16.34	QP	
12		21.0479	3.34	20.07	23.41	50.00	-26.59	AVG	

***Note: Pre-scan all modes and recorded the worst case results in this report ((IEEE 802.11ac VHT20 mode).

5.8 Undesirable Emissions Measurement

5.8.1 Limit

According to §15.407 (b) Undesirable emission limits. Except as shown in paragraph (b) (7) of this section, the maximum emissions outside of the frequency bands of operation shall be attenuated in accordance with the following limits:

- (a) For transmitters operating in the 5.15-5.25 GHz band: All emissions outside of the 5.15-5.35 GHz band shall not exceed an e.i.r.p. of -27 dBm/MHz.
- (b) For transmitters operating in the 5.25-5.35 GHz band: All emissions outside of the 5.15-5.35 GHz band shall not exceed an e.i.r.p. of -27 dBm/MHz.
- (c) For transmitters operating in the 5.47-5.725 GHz band: All emissions outside of the 5.47-5.725 GHz band shall not exceed an e.i.r.p. of -27 dBm/MHz.
- (d) For transmitters operating in the 5.725-5.85 GHz band:
 - (i) All emissions shall be limited to a level of -27 dBm/MHz at 75 MHz or more above or below the band edge increasing linearly to 10 dBm/MHz at 25 MHz above or below the band edge, and from 25 MHz above or below the band edge increasing linearly to a level of 15.6 dBm/MHz at 5 MHz above or below the band edge, and from 5 MHz above or below the band edge increasing linearly to a level of 27 dBm/MHz at the band edge.
 - (ii) Devices certified before March 2, 2017 with antenna gain greater than 10 dBi may demonstrate compliance with the emission limits in §15.247(d), but manufacturing, marketing and importing of devices certified under this alternative must cease by March 2, 2018. Devices certified before March 2, 2018 with antenna gain of 10 dBi or less may demonstrate compliance with the emission limits in §15.247(d), but manufacturing, marketing and importing of devices certified under this alternative must cease before March 2, 2020.
- (e) The emission measurements shall be performed using a minimum resolution bandwidth of 1 MHz. A lower resolution bandwidth may be employed near the band edge, when necessary, provided the measured energy is integrated to show the total power over 1 MHz.
- (f) Unwanted emissions below 1 GHz must comply with the general field strength limits set forth in §15.209. Further, any U-NII devices using an AC power line are required to comply also with the conducted limits set forth in §15.207.
- (g) The provisions of §15.205 apply to intentional radiators operating under this section.
- (h) When measuring the emission limits, the nominal carrier frequency shall be adjusted as close to the upper and lower frequency band edges as the design of the equipment permits.

5.8.2 Test Configuration

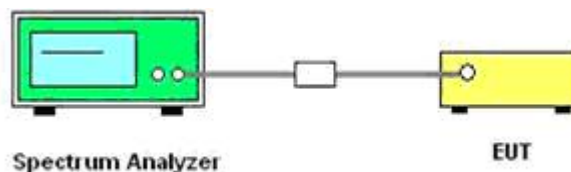

5.8.3 Test Procedure

1. The power was monitored at the coupler port with a Spectrum Analyzer. The power level was set to the maximum level.
2. Set the RBW = 1MHz.
3. Set the VBW \geq 3MHz
4. Number of points in sweep $\geq 2 \times \text{span} / \text{RBW}$. (This ensures that bin-to-bin spacing is $\leq \text{RBW}/2$, so that narrowband signals are not lost between frequency bins.)
5. Manually set sweep time $\geq 10 \times (\text{number of points in sweep}) \times (\text{total on/off period of the transmitted signal})$.
6. Set detector = power averaging (rms).
7. Sweep time = auto couple.
8. Trace mode = max hold.
9. Allow trace to fully stabilize.

5.8.4 Test Results

PASS

Please refer to Appendix E.5.

Remark:

1. *Measured unwanted emission at difference data rate for each mode and recorded worst case for each mode;*
2. *Test results including cable loss;*
3. *Worst case data at 6Mbps at IEEE 802.11a; MCS0 at IEEE 802.11n HT20, IEEE 802.11n HT40, IEEE 802.11a VHT20, IEEE 802.11ac VHT40 and IEEE 802.11ac VHT80;*
4. *E.I.R.P = Conducted power + Antenna Gain;*
5. *EIRP calculation. A value representative of an upper bound on out-of-band antenna gain (in dBi) shall be added to the measured antenna-port conducted emission power to compute EIRP within the specified measurement bandwidth. (For emissions in the restricted bands, additional calculations are required to convert EIRP to field strength at the specified distance.) The upper bound on antenna gain for a device with a single RF output shall be selected as the maximum in-band gain of the antenna across all operating bands or 2 dBi, whichever is greater.3 However, for devices that operate in multiple bands using the same transmit antenna, the highest gain of the antenna within the operating band nearest to the out-of-band frequency being measured may be used in lieu of the overall highest gain when measuring emissions at frequencies within 20% of the absolute frequency at the nearest edge of that band, but in no case shall a value less than 2 dBi be selected;*
6. *Over limit = EIRP – Limit;*

5.9. Frequency Stability

5.9.1 Standard Applicable

According to FCC §15.407(g) "Manufacturers of U-NII devices are responsible for ensuring frequency stability such that an emission is maintained within the band of operation under all conditions of normal operation as specified in the users manual."

According to FCC §2.1055(a) "The frequency stability shall be measured with variation of ambient temperature as follows:"

- (1) From -30° to $+50^{\circ}$ centigrade for all equipment except that specified in paragraphs (a) (2) and (3) of this section.
- (2) From -20° to $+50^{\circ}$ centigrade for equipment to be licensed for use in the Maritime Services under part 80 of this chapter, except for Class A, B, and S Emergency Position Indicating Radiobeacons (EPIRBS), and equipment to be licensed for use above 952 MHz at operational fixed stations in all services, stations in the Local Television Transmission Service and Point-to-Point Microwave Radio Service under part 21 of this chapter, equipment licensed for use aboard aircraft in the Aviation Services under part 87 of this chapter, and equipment authorized for use in the Family Radio Service under part 95 of this chapter.
- (3) From 0° to $+50^{\circ}$ centigrade for equipment to be licensed for use in the Radio Broadcast Services under part 73 of this chapter.

5.9.2 Test Configuration

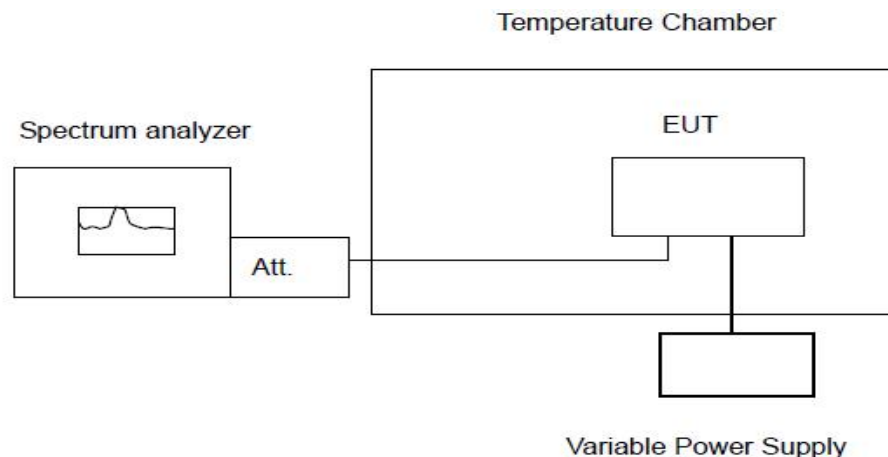

5.9.3 Test Procedure

The equipment under test was connected to an external AC or DC power supply and input rated voltage. RF output was connected to a frequency counter or spectrum analyzer via feed through attenuators. The EUT was placed inside the temperature chamber. Set the spectrum analyzer RBW low enough to obtain the desired frequency resolution and measure EUT 20 degree operating frequency as reference frequency. Turn EUT off and set the chamber temperature to -30 degree. After the temperature stabilized for approximately 30 minutes recorded the frequency. Repeat step measure with 10 degree increased per stage until the highest temperature of +50 degree reached.

5.9.4 Test Results

PASS

Remark:

1. Measured all conditions and recorded worst case.

IEEE 802.11a Mode / 5745 – 5825 MHz / 5745 MHz

Environment Temperature (Degree)	Voltage (V)	Measured Frequency (MHz)	Limit Range (MHz)	Test Results
20	DC 5.5V	5744.035895	5725 – 5850	PASS
20	DC 4.5V	5744.018651	5725 – 5850	PASS
50	DC 5.0V	5744.044102	5725 – 5850	PASS
40	DC 5.0V	5744.064258	5725 – 5850	PASS
30	DC 5.0V	5744.049955	5725 – 5850	PASS
20	DC 5.0V	5744.025557	5725 – 5850	PASS
10	DC 5.0V	5744.096549	5725 – 5850	PASS
0	DC 5.0V	5744.053567	5725 – 5850	PASS
-10	DC 5.0V	5744.000872	5725 – 5850	PASS
-20	DC 5.0V	5744.032362	5725 – 5850	PASS
-30	DC 5.0V	5744.066452	5725 – 5850	PASS

IEEE 802.11a Mode / 5745 – 5825 MHz / 5825 MHz

Environment Temperature (Degree)	Voltage (V)	Measured Frequency (MHz)	Limit Range (MHz)	Test Results
20	DC 5.5V	5825.091183	5725 – 5850	PASS
20	DC 4.5V	5825.065705	5725 – 5850	PASS
50	DC 5.0V	5825.005184	5725 – 5850	PASS
40	DC 5.0V	5825.096707	5725 – 5850	PASS
30	DC 5.0V	5825.000557	5725 – 5850	PASS
20	DC 5.0V	5825.038853	5725 – 5850	PASS
10	DC 5.0V	5825.078935	5725 – 5850	PASS
0	DC 5.0V	5825.010075	5725 – 5850	PASS
-10	DC 5.0V	5825.089750	5725 – 5850	PASS
-20	DC 5.0V	5825.046734	5725 – 5850	PASS
-30	DC 5.0V	5825.001429	5725 – 5850	PASS

5.10. Antenna Requirements

5.10.1 Standard Applicable

For intentional device, according to FCC 47 CFR Section 15.203:

An intentional radiator shall be designed to ensure that no antenna other than that furnished by the responsible party shall be used with the device. The use of a permanently attached antenna or of an antenna that uses a unique coupling to the intentional radiator, the manufacturer may design the unit so that a broken antenna can be replaced by the user, but the use of a standard antenna jack or electrical connector is prohibited

And according to FCC 47 CFR Section 15.407 (a), if transmitting antennas of directional gain greater than 6dBi are used, the power shall be reduced by the amount in dB that the directional gain of the antenna exceeds 6dBi.

5.10.2 Antenna Connected Construction

5.10.2.1. Standard Applicable

According to § 15.203 & RSS-Gen, an intentional radiator shall be designed to ensure that no antenna other than that furnished by the responsible party shall be used with the device.

5.10.2.2. Antenna Connector Construction

The gains of antennas used for transmitting are 2.0dBi, and the antennas are Internal Antennas connect to PCB board and no consideration of replacement. Please see EUT photo for details.

5.10.2.3. Results: Compliance.

6. LIST OF MEASURING EQUIPMENTS

Item	Equipment	Manufacturer	Model No.	Serial No.	Cal Date	Due Date
1	Power Meter	R&S	NRVS	100444	2020-06-22	2021-06-21
2	Power Sensor	R&S	NRV-Z81	100458	2020-06-22	2021-06-21
3	Power Sensor	R&S	NRV-Z32	10057	2020-06-22	2021-06-21
4	Test Software	Tonscend	JS1120-2	/	N/A	N/A
5	RF Control Unit	Tonscend	JS0806-2	N/A	2020-06-22	2021-06-21
6	MXA Signal Analyzer	Agilent	N9020A	MY50510140	2019-11-22	2020-11-21
7	DC Power Supply	Agilent	E3642A	N/A	2019-11-14	2020-11-13
8	EMI Test Software	AUDIX	E3	/	N/A	N/A
9	3m Semi Anechoic Chamber	SIDT FRANKONIA	SAC-3M	03CH03-HY	2019-09-27	2020-09-26
10	Positioning Controller	MF	MF-7082	N/A	2020-06-22	2021-06-21
11	Active Loop Antenna	SCHWARZBECK	FMZB 1519B	00005	2018-07-26	2021-07-25
12	By-log Antenna	SCHWARZBECK	VULB9163	9163-470	2018-07-26	2021-07-25
13	Horn Antenna	SCHWARZBECK	BBHA 9120D	9120D-1925	2018-07-02	2021-07-01
14	Broadband Horn Antenna	SCHWARZBECK	BBHA 9170	791	2017-09-21	2020-09-20
15	Broadband Preamplifier	SCHWARZBECK	BBV 9719	9719-025	2020-06-22	2021-06-21
16	EMI Test Receiver	R&S	ESR 7	101181	2020-06-22	2021-06-21
17	RS SPECTRUM ANALYZER	R&S	FSP40	100503	2019-11-14	2020-11-13
18	Broadband Preamplifier	/	BP-01M18G	P190501	2020-06-22	2021-06-21
19	RF Cable-R03m	Jye Bao	RG142	CB021	2020-06-22	2021-06-21
20	RF Cable-HIGH	SUHNER	SUCOFLEX 106	03CH03-HY	2020-06-22	2021-06-21
21	6dB Attenuator	/	100W/6dB	1172040	2020-06-22	2021-06-21
22	3dB Attenuator	/	2N-3dB	/	2020-06-22	2021-06-21
23	EMI Test Receiver	R&S	ESPI	101840	2020-06-22	2021-06-21
24	Artificial Mains	R&S	ENV216	101288	2020-06-22	2021-06-21
25	10dB Attenuator	HWARZBECK	MTS-IMP-136	261115-001-0032	2020-06-22	2021-06-21

Note: All equipment is calibrated through CHINA CEPREI LABORATORY and GUANGZHOU LISAI CALIBRATION AND TEST CO., LTD.

7. TEST SETUP PHOTOGRAPHS OF EUT

Please refer to separated files for Test Setup Photos of the EUT.

8. EXTERIOR PHOTOGRAPHS OF THE EUT

Please refer to separated files for External Photos of the EUT.

9. INTERIOR PHOTOGRAPHS OF THE EUT

Please refer to separated files for Internal Photos of the EUT.

-----THE END OF REPORT-----