

# Artika For Living Inc

## TEST REPORT

**SCOPE OF WORK**

EMC TESTING–EH1227(TL-SB-XXXXX)

**REPORT NUMBER**

230613032GZU-001

**ISSUE DATE**

12-July-2023

**[REVISED DATE]**

[-----]

**PAGES**

15

**DOCUMENT CONTROL NUMBER**

FCC Part 15:2021-a

© 2022 INTERTEK



## TEST REPORT

Applicant Name & Address : Artika For Living Inc  
1756, 50th ave, Lachine Quebec, H8T 2V5 Canada  
Manufacturing Site : Dongguan City Tianhua Photoelectric Technology Co., Ltd  
#3, 2nd Road Jinqianling Industrial Zone, Jitigang Village, Huangjiang  
Town, Dongguan City-523757, Guangdong, China  
Intertek Report No: 230613032GZU-001  
FCC ID : 2AUHG-TL-SB

## Test standards

**CFR 47, FCC Part 15, Subpart B:2021**

## Sample Description

Product : Swirl Butterfly Chrome Table Lamp  
Model No. : EH1227(TL-SB-XXXXX)  
"Remark: XXXXX are represent different customers. X=0-9 or A-Z"  
Electrical Rating : 100-240V 50/60Hz, 10.3W  
Serial No. : Not Labeled  
Date Received : 13 June 2023  
Date Test : 13 June 2023-05 July 2023  
Conducted

Prepared and Checked By

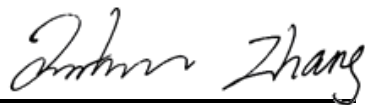

Jackson Zhang

Sr. Project Engineer

Approved By:



Sky Zhu

Supervisor

This report is for the exclusive use of Intertek's Client and is provided pursuant to the agreement between Intertek and its Client. Intertek's responsibility and liability are limited to the terms and conditions of the agreement. Intertek assumes no liability to any party, other than to the Client in accordance with the agreement, for any loss, expense or damage occasioned by the use of this report. Only the Client is authorized to permit copying or distribution of this report and then only in its entirety. Any use of the Intertek name or one of its marks for the sale or advertisement of the tested material, product or service must first be approved in writing by Intertek. The observations and test results in this report are relevant only to the sample tested. This report by itself does not imply that the material, product, or service is or has ever been under an Intertek certification program.

Intertek Testing Services Shenzhen Ltd. Guangzhou Branch  
Room 02, & 101/E201/E301/E401/E501/E601/E701/E801 of Room 01 1-8/F., No. 7-2. Caipin Road, Science City, GETDD,  
Guangzhou, Guangdong, China

**TEST REPORT**

**CONTENT**

**TEST REPORT ..... 1**

**CONTENT ..... 3**

**1. TEST RESULTS SUMMARY ..... 4**

**2. EMC RESULTS CONCLUSION..... 5**

**3. LABORATORY MEASUREMENTS..... 6**

**4. EQUIPMENT USED DURING TEST ..... 7**

**5. EMI TEST..... 8**

5.1 CONDUCTED DISTURBANCE VOLTAGE AT MAINS PORTS ..... 8

5.1.1 *Block Diagram of Test Setup*..... 8

5.1.2 *Test Setup and Procedure* ..... 8

5.1.3 *Limit*..... 9

5.1.4 *Test Data and curve*..... 10

5.2 RADIATED EMISSION 30 MHz -1000 MHz ..... 12

5.2.1 *Block Diagram of Test Setup*..... 12

5.2.2 *Test Setup and Procedure* ..... 12

5.2.3 *Limit*..... 13

5.2.4 *Test Data and Curve* ..... 14

5.3 RADIATED EMISSION ABOVE 1 GHZ ..... 15

**TEST REPORT****1. TEST RESULTS SUMMARY**

Classification of EUT: Class B

Test Item	Standard	Result
Conducted disturbance voltage at mains ports	CFR 47, FCC Part 15, Subpart B	Pass
Radiated emission (30 MHz–1 GHz)	CFR 47, FCC Part 15, Subpart B	Pass
Radiated emission (Above 1 GHz)	CFR 47, FCC Part 15, Subpart B	N/A
Remark: Reference publication is used for methods of measurement: ANSI C63.4:2014		

Remark:

1. The symbol "N/A" in above table means Not Applicable.
2. When determining the test results, measurement uncertainty of tests has been considered.

## TEST REPORT

### 2. EMC RESULTS CONCLUSION

RE: EMC Testing Pursuant to FCC part 15 performed on the Swirl Butterfly Chrome Table Lamp, Model: EH1227(TL-SB-XXXXX).

We tested the Swirl Butterfly Chrome Table Lamp, Model: EH1227(TL-SB-HD2CR), to determine if it was in compliance with the relevant standards as marked on the Test Results Summary. We found that the unit met the requirement of FCC part 15 standard when tested as received. The worst case's test data was presented in this test report.

All models are same except model name. XXXXX are represent different customers. X=0-9 or A-Z.

Based on the above differences select EH1227(TL-SB-HD2CR) perform all tests.

The production units are required to conform to the initial sample as received when the units are placed on the market.

## TEST REPORT

### 3. LABORATORY MEASUREMENTS

#### Configuration Information

Support Equipment:	N/A
Rated Voltage and frequency under test:	120 V~; 60 Hz
Condition of Environment:	Temperature: 22~28°C Relative Humidity:35~60% Atmosphere Pressure:86~106kPa

#### Notes:

1. The EMI measurements had been made in the operating mode produced the largest emission in the frequency band being investigated consistent with normal applications. An attempt had been made to maximize the emission by varying the configuration of the EUT.

#### 2. Test Facility accreditation:

A2LA Certificate Number 0078.10

Intertek Testing Services Shenzhen Ltd. Guangzhou Branch is accredited by A2LA and Listed in FCC website. FCC accredited test labs may perform both Certification testing under Parts 15 and 18 and Declaration of Conformity testing.

#### 3. Test Location:

Intertek Testing Services Shenzhen Ltd. Guangzhou Branch

All tests were performed at:

Room 02, & 101/E201/E301/E401/E501/E601/E701/E801 of Room 01 1-8/F., No. 7-2. Caipin Road, Science City, GETDD, Guangzhou, Guangdong, China

Except Radiated Emissions was performed at:

Room 102/104, No 203, KeZhu Road, Science City, GETDD Guangzhou, China

#### 4. Measurement Uncertainty

No.	Item	Measurement Uncertainty
1	Conducted Emission (9 kHz-150 kHz)	2.54 dB
2	Conducted Emission (150 kHz-30 MHz)	2.51 dB
3	Disturbance Power (30 MHz-300 MHz)	3.13 dB
4	Radiated Emission (9 kHz-30 MHz)	4.15 dB
5	Radiated Emission (30 MHz-1 GHz)	4.62 dB
6	Radiated Emission (1 GHz-6 GHz)	4.67 dB
7	Radiated Emission (6 GHz-18 GHz)	4.76 dB

The measurement uncertainty describes the overall uncertainty of the given measured value during the operation of the EUT.

Measurement uncertainty is calculated in accordance with CISPR16-4-2:2011+A1:2014 +A2:2018.

The measurement uncertainty is given with a confidence of 95%, k=2.

Determination of the test conclusion is based on IEC Guide 115 in consideration of measurement uncertainty.

## TEST REPORT

### 4. EQUIPMENT USED DURING TEST

#### Conducted Disturbance-Mains Terminal (2)

Equipment No.	Equipment	Model	Manufacturer	Cal. Due date (DD-MM-YYYY)	Calibration Interval
EM031-04	EMI receiver	ESR3	R&S	06/01/2023	1Y
EM006-06	LISN	ENV216	R&S	05/09/2023	1Y
SA047-111	Digital Temperature-Humidity Recorder	RS210	YIJIE	22/11/2022	1Y
EM004-03	EMC shield Room	8m×4m×3m	Zhongyu	06/01/2023	1Y
EM031-04-01	EMC32 software (CE)	V10.01.00	R&S	N/A	N/A

#### Radiated Disturbance (30 MHz-1 GHz)

Equipment No.	Equipment	Model	Manufacturer	Cal. Due date (DD-MM-YYYY)	Calibration Interval
EM030-04	3m Semi-Anechoic Chamber	9×6×6 m3	ETS-LINDGREN	7/04/2023	1Y
EM031-02	EMI Test Receiver (9 kHz~7 GHz)	R&S ESR7	R&S	16/11/2022	1Y
EM033-01	TRILOG Super Broadband test Antenna (30MHz-3GHz)	VULB 9163	SCHWARZBECK	18/10/2022	1Y
EM031-02-01	Coaxial cable	/	R&S	8/04/2023	1Y
EM036-01	Common-mode absorbing clamp	CMAD 20B	TESEQ	17/07/2023	1Y
SA047-118	Digital Temperature-Humidity Recorder	RS210	YIJIE	15/07/2023	1Y
EM045-01-01	EMC32 software (RE/RS)	V10.01.00	R&S	N/A	N/A

## TEST REPORT

### 5. EMI TEST

#### 5.1 Conducted Disturbance Voltage at mains ports

**Test Result: Pass**

##### 5.1.1 Block Diagram of Test Setup

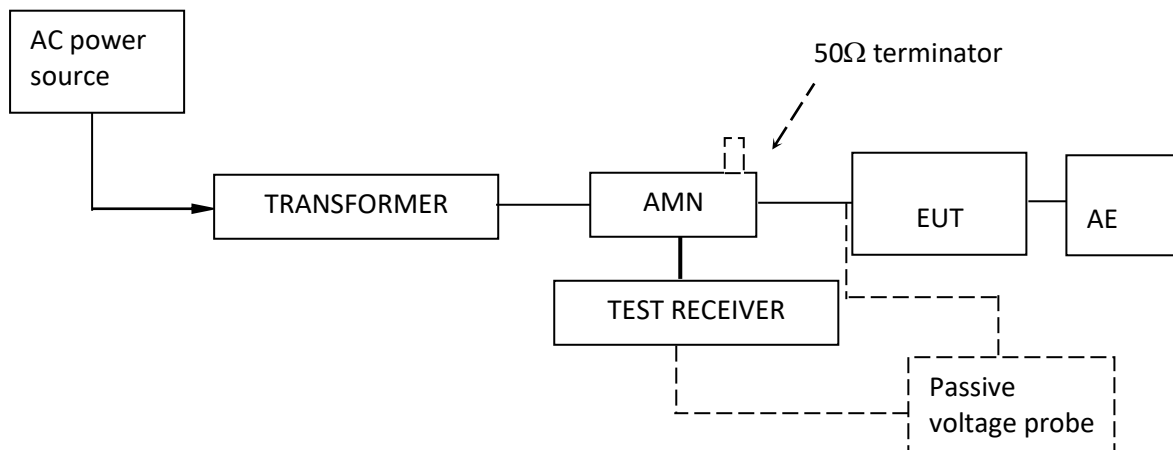

##### 5.1.2 Test Setup and Procedure

The EUT was set to achieve the maximum emission level. The mains terminal disturbance voltage was measured with the EUT in a shielded room. The EUT was connected to AC power source through an Artificial Mains Network which provides a 50Ω linear impedance. Artificial hand is used if appropriate (for handheld apparatus). The load/control terminal disturbance voltage was measured with passive voltage probe if appropriate.

The table-top EUT was placed on a 0.8m high non-metallic table above earthed ground plane (Ground Reference Plane). And for floor standing EUT, was placed on a 0.1m high non-metallic supported on GRP. The EUT keeps a distance of at least 0.8m from any other of the metallic surface. The Artificial Mains Network is situated at a distance of 0.8m from the EUT. During the test, mains lead of EUT excess 0.8m was folded back and forth parallel to the lead so as to form a horizontal bundle with a length between 0.3m and 0.4m.

The bandwidth of test receiver was set at 9 kHz. The frequency range from 150 kHz to 30MHz was checked.



**TEST REPORT****5.1.3 Limit**

Frequency range MHz	AC mains terminals dB (uV)	
	Quasi-peak	Average
0.15 to 0.5	66 to 56*	56 to 46*
0.5 to 5	56	46
5 to 30	60	50

Note 1: The limit decreases linearly with the logarithm of the frequency in the range 0.15 MHz to 0.5 MHz.

Note 2: The lower limit is applicable at the transition frequency.

**TEST REPORT**

**5.1.4 Test Data and curve**

**At mains terminal:**

**Tested Wire: Live**

**Operation Mode: EUT on High Lighting**

Full Spectrum

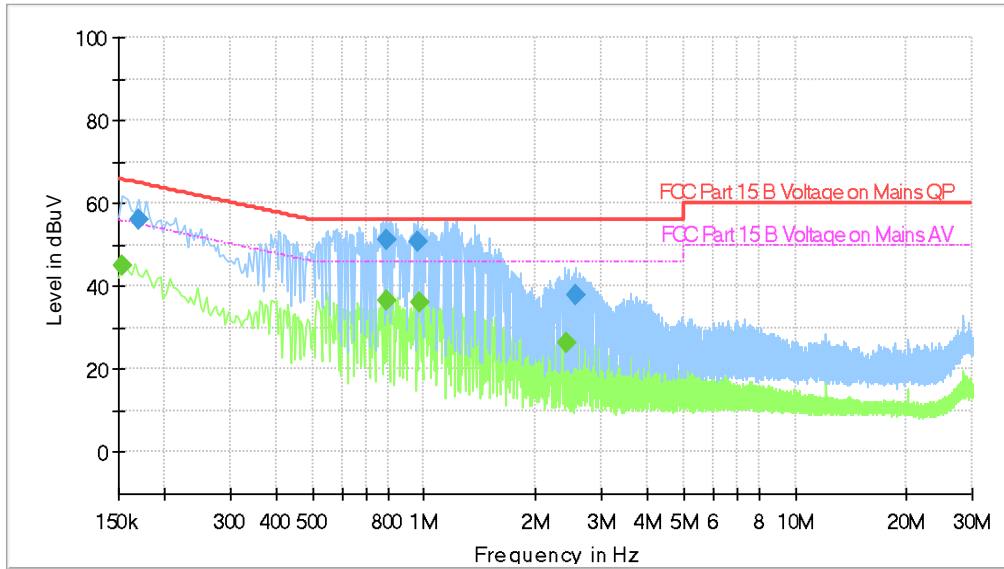

**Final Result**

Frequency (MHz)	QuasiPeak (dBuV)	CAverage (dBuV)	Limit (dBuV)	Margin (dB)	Meas. Time (ms)	Bandwidth (kHz)	Line	Filter	Corr. (dB)
0.154000	---	45.21	55.78	10.57	1000.0	9.000	L1	ON	9.6
0.170000	55.92	---	64.96	9.04	1000.0	9.000	L1	ON	9.6
0.790000	---	36.46	46.00	9.54	1000.0	9.000	L1	ON	9.6
0.790000	51.13	---	56.00	4.87	1000.0	9.000	L1	ON	9.6
0.962000	50.72	---	56.00	5.28	1000.0	9.000	L1	ON	9.6
0.970000	---	36.25	46.00	9.75	1000.0	9.000	L1	ON	9.6
2.430000	---	26.29	46.00	19.71	1000.0	9.000	L1	ON	9.7
2.558000	37.97	---	56.00	18.03	1000.0	9.000	L1	ON	9.7

**TEST REPORT**

**Tested Wire: Neutral**

**Operation Mode: EUT on High Lighting**

Full Spectrum

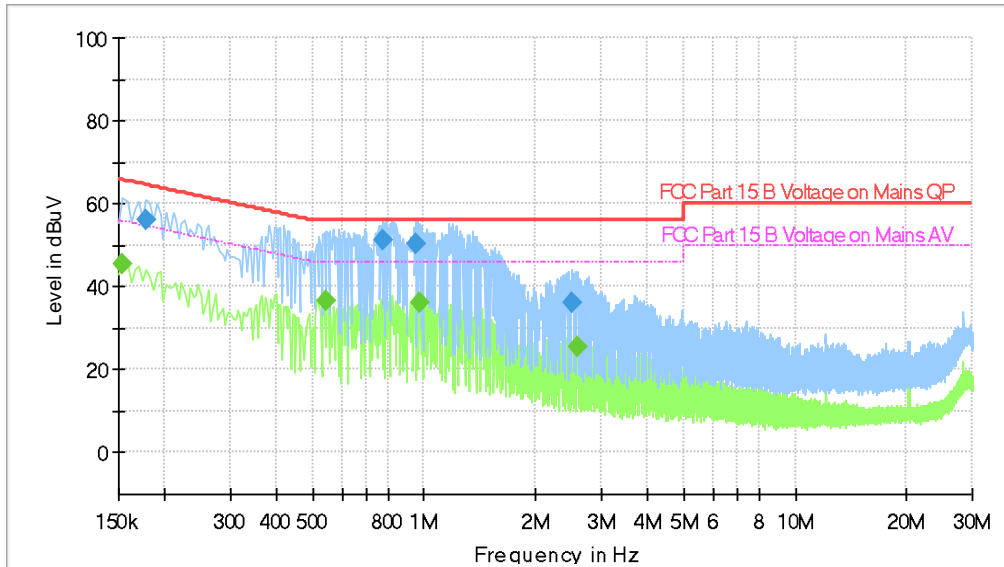

**Final\_Result**

Frequency (MHz)	QuasiPeak (dBuV)	CAverage (dBuV)	Limit (dBuV)	Margin (dB)	Meas. Time (ms)	Bandwidth (kHz)	Line	Filter	Corr. (dB)
0.154000	---	45.49	55.78	10.30	1000.0	9.000	N	ON	9.5
0.178000	56.21	---	64.58	8.37	1000.0	9.000	N	ON	9.5
0.546000	---	36.71	46.00	9.29	1000.0	9.000	N	ON	9.5
0.778000	51.16	---	56.00	4.84	1000.0	9.000	N	ON	9.5
0.950000	50.20	---	56.00	5.80	1000.0	9.000	N	ON	9.5
0.974000	---	35.93	46.00	10.07	1000.0	9.000	N	ON	9.5
2.510000	36.04	---	56.00	19.96	1000.0	9.000	N	ON	9.5
2.578000	---	25.57	46.00	20.43	1000.0	9.000	N	ON	9.5

## TEST REPORT

### 5.2 Radiated Emission 30 MHz -1000 MHz

Test Result: Pass

#### 5.2.1 Block Diagram of Test Setup

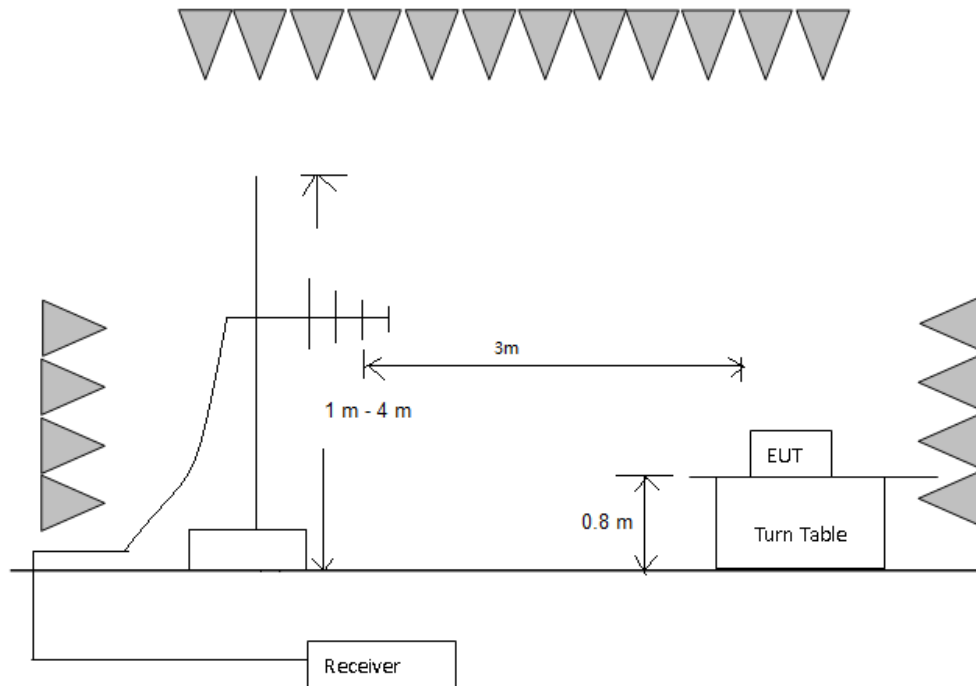

#### 5.2.2 Test Setup and Procedure

The measurement was applied in a semi-anechoic chamber. The EUT and simulators were placed on a 0.8 m high foamed table above the horizontal metal ground plane. The turn table rotated 360 degrees to determine the position of the maximum emission level. The EUT was set 3 meters away from the receiving antenna which was mounted on an antenna mask. The antenna moved up and down between from 1 meter to 4 meters to find out the maximum emission level.

Broadband antenna was used as receiving antenna. Both horizontal and vertical polarization of the antenna was set on measurement. In order to find the maximum emission, all of the interface cables were manipulated according to ANSI C63.4 requirement during radiated test. The bandwidth setting on R&S Test Receiver was 120 kHz.

For an unintentional radiator, including a digital device, the spectrum shall be investigated from the lowest radio frequency signal generated or used in the device, without going below the lowest frequency for which a radiated emission limit is specified, up to the frequency shown in the following table:

## TEST REPORT

Highest frequency generated or used in the device or on which the device operates or tunes (MHz)	Upper Frequency of Radiated Measurement
Below 1.705 MHz	30MHz
1.705 MHz – 108 MHz	1 GHz
108 MHz – 500 MHz	2 GHz
500 MHz – 1 GHz	5 GHz
Above 1 GHz	5th harmonic of the highest frequency or 40 GHz, whichever is lower.
At transitional frequencies the lower limit applies.	

Remark: Radiated Emission was performed from 30 MHz to 1 GHz.

### 5.2.3 Limit

Class B limit at 3m test distance:

Frequency range MHz	Quasi-peak limits dB (μV/m)
30 to 88	40
88 to 216	43.5
216 to 960	46
960 to 1000	54
At transitional frequencies the lower limit applies.	

## TEST REPORT

### 5.2.4 Test Data and Curve

Operation Mode: EUT on High Lighting  
Horizontal

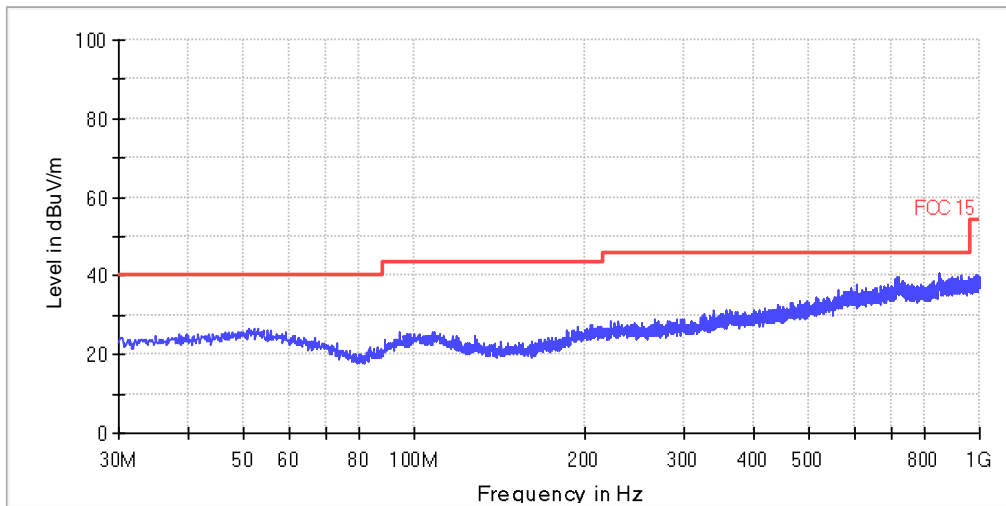

All emission levels are more than 6 dB below the limit.

Vertical

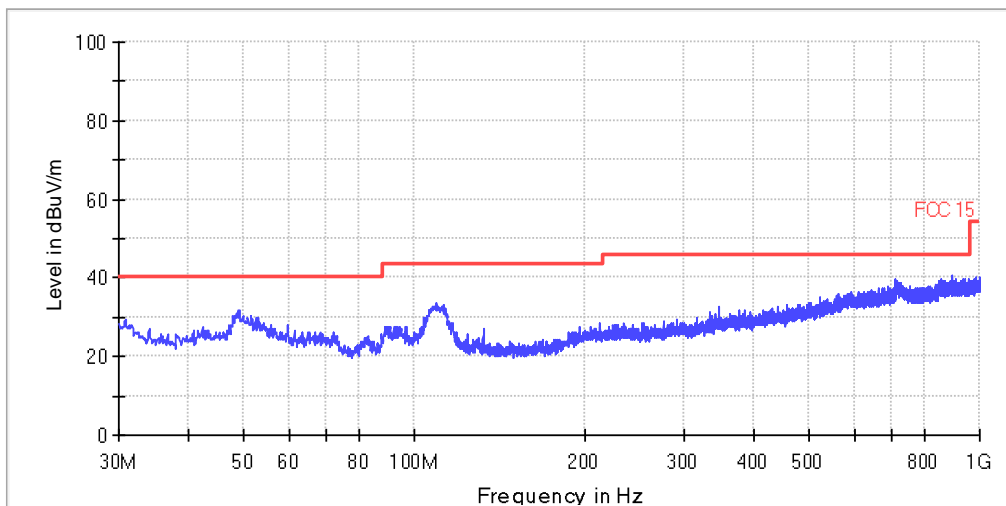

All emission levels are more than 6 dB below the limit.

**TEST REPORT**

**5.3 Radiated Emission above 1 GHz**

**Test Result: Not Applicable**

**Remark:**

The highest internal source of the EUT is not more than 108 MHz, so the measurement above 1000 MHz is not applicable.

\*\*\*\*\*End of Report\*\*\*\*\*