

FCC TEST REPORT

Report No. : NTC-ER2303043

Applicant's name : Artika For Living Inc

Address : 1756 50th avenue, Lachine, Qc, Canada H8T 2V5

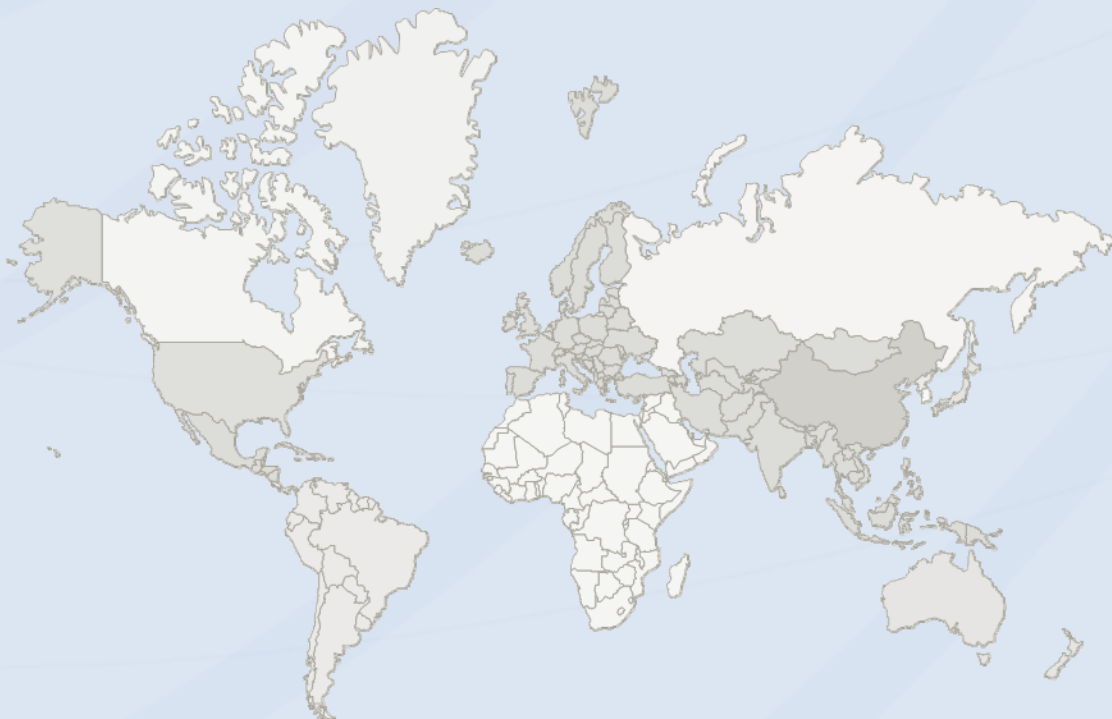

DONGGUAN NEW TESTING CENTRE CO., LTD

Ⓞ Address: 1F & 3F, No. 1 the 1st North Industry Road Songshan Lake Science & Technology Park Dongguan, People's Republic of China 523808

☎ Tel: +86-769-22212079

🌐 Web: <http://www.ntc-cert.com>

✉ E-mail: dave@ntc-cert.com

TABLE OF CONTENTS

Test Report Declare	2
1. Summary of test results	4
2. General test information	4
2.1. Description of EUT	4
2.2. Detail models	4
2.3. Block diagram EUT configuration for test	4
2.4. Test environment conditions	5
2.5. Measurement uncertainty	5
2.6. Test Laboratory	5
3. Power Line Conducted Emission Test	6
3.1. Test equipment	6
3.2. Block diagram of test setup	6
3.3. Power Line Conducted Emission Limits (Class B)	6
3.4. Test Procedure	7
3.5. Test Result	7
4. Radiated emission test	10
4.1. Test equipment	10
4.2. Block diagram of test setup	10
4.3. Radiated emission limit (Class B)	11
4.4. Test Procedure	11
4.5. Test result	12
5. Test setup photograph	14
5.1. Photos of power line conducted emission test	14
5.2. Photos of radiated emission test	14
6. Photos of the EUT	15

TEST REPORT DECLARE

FCC ID	: 2AUHG-PDT-AR5C
Applicant	: Artika For Living Inc
Address	: 1756 50th avenue, Lachine, Qc, Canada H8T 2V5
Equipment under Test	: Led pedant light
Model No	: PDT-AR5C:followed by up to ten characters
Trade Mark	: ARTIKA
Manufacturer	: DongGuan City Rising Stars Lighting Co.,LTD
Address	: YuanQuan No.6 Bai Hao Village HouJie Town DongGuanCity GuangDong Province China
Test Laboratory	: Dongguan New Testing Centre Co., Ltd
Address	: 1F & 3F, No. 1 the 1st North Industry Road Songshan Lake Science & Technology Park Dongguan, People's Republic of China 523808

Test Standard Used:

FCC Rules and Regulations Part 15 Subpart B Class B; ANSI C63.4:2014.

We Declare:

The equipment described above is tested by Dongguan New Testing Centre Co., Ltd and in the configuration tested the equipment complied with the standards specified above (class B). The test results are contained in this test report and Dongguan New Testing Centre Co., Ltd is assumed of full responsibility for the accuracy and completeness of these tests.

After test and evaluation, our opinion is that the equipment provided for test compliance with the requirement of the above FCC standards.

Report No.:	NTC-ER2303043		
Date of Test:	Apr.06, 2023 to Apr.11, 2023	Date of Report:	Apr.12, 2023

Prepared By:

Taylor Chen

Taylor Chen /Engineer

Approved By:



Dave Gao/LAB Manager

Note: This report applies to above tested sample only. This report shall not be reproduced in parts without written approval of Dongguan New Testing Centre Co., Ltd

**** Modified History ****

Revisions	Description	Issued Data	Report No.	Remark
Version 1.0	Initial Test Report Release	2023-04-12	NTC-ER2303043	Dave Gao

1. Summary of test results

Description of Test Item	Standard	Limits	Results
Power Line Conducted Emission Test	FCC Part 15: Subpart B ANSI C63.4: 2014	Class B	PASS
Radiated Emission Test	FCC Part 15: Subpart B ANSI C63.4: 2014	Class B	PASS

2. General test information

2.1. Description of EUT

EUT* Name	: Led pedant light
Model Number	: PDT-AR5C
EUT function description	: Please reference user manual of this device
Rating	: AC120V 60Hz 30W
Trade mark	: ARTIKA
EUT Class	: Class B, intended primarily for use in the domestic environment
Maximum work frequency	: <108MHz
Sample Type	: Series production

Note: 1,EUT is the abbreviation of equipment under test.

2.2. Detail models

Model	Rating	Note
PDT-AR5C	AC120V 60Hz 30W	PDT-AR5C:followed by up to ten characters

Note: These models of circuits are similar.

2.3. Block diagram EUT configuration for test

For EUT ON mode:

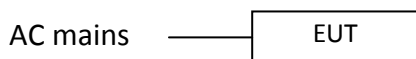

2.4. Test environment conditions

During the measurement the environmental conditions were within the listed ranges:

Temperature range:	21-25°C
Humidity range:	40-75%
Pressure range:	86-106kPa

2.5. Measurement uncertainty

Test Item	Uncertainty
Uncertainty for Conduction emission test	3.2dB
Uncertainty for Radiation Emission test	4.6 dB (Polarize: V)
	4.6 dB (Polarize: H)

Note: This uncertainty represents an expanded uncertainty expressed at approximately the 95% confidence level using a coverage factor of k=2.

2.6. Test Laboratory

Dongguan New Testing Centre Co., Ltd
Add: 1F & 3F, No. 1 the 1st North Industry Road Songshan Lake Science & Technology Park Dongguan,
People's Republic of China 523808.
Tel: +86-769-22212079; Web: <http://www.ntc-cert.com>; E-mail: dave@ntc-cert.com
A2LA Accreditation No. 5426.01

3. Power Line Conducted Emission Test

3.1. Test equipment

Item	Equipment	Manufacturer	Model No.	Serial No.	Last Cal.	Cal. Interval
1	Test Receiver	R&S	ESPI	100146	2022-05-20	1 Year
2	LISN	R&S	ENV216	3650.6550.06	2022-05-20	1 Year
3	LISN	KHC	KH3765	37650053	2022-05-20	1 Year
4	8-WIRE ISN for CAT6	R&S	ENY81-CA6	101862	2022-05-20	1 Year
5	RF Cable	HUBER	SUCOFLEX100	30722/4E	2021-05-21	2 Year
6	MEASUREMENT SOFTWARE	FARAD	EZ-EMC(VER:1.1.4.2)	N/A	N/A	N/A

3.2. Block diagram of test setup

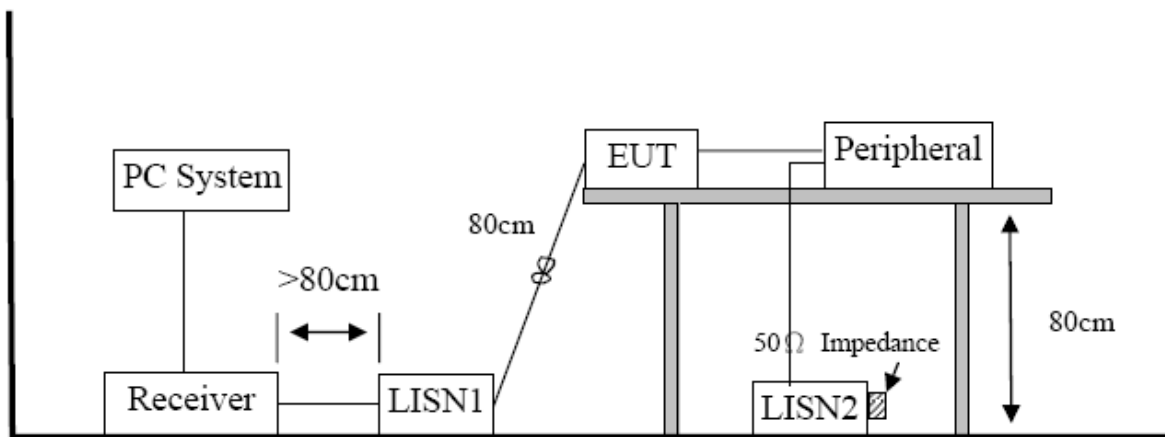

3.3. Power Line Conducted Emission Limits (Class B)

Frequency	Quasi-Peak Level dB(μV)	Average Level dB(μV)
150kHz ~ 500kHz	66 ~ 56*	56 ~ 46*
500kHz ~ 5MHz	56	46
5MHz ~ 30MHz	60	50

Note 1: * Decreasing linearly with logarithm of frequency.

Note 2: The lower limit shall apply at the transition frequencies.

3.4. Test Procedure

The EUT and Support equipment, if needed, were put placed on a non-metallic table, 80cm above the ground plane.

Configuration EUT to simulate typical usage as described in clause 2.3 and test equipment as described in clause 3.2 of this report.

All I/O cables were positioned to simulate typical actual usage as per ANSI C63.4.

All support equipment power received from a second LISN.

Emissions were measured on each current carrying line of the EUT using an EMI Test Receiver connected to the LISN powering the EUT.

The Receiver scanned from 150 kHz to 30MHz for emissions in each of the test modes.

During the above scans, the emissions were maximized by cable manipulation.

The test mode(s) described in clause 2.3 were scanned during the preliminary test.

After the preliminary scan, we found the test mode producing the highest emission level.

The EUT configuration and worse cable configuration of the above highest emission levels were recorded for reference of the final test.

EUT and support equipment were set up on the test bench as per the configuration with highest emission level in the preliminary test.

A scan was taken on both power lines, Neutral and Line, recording at least the six highest emissions. Emission frequency and amplitude were recorded into a computer in which correction factors were used to calculate the emission level and compare reading to the applicable limit.

The test data of the worst-case condition(s) was recorded.

The bandwidth of test receiver is set at 9 KHz.

3.5. Test Result

PASS. (See below detailed test result)

Note1: All emissions not reported below are too low against the prescribed limits.

Note2: "-----" means Peak detection; "-----" means Average detection.

Note3: Measurement = Reading Level + Factor, Margin= Measurement-Limit.

Conducted Emission Test Result

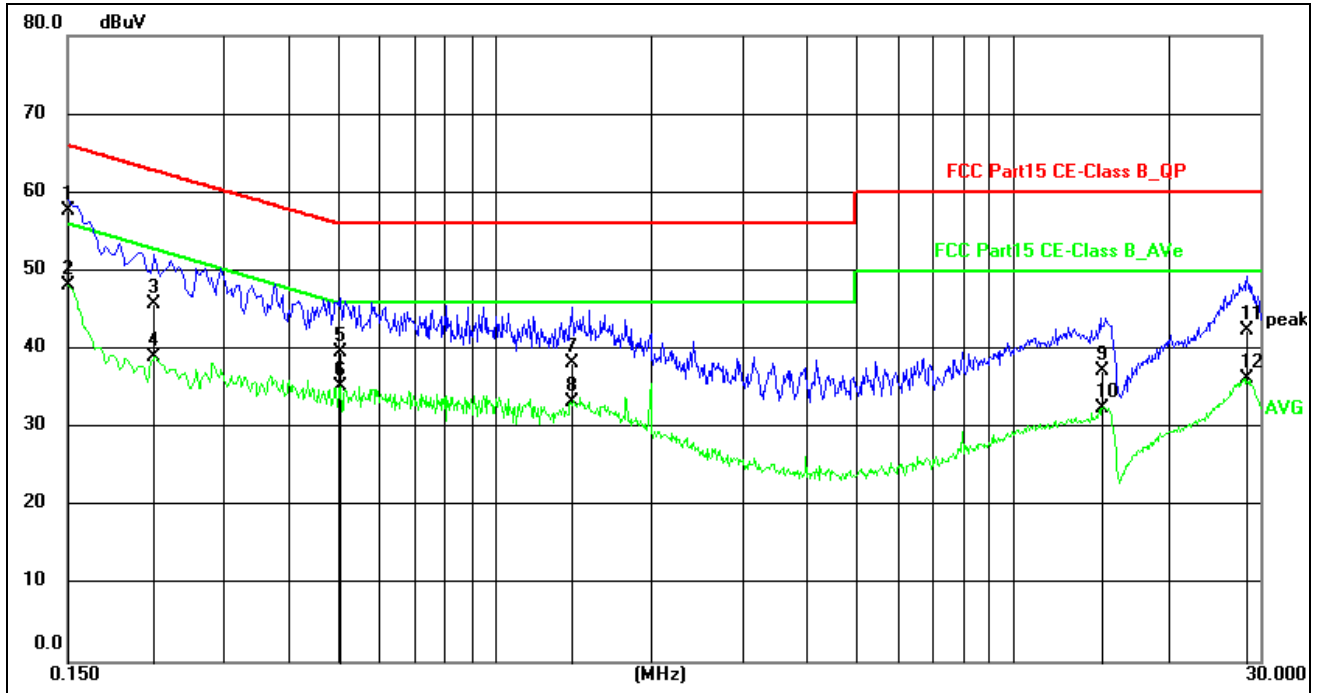

Site:	844LAB	Phase:L1	Temperature(C):25(C)
Limit:	FCC Part15 CE-Class B_QP		Humidity(%):64%
EUT:	Led pedant light	Test Time:	2023/4/6 16:42:20
M/N.:	PDT-AR5C	Power Rating:	AC120V/60Hz
Mode:	Lighting	Test Engineer:	
Note:			

No.	Frequency (MHz)	Reading Level(dBuV)	Factor (dB)	Measure-ment(dBuV)	Limit (dBuV)	Margin (dB)	Detector	Comment
1	0.1503	46.56	11.14	57.70	65.98	-8.28	QP	
2 *	0.1503	36.96	11.14	48.10	55.98	-7.88	AVG	
3	0.2205	34.53	11.14	45.67	62.80	-17.13	QP	
4	0.2205	27.79	11.14	38.93	52.80	-13.87	AVG	
5	0.5045	28.40	11.20	39.60	56.00	-16.40	QP	
6	0.5045	23.98	11.20	35.18	46.00	-10.82	AVG	
7	1.4084	27.04	11.23	38.27	56.00	-17.73	QP	
8	1.4084	22.07	11.23	33.30	46.00	-12.70	AVG	
9	14.8405	25.86	11.37	37.23	60.00	-22.77	QP	
10	14.8405	21.11	11.37	32.48	50.00	-17.52	AVG	
11	28.1756	30.88	11.50	42.38	60.00	-17.62	QP	
12	28.1756	24.81	11.50	36.31	50.00	-13.69	AVG	

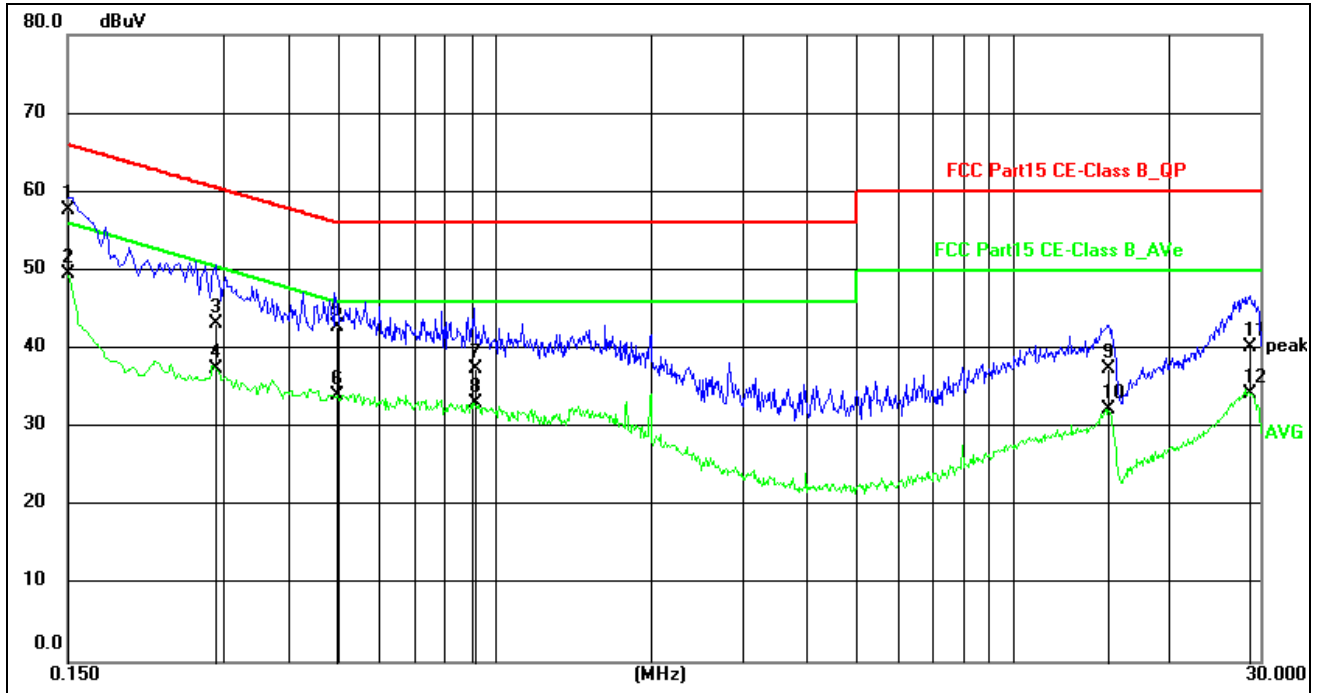

Site:	844LAB	Phase:	N	Temperature(C):	25(C)
Limit:	FCC Part15 CE-Class B_QP	Humidity(%):	64%		
EUT:	Led pedant light	Test Time:	2023/4/6 16:45:38		
M/N.:	PDT-AR5C	Power Rating:	AC120V/60Hz		
Mode:	Lighting	Test Engineer:			
Note:					

No.	Frequency (MHz)	Reading Level(dBuV)	Factor (dB)	Measurement(dBuV)	Limit (dBuV)	Margin (dB)	Detector	Comment
1	0.1504	46.42	11.15	57.57	65.98	-8.41	QP	
2 *	0.1504	38.28	11.15	49.43	55.98	-6.55	AVG	
3	0.2883	31.91	11.23	43.14	60.57	-17.43	QP	
4	0.2883	26.24	11.23	37.47	50.57	-13.10	AVG	
5	0.4959	31.54	11.31	42.85	56.07	-13.22	QP	
6	0.4959	22.73	11.31	34.04	46.07	-12.03	AVG	
7	0.9146	26.14	11.24	37.38	56.00	-18.62	QP	
8	0.9146	21.78	11.24	33.02	46.00	-12.98	AVG	
9	15.2324	26.04	11.36	37.40	60.00	-22.60	QP	
10	15.2324	20.84	11.36	32.20	50.00	-17.80	AVG	
11	28.6021	28.73	11.48	40.21	60.00	-19.79	QP	
12	28.6021	22.69	11.48	34.17	50.00	-15.83	AVG	

4. Radiated emission test

4.1. Test equipment

Item	Equipment	Manufacturer	Model No.	Serial No.	Last Cal.	Cal. Interval
1	EMI TEST RECEIVER	R&S	ESR	7250-304067 528	2022-05-20	1 Year
2	TRILOG BROADBAND ANTENNA	Schwarzbeck	VULB9168	00969	2021-01-10	2 Year
3	PRE-AMPLIFIER	R&S	8447F	3113A04553	2022-05-20	1 Year
4	RF CABLE	GORE	OSQ01Q0107 8.7	SN15458474	2021-05-21	2 Year
5	RF CABLE	ESCO	ETS-LINGREN	RFC-SMS-100- SMS-340-IN	2021-05-21	2 Year
6	MEASUREMENT SOFTWARE	FARAD	EZ-EMC(VER:1 .1.4.2)	N/A	N/A	N/A

4.2. Block diagram of test setup

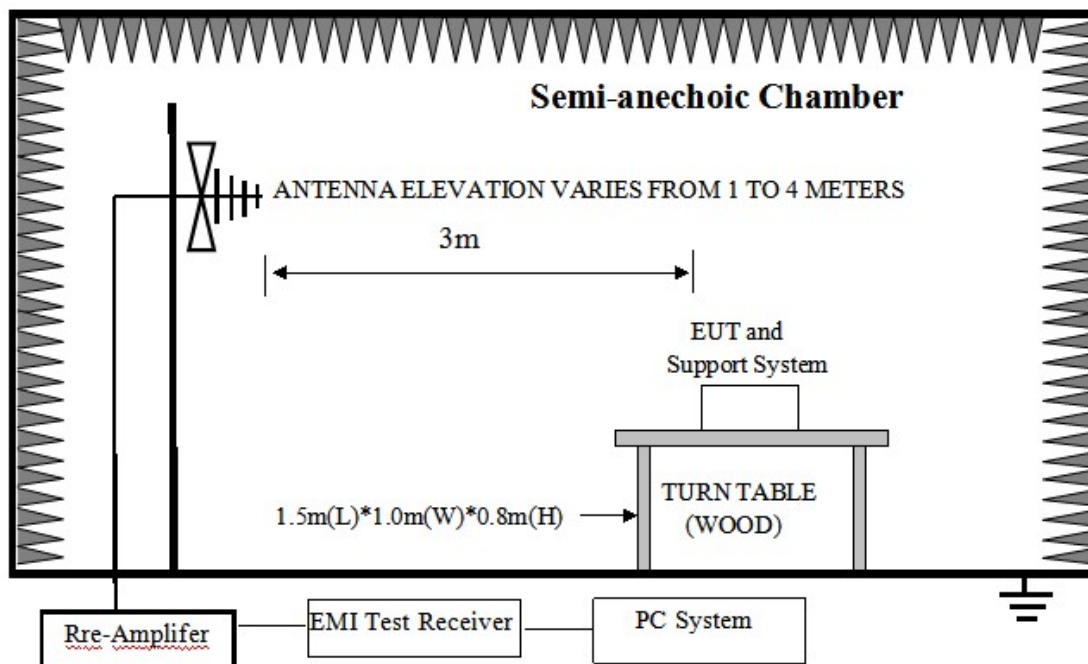

4.3. Radiated emission limit (Class B)

Frequency (MHz)	Distance (Meters)	Field Strengths Limits dB(μ V)/m
30--88	3	40.0
88--216	3	43.5
216--960	3	46.0
960--1000	3	54.0

Note: (1) The smaller limit shall apply at the cross point between two frequency bands.

(2) Distance is the distance in meters between the measuring instrument, antenna and the closest point of any part of the device or system.

4.4. Test Procedure

Procedure of Preliminary Test

The EUT and Support equipment, if needed, were put placed on a non-metallic table, 80cm above the ground plane.

Configuration EUT to simulate typical usage as described in clause 2.3 and test equipment as described in clause 4.2 of this report.

All I/O cables were positioned to simulate typical actual usage as per ANSI C63.4.

Mains cables, telephone lines or other connections to auxiliary equipment located outside the test are shall drape to the floor, be fitted with ferrite clamps or ferrite tubes placed on the floor at the point where the cable reaches the floor and then routed to the place where they leave the turntable. No extension cords shall be used to mains receptacle.

The antenna was placed at 3 meters away from the EUT as stated in ANSI C63.4. The antenna connected to the Spectrum Analyzer via a cable and at times a pre-amplifier would be used.

The Analyzer / Receiver quickly scanned from 30MHz to 1000MHz. The EUT test program was started. Emissions were scanned and measured rotating the EUT to 360 degrees and positioning the antenna 1 to 4 meters above the ground plane, in both the vertical and the horizontal polarization, to maximize the emission reading level.

The test mode(s) described in clause 2.3 were scanned during the preliminary test:

After the preliminary scan, we found the test mode producing the highest emission level. The EUT and cable configuration, antenna position, polarization and turntable position of the above highest emission level were recorded for the final test.

Procedure of Final Test

EUT and support equipment were set up on the turntable as per the configuration with highest emission level in the preliminary test.

The Analyzer / Receiver scanned from 30MHz to 1000MHz. Emissions were scanned and measured rotating the EUT to 360 degrees, varying cable placement and positioning the antenna 1 to 4 meters above the ground plane, in both the vertical and the horizontal polarization, to maximize the emission reading level.

Recorded at least the six highest emissions. Emission frequency, amplitude, antenna position, polarization and turntable position were recorded into a computer in which correction factors were used to calculate the emission level and compare reading to the applicable limit and only Q.P. reading is presented.

The test data of the worst-case condition(s) was recorded.

The bandwidth setting of the test receiver is 120 kHz.

4.5. Test result

PASS. (See below detailed test result)

Note1: All emissions not reported here are too low against the prescribed limits.

Note2: Result Level = Reading Level + Antenna Factor + Cable Loss, Margin= Level-Limit.

Radiated Emission Test Result

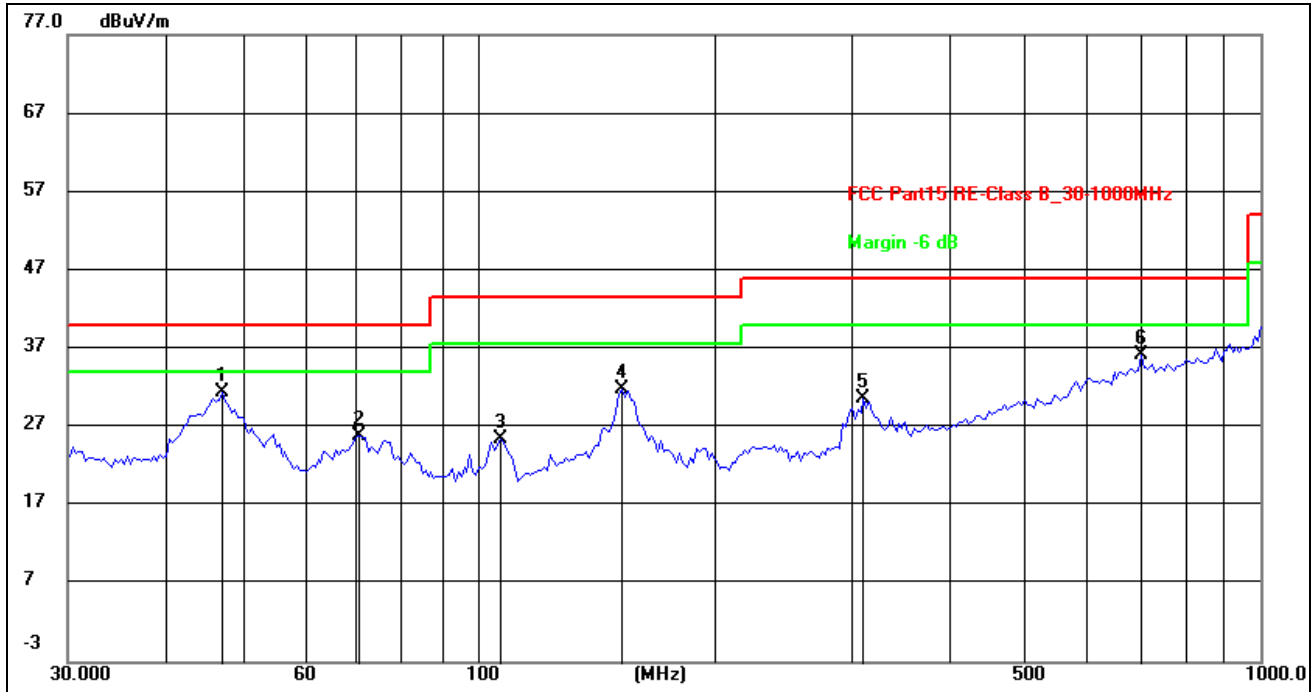

Site:	966LAB	Antenna::Horizontal	Temperature(C):24(C)
Limit:	FCC Part15 RE-Class B_30-1000MHz		Humidity(%):60%
EUT:	Led pedant light	Test Time:	2023/4/6 15:25:28
M/N.:	PDT-AR5C	Power Rating:	AC 120V/60Hz
Mode:	Lighting	Test Engineer:	
Note:			

No.	Frequency (MHz)	Reading (dBuV)	Factor (dB/m)	Level (dBuV/m)	Limit (dBuV/m)	Margin (dB)	Det.	Height (cm)	Azimuth (deg)	Remark
1 *	47.3255	17.09	14.26	31.35	40.00	-8.65	peak	200	19	
2	70.8315	14.83	10.98	25.81	40.00	-14.19	peak	200	335	
3	106.9460	14.11	11.44	25.55	43.50	-17.95	peak	200	47	
4	153.2003	17.63	14.13	31.76	43.50	-11.74	peak	200	123	
5	311.6325	15.80	14.85	30.65	46.00	-15.35	peak	100	253	
6	704.2261	13.65	22.56	36.21	46.00	-9.79	peak	200	271	

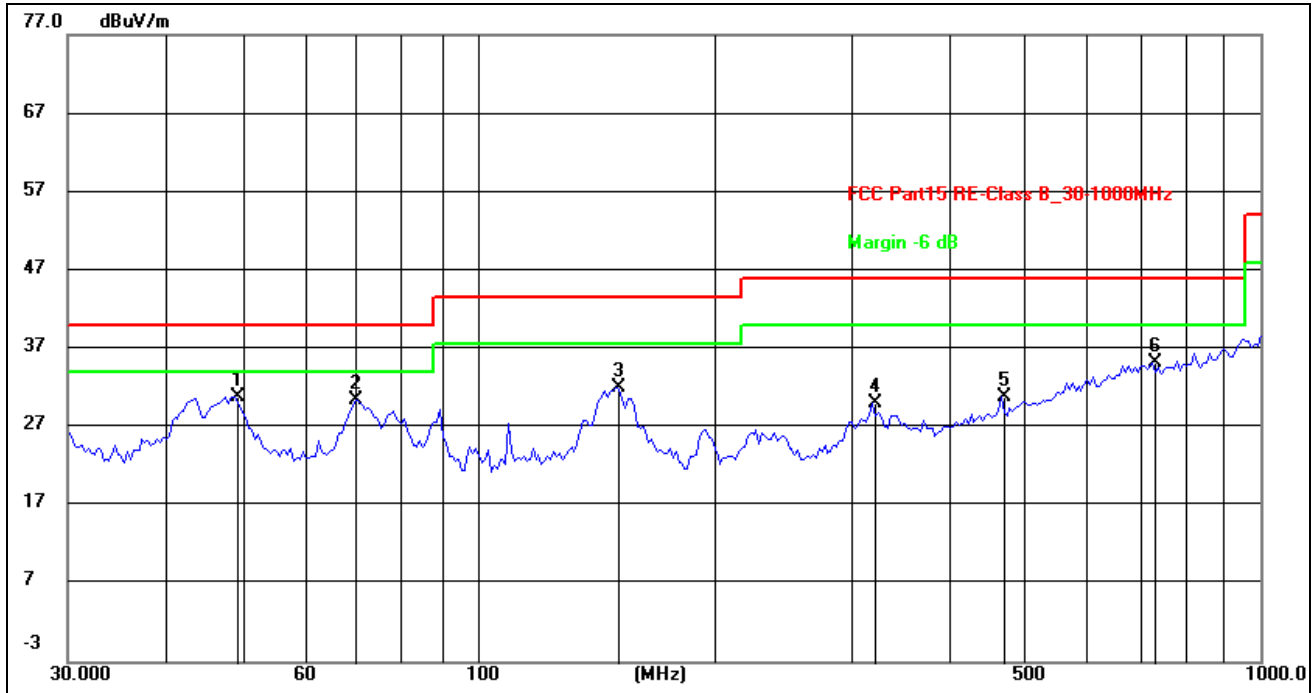

Site:	966LAB	Antenna::Vertical	Temperature(C):24(C)
Limit:	FCC Part15 RE-Class B_30-1000MHz		Humidity(%):60%
EUT:	Led pedant light	Test Time:	2023/4/6 15:28:01
M/N.:	PDT-AR5C	Power Rating:	AC 120V/60Hz
Mode:	Lighting	Test Engineer:	
Note:			

No.	Frequency (MHz)	Reading (dBuV)	Factor (dB/m)	Level (dBuV/m)	Limit (dBuV/m)	Margin (dB)	Det.	Height (cm)	Azimuth (deg)	Remark
1 *	49.0145	16.56	14.31	30.87	40.00	-9.13	peak	100	269	
2	70.2132	18.88	11.61	30.49	40.00	-9.51	peak	100	274	
3	150.5378	16.52	15.45	31.97	43.50	-11.53	peak	100	4	
4	319.9370	15.07	15.07	30.14	46.00	-15.86	peak	100	38	
5	466.4165	12.65	18.27	30.92	46.00	-15.08	peak	100	356	
6	729.3583	12.34	22.89	35.23	46.00	-10.77	peak	100	171	

5. Test setup photograph

5.1. Photos of power line conducted emission test



5.2. Photos of radiated emission test



6. Photos of the EUT

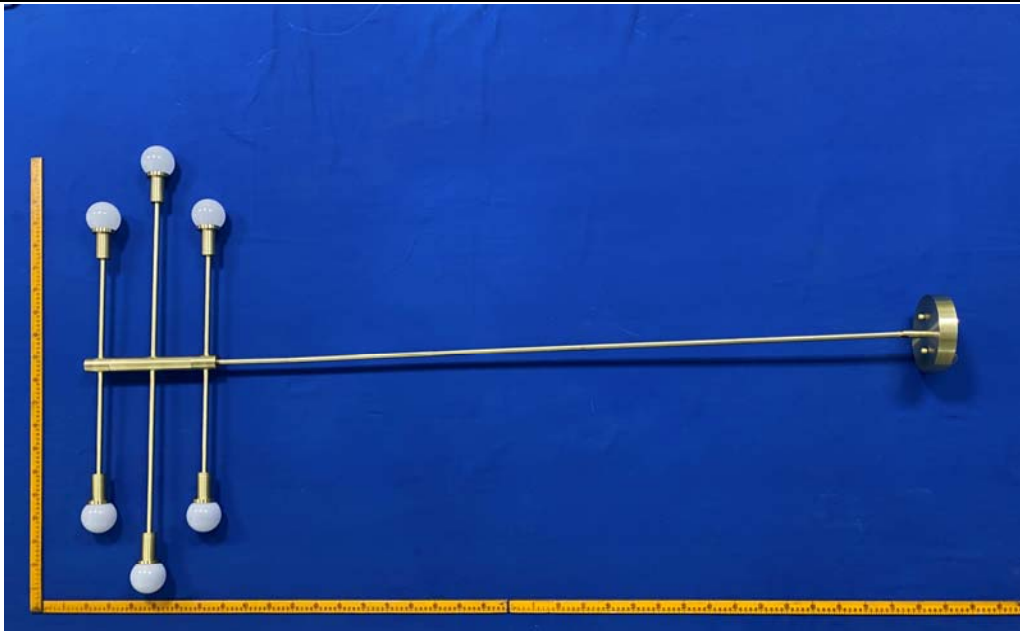

Fig.1(Model: PDT-AR5C)



Fig.2(Model: PDT-AR5C)

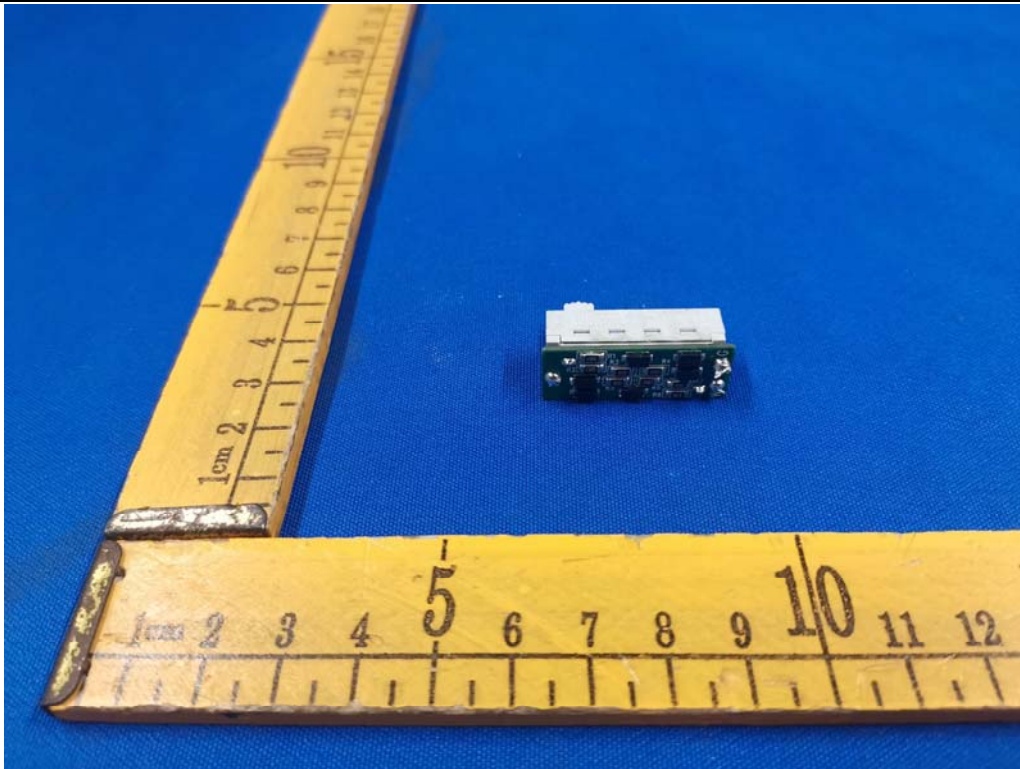

Fig.3(Model: PDT-AR5C)

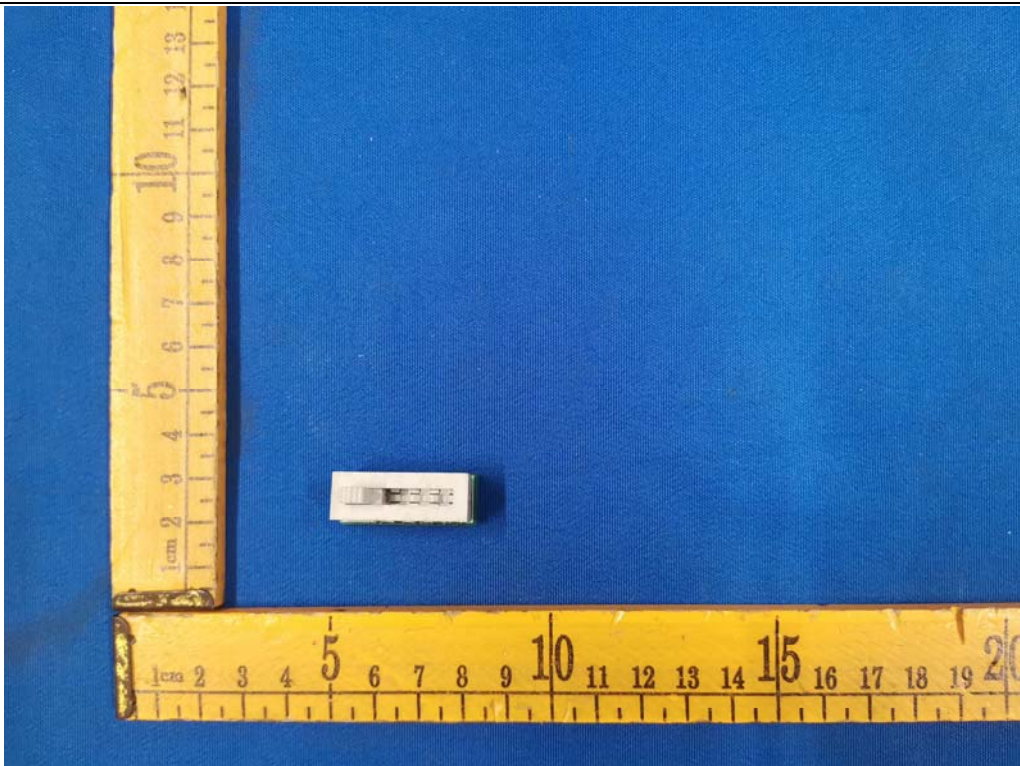

Fig.4(Model: PDT-AR5C)



Fig.5(Model: PDT-AR5C)



Fig.6(Model: PDT-AR5C)

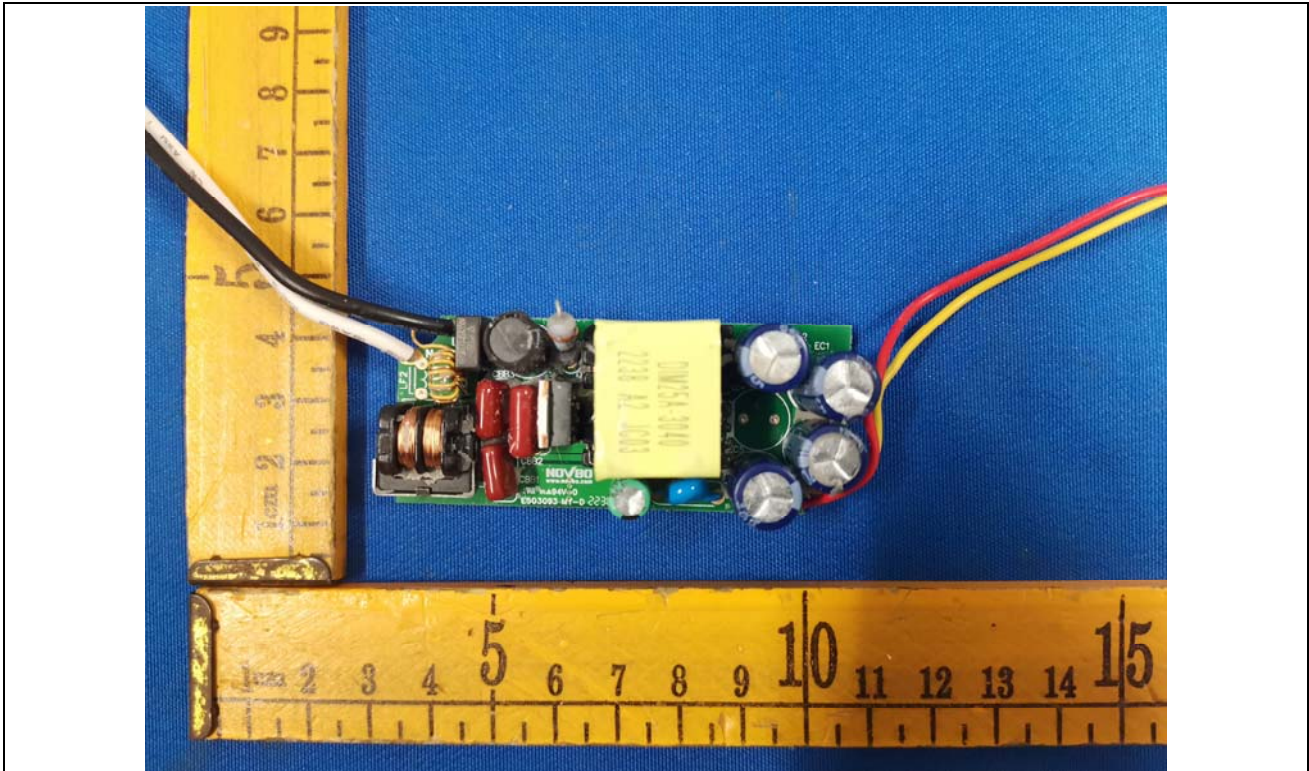

Fig.7(Model: PDT-AR5C)

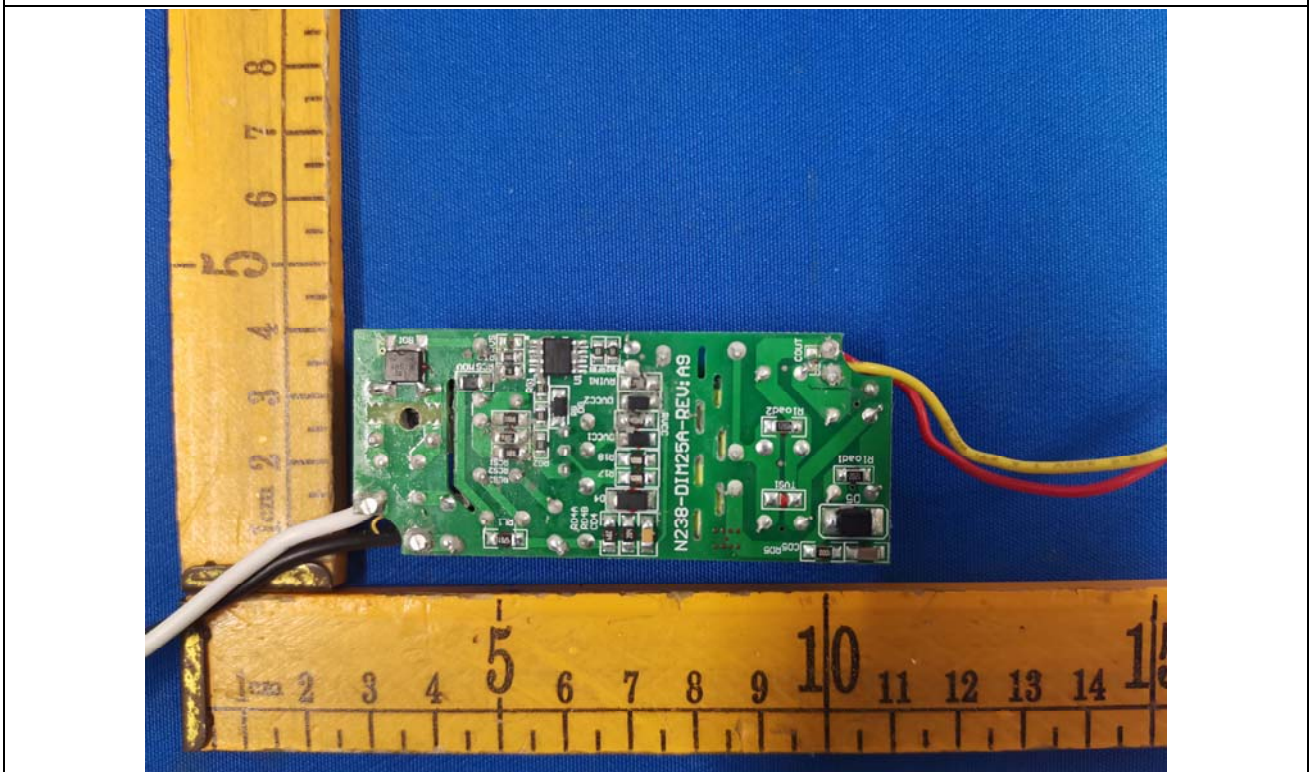

Fig.8(Model: PDT-AR5C)

Appendix I

Regulatory Statement and Label Marking Advice for the FCC SDoC

1. Marking Suggested for the label:

Trade Name and model number

This device complies with Part 15 of the FCC Rules. Operation is subject to the following two conditions: (1) this device may not cause harmful interference, and (2) this device must accept any interference received, including interference that may cause undesired operation.

2. Statement suggested for the User Manual:

Warning: Changes or modifications to this unit not expressly approved by the party responsible for compliance could void the user authority to operate the equipment.

Notes: This equipment has been tested and found to comply with the limits for a Class B digital device, pursuant to Part 15 of the FCC Rules. These limits are designed to provide reasonable protection against harmful interference in a residential installation. This equipment generates uses and can radiate radio frequency energy and, if not installed and used in accordance with the instructions, may cause harmful interference to radio communications.

However, there is no guarantee that interference will not occur in a particular installation. If this equipment does cause harmful interference to radio or television reception, which can be determined by turning the equipment off and on, the user is encouraged to try to correct the interference by one or more of the following measures:

- Reorient or relocate the receiving antenna.
- Increase the separation between the equipment and receiver.
- Connect the equipment into an outlet on a circuit different from that to which the receiver is connected.
- Consult the dealer or an experienced radio/TV technician for help.

Note: If shielded cables or special accessories are required for compliance, a statement must be included which instructs the user to employ them, for example, Shielded cables must be used with this unit to ensure compliance with the Class B FCC limits.

--END OF REPORT--