

# TEST REPORT

**Applicant:** CommuniTake Technologies Ltd.  
**Address:** Yokneam Star Building, High-Tech Park, POB 344,  
Yokneam, Israel 2069205  
**Equipment Type:** 4G Smart phone  
**Model Name:** CTGED01  
**Brand Name:** CommuniTake  
**FCC ID:** 2AUHC-CTGED01  
**Test Standard:** FCC 47 CFR Part 2.1093  
(refer section 3.1)  
**Maximum SAR:** Head (1 g): 0.704 W/kg  
Body (1 g): 1.169 W/kg  
**Test Date:** Jan. 18, 2020 - Feb. 24, 2022  
**Date of Issue:** Mar. 18, 2022

**ISSUED BY:**

Shenzhen BALUN Technology Co., Ltd.

**Tested by:** Zhang Jiwei

**Checked by:** Zong Liyao

**Approved by:** Wei Yanquan  
(Chief Engineer)

Zhang Jiwei

Liyao. Zong

Wei Yanquan

<b>Revision History</b>		
Version	Issue Date	Revisions Content
<u>Rev. 01</u>	<u>Mar. 18, 2022</u>	<u>Initial Issue</u>

## TABLE OF CONTENTS

1	GENERAL INFORMATION.....	5
1.1	Identification of the Testing Laboratory .....	5
1.2	Identification of the Responsible Testing Location .....	5
2	PRODUCT INFORMATION .....	6
2.1	Applicant Information .....	6
2.2	Manufacturer Information.....	6
2.3	Factory Information.....	6
2.4	General Description for Equipment under Test (EUT).....	6
2.5	Ancillary Equipment.....	7
2.6	Technical Information .....	8
3	SUMMARY OF TEST RESULT .....	9
3.1	Test Standards .....	9
3.2	Device Category and SAR Limit .....	10
3.3	Test Result Summary .....	11
3.4	Test Uncertainty .....	12
4	MEASUREMENT SYSTEM .....	14
4.1	Definition of Specific Absorption Rate (SAR) .....	14
4.2	SATIMO SAR System.....	15
5	MEASUREMENT PROCEDURE .....	24
5.1	Antenna Port Test Requirement .....	24
5.2	Purpose of System Check .....	24
5.3	System Check Setup .....	24
6	EUT TEST POSITION CONFIGURATUONS.....	25
6.1	Head Exposure Conditions .....	25

6.2	Define two imaginary lines on the handset.....	25
6.3	Body-worn Position Conditions .....	27
6.4	Hotspot Mode Exposure Position Conditions .....	28
7	SAR MEASUREMENT PROCEDURES.....	29
7.1	SAR Measurement Process Diagram .....	29
7.2	SAR Scan General Requirements .....	30
7.3	SAR Measurement Procedure .....	31
7.4	Area & Zoom Scan Procedures .....	31
8	CONDUCTED RF OUPUT POWER .....	32
8.1	GSM.....	32
8.2	WCDMA .....	33
8.3	LTE.....	34
8.4	WIFI.....	41
8.5	Bluetooth .....	41
9	EUT ANTENNA LOCATION SKETCH .....	42
9.1	SAR Test Exclusion Consideration Table .....	43
9.2	10g Extremity Exposure Consideration.....	45
10	TEST RESULT .....	46
10.1	GSM 850 .....	46
10.2	GSM 1900 .....	46
10.3	WCDMA Band 2 .....	47
10.4	WCDMA Band 4 .....	47
10.5	WCDMA Band 5 .....	48
10.6	LTE Band 2 (20MHz Bandwidth) .....	49
10.7	LTE Band 4 (20MHz Bandwidth) .....	50
10.8	LTE Band 5 (10MHz Bandwidth) .....	51
10.9	LTE Band 7 (20MHz Bandwidth) .....	52
10.10	LTE Band 12 (10MHz Bandwidth).....	53
10.11	WIFI 2.4GHz.....	54
10.12	Worst Case of WCDMA Band 4.....	54

---

10.13	Worst Case of LTE Band 7 .....	54
11	SAR Measurement Variability .....	55
12	SIMULTANEOUS TRANSMISSION.....	56
12.1	Simultaneous Transmission Mode Consider .....	56
12.2	Estimated SAR Calculation.....	57
12.3	Sum SAR of Simultaneous Transmission .....	58
13	TEST EQUIPMENTS LIST .....	59
ANNEX A	SIMULATING LIQUID VERIFICATION RESULT .....	60
ANNEX B	SYSTEM CHECK RESULT .....	61
ANNEX C	TEST DATA.....	82
ANNEX D	EUT EXTERNAL PHOTOS.....	107
ANNEX E	SAR TEST SETUP PHOTOS .....	107
ANNEX F	CALIBRATION REPORT .....	107

# 1 GENERAL INFORMATION

## 1.1 Identification of the Testing Laboratory

Company Name	Shenzhen BALUN Technology Co., Ltd.
Address	Block B, 1/F, Baisha Science and Technology Park Shahe Xi Road, Nanshan District Shenzhen, Guangdong Province, People's Republic of China
Phone Number	+86 755 6685 0100
Fax Number	+86 755 6182 4271

## 1.2 Identification of the Responsible Testing Location

Test Location	Shenzhen BALUN Technology Co., Ltd.
Address	Block B, 1/F, Baisha Science and Technology Park Shahe Xi Road, Nanshan District Shenzhen, Guangdong Province, People's Republic of China
Accreditation Certificate	The laboratory is a testing organization accredited by FCC as a accredited testing laboratory. The designation number is CN1196.
Description	All measurement facilities used to collect the measurement data are located at Block B, 1/F, Baisha Science and Technology Park Shahe Xi Road, Nanshan District Shenzhen, Guangdong Province, People's Republic of China

## 2 PRODUCT INFORMATION

### 2.1 Applicant Information

Applicant	CommuniTake Technologies Ltd.
Address	Yokneam Star Building, High-Tech Park, POB 344, Yokneam, Israel 2069205

### 2.2 Manufacturer Information

Manufacturer	CommuniTake Technologies Ltd.
Address	Yokneam Star Building, High-Tech Park, POB 344, Yokneam, Israel 2069205

### 2.3 Factory Information

Factory	Shenzhen Joyhong Technology Co., Ltd.
Address	4/F., Building A2, Zhengfeng Industrial Park, Fengtang Road, Fuyong, Bao'an, Shenzhen, China

### 2.4 General Description for Equipment under Test (EUT)

EUT Name	4G Smart phone
Model Name Under Test	CTGED01
Series Model Name	N/A
Description of Model name differentiation	N/A
Hardware Version	N/A
Software Version	N/A
Dimensions (Approx.)	N/A
Weight (Approx.)	N/A

## 2.5 Ancillary Equipment

Ancillary Equipment 1	Li ion Rechargeable Battery	
	Brand Name	N/A
	Model No.	CTGED01
	Serial No.	N/A
	Capacity	2500mAh
	Charging Voltage	4.354 V/9.5Wh
	Nominal Voltage	3.8 V
Ancillary Equipment 2	Earphone	
	Model No.	N/A
	Length (Approx.)	1.0 m

## 2.6 Technical Information

Network and Wireless connectivity	2G Network GSM/GPRS/EGPRS 850/1900 MHz 3G Network WCDMA/HSDPA/HSUPA Band 2/4/5 4G Network FDD LTE Band 2/4/5/7/12 Bluetooth 4.2 (BR+EDR+BLE) WIFI 802.11b, 802.11g, 802.11n
Note : The EUT is a mobile phone, which supports dual SIM card under the same transceiver. Each SIM supports GSM, WCDMA and LTE, and both SIM share the same transmitting electro circuit, NV parameters, so only SIM1 was tested in this report.	

The requirement for the following technical information of the EUT was tested in this report:

Operating Mode	GSM, WCDMA, FDD-LTE, 2.4G WLAN, Bluetooth		
Frequency Range	GSM 850	TX: 824 ~ 849 MHz	RX: 869 ~ 894 MHz
	GSM 1900	TX: 1850 ~ 1910 MHz	RX: 1930 ~ 1990 MHz
	WCDMA Band 2	TX: 1850 ~ 1910 MHz	RX: 1930 ~ 1990 MHz
	WCDMA Band 4	TX: 1710 ~ 1755 MHz	RX: 2110 ~ 2155 MHz
	WCDMA Band 5	TX: 824 ~ 849 MHz	RX: 869 ~ 894 MHz
	LTE Band 2	TX: 1850 ~ 1910 MHz	RX: 1930 ~ 1990 MHz
	LTE Band 4	TX: 1710 ~ 1755 MHz	RX: 2110 ~ 2155 MHz
	LTE Band 5	TX: 824 ~ 849 MHz	RX: 869 ~ 894 MHz
	LTE Band 7	TX: 2500 ~ 2570 MHz	RX: 2620 ~ 2690 MHz
	LTE Band 12	TX: 699 ~ 716 MHz	RX: 729 ~ 746 MHz
	802.11b/g /n(HT20/HT40)	2400 ~ 2483.5 MHz	
	Bluetooth	2400 ~ 2483.5 MHz	
Antenna Type	WWAN: PIFA Antenna WLAN: PIFA Antenna Bluetooth: PIFA Antenna		
DTM	Not Support		
Hotspot Function	Support		
Power Reduction	Support		
Exposure Category	General Population/Uncontrolled exposure		
EUT Stage	Portable Device		
Product	Type		
	<input checked="" type="checkbox"/> Production unit		<input type="checkbox"/> Identical prototype



### 3 SUMMARY OF TEST RESULT

#### 3.1 Test Standards

No.	Identity	Document Title
1	47 CFR Part 2.1093	Radiofrequency radiation exposure evaluation: portable devices
2	ANSI C95.1-1992	IEEE Standard for Safety Levels with Respect to Human Exposure to Radio Frequency Electromagnetic Fields, 3 kHz to 300 GHz
3	IEEE Std. 1528-2013	Recommended Practice for Determining the Peak Spatial-Average Specific Absorption Rate (SAR) in the Human Head from Wireless Communications Devices: Measurement Techniques
4	FCC KDB 447498 D01 v06	Mobile and Portable Device RF Exposure Procedures and Equipment Authorization Policies
5	FCC KDB 941225 D01 v03r01	3G SAR MEAUREMENT PROCEDURES
6	FCC KDB 941225 D05 v02r05	SAR Evaluation Considerations for LTE Devices
7	FCC KDB 941225 D06 v02r01	SAR Evaluation Procedures for Portable Devices with Wireless Router Capabilities
8	FCC KDB 865664 D01 v01r04	SAR Measurement 100 MHz to 6 GHz
9	FCC KDB 865664 D02 v01r02	RF Exposure Reporting
10	FCC KDB 648474 D04 v01r03	SAR Evaluation Considerations for Wireless Handsets
11	KDB 248227 D01 v02r02	SAR Guidance for IEEE 802.11 (Wi-Fi) Transmitters

Note: Compared with the EUT of test report BL-SZ2010032-701, the changes of the EUT of this report as below:

1. LCD display change.
2. Disabled LTE Band 17 by software control.
3. Turn off the Voice function.

Other hardware circuit and software are the same as EUT referred in test report BL-SZ2010032-701.

Therefore, delete all data of GSM Voice and LTE B17, and added the worst case sport check test data in section 10.12/10.13 and ANNEX A/B/C., others test data please refer to report BL-SZ2010032-701, which was issued by Shenzhen BALUN Technology Co., Ltd. on Feb. 18, 2020.

### 3.2 Device Category and SAR Limit

This device belongs to portable device category because its radiating structure is allowed to be used within 20 centimeters of the body of the user. Limit for General Population/Uncontrolled exposure should be applied for this device, it is 1.6 W/kg as averaged over any 1 gram of tissue.

Table of Exposure Limits:

Body Position	SAR Value (W/Kg)	
	General Population/ Uncontrolled Exposure	Occupational/ Controlled Exposure
Whole-Body SAR (averaged over the entire body)	0.08	0.4
Partial-Body SAR (averaged over any 1 gram of tissue)	1.60	8.0
SAR for hands, wrists, feet and ankles (averaged over any 10 grams of tissue)	4.0	20.0

**NOTE:**

**General Population/Uncontrolled:** Locations where there is the exposure of individuals who have no knowledge or control of their exposure. General population/uncontrolled exposure limits are applicable to situations in which the general public may be exposed or in which persons who are exposed as a consequence of their employment may not be made fully aware of the potential for exposure or cannot exercise control over their exposure. Members of the general public would come under this category when exposure is not employment-related; for example, in the case of a wireless transmitter that exposes persons in its vicinity.

**Occupational/Controlled:** Locations where there is exposure that may be incurred by persons who are aware of the potential for exposure, In general, occupational/controlled exposure limits are applicable to situations in which persons are exposed as a consequence of their employment, who have been made fully aware of the potential for exposure and can exercise control over their exposure. This exposure category is also applicable when the exposure is of a transient nature due to incidental passage through a location where the exposure levels may be higher than the general population/uncontrolled limits, but the exposed person is fully aware of the potential for exposure and can exercise control over his or her exposure by leaving the area or by some other appropriate means.

### 3.3 Test Result Summary

#### 3.3.1 Highest SAR (1 g Value)

Band	Maximum Scaled SAR (W/kg)			Maximum Report SAR (W/kg)		
	Head	Body		Head	Body	
		Body-worn (10mm)	Hotspot (10mm)		Body-worn (10mm)	Hotspot (10mm)
GSM 850	0.488	0.705	0.705	0.704	1.155	1.169
GSM 1900	0.472	0.986	0.986			
WCDMA Band 2	0.533	1.152	1.152			
WCDMA Band 4	<b>0.704</b>	<b>1.155</b>	1.155			
WCDMA Band 5	0.259	0.350	0.350			
LTE Band 2	0.551	1.088	1.088			
LTE Band 4	0.567	1.148	1.148			
LTE Band 5	0.386	0.422	0.422			
LTE Band 7	0.135	0.989	<b>1.169</b>			
LTE Band 12	0.333	0.622	0.622			
2.4G WLAN	0.425	0.166	0.166			
Limit (W/kg)	1.60					
Verdict	Pass					

#### 3.3.2 Highest Specific SAR (10 g Value)

Position	Simultaneous Configuration	Simultaneous SAR (W/kg)	Limit (W/kg)	Verdict
Head (1g)	WCDMA RMC + 2.4G WLAN	1.129	1.6	Pass
Body-worn (1g)	LTE QPSK + 2.4G WLAN	1.321	1.6	Pass
Hotspot (1g)	LTE QPSK + 2.4G WLAN	1.335	1.6	Pass

#### 3.3.3 Highest Simultaneous SAR

Note: The highest simultaneous SAR please refer section 12.

### 3.4 Test Uncertainty

#### 3.4.1 Measurement uncertainty evaluation for SAR test

The following measurement uncertainty levels have been estimated for tests performed on the EUT as specified in IEEE 1528 This uncertainty represents an expanded uncertainty expressed at approximately the 95% confidence level using a coverage factor of k=2.

Uncertainty Component	Tol (+- %)	Prob. Dist.	Div.	Ci (1g)	Ci (10 g)	1g Ui (+-%)	10 g Ui (+-%)	Vi V <sub>eff</sub>
<b>Measurement System</b>								
Probe calibration	5.8	N	1	1	1	5.80	5.80	∞
Axial Isotropy	3.5	R	$\sqrt{3}$	0.7	0.7	1.41	1.41	∞
Hemispherical Isotropy	5.9	R	$\sqrt{3}$	0.7	0.7	2.38	2.38	∞
Boundary effect	1.0	R	$\sqrt{3}$	1	1	0.58	0.58	∞
Linearity	4.7	R	$\sqrt{3}$	1	1	2.71	2.71	∞
System detection limits	1.0	R	$\sqrt{3}$	1	1	0.58	0.58	∞
Modulation response	3.0	R	$\sqrt{3}$	1	1	1.73	1.73	∞
Readout Electronics	0.5	N	1	1	1	0.50	0.50	∞
Response Time	0.0	R	$\sqrt{3}$	1	1	0.00	0.00	∞
Integration Time	1.4	R	$\sqrt{3}$	1	1	0.81	0.81	∞
RF ambient Conditions - Noise	3.0	R	$\sqrt{3}$	1	1	1.73	1.73	∞
RF ambient Conditions - Reflections	3.0	R	$\sqrt{3}$	1	1	1.73	1.73	∞
Probe positioner Mechanical Tolerance	1.4	R	$\sqrt{3}$	1	1	0.81	0.81	∞
Probe positioning with respect to Phantom Shell	1.4	R	$\sqrt{3}$	1	1	0.81	0.81	∞
Extrapolation, interpolation and integration Algorithms for Max. SAR Evaluation	2.3	R	$\sqrt{3}$	1	1	1.33	1.33	∞
<b>Test sample Related</b>								
Test sample positioning	2.6	N	1	1	1	2.60	2.60	N-1
Device Holder Uncertainty	3.0	N	1	1	1	3.00	3.00	N-1
Output power Variation - SAR drift measurement	5.0	R	$\sqrt{3}$	1	1	2.89	2.89	∞
SAR scaling	2.0	R	$\sqrt{3}$	1	1	1.15	1.15	∞
<b>Phantom and Tissue Parameters</b>								
Phantom Uncertainty (Shape and thickness tolerances)	4.0	R	$\sqrt{3}$	1	1	2.31	2.31	∞
SAR correction for deviation(in permittivity and conductivity )	2.0	N	1	1	0.84	2.00	1.68	∞
Liquid conductivity (temperature uncertainty)	2.5	R	$\sqrt{3}$	0.78	0.71	1.13	1.03	∞
Liquid conductivity - measurement uncertainty	5.0	N	1	0.78	0.71	3.90	3.55	M
Liquid permittivity (temperature uncertainty)	2.5	R	$\sqrt{3}$	0.23	0.26	0.33	0.38	∞
Liquid permittivity - measurement uncertainty	5.0	N	1	0.23	0.26	1.15	1.30	M
Combined Standard Uncertainty	-	RSS	-	-	-	10.72	10.56	-

Expanded Uncertainty (95% Confidence interval)	-	k	-	21.45	21.11	-
---------------------------------------------------	---	---	---	-------	-------	---

### 3.4.2 Measurement uncertainty evaluation for system check

This measurement uncertainty budget is suggested by IEEE 1528. The break down of the individual uncertainties is as follows:

Uncertainty Component	Tol (+-%)	Prob. Dist.	Div.	Ci (1g)	Ci (10g)	1g Ui (+-%)	10g Ui (+-%)	V <sub>i</sub>
<b>Measurement System</b>								
Probe calibration	5.8	N	1	1	1	5.80	5.30	∞
Axial Isotropy	3.5	R	$\sqrt{3}$	1	1	2.02	2.02	∞
Hemispherical Isotropy	5.9	R	$\sqrt{3}$	0	0	0.00	0.00	∞
Boundary effect	1.0	R	$\sqrt{3}$	1	1	0.58	0.56	∞
Probe Linearity	4.7	R	$\sqrt{3}$	1	1	2.71	2.71	∞
System detection limits	1.0	R	$\sqrt{3}$	1	1	0.58	0.58	∞
Modulation response	0.0	R	$\sqrt{3}$	1	1	0.00	0.00	∞
Readout Electronics	0.5	N	1	1	1	0.50	0.50	∞
Response Time	0.0	R	$\sqrt{3}$	1	1	0.00	0.00	∞
Integration Time	1.4	R	$\sqrt{3}$	0	0	0.00	0.00	∞
RF ambient Conditions - Noise	3.0	R	$\sqrt{3}$	1	1	1.73	1.73	∞
RF ambient Conditions - Reflections	3.0	R	$\sqrt{3}$	1	1	1.73	1.73	∞
Probe positioner Mechanical Tolerance	1.4	R	$\sqrt{3}$	1	1	0.81	0.81	∞
Probe positioning with respect to Phantom Shell	1.4	R	$\sqrt{3}$	1	1	0.81	0.81	∞
Extrapolation, interpolation and integration Algorithms for Max. SAR Evaluation	2.3	R	$\sqrt{3}$	1	1	1.33	1.33	∞
<b>Dipole</b>								
Deviation of experimental dipole	5.5	N	1	1	1	5.00	5.00	∞
Dipole axis to liquid distance	2.0	R	$\sqrt{3}$	1	1	1.15	1.15	∞
Power drift	0.5	R	$\sqrt{3}$	1	1	0.29	0.29	∞
<b>Phantom and Tissue Parameters</b>								
Phantom Uncertainty (Shape and thickness tolerances)	4.0	R	$\sqrt{3}$	1	1	2.31	2.31	∞
SAR correction for deviation(in permittivity and conductivity )	2.0	N	1	1	0.84	2.00	1.68	∞
Liquid conductivity (temperature uncertainty)	2.5	R	$\sqrt{3}$	0.78	0.71	1.13	1.02	∞
Liquid conductivity - measurement uncertainty	5.0	N	1	0.78	0.71	3.90	3.55	M
Liquid permittivity (temperature uncertainty)	2.5	R	$\sqrt{3}$	0.23	0.26	0.33	0.38	∞
Liquid permittivity - measurement uncertainty	5.0	N	1	0.23	0.26	1.15	1.30	M
<b>Combined Standard Uncertainty</b>	-	RSS	-	-	-	10.43	10.25	-
<b>Expanded Uncertainty</b> (95% Confidence interval)	-	k	-	-	-	20.86	20.51	-

## 4 MEASUREMENT SYSTEM

### 4.1 Definition of Specific Absorption Rate (SAR)

SAR is related to the rate at which energy is absorbed per unit mass in an object exposed to a radio field. The SAR distribution in a biological body is complicated and is usually carried out by experimental techniques or numerical modeling. The standard recommends limits for two tiers of groups, occupational/controlled and general population/uncontrolled, based on a person's awareness and ability to exercise control over his or her exposure. In general, occupational / controlled exposure limits are higher than the limits for general population /uncontrolled.

The SAR definition is the time derivative (rate) of the incremental energy ( $dW$ ) absorbed by (dissipated in) an incremental mass ( $dm$ ) contained in a volume element ( $dv$ ) of a given density ( $\rho$ ). The equation description is as below:

$$\text{SAR} = \frac{d}{dt} \left( \frac{dW}{dm} \right) = \frac{d}{dt} \left( \frac{dW}{\rho dv} \right)$$

SAR is expressed in units of Watts per kilogram (W/kg) SAR measurement can be related to the electrical field in the tissue by

$$\text{SAR} = \frac{\sigma E^2}{\rho}$$

Where:  $\sigma$  is the conductivity of the tissue,

$\rho$  is the mass density of the tissue and  $E$  is the RMS electrical field strength.

## 4.2 SATIMO SAR System

### 4.2.1 SATIMO SAR System Diagram

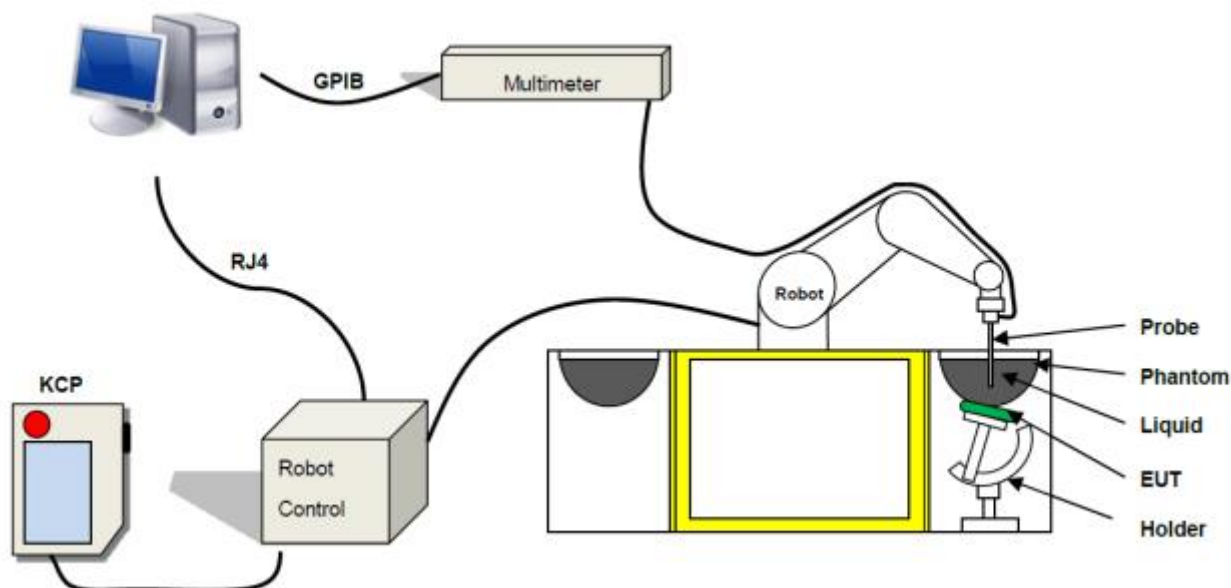

These measurements were performed with the automated near-field scanning system OPENSAR from SATIMO. The system is based on a high precision robot (working range: 850 mm), which positions the probes with a positional repeatability of better than  $\pm 0.02$  mm. Special E- and H-field probes have been developed for measurements close to material discontinuity, the sensors of which are directly loaded with a Schottky diode and connected via highly resistive lines to the data acquisition unit.

The SAR measurements were conducted with dosimetric probe (manufactured by SATIMO), designed in the classical triangular configuration and optimized for dosimetric evaluation. The probe has been calibrated according to the procedure described in SAR standard with accuracy of better than  $\pm 10\%$ . The spherical isotropy was evaluated with the procedure described in SAR standard and found to be better than  $\pm 0.25$  dB. The phantom used was the SAM Phantom as described in FCC supplement C, IEEE P1528.

#### 4.2.2 Robot

The SATIMO SAR system uses the high precision robots from KUKA. For the 6-axis controller system, the robot controller version (KUKA) from KUKA is used. The KUKA robot series have many features that are important for our application:



- High precision (repeatability  $\pm 0.035$  mm)
- High reliability (industrial design)
- Jerk-free straight movements
- Low ELF interference (the closed metallic construction shields against motor control fields)



### 4.2.3 E-Field Probe

For the measurements the Specific Dosimetric E-Field Probe SN 34/15 EPGO 265 with following specifications is used

- Dynamic range: 0.01-100 W/kg
- Tip Diameter : 2.5 mm
- Lower detection limit : 10 mW/kg  
(repeatability better than +/- 1mm)
- Probe linearity: +/- 0.07 dB
- Calibration range: 300 MHz to 6000 MHz for head & body simulating liquid.

Angle between probe axis (evaluation axis) and surface normal line: less than 30°



#### E-Field Probe Calibration Process

Probe calibration is realized, in compliance with CENELEC EN 62209-1/-2 and IEEE 1528 std, with CALISAR, Antennessa proprietary calibration system. The calibration is performed with the IEC62209-1/2 annexe technique using reference guide at the five frequencies.

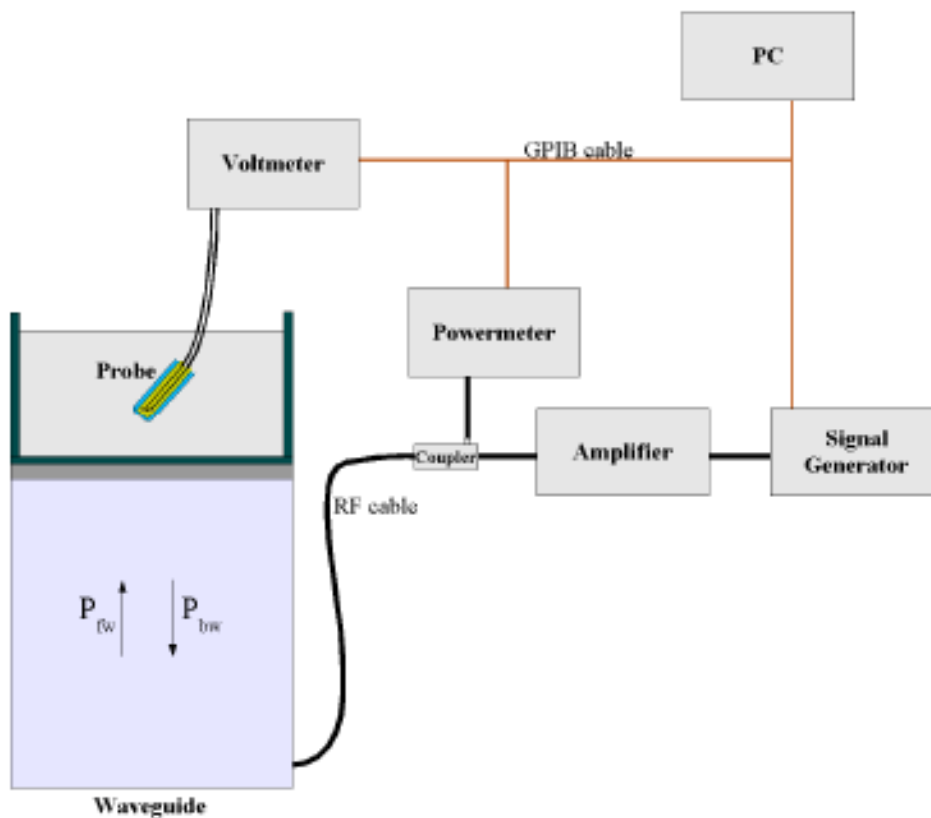

$$SAR = \frac{4(P_{fw} - P_{bw})}{ab\sigma} \cos^2 \left( \pi \frac{y}{a} \right) c^{(2\pi/\sigma)}$$

Where :

- Pfw = Forward Power
- Pbw = Backward Power
- a and b = Waveguide Dimensions
- $\delta$  = Skin Depth

### Keithley configuration

Rate = Medium; Filter =ON; RDGS=10; FILTER TYPE =MOVING AVERAGE; RANGE AUTO After each calibration, a SAR measurement is performed on a validation dipole and compared with a NPL calibrated probe, to verify it.

The calibration factors, CF(N), for the 3 sensors corresponding to dipole 1, dipole 2 and dipole 3 are:

$$CF(N)=SAR(N)/V_{lin}(N) \quad (N=1,2,3)$$

The linearised output voltage  $V_{lin}(N)$  is obtained from the displayed output voltage  $V(N)$  using

$$V_{lin}(N)=V(N)*(1+V(N)/DCP(N)) \quad (N=1,2,3)$$

Where the DCP is the diode compression point in mV.

#### 4.2.4 Phantoms

For the measurements the Specific Anthropomorphic Mannequin (SAM) defined by the IEEE SCC-34/SC2 group is used. The phantom is a polyurethane shell integrated in a wooden table. The thickness of the phantom amounts to 2mm +/- 0.2mm. It enables the dosimetric evaluation of left and right phone usage and includes an additional flat phantom part for the simplified performance check. The phantom set-up includes a cover, which prevents the evaporation of the liquid.

**Photo of Phantom SN 30/13 SAM103**



**Photo of Phantom SN 30/13 SAM104**



Serial Number	Positionner Material	Permittivity	Loss Tangent
SN 30/13 SAM103	Gelcoat with fiberglass	3.4	0.02
SN 30/13 SAM104	Gelcoat with fiberglass	3.4	0.02

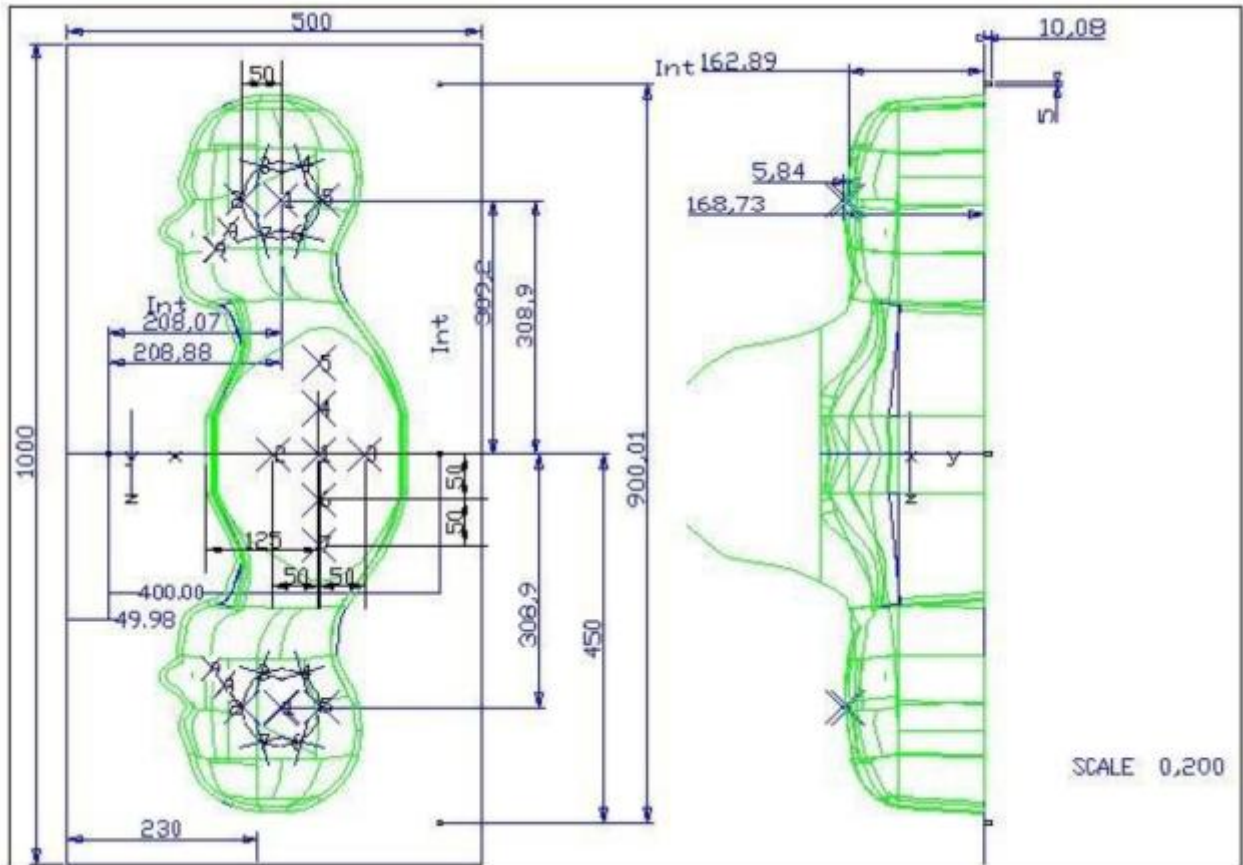

Serial Number	Left Head		Right Head		Flat Part	
<b>SN 30/13 SAM103</b>	2	2.00	2	2.03	1	2.09
	3	2.02	3	2.05	2	2.10
	4	2.04	4	2.04	3	2.09
	5	2.04	5	2.07	4	2.11
	6	2.02	6	2.07	5	2.11
	7	2.01	7	2.09	6	2.09
	8	2.04	8	2.10	7	2.11
	9	2.02	9	2.09	-	-
	<b>SN 30/13 SAM104</b>	2	2.05	2	2.06	1
3		2.08	3	2.03	2	2.03
4		2.05	4	2.03	3	2.01
5		2.06	5	2.02	4	2.03
6		2.08	6	2.02	5	2.03
7		2.06	7	2.04	6	2.00
8		2.07	8	2.04	7	1.98
9		2.07	9	2.05	-	-

#### 4.2.5 Device Holder

The SAR in the phantom is approximately inversely proportional to the square of the distance between the source and the liquid surface. For a source at 5 mm distance, a positioning uncertainty of  $\pm 0.5$  mm would produce a SAR uncertainty of  $\pm 20$  %. Accurate device positioning is therefore crucial for accurate and repeatable measurements. The positions in which the devices must be measured are defined by the standards.



Serial Number	Holder Material	Permittivity	Loss Tangent
SN 25/13 MSH87	Deirin	3.7	0.005
SN 25/13 MSH88	Deirin	3.7	0.005

The positioning system allows obtaining cheek and tilting position with a very good accuracy. In compliance with CENELEC, the tilt angle uncertainty is lower than  $1^\circ$ .

#### 4.2.6 Simulating Liquid

For SAR measurement of the field distribution inside the phantom, the phantom must be filled with homogeneous tissue simulating liquid to a depth of at least 15 cm. For head SAR testing, the liquid height from the ear reference point (ERP) of the phantom to the liquid top surface is larger than 15 cm. For body SAR testing, the liquid height from the center of the flat phantom to the liquid top surface is larger than 15 cm. The nominal dielectric values of the tissue simulating liquids in the phantom and the tolerance of 5%.

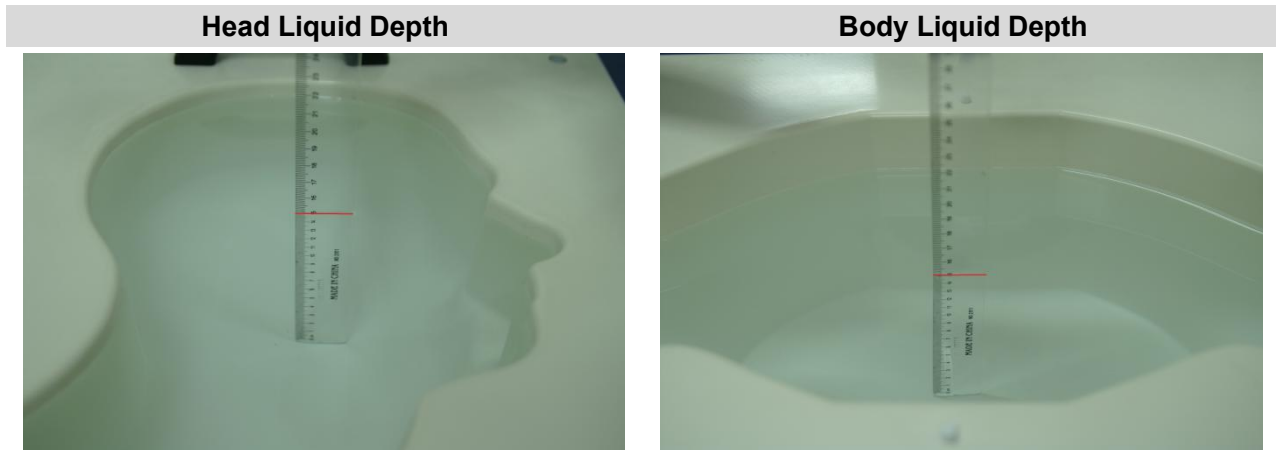

The following table gives the recipes for tissue simulating liquid and the theoretical Conductivity/Permittivity.

Head (Reference IEEE1528)								
Frequency (MHz)	Water (%)	Sugar (%)	Cellulose (%)	Salt (%)	Preventol (%)	DGBE (%)	Conductivity $\sigma$ (S/m)	Permittivity $\epsilon$
750	41.1	57.0	0.2	1.4	0.2	0	0.89	41.9
835	40.3	57.9	0.2	1.4	0.2	0	0.90	41.5
900	40.3	57.9	0.2	1.4	0.2	0	0.97	41.5
1800, 1900, 2000	55.2	0	0	0.3	0	44.5	1.4	40.0
2450	55.0	0	0	0.1	0	44.9	1.80	39.2
2600	54.9	0	0	0.1	0	45.0	1.96	39.0
Frequency(MHz)	Water (%)	Hexyl Carbitol (%)			Triton X-100 (%)		Conductivity $\sigma$ (S/m)	Permittivity $\epsilon$
5200	62.52	17.24			17.24		4.66	36.0
5800	62.52	17.24			17.24		5.27	35.3
Body (From instrument manufacturer)								
Frequency (MHz)	Water (%)	Sugar (%)	Cellulose (%)	Salt (%)	Preventol (%)	DGBE (%)	Conductivity $\sigma$ (S/m)	Permittivity $\epsilon$
750	51.7	47.2	0	0.9	0.1	0	0.96	55.5
835	50.8	48.2	0	0.9	0.1	0	0.97	55.2
900	50.8	48.2	0	0.9	0.1	0	1.05	55.0
1800, 1900, 2000	70.2	0	0	0.4	0	29.4	1.52	53.3
2450	68.6	0	0	0.1	0	31.3	1.95	52.7
2600	68.2	0	0	0.1	0	31.7	2.16	52.5

Frequency(MHz)	Water	DGBE (%)	Salt (%)	Conductivity $\sigma$ (S/m)	Permittivity $\epsilon$
5200	78.60	21.40	/	5.54	47.86
5800	78.50	21.40	0.1	6.0	48.20

## 5 MEASUREMENT PROCEDURE

### 5.1 Antenna Port Test Requirement

The SATIMO SAR system is equipped with one or more system validation kits. These units together with the predefined measurement procedures within the SATIMO software enable the user to conduct the system performance check and system validation. System validation kit includes a dipole, tripod holder to fix it underneath the flat phantom and a corresponding distance holder.

### 5.2 Purpose of System Check

The system performance check verifies that the system operates within its specifications. System and operator errors can be detected and corrected. It is recommended that the system performance check be performed prior to any usage of the system in order to guarantee reproducible results. The system performance check uses normal SAR measurements in a simplified setup with a well characterized source. This setup was selected to give a high sensitivity to all parameters that might fail or vary over time. The system check does not intend to replace the calibration of the components, but indicates situations where the system uncertainty is exceeded due to drift or failure.

### 5.3 System Check Setup

In the simplified setup for system evaluation, the EUT is replaced by a calibrated dipole and the power source is replaced by a continuous wave that comes from a signal generator. The calibrated dipole must be placed beneath the flat phantom section of the SAM twin phantom with the correct distance holder. The distance holder should touch the phantom surface with a light pressure at the reference marking and be oriented parallel to the long side of the phantom. The equipment setup is shown below:

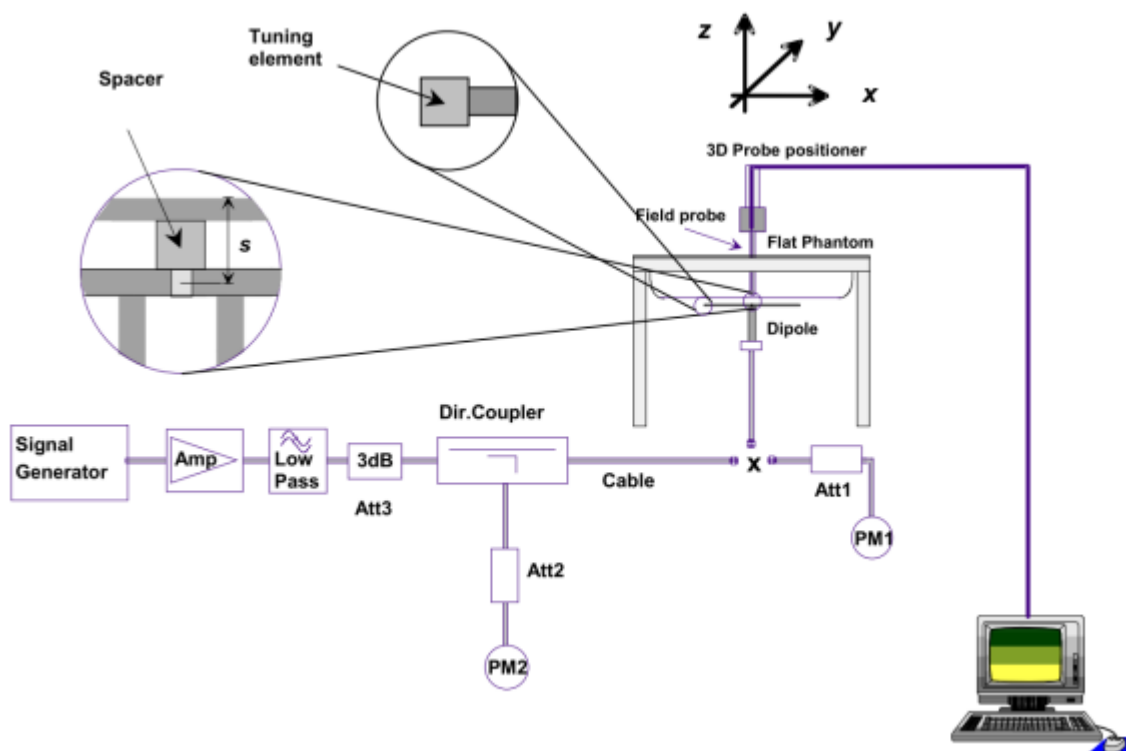



## 6 EUT TEST POSITION CONFIGURATIONS

According to KDB 648474 D04 Handset, handsets are tested for SAR compliance in head, body-worn accessory and other use configurations described in the following subsections.

### 6.1 Head Exposure Conditions

Head exposure is limited to next to the ear voice mode operations. Head SAR compliance is tested according to the test positions defined in IEEE Std 1528-2013 using the SAM phantom illustrated as below.

### 6.2 Define two imaginary lines on the handset

- The vertical center line passes through two points on the front side of the handset - the midpoint of the width  $w_t$  of the handset at the level of the acoustic output, and the midpoint of the width  $w_b$  of the bottom of the handset.
- The horizontal line is perpendicular to the vertical centerline and passes through the center of the acoustic output. The horizontal line is also tangential to the face of the handset at point A.
- The two lines intersect at point A. Note that for many handsets, point A coincides with the center of the acoustic output; however, the acoustic output may be located elsewhere on the horizontal line. Also note that the vertical centerline is not necessarily parallel to the front face of the handset, especially for clamshell handsets, handsets with flip covers, and other irregularly shaped handsets.

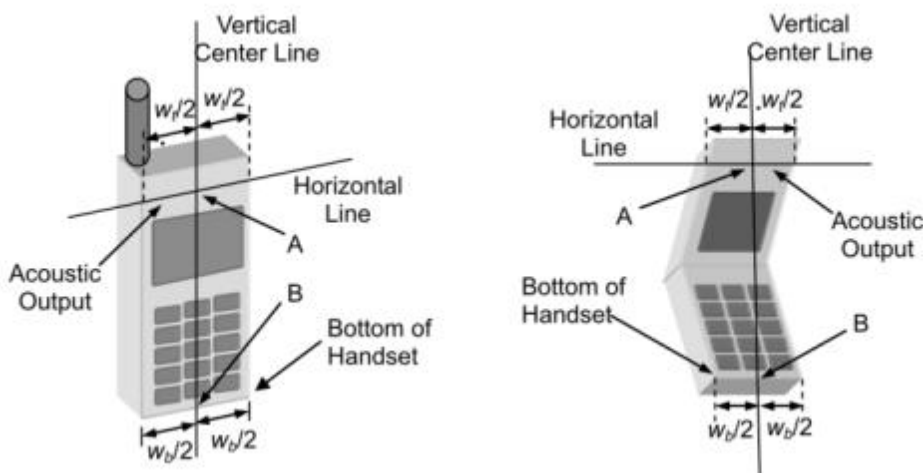

#### 6.2.1 Cheek Position

- To position the device with the vertical center line of the body of the device and the horizontal line crossing the center piece in a plane parallel to the sagittal plane of the phantom. While maintaining the device in this plane, align the vertical center line with the reference plane containing the three ear and mouth reference point (M: Mouth, RE: Right Ear, and LE: Left Ear) and align the center of the ear piece with the line RE-LE.
- To move the device towards the phantom with the ear piece aligned with the line LE-RE until the phone touched the ear. While maintaining the device in the reference plane and maintaining the phone contact with the ear, move the bottom of the phone until any point on the front side is in contact with the cheek of the phantom or until contact with the ear is lost.

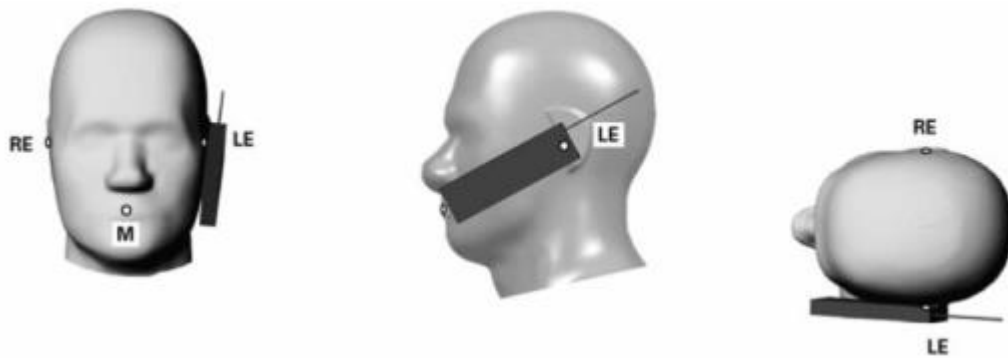

### 6.2.2 Tilted Position

- (a) To position the device in the “cheek” position described above.
- (b) While maintaining the device the reference plane described above and pivoting against the ear, moves it outward away from the mouth by an angle of 15 degrees or until contact with the ear is lost.



### 6.3 Body-worn Position Conditions

Body-worn accessory exposure is typically related to voice mode operations when handsets are carried in body-worn accessories. The body-worn accessory procedures in KDB 447498 are used to test for body-worn accessory SAR compliance, without a headset connected to it. This enables the test results for such configuration to be compatible with that required for hotspot mode when the body-worn accessory test separation distance is greater than or equal to that required for hotspot mode. When the reported SAR for a body-worn accessory, measured without a headset connected to the handset, is  $> 1.2 \text{ W/kg}$ , the highest reported SAR configuration for that wireless mode and frequency band should be repeated for that body-worn accessory with a headset attached to the handset.

Body-worn accessories that do not contain metallic or conductive components may be tested according to worst-case exposure configurations, typically according to the smallest test separation distance required for the group of body-worn accessories with similar operating and exposure characteristics. All body-worn accessories containing metallic components are tested in conjunction with the host device.

Body-worn accessory SAR compliance is based on a single minimum test separation distance for all wireless and operating modes applicable to each body-worn accessory used by the host, and according to the relevant voice and/or data mode transmissions and operations. If a body-worn accessory supports voice only operations in its normal and expected use conditions, testing of data mode for body-worn compliance is not required. A conservative minimum test separation distance for supporting off-the-shelf body-worn accessories that may be acquired by users of consumer handsets is used to test for body-worn accessory SAR compliance. This distance is determined by the handset manufacturer, according to the requirements of Supplement C 01-01. Devices that are designed to operate on the body of users using lanyards and straps, or without requiring additional body-worn accessories, will be tested using a conservative minimum test separation distance  $\leq 5 \text{ mm}$  to support compliance.

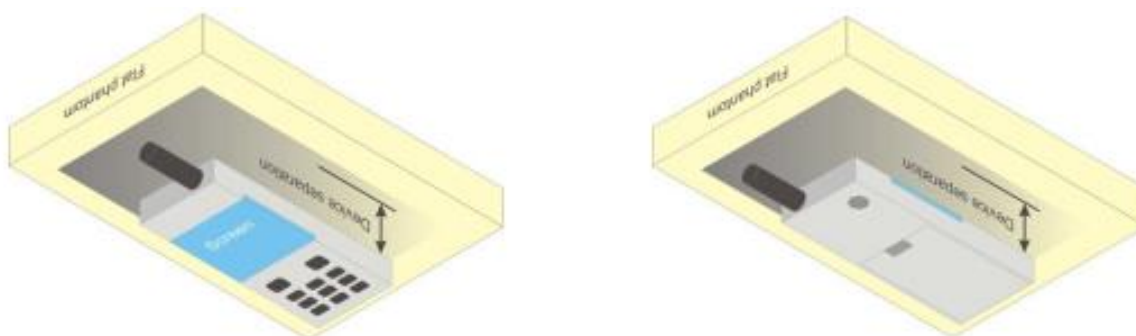

## 6.4 Hotspot Mode Exposure Position Conditions

For handsets that support hotspot mode operations, with wireless router capabilities and various web browsing functions, the relevant hand and body exposure conditions are tested according to the hotspot SAR procedures in KDB 941225. A test separation distance of 10 mm is required between the phantom and all surfaces and edges with a transmitting antenna located within 25 mm from that surface or edge. When the form factor of a handset is smaller than 9 cm x 5 cm, a test separation distance of 5 mm (instead of 10 mm) is required for testing hotspot mode. When the separation distance required for body-worn accessory testing is larger than or equal to that tested for hotspot mode, in the same wireless mode and for the same surface of the phone, the hotspot mode SAR data may be used to support body-worn accessory SAR compliance for that particular configuration (surface).

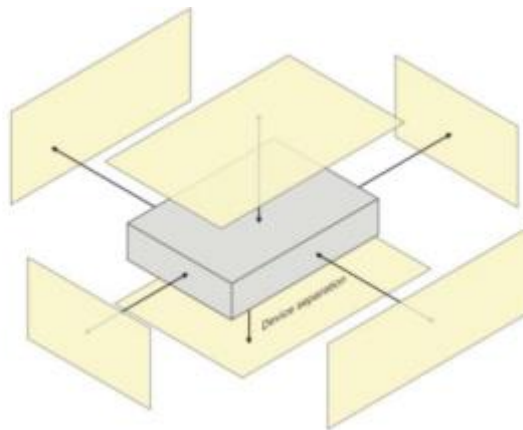

## 7 SAR MEASUREMENT PROCEDURES

### 7.1 SAR Measurement Process Diagram

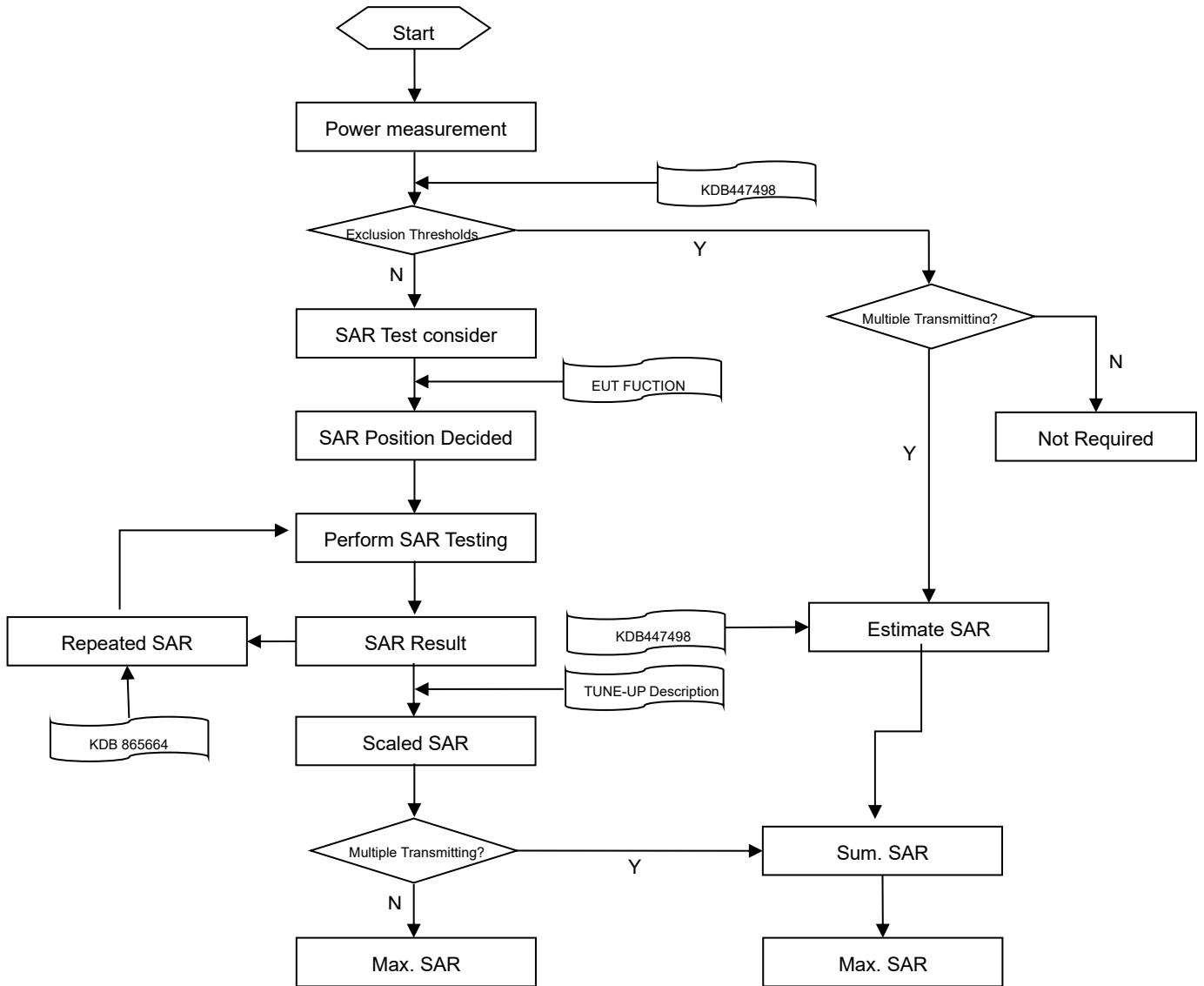

## 7.2 SAR Scan General Requirements

Probe boundary effect error compensation is required for measurements with the probe tip closer than half a probe tip diameter to the phantom surface. Both the probe tip diameter and sensor offset distance must satisfy measurement protocols; to ensure probe boundary effect errors are minimized and the higher fields closest to the phantom surface can be correctly measured and extrapolated to the phantom surface for computing 1-g SAR. Tolerances of the post-processing algorithms must be verified by the test laboratory for the scan resolutions used in the SAR measurements, according to the reference distribution functions specified in IEEE Std 1528-2013.

			≤3GHz	>3GHz
Maximum distance from closest measurement point (geometric center of probe sensors) to phantom surface			5±1 mm	$\frac{1}{2} \cdot \delta \cdot \ln(2) \pm 0.5$ mm
Maximum probe angle from probe axis to phantom surface normal at the measurement location			30°±1°	20°±1°
Maximum area scan spatial resolution: $\Delta x$ Area , $\Delta y$ Area			≤ 2 GHz: ≤ 15 mm 2 – 3 GHz: ≤ 12 mm	3–4 GHz: ≤ 12 mm 4 – 6 GHz: ≤ 10 mm
			When the x or y dimension of the test device, in the measurement plane orientation, is smaller than the above, the measurement resolution must be ≤ the corresponding x or y dimension of the test device with at least one measurement point on the test device.	
Maximum zoom scan spatial resolution: $\Delta x$ Zoom , $\Delta y$ Zoom			≤ 2 GHz: ≤ 8 mm 2 – 3 GHz: ≤ 5 mm*	3–4 GHz: ≤ 5 mm* 4 – 6 GHz: ≤ 4 mm*
Maximum zoom scan spatial resolution, normal to phantom surface	uniform grid: $\Delta z$ Zoom (n)		≤ 5 mm	3–4 GHz: ≤ 4 mm
				4–5 GHz: ≤ 3 mm
				5–6 GHz: ≤ 2 mm
	graded grid	$\Delta z$ Zoom (1): between 1st two points closest to phantom surface	≤ 4 mm	3–4 GHz: ≤ 3 mm
$\Delta z$ Zoom (n>1): between subsequent points		4–5 GHz: ≤ 2.5 mm		
			5–6 GHz: ≤ 2 mm	
Minimum zoom scan volume	x, y, z		≥30 mm	3–4 GHz: ≥ 28 mm
				4–5 GHz: ≥ 25 mm
				5–6 GHz: ≥ 22 mm
<b>Note:</b> <b>1. <math>\delta</math> is the penetration depth of a plane-wave at normal incidence to the tissue medium; see draft standard IEEE P1528-2011 for details.</b> <b>2. * When zoom scan is required and the reported SAR from the area scan based 1-g SAR estimation procedures of KDB 447498 is ≤ 1.4 W/kg, ≤ 8 mm, ≤ 7 mm and ≤ 5 mm zoom scan resolution may be applied, respectively, for 2 GHz to 3GHz, 3 GHz to 4 GHz and 4 GHz to 6 GHz.</b>				

### 7.3 SAR Measurement Procedure

The following steps are used for each test position

- Establish a call with the maximum output power with a base station simulator. The connection between the mobile and the base station simulator is established via air interface
- Measurement of the local E-field value at a fixed location. This value serves as a reference value for calculating a possible power drift.
- Measurement of the SAR distribution with a grid of 8 to 16mm \* 8 to 16 mm and a constant distance to the inner surface of the phantom. Since the sensors cannot directly measure at the inner phantom surface, the values between the sensors and the inner phantom surface are extrapolated. With these values the area of the maximum SAR is calculated by an interpolation scheme.
- Around this point, a cube of 30 \* 30 \* 30 mm or 32 \* 32 \* 32 mm is assessed by measuring 5 or 8 \* 5 or 8\*4 or 5 mm. With these data, the peak spatial-average SAR value can be calculated.

### 7.4 Area & Zoom Scan Procedures

First Area Scan is used to locate the approximate location(s) of the local peak SAR value(s). The measurement grid within an Area Scan is defined by the grid extent, grid step size and grid offset. Next, in order to determine the EM field distribution in a three-dimensional spatial extension, Zoom Scan is required. The Zoom Scan is performed around the highest E-field value to determine the averaged SAR-distribution over 10 g. Area scan and zoom scan resolution setting follows KDB 865664 D01 quoted below.

When the 1-g SAR of the highest peak is within 2 dB of the SAR limit, additional zoom scans are required for other peaks within 2 dB of the highest peak that have not been included in any zoom scan to ensure there is no increase in SAR.

## 8 CONDUCTED RF OUTPUT POWER

### 8.1 GSM

GSM 850								
GSM850 Band	Burst Average Power(dBm)			Tune-up Limit (dBm)	Frame-Averaged power (dBm)			Tune-up Limit (dBm)
Channel	128	190	251		128	190	251	
GPRS (GMSK, 1-Slot)	31.93	32.01	31.99	32.50	22.74	22.82	22.80	23.31
GPRS (GMSK, 2-Slots)	31.19	31.28	31.23	31.50	25.06	25.15	<b>25.10</b>	25.37
GPRS (GMSK, 3-Slots)	29.30	29.38	29.33	29.50	24.88	24.96	24.91	25.08
GPRS (GMSK, 4-Slots)	28.20	28.31	28.22	28.50	25.02	25.13	25.04	25.32
EGPRS (8PSK, 1-Slot)	24.13	24.02	23.89	24.50	14.94	14.83	14.70	15.31
EGPRS (8PSK, 2-Slots)	23.92	23.84	23.75	24.00	17.79	17.71	17.62	17.87
EGPRS (8PSK, 3-Slots)	23.73	23.83	23.35	24.00	19.31	19.41	18.93	19.58
EGPRS (8PSK, 4-Slots)	23.69	23.41	23.20	24.00	20.51	20.23	20.02	20.82
GSM 1900								
GSM1900 Band	Burst Average Power(dBm)			Tune-up Limit (dBm)	Frame-Averaged power(dBm)			Tune-up Limit (dBm)
Channel	512	661	810		512	661	810	
GPRS (GMSK, 1-Slot)	29.21	29.09	28.92	29.50	20.02	19.90	19.73	20.31
GPRS (GMSK, 2-Slots)	28.43	28.34	28.24	28.50	22.30	22.21	22.11	22.37
GPRS (GMSK, 3-Slots)	26.55	26.49	26.48	27.00	22.13	22.07	22.06	22.58
GPRS (GMSK, 4-Slots)	25.50	25.43	25.45	26.00	<b>22.32</b>	22.25	22.27	22.82
EGPRS (8PSK, 1-Slot)	25.71	25.67	25.88	26.00	16.52	16.48	16.69	16.81
EGPRS (8PSK, 2-Slots)	24.41	24.41	24.46	25.00	18.28	18.28	18.33	18.87
EGPRS (8PSK, 3-Slots)	22.13	22.08	22.13	22.50	17.71	17.66	17.71	18.08
EGPRS (8PSK, 4-Slots)	20.88	20.98	21.01	21.50	17.70	17.80	17.83	18.32

Note 1: SAR testing was performed on the maximum frame-averaged power mode.

Note 2: The frame-averaged power is linearly proportion to the slot number configured and it is linearly scaled the maximum burst-averaged power based on time slots. The calculated method is shown as below:

Frame-averaged power = Burst averaged power (1 Tx Slot) – 9.19 dB

Frame-averaged power = Burst averaged power (2 Tx Slots) – 6.13 dB

Frame-averaged power = Burst averaged power (3 Tx Slots) - 4.42dB

Frame-averaged power = Burst averaged power (4 Tx Slots) – 3.18 dB



## 8.2 WCDMA

WCDMA	Band 2				Band 4			
Channel	9262	9400	9538	Tune-up Limit (dBm)	1312	1412	1513	Tune-up Limit (dBm)
RMC 12.2Kbps	23.15	23.39	<b>23.47</b>	23.50	23.96	24.23	<b>24.39</b>	24.50
HSDPA Subtest-1	22.17	22.40	22.53	23.00	22.94	23.25	23.39	23.50
HSDPA Subtest-2	22.15	22.40	22.53	23.00	22.90	23.19	23.29	23.50
HSDPA Subtest-3	21.64	21.90	22.00	22.00	22.42	22.72	22.84	23.00
HSDPA Subtest-4	21.61	21.83	21.96	22.00	22.42	22.69	22.83	23.00
HSUPA Subtest-1	20.23	20.43	20.54	21.00	21.00	21.29	21.45	22.00
HSUPA Subtest-2	20.19	20.45	20.51	21.00	20.98	21.32	21.45	22.00
HSUPA Subtest-3	21.20	21.40	21.51	22.00	21.95	22.28	22.40	23.00
HSUPA Subtest-4	19.70	19.96	20.04	21.00	20.51	20.80	20.92	22.00
HSUPA Subtest-5	21.17	21.38	21.48	22.00	21.94	22.26	22.39	23.00
WCDMA	Band 5				-			
Channel	4132	4182	4233	Tune-up Limit (dBm)	-	-	-	-
RMC 12.2Kbps	22.68	22.69	<b>22.76</b>	23.00	-	-	-	-
HSDPA Subtest-1	21.70	21.69	21.73	22.00	-	-	-	-
HSDPA Subtest-2	21.66	21.62	21.69	22.00	-	-	-	-
HSDPA Subtest-3	21.22	21.16	21.24	22.00	-	-	-	-
HSDPA Subtest-4	21.17	21.17	21.21	22.00	-	-	-	-
HSUPA Subtest-1	19.72	19.71	19.73	20.00	-	-	-	-
HSUPA Subtest-2	19.72	19.72	19.76	20.00	-	-	-	-
HSUPA Subtest-3	20.74	20.71	20.78	21.00	-	-	-	-
HSUPA Subtest-4	19.22	19.21	19.29	20.00	-	-	-	-
HSUPA Subtest-5	20.70	20.70	20.73	21.00	-	-	-	-

### 8.3 LTE

FDD LTE Band 2									
Bandwidth (MHz)	RB Set	Power (dBm)							
		QPSK			Tune up limit (dBm)	16QAM			Tune up limit (dBm)
	Channel	18700	18900	19100		18700	18900	19100	
20 MHz	1 (RB_Pos:0)	23.33	23.45	23.27	24.00	22.84	22.97	22.74	23.50
	1 (RB_Pos:50)	<b>23.79</b>	23.75	23.74	24.00	23.29	23.24	23.19	23.50
	1 (RB_Pos:99)	23.40	23.26	23.54	24.00	22.98	22.71	22.95	23.50
	50 (RB_Pos:0)	22.69	22.79	22.77	23.00	21.72	21.89	21.78	22.50
	50 (RB_Pos:25)	22.71	22.78	22.83	23.00	21.76	21.92	21.82	22.50
	50 (RB_Pos:50)	22.66	22.67	22.74	23.00	21.67	21.80	21.78	22.50
	100 (RB_Pos:0)	22.65	22.76	22.78	23.00	21.70	21.80	21.85	22.50
Bandwidth (MHz)	RB Set	Power (dBm)							
		QPSK			Tune up limit (dBm)	16QAM			Tune up limit (dBm)
	Channel	18675	18900	19125		18675	18900	19125	
15 MHz	1 (RB_Pos:0)	23.53	23.56	23.52	24.00	22.44	23.06	22.88	23.50
	1 (RB_Pos:38)	23.64	23.59	23.71	24.00	22.56	23.10	23.11	23.50
	1 (RB_Pos:74)	23.45	23.39	23.81	24.00	22.45	22.83	23.00	23.50
	36 (RB_Pos:0)	22.71	22.75	22.78	23.00	21.71	21.84	21.75	22.50
	36 (RB_Pos:20)	22.74	22.72	22.84	23.00	21.68	21.87	21.85	22.50
	36 (RB_Pos:39)	22.65	22.63	22.83	23.00	21.68	21.78	21.84	22.50
	75 (RB_Pos:0)	22.74	22.76	22.85	23.00	21.65	21.79	21.84	22.50
Bandwidth (MHz)	RB Set	Power (dBm)							
		QPSK			Tune up limit (dBm)	16QAM			Tune up limit (dBm)
	Channel	18650	18900	19150		18650	18900	19150	
10 MHz	1 (RB_Pos:0)	23.58	23.59	23.63	24.00	22.49	23.06	22.64	23.50
	1 (RB_Pos:25)	23.69	23.70	23.90	24.00	22.58	23.18	22.91	23.50
	1 (RB_Pos:49)	23.52	23.46	23.89	24.00	22.49	22.88	22.76	23.50
	25 (RB_Pos:0)	22.68	22.75	22.86	23.00	21.68	21.88	22.01	22.50
	25 (RB_Pos:12)	22.67	22.78	22.89	23.00	21.66	21.87	22.03	22.50
	25 (RB_Pos:25)	22.66	22.75	22.85	23.00	21.65	21.86	21.98	22.50
	50 (RB_Pos:0)	22.67	22.79	22.90	23.00	21.66	21.89	22.01	22.50
Bandwidth (MHz)	RB Set	Power (dBm)							
		QPSK			Tune up limit (dBm)	16QAM			Tune up limit (dBm)
	Channel	18625	18900	19175		18625	18900	19175	
5 MHz	1 (RB_Pos:0)	23.49	23.52	23.62	24.00	22.69	23.14	22.80	23.50
	1 (RB_Pos:13)	23.59	23.61	23.80	24.00	22.80	23.18	22.91	23.50
	1 (RB_Pos:24)	23.45	23.48	23.76	24.00	22.64	23.05	22.80	23.50
	12 (RB_Pos:0)	22.59	22.67	22.82	23.00	21.66	21.90	21.99	22.50

Bandwidth (MHz)	RB Set	Power (dBm)							
		QPSK			Tune up limit (dBm)	16QAM			Tune up limit (dBm)
		Channel	18615	18900		19185	18615	18900	
	12 (RB_Pos:6)	22.63	22.70	22.89	23.00	21.72	21.92	22.03	22.50
	12 (RB_Pos:13)	22.56	22.66	22.82	23.00	21.70	21.87	21.97	22.50
	25 (RB_Pos:0)	22.63	22.76	22.88	23.00	21.68	21.86	21.91	22.50
3.0 MHz	1 (RB_Pos:0)	23.60	23.55	23.80	24.00	22.50	23.10	22.83	23.50
	1 (RB_Pos:8)	23.56	23.53	23.82	24.00	22.50	23.02	22.80	23.50
	1 (RB_Pos:14)	23.56	23.50	23.92	24.00	22.48	23.00	22.75	23.50
	8 (RB_Pos:0)	22.58	22.61	22.85	23.00	21.68	21.78	21.91	22.50
	8 (RB_Pos:3)	22.67	22.67	22.87	23.00	21.72	21.83	21.97	22.50
	8 (RB_Pos:7)	22.60	22.61	22.83	23.00	21.69	21.74	21.87	22.50
	15 (RB_Pos:0)	22.62	22.65	22.88	23.00	21.62	21.72	21.87	22.50
1.4 MHz	1 (RB_Pos:0)	23.69	23.71	23.47	24.00	23.04	23.05	22.80	23.50
	1 (RB_Pos:3)	23.84	23.90	23.73	24.00	23.19	23.17	22.95	23.50
	1 (RB_Pos:5)	23.66	23.29	23.53	24.00	23.04	23.00	22.79	23.50
	3 (RB_Pos:0)	23.72	23.34	23.65	24.00	23.05	22.94	23.05	23.50
	3 (RB_Pos:1)	23.77	23.38	23.61	24.00	23.04	22.94	23.13	23.50
	3 (RB_Pos:3)	23.68	23.31	23.65	24.00	23.00	22.95	23.09	23.50
	6 (RB_Pos:0)	22.68	22.29	22.51	23.00	22.20	21.57	22.01	22.50

FDD LTE Band 4									
Bandwidth (MHz)	RB Set	Power (dBm)							
		QPSK			Tune up limit (dBm)	16QAM			Tune up limit (dBm)
		Channel	20050	20175		20300	20050	20175	
20 MHz	1 (RB_Pos:0)	23.06	23.36	23.33	24.00	22.48	22.76	22.65	23.50
	1 (RB_Pos:50)	23.62	<b>23.81</b>	23.53	24.00	23.10	23.13	22.90	23.50
	1 (RB_Pos:99)	23.21	23.18	23.06	24.00	22.66	22.58	22.41	23.50
	50 (RB_Pos:0)	22.47	22.55	22.47	23.00	21.41	21.53	21.41	22.50
	50 (RB_Pos:25)	22.49	22.61	22.49	23.00	21.45	21.58	21.40	22.50
	50 (RB_Pos:50)	22.42	22.57	22.27	23.00	21.40	21.53	21.19	22.50
	100 (RB_Pos:0)	22.47	22.54	22.41	23.00	21.44	21.51	21.37	22.50
Bandwidth (MHz)	RB Set	Power (dBm)							
		QPSK			Tune up limit (dBm)	16QAM			Tune up limit (dBm)
		Channel	20025	20175		20325	20025	20175	

15 MHz	1 (RB_Pos:0)	23.24	23.54	23.48	24.00	22.14	22.84	22.78	23.50
	1 (RB_Pos:38)	23.48	23.63	23.43	24.00	22.38	22.93	22.74	23.50
	1 (RB_Pos:74)	23.32	23.38	23.25	24.00	22.24	22.69	22.59	23.50
	36 (RB_Pos:0)	22.52	22.63	22.56	23.00	21.46	21.67	21.47	22.50
	36 (RB_Pos:20)	22.57	22.69	22.50	23.00	21.48	21.68	21.43	22.50
	36 (RB_Pos:39)	22.51	22.66	22.37	23.00	21.47	21.66	21.31	22.50
	75 (RB_Pos:0)	22.50	22.63	22.49	23.00	21.40	21.62	21.40	22.50
Bandwidth (MHz)	RB Set	Power (dBm)							
	Channel	QPSK			Tune up limit (dBm)	16QAM			Tune up limit (dBm)
		20000	20175	20350		20000	20175	20350	
10 MHz	1 (RB_Pos:0)	23.30	23.59	23.41	24.00	22.17	22.89	22.34	23.50
	1 (RB_Pos:25)	23.61	23.74	23.57	24.00	22.47	23.08	22.45	23.50
	1 (RB_Pos:49)	23.42	23.49	23.31	24.00	22.32	22.80	22.29	23.50
	25 (RB_Pos:0)	22.42	22.67	22.45	23.00	21.37	21.61	21.45	22.50
	25 (RB_Pos:12)	22.47	22.64	22.38	23.00	21.43	21.63	21.41	22.50
	25 (RB_Pos:25)	22.47	22.62	22.36	23.00	21.42	21.63	21.37	22.50
	50 (RB_Pos:0)	22.42	22.62	22.39	23.50	21.36	21.62	21.35	22.50
Bandwidth (MHz)	RB Set	Power (dBm)							
	Channel	QPSK			Tune up limit (dBm)	16QAM			Tune up limit (dBm)
		19975	20175	20375		19975	20175	20375	
5 MHz	1 (RB_Pos:0)	23.20	23.52	23.27	24.00	22.37	22.95	22.39	23.50
	1 (RB_Pos:13)	23.36	23.62	23.36	24.00	22.44	23.04	22.44	23.50
	1 (RB_Pos:24)	23.29	23.49	23.28	24.00	22.44	22.92	22.39	23.50
	12 (RB_Pos:0)	22.27	22.52	22.36	23.00	21.29	21.61	21.39	22.50
	12 (RB_Pos:6)	22.32	22.61	22.43	23.00	21.34	21.70	21.45	22.50
	12 (RB_Pos:13)	22.27	22.55	22.35	23.00	21.34	21.63	21.36	22.50
	25 (RB_Pos:0)	22.28	22.59	22.40	23.00	21.25	21.58	21.28	22.50
Bandwidth (MHz)	RB Set	Power (dBm)							
	Channel	QPSK			Tune up limit (dBm)	16QAM			Tune up limit (dBm)
		19965	20175	20385		19965	20175	20385	
3.0 MHz	1 (RB_Pos:0)	23.34	23.56	23.42	24.00	22.15	22.87	22.38	23.50
	1 (RB_Pos:8)	23.26	23.53	23.41	24.00	22.13	22.87	22.35	23.50
	1 (RB_Pos:14)	23.26	23.57	23.44	24.00	22.16	22.84	22.36	23.50
	8 (RB_Pos:0)	22.30	22.56	22.45	23.00	21.32	21.59	21.41	22.50
	8 (RB_Pos:3)	22.37	22.63	22.50	23.00	21.38	21.63	21.44	22.50
	8 (RB_Pos:7)	22.32	22.60	22.43	23.00	21.33	21.55	21.38	22.50
	15 (RB_Pos:0)	22.29	22.57	22.42	23.00	21.24	21.56	21.32	22.50
Bandwidth (MHz)	RB Set	Power (dBm)							
	Channel	QPSK			Tune up limit (dBm)	16QAM			Tune up limit (dBm)
		19957	20175	20393		19957	20175	20393	

					(dBm)				(dBm)
1.4 MHz	1 (RB_Pos:0)	23.43	23.77	23.31	24.00	22.71	23.14	22.34	23.50
	1 (RB_Pos:3)	23.62	23.96	23.34	24.00	22.92	23.01	22.50	23.50
	1 (RB_Pos:5)	23.49	23.74	23.09	24.00	22.75	22.87	22.34	23.50
	3 (RB_Pos:0)	23.40	23.73	23.09	24.00	22.69	22.72	22.57	23.50
	3 (RB_Pos:1)	23.45	23.76	23.12	24.00	22.73	22.71	22.62	23.50
	3 (RB_Pos:3)	23.39	23.73	23.10	24.00	22.68	22.73	22.59	23.50
	6 (RB_Pos:0)	22.52	22.75	22.19	23.00	21.90	21.45	21.54	22.50

FDD LTE Band 5									
Bandwidth (MHz)	RB Set	Power (dBm)							
		QPSK			Tune up limit (dBm)	16QAM			Tune up limit (dBm)
	Channel	20450	20525	20600		20450	20525	20600	
10 MHz	1 (RB_Pos:0)	23.22	23.21	23.23	23.50	22.22	22.59	22.28	23.00
	1 (RB_Pos:25)	23.39	23.37	<b>23.44</b>	23.50	22.39	22.76	22.44	23.00
	1 (RB_Pos:49)	23.19	23.25	23.32	23.50	22.19	22.68	22.33	23.00
	25 (RB_Pos:0)	22.33	22.37	22.40	23.00	21.32	21.36	21.49	22.00
	25 (RB_Pos:12)	22.33	22.38	22.43	23.00	21.32	21.42	21.52	22.00
	25 (RB_Pos:25)	22.27	22.42	22.36	23.00	21.29	21.49	21.42	22.00
	50 (RB_Pos:0)	22.35	22.42	22.42	23.00	21.27	21.46	21.45	22.00
Bandwidth (MHz)	RB Set	Power (dBm)							
		QPSK			Tune up limit (dBm)	16QAM			Tune up limit (dBm)
	Channel	20425	20525	20625		20425	20525	20625	
5MHz	1 (RB_Pos:0)	23.24	23.18	23.25	23.50	22.48	22.74	22.42	23.00
	1 (RB_Pos:13)	23.34	23.31	23.37	23.50	22.51	22.83	22.52	23.00
	1 (RB_Pos:24)	23.20	23.18	23.29	23.50	22.44	22.76	22.42	23.00
	12 (RB_Pos:0)	22.34	22.32	22.40	23.00	21.48	21.48	21.53	22.00
	12 (RB_Pos:6)	22.41	22.39	22.51	23.00	21.50	21.59	21.56	22.00
	12 (RB_Pos:13)	22.36	22.35	22.44	23.00	21.42	21.54	21.55	22.00
	25 (RB_Pos:0)	22.37	22.40	22.43	23.00	21.39	21.48	21.40	22.00
Bandwidth (MHz)	RB Set	Power (dBm)							
		QPSK			Tune up limit (dBm)	16QAM			Tune up limit (dBm)
	Channel	20415	20525	20635		20415	20525	20635	
3.0 MHz	1 (RB_Pos:0)	23.34	23.28	23.34	23.50	22.30	22.68	22.44	23.00
	1 (RB_Pos:8)	23.26	23.24	23.35	23.50	22.29	22.64	22.39	23.00
	1 (RB_Pos:14)	23.24	23.28	23.38	23.50	22.25	22.73	22.38	23.00
	8 (RB_Pos:0)	22.42	22.35	22.42	23.00	21.50	21.42	21.46	22.00
	8 (RB_Pos:3)	22.46	22.40	22.50	23.00	21.52	21.46	21.53	22.00
	8 (RB_Pos:7)	22.39	22.37	22.43	23.00	21.48	21.41	21.48	22.00

Bandwidth (MHz)	RB Set	Power (dBm)							
		QPSK			Tune up limit (dBm)	16QAM			Tune up limit (dBm)
	Channel	20407	20525	20643		20407	20525	20643	
	15 (RB_Pos:0)	22.39	22.39	22.48	23.00	21.39	21.38	21.41	22.00
1.4MHz	1 (RB_Pos:0)	23.27	23.18	23.29	23.50	22.37	22.66	22.36	23.00
	1 (RB_Pos:3)	23.43	23.38	23.46	23.50	22.57	22.78	22.53	23.00
	1 (RB_Pos:5)	23.25	23.17	23.32	23.50	22.43	22.58	22.36	23.00
	3 (RB_Pos:0)	23.31	23.27	23.40	23.50	22.43	22.53	22.61	23.00
	3 (RB_Pos:1)	23.34	23.31	23.44	23.50	22.44	22.55	22.67	23.00
	3 (RB_Pos:3)	23.34	23.27	23.44	23.50	22.42	22.55	22.65	23.00
	6 (RB_Pos:0)	22.38	22.31	22.40	23.00	21.53	21.23	21.57	22.00

FDD LTE Band 7									
Bandwidth (MHz)	RB Set	Power (dBm)							
		QPSK			Tune up limit (dBm)	16QAM			Tune up limit (dBm)
	Channel	20850	21100	21350		20850	21100	21350	
20MHz	1 (RB_Pos:0)	22.42	22.94	22.69	24.00	22.49	22.92	22.85	24.00
	1 (RB_Pos:50)	23.03	22.40	23.22	24.00	23.18	22.50	23.33	24.00
	1 (RB_Pos:99)	<b>23.55</b>	22.12	22.30	24.00	23.73	22.28	22.44	24.00
	50 (RB_Pos:0)	22.59	22.49	23.18	23.50	22.33	22.37	23.04	23.50
	50 (RB_Pos:25)	22.95	22.23	23.16	23.50	22.56	22.14	23.04	23.50
	50 (RB_Pos:50)	23.31	21.96	22.79	23.50	22.61	21.92	22.65	23.50
	100 (RB_Pos:0)	22.89	22.19	23.00	23.50	22.51	22.12	22.91	23.50
Bandwidth (MHz)	RB Set	Power (dBm)							
		QPSK			Tune up limit (dBm)	16QAM			Tune up limit (dBm)
	Channel	20825	21100	21375		20825	21100	21375	
15MHz	1 (RB_Pos:0)	22.73	22.92	23.40	24.00	22.21	22.88	23.44	24.00
	1 (RB_Pos:38)	22.91	22.33	22.91	24.00	22.51	22.42	22.99	24.00
	1 (RB_Pos:74)	23.57	22.02	22.41	24.00	23.24	22.16	22.52	24.00
	36 (RB_Pos:0)	22.64	22.47	23.26	23.50	22.41	22.38	23.14	23.50
	36 (RB_Pos:20)	22.83	22.24	22.90	23.50	22.55	22.18	22.79	23.50
	36 (RB_Pos:39)	23.17	22.02	22.58	23.50	22.58	21.98	22.46	23.50
	75 (RB_Pos:0)	22.86	22.21	22.93	23.50	22.55	22.14	22.80	23.50
Bandwidth (MHz)	RB Set	Power (dBm)							
		QPSK			Tune up limit (dBm)	16QAM			Tune up limit (dBm)
	Channel	20800	21100	21400		20800	21100	21400	
10MHz	1 (RB_Pos:0)	22.82	22.76	23.35	24.00	22.27	22.75	23.03	24.00
	1 (RB_Pos:25)	22.89	22.50	22.69	24.00	22.47	22.57	22.46	24.00

Bandwidth (MHz)	RB Set	Power (dBm)							
		QPSK			Tune up limit (dBm)	16QAM			Tune up limit (dBm)
	Channel	20775	21100	21425		20775	21100	21425	
	1 (RB_Pos:49)	23.18	22.10	22.38	24.00	22.83	22.24	22.17	24.00
	25 (RB_Pos:0)	22.71	22.54	23.01	23.50	22.34	22.42	22.95	24.00
	25 (RB_Pos:12)	22.79	22.41	22.70	23.50	22.44	22.32	22.66	24.00
	25 (RB_Pos:25)	22.93	22.22	22.47	23.50	22.47	22.14	22.43	24.00
	50 (RB_Pos:0)	22.76	22.32	22.73	23.50	22.38	22.25	22.65	24.00
5MHz	1 (RB_Pos:0)	23.44	23.04	22.95	24.00	22.92	23.08	22.71	24.00
	1 (RB_Pos:13)	23.38	22.88	22.68	24.00	23.00	23.01	22.51	24.00
	1 (RB_Pos:24)	23.26	22.60	22.50	24.00	23.01	22.78	22.40	24.00
	12 (RB_Pos:0)	23.10	22.80	22.72	23.50	22.32	22.74	22.59	23.50
	12 (RB_Pos:6)	23.08	22.72	22.61	23.50	22.39	22.68	22.50	23.50
	12 (RB_Pos:13)	23.04	22.58	22.52	23.50	22.35	22.57	22.42	23.50
	25 (RB_Pos:0)	22.97	22.65	22.58	23.50	22.32	22.58	22.41	23.50

FDD LTE Band 12									
Bandwidth (MHz)	RB Set	Power (dBm)							
		QPSK			Tune up limit (dBm)	16QAM			Tune up limit (dBm)
	Channel	23060	23095	23130		23060	23095	23130	
10 MHz	1 (RB_Pos:0)	23.30	23.28	23.28	24.00	22.12	22.70	22.29	23.00
	1 (RB_Pos:25)	23.42	23.50	<b>23.55</b>	24.00	22.46	22.78	22.40	23.00
	1 (RB_Pos:49)	23.33	23.36	23.29	24.00	22.14	22.61	22.44	23.00
	25 (RB_Pos:0)	22.28	22.18	22.44	23.00	21.36	21.17	21.42	22.00
	25 (RB_Pos:12)	22.41	22.31	22.37	23.00	21.40	21.28	21.34	22.00
	25 (RB_Pos:25)	22.52	22.19	22.28	23.00	21.48	21.15	21.32	22.00
	50 (RB_Pos:0)	22.43	22.18	22.43	23.00	21.38	21.16	21.34	22.00
5MHz	1 (RB_Pos:0)	23.26	23.29	23.25	24.00	22.34	22.74	22.27	23.00
	1 (RB_Pos:13)	23.37	23.35	23.37	24.00	22.53	22.79	22.41	23.00
	1 (RB_Pos:24)	23.24	23.31	23.22	24.00	22.51	22.69	22.39	23.00
	12 (RB_Pos:0)	22.36	22.22	22.37	23.00	21.51	21.32	21.40	22.00
	12 (RB_Pos:6)	22.41	22.33	22.35	23.00	21.49	21.46	21.42	22.00
	12 (RB_Pos:13)	22.44	22.23	22.31	23.00	21.48	21.34	21.42	22.00
	25 (RB_Pos:0)	22.37	22.21	22.41	23.00	21.45	21.27	21.36	22.00

	Channel	23025	23095	23165	limit (dBm)	23025	23095	23165	limit (dBm)
3.0 MHz	1 (RB_Pos:0)	23.39	23.32	23.35	24.00	22.16	22.69	22.35	23.00
	1 (RB_Pos:8)	23.36	23.30	23.26	24.00	22.24	22.61	22.31	23.00
	1 (RB_Pos:14)	23.30	23.34	23.28	24.00	22.26	22.60	22.34	23.00
	8 (RB_Pos:0)	22.35	22.32	22.33	23.00	21.44	21.38	21.36	22.00
	8 (RB_Pos:3)	22.38	22.38	22.36	23.00	21.49	21.38	21.42	22.00
	8 (RB_Pos:7)	22.30	22.32	22.26	23.00	21.47	21.30	21.33	22.00
	15 (RB_Pos:0)	22.33	22.32	22.32	23.00	21.37	21.30	21.29	22.00
Bandwidth (MHz)	RB Set	Power (dBm)							
		QPSK			Tune up	16QAM			Tune up
	Channel	23017	23095	23173	limit (dBm)	23017	23095	23173	limit (dBm)
1.4MHz	1 (RB_Pos:0)	23.26	23.27	23.20	24.00	22.22	22.56	22.25	23.00
	1 (RB_Pos:3)	23.41	23.44	23.35	24.00	22.45	22.71	22.47	23.00
	1 (RB_Pos:5)	23.27	23.27	23.21	24.00	22.28	22.57	22.32	23.00
	3 (RB_Pos:0)	23.28	23.26	23.33	24.00	22.24	22.47	22.53	23.00
	3 (RB_Pos:1)	23.29	23.29	23.38	24.00	22.29	22.47	22.57	23.00
	3 (RB_Pos:3)	23.28	23.25	23.39	24.00	22.38	22.43	22.58	23.00
	6 (RB_Pos:0)	22.34	22.31	22.20	23.00	21.45	21.18	21.48	22.00



## 8.4 WIFI

### 8.4.1 2.4G WIFI

Band (GHz)	Mode	Channel	Freq. (MHz)	Conducted Power (dBm)	Tune-up Limit (dBm)	SAR Test Require.
2.4 (2.4~2.4835)	802.11b	1	2412	<b>11.70</b>	12.00	Yes
		6	2437	11.50	12.00	No
		11	2462	11.20	12.00	No
	802.11g	1	2412	6.87	7.00	No
		6	2437	9.06	10.00	No
		11	2462	9.05	10.00	No
	802.11n(HT20)	1	2412	6.42	7.00	No
		6	2437	8.80	10.00	No
		11	2462	9.07	10.00	No
	802.11n(HT40)	3	2422	6.15	7.00	No
		6	2437	6.24	7.00	No
		9	2452	6.42	7.00	No

## 8.5 Bluetooth

Mode	GFSK			$\pi/4$ -DQPSK		
Channel	0	39	78	0	39	78
Frequency (MHz)	2402	2441	2480	2402	2441	2480
Conducted Power (dBm)	-2.42	-2.06	-0.88	-3.05	-2.64	-1.47
Tune-Up Limit (dBm)	0.00			-1.00		
Mode	8-DPSK			BLE		
Channel	0	39	78	0	19	39
Frequency (MHz)	2402	2441	2480	2402	2440	2480
Conducted Power (dBm)	-2.84	-2.41	-1.21	-2.61	-2.07	<b>-0.71</b>
Tune-Up Limit (dBm)	-1.00			0.00		

## 9 EUT ANTENNA LOCATION SKETCH

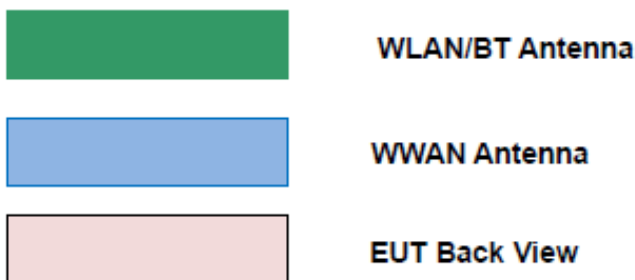
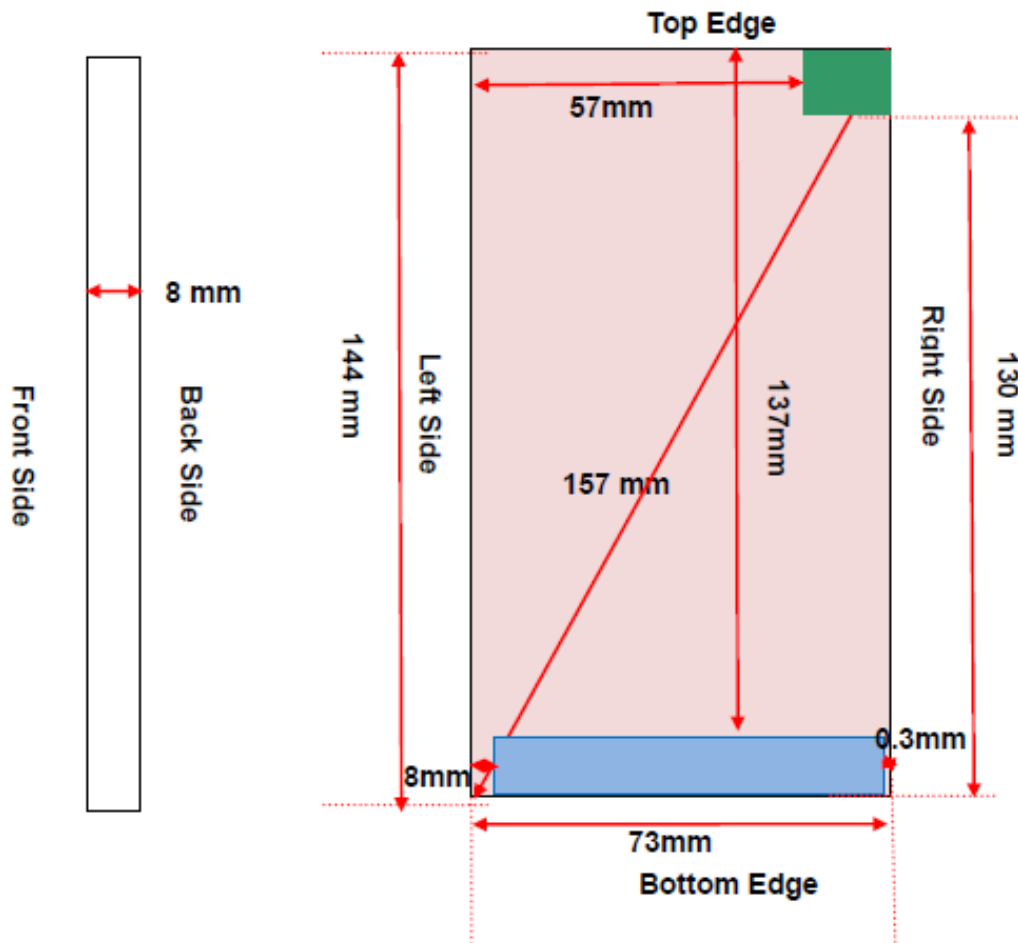

## 9.1 SAR Test Exclusion Consideration Table

According with FCC KDB 447498 D01, Appendix A, <SAR Test Exclusion Thresholds for 100 MHz – 6 GHz and  $\leq 50$  mm> Table, this Device SAR test configurations consider as following :

Band	Mode	Max. Peak Power		Test Position Configurations					
		dBm	mW	Head	Front/ Back	Left Edge	Right Edge	Top Edge	Bottom Edge
GSM 850	Distance to User			<5mm	<5mm	8mm	<5mm	137mm	<5mm
	Data	31.5	1412.54	Yes	Yes	Yes	Yes	No	Yes
GSM 1900	Distance to User			<5mm	<5mm	8mm	<5mm	137mm	<5mm
	Data	26.0	398.11	Yes	Yes	Yes	Yes	No	Yes
WCDMA Band 2	Distance to User			<5mm	<5mm	8mm	<5mm	137mm	<5mm
	RMC	23.5	223.87	Yes	Yes	Yes	Yes	No	Yes
WCDMA Band 4	Distance to User			<5mm	<5mm	8mm	<5mm	137mm	<5mm
	RMC	24.5	281.84	Yes	Yes	Yes	Yes	No	Yes
WCDMA Band 5	Distance to User			<5mm	<5mm	8mm	<5mm	137mm	<5mm
	RMC	23.0	199.53	Yes	Yes	Yes	Yes	No	Yes
LTE Band 2	Distance to User			<5mm	<5mm	8mm	<5mm	137mm	<5mm
	QPSK	24.0	251.19	Yes	Yes	Yes	Yes	No	Yes
LTE Band 4	Distance to User			<5mm	<5mm	8mm	<5mm	137mm	<5mm
	QPSK	24.0	251.19	Yes	Yes	Yes	Yes	No	Yes
LTE Band 5	Distance to User			<5mm	<5mm	8mm	<5mm	137mm	<5mm
	QPSK	23.5	223.87	Yes	Yes	Yes	Yes	No	Yes
LTE Band 7	Distance to User			<5mm	<5mm	8mm	<5mm	137mm	<5mm
	QPSK	24.0	251.19	Yes	Yes	Yes	Yes	No	Yes
LTE Band 12	Distance to User			<5mm	<5mm	8mm	<5mm	137mm	<5mm
	QPSK	24.0	251.19	Yes	Yes	Yes	Yes	No	Yes
WLAN 2.4 G	Distance to User			<5mm	<5mm	57mm	<5mm	<5mm	130mm
	802.11b	12.0	15.85	Yes	Yes	No	Yes	Yes	No
	802.11g	10.0	10.00	No	No	No	No	No	No
	802.11n(HT20)	10.0	10.00	No	No	No	No	No	No
Bluetooth	Distance to User			<5mm	<5mm	57mm	<5mm	<5mm	130mm
	BT	0.0	0.00	No	No	No	No	No	No

### Note:

- Maximum power is the source-based time-average power and represents the maximum RF output power including tune-up tolerance among production units
- Per KDB 447498 D01, for larger devices, the test separation distance of adjacent edge configuration is determined by the closest separation between the antenna and the user.
- Per KDB 447498 D01, standalone SAR test exclusion threshold is applied; If the distance of the antenna to the user is < 5mm, 5mm is used to determine SAR exclusion threshold
- Per KDB 447498 D01, the 1-g and 10-g SAR test exclusion thresholds for 100 MHz to 6 GHz at test separation distances

≤ 50 mm are determined by:

$$\left[ \frac{\text{max. power of channel, including tune-up tolerance, mW}}{\text{min. test separation distance, mm}} \right] \cdot \sqrt{f(\text{GHz})} \leq 3.0$$
 for 1-g SAR and ≤ 7.5 for 10-g extremity SAR

- a.  $f(\text{GHz})$  is the RF channel transmit frequency in GHz
- b. Power and distance are rounded to the nearest mW and mm before calculation
- c. The result is rounded to one decimal place for comparison
- d. For < 50 mm distance, we just calculate mW of the exclusion threshold value (3.0) to do compare.

This formula is  $3.0 / \sqrt{f(\text{GHz})} \cdot \text{min. test separation distance, mm} = \text{exclusion threshold of mW}$ .

5. Per KDB 447498 D01, at 100 MHz to 6 GHz and for test separation distances > 50 mm, the SAR test exclusion threshold is determined according to the following
  - a. [Threshold at 50 mm in step 1) + (test separation distance - 50 mm) · ( f(MHz)/150)] mW, at 100 MHz to 1500 MHz
  - b. [Threshold at 50 mm in step 1) + (test separation distance - 50 mm) · 10] mW at > 1500 MHz and ≤ 6 GHz
6. Per KDB 941225 D01, RMC 12.2kbps setting is used to evaluate SAR. If HSDPA /HSUPA /DC-HSDPA output power is < 0.25dB higher than RMC12.2Kbps, or reported SAR with RMC 12.2kbps setting is ≤ 1.2W/kg, HSDPA/HSUPA/DC-HSDPA SAR evaluation can be excluded.
7. Per KDB 248227 D01 SAR is not required for the following 2.4 GHz OFDM conditions.
  - a. When KDB Publication 447498 D01 SAR test exclusion applies to the OFDM configuration.
  - b. When the highest reported SAR for DSSS is adjusted by the ratio of OFDM to DSSS specified maximum output power and the adjusted SAR is ≤ 1.2 W/kg.

## 9.2 10g Extremity Exposure Consideration

According with FCC KDB 648474 D04, for smart phones with a display diagonal dimension > 15.0 cm or an overall diagonal dimension > 16.0 cm that provide similar mobile web access and multimedia support found in mini-tablets or UMPC mini-tablets that support voice calls next to the ear, unless it is confirmed otherwise through KDB inquiries, the following phablet procedures should be applied to evaluate SAR compliance for each applicable wireless modes and frequency band. Devices marketed as phablets, regardless of form factors and operating characteristics must be tested as a phablet to determine SAR compliance;

The UMPC mini-tablet procedures must also be applied to test the SAR of all surfaces and edges with an antenna located at  $\leq 25$  mm from that surface or edge, in direct contact with a flat phantom, for 10-g extremity SAR according to the body-equivalent tissue dielectric parameters in KDB 865664 to address interactive hand use exposure conditions. The UMPC mini-tablet 1-g SAR at 5 mm is not required. When hotspot mode applies, 10-g extremity SAR is required only for the surfaces and edges with hotspot mode 1-g reported SAR > 1.2 W/kg.

### Conclusion:

The EUT hotspot mode 1-g reported SAR is 1.169 W/kg, which is less than 1.2 W/kg, 10 g extremity SAR is not required.

# 10 TEST RESULT

## 10.1 GSM 850

Mode	Position	Dist. (mm)	Ch.	Freq. (MHz)	Power Drift (%)	1g Meas SAR (W/kg)	Meas. Power (dBm)	Max. tune-up power (dBm)	Scaling Factor	1g Scaled SAR (W/kg)	Meas. No.
<b>Head</b>											
GPRS (2slots)	Left Cheek	0	190	836.6	0.77	0.356	31.28	31.50	1.052	0.374	/
	Left Tilt	0	190	836.6	-2.95	0.177	31.28	31.50	1.052	0.186	/
	Right Cheek	0	190	836.6	0.55	0.464	31.28	31.50	1.052	<b>0.488</b>	1#
	Right Tilt	0	190	836.6	-1.64	0.197	31.28	31.50	1.052	0.207	/
<b>Body-worn Accessory &amp; Hotspot</b>											
GPRS (2slots)	Front Side	10	190	836.6	-2.94	0.414	31.28	31.50	1.052	0.436	/
	Back Side	10	190	836.6	0.85	0.670	31.28	31.50	1.052	<b>0.705</b>	2#
	Left Edge	10	190	836.6	-2.41	0.449	31.28	31.50	1.052	0.472	/
	Right Edge	10	190	836.6	2.84	0.148	31.28	31.50	1.052	0.156	/
	Bottom Edge	10	190	836.6	-0.23	0.145	31.28	31.50	1.052	0.153	/

Note: Refer to ANNEX C for the detailed test data for each test configuration.

## 10.2 GSM 1900

Mode	Position	Dist. (mm)	Ch.	Freq. (MHz)	Power Drift (%)	1g Meas SAR (W/kg)	Meas. Power (dBm)	Max. tune-up power (dBm)	Scaling Factor	1g Scaled SAR (W/kg)	Meas. No.
<b>Head</b>											
GPRS (4slots)	Left Cheek	0	512	1850.2	-0.32	0.421	25.50	26.00	1.122	<b>0.472</b>	3#
	Left Tilt	0	512	1850.2	-0.24	0.142	25.50	26.00	1.122	0.159	/
	Right Cheek	0	512	1850.2	0.36	0.231	25.50	26.00	1.122	0.259	/
	Right Tilt	0	512	1850.2	-0.01	0.110	25.50	26.00	1.122	0.123	/
<b>Body-worn Accessory &amp; Hotspot</b>											
GPRS (4slots)	Front Side	10	512	1850.2	0.36	0.879	25.50	26.00	1.122	<b>0.986</b>	4#
		10	661	1880.0	-2.20	0.830	25.43	26.00	1.140	0.946	/
		10	810	1908.8	2.95	0.746	25.45	26.00	1.135	0.847	/
	Back Side	10	512	1850.2	-1.64	0.439	25.50	26.00	1.122	0.493	/
	Left Edge	10	512	1850.2	0.15	0.183	25.50	26.00	1.122	0.205	/
	Right Edge	10	512	1850.2	-1.21	0.385	25.50	26.00	1.122	0.432	/
	Bottom Edge	10	512	1850.2	-0.77	0.308	25.50	26.00	1.122	0.346	/

Note: Refer to ANNEX C for the detailed test data for each test configuration.

## 10.3WCDMA Band 2

Mode	Position	Dist. (mm)	Ch.	Freq. (MHz)	Power Drift (%)	1g Meas SAR (W/kg)	Meas. Power (dBm)	Max. tune-up power (dBm)	Scaling Factor	1g Scaled SAR (W/kg)	Meas. No.
<b>Head</b>											
RMC	Left Cheek	0	9538	1907.6	-1.33	0.529	23.47	23.50	1.007	<b>0.533</b>	5#
	Left Tilt	0	9538	1907.6	-0.69	0.187	23.47	23.50	1.007	0.188	/
	Right Cheek	0	9538	1907.6	3.66	0.287	23.47	23.50	1.007	0.289	/
	Right Tilt	0	9538	1907.6	-1.75	0.162	23.47	23.50	1.007	0.163	/
<b>Body-worn Accessory &amp; Hotspot</b>											
RMC	Front Side	10	9538	1907.6	-0.57	0.968	23.47	23.50	1.007	0.975	/
		10	9262	1852.4	-0.67	1.063	23.15	23.50	1.084	<b>1.152</b>	6#
		10	9400	1880.0	-0.22	0.974	23.39	23.50	1.026	0.999	/
	Back Side	10	9538	1907.6	-0.19	0.581	23.47	23.50	1.007	0.585	/
	Left Edge	10	9538	1907.6	-1.38	0.170	23.47	23.50	1.007	0.171	/
	Right Edge	10	9538	1907.6	-0.95	0.462	23.47	23.50	1.007	0.465	/
	Bottom Edge	10	9538	1907.6	0.11	0.396	23.47	23.50	1.007	0.399	/
Note: Refer to ANNEX C for the detailed test data for each test configuration.											

## 10.4WCDMA Band 4

Mode	Position	Dist. (mm)	Ch.	Freq. (MHz)	Power Drift (%)	1g Meas SAR (W/kg)	Meas. Power (dBm)	Max. tune-up power (dBm)	Scaling Factor	1g Scaled SAR (W/kg)	Meas. No.
<b>Head</b>											
RMC	Left Cheek	0	1513	1752.6	-3.64	0.686	24.39	24.50	1.026	<b>0.704</b>	7#
	Left Tilt	0	1513	1752.6	-0.70	0.331	24.39	24.50	1.026	0.339	/
	Right Cheek	0	1513	1752.6	-0.45	0.311	24.39	24.50	1.026	0.319	/
	Right Tilt	0	1513	1752.6	-2.13	0.285	24.39	24.50	1.026	0.292	/
<b>Body-worn Accessory &amp; Hotspot</b>											
RMC	Front Side	10	1513	1752.6	-0.91	1.037	24.39	24.50	1.026	1.064	/
		10	1312	1712.4	-0.67	0.901	23.96	24.50	1.132	1.020	/
		10	1412	1732.4	-0.94	1.085	24.23	24.50	1.064	<b>1.155</b>	8#
	Back Side	10	1513	1752.6	-1.28	0.815	24.39	24.50	1.026	0.836	/
		10	1312	1712.4	-1.21	0.721	23.96	24.50	1.132	0.816	/
		10	1412	1732.4	0.37	0.832	24.23	24.50	1.064	0.885	/
	Left Edge	10	1513	1752.6	-0.81	0.328	24.39	24.50	1.026	0.336	/
	Right Edge	10	1513	1752.6	-0.66	0.589	24.39	24.50	1.026	0.604	/
Bottom Edge	10	1513	1752.6	-0.43	0.501	24.39	24.50	1.026	0.514	/	
Note: Refer to ANNEX C for the detailed test data for each test configuration.											

## 10.5WCDMA Band 5

Mode	Position	Dist. (mm)	Ch.	Freq. (MHz)	Power Drift (%)	1g Meas SAR (W/kg)	Meas. Power (dBm)	Max. tune-up power (dBm)	Scaling Factor	1g Scaled SAR (W/kg)	Meas. No.
<b>Head</b>											
RMC	Left Cheek	0	4233	846.6	-0.79	0.173	22.76	23.00	1.057	0.183	/
	Left Tilt	0	4233	846.6	-1.24	0.079	22.76	23.00	1.057	0.083	/
	Right Cheek	0	4233	846.6	1.36	0.245	22.76	23.00	1.057	<b>0.259</b>	9#
	Right Tilt	0	4233	846.6	-0.67	0.093	22.76	23.00	1.057	0.098	/
<b>Body-worn Accessory &amp; Hotspot</b>											
RMC	Front Side	10	4233	846.6	0.60	0.280	22.76	23.00	1.057	0.296	/
	Back Side	10	4233	846.6	-0.83	0.331	22.76	23.00	1.057	<b>0.350</b>	10#
	Left Edge	10	4233	846.6	-1.74	0.233	22.76	23.00	1.057	0.246	/
	Right Edge	10	4233	846.6	-1.18	0.047	22.76	23.00	1.057	0.050	/
	Bottom Edge	10	4233	846.6	-0.79	0.098	22.76	23.00	1.057	0.104	/
Note: Refer to ANNEX C for the detailed test data for each test configuration.											



### 10.6LTE Band 2 (20MHz Bandwidth)

Mode	Position	Dist. (mm)	Ch.	Freq. (MHz)	RB Num.	RB Start	Power Drift (%)	1g Meas SAR (W/kg)	Meas. Power (dBm)	Max. tune-up power (dBm)	Scaling Factor	1g Scaled SAR (W/kg)	Meas. No.	
<b>Head</b>														
QPSK	Left Cheek	0	18700	1860	1	MID	3.40	0.525	23.79	24.00	1.050	<b>0.551</b>	11#	
		0	19100	1900	50	MID	-1.89	0.447	22.83	23.00	1.040	0.465	/	
	Left Tilt	0	18700	1860	1	MID	-1.62	0.182	23.79	24.00	1.050	0.191	/	
		0	19100	1900	50	MID	-2.00	0.156	22.83	23.00	1.040	0.162	/	
	Right Cheek	0	18700	1860	1	MID	-0.30	0.252	23.79	24.00	1.050	0.264	/	
		0	19100	1900	50	MID	-0.68	0.210	22.83	23.00	1.040	0.218	/	
	Right Tilt	0	18700	1860	1	MID	-1.41	0.158	23.79	24.00	1.050	0.166	/	
		0	19100	1900	50	MID	0.03	0.137	22.83	23.00	1.040	0.142	/	
<b>Body-worn Accessory &amp; Hotspot</b>														
QPSK	Front Side	10	18700	1860	1	MID	-0.19	1.037	23.79	24.00	1.050	<b>1.088</b>	12#	
		10	18900	1880	1	MID	-0.06	0.964	23.75	24.00	1.059	1.021	/	
		10	19100	1900	1	MID	-0.64	0.924	23.74	24.00	1.062	0.981	/	
		10	19100	1900	50	MID	-1.04	0.820	22.83	23.00	1.040	0.853	/	
		10	18700	1860	50	MID	-1.40	0.873	22.71	23.00	1.069	0.933	/	
		10	18900	1880	50	LOW	-0.51	0.825	22.79	23.00	1.050	0.866	/	
		10	19100	1900	100	LOW	-0.36	0.865	22.78	23.00	1.052	0.910	/	
	Back Side	10	18700	1860	1	MID	-0.58	0.592	23.79	24.00	1.050	0.621	/	
		10	19100	1900	50	MID	-0.72	0.513	22.83	23.00	1.040	0.533	/	
	Left Edge	10	18700	1860	1	MID	-0.74	0.220	23.79	24.00	1.050	0.231	/	
		10	19100	1900	50	MID	-1.47	0.150	22.83	23.00	1.040	0.156	/	
	Right Edge	10	18700	1860	1	MID	-0.33	0.413	23.79	24.00	1.050	0.433	/	
		10	19100	1900	50	MID	-1.80	0.319	22.83	23.00	1.040	0.332	/	
	Bottom Edge	10	18700	1860	1	MID	0.31	0.367	23.79	24.00	1.050	0.385	/	
		10	19100	1900	50	MID	0.07	0.276	22.83	23.00	1.040	0.287	/	
	Note: Refer to ANNEX C for the detailed test data for each test configuration.													

### 10.7LTE Band 4 (20MHz Bandwidth)

Mode	Position	Dist. (mm)	Ch.	Freq. (MHz)	RB Num.	RB Start	Power Drift (%)	1g Meas SAR (W/kg)	Meas. Power (dBm)	Max. tune-up power (dBm)	Scaling Factor	1g Scaled SAR (W/kg)	Meas. No.	
<b>Head</b>														
QPSK	Left Cheek	0	20175	1732.5	1	MID	-0.41	0.543	23.81	24.00	1.045	<b>0.567</b>	13#	
		0	20175	1732.5	50	MID	-2.28	0.403	22.61	23.00	1.094	0.441	/	
	Left Tilt	0	20175	1732.5	1	MID	-2.37	0.274	23.81	24.00	1.045	0.286	/	
		0	20175	1732.5	50	MID	0.80	0.233	22.61	23.00	1.094	0.255	/	
	Right Cheek	0	20175	1732.5	1	MID	-2.62	0.259	23.81	24.00	1.045	0.271	/	
		0	20175	1732.5	50	MID	-0.22	0.185	22.61	23.00	1.094	0.202	/	
	Right Tilt	0	20175	1732.5	1	MID	-1.09	0.289	23.81	24.00	1.045	0.302	/	
		0	20175	1732.5	50	MID	0.11	0.213	22.61	23.00	1.094	0.233	/	
<b>Body-worn Accessory &amp; Hotspot</b>														
QPSK	Front Side	10	20175	1732.5	1	MID	-0.42	0.838	23.81	24.00	1.045	0.875	/	
		10	20050	1720	1	MID	-0.47	0.873	23.62	24.00	1.091	0.953	/	
		10	20300	1745	1	MID	-0.73	1.030	23.53	24.00	1.114	<b>1.148</b>	14#	
		10	20175	1732.5	50	MID	0.28	0.774	22.61	23.00	1.094	0.847	/	
		10	20050	1720	50	MID	0.67	0.696	22.49	23.00	1.125	0.783	/	
		10	20300	1745	50	MID	0.22	1.010	22.49	23.00	1.125	1.136	/	
		10	20175	1732.5	100	LOW	-0.04	0.762	22.54	23.00	1.112	0.847	/	
	Back Side	10	20175	1732.5	1	MID	-0.48	0.717	23.81	24.00	1.045	0.749	/	
		10	20175	1732.5	50	MID	-0.56	0.576	22.61	23.00	1.094	0.630	/	
	Left Edge	10	20175	1732.5	1	MID	-0.16	0.273	23.81	24.00	1.045	0.285	/	
		10	20175	1732.5	50	MID	-0.52	0.214	22.61	23.00	1.094	0.234	/	
	Right Edge	10	20175	1732.5	1	MID	-0.35	0.562	23.81	24.00	1.045	0.587	/	
		10	20175	1732.5	50	MID	-1.06	0.439	22.61	23.00	1.094	0.480	/	
	Bottom Edge	10	20175	1732.5	1	MID	0.30	0.437	23.81	24.00	1.045	0.457	/	
		10	20175	1732.5	50	MID	-0.28	0.338	22.61	23.00	1.094	0.370	/	
	Note: Refer to ANNEX C for the detailed test data for each test configuration.													

## 10.8LTE Band 5 (10MHz Bandwidth)

Mode	Position	Dist. (mm)	Ch.	Freq. (MHz)	RB Num.	RB Start	Power Drift (%)	1g Meas SAR (W/kg)	Meas. Power (dBm)	Max. tune-up power (dBm)	Scaling Factor	1g Scaled SAR (W/kg)	Meas. No.
<b>Head</b>													
QPSK	Left Cheek	0	20600	844	1	MID	-1.36	0.277	23.44	23.50	1.014	0.281	/
		0	20600	844	25	MID	-0.92	0.238	22.43	23.00	1.140	0.271	/
	Left Tilt	0	20600	844	1	MID	-1.03	0.134	23.44	23.50	1.014	0.136	/
		0	20600	844	25	MID	-0.71	0.117	22.43	23.00	1.140	0.133	/
	Right Cheek	0	20600	844	1	MID	-0.96	0.381	23.44	23.50	1.014	<b>0.386</b>	15#
		0	20600	844	25	MID	-0.48	0.321	22.43	23.00	1.140	0.366	/
	Right Tilt	0	20600	844	1	MID	-0.43	0.167	23.44	23.50	1.014	0.169	/
		0	20600	844	25	MID	-0.43	0.138	22.43	23.00	1.140	0.157	/
<b>Body-worn Accessory &amp; Hotspot</b>													
QPSK	Front Side	10	20600	844	1	MID	-2.79	0.323	23.44	23.50	1.014	0.327	/
		10	20600	844	25	MID	-0.40	0.285	22.43	23.00	1.140	0.325	/
	Back Side	10	20600	844	1	MID	-0.20	0.416	23.44	23.50	1.014	<b>0.422</b>	16#
		10	20600	844	25	MID	-0.84	0.365	22.43	23.00	1.140	0.416	/
	Left Edge	10	20600	844	1	MID	-0.36	0.226	23.44	23.50	1.014	0.229	/
		10	20600	844	25	MID	-3.31	0.264	22.43	23.00	1.140	0.301	/
	Right Edge	10	20600	844	1	MID	-2.22	0.088	23.44	23.50	1.014	0.089	/
		10	20600	844	25	MID	-1.21	0.077	22.43	23.00	1.140	0.088	/
	Bottom Edge	10	20600	844	1	MID	-1.28	0.118	23.44	23.50	1.014	0.120	/
		10	20600	844	25	MID	-1.28	0.104	22.43	23.00	1.140	0.119	/
Note: Refer to ANNEX C for the detailed test data for each test configuration.													

### 10.9LTE Band 7 (20MHz Bandwidth)

Mode	Position	Dist. (mm)	Ch.	Freq. (MHz)	RB Num.	RB Start	Power Drift (%)	1g Meas SAR (W/kg)	Meas. Power (dBm)	Max. tune-up power (dBm)	Scaling Factor	1g Scaled SAR (W/kg)	Meas. No.
<b>Head</b>													
QPSK	Left Cheek	0	20850	2510	1	HIGH	-1.07	0.122	23.55	24.00	1.109	<b>0.135</b>	17#
		0	20850	2510	50	HIGH	3.17	0.113	23.31	23.50	1.045	0.118	/
	Left Tilt	0	20850	2510	1	HIGH	1.56	0.065	23.55	24.00	1.109	0.072	/
		0	20850	2510	50	HIGH	1.85	0.058	23.31	23.50	1.045	0.061	/
	Right Cheek	0	20850	2510	1	HIGH	-3.95	0.060	23.55	24.00	1.109	0.067	/
		0	20850	2510	50	HIGH	-0.65	0.055	23.31	23.50	1.045	0.057	/
	Right Tilt	0	20850	2510	1	HIGH	-0.85	0.051	23.55	24.00	1.109	0.057	/
		0	20850	2510	50	HIGH	-3.24	0.048	23.31	23.50	1.045	0.050	/
<b>Body-worn Accessory &amp; Hotspot</b>													
QPSK	Front Side	10	20850	2510	1	HIGH	-0.60	0.275	23.55	24.00	1.109	0.305	/
		10	20850	2510	50	HIGH	0.85	0.253	23.31	23.50	1.045	0.264	/
	Back Side	10	20850	2510	1	HIGH	0.28	0.892	23.55	24.00	1.109	0.989	/
		10	21100	2535	1	LOW	-3.58	0.745	22.94	24.00	1.276	0.951	/
		10	21350	2560	1	MID	-2.47	0.818	23.22	24.00	1.197	0.979	/
		10	20850	2510	50	HIGH	-1.11	0.838	23.31	23.50	1.045	0.875	/
		10	21100	2535	50	LOW	0.08	0.715	22.49	23.50	1.262	0.902	/
		10	21350	2560	50	LOW	0.69	0.732	23.18	23.50	1.076	0.788	/
		10	21350	2560	100	LOW	-0.81	0.715	23.00	23.50	1.122	0.802	/
	Left Edge	10	20850	2510	1	HIGH	-2.36	0.260	23.55	24.00	1.109	0.288	/
		10	20850	2510	50	HIGH	4.18	0.243	23.31	23.50	1.045	0.254	/
	Right Edge	10	20850	2510	1	HIGH	2.65	0.432	23.55	24.00	1.109	0.479	/
		10	20850	2510	50	HIGH	-3.19	0.395	23.31	23.50	1.045	0.413	/
	Bottom Edge	10	20850	2510	1	HIGH	1.44	1.054	23.55	24.00	1.109	<b>1.169</b>	18#
		10	21100	2535	1	LOW	-0.89	0.784	22.94	24.00	1.276	1.001	/
		10	21350	2560	1	MID	-3.87	0.763	23.22	24.00	1.197	0.913	/
		10	20850	2510	50	HIGH	-1.97	0.969	23.31	23.50	1.045	1.012	/
		10	21100	2535	50	LOW	-0.47	0.641	22.49	23.50	1.262	0.809	/
		10	21350	2560	50	LOW	-2.23	0.802	23.18	23.50	1.076	0.863	/
	10	21350	2560	100	LOW	-1.26	0.791	23.00	23.50	1.122	0.888	/	
Note: Refer to ANNEX C for the detailed test data for each test configuration.													

## 10.10 LTE Band 12 (10MHz Bandwidth)

Mode	Position	Dist. (mm)	Ch.	Freq. (MHz)	RB Num.	RB Start	Power Drift (%)	1g Meas SAR (W/kg)	Meas. Power (dBm)	Max. tune-up power (dBm)	Scaling Factor	1g Scaled SAR (W/kg)	Meas. No.	
<b>Head</b>														
QPSK	Left Cheek	0	23130	711	1	MID	-0.80	0.291	23.55	24.00	1.109	0.323	/	
		0	23060	704	25	HIGH	-0.39	0.241	22.52	23.00	1.117	0.269	/	
	Left Tilt	0	23130	711	1	MID	-0.96	0.156	23.55	24.00	1.109	0.173	/	
		0	23060	704	25	HIGH	0.56	0.122	22.52	23.00	1.117	0.136	/	
	Right Cheek	0	23130	711	1	MID	-0.26	0.300	23.55	24.00	1.109	<b>0.333</b>	19#	
		0	23060	704	25	HIGH	-0.04	0.273	22.52	23.00	1.117	0.305	/	
	Right Tilt	0	23130	711	1	MID	-0.87	0.158	23.55	24.00	1.109	0.175	/	
		0	23060	704	25	HIGH	-1.69	0.120	22.52	23.00	1.117	0.134	/	
<b>Body-worn Accessory &amp; Hotspot</b>														
QPSK	Front Side	10	23130	711	1	MID	-1.97	0.372	23.55	24.00	1.109	0.413	/	
		10	23060	704	25	HIGH	0.02	0.307	22.52	23.00	1.117	0.343	/	
	Back Side	10	23130	711	1	MID	-0.40	0.561	23.55	24.00	1.109	<b>0.622</b>	20#	
		10	23060	704	25	HIGH	-0.20	0.425	22.52	23.00	1.117	0.475	/	
	Left Edge	10	23130	711	1	MID	-0.22	0.354	23.55	24.00	1.109	0.393	/	
		10	23060	704	25	HIGH	-0.28	0.300	22.52	23.00	1.117	0.335	/	
	Right Edge	10	23130	711	1	MID	-0.33	0.336	23.55	24.00	1.109	0.373	/	
		10	23060	704	25	HIGH	-0.07	0.286	22.52	23.00	1.117	0.319	/	
	Bottom Edge	10	23130	711	1	MID	-0.38	0.061	23.55	24.00	1.109	0.068	/	
		10	23060	704	25	HIGH	0.03	0.052	22.52	23.00	1.117	0.058	/	
	Note: Refer to ANNEX C for the detailed test data for each test configuration.													

## 10.11 WIFI 2.4GHZ

Mode	Position	Dist. (mm)	Ch.	Freq. (MHz)	Power Drift (%)	1g Meas SAR (W/kg)	Meas. Power (dBm)	Max. tune-up power (dBm)	Scaling Factor	Duty cycle (%)	Duty Factor	1g Scaled SAR (W/kg)	Meas. No.
<b>Head</b>													
802.11b	Left Cheek	0	1	2412	-1.49	0.170	11.70	12.00	1.072	99.17	1.008	0.184	/
	Left Tilt	0	1	2412	-0.05	0.082	11.70	12.00	1.072	99.17	1.008	0.089	/
	Right Cheek	0	1	2412	0.18	0.393	11.70	12.00	1.072	99.17	1.008	<b>0.425</b>	21#
	Right Tilt	0	1	2412	-0.91	0.224	11.70	12.00	1.072	99.17	1.008	0.242	/
<b>Body-worn Accessory &amp; Hotspot</b>													
802.11b	Front Side	10	1	2412	-0.20	0.061	11.70	12.00	1.072	99.17	1.008	0.066	/
	Back Side	10	1	2412	-4.00	0.154	11.70	12.00	1.072	99.17	1.008	<b>0.166</b>	22#
	Right Edge	10	1	2412	-4.98	0.118	11.70	12.00	1.072	99.17	1.008	0.127	/
	Top Edge	10	1	2412	2.31	0.032	11.70	12.00	1.072	99.17	1.008	0.035	/

Note: Refer to ANNEX C for the detailed test data for each test configuration.

## 10.12 Worst Case of WCDMA Band 4

Mode	Position	Dist. (mm)	Ch.	Freq. (MHz)	Power Drift (%)	1 g Meas SAR (W/kg)	Meas. Power (dBm)	Max. tune-up power (dBm)	Scaling Factor	1g Scaled SAR (W/kg)	Meas. No.
<b>Head-Worst Case</b>											
RMC	Left Cheek	0	1513	1752.6	-4.87	0.527	24.39	24.50	1.026	0.541	1#
<b>Body-worn Accessory &amp; Hotspot-Worst Case</b>											
RMC	Front Side	10	1412	1732.4	-1.71	0.762	24.23	24.50	1.064	0.811	2#

Note: Refer to ANNEX C for the detailed test data for each test configuration.

## 10.13 Worst Case of LTE Band 7

Mode	Position	Dist. (mm)	Ch.	Freq. (MHz)	RB Num.	RB Start	Power Drift (%)	1 g Meas SAR (W/kg)	Meas. Power (dBm)	Max. tune-up power (dBm)	Scaling Factor	1g Scaled SAR (W/kg)	Meas. No.
<b>Body-worn Accessory &amp; Hotspot-Worst Case</b>													
QPSK	Bottom Edge	10	20850	2510	1	HIGH	2.76	1.049	23.55	24.00	1.109	1.164	3#

Note: Refer to ANNEX C for the detailed test data for each test configuration.

## 11 SAR Measurement Variability

According to KDB 865664 D01, SAR measurement variability was assessed for each frequency band, which is determined by the SAR probe calibration point and tissue-equivalent medium used for the device measurements. When both head and body tissue-equivalent media are required for SAR measurements in a frequency band, the variability measurement procedures should be applied to the tissue medium with the highest measured SAR, using the highest measured SAR configuration for that tissue-equivalent medium. Alternatively, if the highest measured SAR for both head and body tissue-equivalent media are  $\leq 1.45$  W/kg and the ratio of these highest SAR values, i.e., largest divided by smallest value, is  $\leq 1.10$ , the highest SAR configuration for either head or body tissue-equivalent medium may be used to perform the repeated measurement. These additional measurements are repeated after the completion of all measurements requiring the same head or body tissue-equivalent medium in a frequency band. The test device should be returned to ambient conditions (normal room temperature) with the battery fully charged before it is re-mounted on the device holder for the repeated measurement(s) to minimize any unexpected variations in the repeated results.

SAR repeated measurement procedure:

1. When the highest measured SAR is  $< 0.80$  W/kg, repeated measurement is not required.
2. When the highest measured SAR is  $\geq 0.80$  W/kg, repeat that measurement once.
3. If the ratio of largest to smallest SAR for the original and first repeated measurements is  $> 1.20$ , or when the original or repeated measurement is  $\geq 1.45$  W/kg, perform a second repeated measurement.
4. If the ratio of largest to smallest SAR for the original, first and second repeated measurements is  $> 1.20$ , and the original, first or second repeated measurement is  $\geq 1.5$  W/kg, perform a third repeated measurement.

Frequency Band (MHz)	Wireless Band	RF Exposure Conditions	Test Position	Highest Measured SAR (W/kg)	Repeated SAR (Yes/No)	Highest Measured SAR (W/kg)	Largest to Smallest SAR Ratio
1850.2	GSM 1900	Body	Front Side	0.879	Yes	0.852	1.03
1852.4	WCDMA Band 2	Body	Front Side	1.063	Yes	1.051	1.01
1732.4	WCDMA Band 4	Body	Front Side	1.085	Yes	1.033	1.05
1860	LTE Band 2	Body	Front Side	1.037	Yes	1.009	1.03
1745	LTE Band 4	Body	Front Side	1.030	Yes	1.013	1.02
2510	LTE Band 7	Body	Bottom Edge	1.054	Yes	1.022	1.03

Note: The ratio of largest to smallest SAR for the original and first repeated measurements is  $< 1.20$ , the second repeated measurement is not required.

## 12 SIMULTANEOUS TRANSMISSION

Simultaneous transmission SAR test exclusion is determined for each operating configuration and exposure condition according to the reported standalone SAR of each applicable simultaneous transmitting antenna. When the sum of SAR 1g of all simultaneously transmitting antennas in an operating mode and exposure condition combination is within the SAR limit (SAR 1g 1.6 W/kg), the simultaneous transmission SAR is not required. When the sum of SAR 1g is greater than the SAR limit (SAR 1g 1.6 W/kg), SAR test exclusion is determined by the SAR to Peak Location Ratio (SPLSR).

### 12.1 Simultaneous Transmission Mode Consider

No.	Simultaneous Tx Combination	Head	Body-worn	Hotspot
1	GSM + Bluetooth	Yes	Yes	No
2	GSM + 2.4G WLAN	Yes	Yes	Yes
3	UMTS + Bluetooth	Yes	Yes	No
4	UMTS + 2.4G WLAN	Yes	Yes	Yes
5	LTE + Bluetooth	Yes	Yes	No
6	LTE + 2.4G WLAN	Yes	Yes	Yes

Note:

- 2G&3G&4G share the same antenna and can't transmit simultaneously.
- The Bluetooth and 2.4G WLAN share the same antenna, can't transmitting together.
- The maximum SAR summation is calculated based on the same configuration and test position.



## 12.2 Estimated SAR Calculation

According to KDB 447498 D01, when standalone SAR test exclusion applies to an antenna that transmits simultaneously with other antennas, the standalone SAR was estimated according to following formula to result in substantially conservative SAR values of  $\leq 0.4$  W/kg to determine simultaneous transmission SAR test exclusion.

$$\text{Estimated SAR} = \frac{\text{Max. Tune Up Power (mw)}}{\text{Min Test Separation Distance}} * \frac{\sqrt{f_{\text{GHz}}}}{x} \quad (\text{where } x = 7.5 \text{ for 1-g SAR})$$

If the minimum test separation distance is  $< 5$  mm, a distance of 5 mm is used for estimated SAR calculation. When the test separation distance is  $> 50$  mm, the 0.4 W/kg is used for SAR-1g.

Band	Mode	Position	Antenna To user (mm)	SAR Testing	Max. Tune-up Power (dBm)	Max. Tune-up Power (mW)	Frequency (GHz)	Calculation Distance/Gap (mm)	Estimated SAR (W/kg)
Bluetooth	GFSK	Right Cheek	5	NO	0.0	1.00	2.480	5	0.042
		Left Cheek	5	NO	0.0	1.00	2.480	5	0.042
		Front Side	10	NO	0.0	1.00	2.480	10	0.021
		Back Side	10	NO	0.0	1.00	2.480	10	0.021

## 12.3 Sum SAR of Simultaneous Transmission

### 12.3.1 Sum Head SAR of Simultaneous Transmission

Simultaneous Mode	Mode	Max. 1g SAR (W/kg)	1g Sum SAR (W/kg)	SPLSR (Yes/No)
GSM+ Bluetooth	GSM	0.488	0.530	No
	Bluetooth	0.042		
GSM+ 2.4G WLAN	GSM	0.488	0.913	No
	2.4G WLAN	0.425		
WCDMA RMC + Bluetooth	WCDMA RMC	0.704	0.746	No
	Bluetooth	0.042		
WCDMA RMC + 2.4G WLAN	WCDMA RMC	0.704	<b>1.129</b>	No
	2.4G WLAN	0.425		
LTE QPSK + Bluetooth	LTE QPSK	0.567	0.609	No
	Bluetooth	0.042		
LTE QPSK + 2.4G WLAN	LTE QPSK	0.567	0.992	No
	2.4G WLAN	0.425		

### 12.3.2 Sum Body-worn SAR of Simultaneous Transmission

Simultaneous Mode	Mode	Max. 1g SAR (W/kg)	1g Sum SAR (W/kg)	SPLSR (Yes/No)
GSM+ Bluetooth	GSM	0.986	1.007	No
	Bluetooth	0.021		
GSM+ 2.4G WLAN	GSM	0.986	1.152	No
	2.4G WLAN	0.166		
WCDMA RMC + Bluetooth	WCDMA RMC	1.155	1.176	No
	Bluetooth	0.021		
WCDMA RMC + 2.4G WLAN	WCDMA RMC	1.155	<b>1.321</b>	No
	2.4G WLAN	0.166		
LTE QPSK + Bluetooth	LTE QPSK	1.148	1.169	No
	Bluetooth	0.021		
LTE QPSK + 2.4G WLAN	LTE QPSK	1.148	1.314	No
	2.4G WLAN	0.166		

### 12.3.3 Sum Hotspot mode SAR of Simultaneous Transmission

Simultaneous Mode	Mode	Max. 1g SAR (W/kg)	1g Sum SAR (W/kg)	SPLSR (Yes/No)
GSM+ 2.4G WLAN	GSM	0.986	1.152	No
	2.4G WLAN	0.166		
WCDMA RMC + 2.4G WLAN	WCDMA RMC	1.155	1.321	No
	2.4G WLAN	0.166		
LTE QPSK + 2.4G WLAN	LTE QPSK	1.169	<b>1.335</b>	No

## 13 TEST EQUIPMENTS LIST

Description	Manufacturer	Model	Serial No./Version	Cal. Date	Cal. Due
Test Software	SATIMO	OpenSAR	V4_02_31	N/A	N/A
750MHz Dipole	SATIMO	SID 750	S/N 08/21 DIP0G750-446	2021/03/18	2024/03/17
835MHz Dipole	SATIMO	SID 835	S/N 08/21 DIP0G835-447	2021/03/18	2024/03/17
1800MHz Dipole	SATIMO	SID 1800	S/N 08/21 DIP1G800-449	2021/03/18	2024/03/17
1900MHz Dipole	SATIMO	SID 1900	S/N 08/21 DIP1G900-450	2021/03/18	2024/03/17
2450MHz Dipole	SATIMO	SID 2450	S/N 08/21 DIP2G450-452	2021/03/18	2024/03/17
2600MHz Dipole	SATIMO	SID 2600	S/N 08/21 DIP2G600-453	2021/03/18	2024/03/17
E-Field Probe	MVG	SSE2	S/N 34/15 EPGO 265	2021/03/01	2022/02/28
E-Field Probe	MVG	SSE2	SN 39/21 EPGO359	2021/11/02	2022/11/01
MultiMeter	Keithley	MultiMeter 2000	4024022	2021/06/04	2022/06/03
Signal Generator	R&S	SMB100A	182396	2021/12/20	2022/12/19
Power Meter	R&S	NRVD-B2	7250BJ-0112/2011	2021/09/08	2022/09/07
Power Sensor	R&S	NRV-Z4	100381	2021/09/08	2022/09/07
Power Sensor	R&S	NRV-Z2	100211	2021/09/08	2022/09/07
Wireless Communication Test Set	Anritsu	MT8820C	6201524635	2022/01/05	2023/01/04
Wireless Communication Test Set	R&S	CMW 500	104946	2021/06/02	2022/06/01
Network Analyzer	Agilent	E5071B	MY42404001	2021/04/01	2022/03/31
Thermometer	Elitech	RC-4HC	EF720B004820	2021/12/01	2022/11/30
Power Amplifier	SATIMO	6552B	22374	N/A	N/A
Dielectric Probe Kit	SATIMO	SCLMP	SN 25/13 OCPG56	N/A	N/A
Antenna	SATIMO	ANTA3	SN 17/13 ZNTA45	N/A	N/A
Phantom1	SATIMO	SAM	SN 11/17 SAM133	N/A	N/A
Phantom2	SATIMO	ELLI	SN 11/17 ELLI42	N/A	N/A
Attenuator	COM-MW	ZA-S1-31	1305003187	N/A	N/A
Directional coupler	AA-MCS	AAMCS-UDC	000272	N/A	N/A

Note: Per KDB 865664 Dipole SAR Validation Verification, BALUN LAB has adopted 3 years calibration intervals. On annual basis, every measurement dipole has been evaluated and is in compliance with the following criteria:

1. There is no physical damage on the dipole;
2. System validation with specific dipole is within 10% of calibrated value;
3. Return-loss is within 20% of calibrated measurement.
4. Impedance (real or imaginary parts) is within 5 Ohms of calibrated measurement.

## ANNEX A SIMULATING LIQUID VERIFICATION RESULT

The dielectric parameters of the liquids were verified prior to the SAR evaluation using an SCLMP Dielectric Probe Kit.

Date	Liquid Type	Fre. (MHz)	Temp. (°C)	Meas. Conductivity ( $\sigma$ ) (S/m)	Meas. Permittivity ( $\epsilon$ )	Target Conductivity ( $\sigma$ ) (S/m)	Target Permittivity ( $\epsilon$ )	Conductivity Tolerance (%)	Permittivity Tolerance (%)
2020.01.18	Head	750	21.3	0.90	42.17	0.89	41.90	1.12	0.64
2020.01.19	Head	835	21.6	0.88	41.98	0.90	41.50	-2.22	1.16
2020.01.20	Head	835	21.4	0.89	41.98	0.90	41.50	-1.11	1.16
2020.02.06	Head	1800	21.3	1.41	39.91	1.40	40.00	0.71	-0.23
2020.02.07	Head	1900	21.5	1.40	40.08	1.40	40.00	0.00	0.20
2020.02.08	Head	1900	21.6	1.41	39.81	1.40	40.00	0.71	-0.47
2020.01.21	Head	2450	21.3	1.79	39.43	1.80	39.20	-0.56	0.59
2020.01.22	Head	2600	21.2	1.98	38.69	1.96	39.01	1.02	-0.82
2022.02.24	Head	1800	22.3	1.42	38.56	1.40	40.00	1.43	-3.60
2022.02.24	Head	2600	21.3	1.98	38.55	1.96	39.01	1.02	-1.18

Note: The tolerance limit of Conductivity and Permittivity is  $\pm 5\%$ .

## ANNEX B SYSTEM CHECK RESULT

Comparing to the original SAR value provided by SATIMO, the validation data should be within its specification of 10%(for 1 g).

Date	Liquid Type	Freq. (MHz)	Power (mW)	Measured SAR (W/kg)	Normalized SAR (W/kg)	Dipole SAR (W/kg)	Tolerance (%)	Targeted SAR(W/kg)	Tolerance (%)
2020.01.18	Head	750	100	0.889	8.89	8.78	1.25	8.49	4.71
2020.01.19	Head	835	100	0.899	8.89	9.58	-7.20	9.56	-7.01
2020.01.20	Head	835	100	0.930	9.30	9.58	-2.92	9.56	-2.72
2020.02.06	Head	1800	100	4.142	41.42	38.76	6.86	38.40	7.86
2020.02.07	Head	1900	100	3.732	37.32	39.49	-5.50	39.70	-5.99
2020.02.08	Head	1900	100	3.820	38.20	39.49	-3.27	39.70	-3.78
2020.01.21	Head	2450	100	4.930	49.30	54.31	-9.22	52.40	-5.92
2020.01.22	Head	2600	100	5.640	56.40	56.32	0.14	55.30	1.99
2022.02.24	Head	1800	100	4.064	40.64	38.76	4.85	38.40	5.83
2022.02.24	Head	2600	100	5.395	53.95	56.32	-4.21	55.30	-2.44

Note: The tolerance limit of System validation  $\pm 10\%$ .

# ANNEX C System Performance Check Data(750 MHz)

Type: Phone measurement (Complete)  
 E-Field Probe: SN 34/15 SSE2 EPGO265  
 Area scan resolution: dx=8mm,dy=8mm  
 Zoom scan resolution: dx=8mm, dy=8mm, dz=5mm  
 Date of measurement: 2020.01.18  
 Measurement duration: 14 minutes 27 seconds

## Experimental conditions.

<b>Phantom File</b>	surf_sam_plan.txt
<b>Phantom</b>	Validation plane
<b>Band</b>	750MHz
<b>Signal</b>	CW
<b>Frequency (MHz)</b>	750MHz
<b>Relative permittivity (real part)</b>	42.172035
<b>Conductivity (S/m)</b>	0.896557
<b>Power drift (%)</b>	0.210000
<b>Ambient Temperature:</b>	22.6°C
<b>Liquid Temperature:</b>	21.3°C
<b>ConvF:</b>	1.89
<b>Crest factor:</b>	1:1

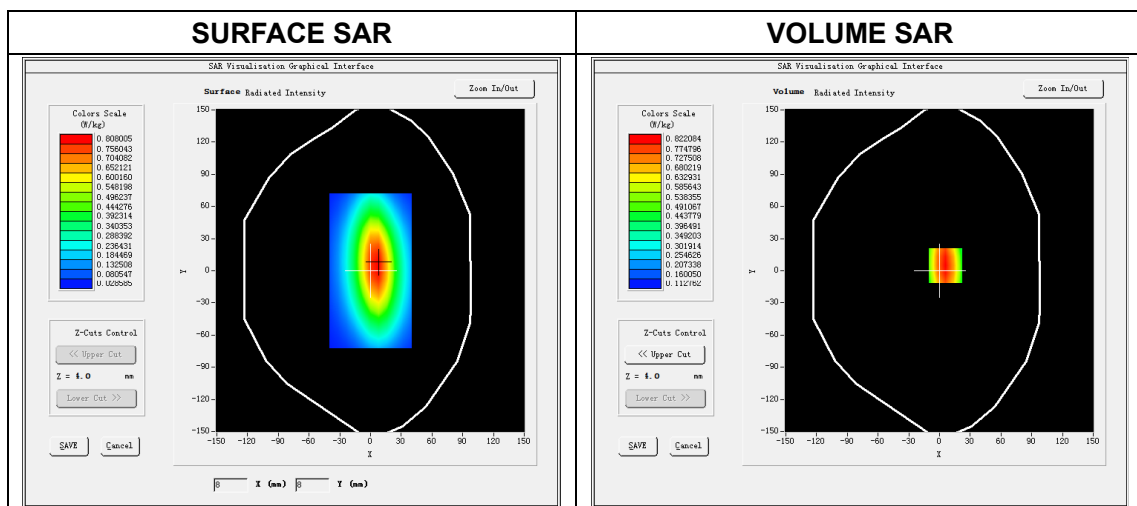

Maximum location: X=6.00, Y=5.00

SAR Peak: 1.10 W/kg

SAR 10g (W/Kg)	0.533304
SAR 1g (W/Kg)	0.889014

**Z Axis Scan**

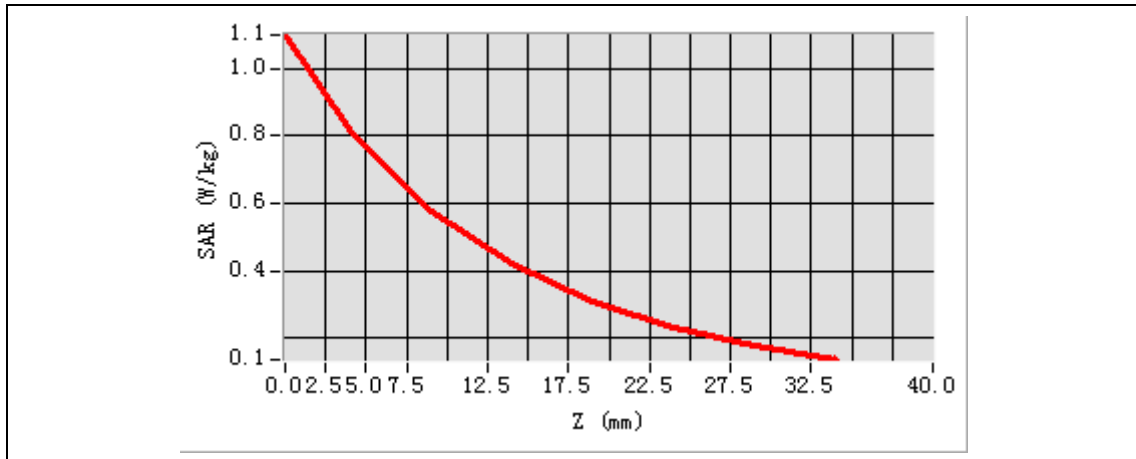

3D screen shot	Hot spot position

# System Performance Check Data(835 MHz)

Type: Phone measurement (Complete)  
 E-Field Probe: SN 34/15 SSE2 EPGO265  
 Area scan resolution: dx=8mm,dy=8mm  
 Zoom scan resolution: dx=8mm, dy=8mm, dz=5mm  
 Date of measurement: 2020.01.19  
 Measurement duration: 13 minutes 27 seconds

## Experimental conditions.

<b>Phantom File</b>	surf_sam_plan.txt
<b>Phantom</b>	Validation plane
<b>Band</b>	835MHz
<b>Signal</b>	CW
<b>Frequency (MHz)</b>	835.000000
<b>Relative permittivity (real part)</b>	41.982803
<b>Conductivity (S/m)</b>	0.876148
<b>Power drift (%)</b>	-0.010000
<b>Ambient Temperature:</b>	22.5°C
<b>Liquid Temperature:</b>	21.6°C
<b>ConvF:</b>	1.93
<b>Crest factor:</b>	1:1

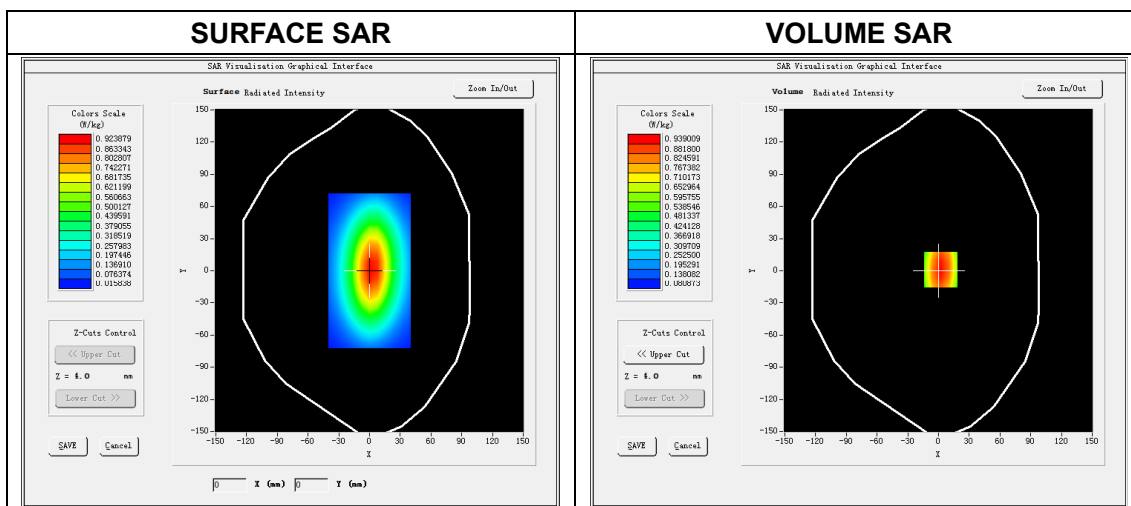



Maximum location: X=2.00, Y=1.00

SAR Peak: 1.31 W/kg

SAR 10 g (W/Kg)	0.577475
SAR 1g (W/Kg)	0.899412

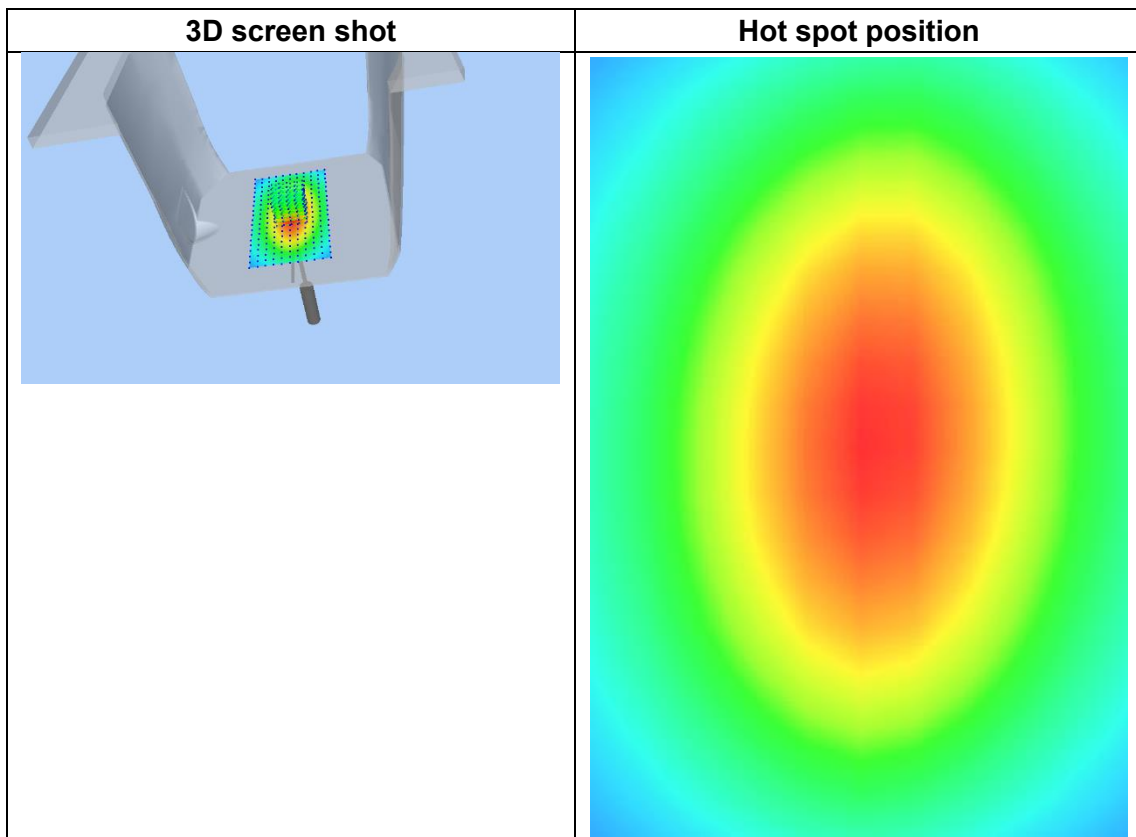
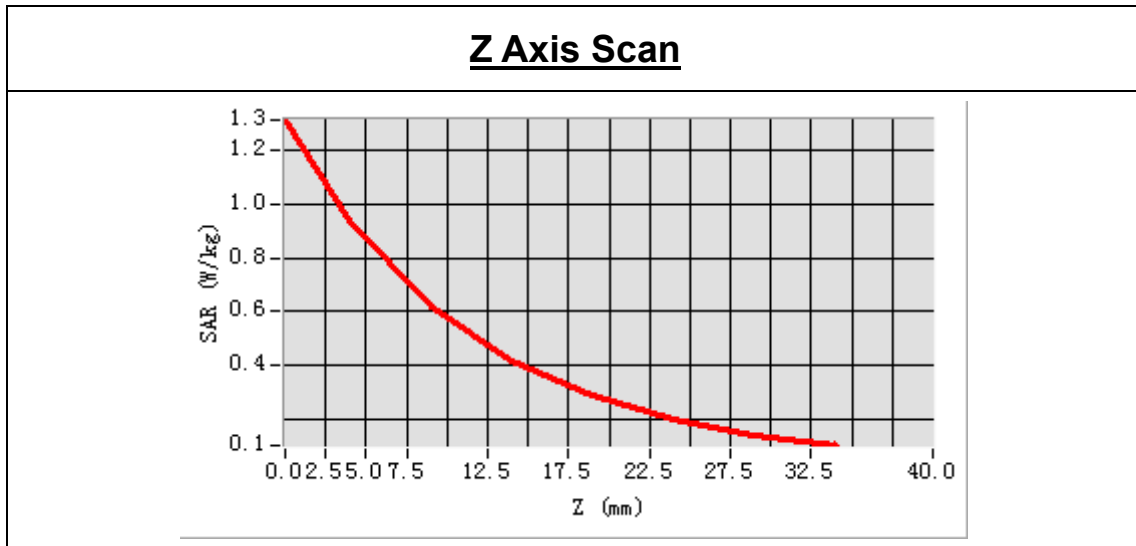

# System Performance Check Data(835 MHz)

Type: Phone measurement (Complete)  
 E-Field Probe: SN 34/15 SSE2 EPGO265  
 Area scan resolution: dx=8mm,dy=8mm  
 Zoom scan resolution: dx=8mm, dy=8mm, dz=5mm  
 Date of measurement: 2020.01.20  
 Measurement duration: 13 minutes 27 seconds

## Experimental conditions.

<b>Phantom File</b>	surf_sam_plan.txt
<b>Phantom</b>	Validation plane
<b>Band</b>	835MHz
<b>Signal</b>	CW
<b>Frequency (MHz)</b>	835.000000
<b>Relative permittivity (real part)</b>	41.976726
<b>Conductivity (S/m)</b>	0.891926
<b>Power drift (%)</b>	-0.120000
<b>Ambient Temperature:</b>	22.7°C
<b>Liquid Temperature:</b>	21.4°C
<b>ConvF:</b>	1.93
<b>Crest factor:</b>	1:1

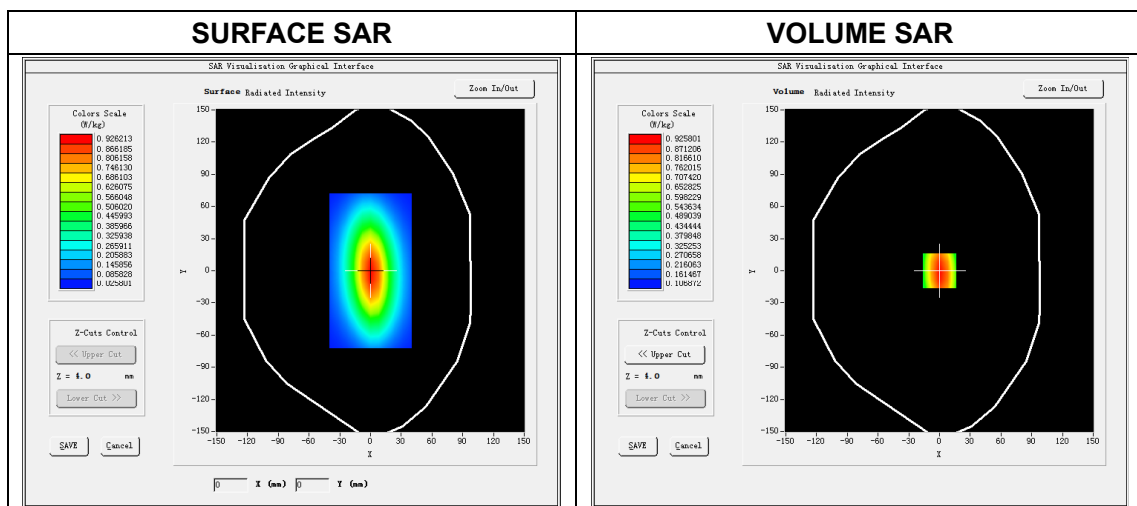

Maximum location: X=0.00, Y=0.00

SAR Peak: 1.26 W/kg

SAR 10 g (W/Kg)	0.587177
SAR 1g (W/Kg)	0.929599

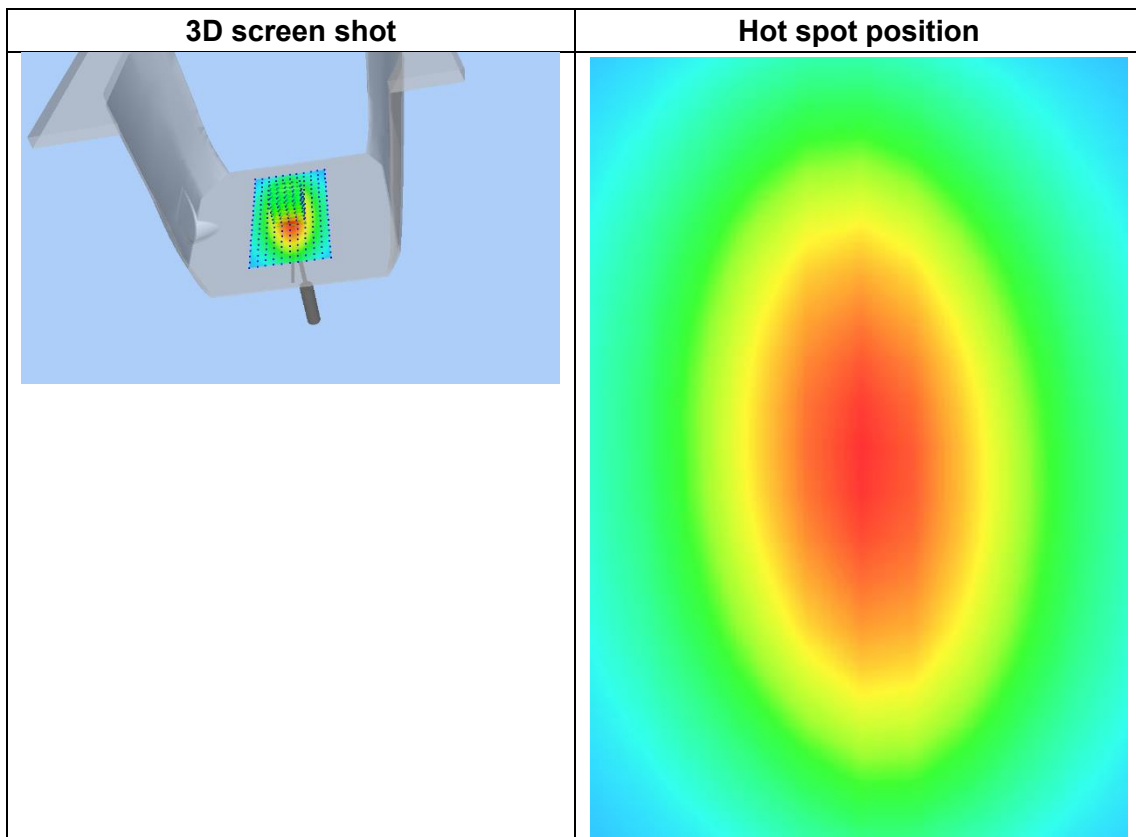
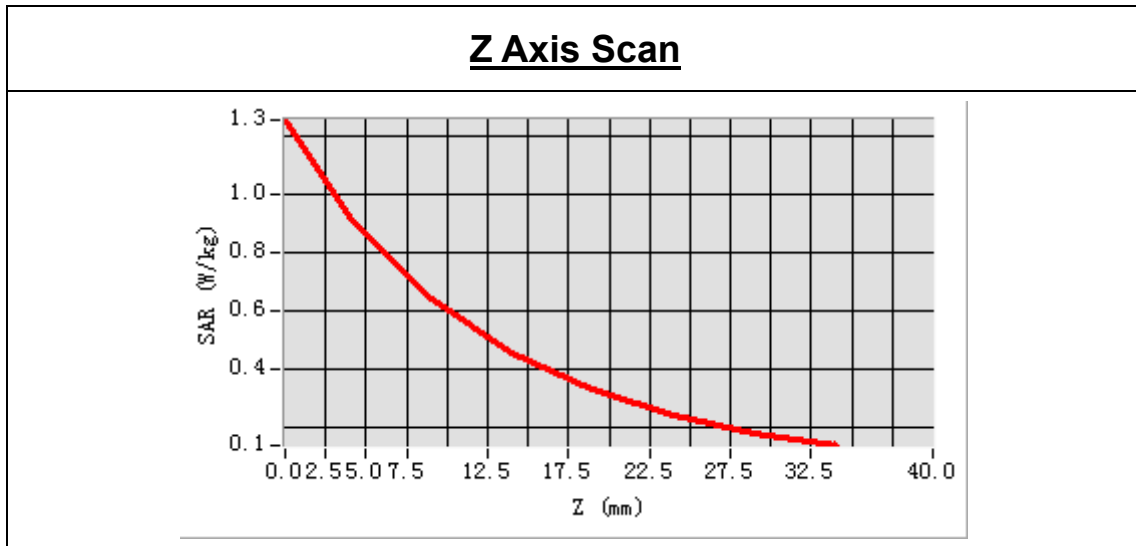

# System Performance Check Data(1800MHz)

Type: Phone measurement (Complete)  
 E-Field Probe: SN 34/15 SSE2 EPGO265  
 Area scan resolution: dx=8mm,dy=8mm  
 Zoom scan resolution: dx=8mm, dy=8mm, dz=5mm  
 Date of measurement: 2020.02.06  
 Measurement duration: 13 minutes 48 seconds

## Experimental conditions.

<b>Phantom File</b>	surf_sam_plan.txt
<b>Phantom</b>	Validation plane
<b>Band</b>	1800MHz
<b>Signal</b>	CW
<b>Frequency (MHz)</b>	1800.000000
<b>Relative permittivity (real part)</b>	39.905123
<b>Conductivity (S/m)</b>	1.412871
<b>Power drift (%)</b>	0.760000
<b>Ambient Temperature:</b>	22.8°C
<b>Liquid Temperature:</b>	21.3°C
<b>ConvF:</b>	2.18
<b>Crest factor:</b>	1:1

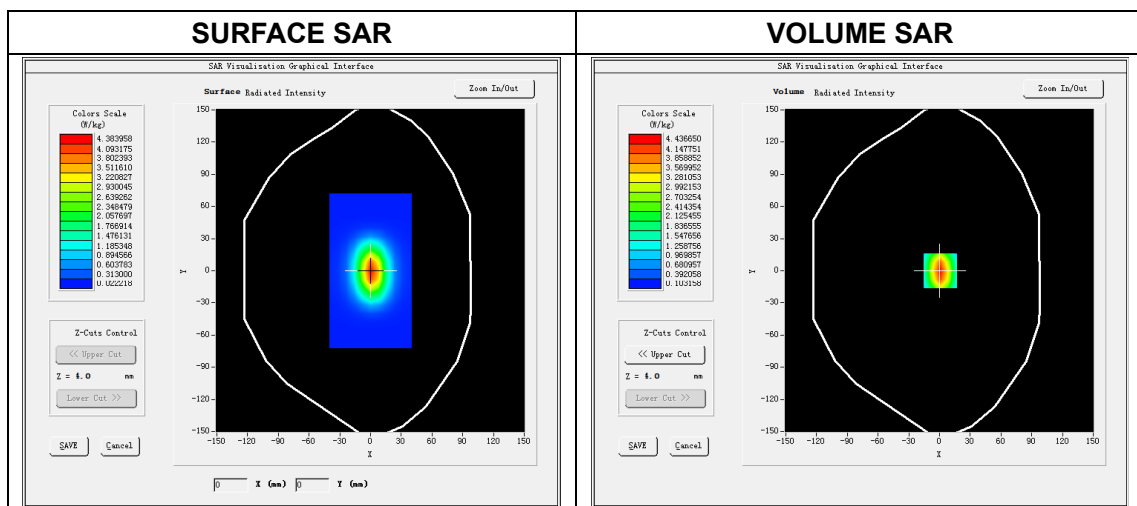

Maximum location: X=1.00, Y=0.00

SAR Peak: 6.93 W/kg

SAR 10 g (W/Kg)	2.151007
SAR 1g (W/Kg)	4.141611

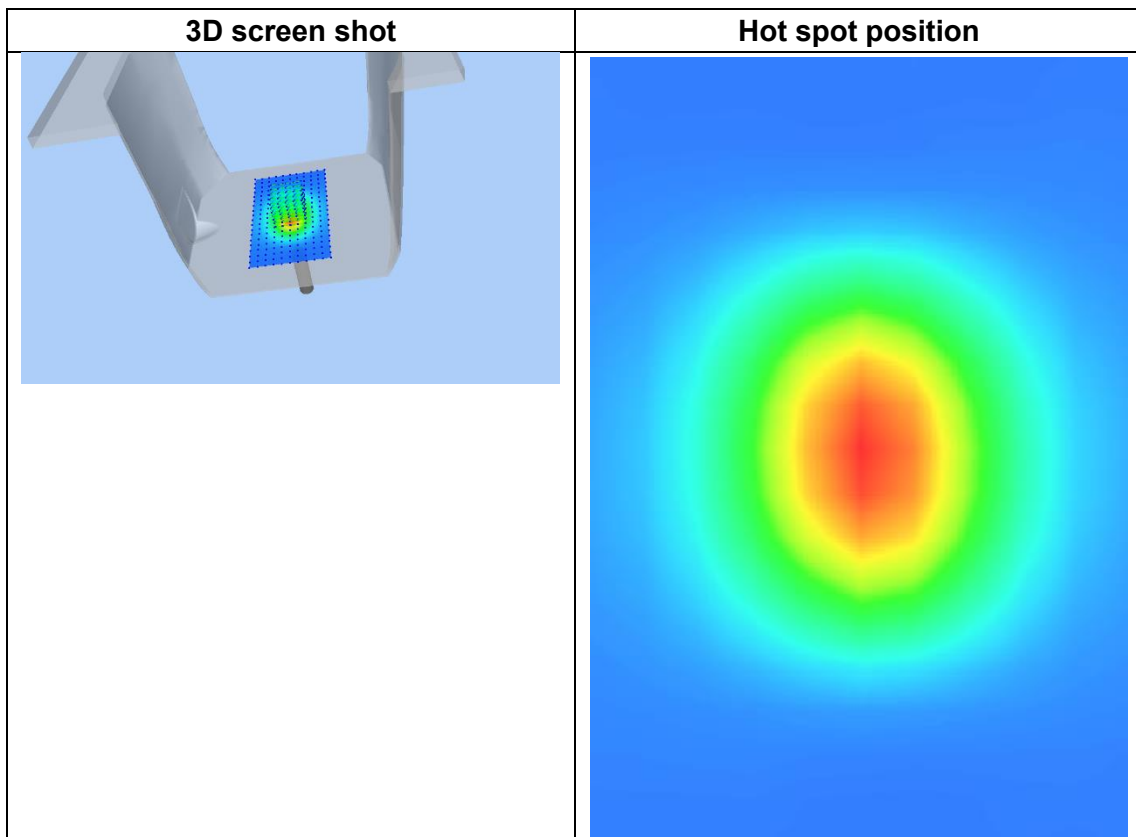
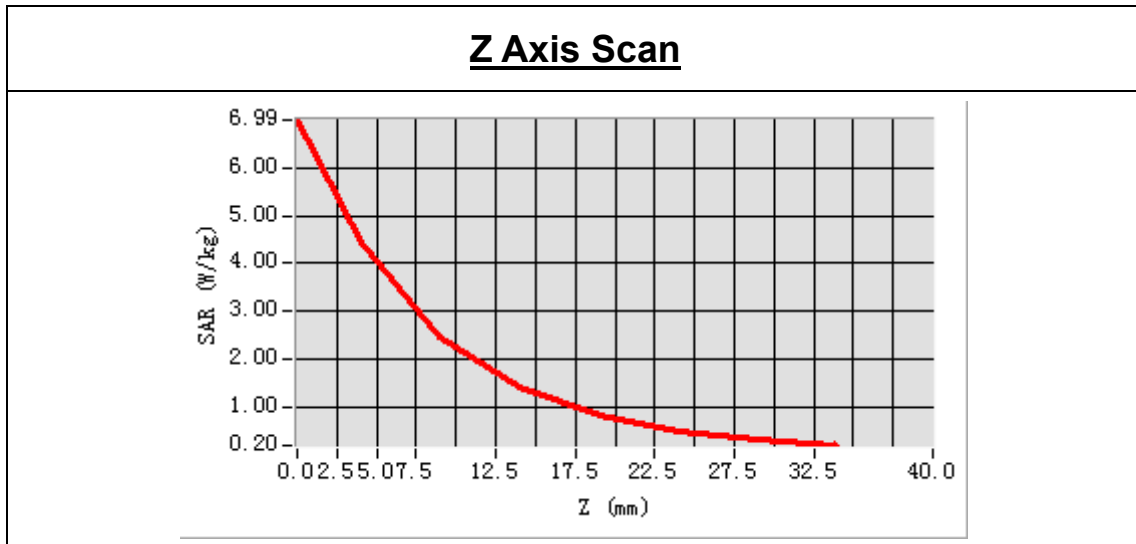

# System Performance Check Data(1900MHz)

Type: Phone measurement (Complete)  
 E-Field Probe: SN 34/15 SSE2 EPGO265  
 Area scan resolution: dx=8mm,dy=8mm  
 Zoom scan resolution: dx=8mm, dy=8mm, dz=5mm  
 Date of measurement: 2020.02.07  
 Measurement duration: 14 minutes 07 seconds

## Experimental conditions.

<b>Phantom File</b>	surf_sam_plan.txt
<b>Phantom</b>	Validation plane
<b>Band</b>	1900MHz
<b>Signal</b>	CW
<b>Frequency (MHz)</b>	1900.000000
<b>Relative permittivity (real part)</b>	40.081386
<b>Conductivity (S/m)</b>	1.401825
<b>Power drift (%)</b>	-0.520000
<b>Ambient Temperature:</b>	22.9°C
<b>Liquid Temperature:</b>	21.5°C
<b>ConvF:</b>	2.46
<b>Crest factor:</b>	1:1

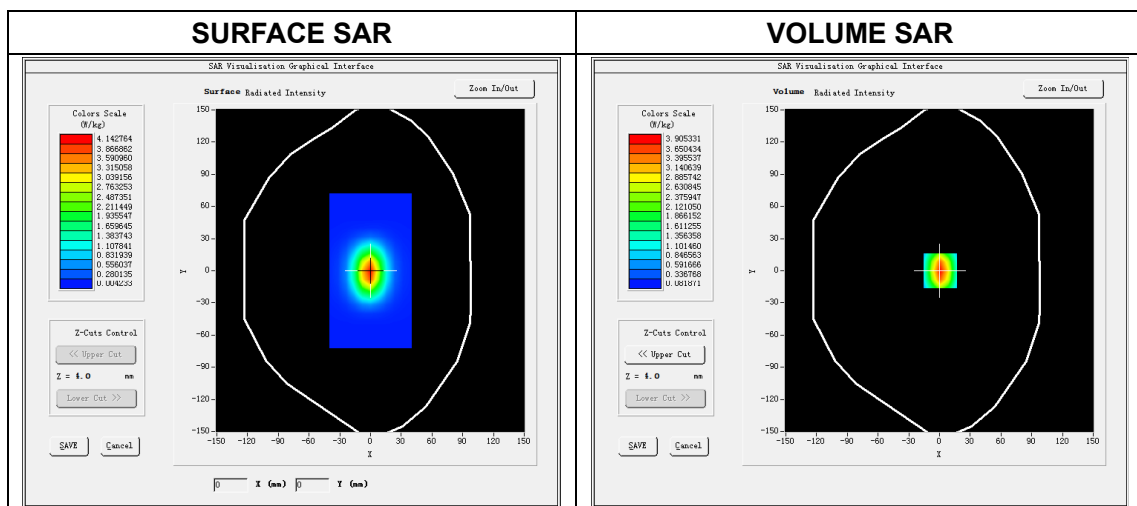

Maximum location: X=1.00, Y=0.00

SAR Peak: 6.10W/kg

SAR 10g (W/Kg)	1.924974
SAR 1g (W/Kg)	3.731512

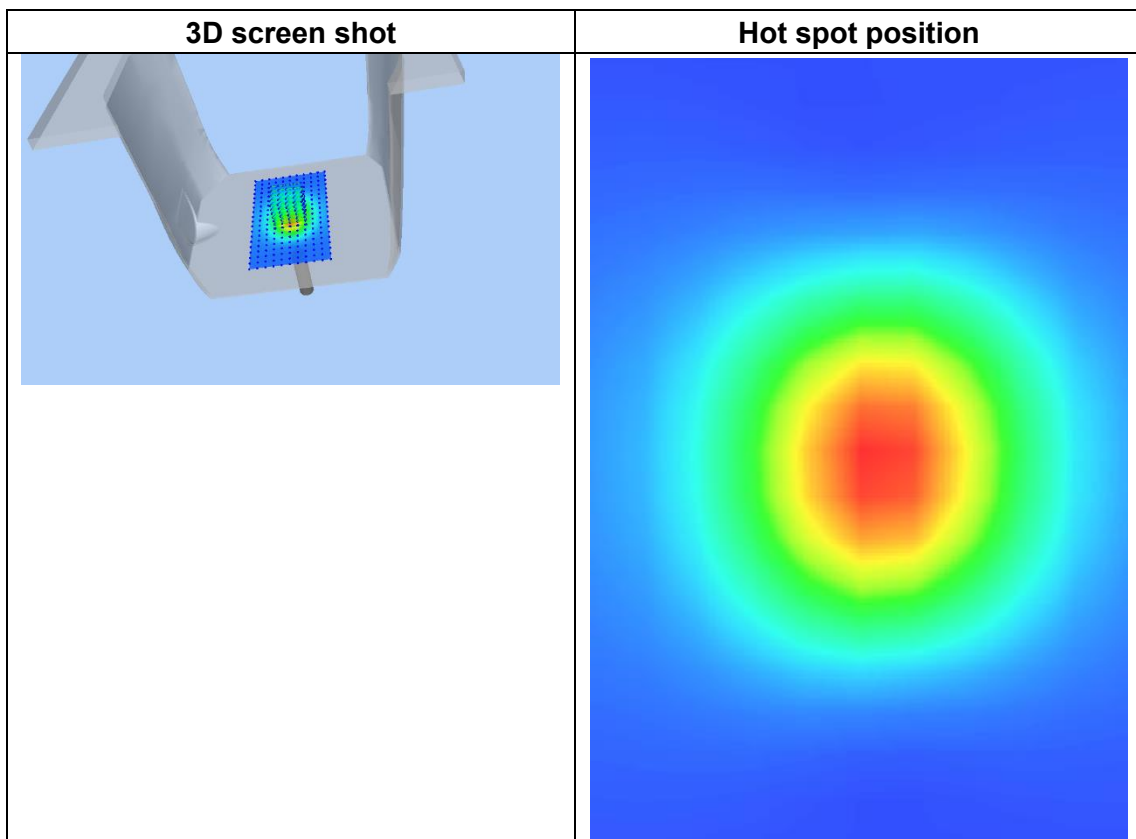
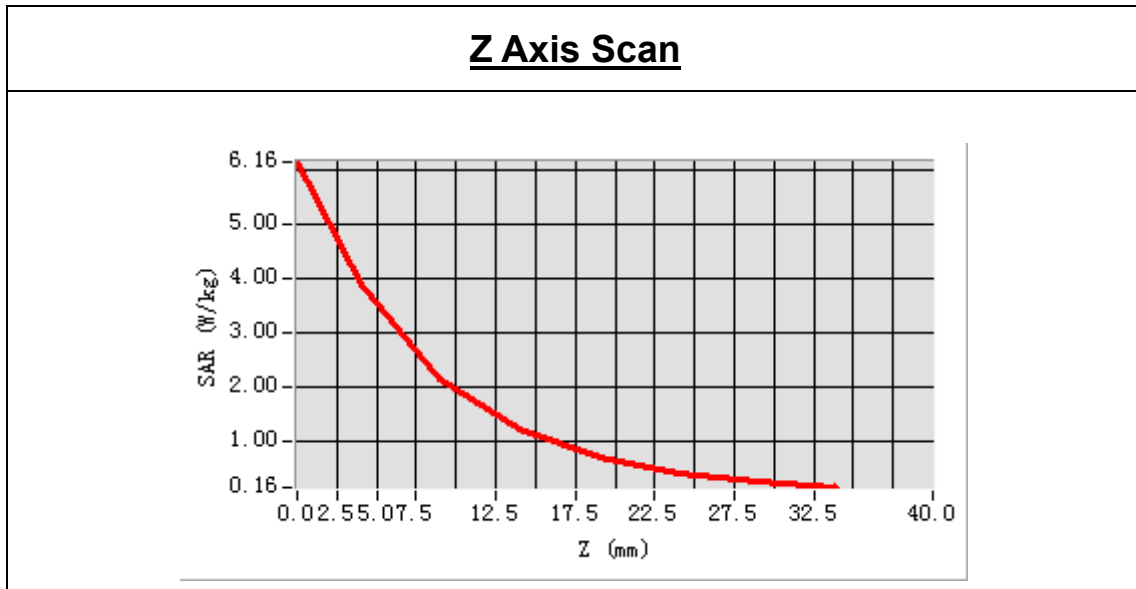

# System Performance Check Data(1900MHz)

Type: Phone measurement (Complete)  
 E-Field Probe: SN 34/15 SSE2 EPGO265  
 Area scan resolution: dx=8mm,dy=8mm  
 Zoom scan resolution: dx=8mm, dy=8mm, dz=5mm  
 Date of measurement: 2020.02.08  
 Measurement duration: 13 minutes 54 seconds

## Experimental conditions.

<b>Phantom File</b>	surf_sam_plan.txt
<b>Phantom</b>	Validation plane
<b>Band</b>	1900MHz
<b>Signal</b>	CW
<b>Frequency (MHz)</b>	1900.000000
<b>Relative permittivity (real part)</b>	39.806923
<b>Conductivity (S/m)</b>	1.407282
<b>Power drift (%)</b>	0.110000
<b>Ambient Temperature:</b>	22.7°C
<b>Liquid Temperature:</b>	21.6°C
<b>ConvF:</b>	2.46
<b>Crest factor:</b>	1:1

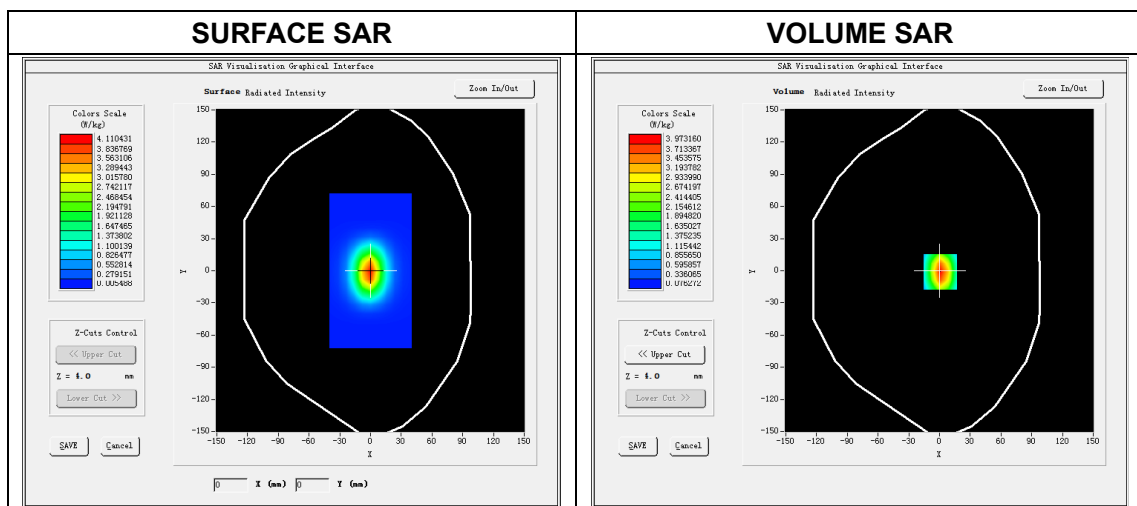



Maximum location: X=1.00, Y=-1.00

SAR Peak: 6.29 W/kg

SAR 10g (W/Kg)	1.913324
SAR 1g (W/Kg)	3.819634

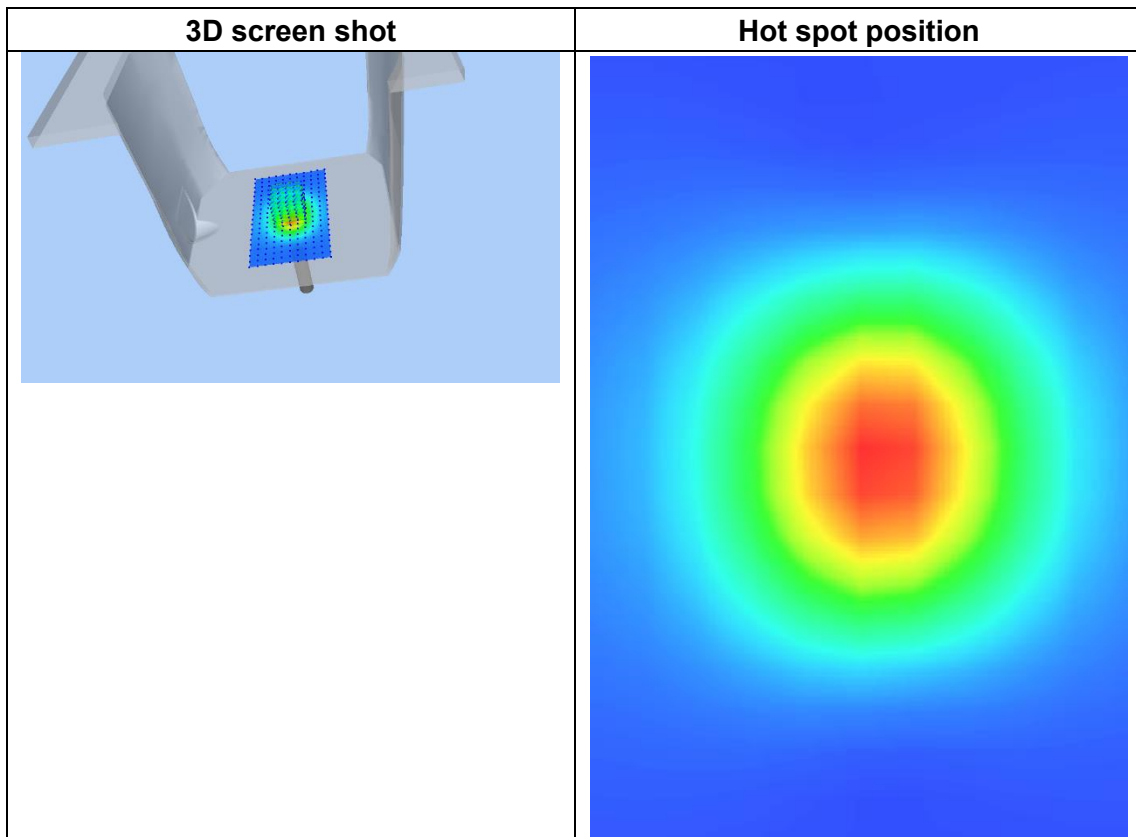
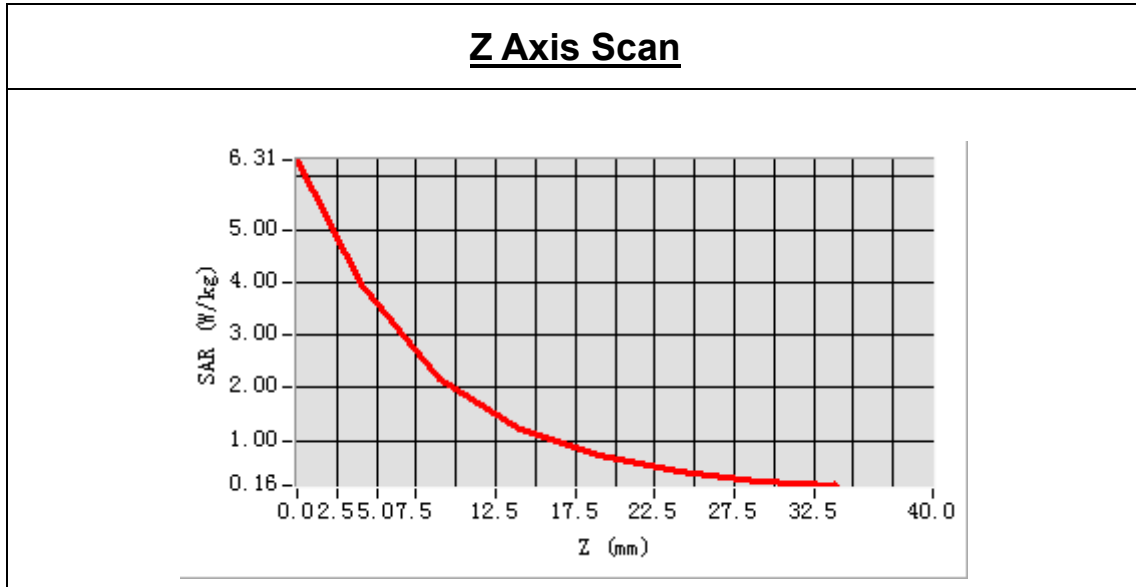

# System Performance Check Data(2450MHz)

Type: Phone measurement (Complete)  
 E-Field Probe: SN 34/15 SSE2 EPGO265  
 Area scan resolution: dx=8mm,dy=8mm  
 Zoom scan resolution: dx=5mm, dy=5mm, dz=5mm  
 Date of measurement: 2020.01.21  
 Measurement duration: 18 minutes 49 seconds

## Experimental conditions.

<b>Phantom File</b>	surf_sam_plan.txt
<b>Phantom</b>	Validation plane
<b>Band</b>	2450MHz
<b>Signal</b>	CW
<b>Frequency (MHz)</b>	2450.000000
<b>Relative permittivity (real part)</b>	39.431984
<b>Conductivity (S/m)</b>	1.785797
<b>Power drift (%)</b>	-0.310000
<b>Ambient Temperature:</b>	22.7°C
<b>Liquid Temperature:</b>	21.3°C
<b>ConvF:</b>	2.55
<b>Crest factor:</b>	1:1

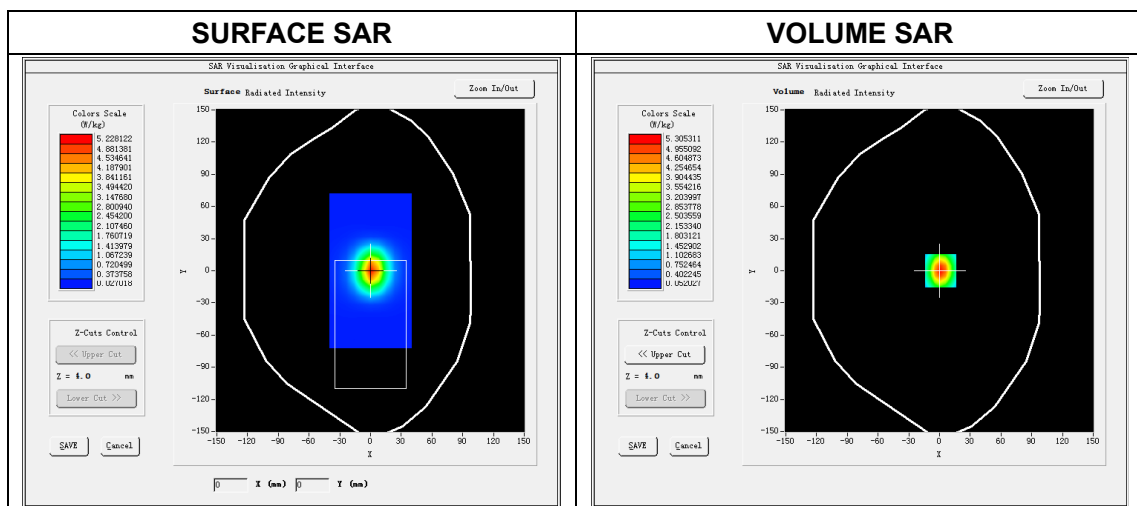

Maximum location: X=1.00, Y=0.00

SAR Peak: 9.20 W/kg

SAR 10g (W/Kg)	2.242416
SAR 1g (W/Kg)	4.930376

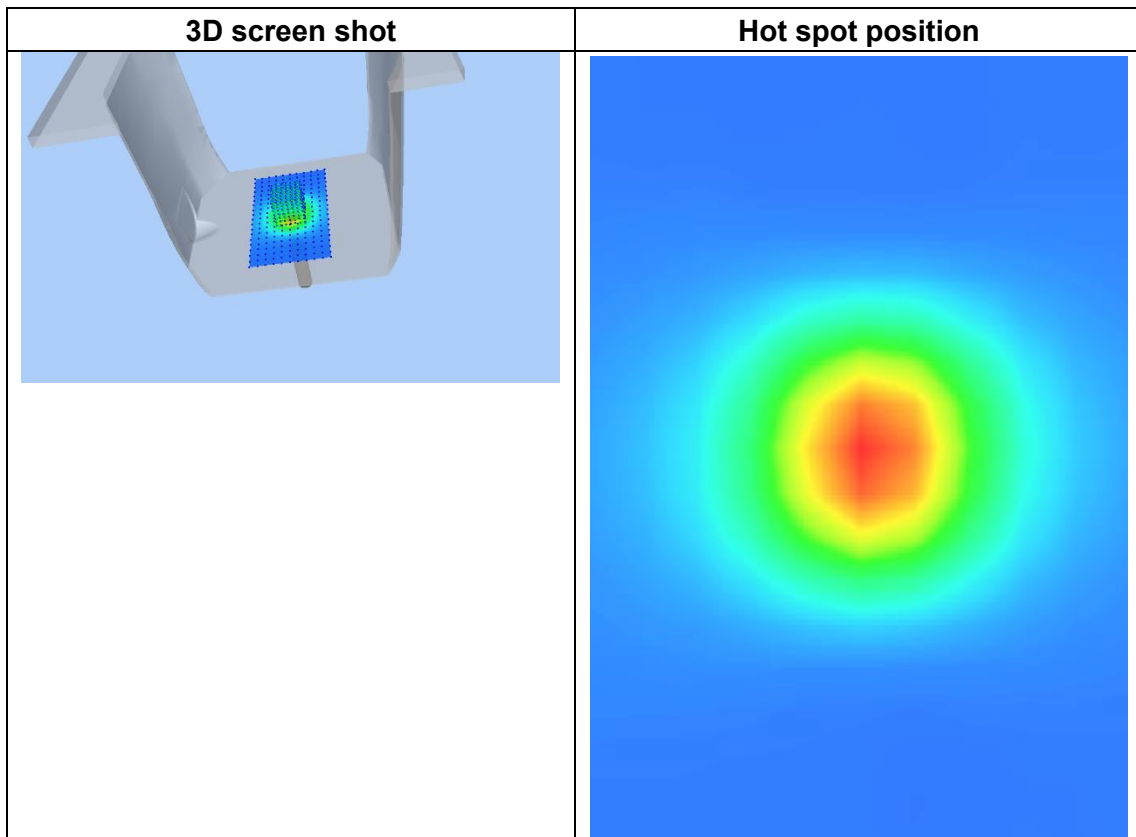
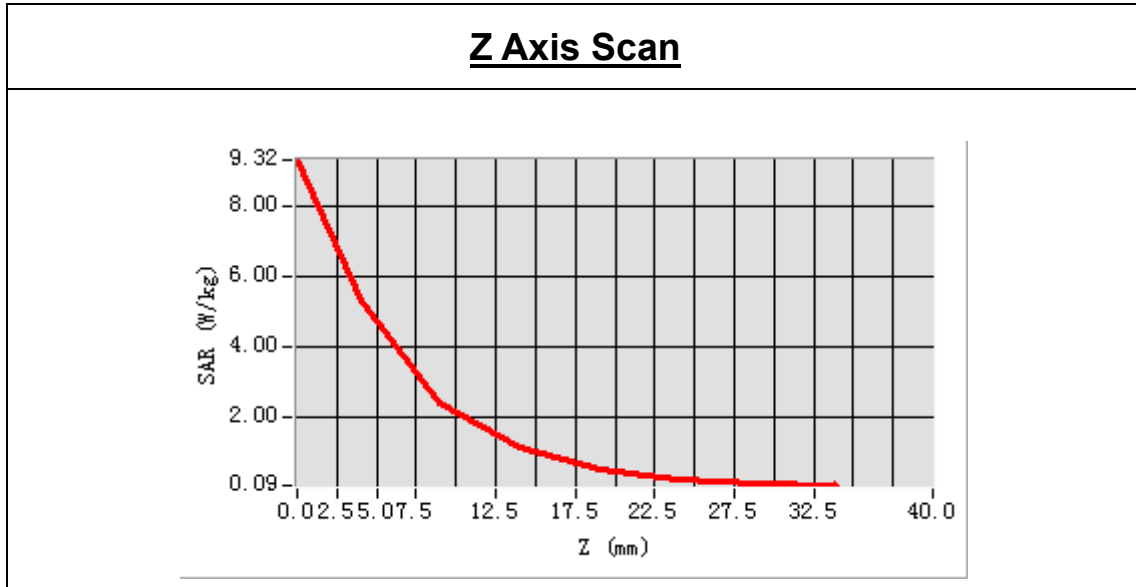

# System Performance Check Data(2600MHz)

Type: Phone measurement (Complete)  
 E-Field Probe: SN 34/15 SSE2 EPGO265  
 Area scan resolution: dx=8mm,dy=8mm  
 Zoom scan resolution: dx=5mm, dy=5mm, dz=5mm  
 Date of measurement: 2020.01.22  
 Measurement duration: 16 minutes 38 seconds

## Experimental conditions.

<b>Phantom File</b>	surf_sam_plan.txt
<b>Phantom</b>	Validation plane
<b>Band</b>	2600MHz
<b>Signal</b>	CW
<b>Frequency (MHz)</b>	2600.000000
<b>Relative permittivity (real part)</b>	38.690629
<b>Conductivity (S/m)</b>	1.983793
<b>Power drift (%)</b>	-1.870000
<b>Ambient Temperature:</b>	22.5°C
<b>Liquid Temperature:</b>	21.2°C
<b>ConvF:</b>	2.38
<b>Crest factor:</b>	1:1

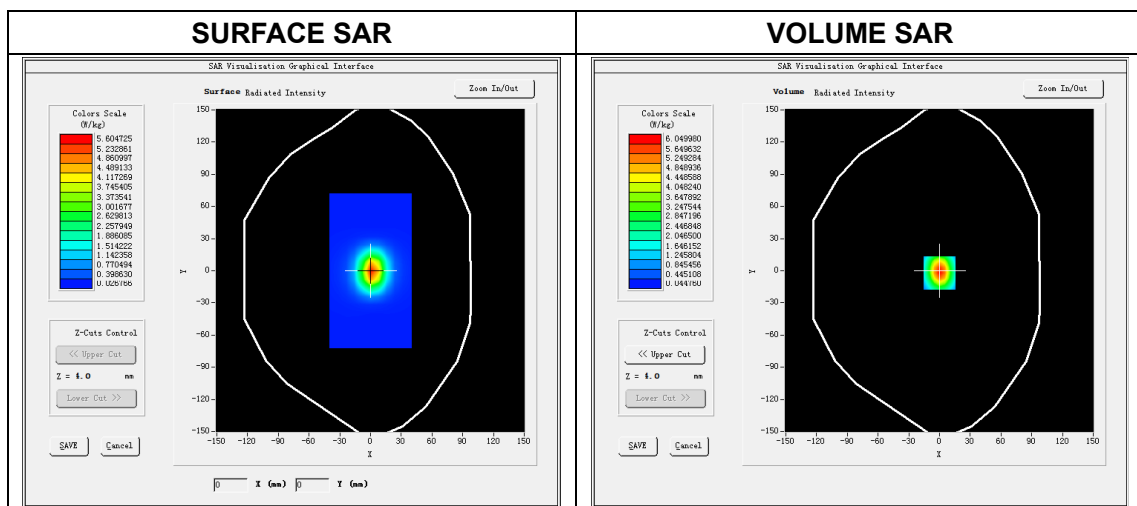

Maximum location: X=0.00, Y=-2.00

SAR Peak:10.48 W/kg

SAR 10g (W/Kg)	2.469851
SAR 1g (W/Kg)	5.639507

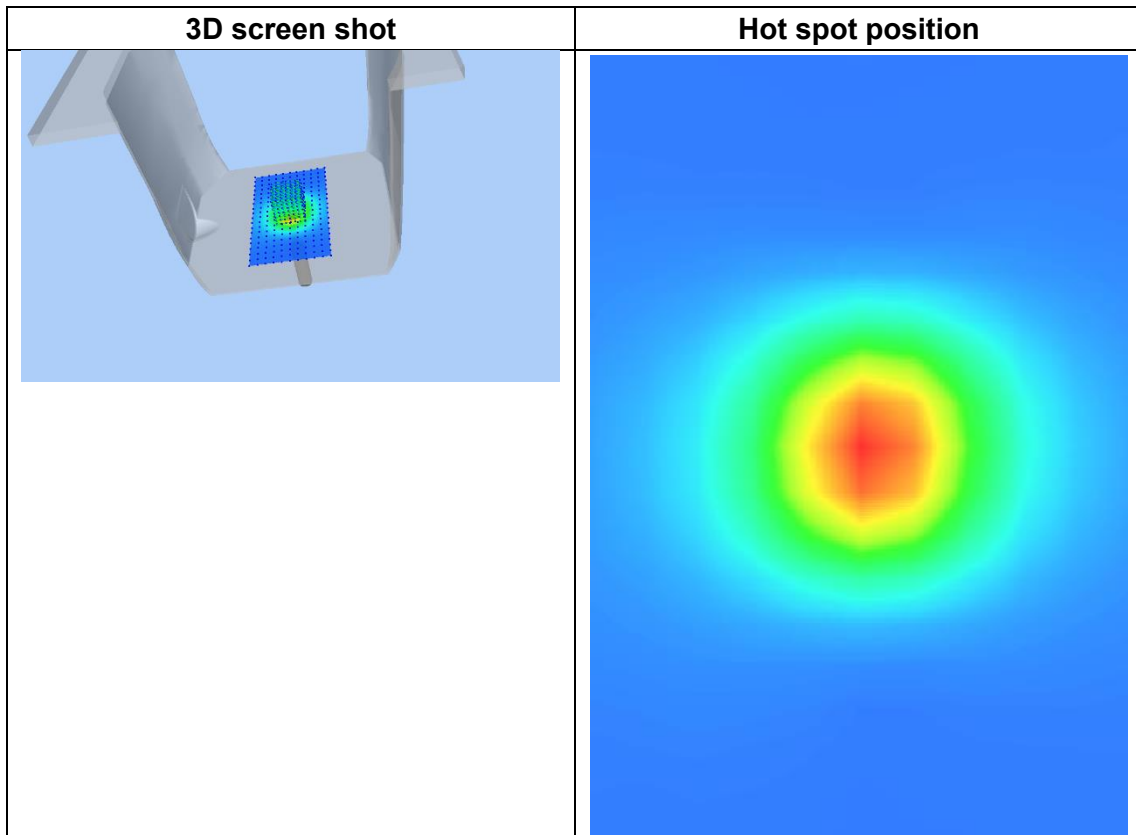
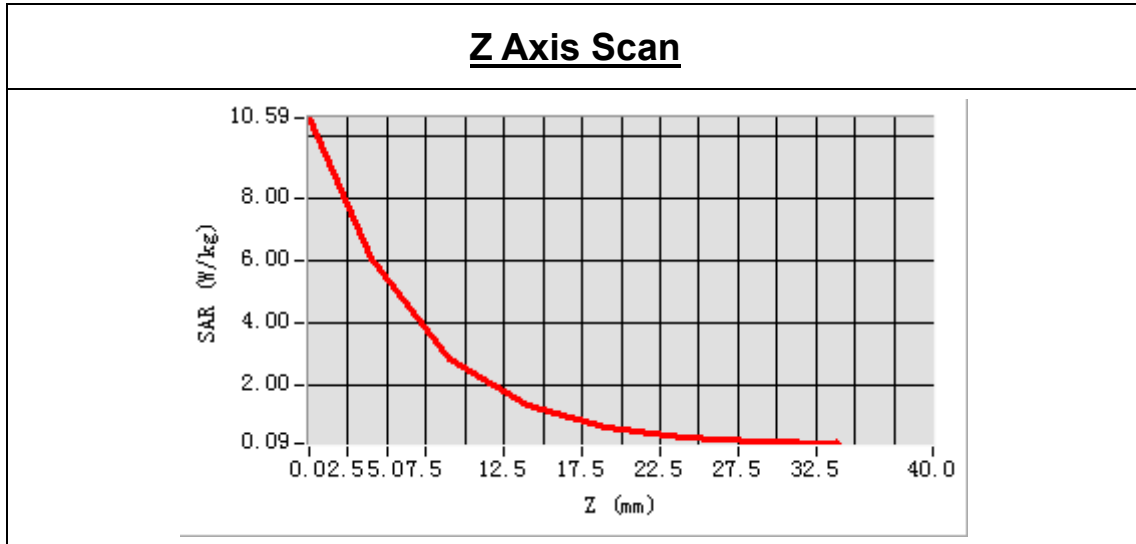

# System Performance Check Data(1800MHz)

Type: Phone measurement (Complete)  
 E-Field Probe: SN 39/21 EPGO359  
 Area scan resolution: dx=8mm,dy=8mm  
 Zoom scan resolution: dx=8mm, dy=8mm, dz=5mm  
 Date of measurement: 2022.02.24  
 Measurement duration: 13 minutes 59 seconds

## Experimental conditions.

<b>Phantom File</b>	surf_sam_plan.txt
<b>Phantom</b>	Validation plane
<b>Band</b>	1800MHz
<b>Signal</b>	CW
<b>Frequency (MHz)</b>	1800.000000
<b>Relative permittivity (real part)</b>	38.560174
<b>Conductivity (S/m)</b>	1.424038
<b>Power drift (%)</b>	-0.140000
<b>Ambient Temperature:</b>	22.4°C
<b>Liquid Temperature:</b>	22.3°C
<b>ConvF:</b>	1.94
<b>Crest factor:</b>	1:1

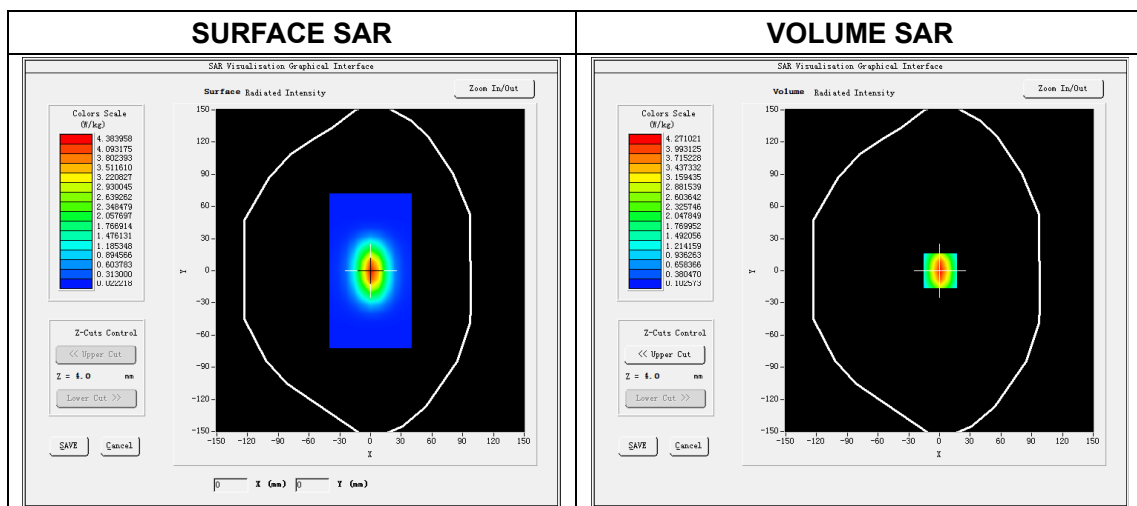

Maximum location: X=1.00, Y=0.00

SAR Peak: 6.69 W/kg

SAR 10 g (W/Kg)	2.081380
SAR 1g (W/Kg)	4.064215

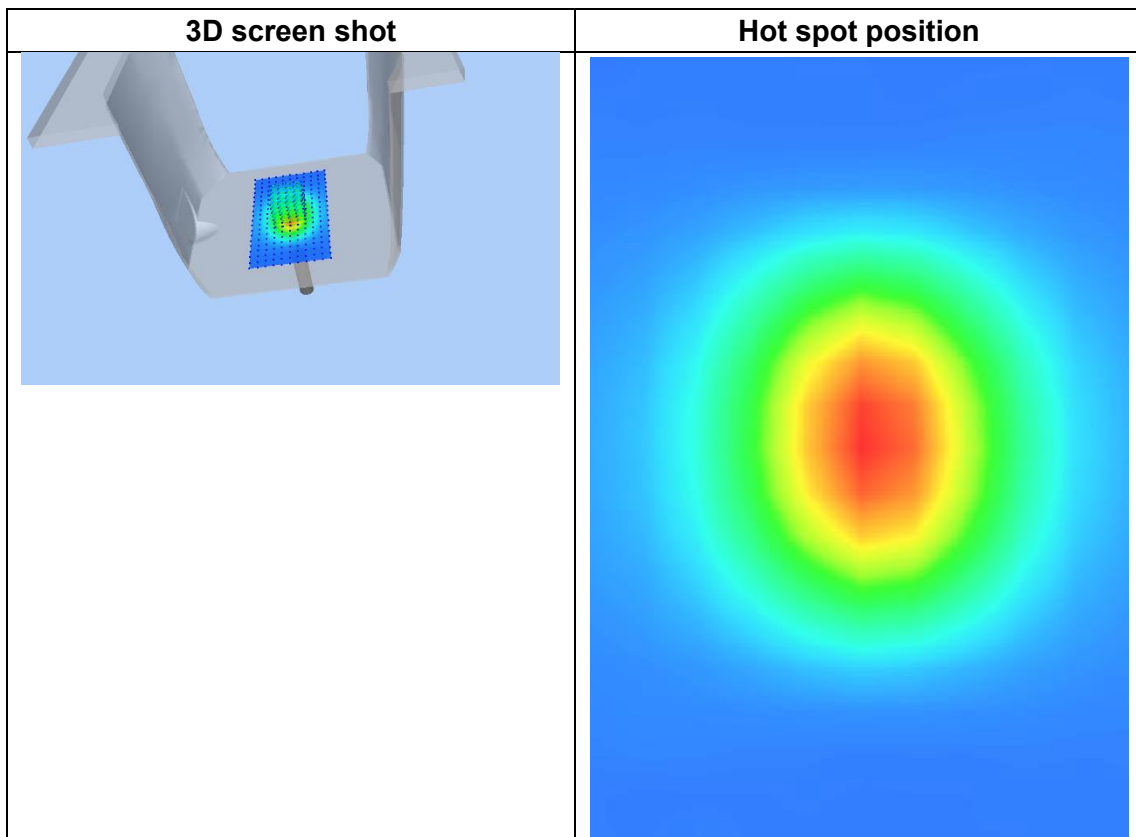
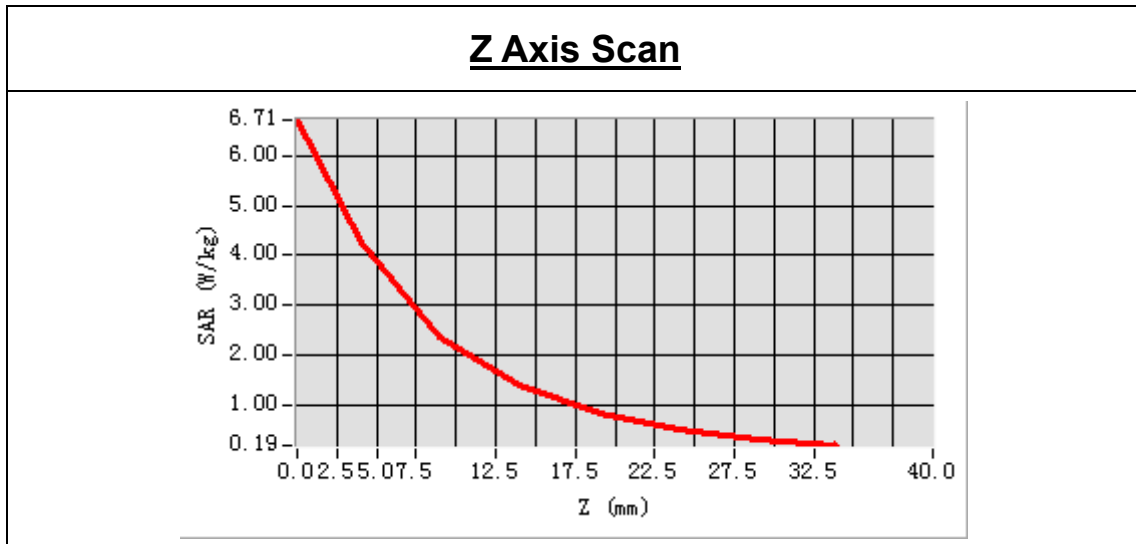

# System Performance Check Data(2600MHz)

Type: Phone measurement (Complete)  
 E-Field Probe: SN 39/21 EPGO359  
 Area scan resolution: dx=8mm,dy=8mm  
 Zoom scan resolution: dx=5mm, dy=5mm, dz=5mm  
 Date of measurement: 2022.02.24  
 Measurement duration: 18 minutes 35 seconds

## Experimental conditions.

<b>Phantom File</b>	surf_sam_plan.txt
<b>Phantom</b>	Validation plane
<b>Band</b>	2600MHz
<b>Signal</b>	CW
<b>Frequency (MHz)</b>	2600.000000
<b>Relative permittivity (real part)</b>	38.546247
<b>Conductivity (S/m)</b>	1.980219
<b>Power drift (%)</b>	0.810000
<b>Ambient Temperature:</b>	22.4°C
<b>Liquid Temperature:</b>	21.3°C
<b>ConvF:</b>	2.15
<b>Crest factor:</b>	1:1

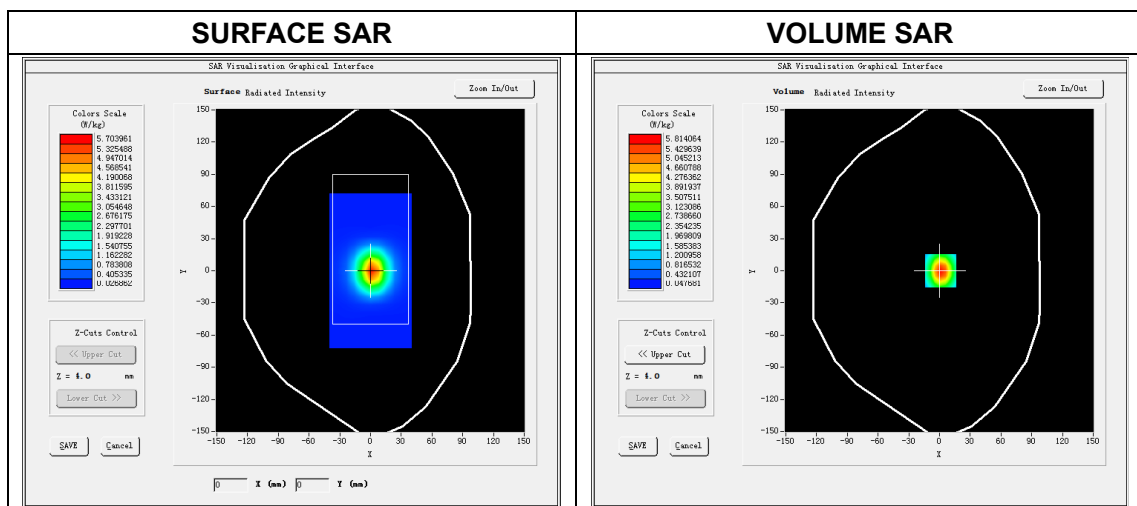



Maximum location: X=1.00, Y=-1.00

SAR Peak: 10.43 W/kg

SAR 10g (W/Kg)	2.456316
SAR 1g (W/Kg)	5.395168

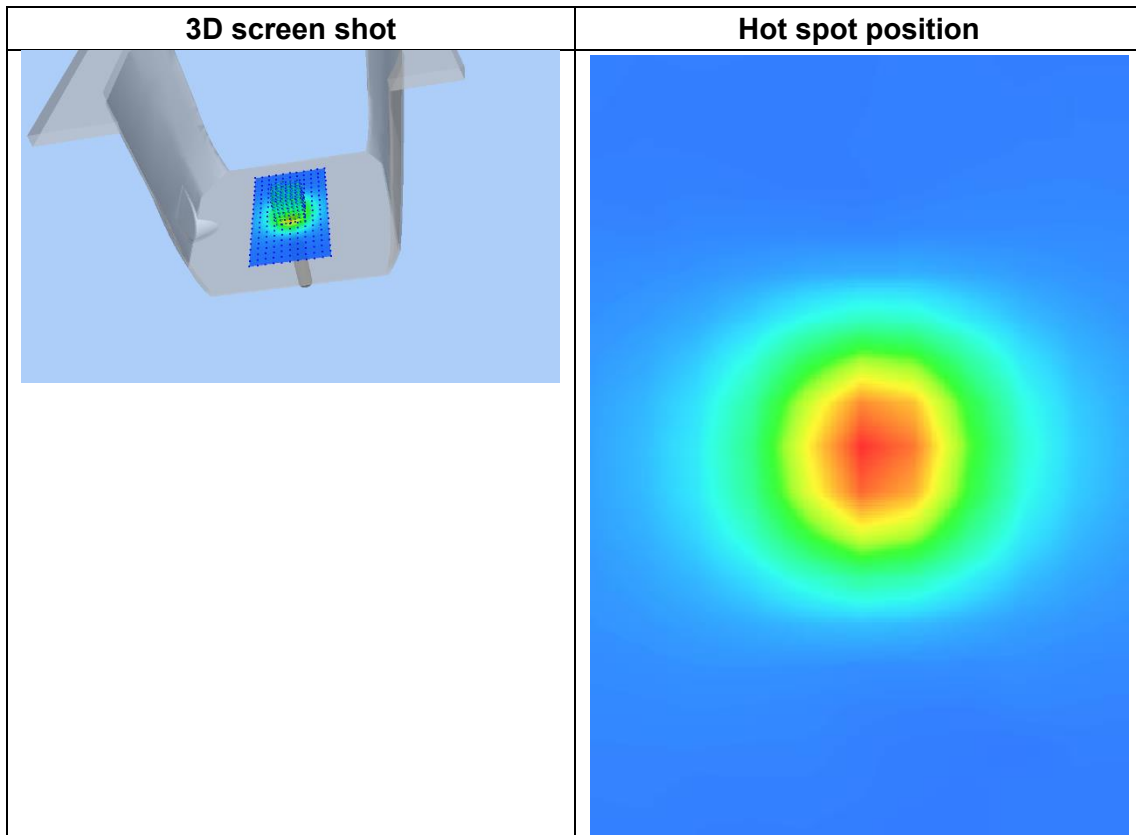
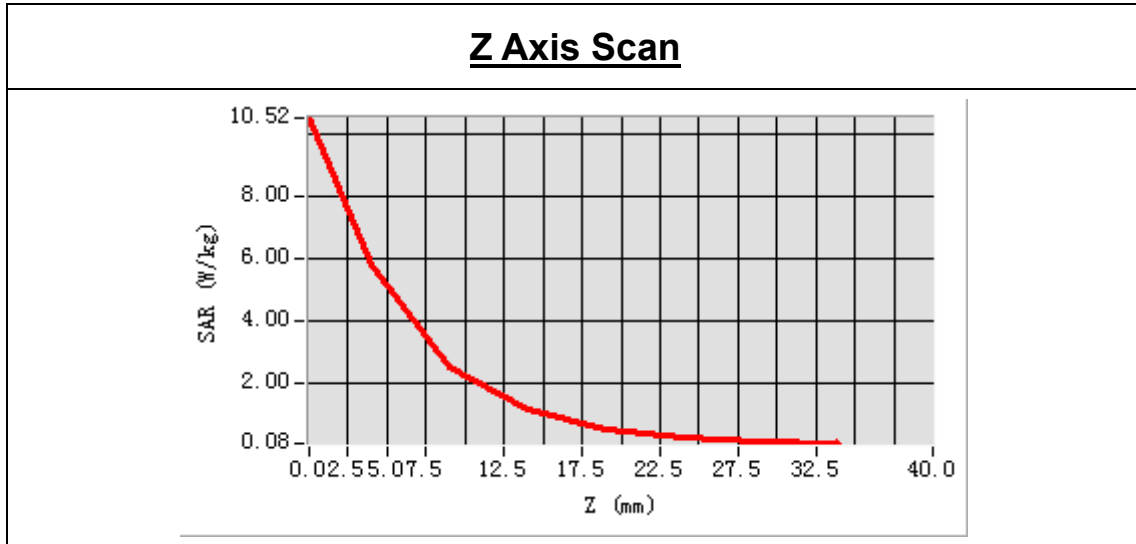

## ANNEX C TEST DATA

### MEAS. 1 Right Head with Cheek on Middle Channel in GPRS850-2Slots mode

**Test Date:** 19/1/2020  
**Measurement duration:** 11 minutes 43 seconds  
**Signal:** GPRS, f=836.6 MHz, Duty Cycle: 1:4.0  
**Liquid Parameters:** Permittivity: 41.96; Conductivity: 0.88 S/m  
**Test condition:** Ambient Temperature: 22.5°C, Liquid Temperature: 21.6°C  
**Probe:** SN 34/15 SSE2 EPGO265, ConvF: 1.93  
**Area Scan:** sam\_direct\_droit2\_surf10mm.txt, h= 5.00 mm  
**Zoom Scan:** 5x5x7,dx=8mm, dy=8mm, dz=5mm,Complete  
**Maximum location:** X=-46.000000, Y=-46.000000  
**SAR 10g (W/Kg):** 0.345709  
**SAR 1g (W/Kg):** 0.464203  
**Power drift (%):** 0.55  
**3D screen shot**

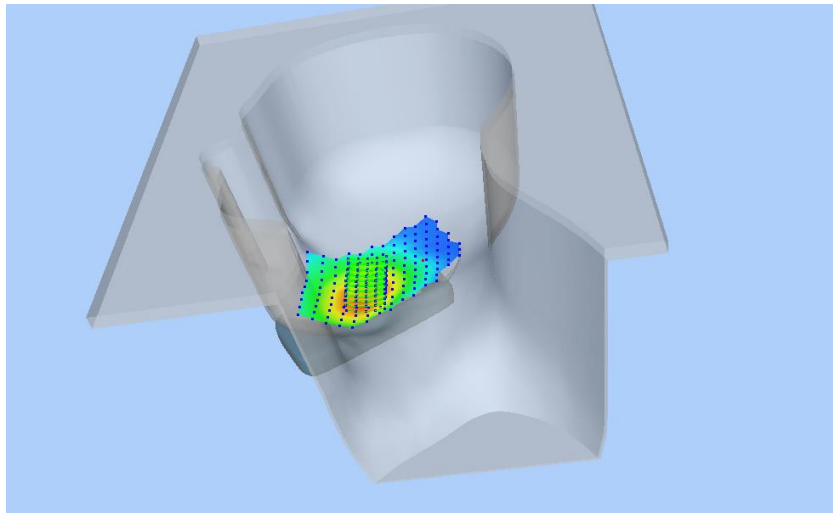

### Z Axis Scan

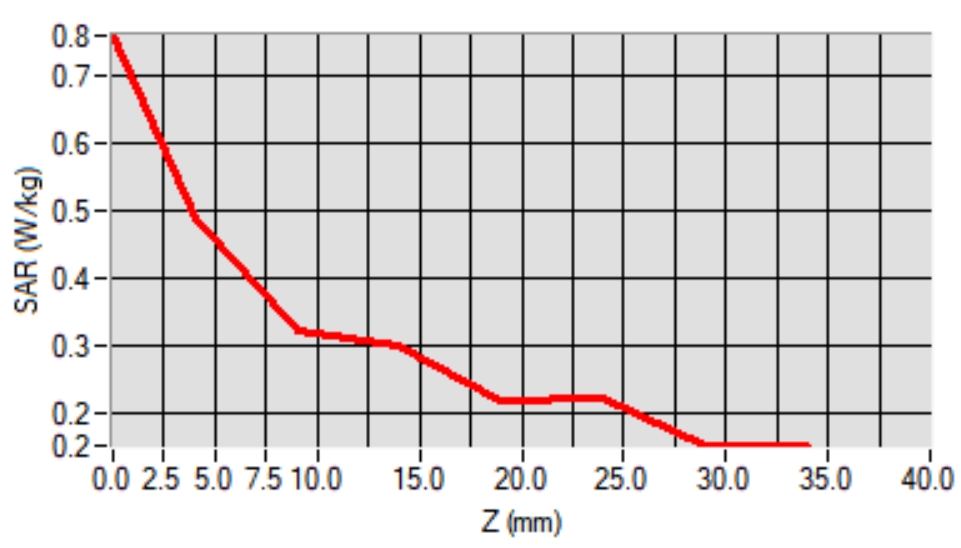

**MEAS. 2 Body Plane with Back Side 10mm on Middle Channel in GPRS850-2Slots mode**

**Test Date:** 19/1/2020  
**Measurement duration:** 13 minutes 47 seconds  
**Signal:** GPRS, f=836.6 MHz, Duty Cycle: 1:4.0  
**Liquid Parameters:** Permittivity: 41.96; Conductivity: 0.88 S/m  
**Test condition:** Ambient Temperature: 22.5°C, Liquid Temperature: 21.6°C  
**Probe:** SN 34/15 SSE2 EPGO265, ConvF: 1.93  
**Area Scan:** sam\_direct\_droit2\_surf10mm.txt, h= 5.00 mm  
**Zoom Scan:** 5x5x7,dx=8mm, dy=8mm, dz=5mm,Complete  
**Maximum location:** X=10.000000, Y=-12.000000  
**SAR 10g (W/Kg):** 0.468900  
**SAR 1g (W/Kg):** 0.669629  
**Power drift (%):** 0.85  
**3D screen shot**

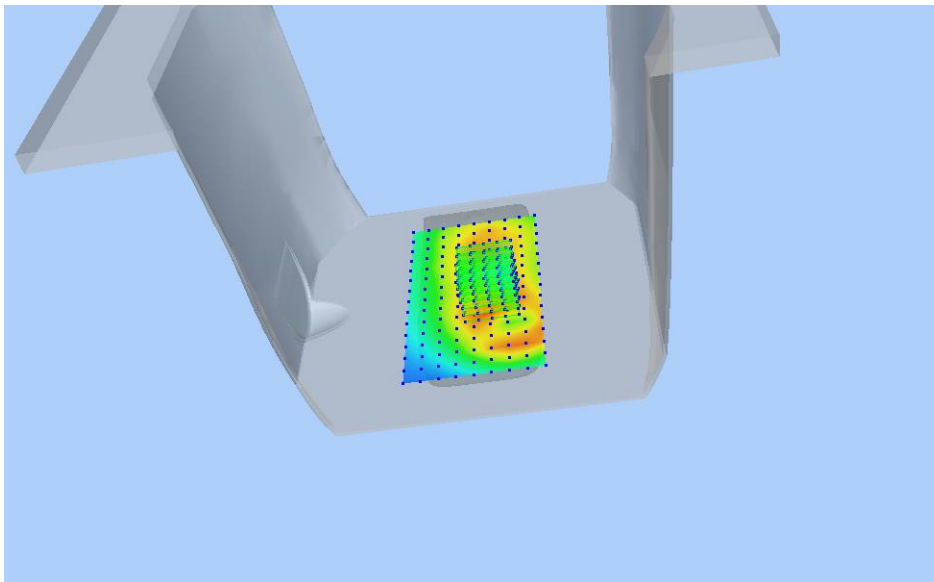

**Z Axis Scan**

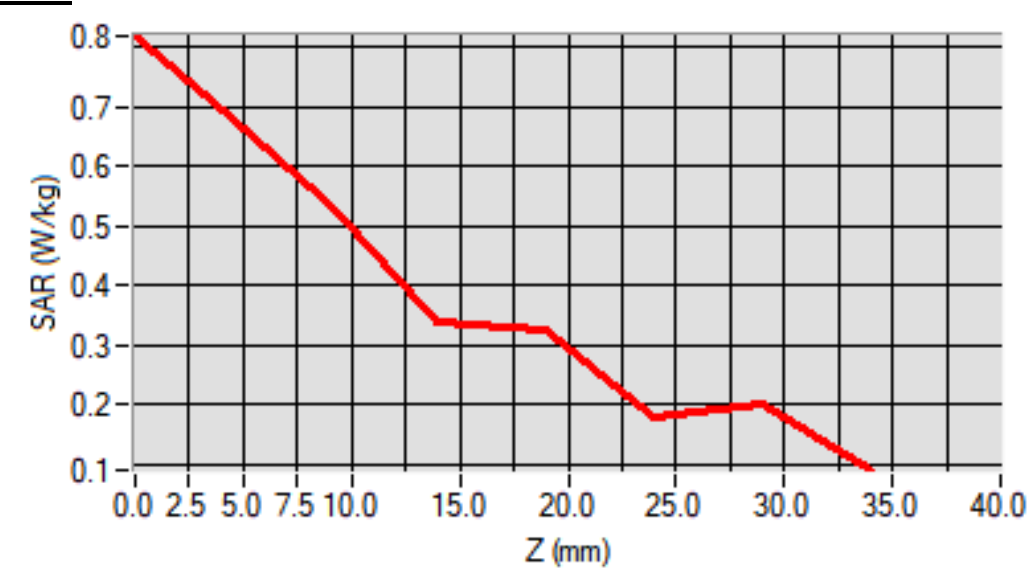

**MEAS. 3 Left Head with Cheek on Low Channel in GPRS1900-4Slots mode**

**Test Date:** 8/2/2020  
**Measurement duration:** 12 minutes 18 seconds  
**Signal:** GPRS, f=1850.2 MHz, Duty Cycle: 1:2.0  
**Liquid Parameters:** Permittivity: 40.39; Conductivity: 1.38 S/m  
**Test condition:** Ambient Temperature: 22.7°C, Liquid Temperature: 21.6°C  
**Probe:** SN 34/15 SSE2 EPGO265, ConvF: 2.46  
**Area Scan:** sam\_direct\_droit2\_surf10mm.txt, h= 5.00 mm  
**Zoom Scan:** 5x5x7,dx=8mm, dy=8mm, dz=5mm,Complete  
**Maximum location:** X=-56.000000, Y=-56.000000  
**SAR 10g (W/Kg):** 0.244219  
**SAR 1g (W/Kg):** 0.420708  
**Power drift (%):** -0.32  
**3D screen shot**

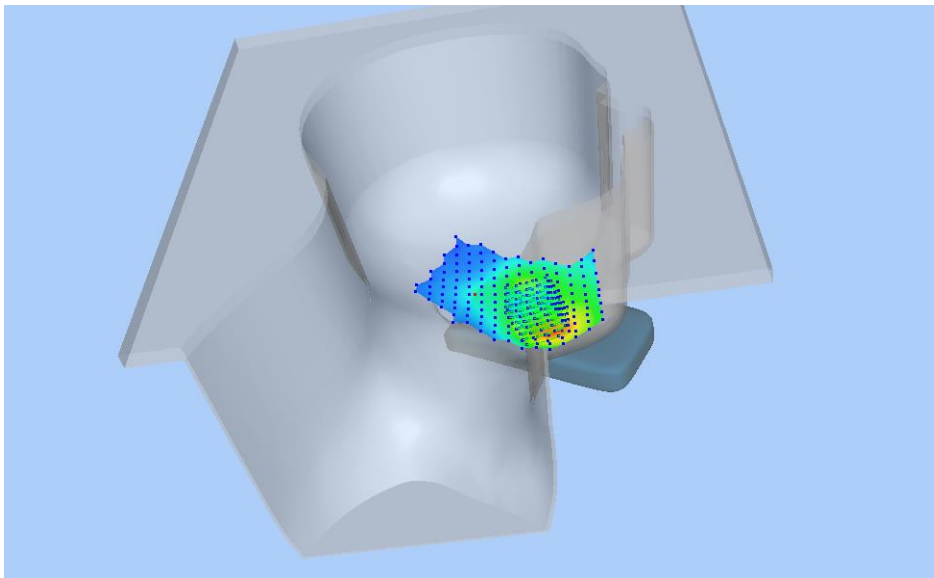

**Z Axis Scan**

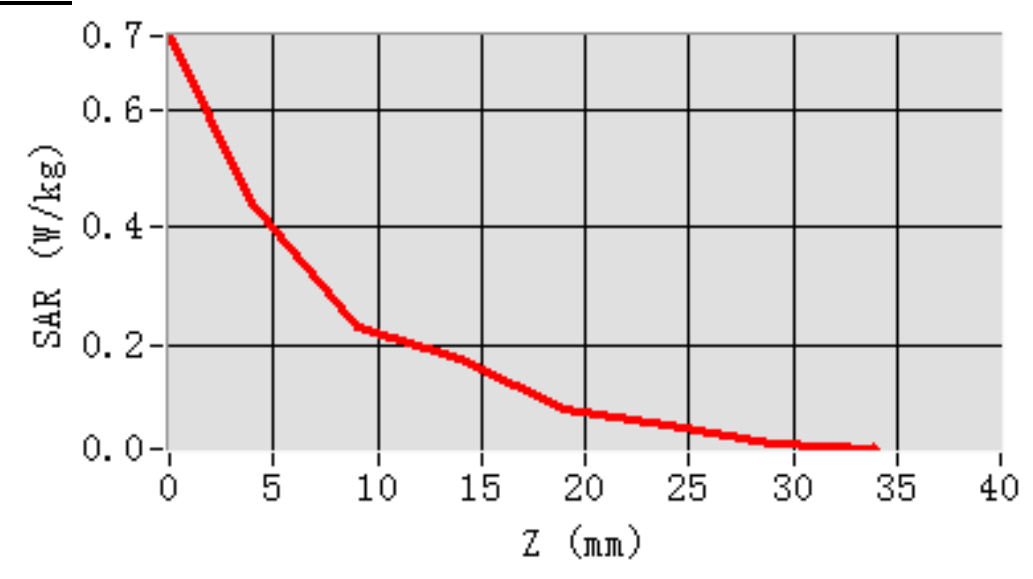

**MEAS. 4 Body Plane with Front Side 10mm on Low Channel in GPRS1900-4Slots mode**

**Test Date:** 8/2/2020  
**Measurement duration:** 1 minutes 38 seconds  
**Signal:** GPRS, f=1850.2 MHz, Duty Cycle: 1:2.0  
**Liquid Parameters:** Permittivity: 40.39; Conductivity: 1.38 S/m  
**Test condition:** Ambient Temperature: 22.7°C, Liquid Temperature: 21.6°C  
**Probe:** SN 34/15 SSE2 EPGO265, ConvF: 2.46  
**Area Scan:** sam\_direct\_droit2\_surf10mm.txt, h= 5.00 mm  
**Zoom Scan:** 5x5x7,dx=8mm, dy=8mm, dz=5mm,Complete  
**Maximum location:** X=-10.000000, Y=-42.000000  
**SAR 10g (W/Kg):** 0.478274  
**SAR 1g (W/Kg):** 0.879251  
**Power drift (%):** 0.36  
**3D screen shot**

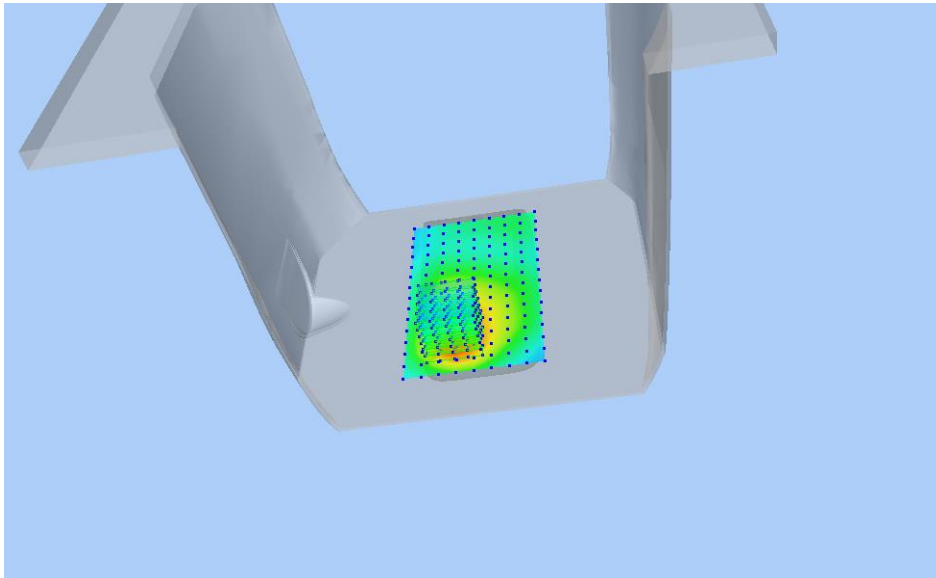

**Z Axis Scan**

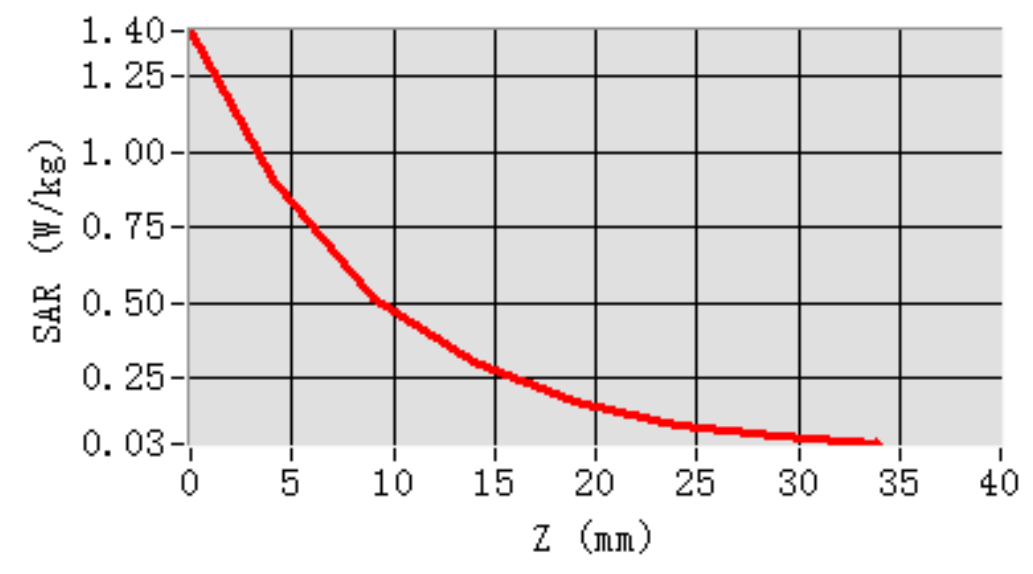

**MEAS. 5 Left Head with Cheek on High Channel in WCDMA Band 2 mode**

**Test Date:** 7/2/2020  
**Measurement duration:** 12 minutes 17 seconds  
**Signal:** WCDMA, f=1907.6 MHz, Duty Cycle: 1:1.0  
**Liquid Parameters:** Permittivity: 40.01; Conductivity: 1.40 S/m  
**Test condition:** Ambient Temperature: 22.9°C, Liquid Temperature: 21.5°C  
**Probe:** SN 34/15 SSE2 EPGO265, ConvF: 2.46  
**Area Scan:** sam\_direct\_droit2\_surf10mm.txt, h= 5.00 mm  
**Zoom Scan:** 5x5x7,dx=8mm, dy=8mm, dz=5mm,Complete  
**Maximum location:** X=-56.000000, Y=-56.000000  
**SAR 10g (W/Kg):** 0.303868  
**SAR 1g (W/Kg):** 0.528716  
**Power drift (%):** -1.33  
**3D screen shot**

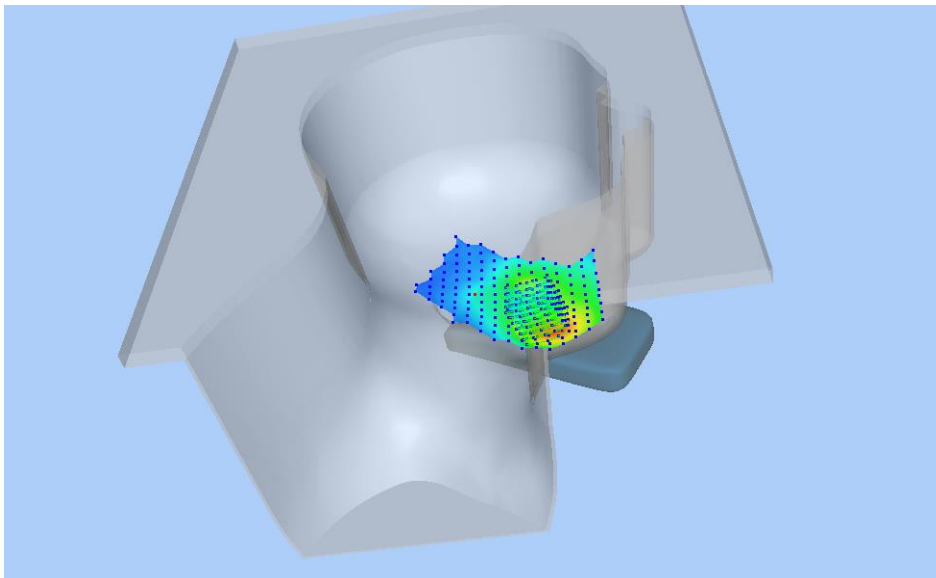

**Z Axis Scan**

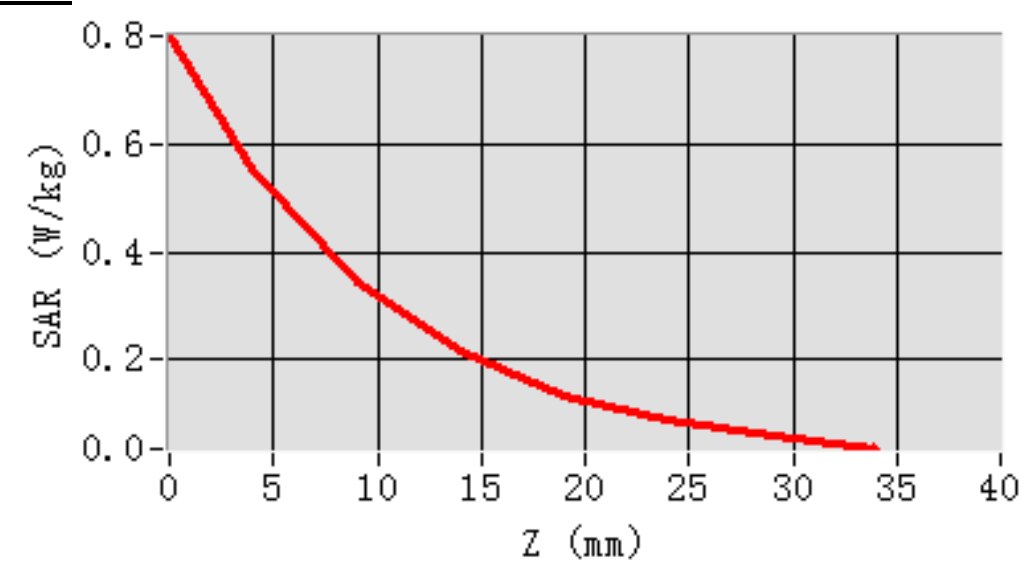

**MEAS. 6 Body Plane with Front Side 10mm on Low Channel in WCDMA Band 2 mode**

**Test Date:** 7/2/2020  
**Measurement duration:** 11 minutes 47 seconds  
**Signal:** WCDMA, f=1852.4 MHz, Duty Cycle: 1:1.0  
**Liquid Parameters:** Permittivity: 40.66; Conductivity: 1.38 S/m  
**Test condition:** Ambient Temperature: 22.9°C, Liquid Temperature: 21.5°C  
**Probe:** SN 34/15 SSE2 EPGO265, ConvF: 2.46  
**Area Scan:** sam\_direct\_droit2\_surf10mm.txt, h= 5.00 mm  
**Zoom Scan:** 5x5x7,dx=8mm, dy=8mm, dz=5mm,Complete  
**Maximum location:** X=0.000000, Y=-42.000000  
**SAR 10g (W/Kg):** 0.587431  
**SAR 1g (W/Kg):** 1.062752  
**Power drift (%):** -0.67  
**3D screen shot**

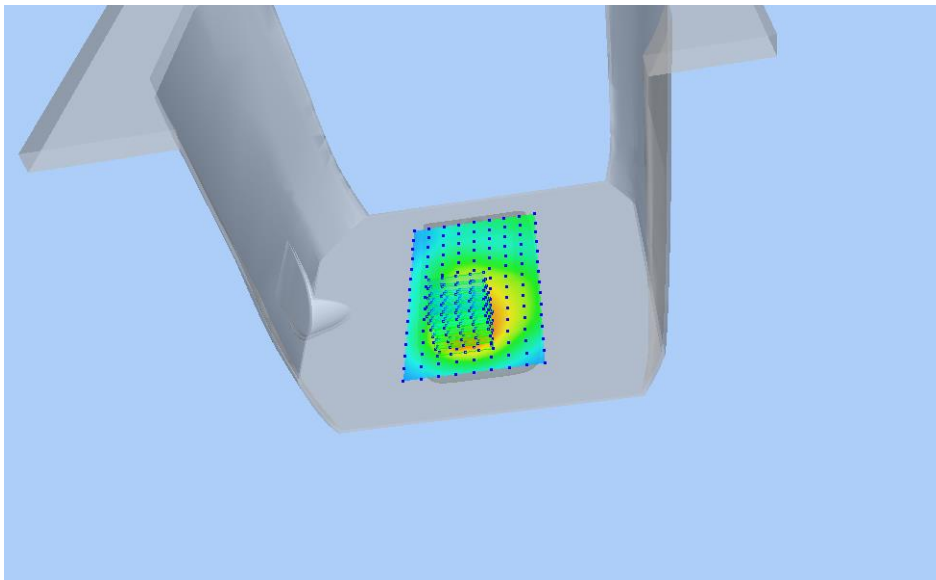

**Z Axis Scan**

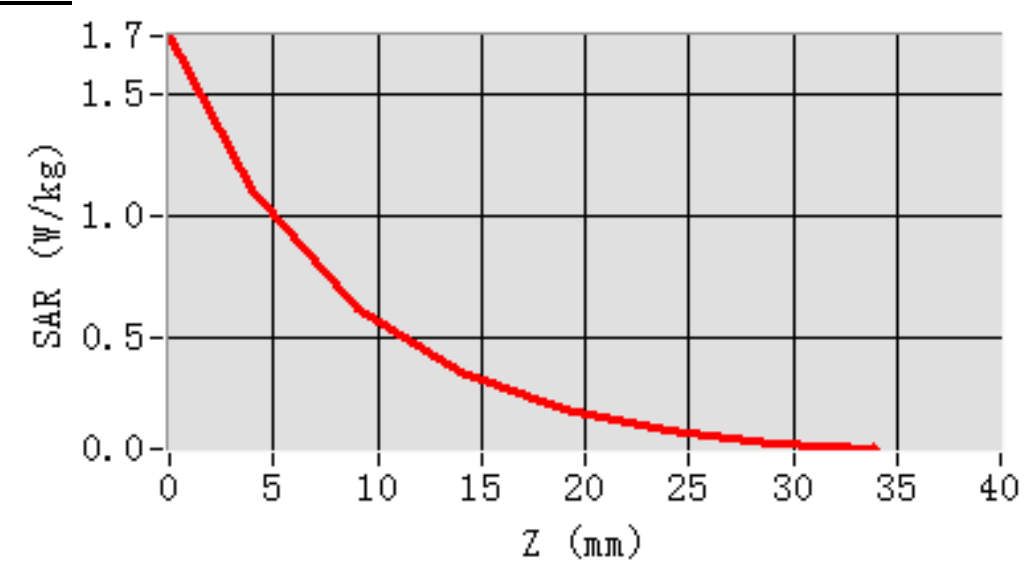

**MEAS. 7 Left Head with Cheek on High Channel in WCDMA Band 4 mode**

**Test Date:** 6/2/2020  
**Measurement duration:** 11 minutes 28 seconds  
**Signal:** WCDMA, f=1752.6 MHz, Duty Cycle: 1:1.0  
**Liquid Parameters:** Permittivity: 40.44; Conductivity: 1.36 S/m  
**Test condition:** Ambient Temperature: 22.8°C, Liquid Temperature: 21.3°C  
**Probe:** SN 34/15 SSE2 EPGO265, ConvF: 2.18  
**Area Scan:** sam\_direct\_droit2\_surf10mm.txt, h= 5.00 mm  
**Zoom Scan:** 5x5x7,dx=8mm, dy=8mm, dz=5mm,Complete  
**Maximum location:** X=-46.000000, Y=-46.000000  
**SAR 10g (W/Kg):** 0.404980  
**SAR 1g (W/Kg):** 0.685908  
**Power drift (%):** -3.64  
**3D screen shot**

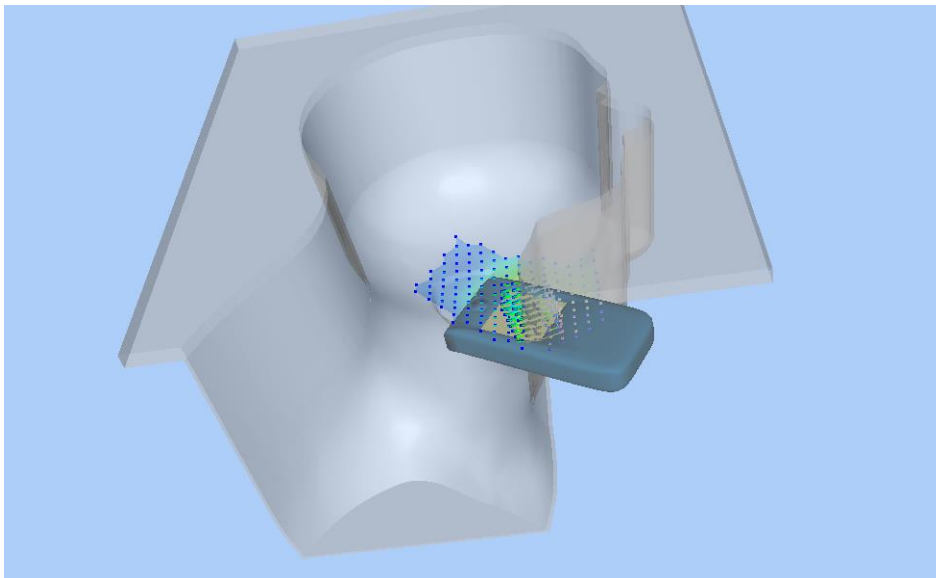

**Z Axis Scan**

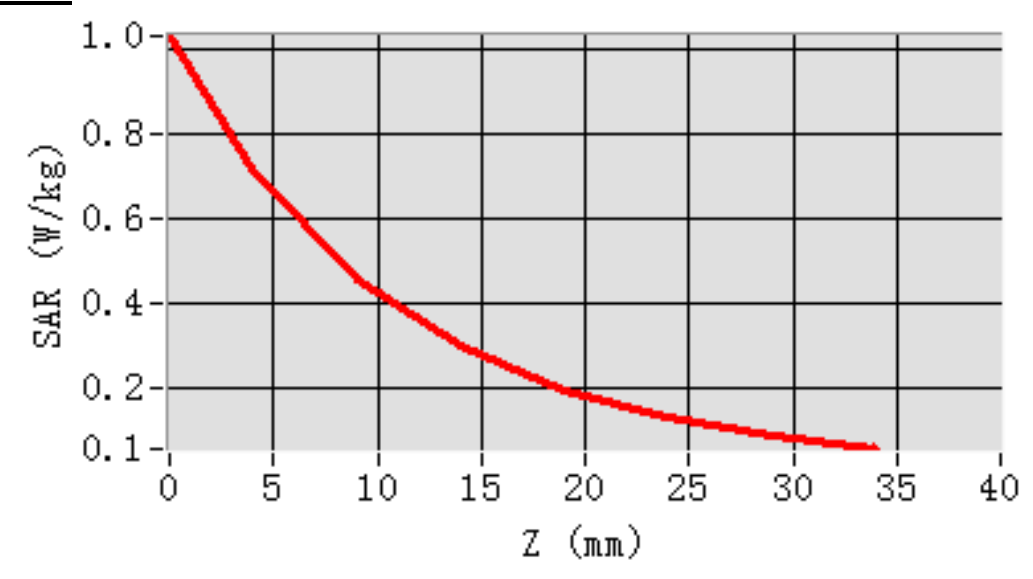



**MEAS. 8 Body Plane with Front Side 10mm on Middle Channel in WCDMA Band 4 mode**

**Test Date:** 6/2/2020  
**Measurement duration:** 11 minutes 54 seconds  
**Signal:** WCDMA, f=1732.4 MHz, Duty Cycle: 1:1.0  
**Liquid Parameters:** Permittivity: 40.67; Conductivity: 1.34 S/m  
**Test condition:** Ambient Temperature: 22.8°C, Liquid Temperature: 21.3°C  
**Probe:** SN 34/15 SSE2 EPGO265, ConvF: 2.18  
**Area Scan:** sam\_direct\_droit2\_surf10mm.txt, h= 5.00 mm  
**Zoom Scan:** 5x5x7,dx=8mm, dy=8mm, dz=5mm,Complete  
**Maximum location:** X=0.000000, Y=-32.000000  
**SAR 10g (W/Kg):** 0.616104  
**SAR 1g (W/Kg):** 1.084845  
**Power drift (%):** -0.94  
**3D screen shot**

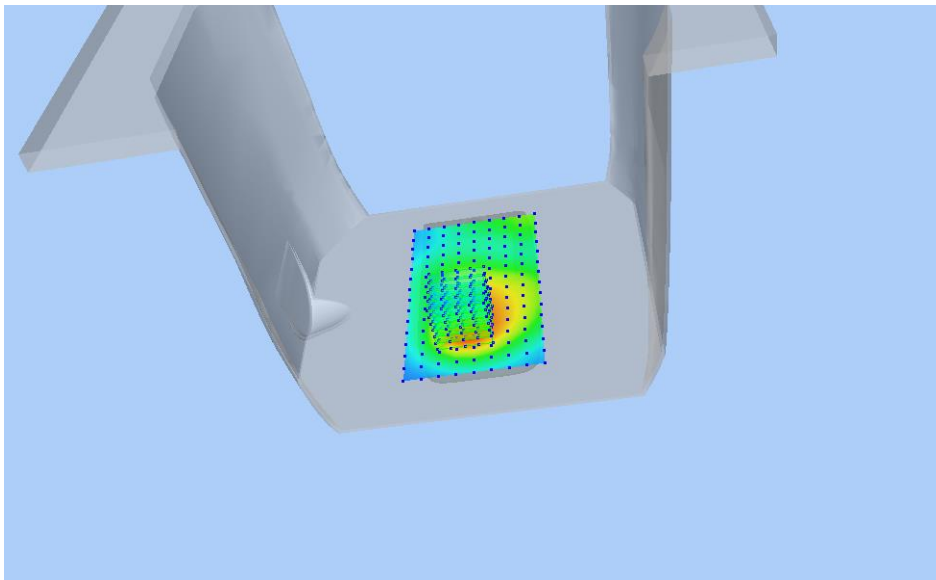

**Z Axis Scan**

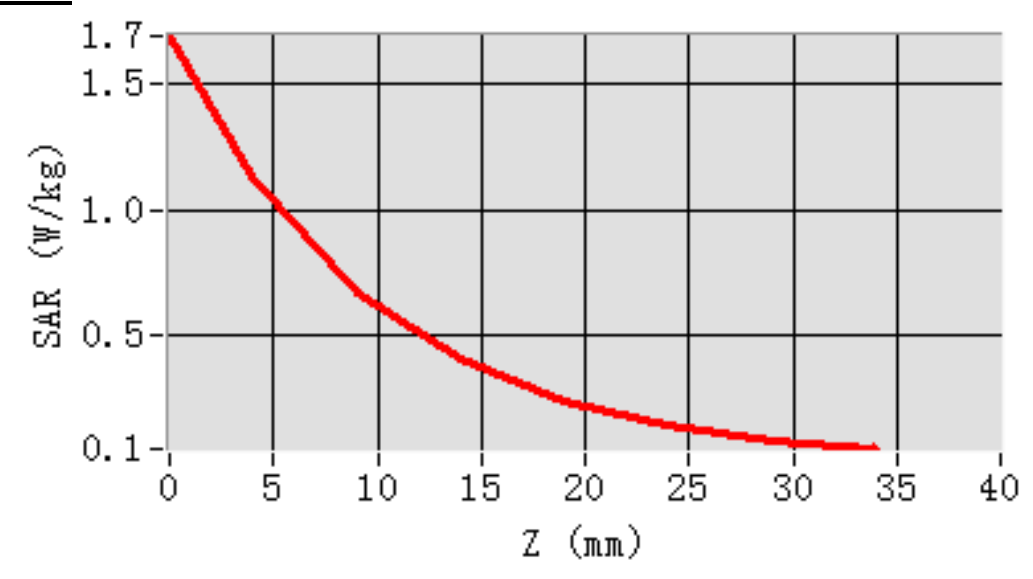

**MEAS. 9 Right Head with Cheek on High Channel in WCDMA Band 5 mode**

**Test Date:** 20/1/2020  
**Measurement duration:** 11 minutes 38 seconds  
**Signal:** WCDMA, f=846.6 MHz, Duty Cycle: 1:1.0  
**Liquid Parameters:** Permittivity: 41.61; Conductivity: 0.91 S/m  
**Test condition:** Ambient Temperature: 22.7°C, Liquid Temperature: 21.4°C  
**Probe:** SN 34/15 SSE2 EPGO265, ConvF: 1.93  
**Area Scan:** sam\_direct\_droit2\_surf10mm.txt, h= 5.00 mm  
**Zoom Scan:** 5x5x7,dx=8mm, dy=8mm, dz=5mm,Complete  
**Maximum location:** X=-46.000000, Y=-36.000000  
**SAR 10g (W/Kg):** 0.189177  
**SAR 1g (W/Kg):** 0.245384  
**Power drift (%):** 1.36  
**3D screen shot**

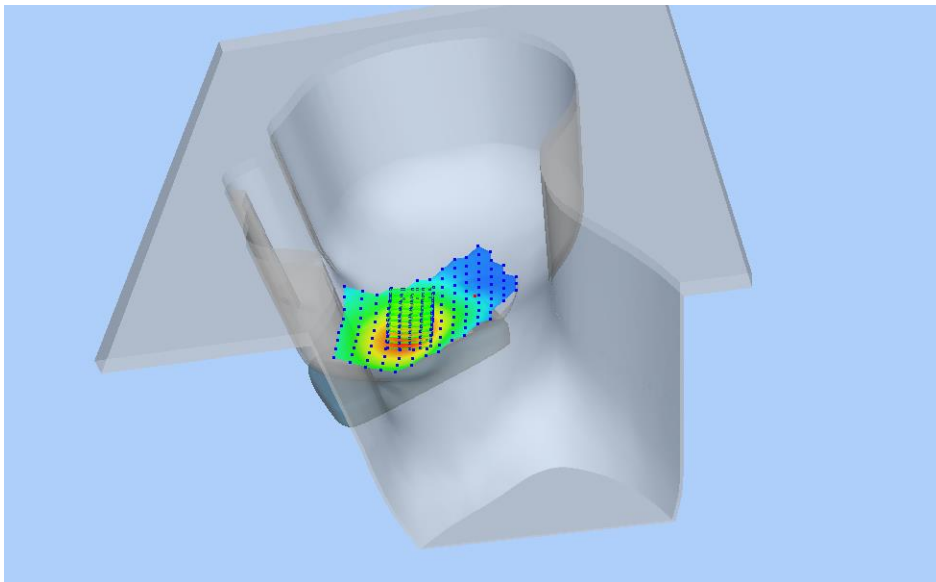

**Z Axis Scan**

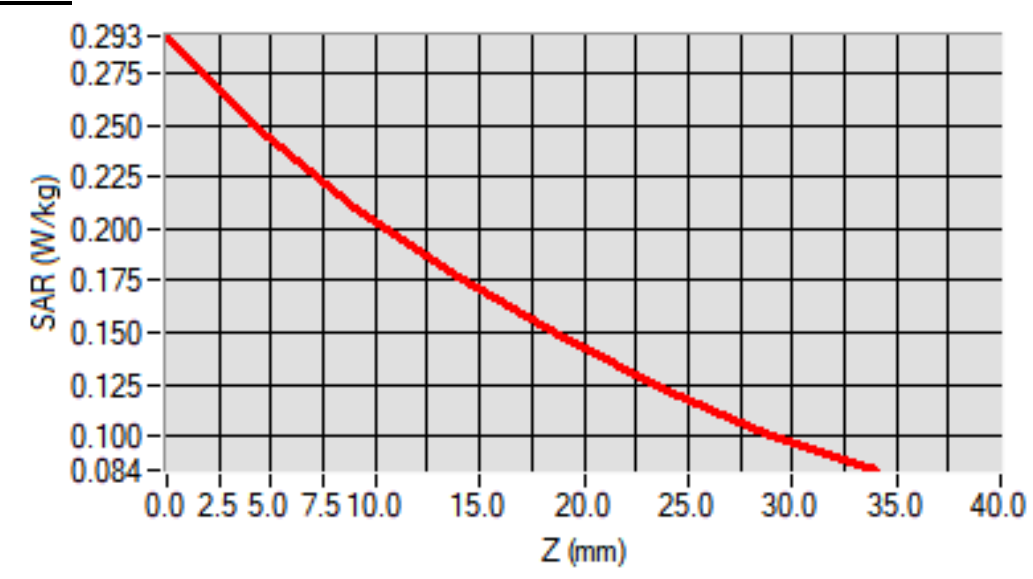

**MEAS. 10 Body Plane with Front Side 10mm on High Channel in WCDMA Band 5 mode**

**Test Date:** 20/1/2020  
**Measurement duration:** 11 minutes 14 seconds  
**Signal:** WCDMA, f=846.6 MHz, Duty Cycle: 1:1.0  
**Liquid Parameters:** Permittivity: 41.61; Conductivity: 0.91 S/m  
**Test condition:** Ambient Temperature: 22.7°C, Liquid Temperature: 21.4°C  
**Probe:** SN 34/15 SSE2 EPGO265, ConvF: 1.93  
**Area Scan:** sam\_direct\_droit2\_surf10mm.txt, h= 5.00 mm  
**Zoom Scan:** 5x5x7,dx=8mm, dy=8mm, dz=5mm,Complete  
**Maximum location:** X=-10.000000, Y=-12.000000  
**SAR 10g (W/Kg):** 0.231091  
**SAR 1g (W/Kg):** 0.331338  
**Power drift (%):** -0.83  
**3D screen shot**

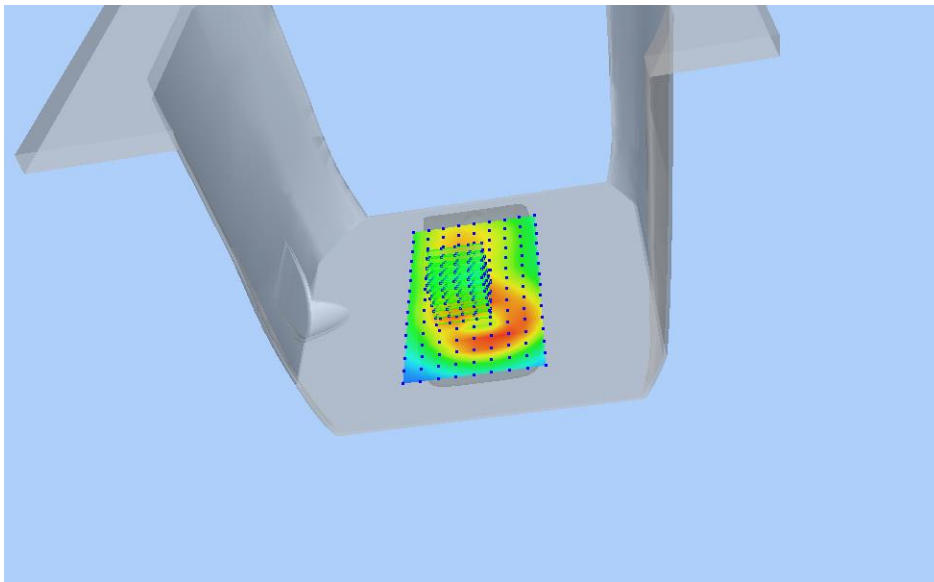

**Z Axis Scan**

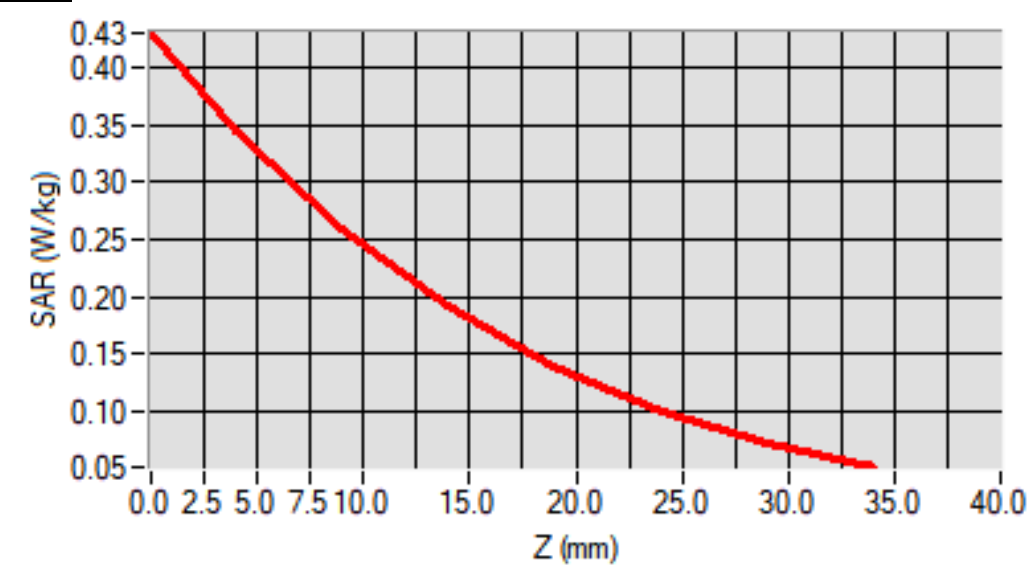

**MEAS. 11 Left Head with Cheek on Low Channel in LTE Band 2 mode with 1RB**

**Test Date:** 7/2/2020  
**Measurement duration:** 12 minutes 20 seconds  
**Signal:** LTE, f=1860.0 MHz, Duty Cycle: 1:1.0  
**Liquid Parameters:** Permittivity: 40.51; Conductivity: 1.38 S/m  
**Test condition:** Ambient Temperature: 22.9°C, Liquid Temperature: 21.5°C  
**Probe:** SN 34/15 SSE2 EPGO265, ConvF: 2.46  
**Area Scan:** sam\_direct\_droit2\_surf10mm.txt, h= 5.00 mm  
**Zoom Scan:** 5x5x7,dx=8mm, dy=8mm, dz=5mm,Complete  
**Maximum location:** X=-56.000000, Y=-56.000000  
**SAR 10g (W/Kg):** 0.298807  
**SAR 1g (W/Kg):** 0.525062  
**Power drift (%):** 3.40  
**3D screen shot**

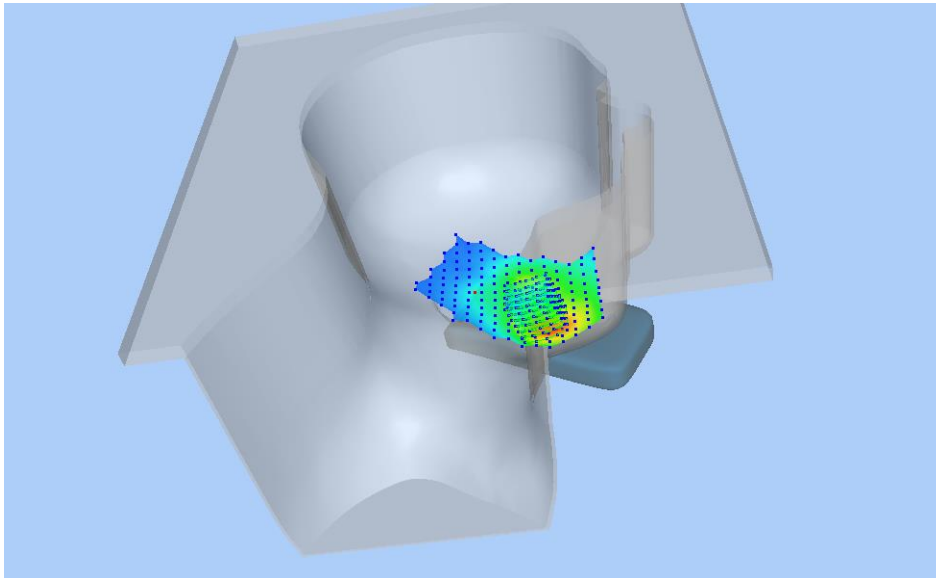

**Z Axis Scan**

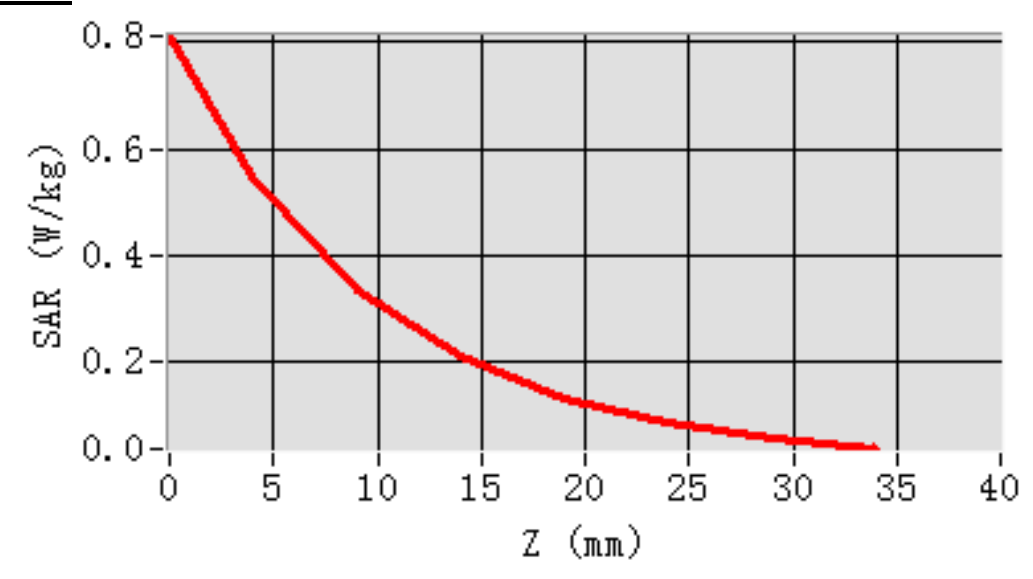

**MEAS. 12 Body Plane with Front Side 10mm on Low Channel in LTE Band 2 mode with 1RB**

**Test Date:** 7/2/2020  
**Measurement duration:** 11 minutes 3 seconds  
**Signal:** LTE, f=1860.0 MHz, f=1859.5 MHz, Duty Cycle: 1:1.0  
**Liquid Parameters:** Permittivity: 40.51; Conductivity: 1.38 S/m  
**Test condition:** Ambient Temperature: 22.9°C, Liquid Temperature: 21.5°C  
**Probe:** SN 34/15 SSE2 EPGO265, ConvF: 2.46  
**Area Scan:** sam\_direct\_droit2\_surf10mm.txt, h= 5.00 mm  
**Zoom Scan:** 5x5x7,dx=8mm, dy=8mm, dz=5mm,Complete  
**Maximum location:** X=-10.000000, Y=-72.000000  
**SAR 10g (W/Kg):** 0.573161  
**SAR 1g (W/Kg):** 1.036907  
**Power drift (%):** -0.19  
**3D screen shot**

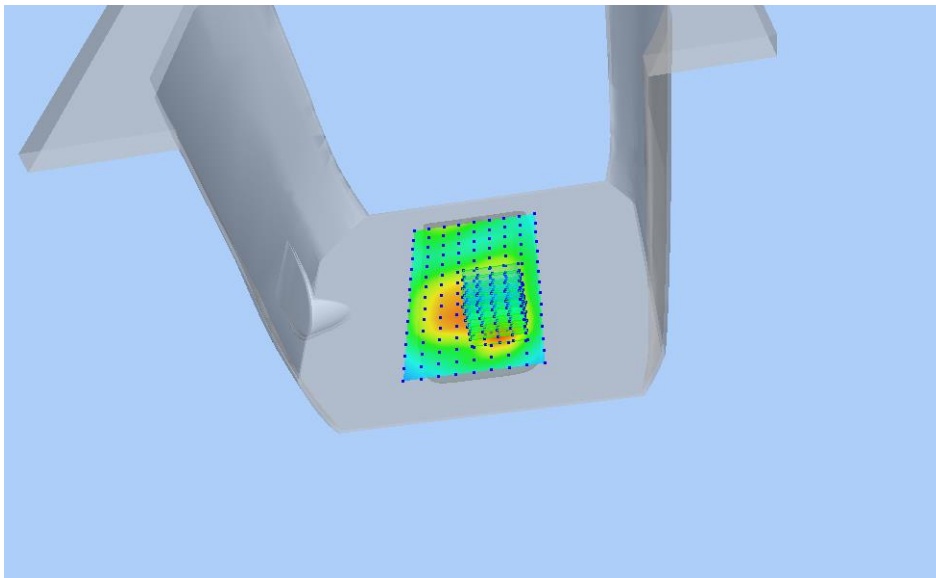

**Z Axis Scan**

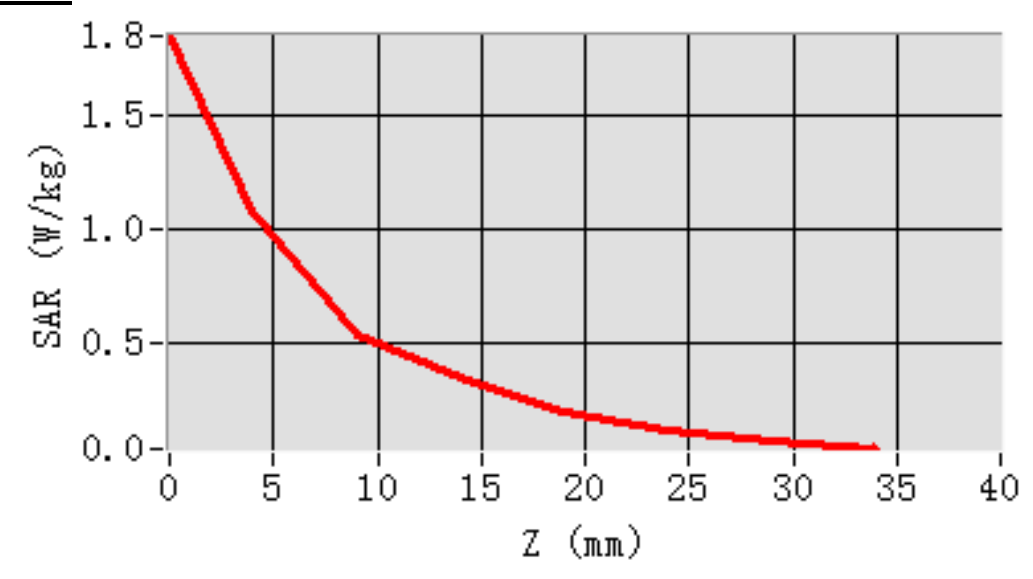

**MEAS. 13 Left Head with Cheek on Middle Channel in LTE Band 4 mode with 1RB**

**Test Date:** 6/2/2020  
**Measurement duration:** 11 minutes 49 seconds  
**Signal:** LTE, f=1732.5 MHz, Duty Cycle: 1:1.0  
**Liquid Parameters:** Permittivity: 40.67; Conductivity: 1.34 S/m  
**Test condition:** Ambient Temperature: 22.8°C, Liquid Temperature: 21.3°C  
**Probe:** SN 34/15 SSE2 EPGO265, ConvF: 2.18  
**Area Scan:** sam\_direct\_droit2\_surf10mm.txt, h= 5.00 mm  
**Zoom Scan:** 5x5x7,dx=8mm, dy=8mm, dz=5mm,Complete  
**Maximum location:** X=-46.000000, Y=-46.000000  
**SAR 10g (W/Kg):** 0.320942  
**SAR 1g (W/Kg):** 0.542634  
**Power drift (%):** -0.41  
**3D screen shot**

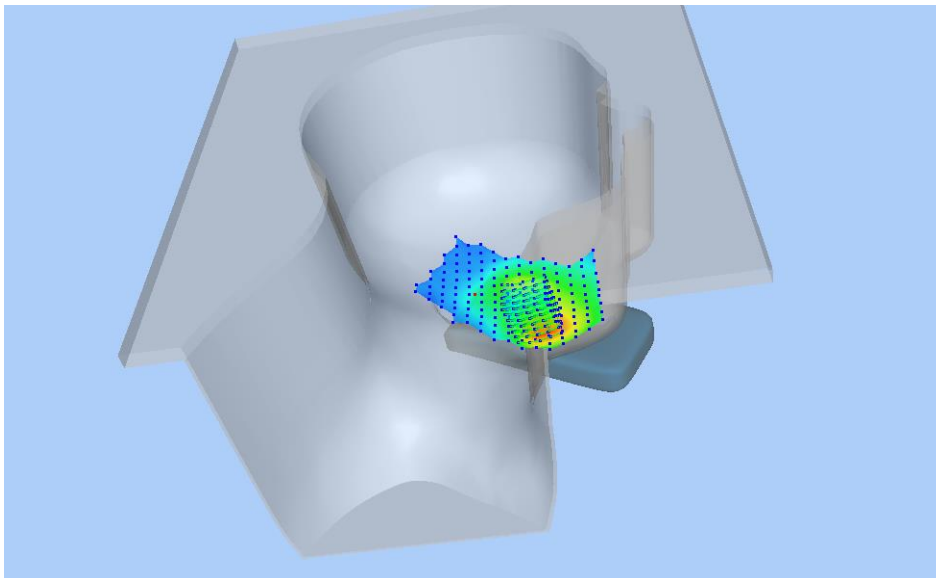

**Z Axis Scan**

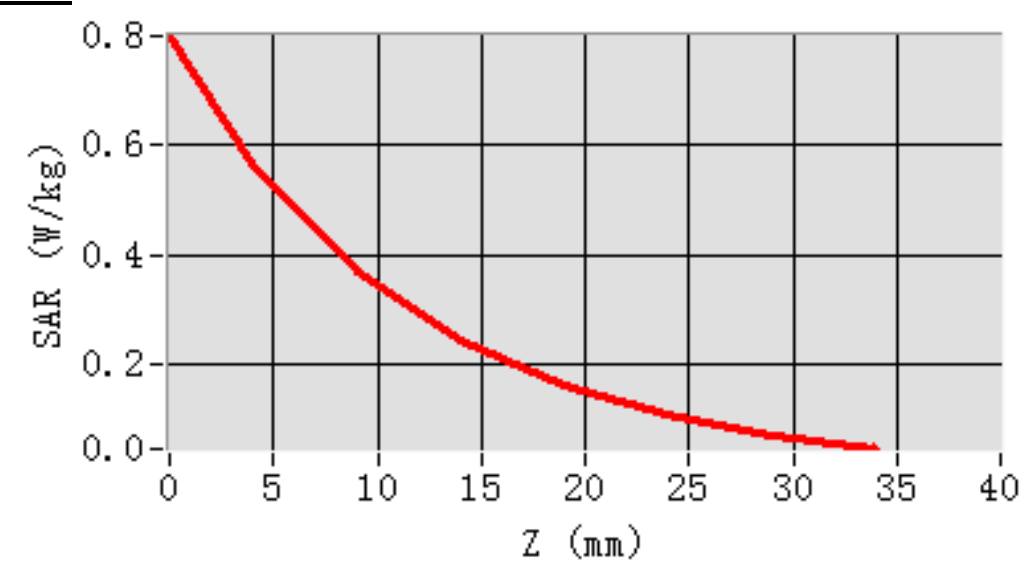

**MEAS. 14 Body Plane with Front Side 10mm on High Channel in LTE Band 4 mode with 1RB**

**Test Date:** 6/2/2020  
**Measurement duration:** 11 minutes 58 seconds  
**Signal:** LTE, f=1745.0 MHz, Duty Cycle: 1:1.0  
**Liquid Parameters:** Permittivity: 40.52; Conductivity: 1.35 S/m  
**Test condition:** Ambient Temperature: 22.8°C, Liquid Temperature: 21.3°C  
**Probe:** SN 34/15 SSE2 EPGO265, ConvF: 2.18  
**Area Scan:** sam\_direct\_droit2\_surf10mm.txt, h= 5.00 mm  
**Zoom Scan:** 5x5x7,dx=8mm, dy=8mm, dz=5mm,Complete  
**Maximum location:** X=0.000000, Y=-32.000000  
**SAR 10g (W/Kg):** 0.586614  
**SAR 1g (W/Kg):** 1.030313  
**Power drift (%):** -0.73  
**3D screen shot**

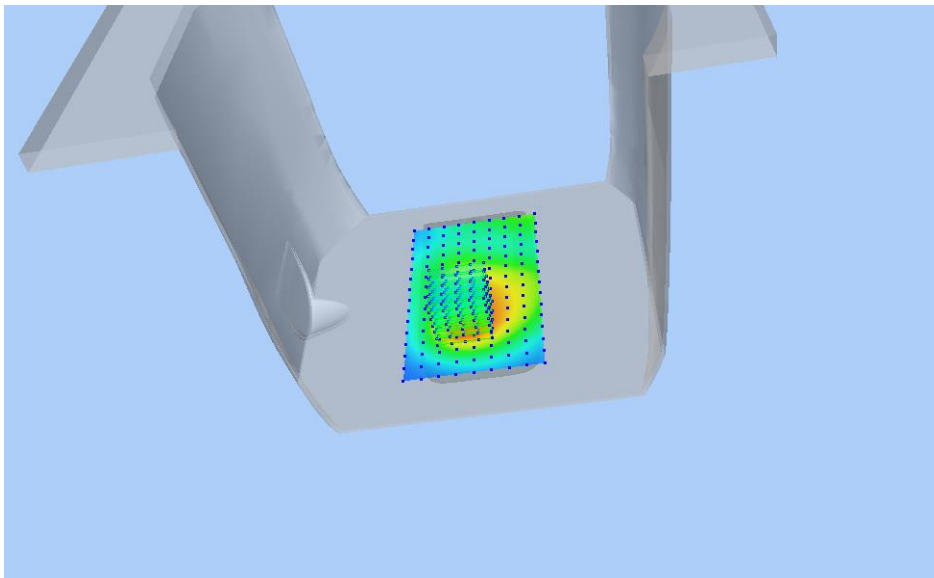

**Z Axis Scan**

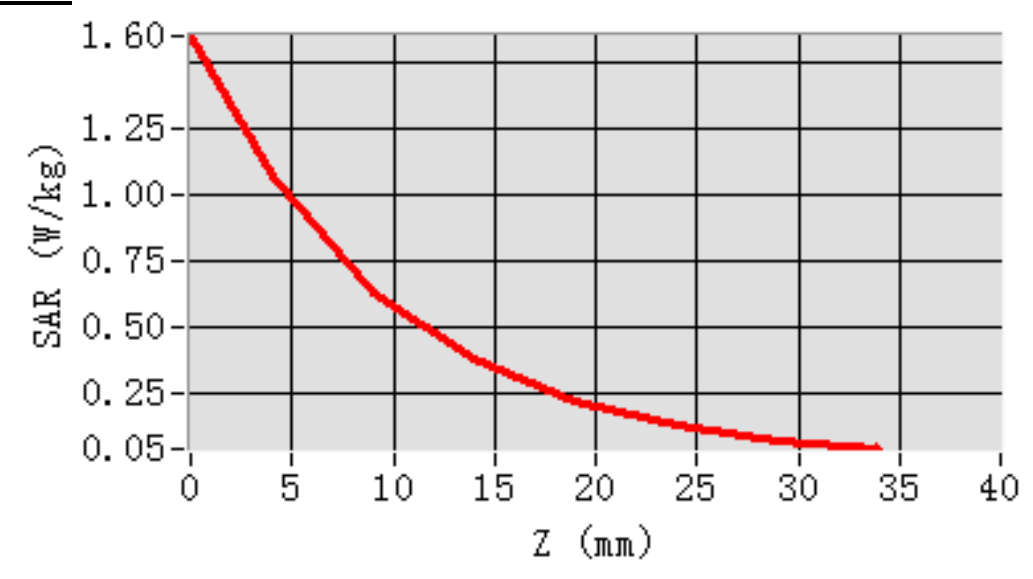

**MEAS. 15 Right Head with Cheek on High Channel in LTE Band 5 mode with 1RB**

**Test Date:** 20/1/2020  
**Measurement duration:** 11 minutes 40 seconds  
**Signal:** LTE, f=844.0 MHz, Duty Cycle: 1:1.0  
**Liquid Parameters:** Permittivity: 41.65; Conductivity: 0.91 S/m  
**Test condition:** Ambient Temperature: 22.7°C, Liquid Temperature: 21.4°C  
**Probe:** SN 34/15 SSE2 EPGO265, ConvF: 1.93  
**Area Scan:** sam\_direct\_droit2\_surf10mm.txt, h= 5.00 mm  
**Zoom Scan:** 5x5x7,dx=8mm, dy=8mm, dz=5mm,Complete  
**Maximum location:** X=-46.000000, Y=-36.000000  
**SAR 10g (W/Kg):** 0.294828  
**SAR 1g (W/Kg):** 0.380806  
**Power drift (%):** -0.96  
**3D screen shot**

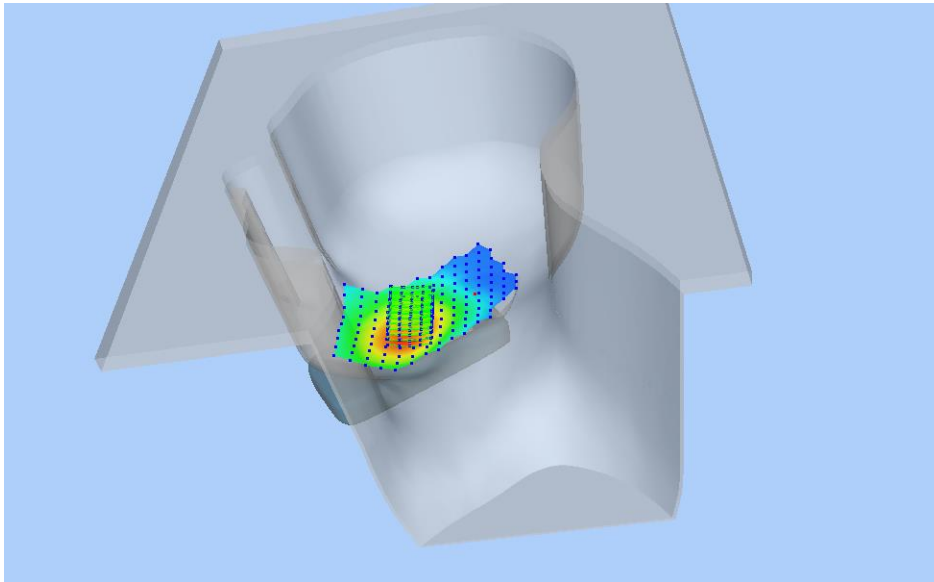

**Z Axis Scan**

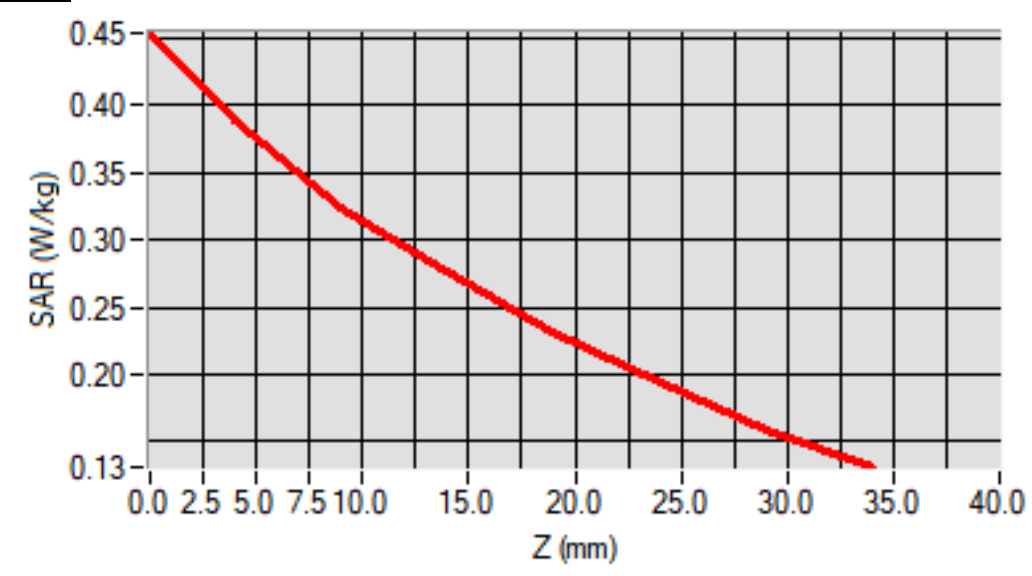



**MEAS. 16 Body Plane with Back Side 10mm on High Channel in LTE Band 5 mode with 1RB**

**Test Date:** 20/1/2020  
**Measurement duration:** 11 minutes 5 seconds  
**Signal:** LTE, f=844.0 MHz, Duty Cycle: 1:1.0  
**Liquid Parameters:** Permittivity: 41.65; Conductivity: 0.91 S/m  
**Test condition:** Ambient Temperature: 22.7°C, Liquid Temperature: 21.4°C  
**Probe:** SN 34/15 SSE2 EPGO265, ConvF: 1.93  
**Area Scan:** sam\_direct\_droit2\_surf10mm.txt, h= 5.00 mm  
**Zoom Scan:** 5x5x7,dx=8mm, dy=8mm, dz=5mm,Complete  
**Maximum location:** X=-10.000000, Y=-22.000000  
**SAR 10g (W/Kg):** 0.291377  
**SAR 1g (W/Kg):** 0.415768  
**Power drift (%):** -0.20  
**3D screen shot**

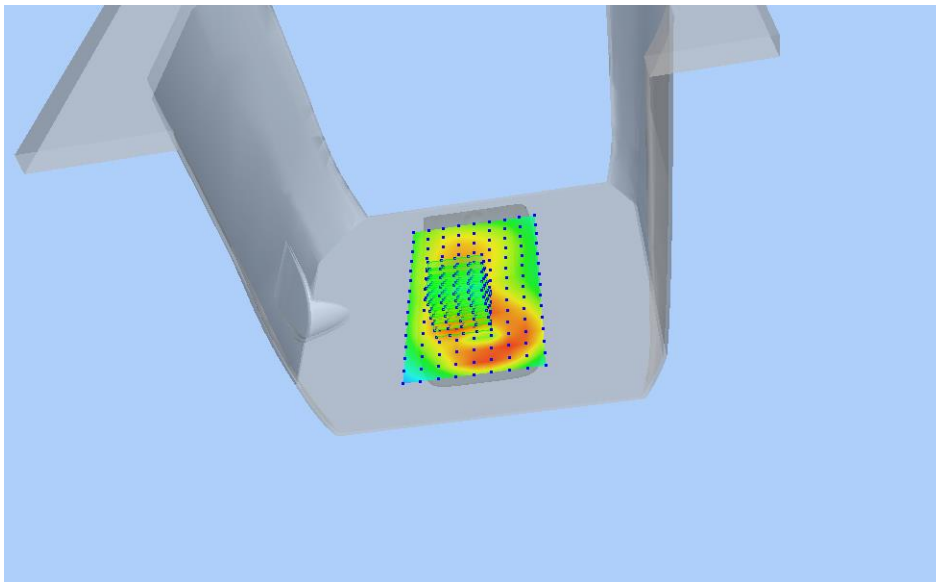

**Z Axis Scan**

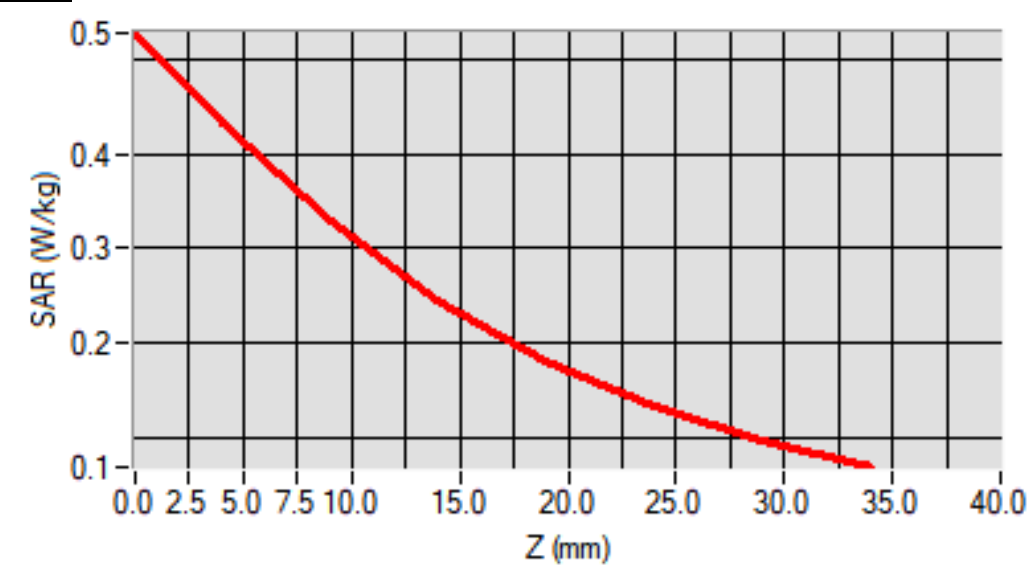

**MEAS. 17 Left Head with Cheek on Low Channel in LTE Band 7 mode with 1RB**

**Test Date:** 22/1/2020  
**Measurement duration:** 16 minutes 6 seconds  
**Signal:** LTE, f=2510.0 MHz, Duty Cycle: 1:1.0  
**Liquid Parameters:** Permittivity: 39.73; Conductivity: 1.84 S/m  
**Test condition:** Ambient Temperature: 22.5°C, Liquid Temperature: 21.2°C  
**Probe:** SN 34/15 SSE2 EPGO265, ConvF: 2.38  
**Area Scan:** sam\_direct\_droit2\_surf10mm.txt, h= 5.00 mm  
**Zoom Scan:** 7x7x7,dx=5mm, dy=5mm, dz=5mm,Complete  
**Maximum location:** X=-46.000000, Y=-46.000000  
**SAR 10g (W/Kg):** 0.062786  
**SAR 1g (W/Kg):** 0.121648  
**Power drift (%):** -1.07  
**3D screen shot**

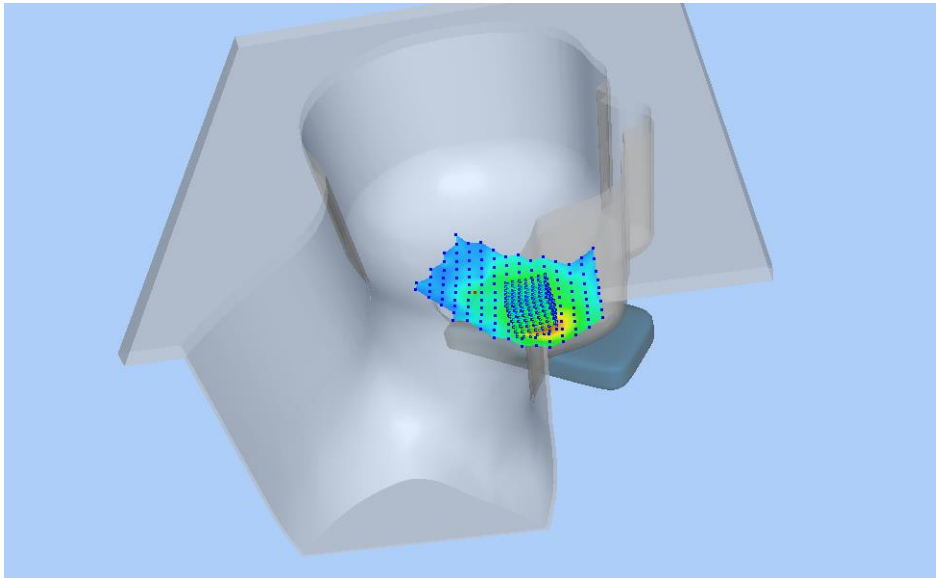

**Z Axis Scan**

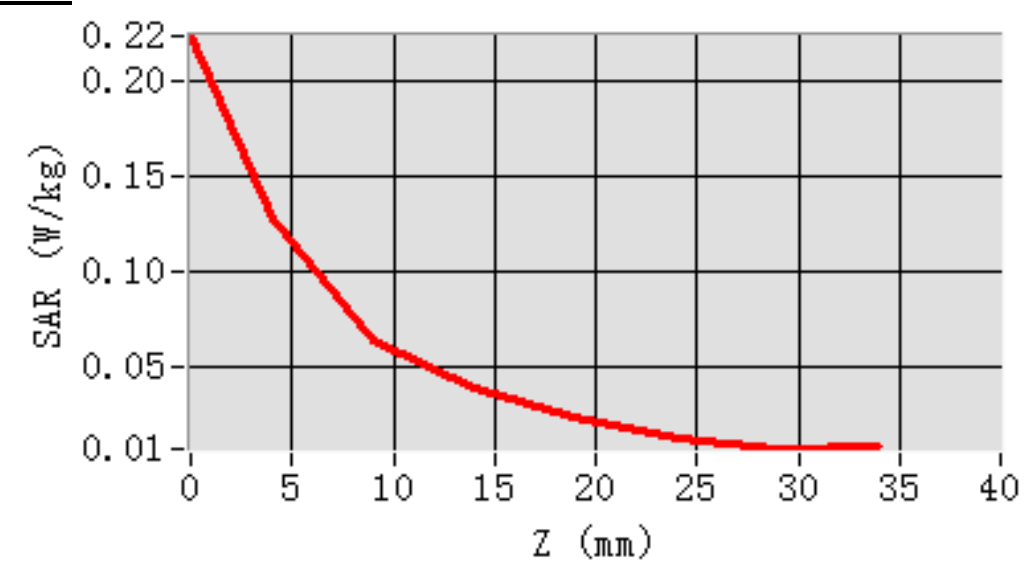

**MEAS. 18 Body Plane with Bottom Edge 10mm on Low Channel in LTE Band 7 mode with 1RB**

**Test Date:** 22/1/2020  
**Measurement duration:** 19 minutes 4 seconds  
**Signal:** LTE, f=2510.0 MHz, Duty Cycle: 1:1.0  
**Liquid Parameters:** Permittivity: 39.73; Conductivity: 1.84 S/m  
**Test condition:** Ambient Temperature: 22.5°C, Liquid Temperature: 21.2°C  
**Probe:** SN 34/15 SSE2 EPGO265, ConvF: 2.38  
**Area Scan:** sam\_direct\_droit2\_surf10mm.txt, h= 5.00 mm  
**Zoom Scan:** 7x7x7,dx=5mm, dy=5mm, dz=5mm,Complete  
**Maximum location:** X=10.000000, Y=-12.000000  
**SAR 10g (W/Kg):** 0.496899  
**SAR 1g (W/Kg):** 1.054043  
**Power drift (%):** 1.44  
**3D screen shot**

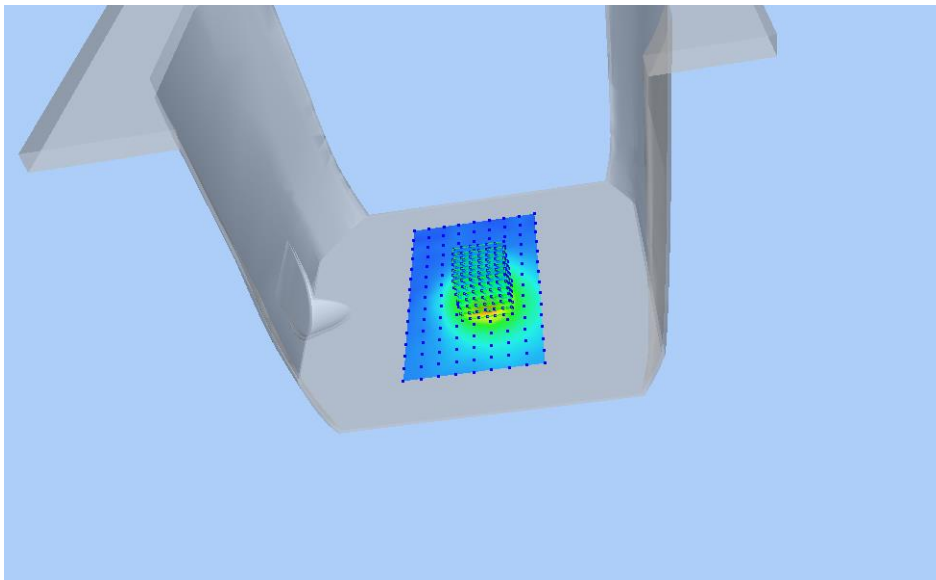

**Z Axis Scan**

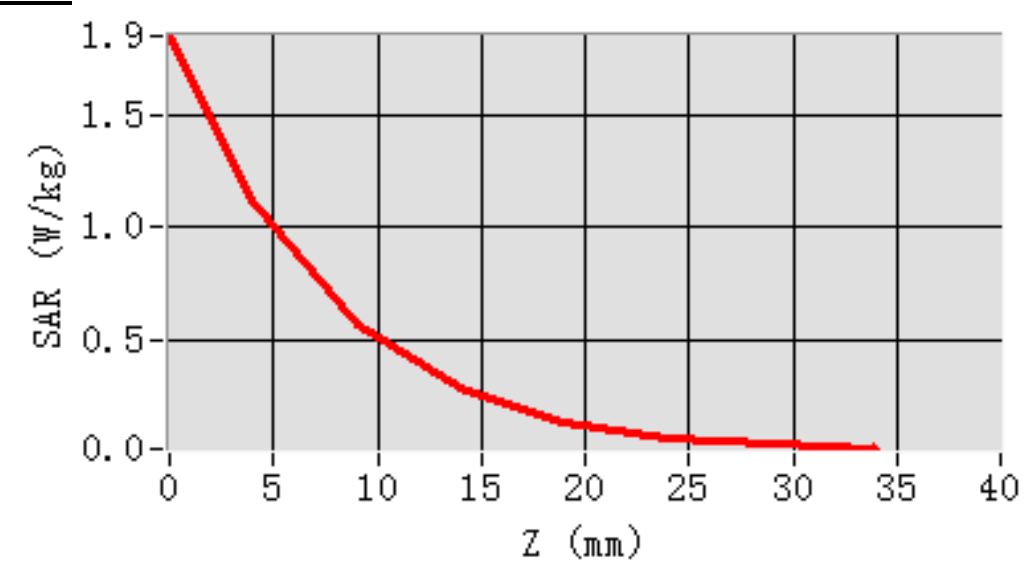

**MEAS. 19 Right Head with Cheek on Middle Channel in LTE Band 12 mode with 1RB**

**Test Date:** 18/1/2020  
**Measurement duration:** 12 minutes 19 seconds  
**Signal:** LTE, f=711.0 MHz, Duty Cycle: 1:1.0  
**Liquid Parameters:** Permittivity: 42.58; Conductivity: 0.88 S/m  
**Test condition:** Ambient Temperature: 22.6°C, Liquid Temperature: 21.3°C  
**Probe:** SN 34/15 SSE2 EPGO265, ConvF: 1.89  
**Area Scan:** sam\_direct\_droit2\_surf10mm.txt, h= 5.00 mm  
**Zoom Scan:** 5x5x7,dx=8mm, dy=8mm, dz=5mm,Complete  
**Maximum location:** X=-56.000000, Y=-36.000000  
**SAR 10g (W/Kg):** 0.253007  
**SAR 1g (W/Kg):** 0.300410  
**Power drift (%):** -0.26  
**3D screen shot**

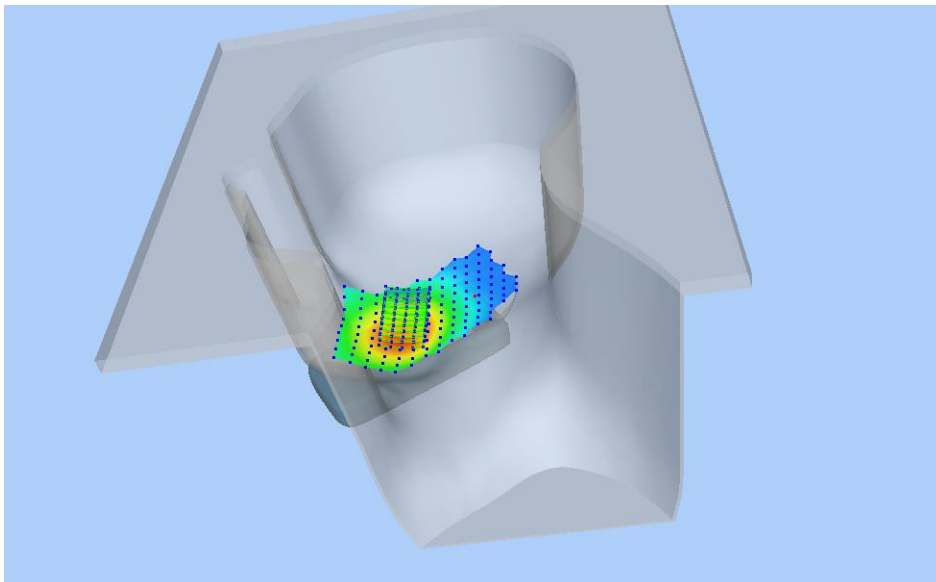

**Z Axis Scan**

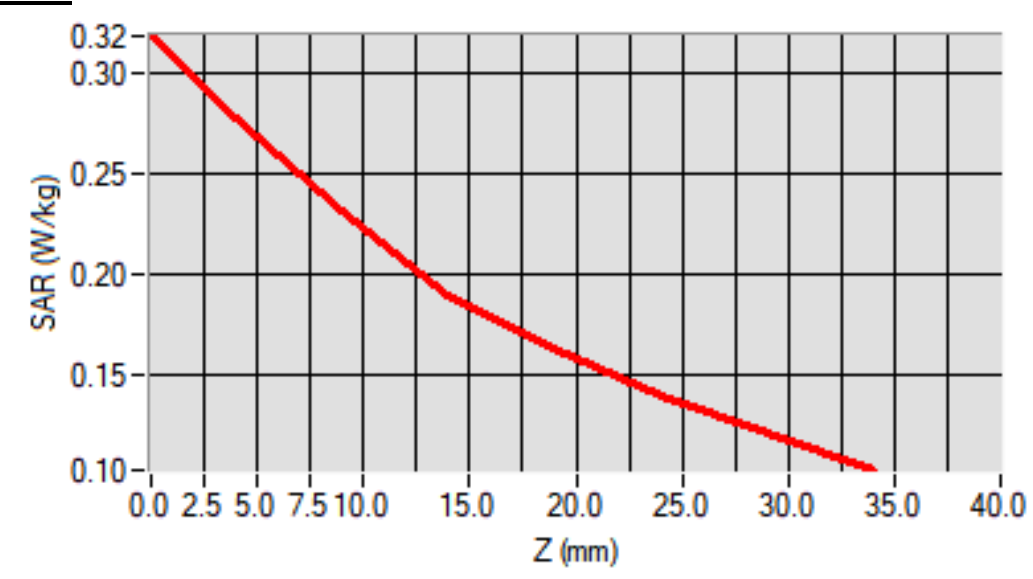

**MEAS. 20 Body Plane with Back Side 10mm on Middle Channel in LTE Band 12 mode with 1RB**

**Test Date:** 18/1/2020  
**Measurement duration:** 12 minutes 49 seconds  
**Signal:** LTE, f=711.0 MHz, Duty Cycle: 1:1.0  
**Liquid Parameters:** Permittivity: 42.58; Conductivity: 0.88 S/m  
**Test condition:** Ambient Temperature: 22.6°C, Liquid Temperature: 21.3°C  
**Probe:** SN 34/15 SSE2 EPGO265, ConvF: 1.89  
**Area Scan:** sam\_direct\_droit2\_surf10mm.txt, h= 5.00 mm  
**Zoom Scan:** 5x5x7,dx=8mm, dy=8mm, dz=5mm,Complete  
**Maximum location:** X=0.000000, Y=-2.000000  
**SAR 10g (W/Kg):** 0.448920  
**SAR 1g (W/Kg):** 0.561145  
**Power drift (%):** -0.40  
**3D screen shot**

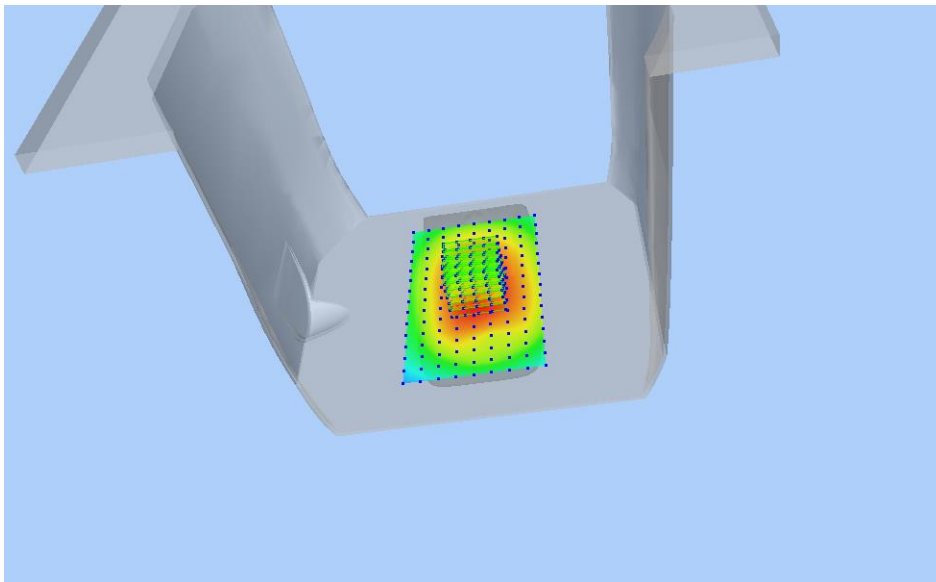

**Z Axis Scan**

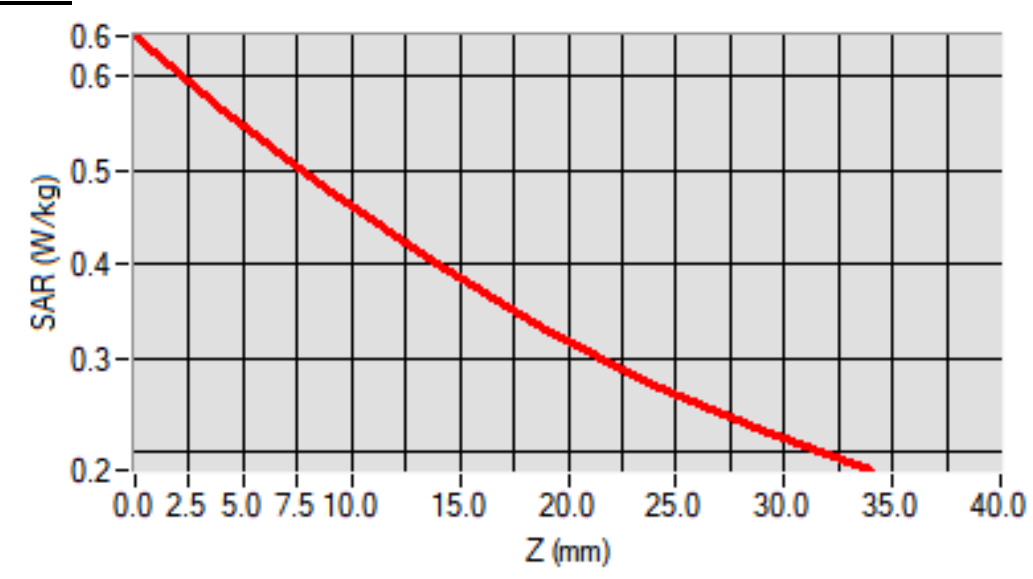

**MEAS. 21 Right Head with Cheek on Low Channel in IEEE 802.b mode**

**Test Date:** 21/1/2020  
**Measurement duration:** 14 minutes 15 seconds  
**Signal:** WLAN, f=2412.0 MHz, Duty Cycle: 1:1.008  
**Liquid Parameters:** Permittivity: 39.85; Conductivity: 1.75 S/m  
**Test condition:** Ambient Temperature: 22.7°C, Liquid Temperature: 21.3°C  
**Probe:** SN 34/15 SSE2 EPGO265, ConvF: 2.55  
**Area Scan:** sam\_direct\_droit2\_surf10mm.txt, h= 5.00 mm  
**Zoom Scan:** 7x7x7,dx=5mm, dy=5mm, dz=5mm,Complete  
**Maximum location:** X=-26.000000, Y=24.000000  
**SAR 10g (W/Kg):** 0.171614  
**SAR 1g (W/Kg):** 0.393393  
**Power drift (%):** 0.18  
**3D screen shot**

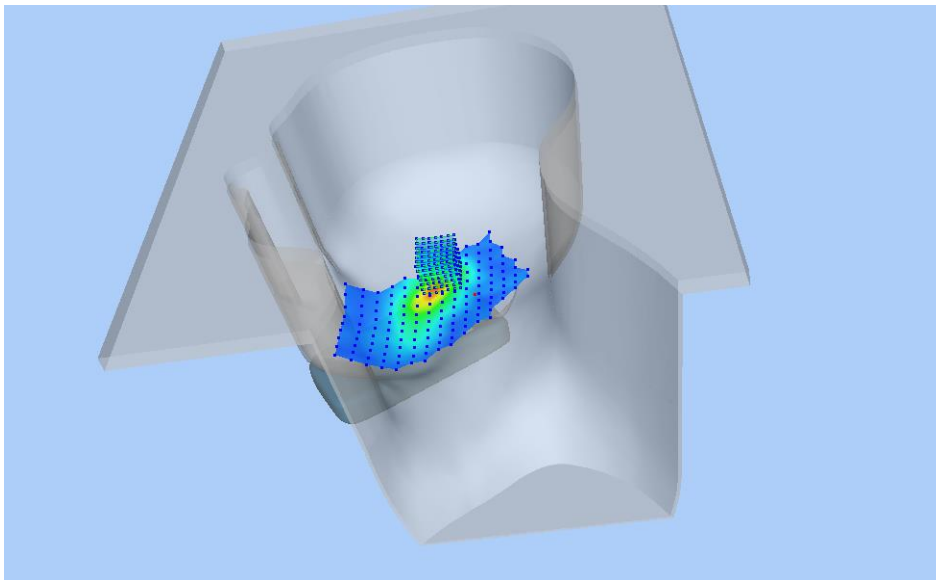

**Z Axis Scan**

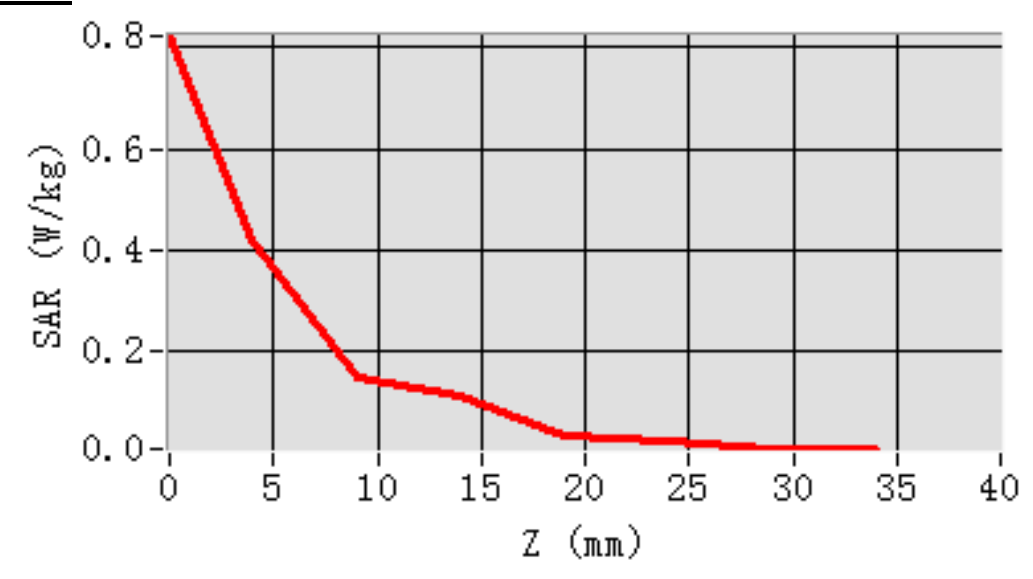

**MEAS. 22 Body Plane with Back Side 10mm on Low Channel in IEEE 802.b mode**

**Test Date:** 21/1/2020  
**Measurement duration:** 18 minutes 27 seconds  
**Signal:** WLAN, f=2412.0 MHz, Duty Cycle: 1:1.008  
**Liquid Parameters:** Permittivity: 39.85; Conductivity: 1.75 S/m  
**Test condition:** Ambient Temperature: 22.7°C, Liquid Temperature: 21.3°C  
**Probe:** SN 34/15 SSE2 EPGO265, ConvF: 2.55  
**Area Scan:** sam\_direct\_droit2\_surf10mm.txt, h= 5.00 mm  
**Zoom Scan:** 7x7x7,dx=5mm, dy=5mm, dz=5mm,Complete  
**Maximum location:** X=0.000000, Y=28.000000  
**SAR 10g (W/Kg):** 0.073922  
**SAR 1g (W/Kg):** 0.153894  
**Power drift (%):** -4.00  
**3D screen shot**

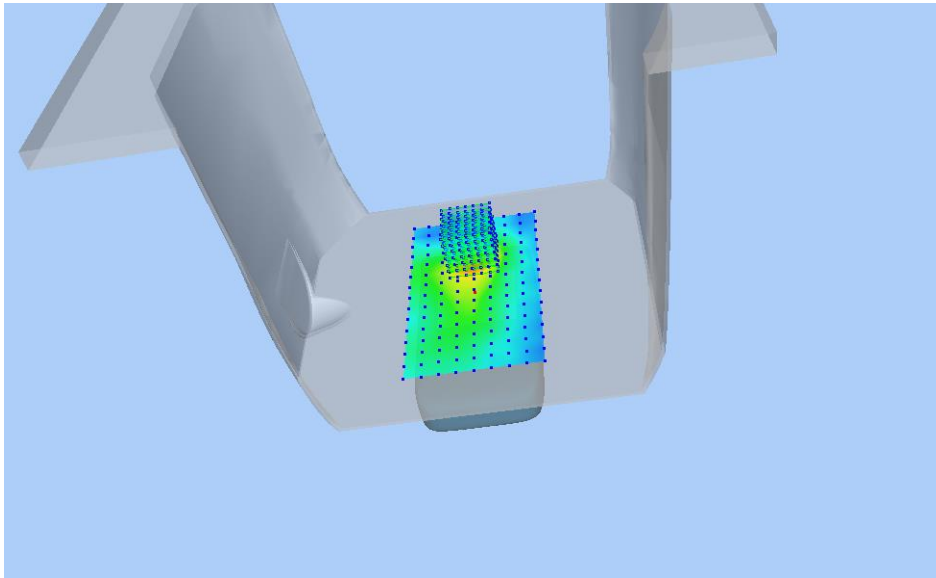

**Z Axis Scan**

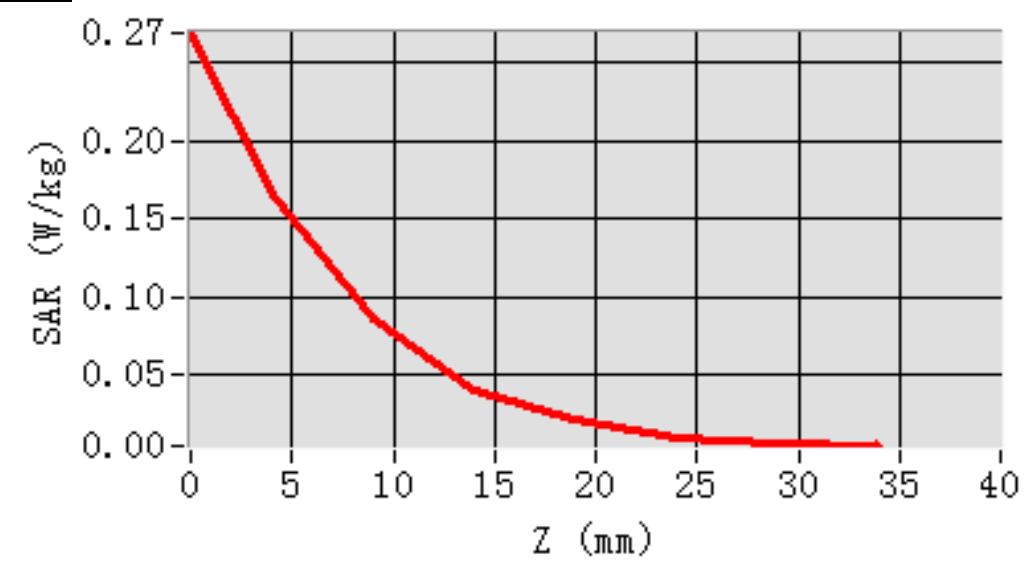

**MEAS. 1 Left Head with Cheek on High Channel in WCDMA Band 4 mode**

**Test Date:** 24/2/2022  
**Measurement duration:** 11 minutes 38 seconds  
**Signal:** LTE, f=1752.6 MHz, Duty Cycle: 1:1.0  
**Liquid Parameters:** Permittivity: 39.17; Conductivity: 1.38 S/m  
**Test condition:** Ambient Temperature: 22.4°C, Liquid Temperature: 21.3°C  
**Probe:** SN 39/21 EPGO359, ConvF: 1.94  
**Area Scan:** sam\_direct\_droit2\_surf10mm.txt, h= 5.00 mm  
**Zoom Scan:** 5x5x7,dx=8mm, dy=8mm, dz=5mm,Complete  
**Maximum location:** X=-56.000000, Y=-56.000000  
**SAR 10g (W/Kg):** 0.321241  
**SAR 1g (W/Kg):** 0.526802  
**Power drift (%):** -4.87  
**3D screen shot**

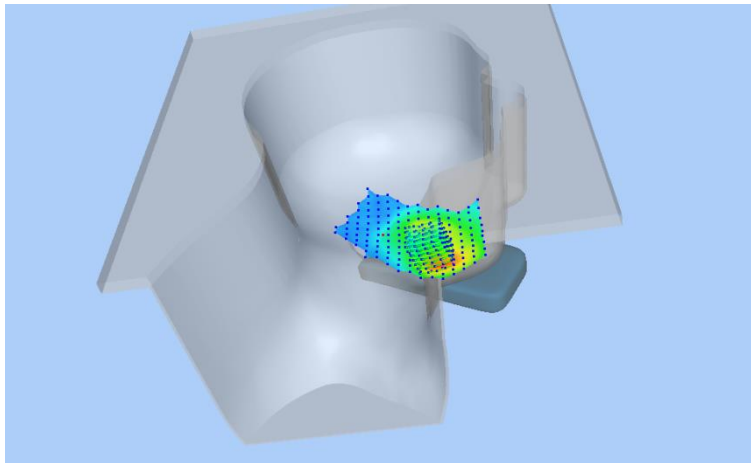

**Z Axis Scan**

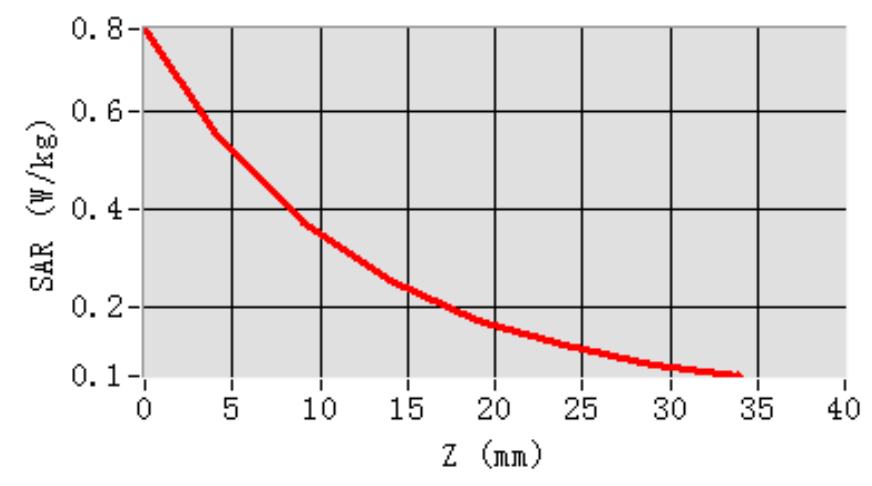



**MEAS. 2 Body Plane with Front Side 10mm on Middle Channel in WCDMA Band 4 mode**

**Test Date:** 24/2/2022  
**Measurement duration:** 12 minutes 26 seconds  
**Signal:** LTE, f=1732.4 MHz, Duty Cycle: 1:1.0  
**Liquid Parameters:** Permittivity: 39.47; Conductivity: 1.36 S/m  
**Test condition:** Ambient Temperature: 22.4°C, Liquid Temperature: 21.3°C  
**Probe:** SN 39/21 EPGO359, ConvF: 1.94  
**Area Scan:** sam\_direct\_droit2\_surf10mm.txt, h= 5.00 mm  
**Zoom Scan:** 5x5x7,dx=8mm, dy=8mm, dz=5mm,Complete  
**Maximum location:** X=0.000000, Y=-12.000000  
**SAR 10g (W/Kg):** 0.457490  
**SAR 1g (W/Kg):** 0.761971  
**Power drift (%):** -1.71  
**3D screen shot**

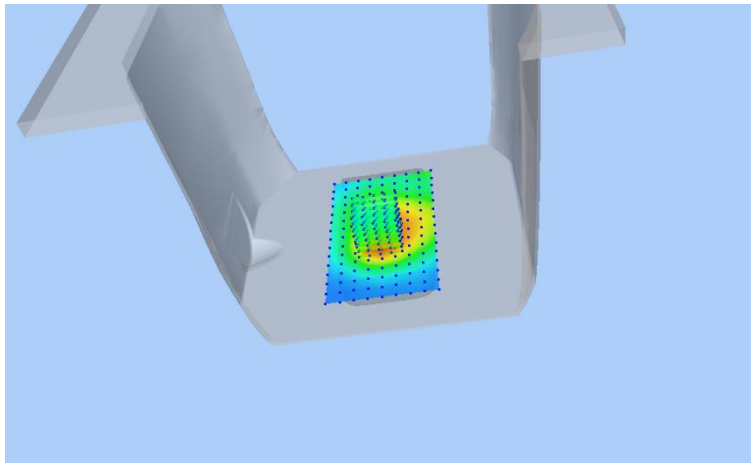

**Z Axis Scan**

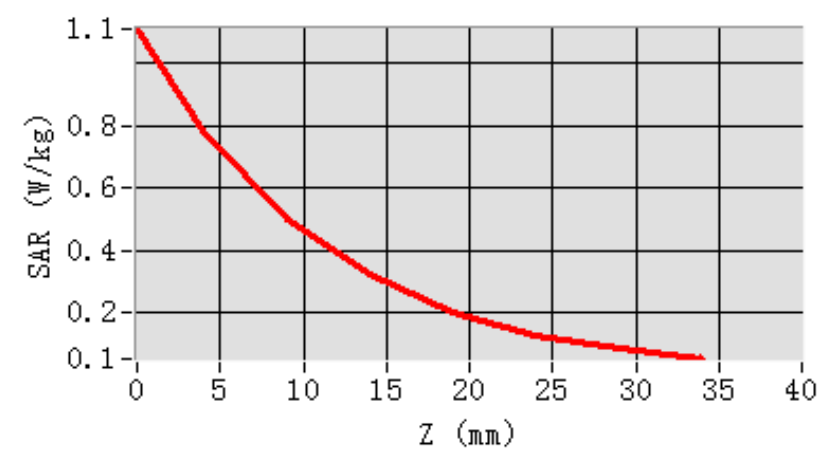

**MEAS. 3 Body Plane with Bottom Edge 10mm on Low Channel in LTE Band 7 mode**

**Test Date:** 24/2/2022  
**Measurement duration:** 18 minutes 45 seconds  
**Signal:** LTE, f=2510.0 MHz, Duty Cycle: 1:1.0  
**Liquid Parameters:** Permittivity: 39.11; Conductivity: 1.87 S/m  
**Test condition:** Ambient Temperature: 22.4°C, Liquid Temperature: 21.3°C  
**Probe:** SN 39/21 EPGO359, ConvF: 2.15  
**Area Scan:** sam\_direct\_droit2\_surf10mm.txt, h= 5.00 mm  
**Zoom Scan:** 7x7x7,dx=5mm, dy=5mm, dz=5mm,Complete  
**Maximum location:** X=10.000000, Y=-12.000000  
**SAR 10g (W/Kg):** 0.467559  
**SAR 1g (W/Kg):** 1.048763  
**Power drift (%):** 2.76  
**3D screen shot**

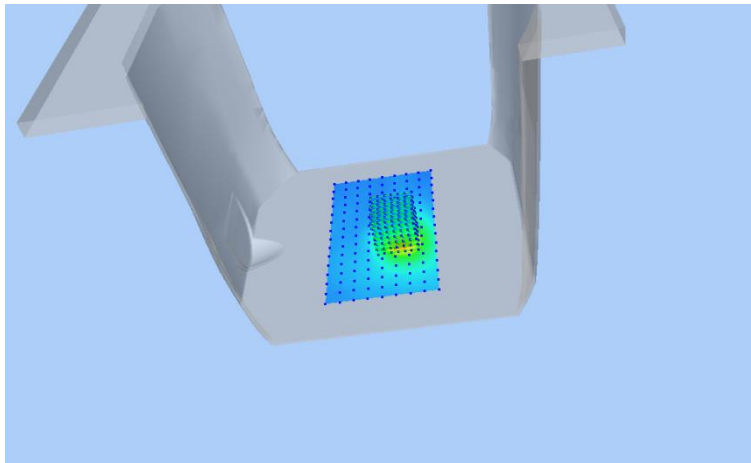

**Z Axis Scan**

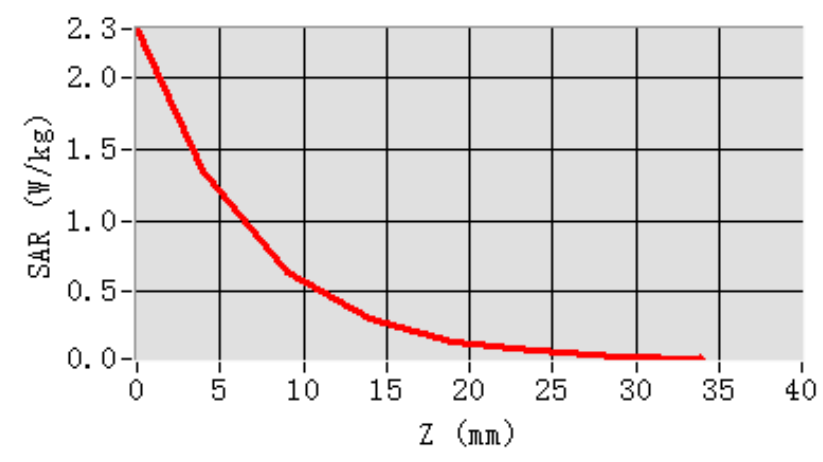

## **ANNEX D EUT EXTERNAL PHOTOS**

Please refer the document “BL-SZ2210355-AW.pdf”.

## **ANNEX E SAR TEST SETUP PHOTOS**

Please refer the document “BL-SZ2210355-AS.pdf”.

## **ANNEX F CALIBRATION REPORT**

Please refer the document “CALIBRATION REPORT.pdf”.

## Statement

1. The laboratory guarantees the scientificity, accuracy and impartiality of the test, and is responsible for all the information in the report, except the information provided by the customer. The customer is responsible for the impact of the information provided on the validity of the results.
2. For the report with CNAS mark or A2LA mark, the items marked with "☆" are not within the accredited scope.
3. This report is invalid if it is altered, without the signature of the testing and approval personnel, or without the "inspection and testing dedicated stamp" or test report stamp.
4. The test data and results are only valid for the tested samples provided by the customer.
5. This report shall not be partially reproduced without the written permission of the laboratory.
6. Any objection shall be raised to the laboratory within 30 days after receiving the report.

--END OF REPORT--