



TESTING LABORATORY
CERTIFICATE#4323.01



SAR EVALUATION REPORT

For

Shanghai ZoomSmart Technology Co., Ltd

Room 802 Hengxi Road No.809 Pujiang Town Minhang district, Shanghai, 201114 China

FCC ID: 2AUFL-LT702

| | | |
|--|--|--------------------|
| Report Type: Original Report | Product Type: Rugged Tablet | |
| Project Engineer: | Chris Wang | <i>Chris. Wang</i> |
| Report Number: | RSHD200817001-20B | |
| Report Date: | 2020-12-08 | |
| Reviewed By: | Oscar Ye EMC Manager | <i>Oscar.Ye</i> |
| Test Laboratory: | Bay Area Compliance Laboratories Corp. (Kunshan) No.248 Chenghu Road,Kunshan,Jiangsu province,China Tel: +86-0512-86175000 Fax: +86-0512-88934268 www.baclcorp.com.cn | |

| Attestation of Test Results | | | |
|---|--|---|---------------------|
| EUT Information | EUT Description | Rugged Tablet | |
| | Tested Model | LT702 | |
| | FCC ID | 2AUFL-LT702 | |
| | Serial Number | RSHD200817001 | |
| | Test Date | 2020-08-23~ 2020-08-30 | |
| MODE | | Max. SAR Level(s) Reported(W/kg) | Limit (W/kg) |
| Body supported Mode | GSM 850 | 0.25 W/kg 1g SAR | 1.6 |
| | PCS 1900 | 0.55 W/kg 1g SAR | |
| | WCDMA 2 | 0.44 W/kg 1g SAR | |
| | WCDMA 5 | 0.69 W/kg 1g SAR | |
| | CDMA | 0.75 W/kg 1g SAR | |
| | LTE Band 2 | 0.66 W/kg 1g SAR | |
| | LTE Band 4 | 0.56 W/kg 1g SAR | |
| | LTE Band 5 | 0.74 W/kg 1g SAR | |
| | LTE Band 7 | 0.67 W/kg 1g SAR | |
| | LTE Band 17 | 0.84 W/kg 1g SAR | |
| | LTE Band 41 | 0.88 W/kg 1g SAR | |
| | 2.4GHz WLAN | 0.49 W/kg 1g SAR | |
| | 5GHz WLAN | 0.62 W/kg 1g SAR | |
| | Hotspot | 1.35 W/kg 1g SAR | |
| Simultaneous | 1.35 W/kg 1g SAR | | |
| Applicable Standards | FCC 47 CFR part 2.1093 Radiofrequency radiation exposure evaluation: portable devices | | |
| | RF Exposure Procedures: TCB Workshop April 2019 | | |
| | IEEE1528:2013 IEEE Recommended Practice for Determining the Peak Spatial-Average Specific Absorption Rate (SAR) in the Human Head from Wireless Communications Devices: Measurement Techniques | | |
| | IEC 62209-1:2016 Measurement procedure for the assessment of specific absorption rate of human exposure to radio frequency fields from hand-held and body-mounted wireless communication devices – Part 1: Devices used next to the ear (Frequency range of 300 MHz to 6 GHz) | | |
| | IEC 62209-2:2010 Human exposure to radio frequency fields from hand-held and body-mounted wireless communication devices-Human models, instrumentation, and procedures-Part 2: Procedure to determine the specific absorption rate (SAR) for wireless communication devices used in close proximity to the human body (frequency range of 30 MHz to 6 GHz) | | |
| | KDB procedures KDB 447498 D01 General RF Exposure Guidance v06 KDB 648474 D04 Handset SAR v01r03 KDB 865664 D01 SAR Measurement 100 MHz to 6 GHz v01r04 KDB 865664 D02 RF Exposure Reporting v01r02 KDB 941225 D01 3G SAR Procedures v03r01 KDB 941225 D05 SAR for LTE Devices v02r05 KDB 248227 D01 802 11 Wi-Fi SAR v02r02 | | |
| Note: This wireless device has been shown to be capable of compliance for localized specific absorption rate (SAR) for General Population/Uncontrolled Exposure limits specified in FCC 47 CFR part 2.1093 and has been tested in accordance with the measurement procedures specified in IEEE 1528-2013 and RF exposure KDB procedures. The results and statements contained in this report pertain only to the device(s) evaluated. | | | |

TABLE OF CONTENTS

| | |
|--|-----------|
| DOCUMENT REVISION HISTORY | 4 |
| EUT DESCRIPTION | 5 |
| TECHNICAL SPECIFICATION | 5 |
| REFERENCE, STANDARDS, AND GUIDELINES..... | 6 |
| SAR LIMITS | 6 |
| FACILITIES..... | 7 |
| DESCRIPTION OF TEST SYSTEM | 8 |
| EQUIPMENT LIST AND CALIBRATION | 15 |
| EQUIPMENTS LIST & CALIBRATION INFORMATION | 15 |
| SAR MEASUREMENT SYSTEM VERIFICATION | 16 |
| LIQUID VERIFICATION | 16 |
| SYSTEM ACCURACY VERIFICATION | 18 |
| SAR SYSTEM VALIDATION DATA..... | 19 |
| EUT TEST STRATEGY AND METHODOLOGY | 27 |
| TEST POSITIONS FOR DEVICE OPERATING NEXT TO A PERSON’S EAR..... | 27 |
| CHEEK/TOUCH POSITION | 28 |
| EAR/TILT POSITION | 28 |
| TEST POSITIONS FOR BODY-WORN AND OTHER CONFIGURATIONS..... | 29 |
| TEST DISTANCE FOR SAR EVALUATION..... | 29 |
| SAR EVALUATION PROCEDURE..... | 30 |
| CONDUCTED OUTPUT POWER MEASUREMENT | 31 |
| PROVISION APPLICABLE | 31 |
| TEST PROCEDURE | 31 |
| RADIO CONFIGURATION | 31 |
| MAXIMUM TARGET OUTPUT POWER | 36 |
| TEST RESULTS: | 37 |
| STANDALONE SAR TEST EXCLUSION CONSIDERATIONS | 56 |
| STANDALONE SAR TEST EXCLUSION CONSIDERATIONS..... | 57 |
| STANDALONE SAR ESTIMATION:..... | 58 |
| STANDALONE SAR TEST EXCLUSION CONSIDERATIONS:..... | 58 |
| SAR TEST EXCLUSION FOR THE EUT EDGE CONSIDERATIONS RESULT | 59 |
| SAR TEST EXCLUSION FOR THE EUT EDGE CONSIDERATIONS DETIAL: | 59 |
| SAR MEASUREMENT RESULTS..... | 60 |
| SAR TEST DATA..... | 60 |
| SAR SIMULTANEOUS TRANSMISSION DESCRIPTION | 72 |
| SAR PLOTS..... | 73 |
| APPENDIX A MEASUREMENT UNCERTAINTY | 88 |
| APPENDIX B EUT TEST POSITION PHOTOS | 90 |
| APPENDIX C CALIBRATION CERTIFICATES | 93 |

DOCUMENT REVISION HISTORY

| Revision Number | Report Number | Description of Revision | Date of Revision |
|------------------------|----------------------|--------------------------------|-------------------------|
| 1.0 | RSHD200817001-20B | Original Report | 2020-12-08 |

EUT DESCRIPTION

This report has been prepared on behalf of **Shanghai ZoomSmart Technology Co., Ltd** and their product **Rugged Tablet**, Model: **LT702**, FCC ID: **2AUFL-LT702** or the EUT (Equipment under Test) as referred to in the rest of this report.

**All measurement and test data in this report was gathered from production sample serial number: RKSA200310001(Assigned by BACL).The EUT supplied by the applicant was received on 2020-08-10.*

Technical Specification

| | |
|-------------------------------|--|
| Device Type: | Rugged Tablet |
| Exposure Category: | Population / Uncontrolled |
| Antenna Type(s): | FPC antenna |
| Body-Worn Accessories: | None |
| Face-Head Accessories: | None |
| Operation Mode : | GSM Voice, GPRS Data, EGPRS Data, WCDMA(R99 (Voice+Data), HSDPA/HSUPA) CDMA FDD-LTE/ TDD-LTE WLAN2.4G/WLAN 5G Bluetooth |
| Frequency Band: | GSM/GPRS/EGPRS 850: 824-849 MHz(TX), 869-894 MHz(RX) GSM/GPRS/EGPRS 1900: 1850-1910 MHz(TX), 1930-1990 MHz(RX) WCDMA Band II: 1850-1910 MHz(TX), 1930-1990 MHz(RX) WCDMA Band V: 824-849 MHz(TX), 869-894 MHz(RX) CDMA850 Band: 824-849 MHz(TX), 869-894 MHz(RX) LTE Band 2: 1850-1910 MHz(TX), 1930MHz-1990 MHz(RX) LTE Band 4: 1710-1755 MHz(TX), 2110-2155 MHz(RX) LTE Band 5: 824-849 MHz(TX), 869-894 MHz(RX) LTE Band 7: 2500-2570 MHz(TX), 2620-2690 MHz(RX) LTE Band 17: 704-716 MHz(TX), 734-746 MHz(RX) LTE Band 41: 2555-2655 MHz(TX), 2555-2655 MHz(RX) 2.4G Wi-Fi: 2412~2462 MHz (802.11b/g/n20), 2422~2452 MHz (802.11n40) BT/BLE(1Mbps): 2402-2480MHz 5G Wi-Fi B1: 5180-5240 MHz, B4: 5745-5825 MHz |
| Conducted RF Power: | GSM 850: 33.52 dBm; PCS 1900: 31.59 dBm WCDMA Band 2: 20.97dBm;WCDMA Band 5: 22.54 dBm CDMA BC0:22.31 dBm LTE Band 2: 22.09 dBm; LTE Band 4: 21.86 dBm LTE Band 5: 24.34 dBm ;LTE Band 7: 21.71 dBm LTE Band 17: 22.22 dBm; LTE Band 41: 22.21 dBm WLAN 2.4G: 14.68 dBm; WLAN 5.2G: 14.48 dBm WLAN 5.8G: 10.51 dBm Bluetooth(BDR/EDR); 7.08 dBm; BLE(1Mbps):1.59dBm |
| Dimensions (L*W*H): | 20.8 cm (H) x 12.8 cm (W) x 1.3 cm (D) |
| Power Source: | DC 3.8V from battery and DC 5V from external power supply |
| Normal Operation: | Body Supported |

REFERENCE, STANDARDS, AND GUIDELINES

FCC:

The Report and Order requires routine SAR evaluation prior to equipment authorization of portable transmitter devices, including portable telephones. For consumer products, the applicable limit is 1.6 mW/g as recommended by the ANSI/IEEE standard C95.1-1992 [6] for an uncontrolled environment (Paragraph 65). According to the Supplement C of OET Bulletin 65 "Evaluating Compliance with FCC Guide-lines for Human Exposure to Radio frequency Electromagnetic Fields", released on Jun 29, 2001 by the FCC, the device should be evaluated at maximum output power (radiated from the antenna) under "worst-case" conditions for normal or intended use, incorporating normal antenna operating positions, device peak performance frequencies and positions for maximum RF energy coupling.

This report describes the methodology and results of experiments performed on wireless data terminal. The objective was to determine if there is RF radiation and if radiation is found, what is the extent of radiation with respect to safety limits. SAR (Specific Absorption Rate) is the measure of RF exposure determined by the amount of RF energy absorbed by human body (or its parts) – to determine how the RF energy couples to the body or head which is a primary health concern for body worn devices. The limit below which the exposure to RF is considered safe by regulatory bodies in North America is 1.6 mW/g average over 1 gram of tissue mass.

SAR Limits

FCC Limit

| EXPOSURE LIMITS | SAR (W/kg) | |
|---|--|--|
| | (General Population / Uncontrolled Exposure Environment) | (Occupational / Controlled Exposure Environment) |
| Spatial Average (averaged over the whole body) | 0.08 | 0.4 |
| Spatial Peak (averaged over any 1 g of tissue) | 1.60 | 8.0 |
| Spatial Peak (hands/wrists/feet/ankles averaged over 10 g) | 4.0 | 20.0 |

Population/Uncontrolled Environments are defined as locations where there is the exposure of individual who have no knowledge or control of their exposure.

Occupational/Controlled Environments are defined as locations where there is exposure that may be incurred by people who are aware of the potential for exposure (i.e. as a result of employment or occupation).

General Population/Uncontrolled environments Spatial Peak limit 1.6W/kg for 1g Body SAR and 4.0 W/kg for 10g Extremity SAR applied to the EUT.

FACILITIES

The test site used by Bay Area Compliance Laboratories Corp. (Kunshan) to collect test data is located on the No.248 Chenghu Road, Kunshan, Jiangsu province, China.

Bay Area Compliance Laboratories Corp. (Kunshan) Lab is accredited to ISO/IEC 17025 by A2LA (Lab code: 4323.01) and the FCC designation No. CN1185 under the FCC KDB 974614 D01 and CAB identifier CN0004 under the ISED requirement. The facility also complies with the radiated and AC line conducted test site criteria set forth in ANSI C63.4-2014.

DESCRIPTION OF TEST SYSTEM

These measurements were performed with the automated near-field scanning system DASY6 from Schmid & Partner Engineering AG (SPEAG) which is the Fifth generation of the system shown in the figure hereinafter:

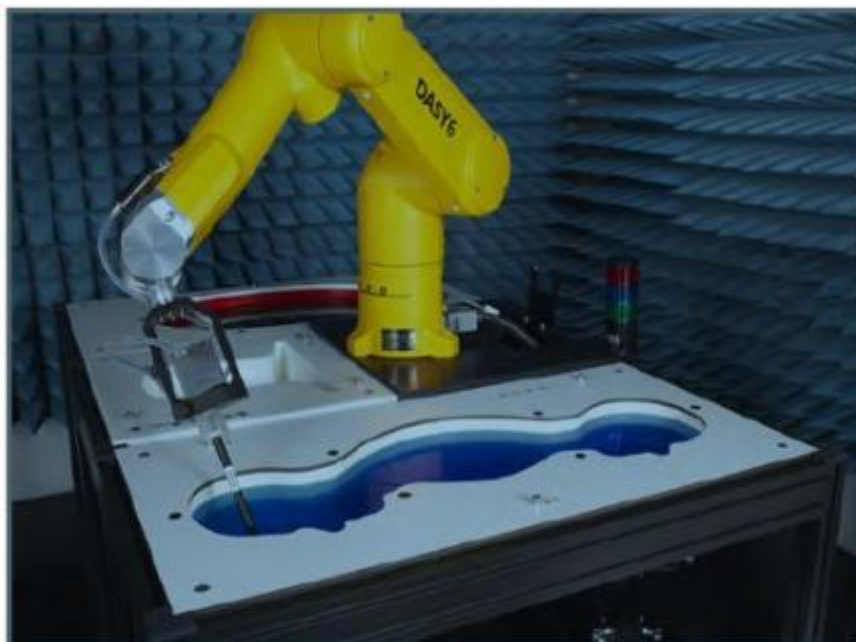

DASY6 System Description

The DASY6 system for performing compliance tests consists of the following items:

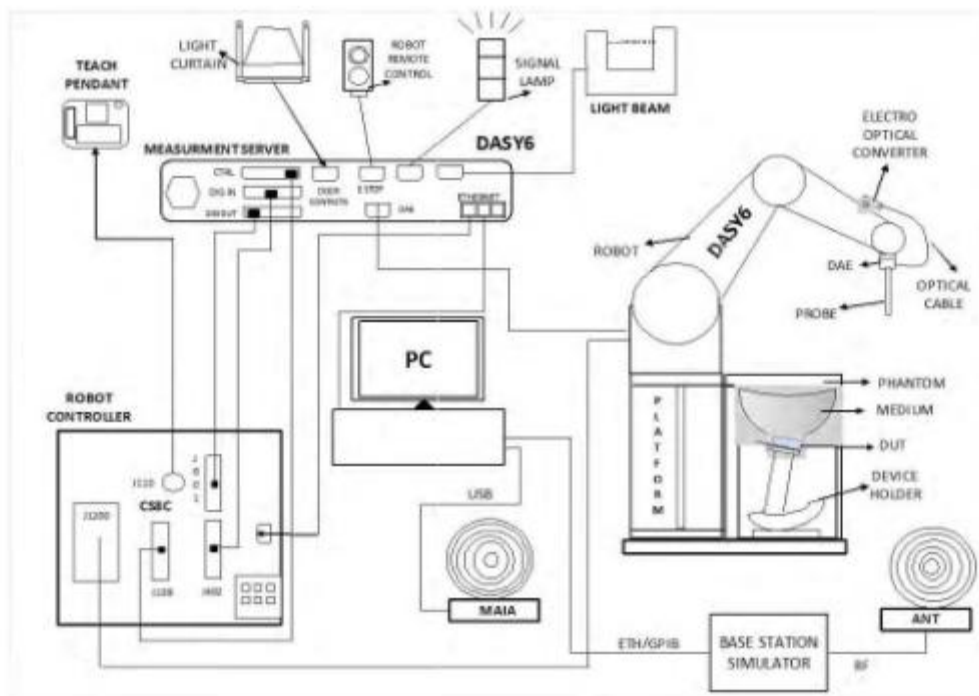

- A standard high precision 6-axis robot (Staubli TX=RX family) with controller, teach pendant and software. An arm extension for accommodating the data acquisition electronics (DAE).
- An isotropic field probe optimized and calibrated for the targeted measurement.
- A data acquisition electronics (DAE) which performs the signal application, signal multiplexing, AD-conversion, offset measurements, mechanical surface detection, collision detection, etc. The unit is battery powered with standard or rechargeable batteries. The signal is optically transmitted to the EOC.
- The Electro-optical converter (EOC) performs the conversion from optical to electrical signals for the digital communication to the DAE. To use optical surface detection, a special version of the EOC is required. The EOC signal is transmitted to the measurement server.
- The function of the measurement server is to perform the time critical tasks such as signal filtering, control of the robot operation and fast movement interrupts.
- The Light Beam used is for probe alignment. This improves the (absolute) accuracy of the probe positioning.
- A computer running Win7 professional operating system and the DASY52 software.
- Remote control and teach pendant as well as additional circuitry for robot safety such as warning lamps, etc.
- The phantom, the device holder and other accessories according to the targeted measurement.

DASY6 Measurement Server

The DASY6 measurement server is based on a PC/104 CPU board with a 400 MHz Intel ULV Celeron, 128 MB chip-disk and 128 MB RAM. The necessary circuits for communication with the DAE4 (or DAE3) electronics box, as well as the 16-bit AD converter system for optical detection and digital I/O interface are contained on the DASY6 I/O board, which is directly connected to the PC/104 bus of the CPU board.



The measurement server performs all real-time data evaluations of field measurements and surface detection, controls robot movements, and handles safety operations. The PC operating system cannot interfere with these time-critical processes. All connections are supervised by a watchdog, and disconnection of any of the cables to the measurement server will automatically disarm the robot and disable all program- controlled robot movements. Furthermore, the measurement server is equipped with an expansion port, which is reserved for future applications. Please note that this expansion port does not have a standardized pinout, and therefore only devices provided by SPEAG can be connected. Connection of devices from any other supplier could seriously damage the measurement server.

Data Acquisition Electronics

The data acquisition electronics (DAE4) consist of a highly sensitive electrometer-grade preamplifier with auto-zeroing, a channel and gain-switching multiplexer, a fast 16 bit AD-converter and a command decoder with a control logic unit. Transmission to the measurement server is accomplished through an optical downlink for data and status information, as well as an optical uplink for commands and the clock.

The mechanical probe mounting device includes two different sensor systems for frontal and sideways probe contacts. They are used for mechanical surface detection and probe collision detection.

The input impedance of both the DAE4 as well as of the DAE3 box is 200M Ω ; the inputs are symmetrical and floating. Common mode rejection is above 80 dB.

EX3DV4 E-Field Probes

| | |
|----------------------|---|
| Frequency | 10 MHz to > 6 GHz Linearity: ± 0.2 dB (30 MHz to 6 GHz) |
| Directivity | ± 0.3 dB in TSL (rotation around probe axis) ± 0.5 dB in TSL (rotation normal to probe axis) |
| Dynamic Range | 10 µW/g to > 100 mW/g Linearity: ± 0.2 dB (noise: typically < 1 µW/g) |
| Dimensions | Overall length: 337 mm (Tip: 20 mm) Tip diameter: 2.5 mm (Body: 12 mm) Typical distance from probe tip to dipole centers: 1 mm |
| Application | High precision dosimetric measurements in any exposure scenario (e.g., very strong gradient fields); the only probe that enables compliance testing for frequencies up to 6 GHz with precision of better 30%. |
| Compatibility | DASY3, DASY4, DASY52 SAR and higher, EASY4/MRI |

SAM Twin Phantom

The SAM Twin Phantom (shown in front of DASY6) is a fiberglass shell phantom with shell thickness 2 mm, except in the ear region where the thickness is increased to 6 mm. The phantom has three measurement areas: 1) Left Head, 2) Right Head, and 3) Flat Section. For larger devices, the use of the ELI-Phantom (shown behind DASY6) is required. For devices such as glasses with a wireless link, the Face Down Phantom is the most suitable (between the SAM Twin and ELI phantoms).

When the phantom is mounted inside allocated slot of the DASY6 platform, phantom reference points can be taught directly in the DASY5 V5.2 software. When the DASY6 platform is used to mount the Phantom, some of the phantom teaching points cannot be reached by the robot in DASY5 V5.2. A special tool called P1a-P2aX-Former is provided to transform two of the three points, P1 and P2, to reachable locations. To use these new teaching points, a revised phantom configuration file is required.

In addition to our standard broadband liquids, the phantom can be used with the following tissue simulating liquids:

Sugar-water-based liquids can be left permanently in the phantom. Always cover the liquid when the system is not in use to prevent changes in liquid parameters due to water evaporation.

DGBE-based liquids should be used with care. As DGBE is a softener for most plastics, the liquid should be taken out of the phantom, and the phantom should be dried when the system is not in use (desirable at least once a week).

Do not use other organic solvents without previously testing the solvent resistivity of the phantom.

Approximately 25 liters of liquid is required to fill the SAM Twin phantom.

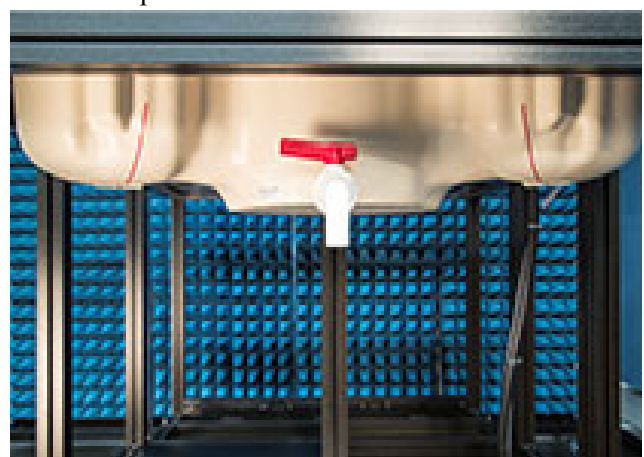

ELI Phantom

The ELI phantom is intended for compliance testing of handheld and body-mounted wireless devices in the frequency range of 30MHz to 6 GHz. ELI is fully compatible with the latest draft of the standard IEC 62209-2 and the use of all known tissue simulating liquids. ELI has been optimized for performance and can be integrated into a SPEAG standard phantom table. A cover is provided to prevent evaporation of water and changes in liquid parameters. Reference markings on the phantom allow installation of the complete setup, including all predefined phantom positions and measurement grids, by teaching three points.

The phantom can be used with the following tissue simulating liquids:

- Sugar-water-based liquids can be left permanently in the phantom. Always cover the liquid when the system is not in use to prevent changes in liquid parameters due to water evaporation.
- DGBE-based liquids should be used with care. As DGBE is a softener for most plastics, the liquid should be taken out of the phantom, and the phantom should be dried when the system is not in use (desirable at least once a week).
- Do not use other organic solvents without previously testing the solvent resistivity of the phantom.

Approximately 25 liters of liquid is required to fill the ELI phantom.

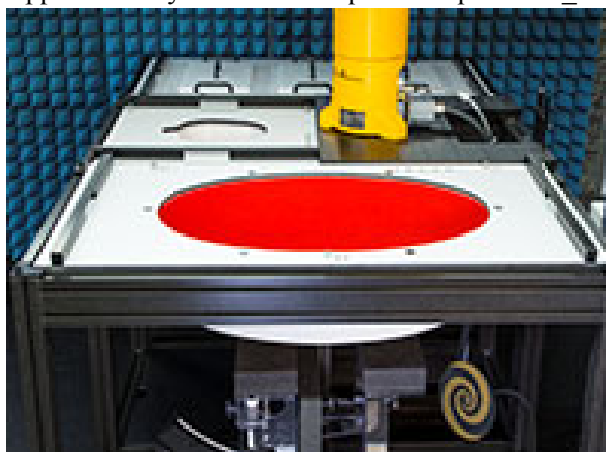

Robots

The DASY6 system uses the high-precision industrial robots TX60L, TX90XL, and RX160L from Staubli SA (France). The TX robot family - the successor of the well-known RX robot family - continues to offer the features important for DASY6 applications:

- High precision (repeatability 0.02mm)
- High reliability (industrial design)
- Low maintenance costs (virtually maintenance free due to direct drive gears; no belt drives)
- Jerk-free straight movements (brushless synchrony motors; no stepper motors)
- Low ELF interference (motor control fields shielded via the closed metallic construction shields)

The robots are controlled by the Staubli CS8c robot controllers. All information regarding the use and maintenance of the robot arm and the robot controller is provided

Area Scans

Area scans are defined prior to the measurement process being executed with a user defined variable spacing between each measurement point (integral) allowing low uncertainty measurements to be conducted. Scans defined for FCC applications utilize a 15mm 2 step integral, with 1.5mm interpolation used to locate the peak SAR area used for zoom scan assessments.

Where the system identifies multiple SAR peaks (which are within 25% of peak value) the system will provide the user with the option of assessing each peak location individually for zoom scan averaging.

Zoom Scan (Cube Scan Averaging)

The averaging zoom scan volume utilized in the DASY5 software is in the shape of a cube and the side dimension of a 1 g or 10 g mass is dependent on the density of the liquid representing the simulated tissue. A density of 1000 kg/m³ is used to represent the head and body tissue density and not the phantom liquid density, in order to be consistent with the definition of the liquid dielectric properties, i.e. the side length of the 1g cube is 10mm, with the side length of the 10g cube is 21.5mm.

When the cube intersects with the surface of the phantom, it is oriented so that 3 vertices touch the surface of the shell or the center of a face is tangent to the surface. The face of the cube closest to the surface is modified in order to conform to the tangent surface.

The zoom scan integer steps can be user defined so as to reduce uncertainty, but normal practice for typical test applications (including FCC) utilize a physical step of 7 x7 x 7 (5mmx5mmx5mm) providing a volume of 30 mm in the X & Y & Z axis.

Calibration Frequency Points for EX3DV4 E-Field Probes SN: 7557 Calibrated: 2019/10/04

| Calibration Frequency Point(MHz) | Frequency Range(MHz) | | Conversion Factor | | |
|----------------------------------|----------------------|------|-------------------|-------|-------|
| | From | To | X | Y | Z |
| 750 Head | 650 | 810 | 10.41 | 10.41 | 10.41 |
| 835 Head | 810 | 935 | 10.10 | 10.10 | 10.10 |
| 1750 Head | 1650 | 1810 | 8.67 | 8.67 | 8.67 |
| 1900 Head | 1810 | 2000 | 8.36 | 8.36 | 8.36 |
| 2300 Head | 2200 | 2399 | 7.79 | 7.79 | 7.79 |
| 2450 Head | 2399 | 2500 | 7.41 | 7.41 | 7.41 |
| 2600 Head | 2500 | 2700 | 7.21 | 7.21 | 7.21 |
| 5250 Head | 5140 | 5360 | 5.38 | 5.38 | 5.38 |
| 5600 Head | 5490 | 5700 | 4.75 | 4.75 | 4.75 |
| 5800 Head | 5700 | 5910 | 4.70 | 4.70 | 4.70 |

Tissue Dielectric Parameters for Head and Body Phantoms

The head tissue dielectric parameters recommended by the IEC 62209-1:2016

Recommended Tissue Dielectric Parameters for Head liquid

Table A.3 – Dielectric properties of the head tissue-equivalent liquid

| Frequency MHz | Relative permittivity ϵ_r | Conductivity (σ) S/m |
|------------------|---------------------------------------|----------------------------------|
| 300 | 45,3 | 0,87 |
| 450 | 43,5 | 0,87 |
| <i>750</i> | <i>41,9</i> | <i>0,89</i> |
| 835 | 41,5 | 0,90 |
| 900 | 41,5 | 0,97 |
| 1 450 | 40,5 | 1,20 |
| <i>1 500</i> | <i>40,4</i> | <i>1,23</i> |
| <i>1 640</i> | <i>40,2</i> | <i>1,31</i> |
| <i>1 750</i> | <i>40,1</i> | <i>1,37</i> |
| 1 800 | 40,0 | 1,40 |
| 1 900 | 40,0 | 1,40 |
| 2 000 | 40,0 | 1,40 |
| <i>2 100</i> | <i>39,8</i> | <i>1,49</i> |
| <i>2 300</i> | <i>39,5</i> | <i>1,67</i> |
| 2 450 | 39,2 | 1,80 |
| <i>2 600</i> | <i>39,0</i> | <i>1,96</i> |
| 3 000 | 38,5 | 2,40 |
| <i>3 500</i> | <i>37,9</i> | <i>2,91</i> |
| <i>4 000</i> | <i>37,4</i> | <i>3,43</i> |
| <i>4 500</i> | <i>36,8</i> | <i>3,94</i> |
| <i>5 000</i> | <i>36,2</i> | <i>4,45</i> |
| <i>5 200</i> | <i>36,0</i> | <i>4,66</i> |
| <i>5 400</i> | <i>35,8</i> | <i>4,86</i> |
| <i>5 600</i> | <i>35,5</i> | <i>5,07</i> |
| <i>5 800</i> | <i>35,3</i> | <i>5,27</i> |
| <i>6 000</i> | <i>35,1</i> | <i>5,48</i> |

NOTE For convenience, permittivity and conductivity values at those frequencies which are not part of the original data provided by Drossos et al. [33] or the extension to 5 800 MHz are provided (i.e. the values shown *in italics*). These values were linearly interpolated between the values in this table that are immediately above and below these values, except the values at 6 000 MHz that were linearly extrapolated from the values at 3 000 MHz and 5 800 MHz.

Note:

- 1, Effective February 19, 2019, FCC has permitted the use of single head-tissue simulating liquid specified in IEC 62209-1 for all SAR tests.
- 2, Mix and Match of traditional FCC SAR TSLs and IEC 62209-1 TSL in a single application is not permitted TSL can be changed in a Permissive Change.
- 3, If SAR increases and original SAR > 1.2 W/kg, additional SAR measurements will be required IEC 62209-1 TSL is an alternative, not mandatory at this time.
- 4, If FCC parameters are used, $\pm 5\%$ tolerance. If IEC parameters, $\pm 10\%$.
- 5, In this case, IEC parameters applied.

EQUIPMENT LIST AND CALIBRATION

Equipments List & Calibration Information

| Equipment | Model | S/N | Calibration Date | Calibration Due Date |
|------------------------------|----------------|---------------|------------------|----------------------|
| DASY5 Test Software | DASY52 52.10.2 | N/A | N/A | N/A |
| DASY6 Measurement Server | DASY6 6.0.31 | N/A | N/A | N/A |
| Data Acquisition Electronics | DAE4 | 527 | 2020/07/9 | 2021/07/8 |
| E-Field Probe | EX3DV4 | 7557 | 2019/10/04 | 2020/10/03 |
| Mounting Device | MD4HHTV5 | SD 000 H01 KA | N/A | N/A |
| Twin-SAM Phantom | QD 000 P41 AA | 1963 | N/A | N/A |
| Dipole, 750MHz | D750V3 | 1166 | 2018/09/05 | 2021/09/04 |
| Dipole, 835MHz | D835V2 | 445 | 2019/12/17 | 2022/12/16 |
| Dipole, 1750MHz | D1750V2 | 1140 | 2018/06/25 | 2021/06/24 |
| Dipole, 1900MHz | D1900V2 | 5d206 | 2018/09/11 | 2021/09/10 |
| Dipole, 2450MHz | D2450V2 | 970 | 2018/06/26 | 2021/06/25 |
| Dipole, 2600MHz | D2600V2 | 1162 | 2019/10/02 | 2022/10/01 |
| Dipole,5000MHz | D5GHzV2 | 1296 | 2019/10/03 | 2022/10/02 |
| Simulated Tissue Liquid Head | HBBL600-6000V6 | 180611-3 | Each Time | |
| Network Analyzer | 8753B | 3625A00809 | 2019/12/14 | 2020/12/13 |
| Dielectric Assessment Kit | DAK-3.5 | SM DAK 300AB | N/A | N/A |
| Signal Generator | N5182B | MY53051592 | 2019/12/14 | 2020/12/13 |
| Power Meter | E4419B | GB43312421 | 2020/08/04 | 2021/08/03 |
| Power Amplifier | 5S1G4 | 71377 | N/A | N/A |
| Directional Coupler | 4242-10 | 3307 | N/A | N/A |
| Attenuator | 3dB | 5402 | N/A | N/A |
| Attenuator | 10dB | AU 3842 | N/A | N/A |

SAR MEASUREMENT SYSTEM VERIFICATION

Liquid Verification

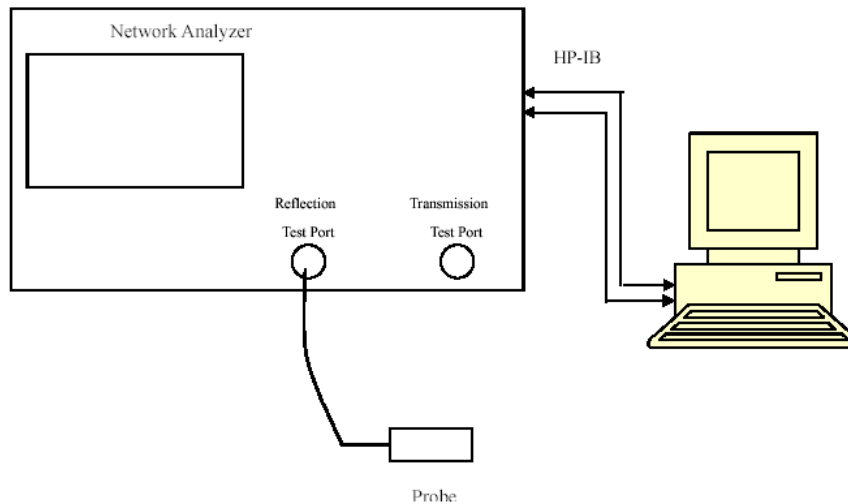

Liquid Verification Setup Block Diagram

Liquid Verification Results

| Frequency (MHz) | Liquid Type | Liquid Parameter | | Target Value | | Delta (%) | | Tolerance (%) |
|-----------------|-------------|------------------|--------------|----------------|--------------|-----------------|---------------------|---------------|
| | | σ (S/m) | ϵ_r | σ (S/m) | ϵ_r | $\Delta \sigma$ | $\Delta \epsilon_r$ | |
| 835 | Head | 0.906 | 42.024 | 0.900 | 41.500 | 0.67 | 1.26 | ± 5 |
| 836.6 | Head | 0.908 | 42.001 | 0.900 | 41.500 | 0.89 | 1.21 | ± 5 |
| 836.52 | Head | 0.908 | 41.999 | 0.900 | 41.500 | 0.89 | 1.20 | ± 5 |
| 836.5 | Head | 0.908 | 42.001 | 0.900 | 41.500 | 0.89 | 1.21 | ± 5 |

*Liquid Verification above was performed on 2020/08/23.

| Frequency (MHz) | Liquid Type | Liquid Parameter | | Target Value | | Delta (%) | | Tolerance (%) |
|-----------------|-------------|------------------|--------------|----------------|--------------|-----------------|---------------------|---------------|
| | | σ (S/m) | ϵ_r | σ (S/m) | ϵ_r | $\Delta \sigma$ | $\Delta \epsilon_r$ | |
| 750 | Head | 0.893 | 41.266 | 0.890 | 41.900 | 0.34 | -1.51 | ± 5 |
| 710 | Head | 0.856 | 41.786 | 0.887 | 42.102 | -3.82 | -0.75 | ± 5 |

*Liquid Verification above was performed on 2020/08/24.

| Frequency (MHz) | Liquid Type | Liquid Parameter | | Target Value | | Delta (%) | | Tolerance (%) |
|-----------------|-------------|------------------|--------------|----------------|--------------|-----------------|---------------------|---------------|
| | | σ (S/m) | ϵ_r | σ (S/m) | ϵ_r | $\Delta \sigma$ | $\Delta \epsilon_r$ | |
| 1750 | Head | 1.370 | 40.851 | 1.387 | 40.038 | -1.44 | 2.03 | ± 5 |
| 1732.5 | Head | 1.353 | 40.926 | 1.377 | 40.067 | -1.96 | 2.14 | ± 5 |

*Liquid Verification above was performed on 2020/08/25.

| Frequency (MHz) | Liquid Type | Liquid Parameter | | Target Value | | Delta (%) | | Tolerance (%) |
|-----------------|-------------|------------------|--------------|----------------|--------------|-----------------|---------------------|---------------|
| | | σ (S/m) | ϵ_r | σ (S/m) | ϵ_r | $\Delta \sigma$ | $\Delta \epsilon_r$ | |
| 1900 | Head | 1.411 | 38.720 | 1.400 | 40 | 0.79 | -3.20 | ± 5 |
| 1880 | Head | 1.390 | 38.807 | 1.400 | 40 | -0.71 | -2.98 | ± 5 |

*Liquid Verification above was performed on 2020/08/26.

| Frequency (MHz) | Liquid Type | Liquid Parameter | | Target Value | | Delta (%) | | Tolerance (%) |
|-----------------|-------------|------------------|--------------|----------------|--------------|-----------------|---------------------|---------------|
| | | σ (S/m) | ϵ_r | σ (S/m) | ϵ_r | $\Delta \sigma$ | $\Delta \epsilon_r$ | |
| 2450 | Head | 1.876 | 39.225 | 1.800 | 39.200 | 4.22 | 0.06 | ± 5 |
| 2437 | Head | 1.860 | 39.273 | 1.788 | 39.219 | 3.91 | 0.14 | ± 5 |
| 2441 | Head | 1.866 | 39.256 | 1.791 | 39.213 | 4.25 | 0.12 | ± 5 |

*Liquid Verification above was performed on 2020/08/27.

| Frequency (MHz) | Liquid Type | Liquid Parameter | | Target Value | | Delta (%) | | Tolerance (%) |
|-----------------|-------------|------------------|--------------|----------------|--------------|-----------------|---------------------|---------------|
| | | σ (S/m) | ϵ_r | σ (S/m) | ϵ_r | $\Delta \sigma$ | $\Delta \epsilon_r$ | |
| 2600 | Head | 1.999 | 37.519 | 1.960 | 39.000 | 1.99 | -3.80 | ± 5 |
| 2535 | Head | 1.971 | 37.768 | 1.888 | 39.084 | 4.29 | -3.36 | ± 5 |
| 2565 | Head | 1.955 | 37.656 | 1.921 | 39.045 | 1.82 | -3.57 | ± 5 |
| 2605 | Head | 2.005 | 37.501 | 1.966 | 38.994 | 1.78 | -3.82 | ± 5 |
| 2645 | Head | 2.048 | 37.322 | 2.009 | 38.943 | 1.89 | -4.16 | ± 5 |

*Liquid Verification above was performed on 2020/08/28.

| Frequency (MHz) | Liquid Type | Liquid Parameter | | Target Value | | Delta (%) | | Tolerance (%) |
|-----------------|-------------|------------------|--------------|----------------|--------------|-----------------|---------------------|---------------|
| | | σ (S/m) | ϵ_r | σ (S/m) | ϵ_r | $\Delta \sigma$ | $\Delta \epsilon_r$ | |
| 5250 | Head | 4.606 | 36.725 | 4.711 | 35.950 | -2.21 | 2.16 | ± 5 |
| 5180 | Head | 4.513 | 36.874 | 4.639 | 36.020 | -2.74 | 2.37 | ± 5 |

*Liquid Verification above was performed on 2020/08/29.

| Frequency (MHz) | Liquid Type | Liquid Parameter | | Target Value | | Delta (%) | | Tolerance (%) |
|-----------------|-------------|------------------|--------------|----------------|--------------|-----------------|---------------------|---------------|
| | | σ (S/m) | ϵ_r | σ (S/m) | ϵ_r | $\Delta \sigma$ | $\Delta \epsilon_r$ | |
| 5800 | Head | 5.245 | 35.523 | 5.270 | 35.300 | -0.47 | 0.63 | ± 5 |
| 5785 | Head | 5.233 | 35.553 | 5.255 | 35.315 | -0.51 | 0.66 | ± 5 |

*Liquid Verification above was performed on 2020/08/30.

System Accuracy Verification

Prior to the assessment, the system validation kit was used to test whether the system was operating within its specifications of $\pm 10\%$. The validation results are tabulated below. And also the corresponding SAR plot is attached as well in the SAR plots files.

The spacing distances in the **System Verification Setup Block Diagram** is given by the following:

- a) $s = 15 \text{ mm} \pm 0,2 \text{ mm}$ for $300 \text{ MHz} \leq f \leq 1 \text{ 000 MHz}$;
- b) $s = 10 \text{ mm} \pm 0,2 \text{ mm}$ for $1 \text{ 000 MHz} < f \leq 3 \text{ 000 MHz}$;
- c) $s = 10 \text{ mm} \pm 0,2 \text{ mm}$ for $3 \text{ 000 MHz} < f \leq 6 \text{ 000 MHz}$.

System Verification Setup Block Diagram

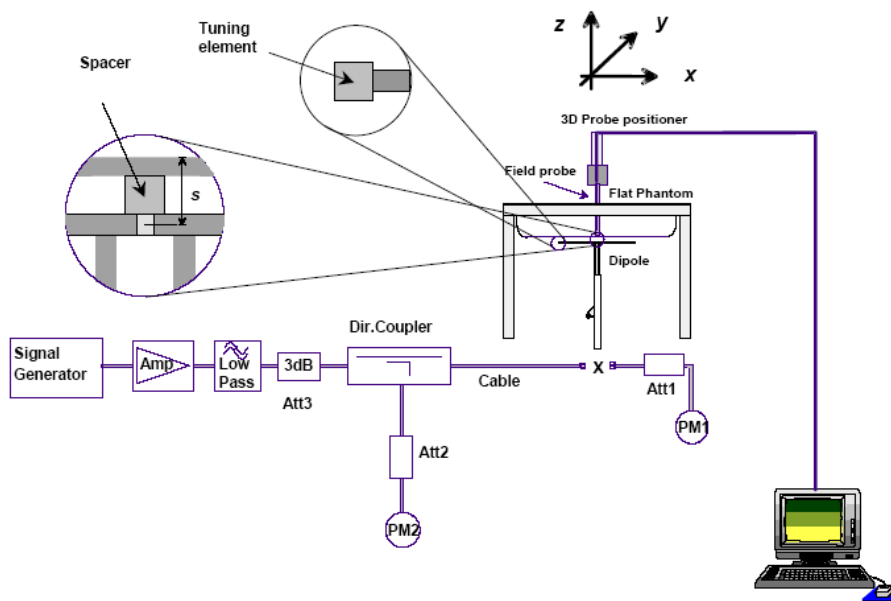

System Accuracy Check Results

| Date | Frequency Band | Liquid Type | Input Power (mW) | Measured SAR (W/kg) | | Normalized to 1W (W/kg) | Target Value (W/kg) | Delta (%) | Tolerance (%) |
|------------|----------------|-------------|------------------|---------------------|-------|-------------------------|---------------------|-----------|---------------|
| 2020/08/24 | 750MHz | Head | 250 | 1g | 2.05 | 8.20 | 8.26 | -0.73 | ± 10 |
| 2020/08/23 | 835 MHz | Head | 250 | 1g | 2.38 | 9.52 | 9.52 | 0 | ± 10 |
| 2020/08/25 | 1750 MHz | Head | 250 | 1g | 8.38 | 33.52 | 36.50 | -8.16 | ± 10 |
| 2020/08/26 | 1900MHz | Head | 250 | 1g | 10.30 | 41.20 | 39.20 | 5.10 | ± 10 |
| 2020/08/27 | 2450 MHz | Head | 250 | 1g | 13.60 | 54.40 | 53.30 | 2.06 | ± 10 |
| 2020/08/28 | 2600 MHz | Head | 250 | 1g | 13.10 | 52.40 | 55.40 | -5.42 | ± 10 |
| 2020/08/29 | 5250 MHz | Head | 100 | 1g | 7.39 | 73.90 | 79.20 | -6.69 | ± 10 |
| 2020/08/30 | 5800 MHz | Head | 100 | 1g | 8.50 | 85.00 | 79.90 | 6.38 | ± 10 |

*The SAR values above are normalized to 1 Watt forward power.

SAR SYSTEM VALIDATION DATA

System Performance Check 750MHz

DUT: D750V3; Type: D750V3; Serial: D750V3 - SN:1166

Communication System: UID 0, CW (0); Frequency: 750 MHz;Duty Cycle: 1:1
 Medium parameters used: $f = 750 \text{ MHz}$; $\sigma = 0.893 \text{ S/m}$; $\epsilon_r = 41.266$; $\rho = 1000 \text{ kg/m}^3$

DASY5 Configuration:

- Probe: EX3DV4 - SN7557;ConvF(10.41, 10.41, 10.41); Calibrated: 10/4/2019;
- Sensor-Surface: 1.4mm (Mechanical Surface Detection)
- Electronics: DAE4 Sn527; Calibrated: 7/9/2020
- Phantom: ELI V8.0; Type: QD OVA 004 Ax; Serial: 2095
- Measurement SW: DASY52, Version 52.10 (1); SEMCAD X Version 14.6.11 (7437)

Pin=250mW/Area Scan (61x61x1): Interpolated grid: $dx=1.500 \text{ mm}$, $dy=1.500 \text{ mm}$
 Maximum value of SAR (interpolated) = 2.60 W/kg

Pin=250mW/Zoom Scan (5x5x7)/Cube 0: Measurement grid: $dx=8\text{mm}$, $dy=8\text{mm}$, $dz=5\text{mm}$
 Reference Value = 52.04 V/m ; Power Drift = -0.03 dB
 Peak SAR (extrapolated) = 3.09 W/kg
SAR(1 g) = 2.05 W/kg ; SAR(10 g) = 1.35 W/kg
 Maximum value of SAR (measured) = 2.59 W/kg

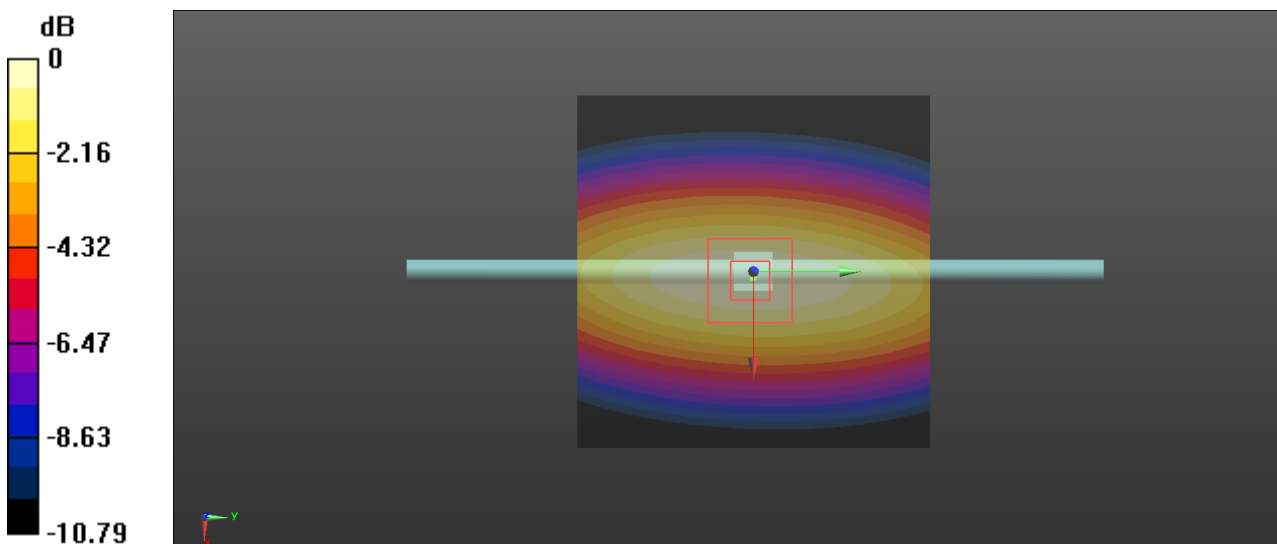

0 dB = $2.59 \text{ W/kg} = 4.13 \text{ dBW/kg}$

System Check_Head_835MHz

DUT: Dipole 835 MHz D835V2; Type: D835V2; Serial: D835V2 - SN:445

Communication System: UID 0, Systemperformance Check MHz (0); Frequency: 835 MHz;Duty Cycle: 1:1

Medium parameters used: $f = 835 \text{ MHz}$; $\sigma = 0.906 \text{ S/m}$; $\epsilon_r = 42.024$; $\rho = 1000 \text{ kg/m}^3$

DASY5 Configuration:

- Probe: EX3DV4 - SN7557;ConvF(10.1, 10.1, 10.1); Calibrated: 10/4/2019;
- Sensor-Surface: 1.4mm (Mechanical Surface Detection)
- Electronics: DAE4 Sn527; Calibrated: 7/9/2020
- Phantom: ELI V8.0; Type: QD OVA 004 Ax; Serial: 2095
- Measurement SW: DASY52, Version 52.10 (1); SEMCAD X Version 14.6.11 (7437)

Pin=250mW/Area Scan (101x201x1): Interpolated grid: $dx=1.500 \text{ mm}$, $dy=1.500 \text{ mm}$
 Maximum value of SAR (interpolated) = 2.57 W/kg

Pin=250mW/Zoom Scan (7x7x7)/Cube 0: Measurement grid: $dx=8\text{mm}$, $dy=8\text{mm}$, $dz=5\text{mm}$
 Reference Value = 53.49 V/m; Power Drift = -0.04 dB

Peak SAR (extrapolated) = 3.58 W/kg

SAR(1 g) = 2.38 W/kg; SAR(10 g) = 1.55 W/kg

Maximum value of SAR (measured) = 2.58 W/kg

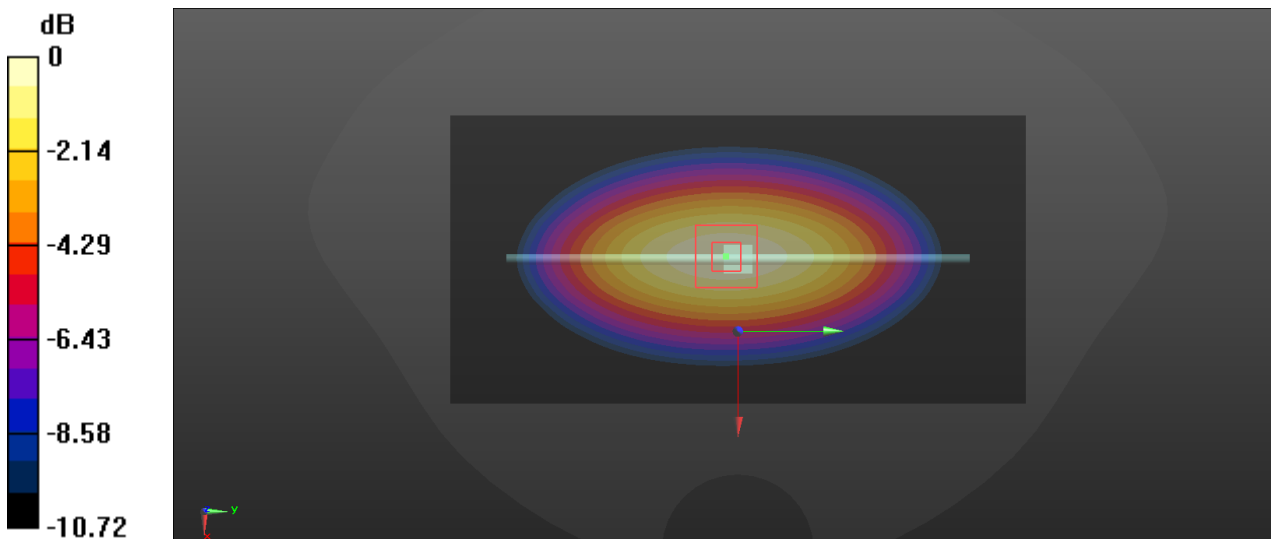

0 dB = 2.58 W/kg = 4.12 dBW/kg

System Check_Head_1750MHz

DUT: Dipole 1750 MHz D1750V2; Type: D1750V2; Serial: D1750V2 - SN:1140

Communication System: UID 0, Systemperformance Check (0); Frequency: 1750 MHz;Duty Cycle: 1:1

Medium parameters used: $f = 1750 \text{ MHz}$; $\sigma = 1.37 \text{ S/m}$; $\epsilon_r = 40.851$; $\rho = 1000 \text{ kg/m}^3$

DASY5 Configuration:

- Probe: EX3DV4 - SN7557;ConvF(8.67, 8.67, 8.67); Calibrated: 10/4/2019;
- Sensor-Surface: 1.4mm (Mechanical Surface Detection)
- Electronics: DAE4 Sn527; Calibrated: 7/9/2020
- Phantom: ELI V8.0; Type: QD OVA 004 Ax; Serial: 2095
- Measurement SW: DASY52, Version 52.10 (1); SEMCAD X Version 14.6.11 (7437)

Pin=250mW/Area Scan (101x141x1): Interpolated grid: $dx=1.500 \text{ mm}$, $dy=1.500 \text{ mm}$
 Maximum value of SAR (interpolated) = 9.39 W/kg

Pin=250mW/Zoom Scan (7x7x7)/Cube 0: Measurement grid: $dx=8\text{mm}$, $dy=8\text{mm}$, $dz=5\text{mm}$
 Reference Value = 86.68 V/m; Power Drift = -0.03 dB

Peak SAR (extrapolated) = 15.4 W/kg

SAR(1 g) = 8.38 W/kg; SAR(10 g) = 4.44 W/kg

Maximum value of SAR (measured) = 9.08 W/kg

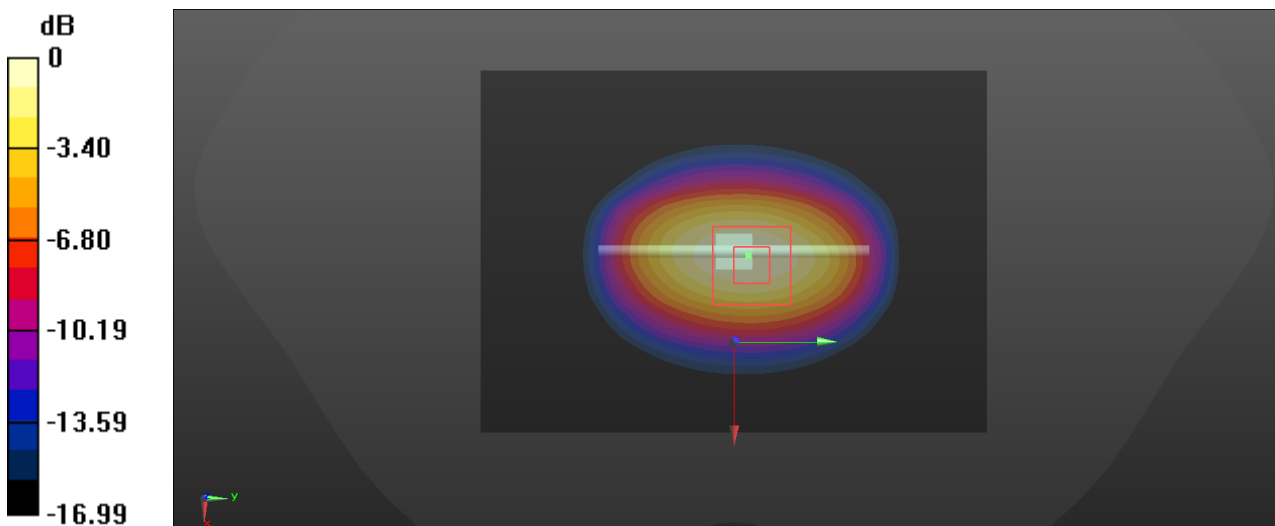

$0 \text{ dB} = 9.08 \text{ W/kg} = 9.58 \text{ dBW/kg}$

System Check_Head_1900MHz

DUT: Dipole 1900 MHz D1900V2; Type: D1900V2; Serial: D1900V2 - SN:5d206

Communication System: UID 0, Systemperformance Check MHz (0); Frequency: 1900 MHz;Duty Cycle: 1:1

Medium parameters used: $f = 1900 \text{ MHz}$; $\sigma = 1.411 \text{ S/m}$; $\epsilon_r = 38.72$; $\rho = 1000 \text{ kg/m}^3$

DASY5 Configuration:

- Probe: EX3DV4 - SN7557;ConvF(8.36, 8.36, 8.36); Calibrated: 10/4/2019;
- Sensor-Surface: 1.4mm (Mechanical Surface Detection)
- Electronics: DAE4 Sn527; Calibrated: 7/9/2019
- Phantom: ELI V8.0; Type: QD OVA 004 Ax; Serial: 2095
- Measurement SW: DASY52, Version 52.10 (1); SEMCAD X Version 14.6.11 (7437)

Pin=250mW/Area Scan (101x141x1): Interpolated grid: $dx=1.500 \text{ mm}$, $dy=1.500 \text{ mm}$
 Maximum value of SAR (interpolated) = 12.1 W/kg

Pin=250mW/Zoom Scan (7x7x7)/Cube 0: Measurement grid: $dx=8\text{mm}$, $dy=8\text{mm}$, $dz=5\text{mm}$
 Reference Value = 96.75 V/m; Power Drift = -0.06 dB

Peak SAR (extrapolated) = 19.2 W/kg

SAR(1 g) = 10.3 W/kg; SAR(10 g) = 5.33 W/kg

Maximum value of SAR (measured) = 11.6 W/kg

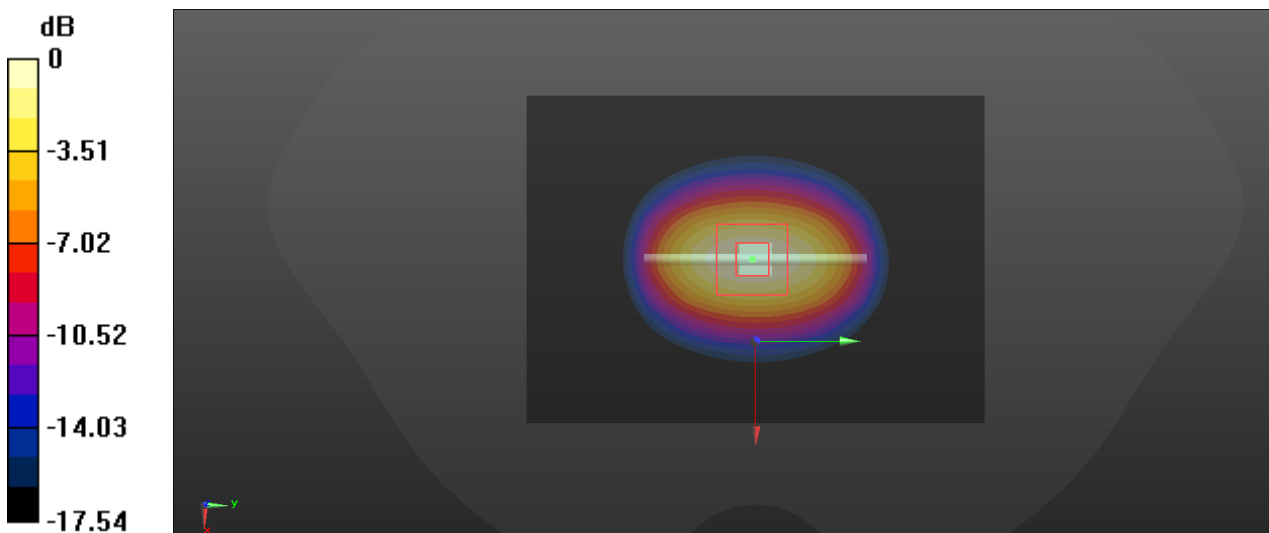

$0 \text{ dB} = 11.6 \text{ W/kg} = 10.64 \text{ dBW/kg}$

System Check_Head_2450MHz

DUT: Dipole 2450 MHz D2450V2; Type: D2450V2; Serial: D2450V2 - SN:970

Communication System: UID 0, Systemperformance Check 2450MHz (0); Frequency: 2450 MHz;Duty Cycle: 1:1

Medium parameters used: $f = 2450 \text{ MHz}$; $\sigma = 1.876 \text{ S/m}$; $\epsilon_r = 39.225$; $\rho = 1000 \text{ kg/m}^3$

DASY5 Configuration:

- Probe: EX3DV4 - SN7557;ConvF(7.41, 7.41, 7.41); Calibrated: 10/4/2019;
- Sensor-Surface: 4mm (Mechanical Surface Detection)
- Electronics: DAE4 Sn527; Calibrated: 6/13/2019
- Phantom: Twin-SAM; Type: QD 000 P41 Ax; Serial: 1963
- Measurement SW: DASY52, Version 52.10 (1); SEMCAD X Version 14.6.11 (7437)

Pin=250mW/2450MHz 2/Area Scan (101x121x1): Interpolated grid: $dx=1.200 \text{ mm}$, $dy=1.200 \text{ mm}$

Maximum value of SAR (interpolated) = 15.6 W/kg

Pin=250mW2450MHz 2/Zoom Scan (7x7x7)/Cube 0: Measurement grid: $dx=5\text{mm}$, $dy=5\text{mm}$, $dz=5\text{mm}$

Reference Value = 89.74 V/m; Power Drift = 0.01 dB

Peak SAR (extrapolated) = 28.8 W/kg

SAR(1 g) = 13.6 W/kg; SAR(10 g) = 6.32 W/kg

Maximum value of SAR (measured) = 15.6 W/kg

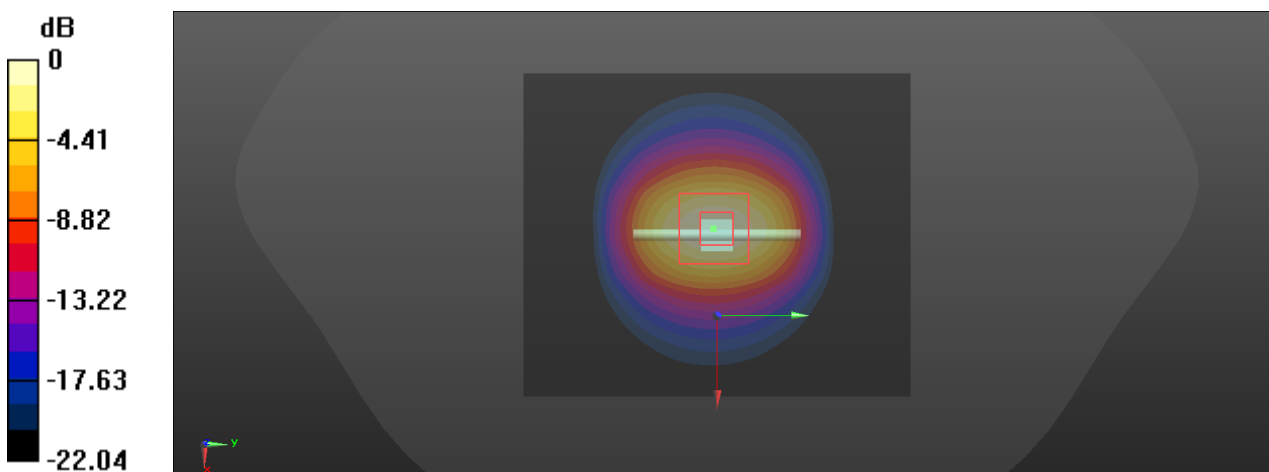

0 dB = 15.6 W/kg = 11.93 dBW/kg

System Check_Head_2600MHz

DUT: Dipole 2600 MHz D2600V2; Type: D2600V2; Serial: D2600V2 - SN:1162

Communication System: UID 0, Systemperformance Check MHz (0); Frequency: 2600 MHz;Duty Cycle: 1:1

Medium parameters used: $f = 2600 \text{ MHz}$; $\sigma = 1.999 \text{ S/m}$; $\epsilon_r = 37.519$; $\rho = 1000 \text{ kg/m}^3$

DASY5 Configuration:

- Probe: EX3DV4 - SN7557;ConvF(7.21, 7.21, 7.21); Calibrated: 10/4/2019;
- Sensor-Surface: 1.4mm (Mechanical Surface Detection)
- Electronics: DAE4 Sn527; Calibrated: 7/9/2020
- Phantom: ELI V8.0; Type: QD OVA 004 Ax; Serial: 2095
- Measurement SW: DASY52, Version 52.10 (1); SEMCAD X Version 14.6.11 (7437)

Pin=250mW/Area Scan (81x121x1): Interpolated grid: $dx=1.200 \text{ mm}$, $dy=1.200 \text{ mm}$
 Maximum value of SAR (interpolated) = 15.3 W/kg

Pin=250mW/Zoom Scan (7x7x7)/Cube 0: Measurement grid: $dx=5\text{mm}$, $dy=5\text{mm}$, $dz=5\text{mm}$
 Reference Value = 93.07 V/m; Power Drift = -0.02 dB

Peak SAR (extrapolated) = 26.5 W/kg

SAR(1 g) = 13.1 W/kg; SAR(10 g) = 6.27 W/kg

Maximum value of SAR (measured) = 14.9 W/kg

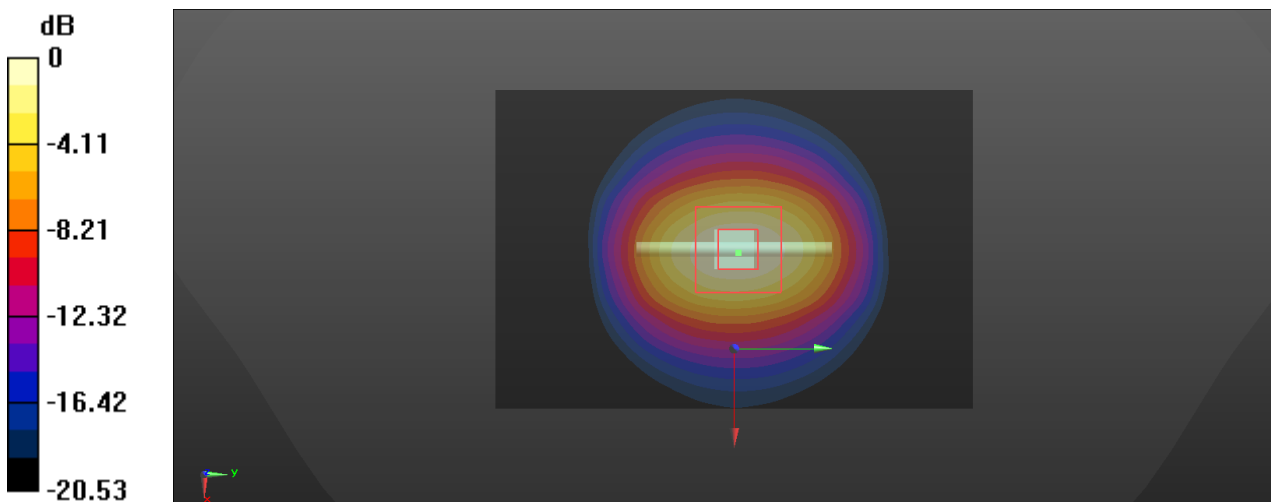

0 dB = 14.9 W/kg = 11.73 dBW/kg

System Check_Head_5250MHz

DUT: D5GHzV2; Type: D5GHzV2; Serial: D5GHzV2 - SN:1296

Communication System: UID 0, CW (0); Frequency: 5250 MHz;Duty Cycle: 1:1
 Medium parameters used: $f = 5250 \text{ MHz}$; $\sigma = 4.606 \text{ S/m}$; $\epsilon_r = 36.725$; $\rho = 1000 \text{ kg/m}^3$

DASY5 Configuration:

- Probe: EX3DV4 - SN7557;ConvF(5.38, 5.38, 5.38); Calibrated: 10/4/2019;
- Sensor-Surface: 1.4mm (Mechanical Surface Detection)
- Electronics: DAE4 Sn527; Calibrated: 7/9/2020
- Phantom: ELI V8.0; Type: QD OVA 004 Ax; Serial: 2095
- Measurement SW: DASY52, Version 52.10 (1); SEMCAD X Version 14.6.11 (7437)

Pin=100mW/Area Scan (71x71x1): Interpolated grid: $dx=1.000 \text{ mm}$, $dy=1.000 \text{ mm}$
 Maximum value of SAR (interpolated) = 17.7 W/kg

/Zoom Scan (7x7x7)/Cube 0: Measurement grid: $dx=4\text{mm}$, $dy=4\text{mm}$, $dz=1.4\text{mm}$

Reference Value = 66.99 V/m; Power Drift = -0.14 dB

Peak SAR (extrapolated) = 28.6 W/kg

SAR(1 g) = 7.39 W/kg; SAR(10 g) = 2.09 W/kg

Maximum value of SAR (measured) = 17.6 W/kg

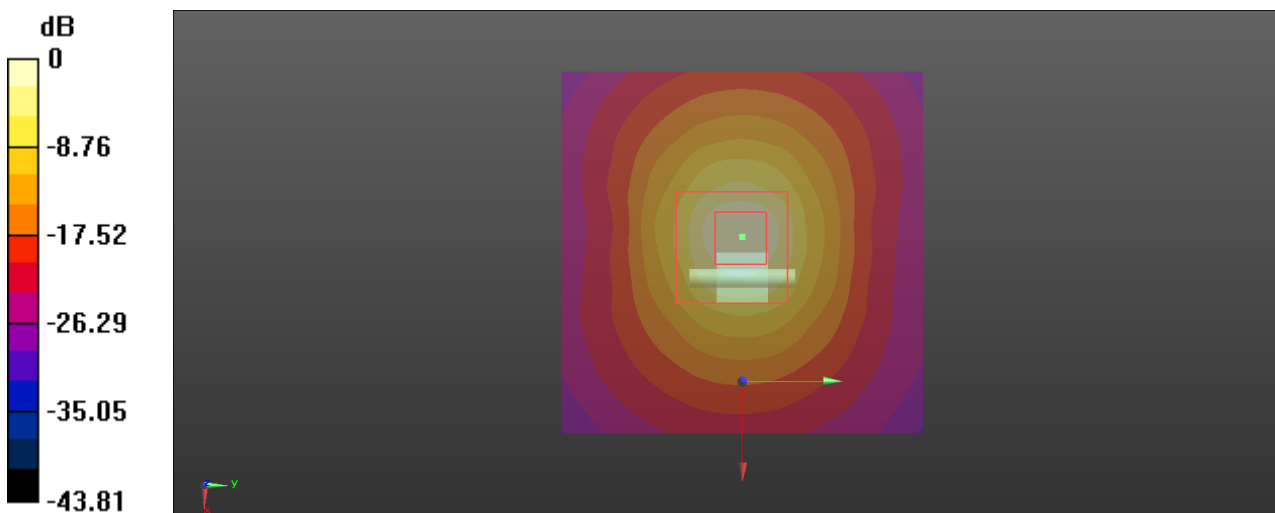

0 dB = 17.6 W/kg = 12.46 dBW/kg

System Check_Head_5800MHz

DUT: D5GHzV2; Type: D5GHzV2; Serial: D5GHzV2 - SN:1296

Communication System: UID 0, CW (0); Frequency: 5800 MHz;Duty Cycle: 1:1
 Medium parameters used: $f = 5800 \text{ MHz}$; $\sigma = 5.245 \text{ S/m}$; $\epsilon_r = 35.523$; $\rho = 1000 \text{ kg/m}^3$

DASY5 Configuration:

- Probe: EX3DV4 - SN7557;ConvF(4.70, 4.70, 4.70); Calibrated: 10/4/2019;
- Sensor-Surface: 1.4mm (Mechanical Surface Detection)
- Electronics: DAE4 Sn527; Calibrated: 7/9/2020
- Phantom: ELI V8.0; Type: QD OVA 004 Ax; Serial: 2095
- Measurement SW: DASY52, Version 52.10 (1); SEMCAD X Version 14.6.11 (7437)

Pin=100mW/Area Scan (71x71x1): Interpolated grid: $dx=1.000 \text{ mm}$, $dy=1.000 \text{ mm}$
 Maximum value of SAR (interpolated) = 22.2 W/kg

Pin=100mW/Zoom Scan (7x7x7)/Cube 0: Measurement grid: $dx=4\text{mm}$, $dy=4\text{mm}$, $dz=1.4\text{mm}$

Reference Value = 68.41 V/m; Power Drift = 0.03 dB

Peak SAR (extrapolated) = 40.3 W/kg

SAR(1 g) = 8.5 W/kg; SAR(10 g) = 2.33 W/kg

Maximum value of SAR (measured) = 22.2 W/kg

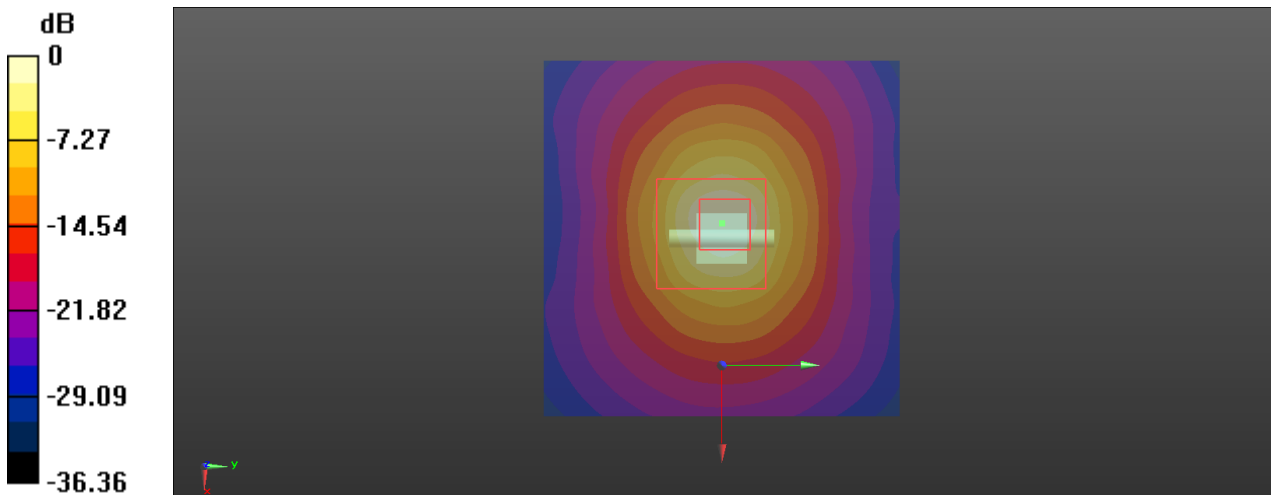

0 dB = 22.2 W/kg = 13.46 dBW/kg

EUT TEST STRATEGY AND METHODOLOGY

Test Positions for Device Operating Next to a Person’s Ear

This category includes most wireless handsets with fixed, retractable or internal antennas located toward the top half of the device, with or without a foldout, sliding or similar keypad cover. The handset should have its earpiece located within the upper ¼ of the device, either along the centerline or off-centered, as perceived by its users. This type of handset should be positioned in a normal operating position with the “test device reference point” located along the “vertical centerline” on the front of the device aligned to the “ear reference point”. The “test device reference point” should be located at the same level as the center of the earpiece region. The “vertical centerline” should bisect the front surface of the handset at its top and bottom edges. A “ear reference point” is located on the outer surface of the head phantom on each ear spacer. It is located 1.5 cm above the center of the ear canal entrance in the “phantom reference plane” defined by the three lines joining the center of each “ear reference point” (left and right) and the tip of the mouth.

A handset should be initially positioned with the earpiece region pressed against the ear spacer of a head phantom. For the SCC-34/SC-2 head phantom, the device should be positioned parallel to the “N-F” line defined along the base of the ear spacer that contains the “ear reference point”. For interim head phantoms, the device should be positioned parallel to the cheek for maximum RF energy coupling. The “test device reference point” is aligned to the “ear reference point” on the head phantom and the “vertical centerline” is aligned to the “phantom reference plane”. This is called the “initial ear position”. While maintaining these three alignments, the body of the handset is gradually adjusted to each of the following positions for evaluating SAR:

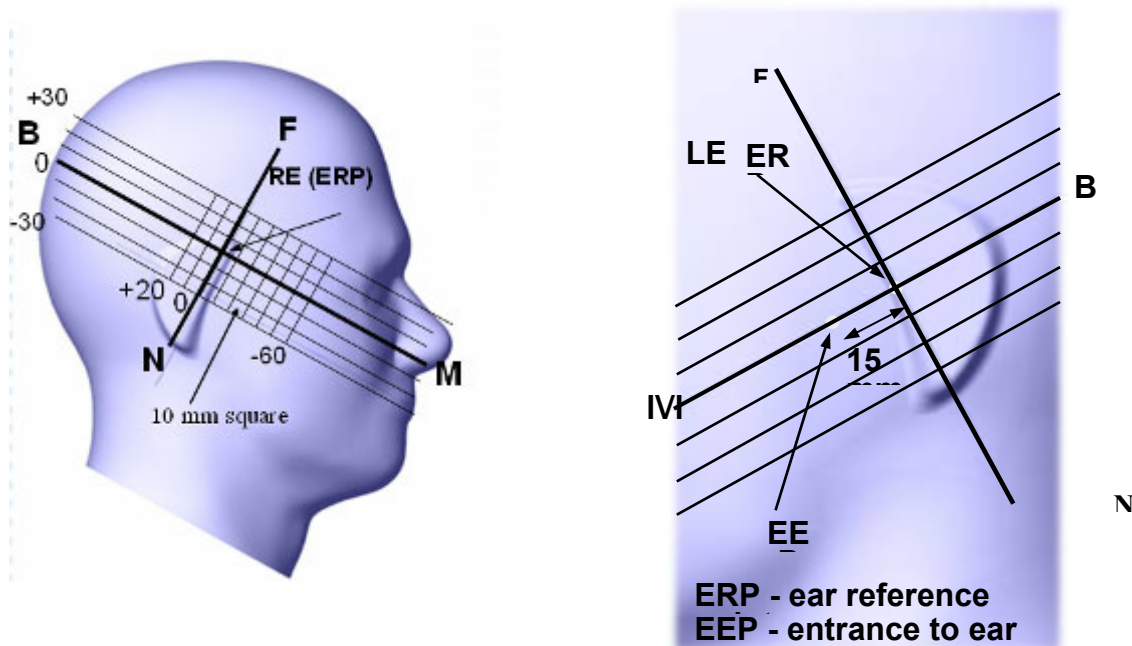

Cheek/Touch Position

The device is brought toward the mouth of the head phantom by pivoting against the “ear reference point” or along the “N-F” line for the SCC-34/SC-2 head phantom.

This test position is established:

When any point on the display, keypad or mouthpiece portions of the handset is in contact with the phantom.

(or) When any portion of a foldout, sliding or similar keypad cover opened to its intended self-adjusting normal use position is in contact with the cheek or mouth of the phantom.

For existing head phantoms – when the handset loses contact with the phantom at the pivoting point, rotation should continue until the device touches the cheek of the phantom or breaks its last contact from the ear spacer.

Cheek /Touch Position

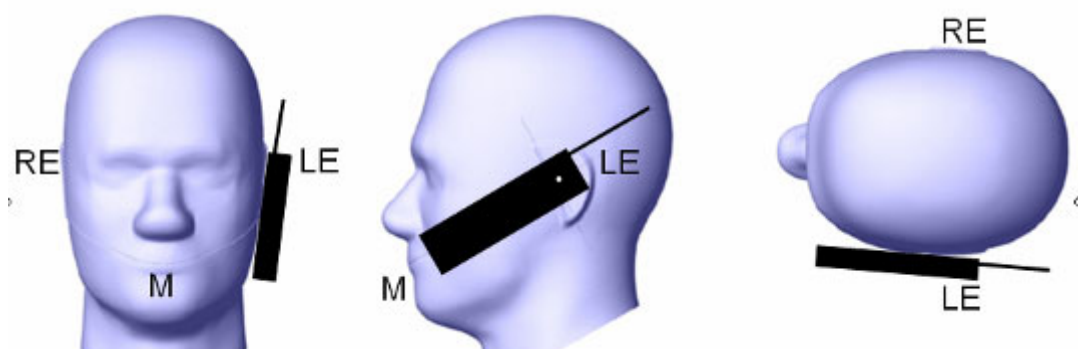

Ear/Tilt Position

With the handset aligned in the “Cheek/Touch Position”:

1) If the earpiece of the handset is not in full contact with the phantom’s ear spacer (in the “Cheek/Touch position”) and the peak SAR location for the “Cheek/Touch” position is located at the ear spacer region or corresponds to the earpiece region of the handset, the device should be returned to the “initial ear position” by rotating it away from the mouth until the earpiece is in full contact with the ear spacer.

2) (otherwise) The handset should be moved (translated) away from the cheek perpendicular to the line passes through both “ear reference points” (note: one of these ear reference points may not physically exist on a split head model) for approximate 2-3 cm. While it is in this position, the device handset is tilted away from the mouth with respect to the “test device reference point” until the inside angle between the vertical centerline on the front surface of the phone and the horizontal line passing through the ear reference point is by 15° to 80° . After the tilt, it is then moved (translated) back toward the head perpendicular to the line passes through both “ear reference points” until the device touches the phantom or the ear spacer. If the antenna touches the head first, the positioning process should be repeated with a tilt angle less than 15° so that the device and its antenna would touch the phantom simultaneously. This test position may require a device holder or positioner to achieve the translation and tilting with acceptable positioning repeatability.

If a device is also designed to transmit with its keypad cover closed for operating in the head position, such positions should also be considered in the SAR evaluation. The device should be tested on the left and right side of the head phantom in the “Cheek/Touch” and “Ear/Tilt” positions. When applicable, each configuration should be tested with the antenna in its fully extended and fully retracted positions. These test configurations should be tested at the high, middle and low frequency channels of each operating mode; for example, AMPS, CDMA, and TDMA. If the SAR measured at the middle channel for each test configuration (left, right, Cheek/Touch, Tilt/Ear, extended and retracted) is at least 2.0 dB lower than the SAR limit, testing at the high and low channels is optional for such test configuration(s). If the transmission band of the test device is less than 10 MHz, testing at the high and low frequency channels is optional.

Ear /Tilt 15° Position

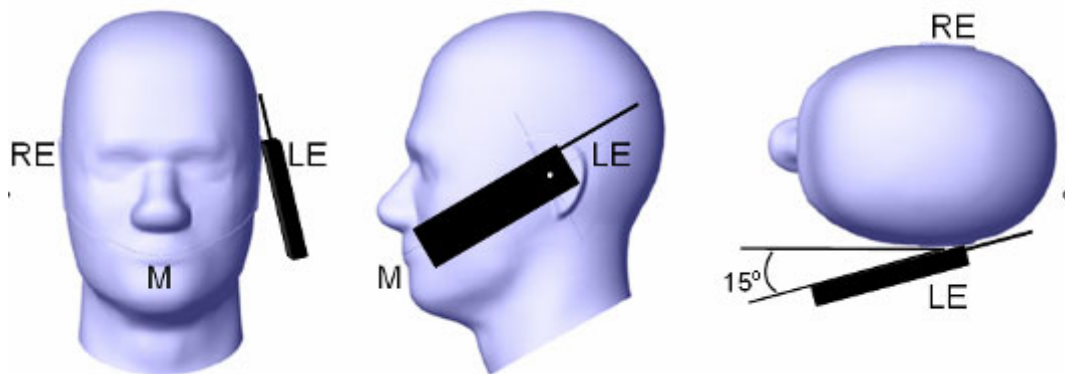

Test positions for body-worn and other configurations

Body-worn operating configurations should be tested with the belt-clips and holsters attached to the device and positioned against a flat phantom in normal use configurations. Devices with a headset output should be tested with a headset connected to the device. When multiple accessories that do not contain metallic components are supplied with the device, the device may be tested with only the accessory that dictates the closest spacing to the body. When multiple accessories that contain metallic components are supplied with the device, the device must be tested with each accessory that contains a unique metallic component. If multiple accessories share an identical metallic component (e.g., the same metallic belt-clip used with different holsters with no other metallic components), only the accessory that dictates the closest spacing to the body must be tested.

Body-worn accessories may not always be supplied or available as options for some devices that are intended to be authorized for body-worn use. A separation distance of 1.5 cm between the back of the device and a flat phantom is recommended for testing body-worn SAR compliance under such circumstances. Other separation distances may be used, but they should not exceed 2.5 cm. In these cases, the device may use body-worn accessories that provide a separation distance greater than that tested for the device provided however that the accessory contains no metallic components.

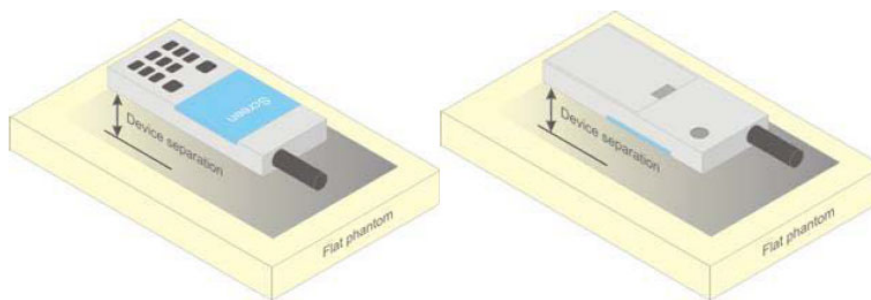

Figure 5 – Test positions for body-worn devices

Test Distance for SAR Evaluation

In this case the EUT(Equipment Under Test) is set against from the phantom, the test distance is 0mm.

SAR Evaluation Procedure

The evaluation was performed with the following procedure:

Step 1: Measurement of the SAR value at a fixed location above the ear point or central position was used as a reference value for assessing the power drop. The SAR at this point is measured at the start of the test and then again at the end of the testing.

Step 2: The SAR distribution at the exposed side of the head was measured at a distance of 4 mm from the inner surface of the shell. The area covered the entire dimension of the head or radiating structures of the EUT, the horizontal grid spacing was 15 mm x 15 mm, and the SAR distribution was determined by integrated grid of 1.5mm x 1.5mm. Based on these data, the area of the maximum absorption was determined by spline interpolation. The first Area Scan covers the entire dimension of the EUT to ensure that the hotspot was correctly identified.

Step 3: Around this point, a volume of 30 mm x 30 mm x 30 mm was assessed by measuring 7x 7 x 7 points. On the basis of this data set, the spatial peak SAR value was evaluated under the following procedure:

1) The data at the surface were extrapolated, since the center of the dipoles is 1.2 mm away from the tip of the probe and the distance between the surface and the lowest measuring point is 1.3 mm. The extrapolation was based on a least square algorithm. A polynomial of the fourth order was calculated through the points in z-axes. This polynomial was then used to evaluate the points between the surface and the probe tip.

2) The maximum interpolated value was searched with a straightforward algorithm. Around this maximum the SAR values averaged over the spatial volumes (1 g or 10 g) were computed by the 3D-Spline interpolation algorithm. The 3D-Spline is composed of three one dimensional splines with the "Not a knot"-condition (in x, y and z-directions). The volume was integrated with the trapezoidal-algorithm. One thousand points (10 x 10 x 10) were interpolated to calculate the averages.

All neighboring volumes were evaluated until no neighboring volume with a higher average value was found.

Step 4: Re-measurement of the SAR value at the same location as in Step 1. If the value changed by more than 5%, the evaluation was repeated.

CONDUCTED OUTPUT POWER MEASUREMENT

Provision Applicable

The measured peak output power should be greater and within 5% than EMI measurement.

Test Procedure

The RF output of the transmitter was connected to the input of the EMI Test Receiver through Connector.

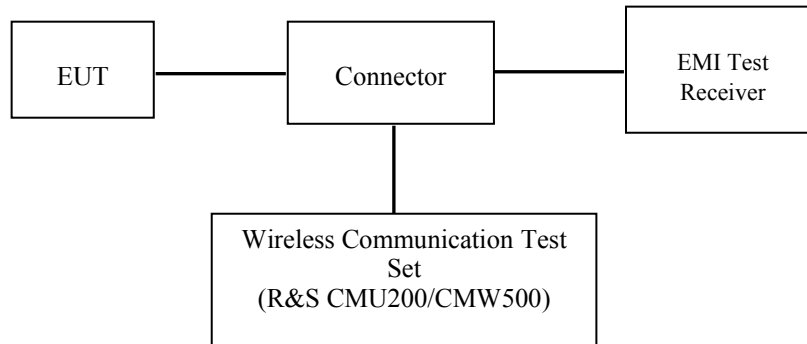

GSM/WCDMA/CDMA/LTE

Radio Configuration

The power measurement was configured by the Wireless Communication Test Set.

GSM/GPRS/EGPRS

Function: Menu select > GSM Mobile Station > GSM 850/1900

Press Connection control to choose the different menus

Press RESET > choose all the reset all settings

Connection Press Signal Off to turn off the signal and change settings

Network Support > GSM + GPRS or GSM + EGSM

Main Service > Packet Data

Service selection > Test Mode A – Auto Slot Config. off

MS Signal Press Slot Config Bottom on the right twice to select and change the number of time slots and power setting

> Slot configuration > Uplink/Gamma

> 33 dBm for GPRS 850

> 30 dBm for GPRS 1900

> 27 dBm for EGPRS 850

> 26 dBm for EGPRS 1900

BS Signal Enter the same channel number for TCH channel (test channel) and BCCH channel

Frequency Offset > + 0 Hz

Mode > BCCH and TCH

BCCH Level > -85 dBm (May need to adjust if link is not stable)

BCCH Channel > choose desired test channel [Enter the same channel number for TCH channel (test channel) and BCCH channel]

Channel Type > Off

P0 > 4 dB

Slot Config > Unchanged (if already set under MS signal)

TCH > choose desired test channel

Hopping > Off

Main Timeslot > 3

Network Coding Scheme > CS4 (GPRS) and MCS5 (EGPRS)

Bit Stream > 2E9-1 PSR Bit Stream

AF/RF Enter appropriate offsets for Ext. Att. Output and Ext. Att. Input

Connection Press Signal on to turn on the signal and change settings

WCDMA Release 99

The following tests were conducted according to the test requirements outlines in section 5.2 of the 3GPP TS34.121-1 specification. The EUT has a nominal maximum output power of 24dBm (+1.7/-3.7).

| | | |
|-----------------------------------|-------------------------|--------------|
| WCDMA General Settings | Loopback Mode | Test Mode 1 |
| | Rel99 RMC | 12.2kbps RMC |
| | Power Control Algorithm | Algorithm2 |
| | β_c/β_d | 8/15 |

HSDPA

The following tests were conducted according to the test requirements outlines in section 5.2 of the 3GPP TS34.121-1 specification.

| | Mode | HSDPA | HSDPA | HSDPA | HSDPA |
|------------------------------------|-----------------------------|--------------|-------|-------|-------|
| | Subset | 1 | 2 | 3 | 4 |
| WCDMA General Settings | Loopback Mode | Test Mode 1 | | | |
| | Rel99 RMC | 12.2kbps RMC | | | |
| | HSDPA FRC | H-Set1 | | | |
| | Power Control Algorithm | Algorithm2 | | | |
| | β_c | 2/15 | 12/15 | 15/15 | 15/15 |
| | β_d | 15/15 | 15/15 | 8/15 | 4/15 |
| | $\beta_d(SF)$ | 64 | | | |
| | β_c/β_d | 2/15 | 12/15 | 15/8 | 15/4 |
| | β_{hs} | 4/15 | 24/15 | 30/15 | 30/15 |
| MPR(dB) | 0 | 0 | 0.5 | 0.5 | |
| HSDPA Specific Settings | DACK | 8 | | | |
| | DNAK | 8 | | | |
| | DCQI | 8 | | | |
| | Ack-Nack repetition factor | 3 | | | |
| | CQI Feedback | 4ms | | | |
| | CQI Repetition Factor | 2 | | | |
| | $A_{hs}=\beta_{hs}/\beta_c$ | 30/15 | | | |

HSUPA

The following tests were conducted according to the test requirements outlines in section 5.2 of the 3GPP TS34.121-1 specification.

| | Mode | HSUPA | HSUPA | HSUPA | HSUPA | HSUPA |
|--------------------------------|----------------------------------|--|--|--|--|--------------|
| | Subset | 1 | 2 | 3 | 4 | 5 |
| WCDMA General Settings | Loopback Mode | Test Mode 1 | | | | |
| | Rel99 RMC | 12.2kbps RMC | | | | |
| | HSDPA FRC | H-Set1 | | | | |
| | HSUPA Test | HSUPA Loopback | | | | |
| | Power Control Algorithm | Algorithm2 | | | | |
| | β_c | 11/15 | 6/15 | 15/15 | 2/15 | 15/15 |
| | β_d | 15/15 | 15/15 | 9/15 | 15/15 | 0 |
| | β_{cc} | 209/225 | 12/15 | 30/15 | 2/15 | 5/15 |
| | β_c / β_d | 11/15 | 6/15 | 15/9 | 2/15 | - |
| | β_{hs} | 22/15 | 12/15 | 30/15 | 4/15 | 5/15 |
| | CM(dB) | 1.0 | 3.0 | 2.0 | 3.0 | 1.0 |
| MPR(dB) | 0 | 2 | 1 | 2 | 0 | |
| HSDPA Specific Settings | DACK | 8 | | | | |
| | DNAK | 8 | | | | |
| | DCQI | 8 | | | | |
| | Ack-Nack repetition factor | 3 | | | | |
| | CQI Feedback | 4ms | | | | |
| | CQI Repetition Factor | 2 | | | | |
| | $A_{hs} = \beta_{hs} / \beta_c$ | 30/15 | | | | |
| HSUPA Specific Settings | DE-DPCCH | 6 | 8 | 8 | 5 | 7 |
| | DHARQ | 0 | 0 | 0 | 0 | 0 |
| | AG Index | 20 | 12 | 15 | 17 | 21 |
| | ETFCI | 75 | 67 | 92 | 71 | 81 |
| | Associated Max UL Data Rate kbps | 242.1 | 174.9 | 482.8 | 205.8 | 308.9 |
| | Reference E_FCIs | E-TFCI 11 E E-TFCI PO 4 E-TFCI 67 E-TFCI PO 18 E-TFCI 71 E-TFCI PO23 E-TFCI 75 E-TFCI PO26 E-TFCI 81 E-TFCI PO 27 | E-TFCI 11 E-TFCI PO4 E-TFCI 92 E-TFCI PO 18 | E-TFCI 11 E-TFCI PO4 E-TFCI 92 E-TFCI PO 18 | E-TFCI 11 E E-TFCI PO 4 E-TFCI 67 E-TFCI PO 18 E-TFCI 71 E-TFCI PO23 E-TFCI 75 E-TFCI PO26 E-TFCI 81 E-TFCI PO 27 | |

DC-HSDPA

The following tests were conducted according to the test requirements in Table C.8.1.12 of 3GPP TS 34.121-1

Table C.8.1.12: Fixed Reference Channel H-Set 12

| Parameter | Unit | Value |
|--|-----------|-------|
| Nominal Avg. Inf. Bit Rate | kbps | 60 |
| Inter-TTI Distance | TTI's | 1 |
| Number of HARQ Processes | Processes | 6 |
| Information Bit Payload (N_{INF}) | Bits | 120 |
| Number Code Blocks | Blocks | 1 |
| Binary Channel Bits Per TTI | Bits | 960 |
| Total Available SML's in UE | SML's | 19200 |
| Number of SML's per HARQ Proc. | SML's | 3200 |
| Coding Rate | | 0.15 |
| Number of Physical Channel Codes | Codes | 1 |
| Modulation | | QPSK |
| Note 1: The RMC is intended to be used for DC-HSDPA mode and both cells shall transmit with identical parameters as listed in the table. Note 2: Maximum number of transmission is limited to 1, i.e., retransmission is not allowed. The redundancy and constellation version 0 shall be used. | | |

HSPA+

| Sub-test | β_c (Note3) | β_d | β_{HS} (Note1) | β_{ec} | β_{ed} (2xSF2) (Note 4) | β_{ed} (2xSF4) (Note 4) | CM (dB) (Note 2) | MPR (dB) (Note 2) | AG Index (Note 4) | E-TFCI (Note 5) | E-TFCI (boost) |
|---|----------------------|-----------|-------------------------|--------------|--|--|------------------------|-------------------------|-------------------------|--------------------|-------------------|
| 1 | 1 | 0 | 30/15 | 30/15 | β_{ed1} : 30/15 β_{ed2} : 30/15 | β_{ed3} : 24/15 β_{ed4} : 24/15 | 3.5 | 2.5 | 14 | 105 | 105 |
| Note 1: $\Delta_{ACK}, \Delta_{NACK}$ and $\Delta_{CQI} = 30/15$ with $\beta_{hs} = 30/15 * \beta_c$. Note 2: CM = 3.5 and the MPR is based on the relative CM difference, MPR = MAX(CM-1,0). Note 3: DPDCH is not configured, therefore the β_c is set to 1 and $\beta_d = 0$ by default. Note 4: β_{ed} can not be set directly; it is set by Absolute Grant Value. Note 5: All the sub-tests require the UE to transmit 2SF2+2SF4 16QAM EDCH and they apply for UE using E-DPDCH category 7. E-DCH TTI is set to 2ms TTI and E-DCH table index = 2. To support these E-DCH configurations DPDCH is not allocated. The UE is signalled to use the extrapolation algorithm. | | | | | | | | | | | |

The following tests were conducted according to the test requirements in Table C.11.1.4 of 3GPP TS 34.121-1

LTE

For UE Power Class 1 and 3, the allowed Maximum Power Reduction (MPR) for the maximum output power in Table 6.2.2-1 due to higher order modulation and transmit bandwidth configuration (resource blocks) is specified in Table 6.2.3-1.

Table 6.2.3-1: Maximum Power Reduction (MPR) for Power Class 1 and 3

| Modulation | Channel bandwidth / Transmission bandwidth (N_{RB}) | | | | | | MPR (dB) |
|------------|---|---------|-------|--------|--------|--------|----------|
| | 1.4 MHz | 3.0 MHz | 5 MHz | 10 MHz | 15 MHz | 20 MHz | |
| QPSK | > 5 | > 4 | > 8 | > 12 | > 16 | > 18 | ≤ 1 |
| 16 QAM | ≤ 5 | ≤ 4 | ≤ 8 | ≤ 12 | ≤ 16 | ≤ 18 | ≤ 1 |
| 16 QAM | > 5 | > 4 | > 8 | > 12 | > 16 | > 18 | ≤ 2 |

For UE Power Class 1 and 3 the specific requirements and identified sub clauses are specified in Table 6.2.4-1 along with the allowed A-MPR values that may be used to meet these requirements. The allowed A-MPR values specified below in Table 6.2.4-1 to 6.2.4-15 are in addition to the allowed MPR requirements specified in sub clause 6.2.3.

Table 6.2.4-1: Additional Maximum Power Reduction (A-MPR)

| Network Signalling value | Requirements (subclause) | E-UTRA Band | Channel bandwidth (MHz) | Resources Blocks (N_{RB}) | A-MPR (dB) |
|--------------------------|-------------------------------|--------------------------|-------------------------|--|------------|
| NS_01 | 6.6.2.1.1 | Table 5.5-1 | 1.4, 3, 5, 10, 15, 20 | Table 5.6-1 | N/A |
| NS_03 | 6.6.2.2.1 | 2, 4, 10, 23, 25, 35, 36 | 3 | >5 | ≤ 1 |
| | | | 5 | >6 | ≤ 1 |
| | | | 10 | >6 | ≤ 1 |
| | | | 15 | >8 | ≤ 1 |
| | | | 20 | >10 | ≤ 1 |
| NS_04 | 6.6.2.2.2 | 41 | 5 | >6 | ≤ 1 |
| | | | 10, 15, 20 | Table 6.2.4-4 | |
| NS_05 | 6.6.3.3.1 | 1 | 10, 15, 20 | ≥ 50 | ≤ 1 |
| NS_06 | 6.6.2.2.3 | 12, 13, 14, 17 | 1.4, 3, 5, 10 | Table 5.6-1 | N/A |
| NS_07 | 6.6.2.2.3 | 13 | 10 | Table 6.2.4-2 | |
| NS_08 | 6.6.3.3.2 | | | | |
| NS_09 | 6.6.3.3.3 | 19 | 10, 15 | > 44 | ≤ 3 |
| | | | | > 40 | ≤ 1 |
| | | | | > 55 | ≤ 2 |
| NS_10 | | 20 | 15, 20 | Table 6.2.4-3 | |
| NS_11 | 6.6.2.2.1 | 23 | 1.4, 3, 5, 10, 15, 20 | Table 6.2.4-5 | |
| NS_12 | 6.6.3.3.5 | 26 | 1.4, 3, 5 | Table 6.2.4-6 | |
| NS_13 | 6.6.3.3.6 | 26 | 5 | Table 6.2.4-7 | |
| NS_14 | 6.6.3.3.7 | 26 | 10, 15 | Table 6.2.4-8 | |
| NS_15 | 6.6.3.3.8 | 26 | 1.4, 3, 5, 10, 15 | Table 6.2.4-9 | |
| | | | | Table 6.2.4-10 | |
| NS_16 | 6.6.3.3.9 | 27 | 3, 5, 10 | Table 6.2.4-11, Table 6.2.4-12, Table 6.2.4-13 | |
| NS_17 | 6.6.3.3.10 | 28 | 5, 10 | Table 5.6-1 | N/A |
| NS_18 | 6.6.3.3.11 | 28 | 5 | ≥ 2 | ≤ 1 |
| | | | 10, 15, 20 | ≥ 1 | ≤ 4 |
| NS_19 | 6.6.3.3.12 | 44 | 10, 15, 20 | Table 6.2.4-14 | |
| NS_20 | 6.2.2 6.6.2.2.1 6.6.3.2 | 23 | 5, 10, 15, 20 | Table 6.2.4-15 | |
| ... | | | | | |
| NS_32 | - | - | - | - | - |

Maximum Target Output Power

| Max Target Power(dBm) | | | |
|------------------------------|----------------|---------------|-------------|
| Mode/Band | Channel | | |
| | Low | Middle | High |
| GSM850 | 34 | 34 | 34 |
| GPRS 4 TX Slot | 30 | 30 | 30 |
| DCS1900 | 32 | 32 | 32 |
| GPRS 4 TX Slot | 27 | 27 | 27 |
| WCDMA Band 5 | 23 | 23 | 23 |
| WCDMA Band 2 | 23 | 23 | 23 |
| CDMA | 22.5 | 22.5 | 22.5 |
| LTE Band 2 | 23.5 | 23.5 | 23.5 |
| LTE Band 4 | 23 | 23 | 23 |
| LTE Band 5 | 24.5 | 24.5 | 24.5 |
| LTE Band 7 | 23 | 23 | 23 |
| LTE Band 17 | 22.5 | 22.5 | 22.5 |
| LTE Band 41 | 22.5 | 22.5 | 22.5 |
| WLAN(2.4G) | 14 | 15 | 14 |
| Bluetooth | 6.5 | 7.5 | 4.5 |
| BLE | 2 | 3 | 0.5 |
| WLAN(5.2G) | 15 | 15 | 13 |
| WLAN(5.8G) | 10.8 | 10 | 10 |

Test Results:

GSM

| Mode | Channel | Frequency (MHz) | Average Output Power (dBm) |
|----------|---------|-----------------|----------------------------|
| GSM 850 | 128 | 824.2 | 33.48 |
| | 190 | 836.6 | 33.36 |
| | 251 | 848.8 | 33.19 |
| PCS 1900 | 512 | 1850.2 | 30.58 |
| | 661 | 1880 | 30.64 |
| | 810 | 1909.8 | 30.98 |

GPRS:

| Band | Channel No. | Frequency (MHz) | RF Output Power (dBm) | | | |
|----------|-------------|-----------------|-----------------------|---------|---------|---------|
| | | | 1 slot | 2 slots | 3 slots | 4 slots |
| GSM 850 | 128 | 824.2 | 32.02 | 31.20 | 30.27 | 29.34 |
| | 190 | 836.6 | 32.26 | 31.55 | 30.63 | 29.56 |
| | 251 | 848.8 | 32.31 | 31.68 | 30.47 | 29.40 |
| PCS 1900 | 512 | 1850.2 | 29.34 | 28.84 | 27.84 | 26.68 |
| | 661 | 1880.0 | 28.96 | 28.70 | 27.70 | 26.75 |
| | 810 | 1909.8 | 28.67 | 27.93 | 26.86 | 25.77 |

EDGE:

| Band | Channel No. | Frequency (MHz) | RF Output Power (dBm) | | | |
|----------|-------------|-----------------|-----------------------|---------|---------|---------|
| | | | 1 slot | 2 slots | 3 slots | 4 slots |
| GSM 850 | 128 | 824.2 | 25.99 | 25.05 | 24.04 | 22.90 |
| | 190 | 836.6 | 26.23 | 25.32 | 24.19 | 23.09 |
| | 251 | 848.8 | 26.25 | 25.30 | 24.23 | 23.10 |
| PCS 1900 | 512 | 1850.2 | 24.97 | 23.94 | 22.88 | 21.77 |
| | 661 | 1880.0 | 24.69 | 23.60 | 22.46 | 21.35 |
| | 810 | 1909.8 | 24.54 | 23.42 | 22.33 | 21.08 |

For SAR, the time based average power is relevant, the difference in between depends on the duty cycle of the TDMA signal.

| Number of Time slot | 1 | 2 | 3 | 4 |
|--|-------|-------|----------|-------|
| Duty Cycle | 1:8 | 1:4 | 1:2.66 | 1:2 |
| Time based Ave. power compared to slotted Ave. power | -9 dB | -6 dB | -4.25 dB | -3 dB |
| Crest Factor | 8 | 4 | 2.66 | 2 |

The time based average power for GSM

| Mode | Channel | Frequency (MHz) | Average Output Power (dBm) |
|----------|---------|-----------------|----------------------------|
| GSM 850 | 128 | 824.2 | 24.48 |
| | 190 | 836.6 | 24.36 |
| | 251 | 848.8 | 24.19 |
| PCS 1900 | 512 | 1850.2 | 21.58 |
| | 661 | 1880 | 21.64 |
| | 810 | 1909.8 | 21.98 |

The time based average power for GPRS

| Band | Channel No. | Frequency (MHz) | Time based average Power (dBm) | | | |
|----------|-------------|-----------------|--------------------------------|--------|---------|---------|
| | | | 1 slot | 2 slot | 3 slots | 4 slots |
| GSM 850 | 128 | 824.2 | 23.02 | 25.2 | 26.01 | 26.34 |
| | 190 | 836.6 | 23.26 | 25.55 | 26.37 | 26.56 |
| | 251 | 848.8 | 23.31 | 25.68 | 26.21 | 26.40 |
| PCS 1900 | 512 | 1850.2 | 20.34 | 22.84 | 23.58 | 23.68 |
| | 661 | 1880 | 19.96 | 22.7 | 23.44 | 23.75 |
| | 810 | 1909.8 | 19.67 | 21.93 | 22.60 | 22.77 |

The time based average power for EDGE

| Band | Channel No. | Frequency (MHz) | Time based average Power (dBm) | | | |
|----------|-------------|-----------------|--------------------------------|--------|---------|---------|
| | | | 1 slot | 2 slot | 3 slots | 4 slots |
| GSM 850 | 128 | 824.2 | 16.99 | 19.05 | 19.78 | 19.9 |
| | 190 | 836.6 | 17.23 | 19.32 | 19.93 | 20.09 |
| | 251 | 848.8 | 17.25 | 19.3 | 19.97 | 20.10 |
| PCS 1900 | 512 | 1850.2 | 15.97 | 17.94 | 18.62 | 18.77 |
| | 661 | 1880 | 15.69 | 17.6 | 18.2 | 18.35 |
| | 810 | 1909.8 | 15.54 | 17.42 | 18.07 | 18.08 |

Note:

1. Rohde & Schwarz Radio Communication Tester (CMU200) was used for the measurement of GSM peak and average output power for active timeslots.
2. For GSM voice, 1 timeslot has been activated with power level 5 (850 MHz band) and 0 (1900 MHz band).
3. For GPRS, 1, 2, 3 and 4 timeslots has been activated separately with power level 3(850 MHz band) and 3(1900 MHz band).
4. According to KDB941225D01-SAR for EGPRS mode are not required when the source-based time-averaged output power for data mode is lower than that in the normal GPRS mode.

WCDMA:

WCDMA Band II

| Mode | Test Condition | Test Mode | 3GPP Sub Test | Average Output Power (dBm) | | |
|-----------------|----------------|-----------|---------------|----------------------------|------------------|----------------|
| | | | | Low Frequency | Middle Frequency | High Frequency |
| WCDMA (Band II) | Normal | Rel 99 | 1 | 20.91 | 20.66 | 20.97 |
| | | HSDPA | 1 | 20.8 | 20.65 | 20.77 |
| | | | 2 | 20.82 | 20.58 | 20.58 |
| | | | 3 | 20.72 | 20.59 | 20.68 |
| | | | 4 | 20.71 | 20.45 | 20.69 |
| | | HSUPA | 1 | 20.71 | 20.56 | 20.74 |
| | | | 2 | 20.75 | 20.51 | 20.61 |
| | | | 3 | 20.78 | 20.58 | 20.66 |
| | | | 4 | 20.64 | 20.67 | 20.71 |
| | | | 5 | 20.67 | 20.58 | 20.65 |
| | | HSPA+ | 1 | 20.83 | 20.42 | 20.66 |

WCDMA Band V

| Mode | Test Condition | Test Mode | 3GPP Sub Test | Average Output Power (dBm) | | |
|----------------|----------------|-----------|---------------|----------------------------|------------------|----------------|
| | | | | Low Frequency | Middle Frequency | High Frequency |
| WCDMA (Band V) | Normal | Rel 99 | 1 | 22.32 | 22.54 | 22.28 |
| | | HSDPA | 1 | 22.04 | 22.01 | 22.19 |
| | | | 2 | 21.96 | 22.03 | 22.07 |
| | | | 3 | 22.09 | 21.93 | 22.00 |
| | | | 4 | 22.08 | 22.03 | 22.12 |
| | | HSUPA | 1 | 22.00 | 22.10 | 22.14 |
| | | | 2 | 22.02 | 22.09 | 22.17 |
| | | | 3 | 21.95 | 22.11 | 22.08 |
| | | | 4 | 22.03 | 22.09 | 22.16 |
| | | | 5 | 22.02 | 22.01 | 22.11 |
| | | HSPA+ | 1 | 22.06 | 22.08 | 22.09 |

CDMA

| Mode | Test Mode | Channel | Frequency (MHz) | Average Output Power (dBm) | Limit (dBm) |
|------|------------|---------|-----------------|----------------------------|-------------|
| CDMA | EVDO (BC0) | 1013 | 824.70 | 22.19 | 38.45 |
| | | 384 | 836.52 | 22.31 | 38.45 |
| | | 777 | 848.31 | 22.13 | 38.45 |

| Mode | Test Mode | Channel | Frequency (MHz) | Average Output Power (dBm) | Limit (dBm) |
|------|-----------|---------|-----------------|----------------------------|-------------|
| CDMA | 1xRTT | 1013 | 824.70 | 22.02 | 38.45 |
| | | 384 | 836.52 | 22.06 | 38.45 |
| | | 777 | 848.31 | 21.98 | 38.45 |

Note:

1. The default test configuration is to measure SAR with an established radio link between the EUT and a communication test set using a 12.2 kbps RMC (reference measurement Channel) Configured in Test Loop Model 1.
2. KDB 941225 D01-Body SAR is not required for HSDPA/HSUPA/HSPA+ when the maximum average output of each RF channel is less than ¼ dB higher than measured 12.2kbps RMC or the maximum SAR for 12.2kbps RMC is < 75% of SAR limit.

Maximum Output Power:

LTE Band 2

| Test Bandwidth | Test Modulation | Resource Block & RB offset | Low Channel (dBm) | Middle Channel (dBm) | High Channel (dBm) |
|----------------|-----------------|----------------------------|-------------------|----------------------|--------------------|
| 1.4M | QPSK | 1#0 | 20.78 | 20.88 | 21.46 |
| | | 1#3 | 20.96 | 21.03 | 21.21 |
| | | 1#5 | 20.86 | 20.47 | 21.5 |
| | | 3#0 | 21.25 | 20.46 | 20.42 |
| | | 3#1 | 21.42 | 20.89 | 20.65 |
| | | 3#3 | 20.93 | 21.29 | 20.53 |
| | | 6#0 | 21.13 | 21.22 | 21.23 |
| | 16-QAM | 1#0 | 21.11 | 20.93 | 20.55 |
| | | 1#3 | 21.65 | 21.01 | 20.66 |
| | | 1#5 | 21.64 | 20.57 | 20.62 |
| | | 3#0 | 20.87 | 20.42 | 21.16 |
| | | 3#1 | 21.5 | 21.36 | 21.43 |
| | | 3#3 | 21.69 | 20.5 | 21.38 |
| | | 6#0 | 21.4 | 20.72 | 20.36 |
| 3M | QPSK | 1#0 | 21.53 | 21.39 | 21.17 |
| | | 1#7 | 21.35 | 21.48 | 20.95 |
| | | 1#14 | 21.44 | 20.8 | 20.48 |
| | | 8#0 | 20.92 | 21.3 | 21.37 |
| | | 8#4 | 21.7 | 20.82 | 21.22 |
| | | 8#7 | 20.89 | 21.14 | 20.64 |
| | | 15#0 | 21.26 | 20.94 | 20.89 |
| | 16-QAM | 1#0 | 21.4 | 21.34 | 20.63 |
| | | 1#7 | 21.46 | 21.45 | 20.77 |
| | | 1#14 | 20.74 | 20.54 | 20.5 |
| | | 8#0 | 20.88 | 21.21 | 20.94 |
| | | 8#4 | 21.21 | 20.84 | 20.73 |
| | | 8#7 | 21.39 | 20.94 | 20.74 |
| | | 15#0 | 20.94 | 21.26 | 21.02 |

| Test Bandwidth | Test Modulation | Resource Block & RB offset | Low Channel (dBm) | Middle Channel (dBm) | High Channel (dBm) |
|----------------|-----------------|----------------------------|-------------------|----------------------|--------------------|
| 5M | QPSK | 1#0 | 21.57 | 20.64 | 20.64 |
| | | 1#12 | 21.02 | 20.54 | 20.66 |
| | | 1#24 | 21.31 | 20.76 | 20.76 |
| | | 12#0 | 21.14 | 20.66 | 21.41 |
| | | 12#6 | 21.82 | 20.43 | 20.99 |
| | | 12#11 | 21.11 | 20.62 | 21 |
| | | 25#0 | 21.15 | 21.18 | 20.69 |
| | 16-QAM | 1#0 | 20.92 | 20.59 | 21.27 |
| | | 1#12 | 21.6 | 20.79 | 21.21 |
| | | 1#24 | 21.58 | 21.27 | 20.63 |
| | | 12#0 | 21.44 | 20.88 | 20.57 |
| | | 12#6 | 21.79 | 20.79 | 20.68 |
| | | 12#11 | 21.37 | 20.69 | 20.56 |
| | | 25#0 | 21.79 | 20.85 | 21.03 |
| 10M | QPSK | 1#0 | 21.55 | 21.36 | 20.94 |
| | | 1#24 | 21.34 | 20.89 | 21.15 |
| | | 1#49 | 21.79 | 21.11 | 21.04 |
| | | 25#0 | 20.92 | 20.44 | 21.39 |
| | | 25#12 | 21.05 | 21.02 | 20.66 |
| | | 25#24 | 21.77 | 21.16 | 20.84 |
| | | 50#0 | 21.83 | 20.39 | 21.54 |
| | 16-QAM | 1#0 | 21.33 | 20.66 | 21.46 |
| | | 1#24 | 21.58 | 20.44 | 20.88 |
| | | 1#49 | 21.32 | 21.03 | 20.85 |
| | | 25#0 | 21.69 | 21.24 | 21.33 |
| | | 25#12 | 21.45 | 21.1 | 20.95 |
| | | 25#24 | 21.54 | 20.5 | 21.27 |
| | | 50#0 | 21 | 20.52 | 21.16 |

| Test Bandwidth | Test Modulation | Resource Block & RB offset | Low Channel (dBm) | Middle Channel (dBm) | High Channel (dBm) |
|----------------|-----------------|----------------------------|-------------------|----------------------|--------------------|
| 15M | QPSK | 1#0 | 21.87 | 21.93 | 21.22 |
| | | 1#37 | 21.85 | 21.38 | 21.07 |
| | | 1#74 | 21.97 | 21.29 | 21.06 |
| | | 36#0 | 21.33 | 21.48 | 21.08 |
| | | 36#17 | 21.94 | 21.38 | 20.94 |
| | | 36#35 | 21.9 | 21.29 | 21.16 |
| | | 75#0 | 21.64 | 21.8 | 21.55 |
| | 16-QAM | 1#0 | 21.38 | 21.66 | 21.68 |
| | | 1#37 | 21.28 | 21.9 | 20.85 |
| | | 1#74 | 21.46 | 21.4 | 21.15 |
| | | 36#0 | 21.79 | 21.58 | 21.08 |
| | | 36#17 | 21.83 | 21.68 | 21.36 |
| | | 36#35 | 21.64 | 21.71 | 20.79 |
| | | 75#0 | 21.3 | 21.95 | 21.17 |
| 20M | QPSK | 1#0 | 21.88 | 22.09 | 21.99 |
| | | 1#49 | 21.16 | 21.76 | 21.54 |
| | | 1#99 | 21.76 | 21.75 | 21.7 |
| | | 50#0 | 21.6 | 21.63 | 21.56 |
| | | 50#24 | 21.95 | 21.45 | 21.46 |
| | | 50#49 | 21.41 | 22.07 | 21.44 |
| | | 100#0 | 21.36 | 21.43 | 21.08 |
| | 16-QAM | 1#0 | 21.94 | 21.56 | 21.38 |
| | | 1#49 | 22.04 | 21.4 | 21.22 |
| | | 1#99 | 21.61 | 21.79 | 20.74 |
| | | 50#0 | 21.21 | 21.97 | 20.77 |
| | | 50#24 | 21.79 | 21.6 | 21.35 |
| | | 50#49 | 21.73 | 22.02 | 21.68 |
| | | 100#0 | 21.88 | 21.53 | 21.27 |

LTE Band 4

| Test Bandwidth | Test Modulation | Resource Block & RB offset | Low Channel (dBm) | Middle Channel (dBm) | High Channel (dBm) |
|----------------|-----------------|----------------------------|-------------------|----------------------|--------------------|
| 1.4M | QPSK | 1#0 | 20.82 | 20.69 | 21.05 |
| | | 1#3 | 20.93 | 21.3 | 21.45 |
| | | 1#5 | 21.51 | 21.49 | 21.66 |
| | | 3#0 | 20.89 | 21.6 | 21.48 |
| | | 3#1 | 21.81 | 21.08 | 21.6 |
| | | 3#3 | 21.25 | 20.89 | 21.83 |
| | | 6#0 | 21.27 | 21.41 | 21.11 |
| | 16-QAM | 1#0 | 21.25 | 21.06 | 21.73 |
| | | 1#3 | 21.38 | 20.87 | 21.74 |
| | | 1#5 | 21.47 | 20.85 | 21.36 |
| | | 3#0 | 21.06 | 21.33 | 21.86 |
| | | 3#1 | 21.57 | 20.69 | 21.8 |
| | | 3#3 | 21.79 | 21.27 | 21.31 |
| | | 6#0 | 21.7 | 21.01 | 21.6 |
| 3M | QPSK | 1#0 | 21.19 | 21.02 | 21.31 |
| | | 1#7 | 21.09 | 21.14 | 21.81 |
| | | 1#14 | 21.45 | 21.64 | 21.56 |
| | | 8#0 | 21.49 | 21.12 | 21.85 |
| | | 8#4 | 21.6 | 21.52 | 21.56 |
| | | 8#7 | 21.7 | 21.25 | 21.35 |
| | | 15#0 | 21.65 | 20.75 | 21.44 |
| | 16-QAM | 1#0 | 21.66 | 21.39 | 21.29 |
| | | 1#7 | 21.62 | 21.65 | 21.82 |
| | | 1#14 | 21.62 | 21.38 | 21.37 |
| | | 8#0 | 20.96 | 20.73 | 21.22 |
| | | 8#4 | 20.93 | 20.85 | 21.86 |
| | | 8#7 | 21.5 | 21.67 | 21.7 |
| | | 15#0 | 21.04 | 20.72 | 21.27 |

| Test Bandwidth | Test Modulation | Resource Block & RB offset | Low Channel (dBm) | Middle Channel (dBm) | High Channel (dBm) |
|----------------|-----------------|----------------------------|-------------------|----------------------|--------------------|
| 5M | QPSK | 1#0 | 20.68 | 20.79 | 20.79 |
| | | 1#12 | 21.31 | 21.63 | 21.31 |
| | | 1#24 | 21.16 | 21.25 | 21.32 |
| | | 12#0 | 20.72 | 21 | 21.4 |
| | | 12#6 | 20.8 | 20.91 | 21.73 |
| | | 12#11 | 21.65 | 21.61 | 21.8 |
| | | 25#0 | 21.29 | 21.1 | 21.35 |
| | 16-QAM | 1#0 | 21.55 | 21.17 | 21.49 |
| | | 1#12 | 20.86 | 20.86 | 21.77 |
| | | 1#24 | 21.08 | 21.33 | 21.56 |
| | | 12#0 | 20.74 | 21.22 | 21.74 |
| | | 12#6 | 20.72 | 20.99 | 21.01 |
| | | 12#11 | 21.57 | 21.61 | 21.15 |
| | | 25#0 | 21.43 | 21.52 | 21.05 |
| 10M | QPSK | 1#0 | 21.14 | 21.66 | 21.04 |
| | | 1#24 | 21.58 | 21.15 | 21.45 |
| | | 1#49 | 21.48 | 21.3 | 21.42 |
| | | 25#0 | 21.47 | 21.73 | 21.43 |
| | | 25#12 | 21.02 | 21.69 | 21.48 |
| | | 25#24 | 20.8 | 21.57 | 21.55 |
| | | 50#0 | 21.47 | 21.53 | 21.32 |
| | 16-QAM | 1#0 | 20.76 | 20.92 | 21.34 |
| | | 1#24 | 21.1 | 21.68 | 21.64 |
| | | 1#49 | 20.79 | 21.19 | 21.05 |
| | | 25#0 | 20.93 | 21.46 | 21.37 |
| | | 25#12 | 21.69 | 21.1 | 21.22 |
| | | 25#24 | 20.76 | 20.94 | 21.05 |
| | | 50#0 | 21.41 | 20.89 | 21.52 |

| Test Bandwidth | Test Modulation | Resource Block & RB offset | Low Channel (dBm) | Middle Channel (dBm) | High Channel (dBm) |
|----------------|-----------------|----------------------------|-------------------|----------------------|--------------------|
| 15M | QPSK | 1#0 | 21.16 | 20.79 | 20.69 |
| | | 1#37 | 20.83 | 21.04 | 21.49 |
| | | 1#74 | 21.11 | 21.52 | 21.03 |
| | | 36#0 | 20.98 | 20.71 | 21.21 |
| | | 36#17 | 21.75 | 20.86 | 21.16 |
| | | 36#35 | 20.83 | 21.45 | 21.6 |
| | | 75#0 | 21.37 | 21.32 | 21.48 |
| | 16-QAM | 1#0 | 21.32 | 21.1 | 21.67 |
| | | 1#37 | 21.29 | 21.21 | 21.59 |
| | | 1#74 | 20.99 | 21 | 21.08 |
| | | 36#0 | 20.84 | 20.75 | 21.45 |
| | | 36#17 | 21.5 | 21.51 | 21.71 |
| | | 36#35 | 20.98 | 20.94 | 21.75 |
| | | 75#0 | 21.31 | 21.31 | 21.42 |
| 20M | QPSK | 1#0 | 21.41 | 21.78 | 21.66 |
| | | 1#49 | 21.53 | 21.45 | 21.55 |
| | | 1#99 | 21.25 | 21.34 | 21.39 |
| | | 50#0 | 21.08 | 21.33 | 21.17 |
| | | 50#24 | 20.89 | 21.29 | 20.94 |
| | | 50#49 | 21.62 | 20.93 | 21.19 |
| | | 100#0 | 21.01 | 21.26 | 21.16 |
| | 16-QAM | 1#0 | 21.59 | 20.64 | 21.75 |
| | | 1#49 | 21.05 | 20.67 | 21.26 |
| | | 1#99 | 21 | 20.82 | 21.32 |
| | | 50#0 | 21.29 | 20.77 | 21.36 |
| | | 50#24 | 21.45 | 20.98 | 21.53 |
| | | 50#49 | 21.62 | 20.98 | 21.72 |
| | | 100#0 | 21.52 | 20.93 | 21.21 |

LTE Band 5

| Test Bandwidth | Test Modulation | Resource Block & RB offset | Low Channel (dBm) | Middle Channel (dBm) | High Channel (dBm) |
|----------------|-----------------|----------------------------|-------------------|----------------------|--------------------|
| 1.4M | QPSK | 1#0 | 23.46 | 23.09 | 23.49 |
| | | 1#3 | 24.06 | 24.15 | 23.56 |
| | | 1#5 | 23.87 | 23.74 | 23.36 |
| | | 3#0 | 24.29 | 23.58 | 23.20 |
| | | 3#1 | 23.46 | 23.88 | 23.56 |
| | | 3#3 | 24.17 | 23.56 | 23.30 |
| | | 6#0 | 23.93 | 23.28 | 23.62 |
| | 16-QAM | 1#0 | 24.25 | 24.05 | 24.08 |
| | | 1#3 | 24.17 | 24.01 | 23.70 |
| | | 1#5 | 23.86 | 23.39 | 23.53 |
| | | 3#0 | 23.86 | 24.01 | 23.48 |
| | | 3#1 | 23.94 | 24.05 | 23.48 |
| | | 3#3 | 23.77 | 24.04 | 23.81 |
| | | 6#0 | 23.44 | 23.55 | 23.83 |
| 3M | QPSK | 1#0 | 23.96 | 23.91 | 23.63 |
| | | 1#7 | 23.63 | 23.67 | 23.34 |
| | | 1#14 | 23.87 | 23.54 | 23.65 |
| | | 8#0 | 24.16 | 23.92 | 23.26 |
| | | 8#4 | 23.40 | 24.12 | 23.47 |
| | | 8#7 | 23.55 | 23.68 | 23.20 |
| | | 15#0 | 23.73 | 24.16 | 23.62 |
| | 16-QAM | 1#0 | 23.46 | 23.74 | 23.63 |
| | | 1#7 | 24.30 | 23.77 | 24.07 |
| | | 1#14 | 24.00 | 23.73 | 23.92 |
| | | 8#0 | 23.90 | 23.88 | 23.58 |
| | | 8#4 | 24.23 | 23.65 | 23.95 |
| | | 8#7 | 24.02 | 23.29 | 23.97 |
| | | 15#0 | 23.68 | 23.61 | 23.44 |

| Test Bandwidth | Test Modulation | Resource Block & RB offset | Low Channel (dBm) | Middle Channel (dBm) | High Channel (dBm) |
|----------------|-----------------|----------------------------|-------------------|----------------------|--------------------|
| 5M | QPSK | 1#0 | 23.19 | 23.43 | 23.29 |
| | | 1#12 | 24.72 | 23.80 | 23.81 |
| | | 1#24 | 23.67 | 23.63 | 23.78 |
| | | 12#0 | 24.23 | 23.68 | 23.38 |
| | | 12#6 | 24.13 | 24.14 | 23.74 |
| | | 12#11 | 24.04 | 23.71 | 23.56 |
| | | 25#0 | 23.59 | 23.69 | 23.76 |
| | 16-QAM | 1#0 | 24.09 | 23.95 | 23.58 |
| | | 1#12 | 23.89 | 23.90 | 23.83 |
| | | 1#24 | 24.09 | 23.67 | 23.51 |
| | | 12#0 | 24.00 | 24.24 | 23.63 |
| | | 12#6 | 23.87 | 23.83 | 24.12 |
| | | 12#11 | 23.71 | 23.51 | 23.67 |
| | | 25#0 | 24.09 | 23.89 | 24.30 |
| 10M | QPSK | 1#0 | 24.28 | 24.34 | 24.32 |
| | | 1#24 | 23.56 | 23.33 | 24.14 |
| | | 1#49 | 24.21 | 23.48 | 23.98 |
| | | 25#0 | 23.72 | 23.86 | 23.74 |
| | | 25#12 | 23.75 | 23.48 | 24.02 |
| | | 25#24 | 23.71 | 23.59 | 24.21 |
| | | 50#0 | 23.54 | 23.82 | 23.76 |
| | 16-QAM | 1#0 | 23.66 | 23.75 | 23.84 |
| | | 1#24 | 23.92 | 23.82 | 24.13 |
| | | 1#49 | 24.04 | 24.15 | 23.38 |
| | | 25#0 | 23.89 | 23.60 | 23.46 |
| | | 25#12 | 24.30 | 23.84 | 24.01 |
| | | 25#24 | 23.89 | 23.60 | 23.93 |
| | | 50#0 | 23.53 | 24.19 | 23.84 |

LTE Band 7

| Test Bandwidth | Test Modulation | Resource Block & RB offset | Low Channel (dBm) | Middle Channel (dBm) | High Channel (dBm) |
|----------------|-----------------|----------------------------|-------------------|----------------------|--------------------|
| 5M | QPSK | 1#0 | 21.22 | 21.58 | 21.74 |
| | | 1#12 | 21.53 | 20.77 | 21.32 |
| | | 1#24 | 21.56 | 20.93 | 21.62 |
| | | 12#0 | 21.70 | 21.03 | 21.25 |
| | | 12#6 | 21.63 | 21.41 | 21.09 |
| | | 12#11 | 21.29 | 21.38 | 21.14 |
| | | 25#0 | 21.58 | 21.12 | 21.28 |
| | 16-QAM | 1#0 | 21.29 | 20.73 | 21.52 |
| | | 1#12 | 21.34 | 20.89 | 21.71 |
| | | 1#24 | 21.66 | 21.48 | 21.45 |
| | | 12#0 | 20.98 | 20.9 | 21.49 |
| | | 12#6 | 21.45 | 21.14 | 21.35 |
| | | 12#11 | 21.3 | 21.45 | 21.46 |
| | | 25#0 | 21.22 | 20.84 | 21.36 |
| 10M | QPSK | 1#0 | 21.4 | 20.74 | 21.15 |
| | | 1#24 | 21.04 | 21.38 | 21.49 |
| | | 1#49 | 21.61 | 21.64 | 21.12 |
| | | 25#0 | 21.68 | 21.12 | 21.27 |
| | | 25#12 | 21.33 | 20.99 | 21.19 |
| | | 25#24 | 21.67 | 21.56 | 21.69 |
| | | 50#0 | 21.76 | 21.37 | 21.7 |
| | 16-QAM | 1#0 | 21.32 | 21.01 | 21.55 |
| | | 1#24 | 21.49 | 21.13 | 21.46 |
| | | 1#49 | 21.18 | 20.98 | 21.41 |
| | | 25#0 | 21.28 | 21.14 | 21.56 |
| | | 25#12 | 21.18 | 21.45 | 21.06 |
| | | 25#24 | 21.44 | 20.75 | 21.70 |
| | | 50#0 | 21.27 | 20.89 | 22.02 |

| Test Bandwidth | Test Modulation | Resource Block & RB offset | Low Channel (dBm) | Middle Channel (dBm) | High Channel (dBm) |
|----------------|-----------------|----------------------------|-------------------|----------------------|--------------------|
| 15M | QPSK | 1#0 | 21.16 | 21.63 | 21.93 |
| | | 1#37 | 21.32 | 21.18 | 21.27 |
| | | 1#74 | 21.16 | 20.91 | 21.55 |
| | | 36#0 | 21.41 | 21.4 | 21.65 |
| | | 36#17 | 21.54 | 20.94 | 21.3 |
| | | 36#35 | 21.65 | 21.15 | 21.37 |
| | | 75#0 | 21.28 | 21.12 | 21.1 |
| | 16-QAM | 1#0 | 20.95 | 20.72 | 21.85 |
| | | 1#37 | 21.49 | 21.69 | 21.65 |
| | | 1#74 | 21.15 | 21.31 | 21.95 |
| | | 36#0 | 21.25 | 21.09 | 21.93 |
| | | 36#17 | 21.63 | 21.62 | 21.86 |
| | | 36#35 | 21.5 | 21.1 | 21.16 |
| | | 75#0 | 20.94 | 21.35 | 21.06 |
| 20M | QPSK | 1#0 | 21.7 | 21.71 | 21.63 |
| | | 1#49 | 21.31 | 21.05 | 21.21 |
| | | 1#99 | 21.43 | 21.19 | 21.2 |
| | | 50#0 | 21.14 | 21.73 | 21.48 |
| | | 50#24 | 21.47 | 21.62 | 21.52 |
| | | 50#49 | 20.85 | 21.24 | 21.56 |
| | | 100#0 | 20.82 | 21.53 | 21.11 |
| | 16-QAM | 1#0 | 21.44 | 21.28 | 21.72 |
| | | 1#49 | 20.89 | 21.05 | 21.68 |
| | | 1#99 | 21.26 | 21.45 | 21.52 |
| | | 50#0 | 21.72 | 21.65 | 21.56 |
| | | 50#24 | 21.35 | 21.24 | 21.32 |
| | | 50#49 | 21.66 | 21.17 | 21.11 |
| | | 100#0 | 21.52 | 21.47 | 21.34 |

LTE Band 17

| Test Bandwidth | Test Modulation | Resource Block & RB offset | Low Channel (dBm) | Middle Channel (dBm) | High Channel (dBm) |
|----------------|-----------------|----------------------------|-------------------|----------------------|--------------------|
| 5M | QPSK | 1#0 | 21.58 | 21.95 | 21.16 |
| | | 1#12 | 22.22 | 21.47 | 21.42 |
| | | 1#24 | 21.92 | 21.15 | 21.15 |
| | | 12#0 | 21.28 | 21.14 | 21.34 |
| | | 12#6 | 21.77 | 21.24 | 21.04 |
| | | 12#11 | 21.57 | 21.43 | 21.29 |
| | | 25#0 | 21.90 | 22.06 | 21.23 |
| | 16-QAM | 1#0 | 21.44 | 21.63 | 21.84 |
| | | 1#12 | 22.01 | 21.45 | 21.47 |
| | | 1#24 | 22.04 | 21.89 | 21.69 |
| | | 12#0 | 22.08 | 22.00 | 21.73 |
| | | 12#6 | 21.46 | 21.62 | 21.28 |
| | | 12#11 | 21.39 | 22.09 | 21.38 |
| | | 25#0 | 22.09 | 22.10 | 21.11 |
| 10M | QPSK | 1#0 | 21.33 | 21.58 | 21.58 |
| | | 1#24 | 21.48 | 21.64 | 21.31 |
| | | 1#49 | 21.86 | 21.57 | 21.21 |
| | | 25#0 | 21.45 | 21.48 | 21.38 |
| | | 25#12 | 21.48 | 21.19 | 21.67 |
| | | 25#24 | 21.53 | 21.28 | 22.15 |
| | | 50#0 | 21.47 | 21.71 | 21.94 |
| | 16-QAM | 1#0 | 21.67 | 21.41 | 21.72 |
| | | 1#24 | 21.66 | 21.70 | 21.33 |
| | | 1#49 | 21.48 | 21.81 | 21.61 |
| | | 25#0 | 22.04 | 21.76 | 21.63 |
| | | 25#12 | 21.69 | 21.38 | 21.81 |
| | | 25#24 | 21.42 | 21.88 | 21.84 |
| | | 50#0 | 22.01 | 21.17 | 22.08 |

LTE Band 41

| Test Bandwidth | Test Modulation | Resource Block & RB offset | Low Channel (dBm) | Middle Channel (dBm) | High Channel (dBm) |
|----------------|-----------------|----------------------------|-------------------|----------------------|--------------------|
| 5M | QPSK | 1#0 | 21.75 | 21.87 | 21.94 |
| | | 1#12 | 21.54 | 21.61 | 21.54 |
| | | 1#24 | 21.63 | 21.84 | 21.66 |
| | | 12#0 | 21.51 | 22.09 | 21.97 |
| | | 12#6 | 22.03 | 21.43 | 21.39 |
| | | 12#11 | 22.02 | 22.11 | 21.59 |
| | | 25#0 | 21.63 | 21.46 | 21.04 |
| | 16-QAM | 1#0 | 22.12 | 21.28 | 21.93 |
| | | 1#12 | 21.84 | 21.40 | 21.63 |
| | | 1#24 | 22.12 | 21.59 | 21.04 |
| | | 12#0 | 21.47 | 21.13 | 21.91 |
| | | 12#6 | 22.00 | 21.70 | 21.44 |
| | | 12#11 | 21.39 | 21.88 | 21.35 |
| | | 25#0 | 22.13 | 21.29 | 21.73 |
| 10M | QPSK | 1#0 | 21.78 | 22.01 | 21.35 |
| | | 1#24 | 22.09 | 21.41 | 21.91 |
| | | 1#49 | 21.37 | 21.92 | 21.26 |
| | | 25#0 | 21.58 | 21.38 | 21.34 |
| | | 25#12 | 21.38 | 21.16 | 21.37 |
| | | 25#24 | 21.28 | 21.79 | 21.67 |
| | | 50#0 | 21.60 | 21.44 | 21.72 |
| | 16-QAM | 1#0 | 21.47 | 22.00 | 22.11 |
| | | 1#24 | 21.99 | 21.79 | 21.47 |
| | | 1#49 | 21.65 | 21.92 | 22.14 |
| | | 25#0 | 21.73 | 22.09 | 21.26 |
| | | 25#12 | 21.82 | 21.77 | 21.92 |
| | | 25#24 | 21.41 | 22.09 | 22.08 |
| | | 50#0 | 21.31 | 22.05 | 21.89 |

| Test Bandwidth | Test Modulation | Resource Block & RB offset | Low Channel (dBm) | Middle Channel (dBm) | High Channel (dBm) |
|----------------|-----------------|----------------------------|-------------------|----------------------|--------------------|
| 15M | QPSK | 1#0 | 22.06 | 22.02 | 21.18 |
| | | 1#37 | 22.21 | 21.28 | 21.36 |
| | | 1#74 | 22.02 | 21.36 | 21.10 |
| | | 36#0 | 21.73 | 21.17 | 21.80 |
| | | 36#17 | 21.52 | 21.35 | 21.67 |
| | | 36#35 | 21.62 | 21.15 | 21.74 |
| | | 75#0 | 22.09 | 21.61 | 21.29 |
| | 16-QAM | 1#0 | 21.87 | 21.48 | 21.26 |
| | | 1#37 | 21.96 | 21.65 | 21.68 |
| | | 1#74 | 21.37 | 21.84 | 21.87 |
| | | 36#0 | 21.81 | 21.28 | 21.82 |
| | | 36#17 | 21.34 | 21.87 | 21.41 |
| | | 36#35 | 21.74 | 21.57 | 21.58 |
| | | 75#0 | 21.45 | 22.09 | 21.94 |
| 20M | QPSK | 1#0 | 21.55 | 21.84 | 21.20 |
| | | 1#49 | 22.03 | 21.27 | 21.31 |
| | | 1#99 | 21.17 | 21.45 | 21.36 |
| | | 50#0 | 21.45 | 21.61 | 21.49 |
| | | 50#24 | 22.03 | 21.42 | 21.80 |
| | | 50#49 | 21.19 | 21.82 | 21.59 |
| | | 100#0 | 22.14 | 21.50 | 21.33 |
| | 16-QAM | 1#0 | 21.37 | 21.22 | 21.67 |
| | | 1#49 | 21.71 | 21.85 | 21.68 |
| | | 1#99 | 22.08 | 21.24 | 21.89 |
| | | 50#0 | 22.05 | 21.87 | 21.53 |
| | | 50#24 | 21.44 | 22.00 | 21.57 |
| | | 50#49 | 21.83 | 21.31 | 21.27 |
| | | 100#0 | 21.18 | 21.21 | 21.55 |

WLAN 2.4G:

| Mode | Channel frequency (MHz) | Data Rate | Conducted Average Output Power(dBm) |
|--------------|-------------------------|-----------|-------------------------------------|
| 802.11b | 2412 | 1Mbps | 13.41 |
| | 2437 | | 14.68 |
| | 2462 | | 13.60 |
| 802.11g | 2412 | 6Mbps | 7.12 |
| | 2437 | | 6.57 |
| | 2462 | | 6.89 |
| 802.11n HT20 | 2412 | MCS0 | 7.20 |
| | 2437 | | 6.25 |
| | 2462 | | 6.93 |
| 802.11n HT40 | 2422 | MCS0 | 6.61 |
| | 2437 | | 7.34 |
| | 2452 | | 5.75 |

WLAN 5.2G:

| Test mode | Band | Frequency (MHz) | Average Conducted Output Power (dBm) |
|--------------|---------------|-----------------|--------------------------------------|
| 802.11a | 5150-5250 MHz | 5180 | 14.48 |
| | | 5200 | 14.36 |
| | | 5240 | 12.67 |
| 802.11ac20 | 5150-5250 MHz | 5180 | 14.28 |
| | | 5200 | 14.36 |
| | | 5240 | 12.64 |
| 802.11n-HT20 | 5150-5250 MHz | 5180 | 14.37 |
| | | 5200 | 14.30 |
| | | 5240 | 12.62 |
| 802.11ac40 | 5150-5250 MHz | 5190 | 13.33 |
| | | 5230 | 12.06 |
| 802.11n-HT40 | 5150-5250 MHz | 5190 | 13.56 |
| | | 5230 | 12.48 |
| 802.11ac80 | 5150-5250 MHz | 5210 | 12.94 |

WLAN 5.8G:

| Test mode | Band | Frequency (MHz) | Average Conducted Output Power (dBm) |
|--------------|---------------|-----------------|--------------------------------------|
| 802.11a | 5725-5850 MHz | 5745 | 10.51 |
| | | 5785 | 9.72 |
| | | 5825 | 9.87 |
| 802.11ac20 | 5725-5850 MHz | 5745 | 10.73 |
| | | 5785 | 9.86 |
| | | 5825 | 9.61 |
| 802.11n-HT20 | 5725-5850 MHz | 5745 | 10.58 |
| | | 5785 | 10.21 |
| | | 5825 | 9.01 |
| 802.11ac40 | 5725-5850 MHz | 5755 | 9.34 |
| | | 5795 | 8.51 |
| 802.11n-HT40 | 5725-5850 MHz | 5755 | 9.37 |
| | | 5795 | 9.05 |
| 802.11ac80 | 5725-5850 MHz | 5775 | 8.89 |

Bluetooth:

| Mode | Channel frequency (MHz) | RF Output Power (dBm) |
|----------------------|-------------------------|-----------------------|
| BDR(GFSK) | 2402 | 6.39 |
| | 2441 | 7.08 |
| | 2480 | 4.31 |
| EDR($\pi/4$ -DQPSK) | 2402 | 5.34 |
| | 2441 | 6.57 |
| | 2480 | 3.72 |
| EDR(8DPSK) | 2402 | 5.64 |
| | 2441 | 6.81 |
| | 2480 | 4.07 |

BLE:

| Channel | Frequency (MHz) | Max Conducted Peak Output Power (dBm) |
|----------|-----------------|---------------------------------------|
| BLE Mode | | |
| Low | 2402 | 1.59 |
| Middle | 2440 | 2.70 |
| High | 2480 | -0.00 |

Standalone SAR test exclusion considerations

Antennas Location:

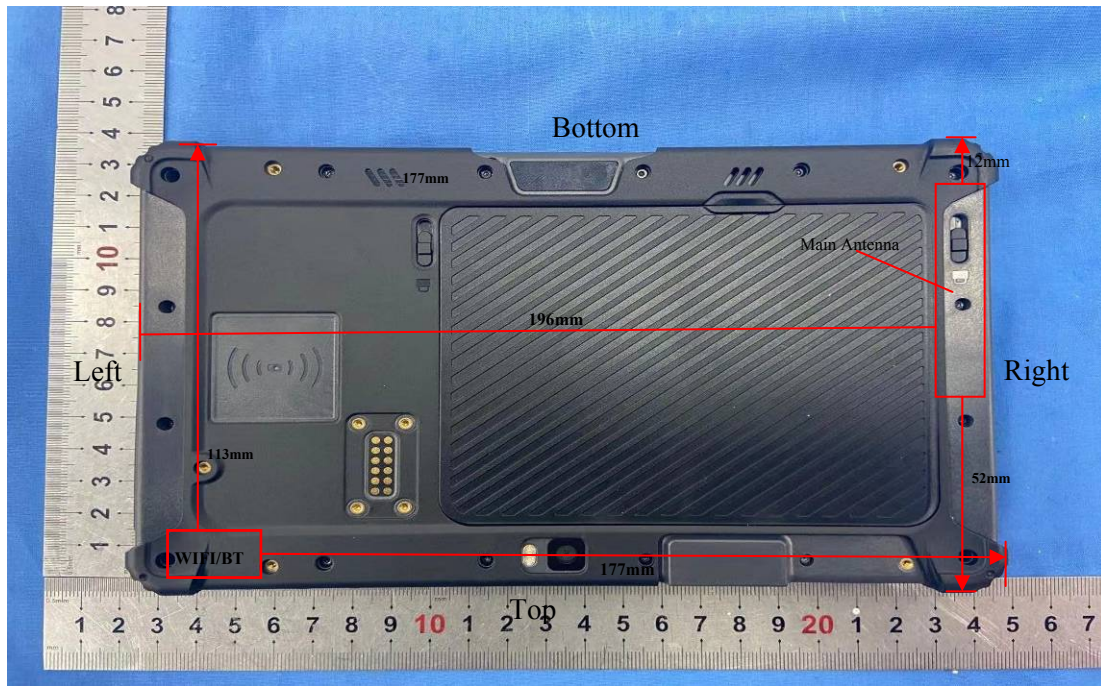

Antenna Distance To Edge

| Antenna | Antenna Distance To Edge(mm) | | | | | |
|---------|------------------------------|-------|------|-------|-----|--------|
| | Back | Front | Left | Right | Top | Bottom |
| WWAN | <5 | <5 | 196 | <5 | 52 | 12 |
| WIFI/BT | <5 | <5 | 8 | 177 | <5 | 113 |

Standalone SAR test exclusion considerations

| Mode | Frequency (MHz) | Pavg (dBm) | Pavg (mW) | Distance (mm) | Calculated value | Threshold (1-g) | SAR Test Exclusion |
|-----------|-----------------|------------|-----------|---------------|------------------|-----------------|--------------------|
| WLAN 2.4G | 2462 | 14 | 25.12 | 5 | 7.9 | 3 | NO |
| WLAN 5.2G | 5240 | 13 | 19.95 | 5 | 9.1 | 3 | NO |
| WLAN 5.8G | 5825 | 10 | 10 | 5 | 4.8 | 3 | NO |
| Bluetooth | 2441 | 7.5 | 5.62 | 5 | 0.9 | 3 | YES |

Note: The WLAN based average power for calculation. and Bluetooth based peak output power for calculation.

NOTE:

The 1-g and 10-g SAR test exclusion thresholds for 100 MHz to 6 GHz at test separation distances ≤ 50 mm are determined by:

$$[(\text{max. power of channel, including tune-up tolerance, mW}) / (\text{min. test separation distance, mm})] \cdot$$

$$[\sqrt{f(\text{GHz})}] \leq 3.0 \text{ for 1-g SAR and } \leq 7.5 \text{ for 10-g extremity SAR, where}$$

1. f(GHz) is the RF channel transmit frequency in GHz.

2. Power and distance are rounded to the nearest mW and mm before calculation.

3. The result is rounded to one decimal place for comparison.

4. When the minimum test separation distance is < 5 mm, a distance of 5 mm is applied to determine SAR test Exclusion.

Standalone SAR estimation:

| Mode | Frequency (MHz) | Pavg (dBm) | Pavg (mW) | Distance (mm) | Estimated 1-g (W/kg) |
|---------|-----------------|------------|-----------|---------------|----------------------|
| BT Body | 2441 | 7.5 | 5.62 | 5 | 0.234 |

Note: The bluetooth based Peak power for calculation.

When standalone SAR test exclusion applies to an antenna that transmits simultaneously with other antennas, the standalone SAR must be estimated according to following to determine simultaneous transmission SAR test exclusion:

$$[(\text{max. power of channel, including tune-up tolerance, mW}) / (\text{min. test separation distance, mm})] \cdot [\sqrt{f(\text{GHz})} / x]$$

W/kg for test separation distances ≤50 mm;

where x = 7.5 for 1-g SAR. and x= 18.75 for 10-g SAR.

When the minimum test separation distance is < 5 mm, a distance of 5 mm is applied to determine SAR test Exclusion

Standalone SAR test exclusion considerations:

| Mode | Frequency (MHz) | Pavg (dBm) | Pavg (mW) | Test exclusion Distance(mm) |
|-------------|-----------------|------------|-----------|-----------------------------|
| GPRS 850 | 848.8 | 30 | 1000 | 198 |
| GPRS 1900 | 1909.8 | 27 | 501 | 90 |
| WCDMA Band2 | 1907.6 | 23 | 199.5 | 59 |
| WCDMA Band5 | 846.6 | 23 | 199.5 | 56 |
| CDMA850 | 848.31 | 23 | 199.5 | 56 |
| LTE Band2 | 1909.3 | 23.5 | 223.9 | 62 |
| LTE Band4 | 1754.3 | 23 | 199.5 | 59 |
| LTE Band5 | 844.0 | 24.5 | 281.8 | 56 |
| LTE Band7 | 2560 | 23 | 199.5 | 61 |
| LTE Band17 | 711 | 22.5 | 177.8 | 52 |
| LTE Band41 | 2645 | 22.5 | 177.8 | 59 |
| Wi-Fi 2.4G | 2462 | 14 | 25.1 | 14 |
| Wi-Fi 5.2G | 5240 | 13 | 20.0 | 17 |
| Wi-Fi 5.8G | 5825 | 10 | 10 | 9 |

Note: For GSM Mode(s), the maximum time based average power(4Slots) were used for calculation.

SAR test exclusion for the EUT edge considerations Result

| Antenna Distance To Edge(mm) | | | | | | |
|------------------------------|----------|----------|-----------|-----------|----------|-----------|
| Mode | Front | Back | Left | Right | Top | Bottom |
| GSM850 | Required | Required | Required | Required | Required | Required |
| GSM1900 | Required | Required | Exclusion | Required | Required | Required |
| WCDMA Band2 | Required | Required | Exclusion | Required | Required | Required |
| WCDMA Band5 | Required | Required | Exclusion | Required | Required | Required |
| CDMA | Required | Required | Exclusion | Required | Required | Required |
| LTE Band2 | Required | Required | Exclusion | Required | Required | Required |
| LTE Band4 | Required | Required | Exclusion | Required | Required | Required |
| LTE Band5 | Required | Required | Exclusion | Required | Required | Required |
| LTE Band7 | Required | Required | Exclusion | Required | Required | Required |
| LTE Band17 | Required | Required | Exclusion | Required | Required | Required |
| LTE Band41 | Required | Required | Exclusion | Required | Required | Required |
| WLAN 2.4G | Required | Required | Required | Exclusion | Required | Exclusion |
| WLAN 5.2G | Required | Required | Required | Exclusion | Required | Exclusion |
| WLAN 5.8G | Required | Required | Required | Exclusion | Required | Exclusion |

Note:

Required: The distance is less than **Test Exclusion Distance**, testing is required.

Exclusion*: SAR test exclusion evaluation has been done above.

Exclusion: The distance is larger than **Test Exclusion Distance**, testing is not required.

SAR test exclusion for the EUT edge considerations detail:

Distance<50mm(To Edges)

The 1-g and 10-g SAR test exclusion thresholds for 100 MHz to 6 GHz at test separation distance ≤ 50 mm are determined by:

$$[(\text{max. power of channel, including tune-up tolerance, mW}) / (\text{min. test separation distance, mm})] \cdot \sqrt{f(\text{GHz})} \leq 3.0 \text{ for 1-g SAR and } \leq 7.5 \text{ for 10-g extremity SAR, where}$$

1. f(GHz) is the RF channel transmit frequency in GHz.
2. Power and distance are rounded to the nearest mW and mm before calculation.
3. The result is rounded to one decimal place for comparison.
4. When the minimum test separation distance is < 5 mm, a distance of 5 mm is applied to determine SAR test Exclusion.
5. The Time based average Power is used for calculation.

Distance>50mm(To Edges)

At 100 MHz to 6 GHz and for *test separation distance* > 50 mm, the SAR test exclusion threshold is determined according to the following:

- a) [(Power allowed at numeric threshold for 50mm in step 1) + (test separation distance - 50mm) · (f(MHz)/150)]mW, at 100 MHz to 1500 MHz
- a) [(Power allowed at numeric threshold for 50mm in step 1) + (test separation distance - 50mm) · 10]mW, at > 1500 MHz and ≤ 6 GHz.

SAR MEASUREMENT RESULTS

This page summarizes the results of the performed dosimetric evaluation.

SAR Test Data

Environmental Conditions

| | | | | | |
|---------------------------|--------------|--------------|--------------|--------------|--------------|
| Temperature: | 21.5-22.9 °C | 21.1-22.4 °C | 20.9-22.2 °C | 20.8-21.8 °C | 21.1-22.3 °C |
| Relative Humidity: | 51 % | 49 % | 50 % | 48 % | 48 % |
| ATM Pressure: | 101.8 kPa | 101.5 kPa | 101.7 kPa | 101.6 kPa | 101.5 kPa |
| Test Date: | 2020/08/23 | 2020/08/24 | 2020/08/25 | 2020/08/26 | 2020/08/27 |
| Temperature: | 21.5-22.7 °C | 21.5-22.6 °C | 21.5-22.7 °C | | |
| Relative Humidity: | 53 % | 49 % | 50 % | | |
| ATM Pressure: | 101.7 kPa | 101.8 kPa | 101.8 kPa | | |
| Test Date: | 2020/08/28 | 2020/08/29 | 2020/08/30 | | |

Testing was performed by Chris wang. and Bard Liu

GSM 850 :

| EUT Position | Frequency (MHz) | Test Mode | Max Power (dBm) | | Scaled Factor | 1g SAR (W/kg) | | Plot |
|------------------------|-----------------|-----------|-----------------|-------|---------------|---------------|-------|------|
| | | | Meas. | Rated | | Meas. | Rated | |
| Body-Front (0mm) | 824.2 | GPRS | / | / | / | / | / | / |
| | 836.6 | GPRS | 29.56 | 30.0 | 1.170 | 0.222 | 0.246 | #1 |
| | 848.8 | GPRS | / | / | / | / | / | / |
| Body-Back (0mm) | 824.2 | GPRS | / | / | / | / | / | / |
| | 836.6 | GPRS | 29.56 | 30.0 | 1.170 | 0.193 | 0.214 | / |
| | 848.8 | GPRS | / | / | / | / | / | / |
| Body-Headset-Back(0mm) | 824.2 | GSM Voice | 33.48 | 34.0 | 1.127 | 0.112 | 0.126 | / |
| | 836.6 | GSM Voice | / | / | / | / | / | / |
| | 848.8 | GSM Voice | / | / | / | / | / | / |
| Body-Left (0mm) | 824.2 | GPRS | / | / | / | / | / | / |
| | 836.6 | GPRS | 29.56 | 30.0 | 1.170 | 0.002 | 0.002 | / |
| | 848.8 | GPRS | / | / | / | / | / | / |
| Body-Right (0mm) | 824.2 | GPRS | / | / | / | / | / | / |
| | 836.6 | GPRS | 29.56 | 30.0 | 1.170 | 0.221 | 0.245 | / |
| | 848.8 | GPRS | / | / | / | / | / | / |
| Body-Top (0mm) | 824.2 | GPRS | / | / | / | / | / | / |
| | 836.6 | GPRS | 29.56 | 30.0 | 1.170 | 0.026 | 0.029 | / |
| | 848.8 | GPRS | / | / | / | / | / | / |
| Body-Bottom (0mm) | 824.2 | GPRS | / | / | / | / | / | / |
| | 836.6 | GPRS | 29.56 | 30.0 | 1.170 | 0.013 | 0.014 | / |
| | 848.8 | GPRS | / | / | / | / | / | / |

PCS 1900 :

| EUT Position | Frequency (MHz) | Test Mode | Max Power (dBm) | | Scaled Factor | 1g SAR (W/kg) | | Plot |
|------------------------|-----------------|-----------|-----------------|-------|---------------|---------------|-------|------|
| | | | Meas. | Rated | | Meas. | Rated | |
| Body-Front (0mm) | 1850.2 | GPRS | / | / | / | / | / | / |
| | 1880 | GPRS | 26.75 | 27 | 1.059 | 0.395 | 0.418 | / |
| | 1909.8 | GPRS | / | / | / | / | / | / |
| Body-Back (0mm) | 1850.2 | GPRS | / | / | / | / | / | / |
| | 1880 | GPRS | 26.75 | 27 | 1.059 | 0.362 | 0.383 | / |
| | 1909.8 | GPRS | / | / | / | / | / | / |
| Body-Headset-Back(0mm) | 1850.2 | GSM Voice | / | / | / | / | / | / |
| | 1880 | GSM Voice | / | / | / | / | / | / |
| | 1909.8 | GSM Voice | 30.98 | 32 | 1.265 | 0.205 | 0.259 | / |
| Body-Right (0mm) | 1850.2 | GPRS | / | / | / | / | / | / |
| | 1880 | GPRS | 26.75 | 27 | 1.059 | 0.515 | 0.546 | #2 |
| | 1909.8 | GPRS | / | / | / | / | / | / |
| Body-Top (0mm) | 1850.2 | GPRS | / | / | / | / | / | / |
| | 1880 | GPRS | 26.75 | 27 | 1.059 | 0.032 | 0.034 | / |
| | 1909.8 | GPRS | / | / | / | / | / | / |
| Body-Bottom (0mm) | 1850.2 | GPRS | / | / | / | / | / | / |
| | 1880 | GPRS | 26.75 | 27 | 1.059 | 0.010 | 0.011 | / |
| | 1909.8 | GPRS | / | / | / | / | / | / |

WCDMA Band 2 :

| EUT Position | Frequency (MHz) | Test Mode | Max Power (dBm) | | Scaled Factor | 1g SAR (W/kg) | | Plot |
|-------------------|-----------------|-----------|-----------------|-------|---------------|---------------|-------|------|
| | | | Meas. | Rated | | Meas. | Rated | |
| Body-Front (0mm) | 1852.4 | RMC | / | / | / | / | / | / |
| | 1880 | RMC | 20.66 | 21 | 1.081 | 0.407 | 0.440 | #4 |
| | 1907.6 | RMC | / | / | / | / | / | / |
| Body-Back (0mm) | 1852.4 | RMC | / | / | / | / | / | / |
| | 1880 | RMC | 20.66 | 21 | 1.081 | 0.361 | 0.390 | / |
| | 1907.6 | RMC | / | / | / | / | / | / |
| Body-Right (0mm) | 1852.4 | RMC | / | / | / | / | / | / |
| | 1880 | RMC | 20.66 | 21 | 1.081 | 0.325 | 0.351 | / |
| | 1907.6 | RMC | / | / | / | / | / | / |
| Body-Top (0mm) | 1852.4 | RMC | / | / | / | / | / | / |
| | 1880 | RMC | 20.66 | 21 | 1.081 | 0.132 | 0.143 | / |
| | 1907.6 | RMC | / | / | / | / | / | / |
| Body-Bottom (0mm) | 1852.4 | RMC | / | / | / | / | / | / |
| | 1880 | RMC | 20.66 | 21 | 1.081 | 0.024 | 0.026 | / |
| | 1907.6 | RMC | / | / | / | / | / | / |

WCDMA Band 5 :

| EUT Position | Frequency (MHz) | Test Mode | Max Power (dBm) | | Scaled Factor | 1g SAR (W/kg) | | Plot |
|-------------------|-----------------|-----------|-----------------|-------|---------------|---------------|-------|------|
| | | | Meas. | Rated | | Meas. | Rated | |
| Body-Front (0mm) | 826.4 | RMC | / | / | / | / | / | / |
| | 836.4 | RMC | 22.54 | 23 | 1.112 | 0.586 | 0.651 | / |
| | 846.6 | RMC | / | / | / | / | / | / |
| Body-Back (0mm) | 826.4 | RMC | / | / | / | / | / | / |
| | 836.4 | RMC | 22.54 | 23 | 1.112 | 0.622 | 0.691 | #3 |
| | 846.6 | RMC | / | / | / | / | / | / |
| Body-Right (0mm) | 826.4 | RMC | / | / | / | / | / | / |
| | 836.4 | RMC | 22.54 | 23 | 1.112 | 0.403 | 0.448 | / |
| | 846.6 | RMC | / | / | / | / | / | / |
| Body-Top (0mm) | 826.4 | RMC | / | / | / | / | / | / |
| | 836.4 | RMC | 22.54 | 23 | 1.112 | 0.122 | 0.136 | / |
| | 846.6 | RMC | / | / | / | / | / | / |
| Body-Bottom (0mm) | 826.4 | RMC | / | / | / | / | / | / |
| | 836.4 | RMC | 22.54 | 23 | 1.112 | 0.046 | 0.051 | / |
| | 846.6 | RMC | / | / | / | / | / | / |

CDMA BC0 :

| EUT Position | Frequency (MHz) | Test Mode | Max Power (dBm) | | Scaled Factor | 1g SAR (W/kg) | | Plot |
|-------------------|-----------------|-----------|-----------------|-------|---------------|---------------|-------|------|
| | | | Meas. | Rated | | Meas. | Rated | |
| Body-Front (0mm) | 824.70 | 1xRTT | / | / | / | / | / | / |
| | 836.52 | 1xRTT | 22.06 | 22.5 | 1.107 | 0.673 | 0.745 | #5 |
| | 848.31 | 1xRTT | / | / | / | / | / | / |
| Body-Back (0mm) | 824.70 | 1xRTT | / | / | / | / | / | / |
| | 836.52 | 1xRTT | 22.06 | 22.5 | 1.107 | 0.551 | 0.610 | / |
| | 848.31 | 1xRTT | / | / | / | / | / | / |
| Body-Right (0mm) | 824.70 | 1xRTT | / | / | / | / | / | / |
| | 836.52 | 1xRTT | 22.06 | 22.5 | 1.107 | 0.426 | 0.471 | / |
| | 848.31 | 1xRTT | / | / | / | / | / | / |
| Body-Top (0mm) | 824.70 | 1xRTT | / | / | / | / | / | / |
| | 836.52 | 1xRTT | 22.06 | 22.5 | 1.107 | 0.132 | 0.146 | / |
| | 848.31 | 1xRTT | / | / | / | / | / | / |
| Body-Bottom (0mm) | 824.70 | 1xRTT | / | / | / | / | / | / |
| | 836.52 | 1xRTT | 22.06 | 22.5 | 1.107 | 0.041 | 0.045 | / |
| | 848.31 | 1xRTT | / | / | / | / | / | / |

| EUT Position | Frequency (MHz) | Test Mode | Max Power (dBm) | | Scaled Factor | 1g SAR (W/kg) | | Plot |
|-------------------|-----------------|-----------|-----------------|-------|---------------|---------------|-------|------|
| | | | Meas. | Rated | | Meas. | Rated | |
| Body-Front (0mm) | 824.70 | EVDO | / | / | / | / | / | / |
| | 836.52 | EVDO | 22.31 | 22.5 | 1.045 | 0.606 | 0.633 | #6 |
| | 848.31 | EVDO | / | / | / | / | / | / |
| Body-Back (0mm) | 824.70 | EVDO | / | / | / | / | / | / |
| | 836.52 | EVDO | 22.31 | 22.5 | 1.045 | 0.566 | 0.591 | / |
| | 848.31 | EVDO | / | / | / | / | / | / |
| Body-Right (0mm) | 824.70 | EVDO | / | / | / | / | / | / |
| | 836.52 | EVDO | 22.31 | 22.5 | 1.045 | 0.389 | 0.406 | / |
| | 848.31 | EVDO | / | / | / | / | / | / |
| Body-Top (0mm) | 824.70 | EVDO | / | / | / | / | / | / |
| | 836.52 | EVDO | 22.31 | 22.5 | 1.045 | 0.106 | 0.111 | / |
| | 848.31 | EVDO | / | / | / | / | / | / |
| Body-Bottom (0mm) | 824.70 | EVDO | / | / | / | / | / | / |
| | 836.52 | EVDO | 22.31 | 22.5 | 1.045 | 0.032 | 0.033 | / |
| | 848.31 | EVDO | / | / | / | / | / | / |

LTE Band 5 :

| EUT Position | Frequency (MHz) | Bandwidth (MHz) | Test Mode | Max Power (dBm) | | Scaled Factor | 1g SAR (W/kg) | | Plot |
|-------------------|-----------------|-----------------|-----------|-----------------|-------|---------------|---------------|-------|------|
| | | | | Meas. | Rated | | Meas. | Rated | |
| Body-Front (0mm) | 829 | 10 | 1RB | / | / | / | / | / | / |
| | 836.5 | 10 | 1RB | 24.34 | 24.5 | 1.038 | 0.660 | 0.685 | / |
| | 844 | 10 | 1RB | / | / | / | / | / | / |
| | 836.5 | 10 | 50%RB | 2386 | 24.5 | 1.159 | 0.562 | 0.651 | / |
| Body-Back (0mm) | 829 | 10 | 1RB | / | / | / | | | / |
| | 836.5 | 10 | 1RB | 24.34 | 24.5 | 1.038 | 0.715 | 0.742 | #8 |
| | 844 | 10 | 1RB | / | / | / | | | / |
| | 836.5 | 10 | 50%RB | 2386 | 24.5 | 1.159 | 0.558 | 0.647 | / |
| Body-Right (0mm) | 829 | 10 | 1RB | / | / | / | | | / |
| | 836.5 | 10 | 1RB | 24.34 | 24.5 | 1.038 | 0.490 | 0.508 | / |
| | 844 | 10 | 1RB | / | / | / | | | / |
| | 836.5 | 10 | 50%RB | 2386 | 24.5 | 1.159 | 0.432 | 0.501 | / |
| Body-Top (0mm) | 829 | 10 | 1RB | / | / | / | / | / | / |
| | 836.5 | 10 | 1RB | 21.83 | 22.0 | 1.040 | 0.041 | 0.042 | / |
| | 844 | 10 | 1RB | / | / | / | | | / |
| | 836.5 | 10 | 50%RB | 21.14 | 22.0 | 1.219 | 0.025 | 0.029 | / |
| Body-Bottom (0mm) | 829 | 10 | 1RB | / | / | / | / | / | / |
| | 836.5 | 10 | 1RB | 21.83 | 22.0 | 1.040 | 0.008 | 0.008 | / |
| | 844 | 10 | 1RB | / | / | / | | | / |
| | 836.5 | 10 | 50%RB | 21.14 | 22.0 | 1.219 | 0.003 | 0.003 | / |

LTE Band 7 :

| EUT Position | Frequency (MHz) | Bandwidth (MHz) | Test Mode | Max Power (dBm) | | Scaled Factor | 1g SAR (W/kg) | | Plot |
|-------------------|-----------------|-----------------|-----------|-----------------|-------|---------------|---------------|-------|------|
| | | | | Meas. | Rated | | Meas. | Rated | |
| Body-Front (0mm) | 2510 | 20 | 1RB | / | / | / | / | / | / |
| | 2535 | 20 | 1RB | 21.71 | 22 | 1.069 | 0.629 | 0.672 | #11 |
| | 2560 | 20 | 1RB | / | / | / | / | / | / |
| | 2535 | 20 | 50%RB | 21.73 | 22 | 1.064 | 0.467 | 0.497 | / |
| Body-Back (0mm) | 2510 | 20 | 1RB | / | / | / | | | / |
| | 2535 | 20 | 1RB | 21.71 | 22 | 1.069 | 0.268 | 0.287 | |
| | 2560 | 20 | 1RB | / | / | / | | | / |
| | 2535 | 20 | 50%RB | 21.73 | 22 | 1.064 | 0.221 | 0.235 | / |
| Body-Right (0mm) | 2510 | 20 | 1RB | / | / | / | | | / |
| | 2535 | 20 | 1RB | 21.71 | 22 | 1.069 | 0.365 | 0.390 | / |
| | 2560 | 20 | 1RB | / | / | / | | | / |
| | 2535 | 20 | 50%RB | 21.73 | 22 | 1.064 | 0.302 | 0.321 | / |
| Body-Top (0mm) | 2510 | 20 | 1RB | / | / | / | / | / | / |
| | 2535 | 20 | 1RB | 21.71 | 22 | 1.069 | 0.106 | 0.113 | / |
| | 2560 | 20 | 1RB | / | / | / | | | / |
| | 2535 | 20 | 50%RB | 21.73 | 22 | 1.064 | 0.084 | 0.089 | / |
| Body-Bottom (0mm) | 2510 | 20 | 1RB | / | / | / | / | / | / |
| | 2535 | 20 | 1RB | 21.71 | 22 | 1.069 | 0.003 | 0.003 | / |
| | 2560 | 20 | 1RB | / | / | / | | | / |
| | 2535 | 20 | 50%RB | 21.73 | 22 | 1.064 | 0.002 | 0.002 | / |

LTE Band 2:

| EUT Position | Frequency (MHz) | Bandwidth (MHz) | Test Mode | Max Power (dBm) | | Scaled Factor | 1g SAR (W/kg) | | Plot |
|-------------------|-----------------|-----------------|-----------|-----------------|-------|---------------|---------------|-------|------|
| | | | | Meas. | Rated | | Meas. | Rated | |
| Body-Front (0mm) | 1860 | 20 | 1RB | / | / | / | / | / | / |
| | 1880 | 20 | 1RB | 22.09 | 22.5 | 1.099 | 0.597 | 0.656 | #10 |
| | 1900 | 20 | 1RB | / | / | / | / | / | / |
| | 1880 | 20 | 50%RB | 21.63 | 22.5 | 1.222 | 0.483 | 0.590 | / |
| Body-Back (0mm) | 1860 | 20 | 1RB | / | / | / | / | / | / |
| | 1880 | 20 | 1RB | 22.09 | 22.5 | 1.099 | 0.477 | 0.524 | |
| | 1900 | 20 | 1RB | / | / | / | / | / | / |
| | 1880 | 20 | 50%RB | 21.63 | 22.5 | 1.222 | 0.372 | 0.455 | / |
| Body-Right (0mm) | 1860 | 20 | 1RB | / | / | / | / | / | / |
| | 1880 | 20 | 1RB | 22.09 | 22.5 | 1.099 | 0.579 | 0.636 | / |
| | 1900 | 20 | 1RB | / | / | / | / | / | / |
| | 1880 | 20 | 50%RB | 21.63 | 22.5 | 1.222 | 0.506 | 0.618 | / |
| Body-Top (0mm) | 1860 | 20 | 1RB | / | / | / | / | / | / |
| | 1880 | 20 | 1RB | 22.09 | 22.5 | 1.099 | 0.311 | 0.342 | / |
| | 1900 | 20 | 1RB | / | / | / | / | / | / |
| | 1880 | 20 | 50%RB | 21.63 | 22.5 | 1.222 | 0.235 | 0.287 | / |
| Body-Bottom (0mm) | 1860 | 20 | 1RB | / | / | / | / | / | / |
| | 1880 | 20 | 1RB | 22.09 | 22.5 | 1.099 | 0.012 | 0.013 | / |
| | 1900 | 20 | 1RB | / | / | / | / | / | / |
| | 1880 | 20 | 50%RB | 21.63 | 22.5 | 1.222 | 0.007 | 0.008 | / |

LTE Band 4:

| EUT Position | Frequency (MHz) | Bandwidth (MHz) | Test Mode | Max Power (dBm) | | Scaled Factor | 1g SAR (W/kg) | | Plot |
|-------------------|-----------------|-----------------|-----------|-----------------|-------|---------------|---------------|-------|------|
| | | | | Meas. | Rated | | Meas. | Rated | |
| Body-Front (0mm) | 1720.0 | 20 | 1RB | / | / | / | / | / | / |
| | 1732.5 | 20 | 1RB | 21.78 | 22 | 1.052 | 0.336 | 0.353 | / |
| | 1745.0 | 20 | 1RB | / | / | / | / | / | / |
| | 1732.5 | 20 | 50%RB | 21.33 | 22 | 1.167 | 0.267 | 0.312 | / |
| Body-Back (0mm) | 1720.0 | 20 | 1RB | / | / | / | / | / | / |
| | 1732.5 | 20 | 1RB | 21.78 | 22 | 1.052 | 0.288 | 0.303 | / |
| | 1745.0 | 20 | 1RB | / | / | / | / | / | / |
| | 1732.5 | 20 | 50%RB | 21.33 | 22 | 1.167 | 0.270 | 0.315 | / |
| Body-Right (0mm) | 1720.0 | 20 | 1RB | / | / | / | / | / | / |
| | 1732.5 | 20 | 1RB | 21.78 | 22 | 1.052 | 0.529 | 0.556 | #9 |
| | 1745.0 | 20 | 1RB | / | / | / | / | / | / |
| | 1732.5 | 20 | 50%RB | 21.33 | 22 | 1.167 | 0.432 | 0.504 | / |
| Body-Top (0mm) | 1720.0 | 20 | 1RB | / | / | / | / | / | / |
| | 1732.5 | 20 | 1RB | 21.78 | 22 | 1.052 | 0.106 | 0.112 | / |
| | 1745.0 | 20 | 1RB | / | / | / | / | / | / |
| | 1732.5 | 20 | 50%RB | 21.33 | 22 | 1.167 | 0.085 | 0.099 | / |
| Body-Bottom (0mm) | 1720.0 | 20 | 1RB | / | / | / | / | / | / |
| | 1732.5 | 20 | 1RB | 21.78 | 22 | 1.052 | 0.026 | 0.027 | / |
| | 1745.0 | 20 | 1RB | / | / | / | / | / | / |
| | 1732.5 | 20 | 50%RB | 21.33 | 22 | 1.167 | 0.018 | 0.021 | / |

LTE Band 17:

| EUT Position | Frequency (MHz) | Bandwidth (MHz) | Test Mode | Max Power (dBm) | | Scaled Factor | 1g SAR (W/kg) | | Plot |
|-------------------|-----------------|-----------------|-----------|-----------------|-------|---------------|---------------|-------|------|
| | | | | Meas. | Rated | | Meas. | Rated | |
| Body-Front (0mm) | 709.0 | 10 | 1RB | / | / | / | / | / | / |
| | 710.0 | 10 | 1RB | 21.58 | 22.5 | 1.236 | 0.636 | 0.786 | / |
| | 711.0 | 10 | 1RB | / | / | / | / | / | / |
| | 710.0 | 10 | 50%RB | 21.48 | 22.5 | 1.265 | 0.565 | 0.715 | / |
| Body-Back (0mm) | 709.0 | 10 | 1RB | / | / | / | / | / | / |
| | 710.0 | 10 | 1RB | 21.58 | 22.5 | 1.236 | 0.682 | 0.843 | #7 |
| | 711.0 | 10 | 1RB | / | / | / | / | / | / |
| | 710.0 | 10 | 50%RB | 21.48 | 22.5 | 1.265 | 0.618 | 0.782 | / |
| Body-Right (0mm) | 709.0 | 10 | 1RB | / | / | / | / | / | / |
| | 710.0 | 10 | 1RB | 21.58 | 22.5 | 1.236 | 0.592 | 0.732 | / |
| | 711.0 | 10 | 1RB | / | / | / | / | / | / |
| | 710.0 | 10 | 50%RB | 21.48 | 22.5 | 1.265 | 0.485 | 0.613 | / |
| Body-Top (0mm) | 709.0 | 10 | 1RB | / | / | / | / | / | / |
| | 710.0 | 10 | 1RB | 21.58 | 22.5 | 1.236 | 0.066 | 0.082 | / |
| | 711.0 | 10 | 1RB | / | / | / | / | / | / |
| | 710.0 | 10 | 50%RB | 21.48 | 22.5 | 1.265 | 0.042 | 0.053 | / |
| Body-Bottom (0mm) | 709.0 | 10 | 1RB | / | / | / | / | / | / |
| | 710.0 | 10 | 1RB | 21.58 | 22.5 | 1.236 | 0.015 | 0.019 | / |
| | 711.0 | 10 | 1RB | / | / | / | / | / | / |
| | 710.0 | 10 | 50%RB | 21.48 | 22.5 | 1.265 | 0.013 | 0.016 | / |

LTE Band 41:

| EUT Position | Frequency (MHz) | Bandwidth (MHz) | Test Mode | Max Power (dBm) | | Scaled Factor | 1g SAR (W/kg) | | Plot |
|-------------------|-----------------|-----------------|-----------|-----------------|-------|---------------|---------------|-------|------|
| | | | | Meas. | Rated | | Meas. | Rated | |
| Body-Front (0mm) | 2565 | 20 | 1RB | 21.55 | 22.5 | 1.245 | 0.532 | 0.662 | / |
| | 2605 | 20 | 1RB | 21.84 | 22.5 | 1.164 | 0.755 | 0.879 | #12 |
| | 2645 | 20 | 1RB | 21.2 | 22.5 | 1.349 | 0.556 | 0.750 | / |
| | 2565 | 20 | 50%RB | 21.45 | 22.5 | 1.274 | 0.389 | 0.495 | / |
| | 2605 | 20 | 50%RB | 21.61 | 22.5 | 1.227 | 0.605 | 0.743 | / |
| | 2645 | 20 | 50%RB | 21.49 | 22.5 | 1.262 | 0.405 | 0.511 | / |
| | 2605 | 20 | 100%RB | 21.5 | 22.5 | 1.259 | 0.589 | 0.742 | / |
| Body-Back (0mm) | 2565 | 20 | 1RB | / | / | / | / | / | / |
| | 2605 | 20 | 1RB | 21.84 | 22.5 | 1.164 | 0.287 | 0.334 | / |
| | 2645 | 20 | 1RB | / | / | / | / | / | / |
| | 2605 | 20 | 50%RB | 21.61 | 22.5 | 1.227 | 0.250 | 0.307 | / |
| Body-Right (0mm) | 2565 | 20 | 1RB | 21.55 | 22.5 | 1.245 | 0.506 | 0.630 | / |
| | 2605 | 20 | 1RB | 21.84 | 22.5 | 1.164 | 0.739 | 0.860 | / |
| | 2645 | 20 | 1RB | 21.2 | 22.5 | 1.349 | 0.526 | 0.710 | / |
| | 2565 | 20 | 50%RB | 21.45 | 22.5 | 1.274 | 0.521 | 0.663 | / |
| | 2605 | 20 | 50%RB | 21.61 | 22.5 | 1.227 | 0.567 | 0.696 | / |
| | 2645 | 20 | 50%RB | 21.49 | 22.5 | 1.262 | 0.503 | 0.635 | / |
| | 2605 | 20 | 100%RB | 21.5 | 22.5 | 1.259 | 0.524 | 0.660 | / |
| Body-Top (0mm) | 2565 | 20 | 1RB | / | / | / | / | / | / |
| | 2605 | 20 | 1RB | 21.84 | 22.5 | 1.164 | 0.068 | 0.079 | / |
| | 2645 | 20 | 1RB | / | / | / | / | / | / |
| | 2605 | 20 | 50%RB | 21.61 | 22.5 | 1.227 | 0.045 | 0.055 | / |
| Body-Bottom (0mm) | 2565 | 20 | 1RB | / | / | / | / | / | / |
| | 2605 | 20 | 1RB | 21.84 | 22.5 | 1.164 | 0.021 | 0.024 | / |
| | 2645 | 20 | 1RB | / | / | / | / | / | / |
| | 2605 | 20 | 50%RB | 21.61 | 22.5 | 1.227 | 0.019 | 0.023 | / |

WLAN 2.4G:

| EUT Position | Frequency (MHz) | Test Mode | Max. Meas. Power (dBm) | Max. Rated Power (dBm) | 10g SAR (W/kg) | | | |
|------------------|-----------------|-----------|------------------------|------------------------|----------------|-----------|------------|------|
| | | | | | Scaled Factor | Meas. SAR | Scaled SAR | Plot |
| Body-Front (0mm) | 2412 | 802.11b | / | / | / | / | / | / |
| | 2437 | 802.11b | 14.68 | 15.0 | 1.076 | 0.437 | 0.470 | / |
| | 2462 | 802.11b | / | / | / | / | / | / |
| Body-Back (0mm) | 2412 | 802.11b | / | / | / | | | / |
| | 2437 | 802.11b | 14.68 | 15.0 | 1.076 | 0.451 | 0.485 | #13 |
| | 2462 | 802.11b | / | / | / | / | / | / |
| Body- Left (0mm) | 2412 | 802.11b | / | / | / | / | / | / |
| | 2437 | 802.11b | 14.68 | 15.0 | 1.076 | 0.430 | 0.463 | |
| | 2462 | 802.11b | / | / | / | / | / | / |
| Body-Top (0mm) | 2412 | 802.11b | / | / | / | / | / | / |
| | 2437 | 802.11b | 14.68 | 15.0 | 1.076 | 0.236 | 0.254 | / |
| | 2462 | 802.11b | / | / | / | / | / | / |

Note:

1. When the SAR Value is less than half of the limit, testing for other channels are optional.
2. When SAR or MPE is not measured at the maximum power level allowed for production units, the results must be scaled to the maximum tune-up tolerance limit according to the power applied to the individual channels tested to determine compliance.
3. KDB 248227 D01-SAR measurement is not required for 2.4 GHz OFDM(801.11g/n) when the highest reported SAR for DSSS(802.11b) is ≤ 1.2 W/kg, and the output power for DSSS is not less than that for OFDM.

WLAN 5G:

| EUT Position | Frequency (MHz) | Test Mode | Bandwidth (MHz) | Max. Meas. Power (dBm) | Max. Rated Power (dBm) | 1g SAR (W/kg) | | | |
|------------------|-----------------|-----------|-----------------|------------------------|------------------------|---------------|-----------|------------|------|
| | | | | | | Scaled Factor | Meas. SAR | Scaled SAR | Plot |
| Body Front (0mm) | 5180 | 802.11a | 20 | 14.48 | 15 | 1.127 | 0.253 | 0.285 | / |
| | 5200 | 802.11a | 20 | / | / | / | / | / | / |
| | 5240 | 802.11a | 20 | / | / | / | / | / | / |
| Body-Back (0mm) | 5180 | 802.11a | 20 | 14.48 | 15 | 1.127 | 0.112 | 0.126 | / |
| | 5200 | 802.11a | 20 | / | / | / | / | / | / |
| | 5240 | 802.11a | 20 | / | / | / | / | / | / |
| Body- Left (0mm) | 5180 | 802.11a | 20 | 14.48 | 15 | 1.127 | 0.309 | 0.348 | / |
| | 5200 | 802.11a | 20 | / | / | / | / | / | / |
| | 5240 | 802.11a | 20 | / | / | / | / | / | / |
| Body-Top (0mm) | 5180 | 802.11a | 20 | 14.48 | 15 | 1.127 | 0.552 | 0.622 | #14 |
| | 5200 | 802.11a | 20 | 14.36 | 15 | 1.159 | 0.516 | 0.598 | / |
| | 5240 | 802.11a | 20 | 12.67 | 13 | 1.079 | 0.402 | 0.434 | / |

| EUT Position | Frequency (MHz) | Test Mode | Bandwidth (MHz) | Max. Meas. Power (dBm) | Max. Rated Power (dBm) | 1g SAR (W/kg) | | | |
|------------------|-----------------|-----------|-----------------|------------------------|------------------------|---------------|-----------|------------|------|
| | | | | | | Scaled Factor | Meas. SAR | Scaled SAR | Plot |
| Body Front (0mm) | 5745 | 802.11a | 20 | / | / | / | / | / | / |
| | 5785 | 802.11a | 20 | 10.51 | 10.8 | 1.069 | 0.051 | 0.055 | / |
| | 5825 | 802.11a | 20 | / | / | / | / | / | / |
| Body-Back (0mm) | 5745 | 802.11a | 20 | / | / | / | / | / | / |
| | 5785 | 802.11a | 20 | 10.51 | 10.8 | 1.069 | 0.126 | 0.135 | / |
| | 5825 | 802.11a | 20 | / | / | / | / | / | / |
| Body-Left (0mm) | 5745 | 802.11a | 20 | / | / | / | / | / | / |
| | 5785 | 802.11a | 20 | 10.51 | 10.8 | 1.069 | 0.076 | 0.081 | / |
| | 5825 | 802.11a | 20 | / | / | / | / | / | / |
| Body-Top (0mm) | 5745 | 802.11a | 20 | / | / | / | / | / | / |
| | 5785 | 802.11a | 20 | 10.51 | 10.8 | 1.069 | 0.302 | 0.323 | #15 |
| | 5825 | 802.11a | 20 | / | / | / | / | / | / |

SAR SIMULTANEOUS TRANSMISSION DESCRIPTION

Simultaneous Transmission:

| Description of Simultaneous Transmit Capabilities | | |
|---|---------------|----------|
| Transmitter Combination | Simultaneous? | Hotspot? |
| WWAN(GSM/WCDMA/LTE) + WLAN 2.4G | √ | √ |
| WWAN(GSM/WCDMA/LTE) + WLAN 5G | √ | √ |
| WWAN(GSM/WCDMA/LTE) + Bluetooth | √ | X |

Simultaneous Transmission Consideration Detail

| Transmitter Combination | Position | Max SAR(W/kg) | | ΣSAR< 1.6W/kg |
|-------------------------|------------|---------------|------------|---------------|
| | | SAR1(WWAN) | SAR2(WLAN) | |
| WWAN+ WLAN 2.4G | Body Front | 0.879 | 0.470 | 1.349 |
| | Body Back | 0.843 | 0.485 | 1.328 |
| | Body Left | N/A | 0.463 | N/A |
| | Body Right | 0.860 | N/A | N/A |
| | Body Top | 0.342 | 0.254 | 0.596 |

| Transmitter Combination | Position | Max SAR(W/kg) | | ΣSAR< 1.6W/kg |
|-------------------------|------------|---------------|------------|---------------|
| | | SAR1(WWAN) | SAR2(WLAN) | |
| WWAN+ Bluetooth | Body Front | 0.879 | 0.234 | 1.113 |
| | Body Back | 0.843 | 0.234 | 1.077 |
| | Body Left | N/A | 0.234 | N/A |
| | Body Right | 0.860 | 0.234 | 1.094 |
| | Body Top | 0.342 | 0.234 | 0.576 |

| Transmitter Combination | Position | Max SAR(W/kg) | | ΣSAR< 1.6W/kg |
|-------------------------|------------|---------------|------------|---------------|
| | | SAR1(WWAN) | SAR2(WLAN) | |
| WWAN+ WLAN 5G | Body Front | 0.879 | 0.285 | 1.164 |
| | Body Back | 0.843 | 0.135 | 0.978 |
| | Body Left | N/A | 0.348 | N/A |
| | Body Right | 0.860 | N/A | N/A |
| | Body Top | 0.342 | 0.622 | 0.964 |

Conclusion:

Sum of SAR: $\Sigma SAR \leq 1.6 \text{ W/kg}$ for 1g Body SAR , therefore simultaneous transmission SAR with Volume Scans is **not required**.

SAR Plots

Test Plot 1# GSM850_GPRS 4 Tx slots_Front_0mm_Ch190

Communication System: UID 0, GSM850 (0); Frequency: 836.6 MHz; Duty Cycle: 1:2.08
 Medium parameters used: $f = 836.6 \text{ MHz}$; $\sigma = 0.908 \text{ S/m}$; $\epsilon_r = 42.001$; $\rho = 1000 \text{ kg/m}^3$

DASY5 Configuration:

- Probe: EX3DV4 - SN7557; ConvF(10.1, 10.1, 10.1); Calibrated: 4/10/2019,
- Sensor-Surface: 1.4mm (Mechanical Surface Detection)
- Electronics: DAE4 Sn527; Calibrated: 7/9/2020
- Phantom: ELI V8.0; Type: QD OVA 004 Ax; Serial: 2095
- Measurement SW: DASY52, Version 52.10 (1); SEMCAD X Version 14.6.11 (7437)

Area Scan (101x71x1): Interpolated grid: $dx=1.500 \text{ mm}$, $dy=1.500 \text{ mm}$
 Maximum value of SAR (interpolated) = 0.316 W/kg

Zoom Scan (6x6x7)/Cube 0: Measurement grid: $dx=8\text{mm}$, $dy=8\text{mm}$, $dz=5\text{mm}$
 Reference Value = 2.603 V/m ; Power Drift = -0.00 dB
 Peak SAR (extrapolated) = 0.448 W/kg
SAR(1 g) = 0.222 W/kg ; SAR(10 g) = 0.121 W/kg
 Maximum value of SAR (measured) = 0.331 W/kg

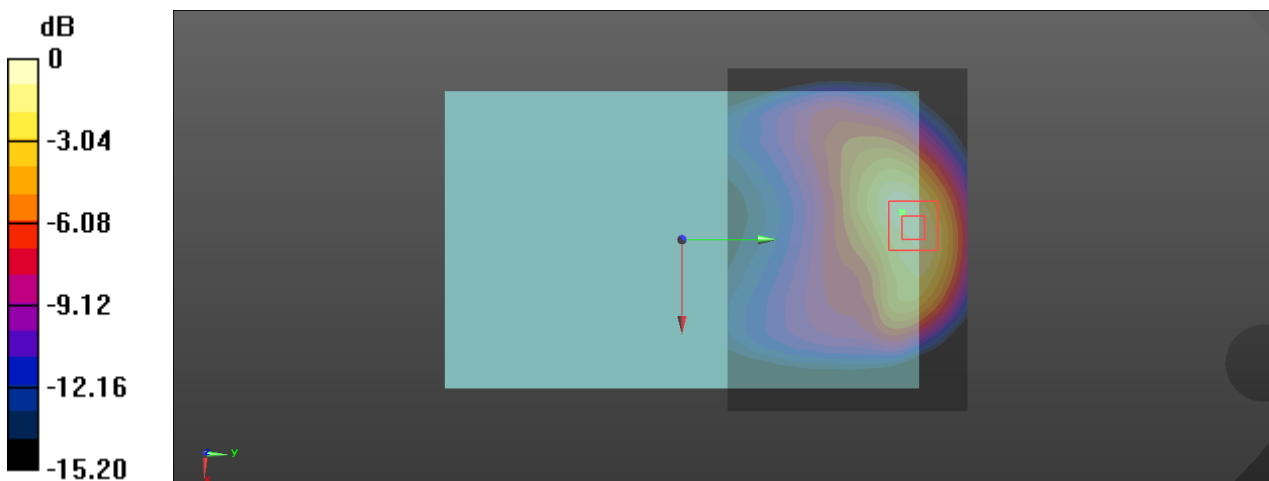

$0 \text{ dB} = 0.331 \text{ W/kg} = -4.80 \text{ dBW/kg}$

Test Plot 2# GSM1900_GPRS 4 Tx slots_Right Side_0mm_Ch661

Communication System: UID 0, GSM 1900 (0); Frequency: 1880 MHz;Duty Cycle: 1:2.08
 Medium parameters used: f = 1880 MHz; $\sigma = 1.39$ S/m; $\epsilon_r = 38.807$; $\rho = 1000$ kg/m³

DASY5 Configuration:

- Probe: EX3DV4 - SN7557;ConvF(8.36, 8.36, 8.36); Calibrated: 4/10/2019,
- Sensor-Surface: 1.4mm (Mechanical Surface Detection)
- Electronics: DAE4 Sn527; Calibrated: 7/9/2020
- Phantom: ELI V8.0; Type: QD OVA 004 Ax; Serial: 2095
- Measurement SW: DASY52, Version 52.10 (1); SEMCAD X Version 14.6.11 (7437)

Area Scan (31x91x1): Interpolated grid: dx=1.500 mm, dy=1.500 mm
 Maximum value of SAR (interpolated) = 0.785 W/kg

Zoom Scan (5x5x7)/Cube 0: Measurement grid: dx=8mm, dy=8mm, dz=5mm
 Reference Value = 11.73 V/m; Power Drift = 0.03 dB
 Peak SAR (extrapolated) = 0.903 W/kg
SAR(1 g) = 0.515 W/kg; SAR(10 g) = 0.285 W/kg
 Maximum value of SAR (measured) = 0.752 W/kg

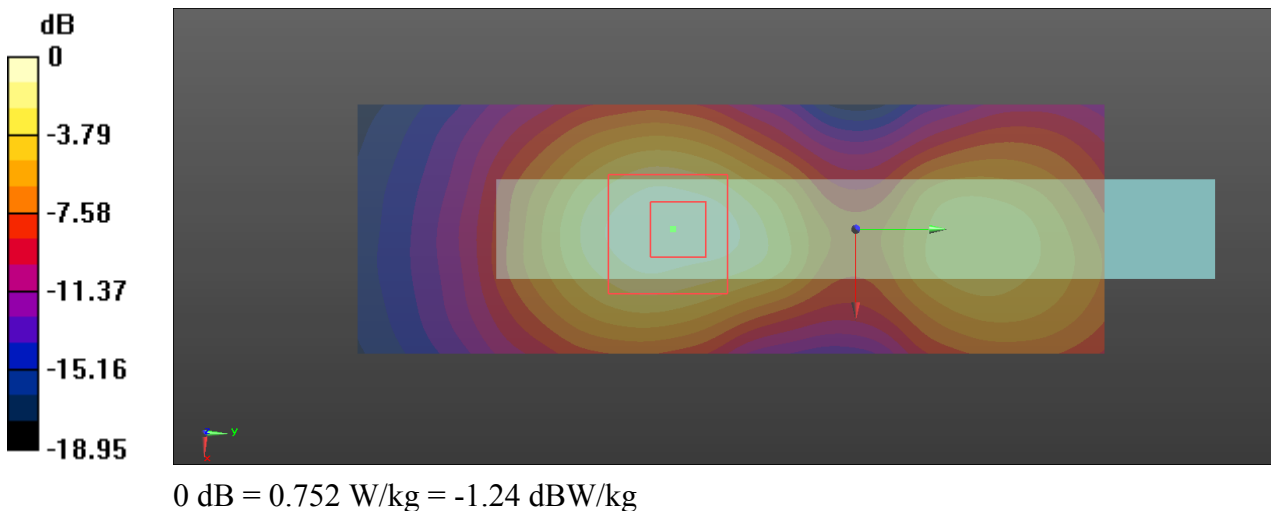

Test plot 3#WCDMA V_RMC 12.2Kbps_Back_0mm_Ch4182

Communication System: UID 0, WCDMA 3G (0); Frequency: 836.4 MHz; Duty Cycle: 1:1
 Medium parameters used: $f = 836.4 \text{ MHz}$; $\sigma = 0.908 \text{ S/m}$; $\epsilon_r = 42.001$; $\rho = 1000 \text{ kg/m}^3$

DASY5 Configuration:

- Probe: EX3DV4 - SN7557; ConvF(10.1, 10.1, 10.1); Calibrated: 4/10/2019,
- Sensor-Surface: 1.4mm (Mechanical Surface Detection)
- Electronics: DAE4 Sn527; Calibrated: 7/9/2020
- Phantom: ELI V8.0; Type: QD OVA 004 Ax; Serial: 2095
- Measurement SW: DASY52, Version 52.10 (1); SEMCAD X Version 14.6.11 (7437)

Area Scan (101x71x1): Interpolated grid: $dx=1.500 \text{ mm}$, $dy=1.500 \text{ mm}$
 Maximum value of SAR (interpolated) = 0.663 W/kg

Zoom Scan (5x5x7)/Cube 0: Measurement grid: $dx=8\text{mm}$, $dy=8\text{mm}$, $dz=5\text{mm}$
 Reference Value = 6.211 V/m ; Power Drift = 0.11 dB
 Peak SAR (extrapolated) = 1.21 W/kg
SAR(1 g) = 0.622 W/kg ; SAR(10 g) = 0.348 W/kg
 Maximum value of SAR (measured) = 0.977 W/kg

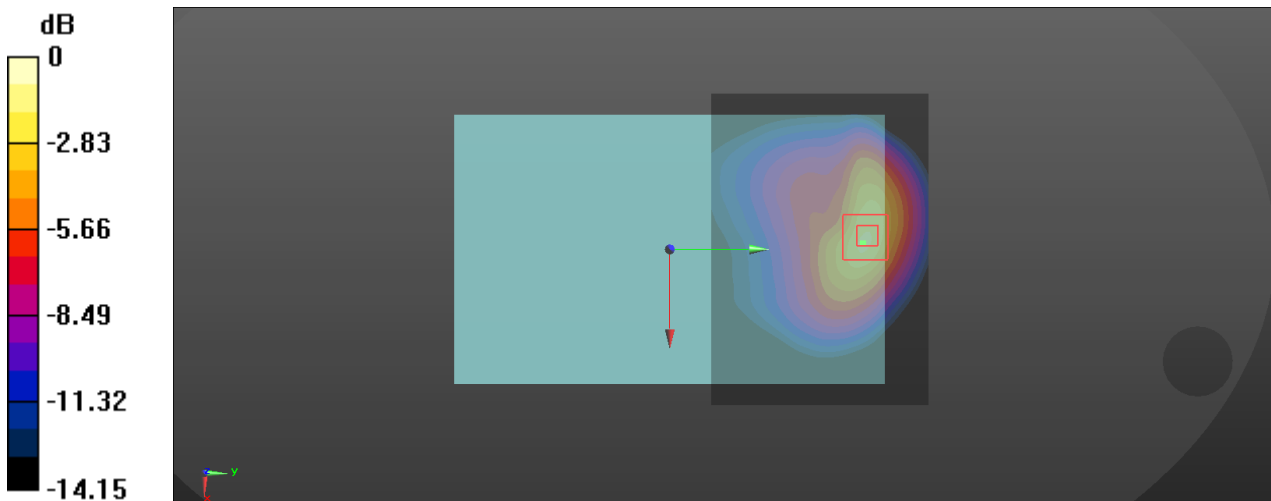

0 dB = $0.977 \text{ W/kg} = -0.10 \text{ dBW/kg}$

Test plot 4# WCDMA II_RMC 12.2Kbps_Front_0mm_Ch9400

Communication System: UID 0, WCDMA 3G (0); Frequency: 1880 MHz;Duty Cycle: 1:1
 Medium parameters used: $f = 1880 \text{ MHz}$; $\sigma = 1.39 \text{ S/m}$; $\epsilon_r = 38.807$; $\rho = 1000 \text{ kg/m}^3$

DASY5 Configuration:

- Probe: EX3DV4 - SN7557;ConvF(8.36, 8.36, 8.36); Calibrated: 4/10/2019,
- Sensor-Surface: 1.4mm (Mechanical Surface Detection)
- Electronics: DAE4 Sn527; Calibrated: 7/9/2020
- Phantom: ELI V8.0; Type: QD OVA 004 Ax; Serial: 2095
- Measurement SW: DASY52, Version 52.10 (1); SEMCAD X Version 14.6.11 (7437)

Area Scan (101x71x1): Interpolated grid: $dx=1.500 \text{ mm}$, $dy=1.500 \text{ mm}$
 Maximum value of SAR (interpolated) = 0.462 W/kg

Zoom Scan (5x5x7)/Cube 0: Measurement grid: $dx=8\text{mm}$, $dy=8\text{mm}$, $dz=5\text{mm}$
 Reference Value = 0 V/m ; Power Drift = 0.00 dB
 Peak SAR (extrapolated) = 0.904 W/kg
SAR(1 g) = 0.407 W/kg ; SAR(10 g) = 0.208 W/kg
 Maximum value of SAR (measured) = 0.636 W/kg

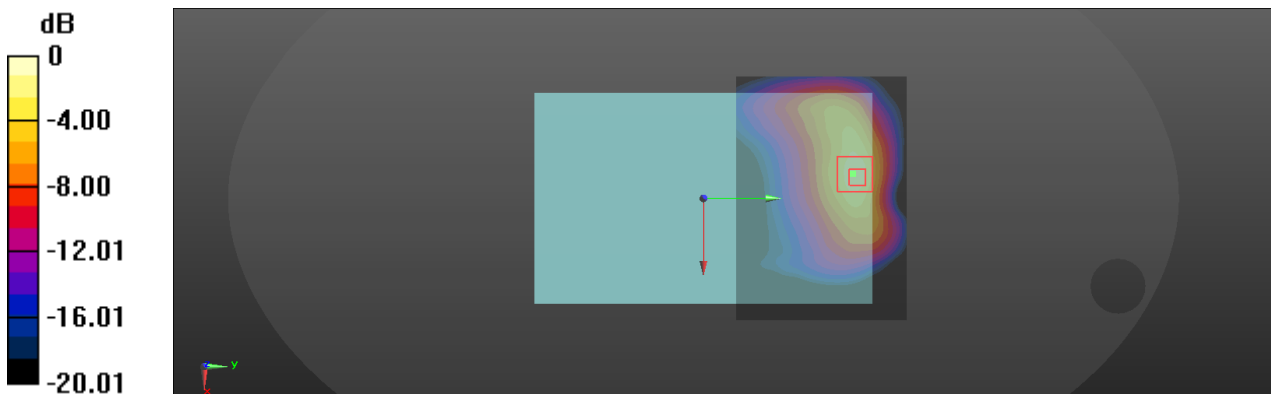

$0 \text{ dB} = 0.636 \text{ W/kg} = -1.97 \text{ dBW/kg}$

Test plot 5# CDMA_RC3 SO32 (F+SCH) _Front_0mm_Ch384

Communication System: UID 0, CDMA2000 BC0 (0); Frequency: 836.52 MHz;Duty Cycle: 1:1
 Medium parameters used: $f = 837 \text{ MHz}$; $\sigma = 0.908 \text{ S/m}$; $\epsilon_r = 42.001$; $\rho = 1000 \text{ kg/m}^3$

DASY5 Configuration:

- Probe: EX3DV4 - SN7557;ConvF(10.1, 10.1, 10.1); Calibrated: 4/10/2019,
- Sensor-Surface: 1.4mm (Mechanical Surface Detection)
- Electronics: DAE4 Sn527; Calibrated: 7/9/2020
- Phantom: ELI V8.0; Type: QD OVA 004 Ax; Serial: 2095
- Measurement SW: DASY52, Version 52.10 (1); SEMCAD X Version 14.6.11 (7437)

Area Scan (101x71x1): Interpolated grid: $dx=1.500 \text{ mm}$, $dy=1.500 \text{ mm}$
 Maximum value of SAR (interpolated) = 0.701 W/kg

Zoom Scan (5x5x7)/Cube 0: Measurement grid: $dx=8\text{mm}$, $dy=8\text{mm}$, $dz=5\text{mm}$

Reference Value = 3.498 V/m ; Power Drift = -0.02 dB

Peak SAR (extrapolated) = 1.49 W/kg

SAR(1 g) = 0.673 W/kg ; SAR(10 g) = 0.355 W/kg

Maximum value of SAR (measured) = 1.12 W/kg

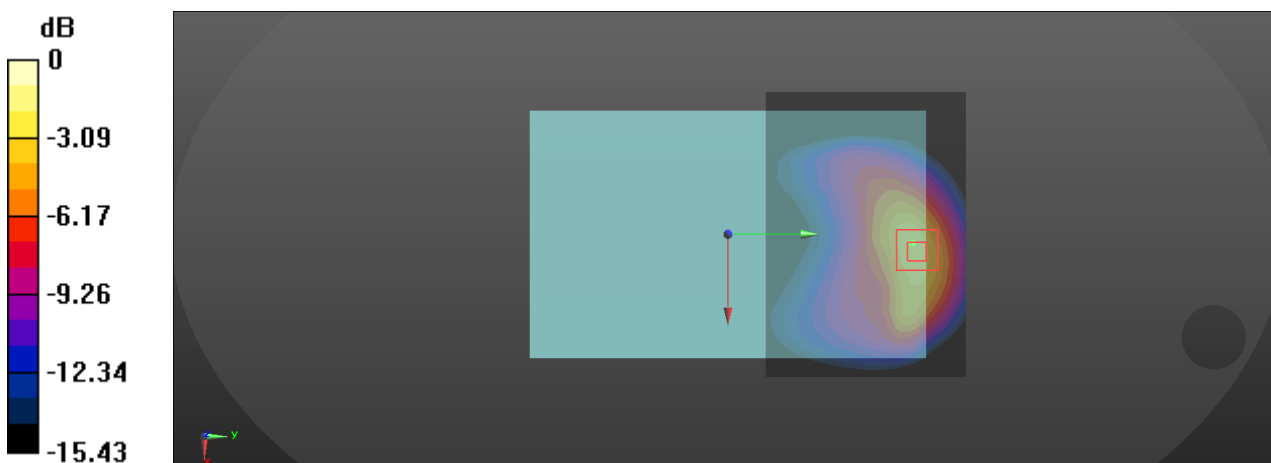

$0 \text{ dB} = 1.12 \text{ W/kg} = 0.49 \text{ dBW/kg}$

Test plot 6#EVDO_RTAP 153.6Kbps _Front_0mm_Ch384

Communication System: UID 0, CDMA2000 BC0 (0); Frequency: 836.52 MHz;Duty Cycle: 1:1
Medium parameters used: $f = 837 \text{ MHz}$; $\sigma = 0.908 \text{ S/m}$; $\epsilon_r = 42.001$; $\rho = 1000 \text{ kg/m}^3$

DASY5 Configuration:

- Probe: EX3DV4 - SN7557;ConvF(10.1, 10.1, 10.1); Calibrated: 4/10/2019,
- Sensor-Surface: 1.4mm (Mechanical Surface Detection)
- Electronics: DAE4 Sn527; Calibrated: 7/9/2020
- Phantom: ELI V8.0; Type: QD OVA 004 Ax; Serial: 2095
- Measurement SW: DASY52, Version 52.10 (1); SEMCAD X Version 14.6.11 (7437)

Area Scan (101x71x1): Interpolated grid: $dx=1.500 \text{ mm}$, $dy=1.500 \text{ mm}$
Maximum value of SAR (interpolated) = 0.676 W/kg

Zoom Scan (5x5x7)/Cube 0: Measurement grid: $dx=8\text{mm}$, $dy=8\text{mm}$, $dz=5\text{mm}$
Reference Value = 3.384 V/m ; Power Drift = -0.10 dB
Peak SAR (extrapolated) = 1.36 W/kg
SAR(1 g) = 0.606 W/kg ; SAR(10 g) = 0.342 W/kg
Maximum value of SAR (measured) = 1.01 W/kg

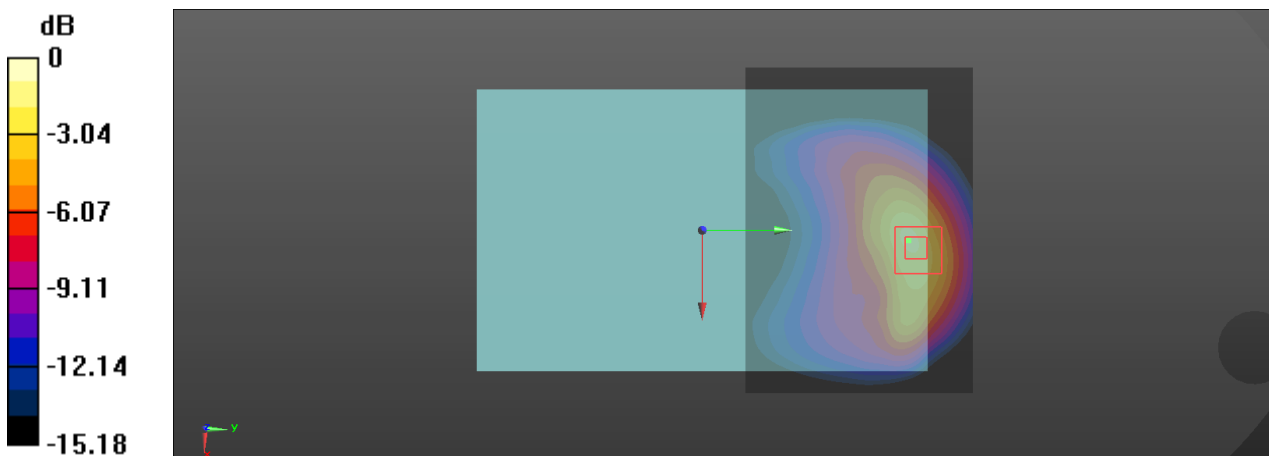

0 dB = 1.01 W/kg = 0.04 dBW/kg

Test plot 7#LTE Band 17_10M_QPSK_1RB_0offset_Back_0mm_Ch23790

Communication System: UID 0, FDD LTE 4G (0); Frequency: 710 MHz;Duty Cycle: 1:1
 Medium parameters used: $f = 710 \text{ MHz}$; $\sigma = 0.856 \text{ S/m}$; $\epsilon_r = 41.786$; $\rho = 1000 \text{ kg/m}^3$

DASY5 Configuration:

- Probe: EX3DV4 - SN7382;ConvF(10.41, 10.41, 10.41); Calibrated: 4/10/2019,
- Sensor-Surface: 1.4mm (Mechanical Surface Detection)
- Electronics: DAE4 Sn527; Calibrated: 7/9/2020
- Phantom: ELI V8.0; Type: QD OVA 004 Ax; Serial: 2095
- Measurement SW: DASY52, Version 52.10 (1); SEMCAD X Version 14.6.11 (7437)

Area Scan (101x61x1): Interpolated grid: $dx=1.500 \text{ mm}$, $dy=1.500 \text{ mm}$
 Maximum value of SAR (interpolated) = 0.926 W/kg

Zoom Scan (5x5x7)/Cube 0: Measurement grid: $dx=8\text{mm}$, $dy=8\text{mm}$, $dz=5\text{mm}$
 Reference Value = 8.740 V/m ; Power Drift = 0.06 dB
 Peak SAR (extrapolated) = 1.37 W/kg
SAR(1 g) = 0.682 W/kg ; SAR(10 g) = 0.384 W/kg
 Maximum value of SAR (measured) = 1.09 W/kg

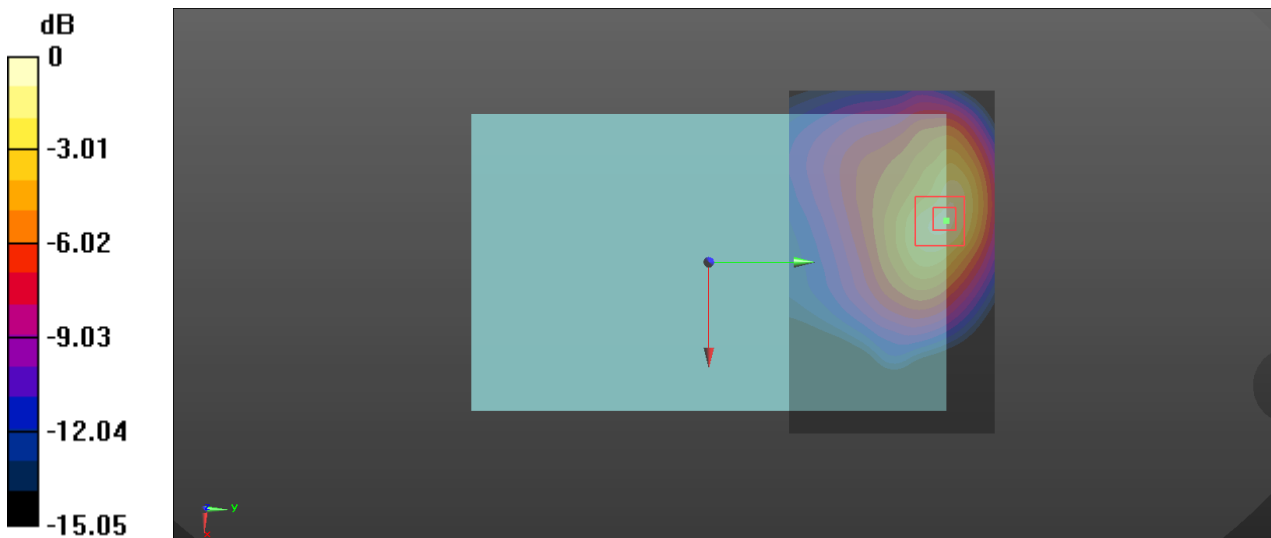

0 dB = $1.09 \text{ W/kg} = 0.37 \text{ dBW/kg}$

Test plot 8#LTE Band 5_10M_QPSK_1RB_0offset_Back_0mm_Ch20525

Communication System: UID 0, FDD LTE 4G (0); Frequency: 836.5 MHz;Duty Cycle: 1:1
 Medium parameters used: $f = 836.5 \text{ MHz}$; $\sigma = 0.908 \text{ S/m}$; $\epsilon_r = 42.001$; $\rho = 1000 \text{ kg/m}^3$

DASY5 Configuration:

- Probe: EX3DV4 - SN7557;ConvF(10.1, 10.1, 10.1); Calibrated: 4/10/2019,
- Sensor-Surface: 1.4mm (Mechanical Surface Detection)
- Electronics: DAE4 Sn527; Calibrated: 7/9/2020
- Phantom: ELI V8.0; Type: QD OVA 004 Ax; Serial: 2095
- Measurement SW: DASY52, Version 52.10 (1); SEMCAD X Version 14.6.11 (7437)

Area Scan (101x61x1): Interpolated grid: $dx=1.500 \text{ mm}$, $dy=1.500 \text{ mm}$
 Maximum value of SAR (interpolated) = 1.04 W/kg

Zoom Scan (5x5x7)/Cube 0: Measurement grid: $dx=8\text{mm}$, $dy=8\text{mm}$, $dz=5\text{mm}$
 Reference Value = 7.412 V/m; Power Drift = 0.01 dB
 Peak SAR (extrapolated) = 1.38 W/kg
SAR(1 g) = 0.715 W/kg; SAR(10 g) = 0.398 W/kg
 Maximum value of SAR (measured) = 1.13 W/kg

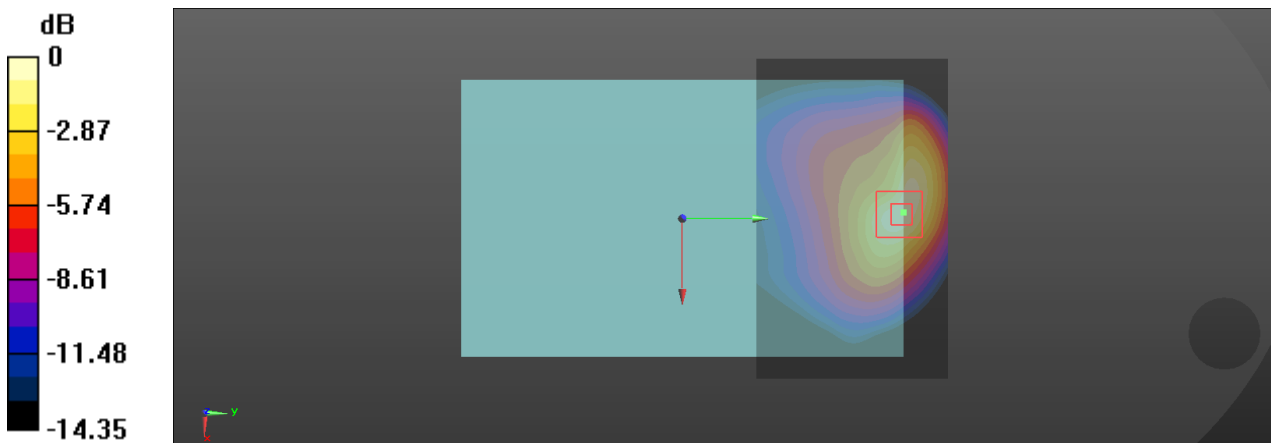

0 dB = 1.13 W/kg = 0.53 dBW/kg

Test plot 9#LTE Band 4_20M_QPSK_1RB_0offset_Right Side_0mm_Ch20175

Communication System: UID 0, FDD LTE 4G (0); Frequency: 1732.5 MHz;Duty Cycle: 1:1
 Medium parameters used: $f = 1733 \text{ MHz}$; $\sigma = 1.38 \text{ S/m}$; $\epsilon_r = 39.696$; $\rho = 1000 \text{ kg/m}^3$

DASY5 Configuration:

- Probe: EX3DV4 - SN7557;ConvF(8.67, 8.67, 8.67); Calibrated: 4/10/2019,
- Sensor-Surface: 1.4mm (Mechanical Surface Detection)
- Electronics: DAE4 Sn527; Calibrated: 7/9/2020
- Phantom: ELI V8.0; Type: QD OVA 004 Ax; Serial: 2095
- Measurement SW: DASY52, Version 52.10 (1); SEMCAD X Version 14.6.11 (7437)

Area Scan (31x101x1): Interpolated grid: $dx=1.500 \text{ mm}$, $dy=1.500 \text{ mm}$
 Maximum value of SAR (interpolated) = 0.805 W/kg

Zoom Scan (5x5x7)/Cube 0: Measurement grid: $dx=8\text{mm}$, $dy=8\text{mm}$, $dz=5\text{mm}$
 Reference Value = 16.22 V/m ; Power Drift = 0.05 dB
 Peak SAR (extrapolated) = 0.962 W/kg
SAR(1 g) = 0.529 W/kg ; SAR(10 g) = 0.290 W/kg
 Maximum value of SAR (measured) = 0.781 W/kg

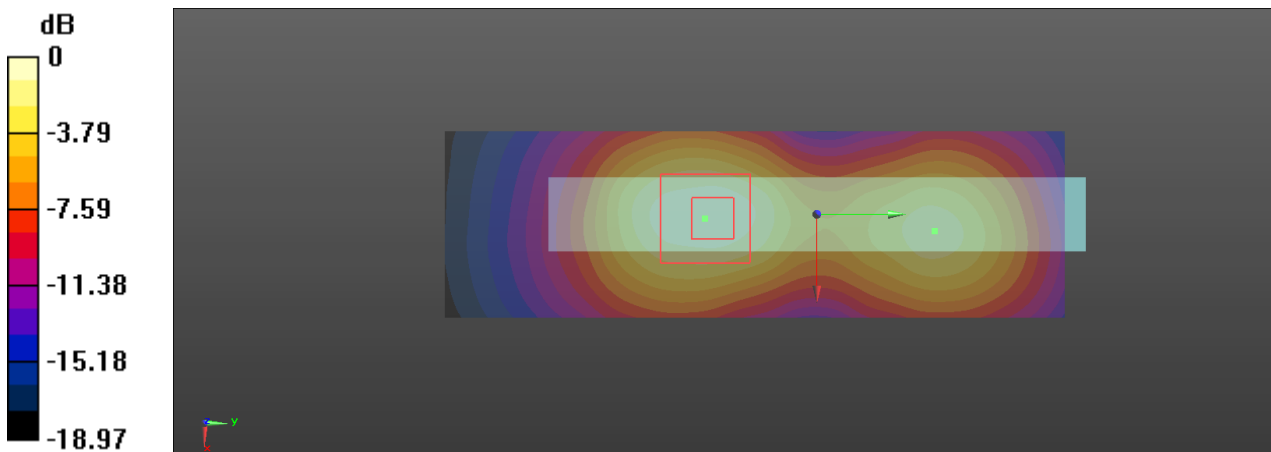

$0 \text{ dB} = 0.781 \text{ W/kg} = -1.07 \text{ dBW/kg}$

Test plot 10#LTE Band 2_20M_QPSK_1RB_0offset_Front_0mm_Ch18900

Communication System: UID 0, FDD LTE 4G (0); Frequency: 1880 MHz;Duty Cycle: 1:1
 Medium parameters used: $f = 1880 \text{ MHz}$; $\sigma = 1.39 \text{ S/m}$; $\epsilon_r = 38.807$; $\rho = 1000 \text{ kg/m}^3$

DASY5 Configuration:

- Probe: EX3DV4 - SN7557;ConvF(8.36, 8.36, 8.36); Calibrated: 4/10/2019, ConvF(8.29, 8.29, 8.29); Calibrated: 8/10/2018;
- Sensor-Surface: 1.4mm (Mechanical Surface Detection)
- Electronics: DAE4 Sn527; Calibrated: 7/9/2020
- Phantom: ELI V8.0; Type: QD OVA 004 Ax; Serial: 2095
- Measurement SW: DASY52, Version 52.10 (1); SEMCAD X Version 14.6.11 (7437)

Area Scan (101x61x1): Interpolated grid: $dx=1.500 \text{ mm}$, $dy=1.500 \text{ mm}$
 Maximum value of SAR (interpolated) = 0.975 W/kg

Zoom Scan (5x5x7)/Cube 0: Measurement grid: $dx=8\text{mm}$, $dy=8\text{mm}$, $dz=5\text{mm}$
 Reference Value = 0.1070 V/m ; Power Drift = 0.1 dB
 Peak SAR (extrapolated) = 1.34 W/kg
SAR(1 g) = 0.597 W/kg ; SAR(10 g) = 0.296 W/kg
 Maximum value of SAR (measured) = 0.951 W/kg

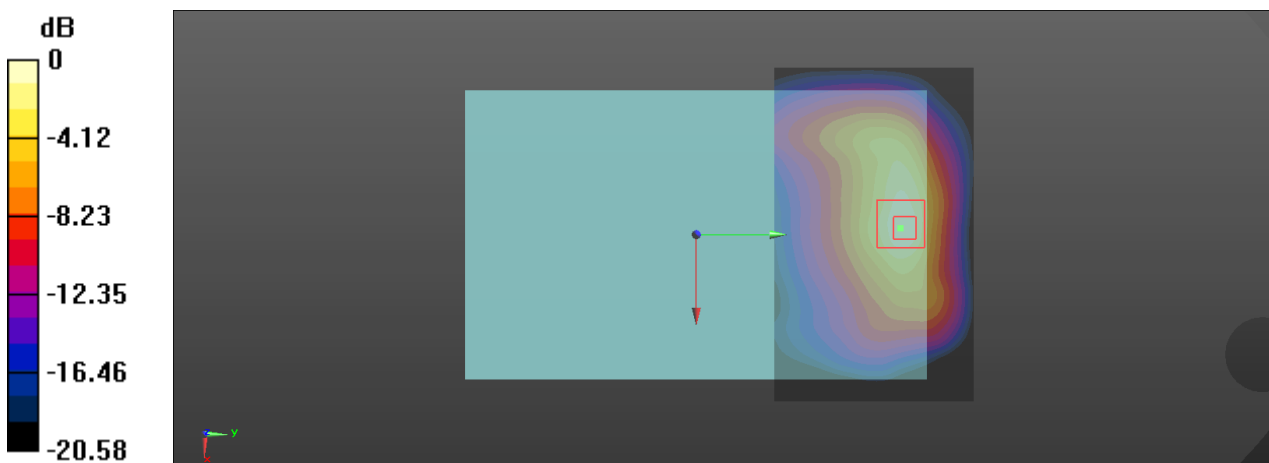

$0 \text{ dB} = 0.951 \text{ W/kg} = -0.22 \text{ dBW/kg}$

Test plot 11#LTE Band 7_20M_QPSK_1RB_0offset_Front_0mm_Ch21100

Communication System: UID 0, FDD LTE 4G (0); Frequency: 2535 MHz;Duty Cycle: 1:1
 Medium parameters used: $f = 2535 \text{ MHz}$; $\sigma = 1.971 \text{ S/m}$; $\epsilon_r = 37.768$; $\rho = 1000 \text{ kg/m}^3$

DASY5 Configuration:

- Probe: EX3DV4 - SN7557;ConvF(7.21, 7.21, 7.21); Calibrated: 4/10/2019,
- Sensor-Surface: 1.4mm (Mechanical Surface Detection)
- Electronics: DAE4 Sn527; Calibrated: 7/9/2020
- Phantom: ELI V8.0; Type: QD OVA 004 Ax; Serial: 2095
- Measurement SW: DASY52, Version 52.10 (1); SEMCAD X Version 14.6.11 (7437)

Area Scan (121x71x1): Interpolated grid: $dx=1.200 \text{ mm}$, $dy=1.200 \text{ mm}$
 Maximum value of SAR (interpolated) = 0.907 W/kg

Zoom Scan (7x7x7)/Cube 0: Measurement grid: $dx=5\text{mm}$, $dy=5\text{mm}$, $dz=5\text{mm}$
 Reference Value = 0 V/m ; Power Drift = 0.00 dB
 Peak SAR (extrapolated) = 1.61 W/kg
SAR(1 g) = 0.629 W/kg ; SAR(10 g) = 0.255 W/kg
 Maximum value of SAR (measured) = 1.15 W/kg

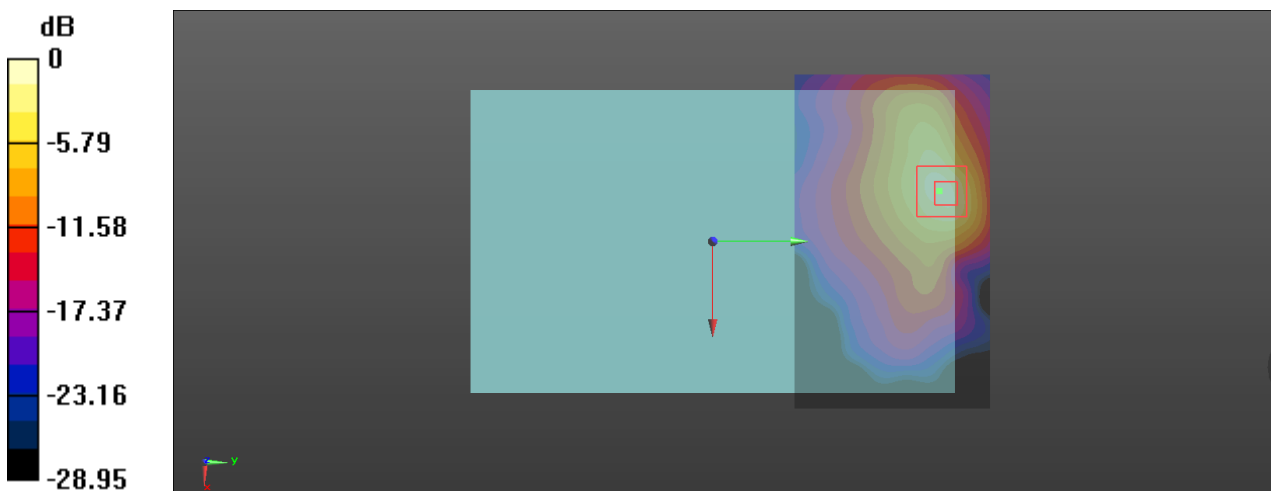

0 dB = 1.15 W/kg = 0.61 dBW/kg

Test plot 12# LTE Band 41_20M_QPSK_1RB_0offset_Front_0mm_Ch40620

Communication System: UID 0, TDD LTE 4G (0); Frequency: 2593 MHz;Duty Cycle: 1:1.59
 Medium parameters used: $f = 2593 \text{ MHz}$; $\sigma = 1.991 \text{ S/m}$; $\epsilon_r = 37.544$; $\rho = 1000 \text{ kg/m}^3$

DASY5 Configuration:

- Probe: EX3DV4 - SN7557;ConvF(7.21, 7.21, 7.21); Calibrated: 4/10/2019,
- Sensor-Surface: 1.4mm (Mechanical Surface Detection)
- Electronics: DAE4 Sn527; Calibrated: 7/9/2020
- Phantom: ELI V8.0; Type: QD OVA 004 Ax; Serial: 2095
- Measurement SW: DASY52, Version 52.10 (1); SEMCAD X Version 14.6.11 (7437)

Area Scan (121x71x1): Interpolated grid: $dx=1.200 \text{ mm}$, $dy=1.200 \text{ mm}$
 Maximum value of SAR (interpolated) = 1.07 W/kg

Zoom Scan (7x7x7)/Cube 0: Measurement grid: $dx=5\text{mm}$, $dy=5\text{mm}$, $dz=5\text{mm}$
 Reference Value = 0.3040 V/m; Power Drift = -0.07 dB
 Peak SAR (extrapolated) = 1.87 W/kg
SAR(1 g) = 0.755 W/kg; SAR(10 g) = 0.295 W/kg
 Maximum value of SAR (measured) = 1.36 W/kg

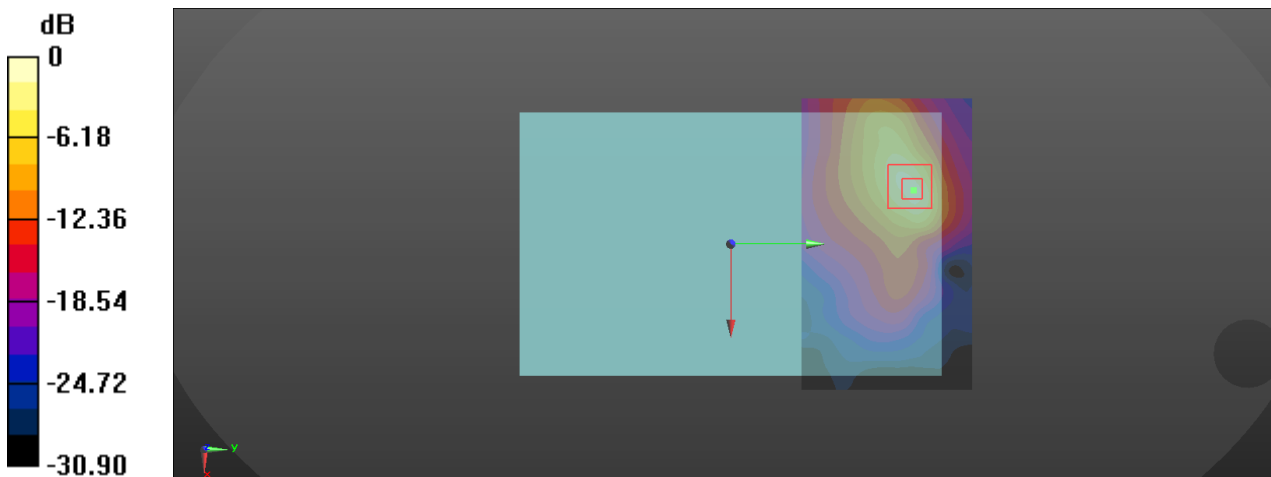

$0 \text{ dB} = 1.36 \text{ W/kg} = 1.34 \text{ dBW/kg}$

Test plot 13#WLAN 2.4GHz_802.11b 1Mbps_Back_0mm_Ch6

Communication System: UID 0, WIFI2.4G (0); Frequency: 2437 MHz;Duty Cycle: 1:1
 Medium parameters used: $f = 2437 \text{ MHz}$; $\sigma = 1.86 \text{ S/m}$; $\epsilon_r = 39.273$; $\rho = 1000 \text{ kg/m}^3$

DASY5 Configuration:

- Probe: EX3DV4 - SN7557;ConvF(7.41, 7.41, 7.41); Calibrated: 4/10/2019,
- Sensor-Surface: 1.4mm (Mechanical Surface Detection)
- Electronics: DAE4 Sn527; Calibrated: 7/9/2020
- Phantom: ELI V8.0; Type: QD OVA 004 Ax; Serial: 2095
- Measurement SW: DASY52, Version 52.10 (1); SEMCAD X Version 14.6.11 (7437)

Area Scan (111x71x1): Interpolated grid: $dx=1.200 \text{ mm}$, $dy=1.200 \text{ mm}$
 Maximum value of SAR (interpolated) = 0.788 W/kg

Zoom Scan (9x8x7)/Cube 0: Measurement grid: $dx=5\text{mm}$, $dy=5\text{mm}$, $dz=5\text{mm}$
 Reference Value = 1.939 V/m ; Power Drift = 0.01 dB
 Peak SAR (extrapolated) = 0.932 W/kg
SAR(1 g) = 0.451 W/kg ; SAR(10 g) = 0.220 W/kg
 Maximum value of SAR (measured) = 0.725 W/kg

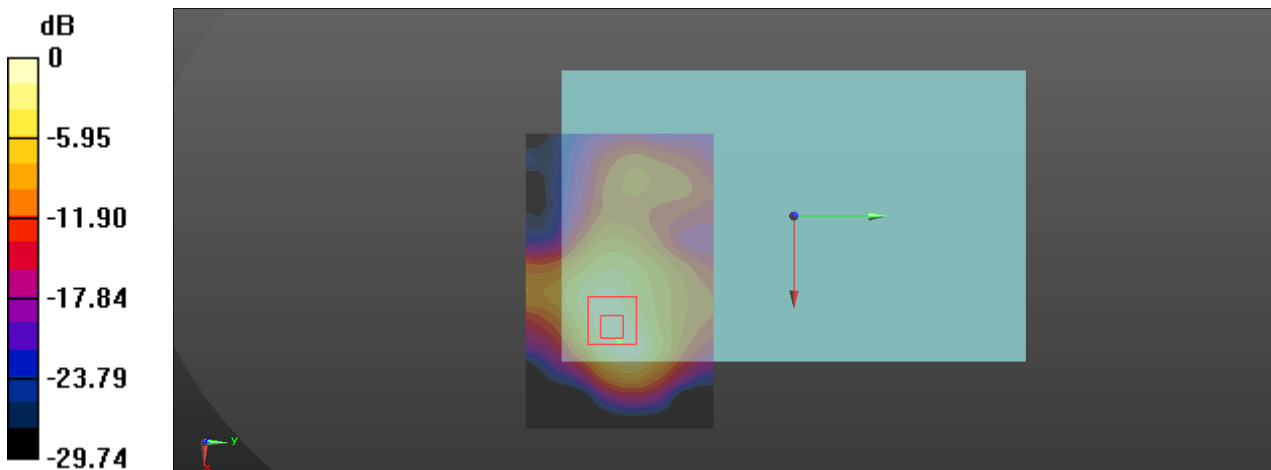

$0 \text{ dB} = 0.725 \text{ W/kg} = -1.40 \text{ dBW/kg}$

Test plot 14#WLAN 5GHz_802.11n-HT20 MCS0_Top Side_0mm_Ch36

Communication System: UID 0, WIFI 5G (0); Frequency: 5180 MHz;Duty Cycle: 1:1
 Medium parameters used: $f = 5180 \text{ MHz}$; $\sigma = 4.513 \text{ S/m}$; $\epsilon_r = 36.874$; $\rho = 1000 \text{ kg/m}^3$

DASY5 Configuration:

- Probe: EX3DV4 - SN7557;ConvF(5.38, 5.38, 5.38); Calibrated: 4/10/2019,
- Sensor-Surface: 1.4mm (Mechanical Surface Detection)
- Electronics: DAE4 Sn527; Calibrated: 7/9/2020
- Phantom: ELI V8.0; Type: QD OVA 004 Ax; Serial: 2095
- Measurement SW: DASY52, Version 52.10 (1); SEMCAD X Version 14.6.11 (7437)

Area Scan (51x91x1): Interpolated grid: $dx=1.000 \text{ mm}$, $dy=1.000 \text{ mm}$

Maximum value of SAR (interpolated) = 2.54 W/kg

Zoom Scan (7x7x7)/Cube 0: Measurement grid: $dx=4\text{mm}$, $dy=4\text{mm}$, $dz=1.4\text{mm}$

Reference Value = 0.7330 V/m; Power Drift = 0.00 dB

Peak SAR (extrapolated) = 3.40 W/kg

SAR(1 g) = 0.552 W/kg; SAR(10 g) = 0.084 W/kg

Maximum value of SAR (measured) = 1.96 W/kg

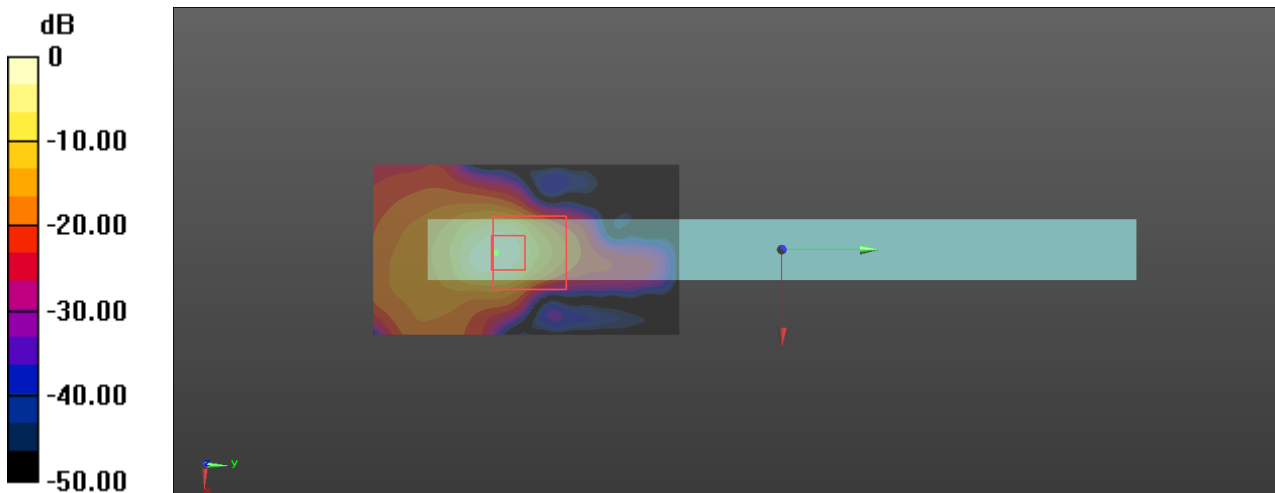

$0 \text{ dB} = 1.96 \text{ W/kg} = 2.92 \text{ dBW/kg}$

Test plot 15#WLAN 5GHz_802.11a 6Mbps_Top Side_0mm_Ch157

Communication System: UID 0, WIFI 5G (0); Frequency: 5785 MHz;Duty Cycle: 1:1
 Medium parameters used: $f = 5785 \text{ MHz}$; $\sigma = 5.233 \text{ S/m}$; $\epsilon_r = 35.553$; $\rho = 1000 \text{ kg/m}^3$

DASY5 Configuration:

- Probe: EX3DV4 - SN7557;ConvF(4.70, 4.70, 4.70); Calibrated: 4/10/2019,
- Sensor-Surface: 1.4mm (Mechanical Surface Detection)
- Electronics: DAE4 Sn527; Calibrated: 7/9/2020
- Phantom: ELI V8.0; Type: QD OVA 004 Ax; Serial: 2095
- Measurement SW: DASY52, Version 52.10 (1); SEMCAD X Version 14.6.11 (7437)

Area Scan (51x91x1): Interpolated grid: $dx=1.000 \text{ mm}$, $dy=1.000 \text{ mm}$
 Maximum value of SAR (interpolated) = 1.13 W/kg

Zoom Scan (7x7x7)/Cube 0: Measurement grid: $dx=4\text{mm}$, $dy=4\text{mm}$, $dz=1.4\text{mm}$
 Reference Value = 0 V/m; Power Drift =0.00 dB
 Peak SAR (extrapolated) = 1.67 W/kg
SAR(1 g) = 0.302 W/kg; SAR(10 g) = 0.063 W/kg
 Maximum value of SAR (measured) = 0.873 W/kg

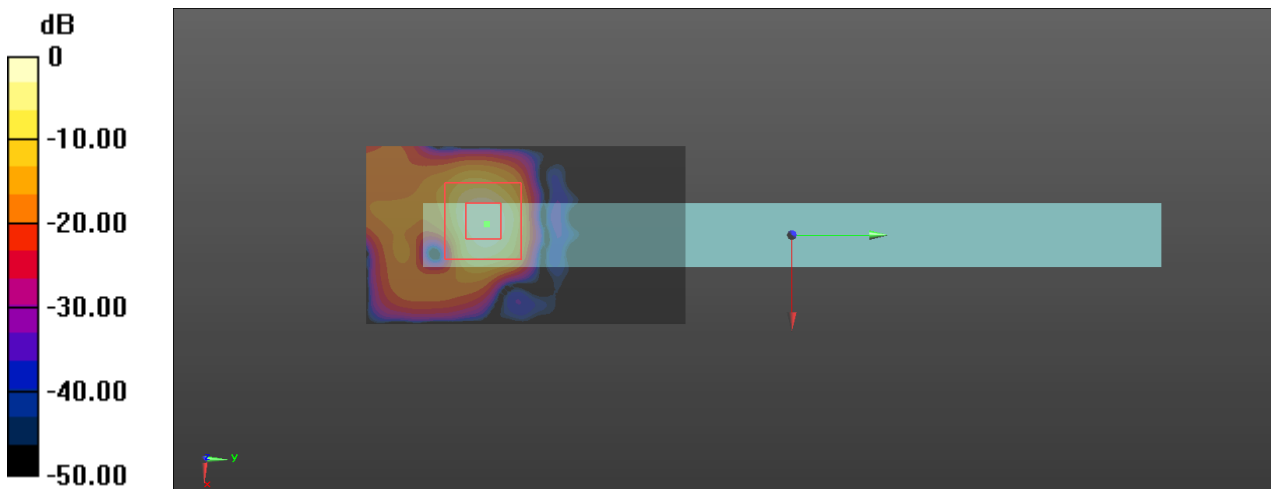

$0 \text{ dB} = 0.873 \text{ W/kg} = -0.59 \text{ dBW/kg}$

APPENDIX A MEASUREMENT UNCERTAINTY

The uncertainty budget has been determined for the measurement system and is given in the following Table.

Measurement uncertainty evaluation for IEEE1528-2013 SAR test

| Source of uncertainty | Tolerance/uncertainty ± % | Probability distribution | Divisor | ci (1 g) | ci (10 g) | Standard uncertainty ± %, (1 g) | Standard uncertainty ± %, (10 g) |
|--|---------------------------|--------------------------|---------|----------|-----------|---------------------------------|----------------------------------|
| Measurement system | | | | | | | |
| Probe calibration | 6.55 | N | 1 | 1 | 1 | 6.6 | 6.6 |
| Axial Isotropy | 4.7 | R | √3 | 1 | 1 | 2.7 | 2.7 |
| Hemispherical Isotropy | 9.6 | R | √3 | 0 | 0 | 0.0 | 0.0 |
| Boundary effect | 1.0 | R | √3 | 1 | 1 | 0.6 | 0.6 |
| Linearity | 4.7 | R | √3 | 1 | 1 | 2.7 | 2.7 |
| Detection limits | 1.0 | R | √3 | 1 | 1 | 0.6 | 0.6 |
| Readout electronics | 0.3 | N | 1 | 1 | 1 | 0.3 | 0.3 |
| Response time | 0.0 | R | √3 | 1 | 1 | 0.0 | 0.0 |
| Integration time | 0.0 | R | √3 | 1 | 1 | 0.0 | 0.0 |
| RF ambient conditions – noise | 1.0 | R | √3 | 1 | 1 | 0.6 | 0.6 |
| RF ambient conditions–reflections | 1.0 | R | √3 | 1 | 1 | 0.6 | 0.6 |
| Probe positioner mech. Restrictions | 0.8 | R | √3 | 1 | 1 | 0.5 | 0.5 |
| Probe positioning with respect to phantom shell | 6.7 | R | √3 | 1 | 1 | 3.9 | 3.9 |
| Post-processing | 2.0 | R | √3 | 1 | 1 | 1.2 | 1.2 |
| Test sample related | | | | | | | |
| Test sample positioning | 2.8 | N | 1 | 1 | 1 | 2.8 | 2.8 |
| Device holder uncertainty | 6.3 | N | 1 | 1 | 1 | 6.3 | 6.3 |
| Drift of output power | 5.0 | R | √3 | 1 | 1 | 2.9 | 2.9 |
| Phantom and set-up | | | | | | | |
| Phantom uncertainty (shape and thickness tolerances) | 4.0 | R | √3 | 1 | 1 | 2.3 | 2.3 |
| Liquid conductivity target) | 5.0 | R | √3 | 0.64 | 0.43 | 1.8 | 1.2 |
| Liquid conductivity meas.) | 2.5 | N | 1 | 0.64 | 0.43 | 1.6 | 1.1 |
| Liquid permittivity target) | 5.0 | R | √3 | 0.6 | 0.49 | 1.7 | 1.4 |
| Liquid permittivity meas.) | 2.5 | N | 1 | 0.6 | 0.49 | 1.5 | 1.2 |
| Combined standard uncertainty | | RSS | | | | 12.2 | 12.0 |
| Expanded uncertainty 95 % confidence interval) | | | | | | 24.3 | 23.9 |

Measurement uncertainty evaluation for IEC62209-2 SAR test

| Source of uncertainty | Tolerance/uncertainty ± % | Probability distribution | Divisor | ci (1 g) | ci (10 g) | Standard uncertainty ± %, (1 g) | Standard uncertainty ± %, (10 g) |
|--|---------------------------|--------------------------|---------|----------|-----------|---------------------------------|----------------------------------|
| Measurement system | | | | | | | |
| Probe calibration | 6.55 | N | 1 | 1 | 1 | 6.6 | 6.6 |
| Axial Isotropy | 4.7 | R | √3 | 1 | 1 | 2.7 | 2.7 |
| Hemispherical Isotropy | 9.6 | R | √3 | 0 | 0 | 0.0 | 0.0 |
| Linearity | 4.7 | R | √3 | 1 | 1 | 2.7 | 2.7 |
| Modulation Response | 0.0 | R | √3 | 1 | 1 | 0.0 | 0.0 |
| Detection limits | 1.0 | R | √3 | 1 | 1 | 0.6 | 0.6 |
| Boundary effect | 1.0 | R | √3 | 1 | 1 | 0.6 | 0.6 |
| Readout electronics | 0.3 | N | 1 | 1 | 1 | 0.3 | 0.3 |
| Response time | 0.0 | R | √3 | 1 | 1 | 0.0 | 0.0 |
| Integration time | 0.0 | R | √3 | 1 | 1 | 0.0 | 0.0 |
| RF ambient conditions – noise | 1.0 | R | √3 | 1 | 1 | 0.6 | 0.6 |
| RF ambient conditions–reflections | 1.0 | R | √3 | 1 | 1 | 0.6 | 0.6 |
| Probe positioner mech. Restrictions | 0.8 | R | √3 | 1 | 1 | 0.5 | 0.5 |
| Probe positioning with respect to phantom shell | 6.7 | R | √3 | 1 | 1 | 3.9 | 3.9 |
| Post-processing | 2.0 | R | √3 | 1 | 1 | 1.2 | 1.2 |
| Test sample related | | | | | | | |
| Device holder Uncertainty | 6.3 | N | 1 | 1 | 1 | 6.3 | 6.3 |
| Test sample positioning | 2.8 | N | 1 | 1 | 1 | 2.8 | 2.8 |
| Power scaling | 4.5 | R | √3 | 1 | 1 | 2.6 | 2.6 |
| Drift of output power | 5.0 | R | √3 | 1 | 1 | 2.9 | 2.9 |
| Phantom and set-up | | | | | | | |
| Phantom uncertainty (shape and thickness tolerances) | 4.0 | R | √3 | 1 | 1 | 2.3 | 2.3 |
| Algorithm for correcting SAR for deviations in permittivity and conductivity | 1.9 | N | 1 | 1 | 0.84 | 1.1 | 0.9 |
| Liquid conductivity (meas.) | 2.5 | N | 1 | 0.64 | 0.43 | 1.6 | 1.1 |
| Liquid permittivity (meas.) | 2.5 | N | 1 | 0.6 | 0.49 | 1.5 | 1.2 |
| Temp. unc. - Conductivity | 1.7 | R | √3 | 0.78 | 0.71 | 0.8 | 0.7 |
| Temp. unc. - Permittivity | 0.3 | R | √3 | 0.23 | 0.26 | 0.0 | 0.0 |
| Combined standard uncertainty | | RSS | | | | 12.2 | 12.1 |
| Expanded uncertainty 95 % confidence interval) | | | | | | 24.5 | 24.2 |

APPENDIX B EUT TEST POSITION PHOTOS

Front(0mm)



Back(0mm)

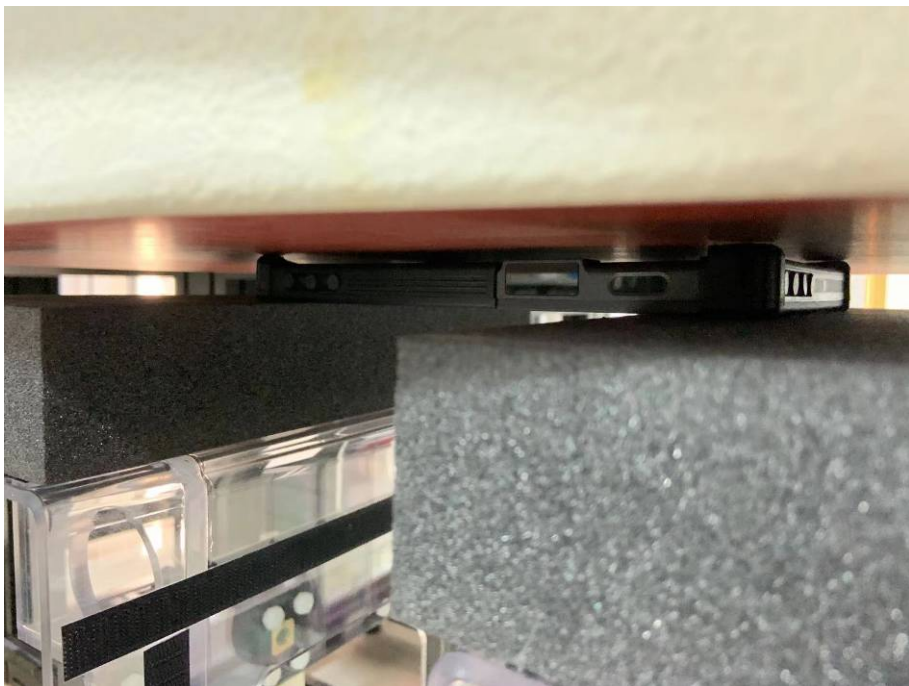

Left (0mm)



Right Side (0mm)



Top (0mm)

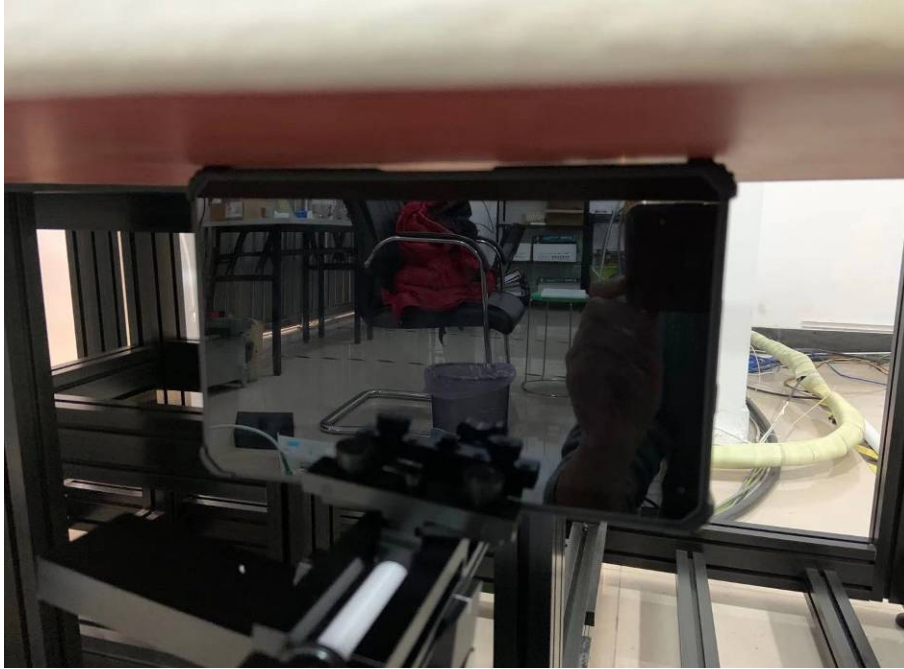

APPENDIX C CALIBRATION CERTIFICATES

Please Refer to the Attachment.

******* END OF REPORT *******