

Zamkol ZK706 Pro

—— Portable Wireless Speaker ——

Model: ZK706 Pro

User Manual | Guide Utilisateur | Manuale Utente
Benutzerhandbuch | Manual de Usuario

CONTENT

User Manual	01
Guide Utilisateur	11
Manuale Utente	20
Benutzerhandbuch	29
Manual de Usuario	38

Packing List

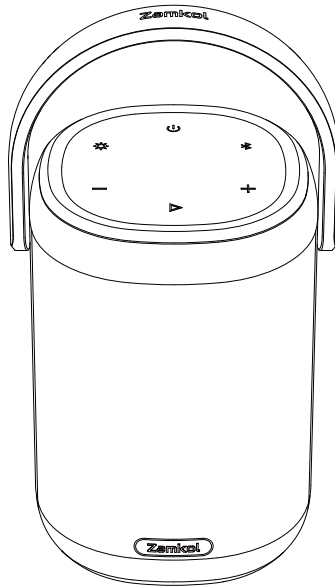

Zamkol ZK706 Pro

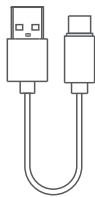

USB-C Charging Cable

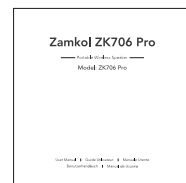

User Manual

Product Illustration

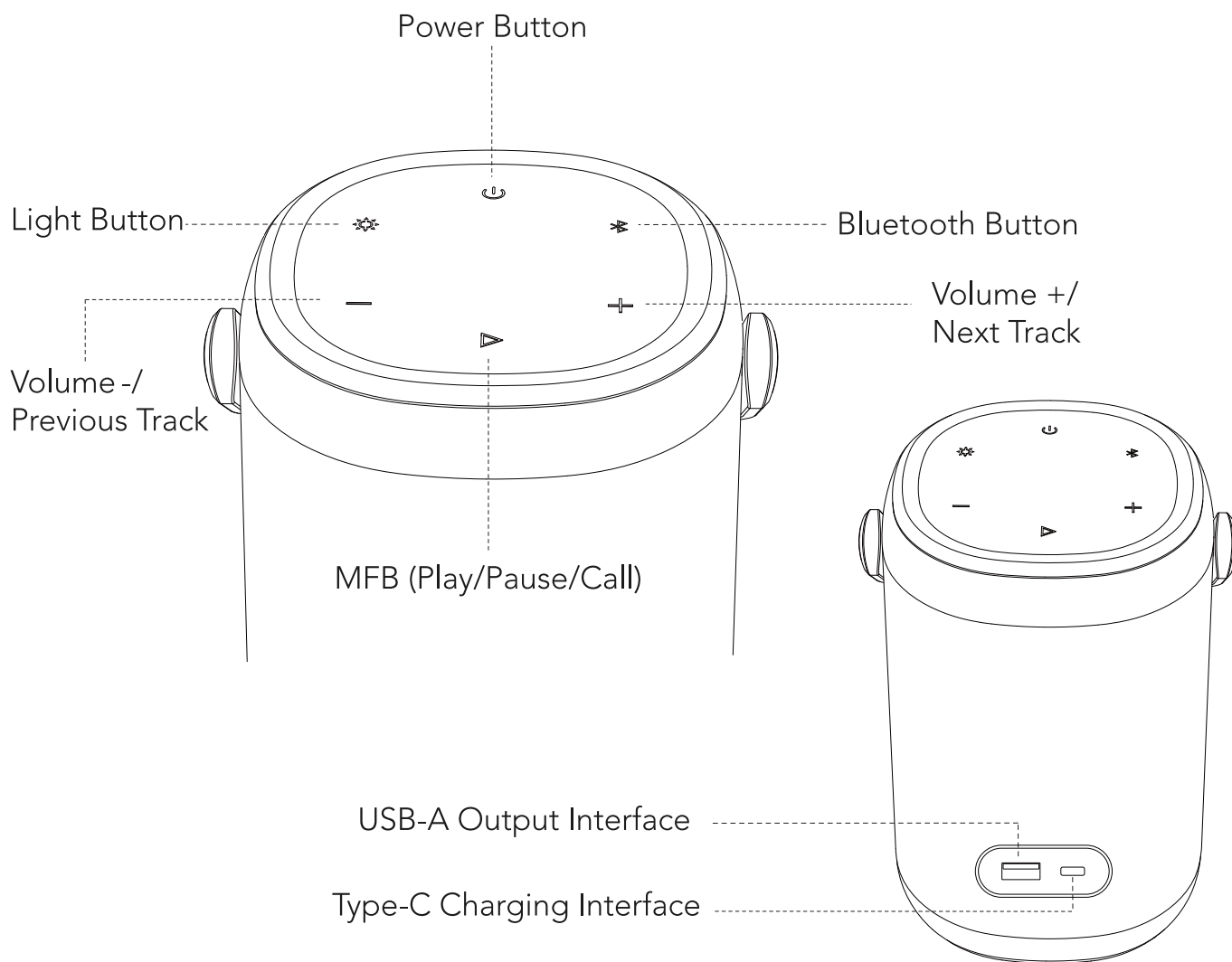

• Charging

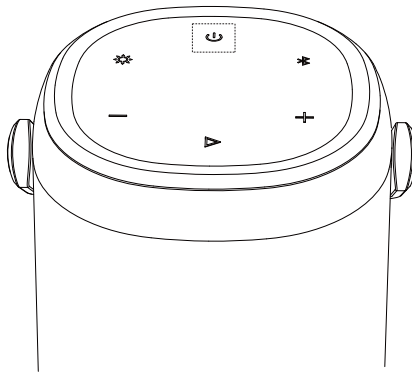

LED Indicator	Battery Status
Flashing Red	Low battery (< 20%)
Solid Red	Charging
Power indicator turns off	Fully charged

- Note:** 1. Please fully charge the built-in battery before the first use.
2. When the battery is less than 10% power remaining, the speaker will power off automatically.

Buttons Overview



• Power Button

	Press and hold it for 2s	Power on	White light on
		Power off	All LED indicators off



• Light Button

	Short press once	Switching light patterns
---	------------------	--------------------------

• Volume Button

	Short press	Volume up
	Press and hold it for 2s	Next track
	Short press	Volume down
	Press and hold it for 2s	Previous track

• Multifunctional Button (MFB)

 Music mode	Short press	Play/pause
	Press and hold it for 2s	Activate Siri
 Conversation mode	Short press	Answer phone call
	Press and hold it for 2s	Reject phone call
	Short press	End outgoing call

• Bluetooth Button

	Short press	Enters pairing mode
	Press and hold it for 3s	Host enters to True Wireless Stereo pairing mode

Pairing Mode

1. When powered on, the speaker automatically reconnects to the previously connected device.

2. Go to Bluetooth settings on your mobile device, then search and select "Zamkol ZK706 Pro" from devices list.

3. Once paired , the Bluetooth indicator will turn solid blue.

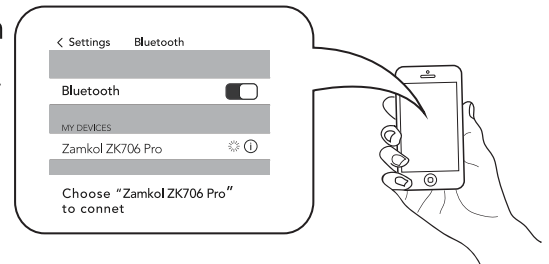

Note: 1. Make sure that the speaker is within 10 meters from your mobile device.

2. When powered on, the speaker will automatically reconnect to the last connected device.

• True Wireless Stereo Connection between Two ZK706 Pro

1. Press and hold the "  " button for 3s to enter into True Wireless Stereo pairing mode as the host.

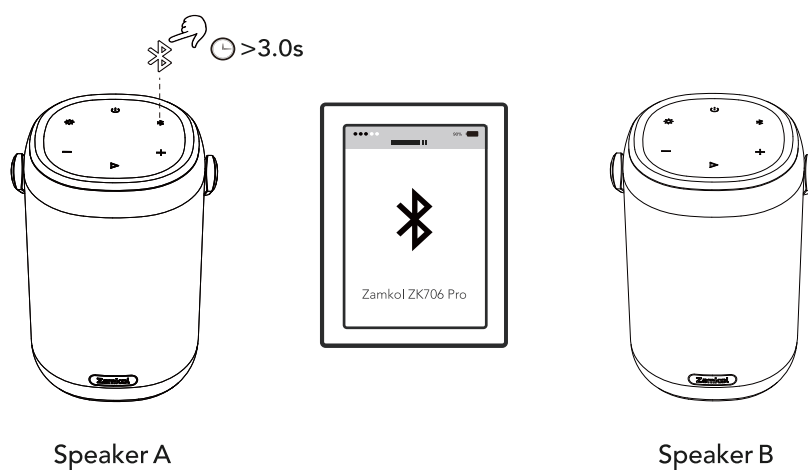

2. Enable the Bluetooth on your device and connect to "Zamkol ZK706 Pro", the stereo sound will play from both speakers.

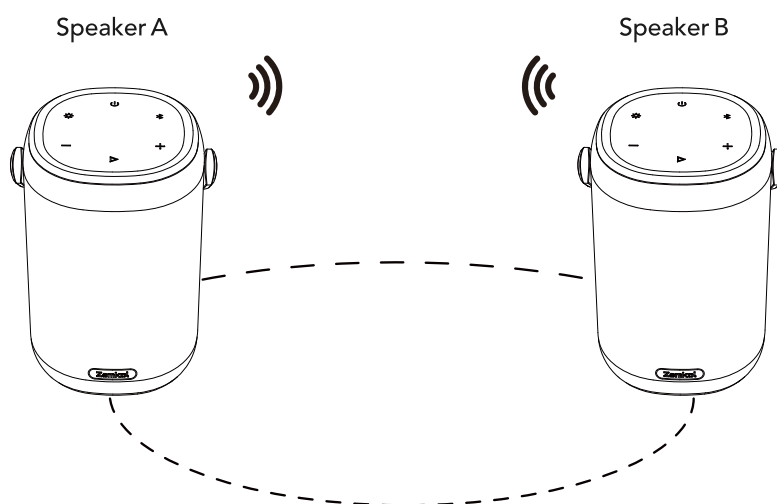

3. Once paired, the main speaker blue indicator light is always on.

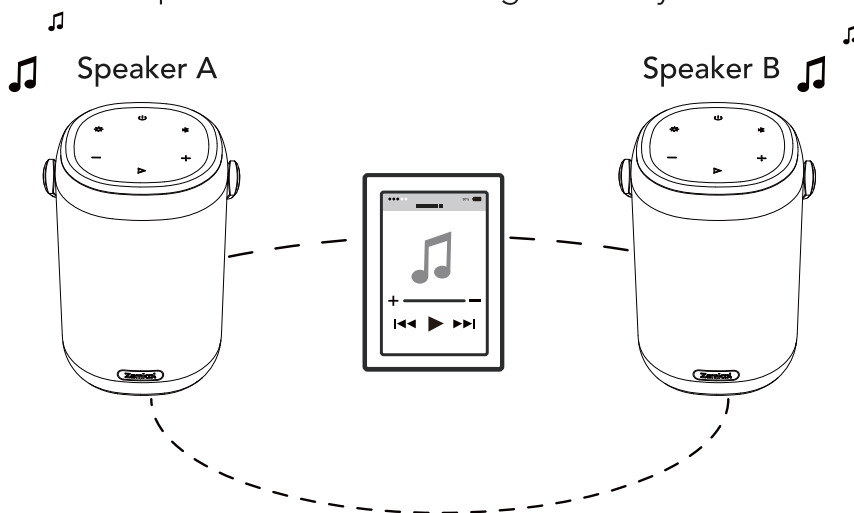

• Factory Reset and Reconnect

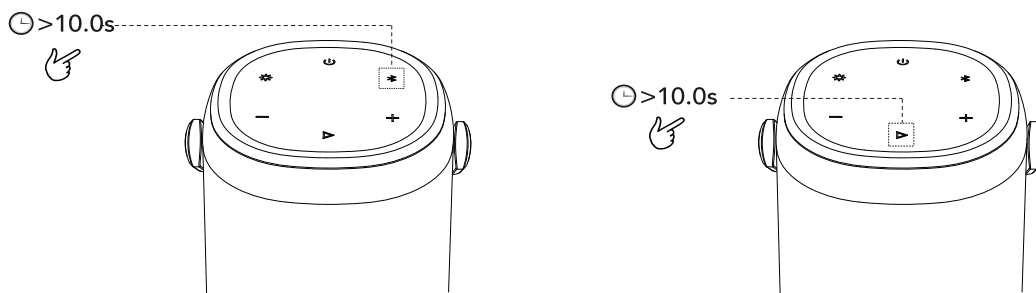

1. If this speaker becomes disconnected or has another connecting problem, you can press and hold "Bluetooth" buttons simultaneously for 10s at least to clear the pairing of speaker and remove the old pairing in your Bluetooth device, and then pair again.

2. If this speaker becomes out of control and can't be powered off, you can press and hold the play button for 10s at least to reboot.

Product Specifications

Model	ZK706 Pro
Bluetooth Version	5.0
Frequency Response	70Hz-20kHz
Battery Type	3.7V/8000 mAh
Charging Time	≤5 Hours@ 5V/2A
Waterproof	IPX7
Dimensions	110 x 110 x 168 mm
Frequency band	2402--2480 MHz
Maximum transmission power	-6~4dBm

• **FCC Statement**

Changes or modifications not expressly approved by the party responsible for compliance could void the user's authority to operate the equipment.

This equipment has been tested and found to comply with the limits for a Class B digital device, pursuant to Part 15 of the FCC Rules. These limits are designed to provide reasonable protection against harmful interference in a residential installation. This equipment generates uses and can radiate radio frequency energy and, if not installed and used in accordance with the instructions, may cause harmful interference to radio communications. However, there is no guarantee that interference will not occur in a particular installation. If this equipment does cause harmful interference to radio or television reception, which can be determined by turning the equipment off and on, the user is encouraged to try to correct the interference by one or more of the following measures:

- Reorient or relocate the receiving antenna.
- Increase the separation between the equipment and receiver.
- Connect the equipment into an outlet on a circuit different from that to which the receiver is connected.
- Consult the dealer or an experienced radio/TV technician for help

This device complies with part 15 of the FCC rules. Operation is subject to the following two conditions (1) this device may not cause harmful interference, and (2) this device must accept any interference received, including interference that may cause undesired operation.

Contenu du Colis

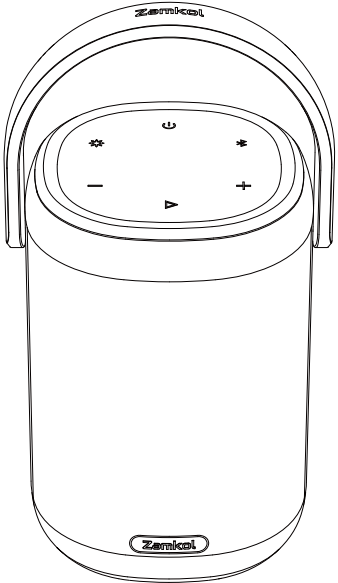

Zamkol ZK706 Pro

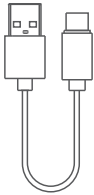

Câble de chargement USB-C



Manuel Utilisateur

Schéma du Produit

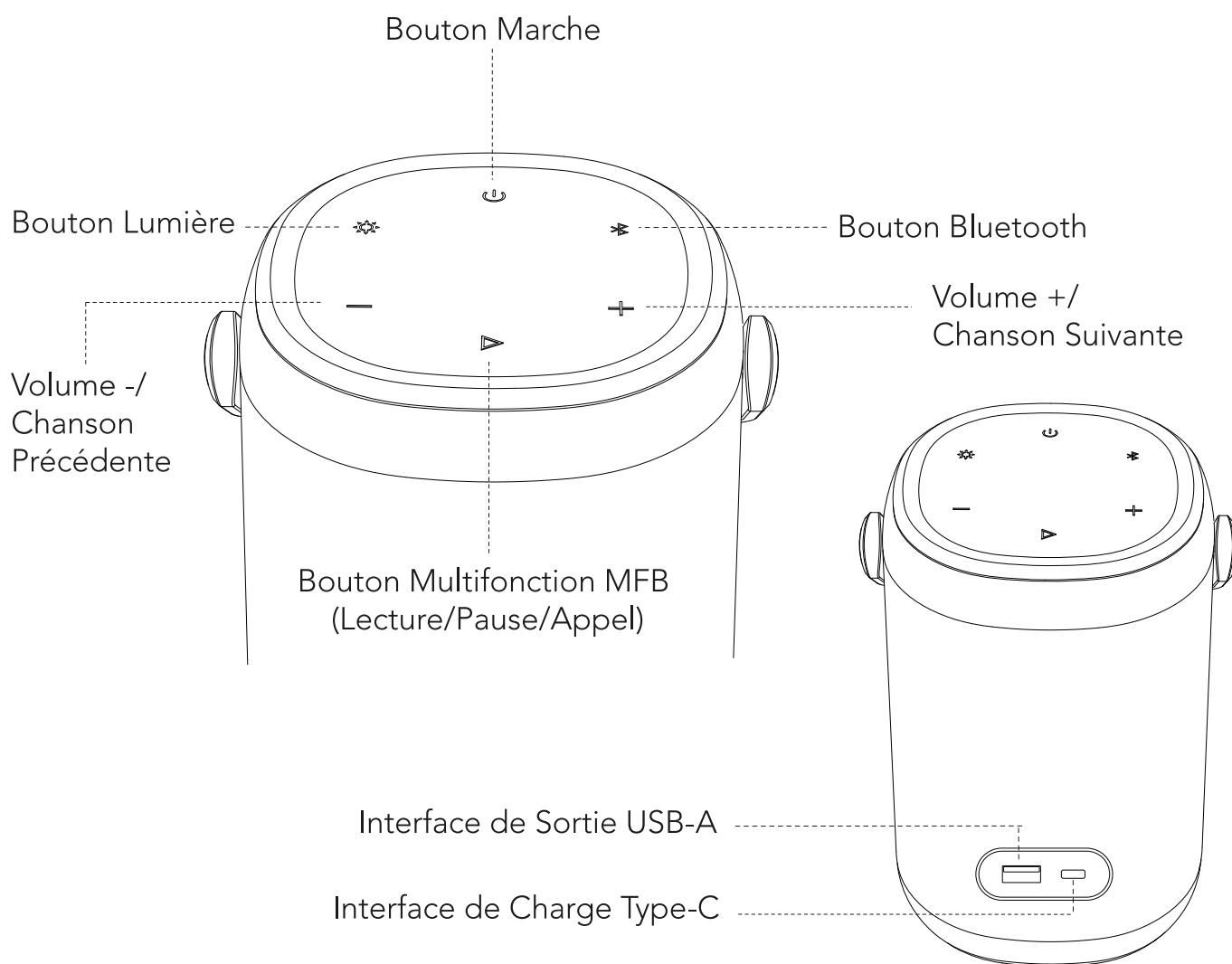

• Mise en Charge

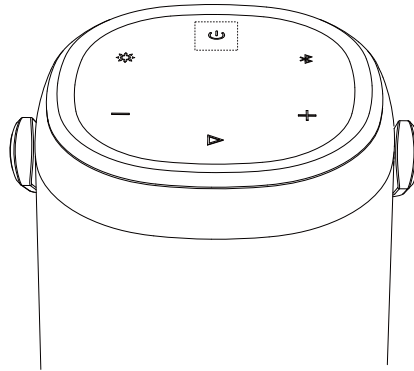

Voyants LED	Etat de la Batterie
Rouge Clignotant	Batterie Faible (<20%)
Rouge Fixe	En charge
Voyant Eteint	Pleinement Chargé

Note: 1. Veuillez pleinement charger la batterie intégrée avant la première utilisation.
2. Lorsque l' appareil descend sous les 10% de batterie restante, le haut-parleur s'éteint automatiquement.

Aperçu des Boutons



• Bouton Marche

	Maintenez-le appuyé 2 secondes	Allumage	Voyant Blanc Allumé
		Extinction	Tous les voyants éteints



• Bouton Lumière

	Appuyez Brièvement	Modifier le mode d'éclairage
---	--------------------	------------------------------

• Bouton Volume

	Appuyez Brièvement	Augmenter le Volume
	Maintenez-le appuyé 2 secondes	Chanson Suivante
	Appuyez Brièvement	Baisser le Volume
	Maintenez-le appuyé 2 secondes	Chanson précédente

• Bouton Multifonction (MFB)

 Mode Musique	Appuyez Brièvement	Lecture / Pause
	Maintenez-le appuyé 2 secondes	Activer Siri
 Mode Conversation	Appuyez Brièvement	Répondre à un Appel
	Maintenez-le appuyé 2 secondes	Refuser un Appel
	Appuyez Brièvement	Terminer l'Appel en cours

• Bouton Bluetooth

	Appuyez Brièvement	Entrer en Mode Synchronisation
	Maintenez-le appuyé 3 secondes	Entrer en Mode Synchronisation True Wireless Stereo en tant qu'hôte

Mode Synchronisation

1. Lorsque le haut-parleur est éteint, maintenez le bouton marche appuyé jusqu'à entendre l'invite vocale. Le voyant LED deviendra bleu clignotant.

2. Accédez aux paramètres Bluetooth sur votre smartphone, puis recherchez et sélectionnez "Zamkol ZK706 Pro" dans la liste des appareils.

3. Une fois synchronisé, le voyant Bluetooth sera en bleu fixe.

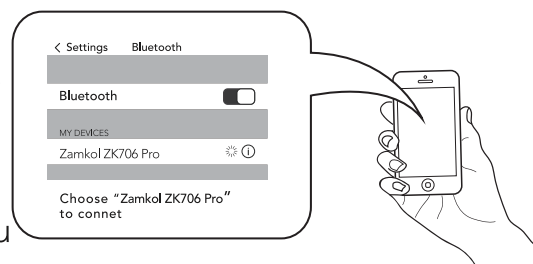

Note: 1. Assurez-vous que le haut-parleur se trouve à moins de 10 mètres de votre appareil mobile

2. Une fois allumé, le haut-parleur se reconnectera automatiquement au dernier appareil connecté.

• Connexion True Wireless Stereo entre deux appareils ZK706 Pro

1. Maintenez le bouton "  " enfoncé pendant 3 secondes pour entrer en mode Synchronisation True Wireless Stereo en tant qu'hôte.

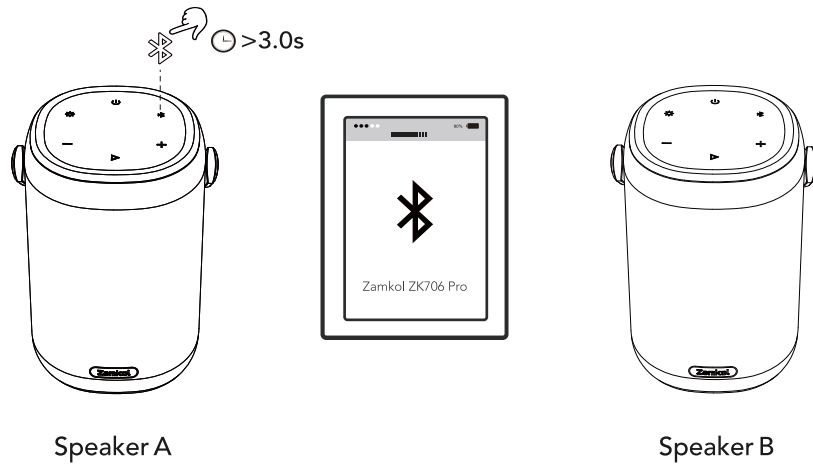

2. Activez le Bluetooth de votre appareil mobile et connectez-vous à " Zamkol ZK706 Pro " Le son sera diffusé par les deux haut-parleurs.

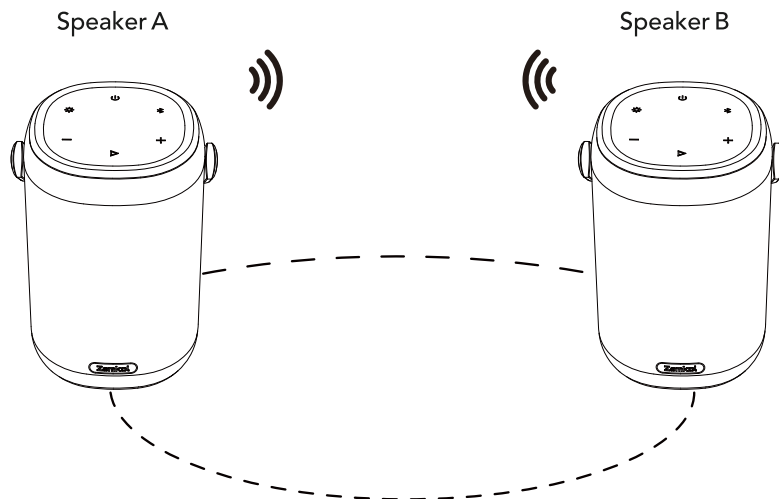

3. Une fois synchronisé, le voyant bleu du haut-parleur principal reste constamment allumé.

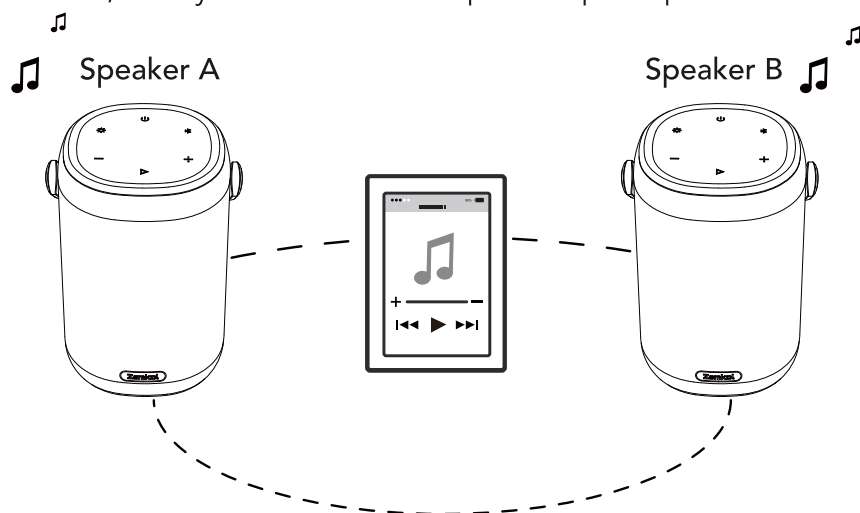

• Réinitialisation d'usine et Reconnexion

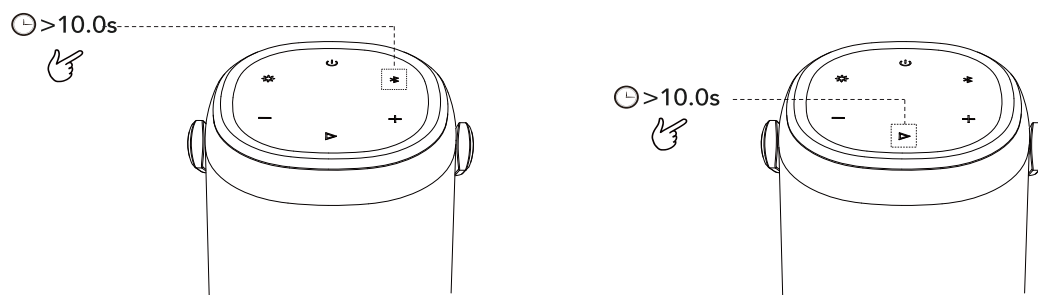

1. Si le haut-parleur se déconnecte ou rencontre un autre problème de connexion, vous pouvez maintenir appuyé simultanément les boutons "Bluetooth" pendant au moins 10 secondes pour effacer la synchronisation du haut-parleur et supprimer l'ancienne synchronisation de votre appareil Bluetooth, puis le re-synchroniser.

2. Si ce haut-parleur devient incontrôlable et ne peut pas être éteint, vous pouvez maintenir appuyé le bouton Marche pendant au moins 10 secondes pour redémarrer.

Caractéristiques du Produit

Modèle	ZK706 Pro
Version Bluetooth	5.0
Fréquence de réponse	70Hz-20kHz
Type de Batterie	3.7V/8000 mAh
Durée de mise en charge	≤5 Hours@ 5V/2A
Étanchéité	IPX7
Dimensions	110 x 110 x 168 mm
Bande de fréquence	2402--2480 MHz
Puissance d'émission maximale	-6~4dBm

Incluso nella confezione

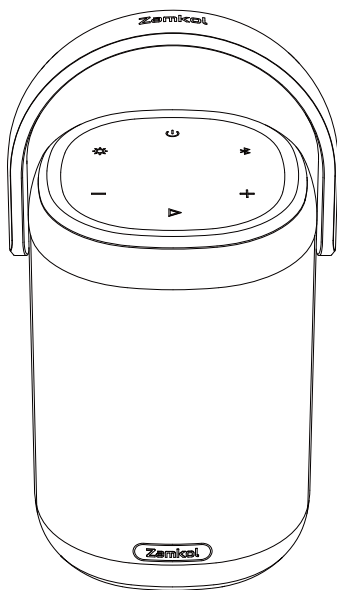

Zamkol ZK706 Pro

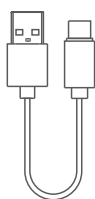

Cavo ricarica USB-C

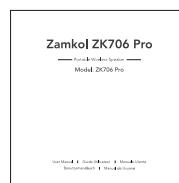

Manuale d'uso

Illustrazione del prodotto

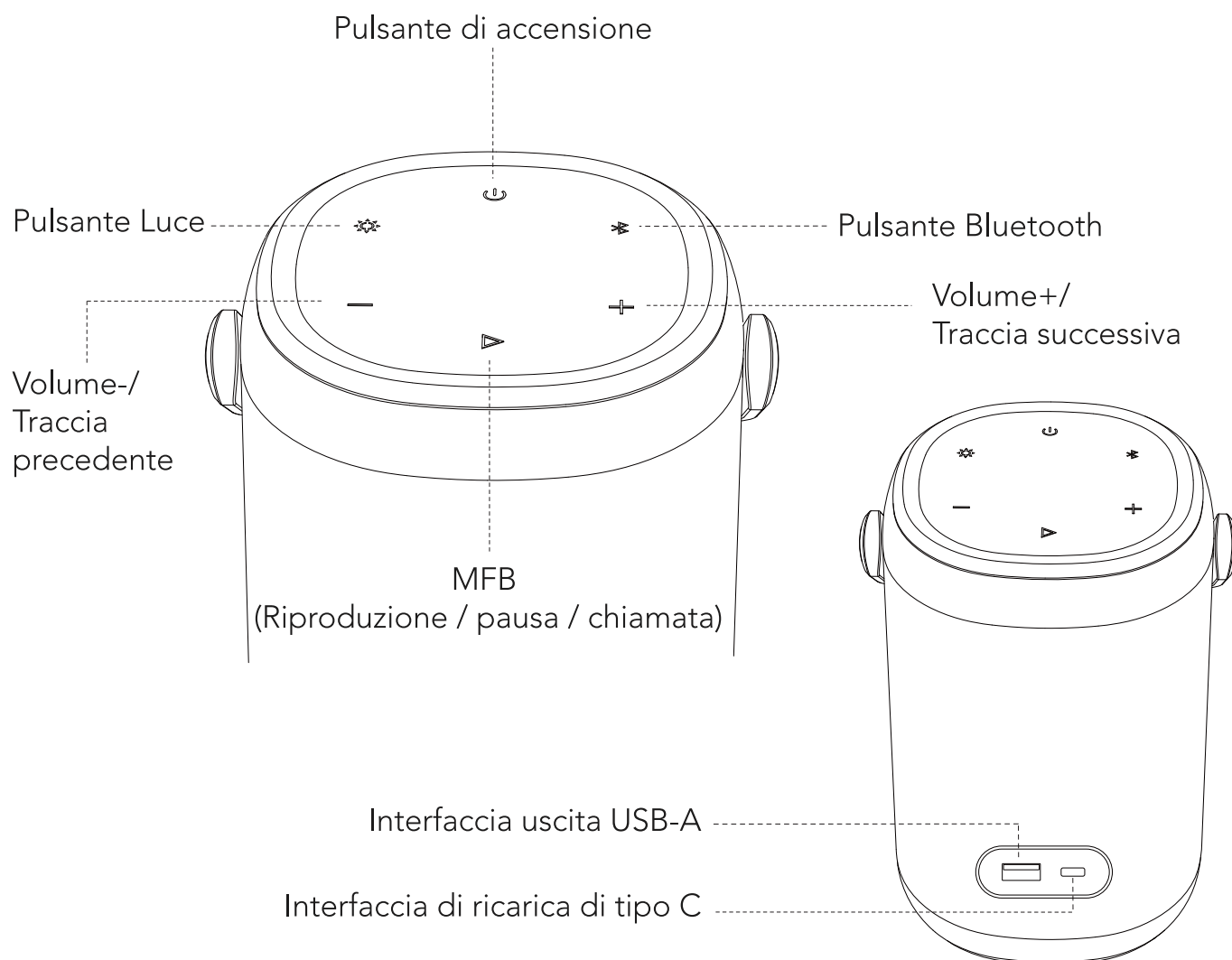

• Ricarica batteria

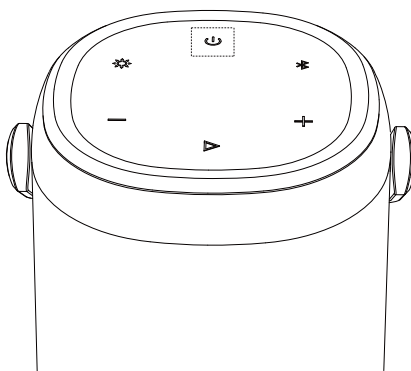

Indicatori LED	Stato della batteria
Rosso lampeggiante	Batteria scarica (<20%)
Rosso fisso	Caricamento
L'indicatore di alimentazione si spegne	Carica completata

- Notat:** 1. Si prega di ricaricare completamente la batteria integrata prima del primo utilizzo.
2. Quando lo stato della batteria è inferiore al 10% ,l'altoparlante si spegne automaticamente.

Panoramica dei pulsanti



• Pulsante di accensione

	Tenere premuto per 2 secondi	Accensione	Indicatore bianco acceso
		Spegnimento	Tutti gli indicatori LED spenti



• Pulsante Luce

	Premere brevemente una volta	Commutazione dei modelli di luce
---	------------------------------	----------------------------------

• Pulsante del volume

	Breve pressione	Aumento del volume
	Tenere premuto per 2 secondi	Traccia successiva
	Breve pressione	Volume giù
	Tenere premuto per 2 secondi	Traccia precedente

• Pulsante multifunzione (MFB)

 Modalità musica	Breve pressione	Riproduce / Mettere in pausa
	Tenere premuto per 2 secondi	Attiva Siri
 Modalità conversazione	Breve pressione	Rispondere alla chiamata
	Tenere premuto per 2 secondi	Rifiuta chiamata
	Breve pressione	Terminare la chiamata in uscita

• Pulsante Bluetooth

	Breve pressione	Accesso alla modalità di associazione
	Tenere premuto per 3 secondi	Entra in modalità True Wireless Stereo di associazione come host

Modalità di associazione

1. Quando l'altoparlante è spento, tenere premuto il pulsante di accensione fino a quando non si sente un tono crescente. L'indicatore LED diventerà blu lampeggiante.

2. Vai alle impostazioni Bluetooth del tuo dispositivo mobile, cercare e selezionare "Zamkol ZK706 Pro" dall'elenco dei dispositivi.

3. Una volta associato, l'indicatore Bluetooth diventerà blu fisso.

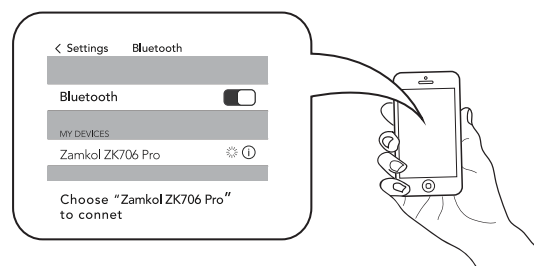

Nota: 1. Assicurarsi che l'altoparlante si trova a 10 metri dal tuo dispositivo mobile.
2. Quando è acceso, l'altoparlante si riconnette automaticamente all'ultimo dispositivo collegato.

• Connessione stereo true wireless tra due ZK706 Pro

1. Tenere premuto il pulsante "  " per 3s per entrare in modalità di associazione True Wireless Stereo come host.

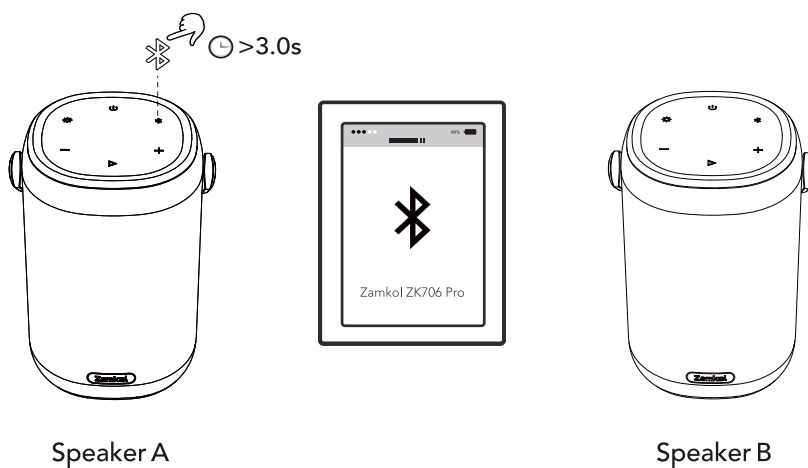

2. Abilitare il Bluetooth del tuo dispositivo mobile e connetterlo a "Zamkol ZK706Pro".
L'audio verrà riprodotto da entrambi gli altoparlanti.

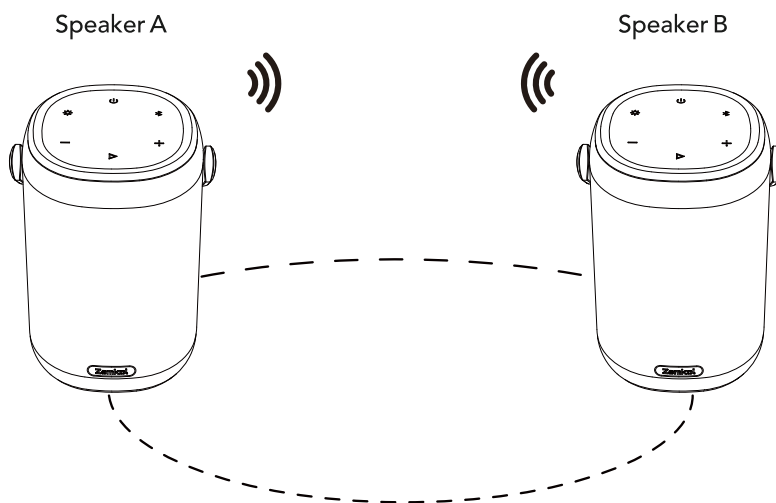

3. Una volta associato, la spia blu dell'altoparlante principale rimane sempre accesa.

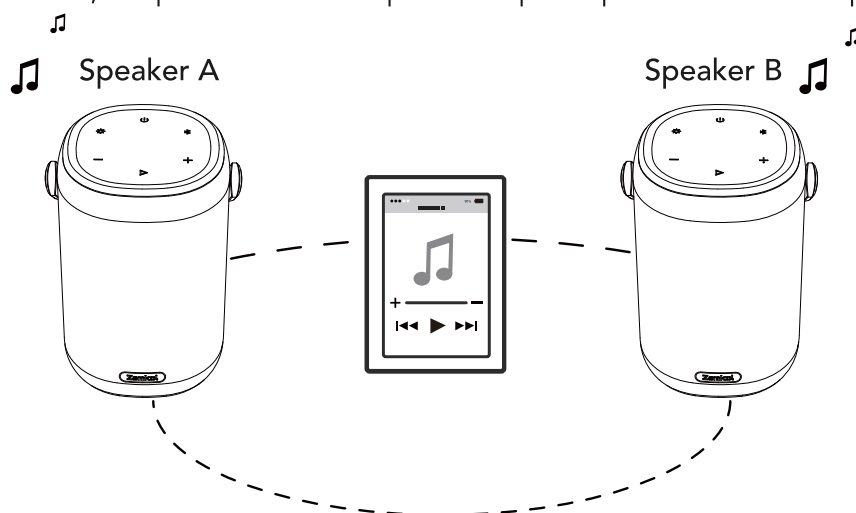

• Ripristino delle impostazioni di fabbrica e riconnessione

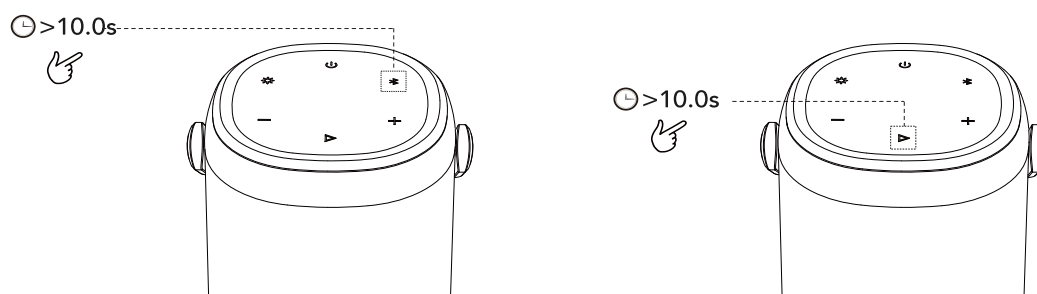

1. Se l'altoparlante si disconnette o ha un altro problema di connessione, è possibile premere e tenere premuti contemporaneamente i pulsanti "Bluetooth" per almeno 10s per cancellare e rimuovere l'associazione principale dal dispositivo Bluetooth, dopo eseguire nuovamente l'associazione.

2. Se l'altoparlante si blocca e non può essere spento, è possibile tenere premuto il pulsante di riproduzione per almeno 10 secondi per riavviarlo.

Specifiche del prodotto

Modello	ZK706 Pro
Versione Bluetooth	5.0
Risposta in frequenza	70Hz-20kHz
Tipo di batteria	3.7V/8000 mAh
Tempo di ricarica	≤5 ore @ 5V/2A
Impermeabile	IPX7
Dimensioni	110 x 110 x 168 millimetri
Banda di frequenza	2402--2480 MHz
Potenza di trasmissione massima	-6~4dBm

Verpackungsliste

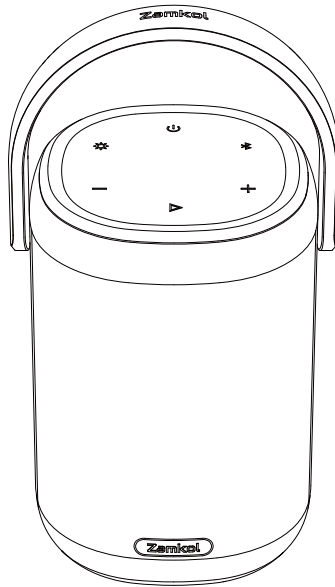

Zamkol ZK706 Pro

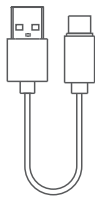

USB-C Ladekabel

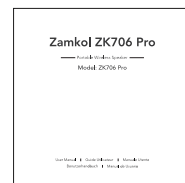

Benutzerhandbuch

Produktabbildung

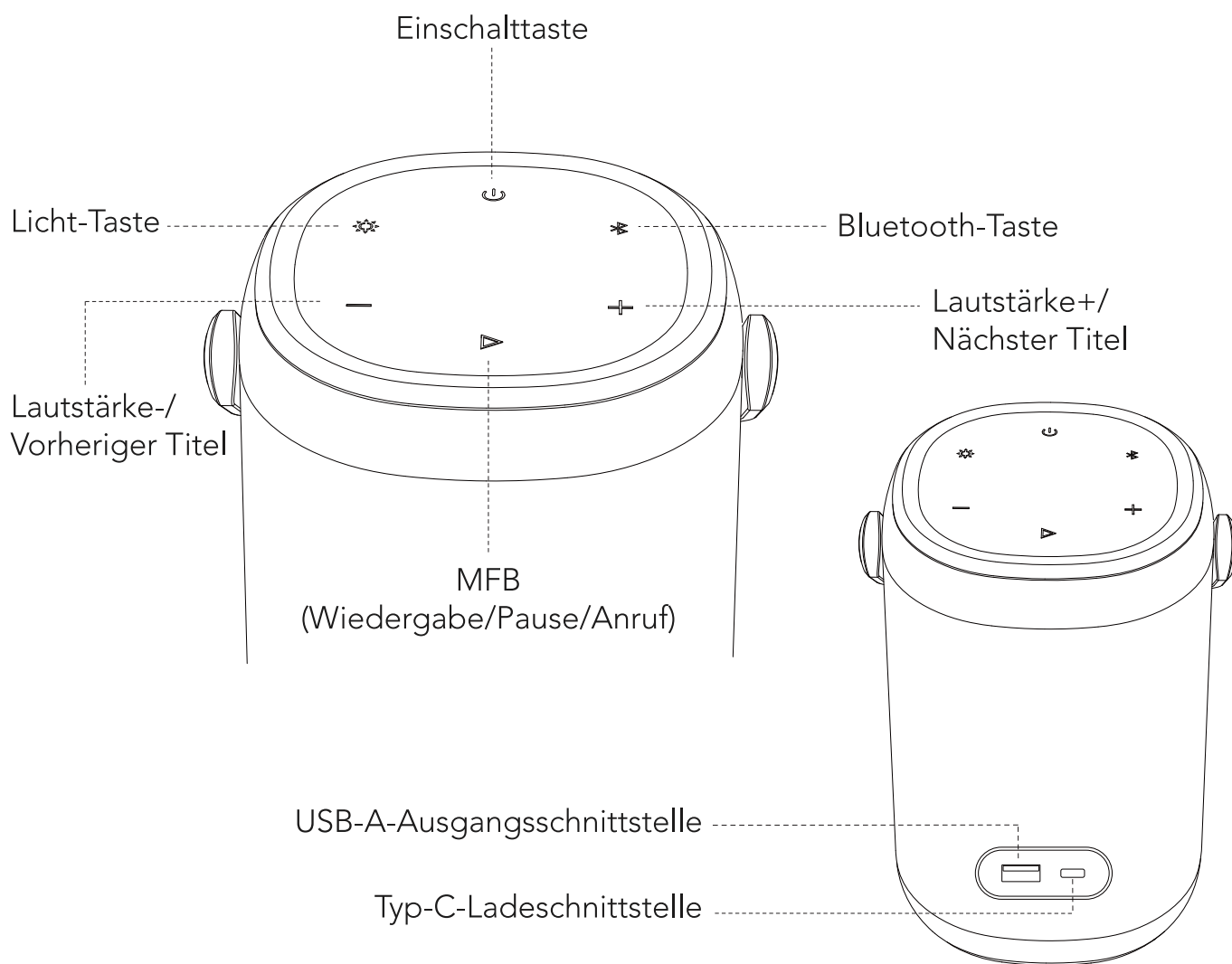

• Aufladen

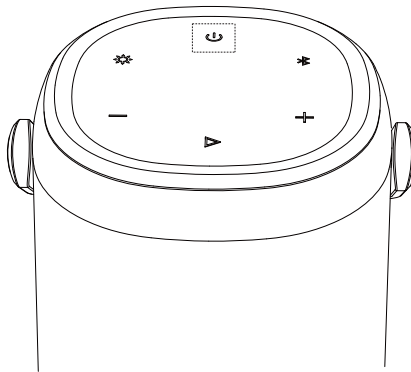

LED Anzeigen	Batteriestatus
Blinkt rot	Batteriestand niedrig (<20%)
Bleibt bei rot	Lädt auf
Betriebsanzeige schaltet sich aus	Voll aufgeladen

- Hinweis:** 1. Bitte laden Sie den eingebauten Akku vor dem ersten Gebrauch vollständig auf.
2. Wenn der Akku weniger als 10 % Restkapazität hat, schaltet sich der Lautsprecher automatisch aus.

Schaltflächenübersicht



• Einschalttaste

	Drücken und halten Sie die Taste 2 Sekunden lang	Einschalten	Weißer Anzeiger leuchtet
		Ausschalten	Alle LED-Anzeigen aus



• Lichttaste

	Einmal kurz drücken	Umschalten der Lichtmuster
---	---------------------	----------------------------

• Lautstärketaste

	Kurz drücken	Lautstärke erhöhen
	Drücken und halten Sie die Taste 2 Sekunden lang	Nächster Titel
	Kurz drücken	Lautstärke runter
	Drücken und halten Sie die Taste 2 Sekunden lang	Vorheriger Titel

• Multifunktions-taste (MFB)

 Musik-Modus	Kurz drücken	Wiedergabe/Pause
	Drücken und halten Sie die Taste 2 Sekunden lang	Siri aktivieren
 Konversationsmodus	Breve pressione	Telefonanruf entgegennehmen
	Drücken und halten Sie die Taste 2 Sekunden lang	Telefonanruf ablehnen
	Kurz drücken	Ausgehendes Gespräch beenden

• Bluetoothtaste

	Kurz drücken	Aufrufen des Kopplungsmodus
	Drücken und halten Sie die Taste 3 Sekunden lang	Aufrufen des True Wireless Stereo Pairing-Modus als Host

Kopplungsmodus

1. Wenn der Lautsprecher ausgeschaltet ist, halten Sie die Einschalttaste gedrückt, bis ein ansteigender Ton zu hören ist. Die LED-Anzeige blinkt nun blau.

2. Gehen Sie zu den Bluetooth-Einstellungen auf Ihrem Mobilgerät, suchen Sie dann nach "Zamkol ZK706 Pro" und wählen Sie es aus der Geräteliste aus.

3. Nach der Kopplung leuchtet die Bluetooth-Anzeige dauerhaft blau.

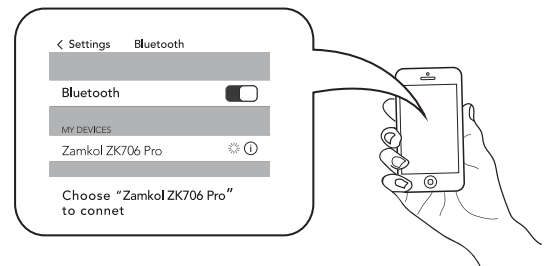

- Hinweis:**
1. Stellen Sie sicher, dass der Lautsprecher nicht weiter als 10 Meter von Ihrem Mobilgerät entfernt ist
 2. Nach dem Einschalten stellt der Lautsprecher automatisch die Verbindung zum zuletzt verbundenen Gerät wieder her.

• Echte drahtlose Stereo-Verbindung zwischen zwei ZK706 Pro

1. Halten Sie die "⌘" -Taste 3 Sekunden lang gedrückt, um als Host in den True Wireless Stereo Pairing-Modus zu wechseln.

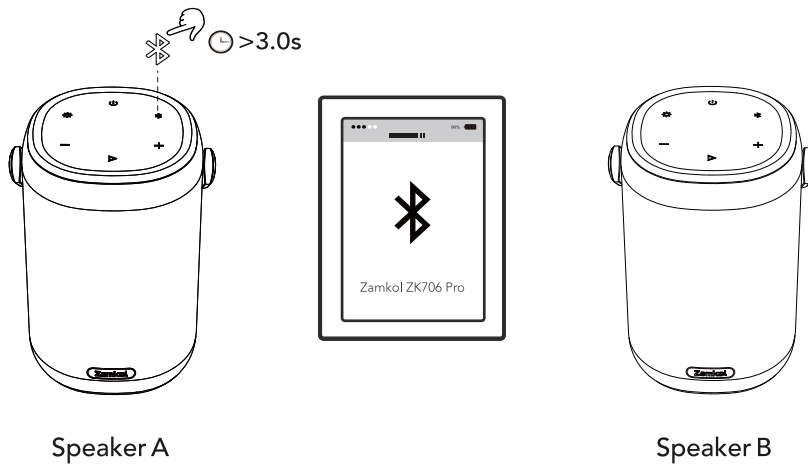

2. Aktivieren Sie Bluetooth auf Ihrem Mobilgerät und verbinden Sie es mit dem "Zamkol ZK706 Pro". Der Ton wird von beiden Lautsprechern wiedergegeben.

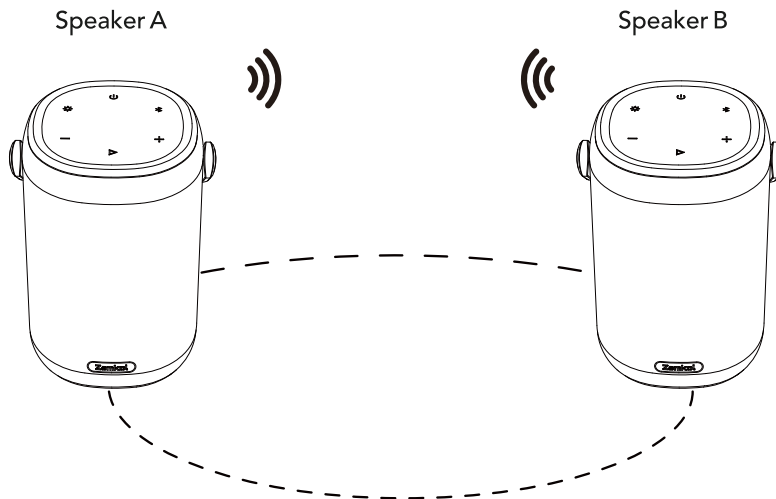

3. Einmal gepaart, der Hauptlautsprecher blaue Kontrollleuchte ist immer an.

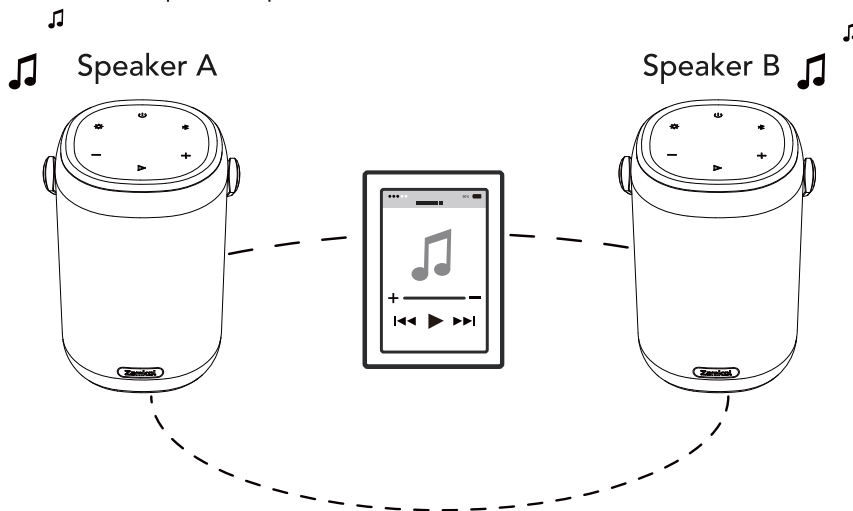

• Zurücksetzen auf die Werkseinstellungen und Wiederherstellen der Verbindung

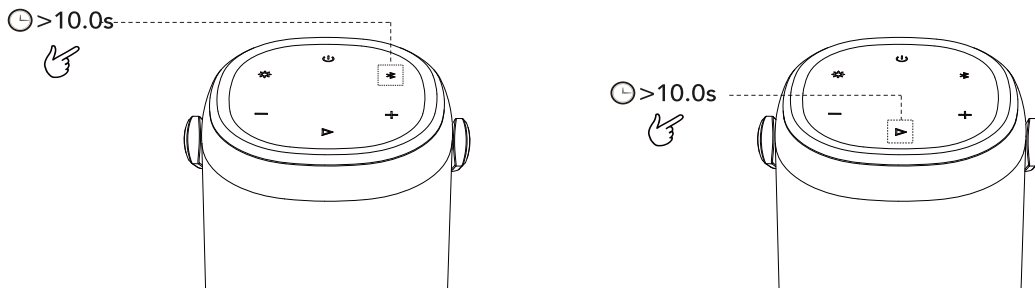

1. Wenn die Verbindung zu diesem Lautsprecher unterbrochen wird oder ein anderes Verbindungsproblem auftritt, können Sie die "Bluetooth"-Tasten mindestens 10 Sekunden lang gleichzeitig gedrückt halten, um das Pairing des Lautsprechers zu löschen und das alte Pairing in Ihrem Bluetooth-Gerät zu entfernen und dann erneut zu koppeln.

2. Wenn der Lautsprecher außer Kontrolle gerät und sich nicht mehr ausschalten lässt, können Sie die Wiedergabetaste mindestens 10 Sekunden lang gedrückt halten, um einen Neustart durchzuführen.

Produktspezifikationen

Modell	ZK706 Pro
Bluetooth-Version	5.0
Frequenzgang	70Hz-20kHz
Batterie-Typ	3.7V/8000 mAh
Aufladezeit	≤5 Std. @ 5V/2A
Wasserdicht	IPX7
Maße	110 x 110 x 168 mm
Frequenzbereich	2402--2480 MHz
Maximale Sendeleistung	-6~4dBm

Lista de empaque

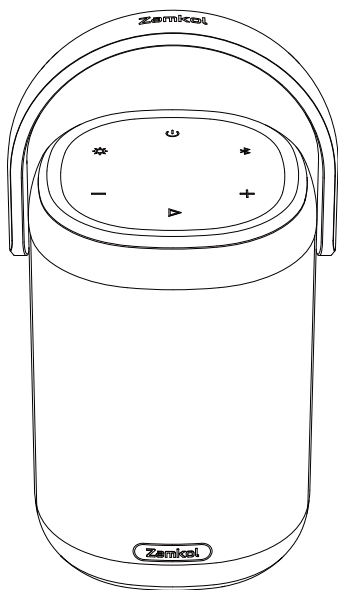

Zamkol ZK706 Pro

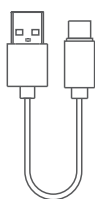

Cable de carga USB-C

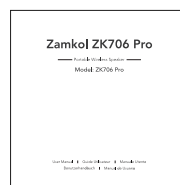

Manual de Usuario

Ilustración del producto

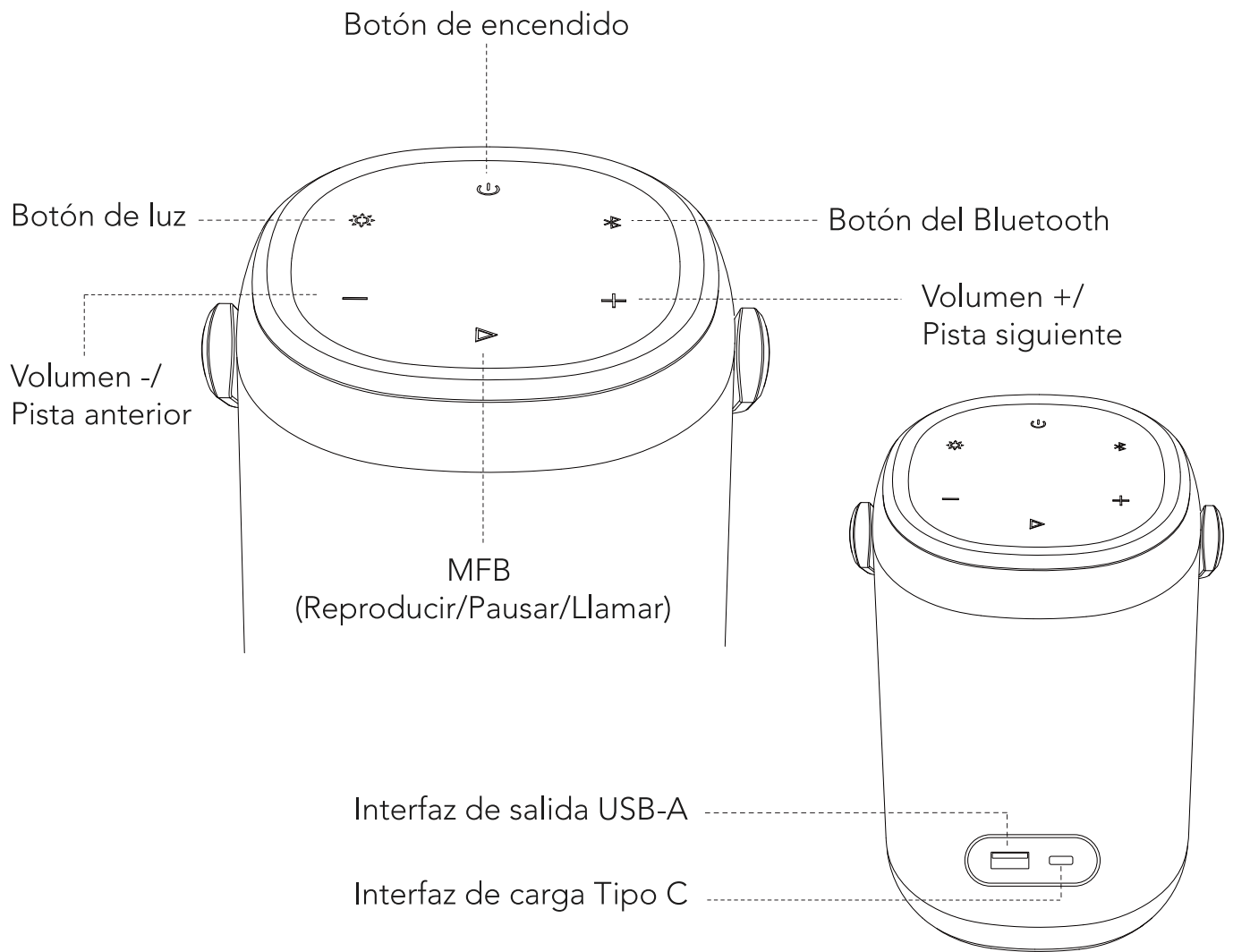

• Carga

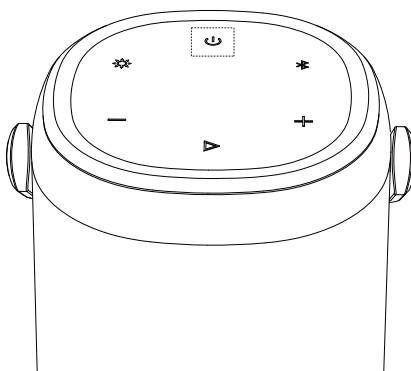

Indicador LED	Estado de la batería
Parpadeando en rojo	Batería baja (<20%)
Rojo fijo	Cargando
Luz indicadora apagada	Carga completada

- Nota:** 1. Por favor cargue completamente la batería antes de usarlo por primera vez.
2. Cuando la batería es menor al 10%, el altavoz se apagará automáticamente.

Función de los botones



• Botón de encendido

	Presione durante 2 segundos	Encender	La luz indicadora blanca se enciende
		Apagar	Todas las luces indicadoras se apagan



• Botón de luz

	Presione brevemente una vez	Cambio de patrones de luz
---	-----------------------------	---------------------------

• Botón de Volumen

	Presione brevemente	Subir volumen
	Presione durante 2 segundos	Pista siguiente
	Presione brevemente	Bajar volumen
	Presione durante 2 segundos	Pista anterior

• Botón Multifuncional (MFB)

 Modo música	Presione brevemente	Reproducir / Pausar
	Presione durante 2 segundos	Activar a Siri
 Modo conversación	Presione brevemente	Contestar llamada telefónica
	Presione durante 2 segundos	Rechazar una llamada
	Presione brevemente	Finalizar llamada saliente

• Botón Bluetooth

	Presione brevemente	Entrar al modo de emparejamiento
	Presione durante 3 segundos	Entrar al modo de emparejamiento estéreo inalámbrico como anfitrión

Modo de emparejamiento

1. Cuando el altavoz se apague, mantenga presionado el botón de encendido hasta que escuche el tono ascendente, entonces el indicador LED se volverá azul intermitente.

2. Vaya a la configuración del Bluetooth de su móvil, luego busque y seleccione "Zamkol ZK706 Pro" de la lista de dispositivos.

3. Una vez emparejado, el indicador del Bluetooth se volverá en azul sólido.

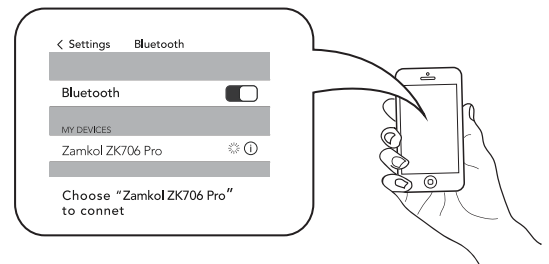

- Nota:** 1. Asegúrese de que el altavoz se encuentre a una distancia menor a 10 metros de su dispositivo móvil
2. Una vez encendido, el altavoz se reconectará automáticamente al dispositivo anterior conectado.

• Conexión estéreo Inalámbrica entre dos altavoces ZK706 Pro

1. Presione el botón "  " durante 3 segundos para entrar al modo de emparejamiento inalámbrico.

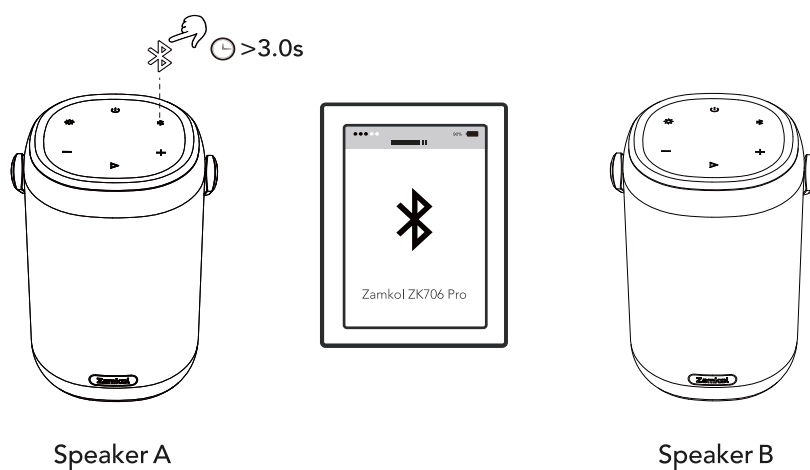

2. Active el Bluetooth en su dispositivo móvil y conéctese a "Zamkol ZK706 Pro". El audio será reproducido en ambos altavoces.

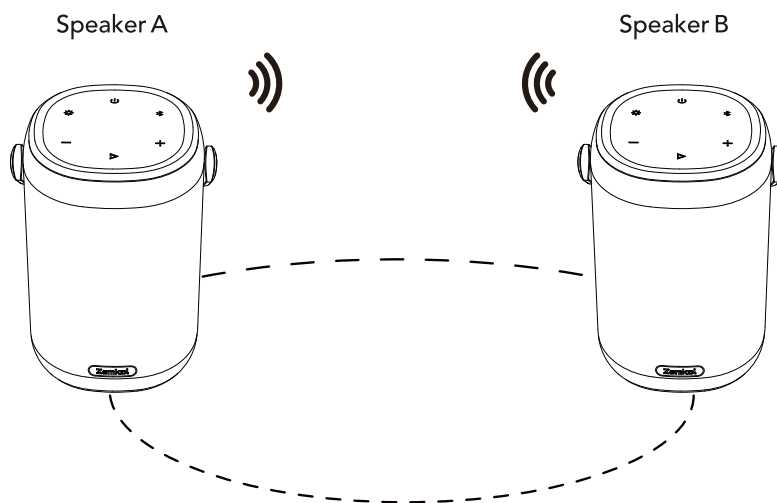

3. Una vez emparejado, la luz indicadora azul del altavoz principal permanecerá siempre encendida.

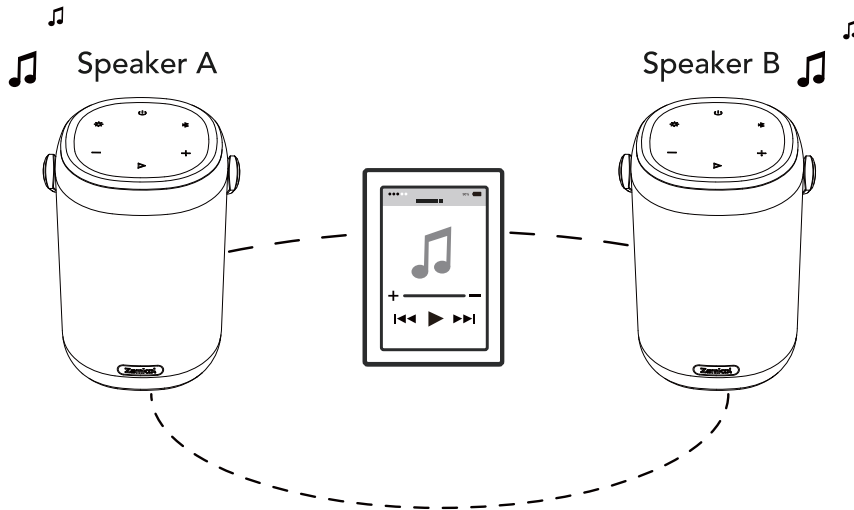

• Restauración de fábrica y Reconexión

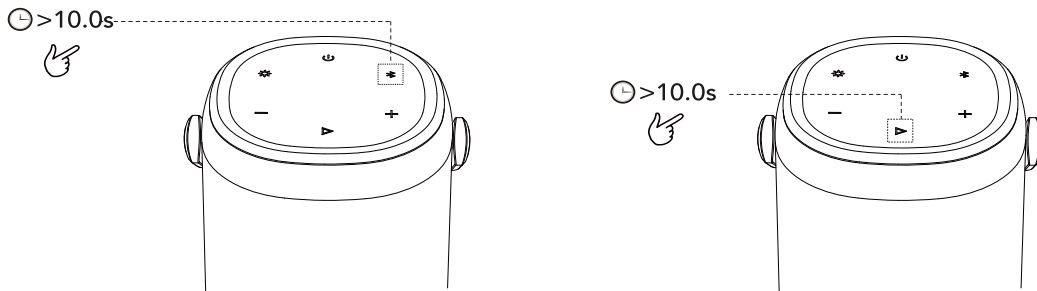

1. Si el altavoz llega a desconectarse o tiene algún otro problema de conexión, presione el botón "Bluetooth" simultáneamente durante 10 segundos como mínimo para limpiar el emparejamiento del altavoz y borrar el registro anterior en su dispositivo, entonces vuelva a emparejar.

2. Si el altavoz pierde el control y no se puede apagar, presione el botón "reproducir" al menos durante 10 segundos para reiniciar.

Especificaciones

Modelo	ZK706 Pro
Versión del Bluetooth	5.0
Frecuencia de respuesta	70Hz-20kHz
Tipo de batería	3.7V/8000 mAh
Tiempo de carga	≤5 Hours @ 5V/2A
Impermeabilidad	IPX7
Dimensiones	110 x 110 x 168 mm
Banda de frecuencia	2402--2480 MHz
Potencia máxima de transmisión	-6~4dBm

DOC:

Hereby, [SHELLBOT TECHNOLOGY FR] declares that the radio equipment type [Portable Wireless Speaker ZK706 Pro] is in compliance with Directive 2014/53/EU.

The full text of the EU declaration conformity is available at the following internet address:

<https://www.zamkol.com/upload/doc/ZK706PRO-DOC-EN.pdf>

Learn more about the UK Declaration of Conformity, Please click below link to download:

<https://www.zamkol.com/upload/doc/ZK706PRO-DOC-UK.pdf>

Hiermit erklärt [SHELLBOT TECHNOLOGY FR], dass der Funkanlagentyp [Portable Wireless Speaker ZK706 Pro] der Richtlinie 2014/53/EU entspricht.

Der vollständige Text der EU-Konformitätserklärung ist unter der folgenden Internetadresse verfügbar: <https://www.zamkol.com/upload/doc/ZK706PRO-DOC-DE.pdf>