

Zamkol

WIRELESS STEREO SPEAKER

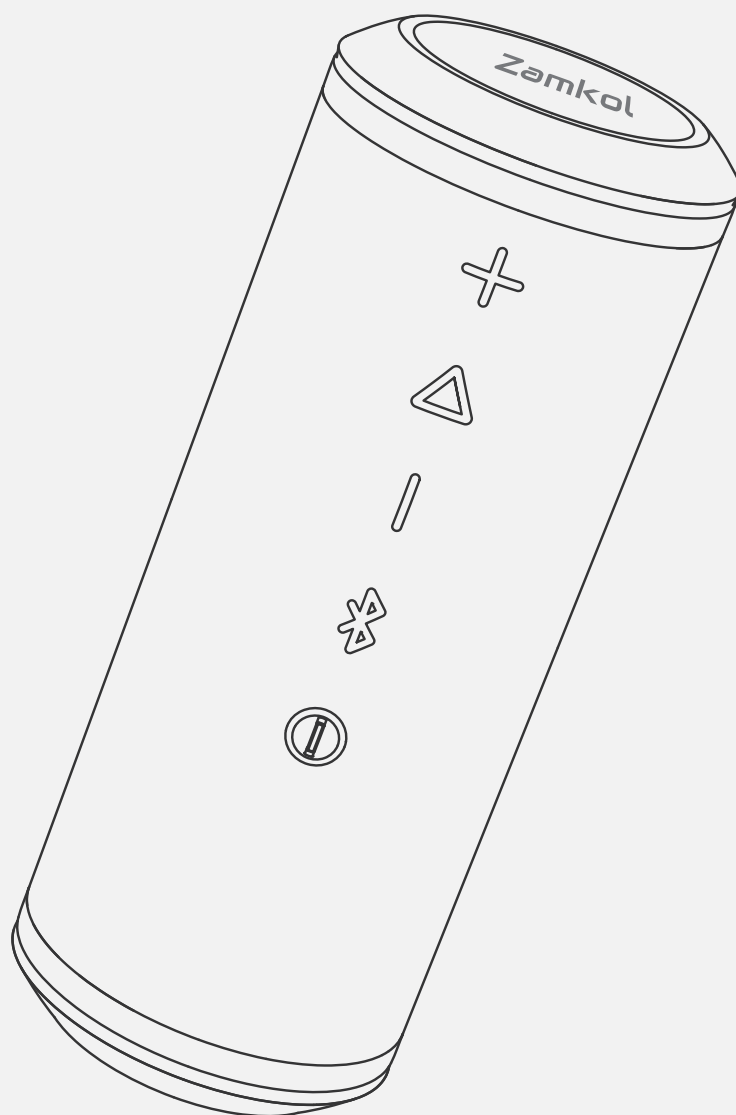

MODEL: ZK606Pro

USER MANUAL

English 01-09

Français 10-17

Italiano 18-25

Deutsch 26-33

日本語 34-41

Española 42-49

- Packaging List

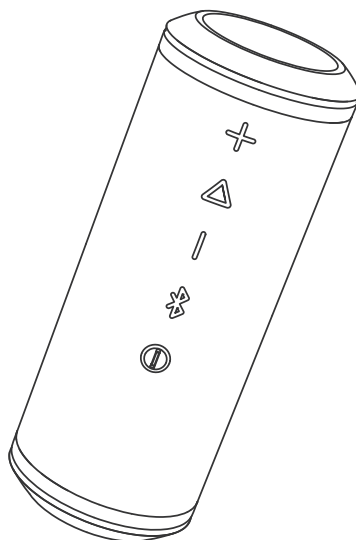

Zamkol ZK606 Pro

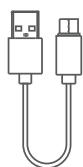

USB-C
charging cable

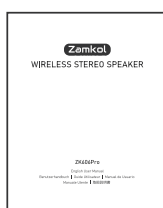

User
Manual

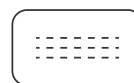

Warranty
Card

• Product overview

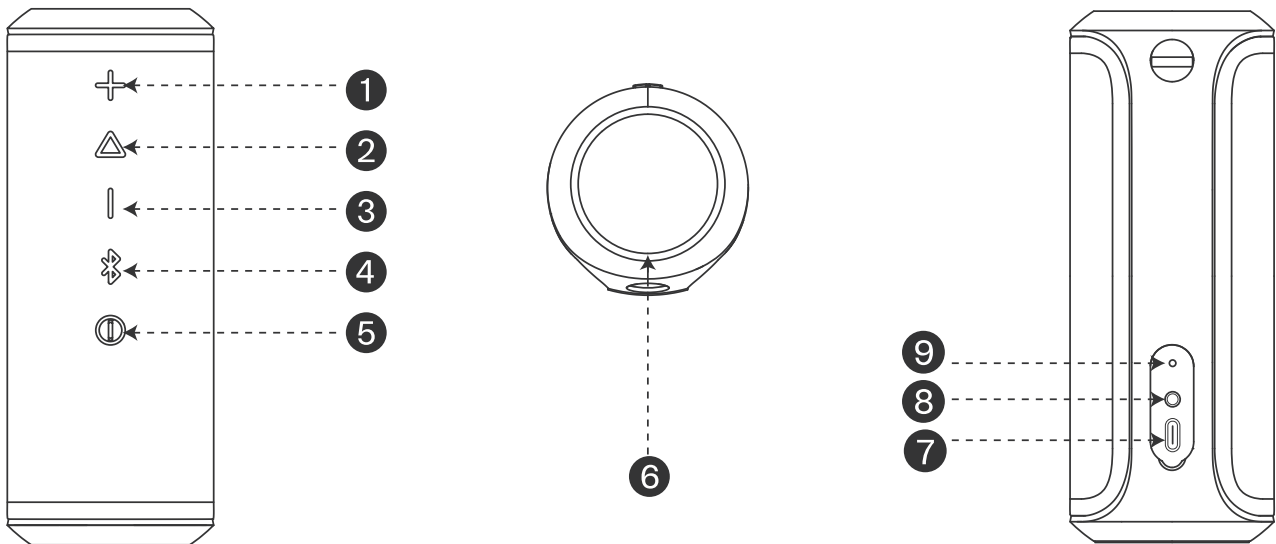

- ① Volume +/Next Track
- ② 2.MFB (Play/Pause/Call)
- ③ Volume -/Previous Track
- ④ Bluetooth button
- ⑤ Power button

- ⑥ Mode light + Charging light
- ⑦ Type-C charging connector
- ⑧ AUX IN Jack
- ⑨ Reset

- Charging

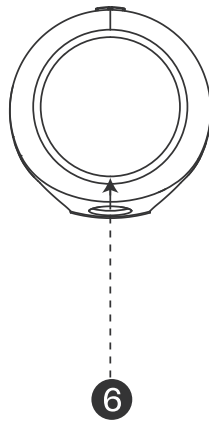



LED Indicator	Battery Status
Flashing Red	Low battery (< 20%)
Solid Red	Charging
Red LED Turns off	Fully charged

NOTE: 1. Before using it for the first time, please fully charge the built-in battery.

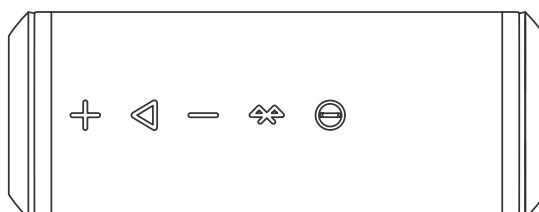

2. When the battery is less than 10% power remaining, the speaker will power off automatically.

• Overview Button



	Press and hold it for 2s	Power on	Blue indicator light will flash
	Press and hold it for 2s	Power off	All indicators will turn off

• Bluetooth Connection

 Bluetooth Mode	Short press for 1 second	Active entry of pairing status
 Bluetooth TWS Mode	Press and hold it for 3s	Host enters to TWS pairing mode

Make sure that the speaker is within 10 meters from your mobile device.

1. When your speaker is turned off, press and hold the “  ” button until you hear a rising tone and the LED indicators turn blinking blue.

2. Go to the Bluetooth settings on your mobile device, search and select “ Zamkol ZK606Pro ” from the list of devices.

3. Once paired, the LED indicators turn solid blue.

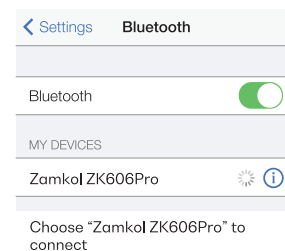



Note: When powered on, the speaker automatically reconnects to the previously connected device.

• Volume adjustment

+	Short press	Increase volume
	Press and hold it for 2s	Next track
-	Short press	Decrease volume
	Press and hold it for 2s	Previous track

• **Multifunctional button (MFB)**

 Music mode	Short press for 1 second	Play/pause
	Press and hold it for 2s	Activate siri
 Conversation mode	Short press for 1 second	Answer phone call
	Press and hold it for 2s	Rejected phone call
	Short press	End phone call

• **Bluetooth TWS pairing**

TWS Connection Operation

1. Long press the “” button to enter into the true wireless stereo pairing mode as a master speaker. If one of them fails, clean up the pairing information.

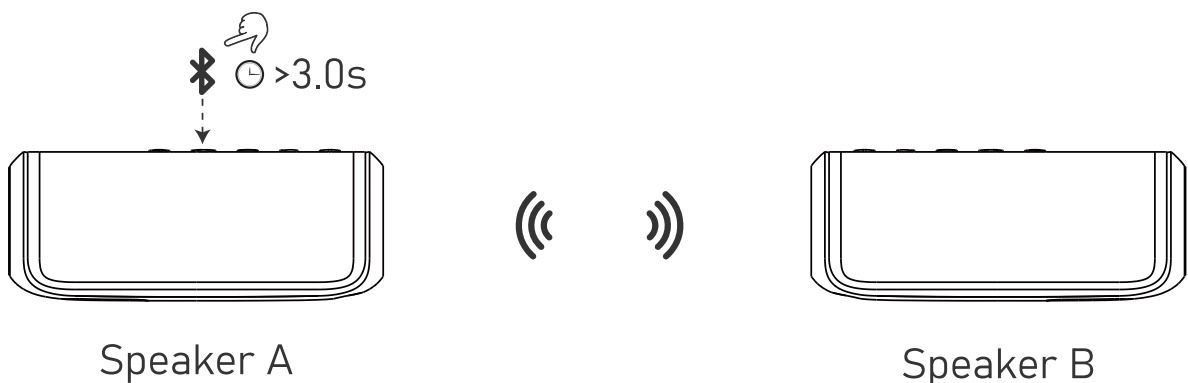

2. Enable the Bluetooth on your device and connect to “Zamkol ZK606Pro”, the stereo sound will play from both speakers.



3. Once paired, the MAIN speaker blue indicator light is always on.

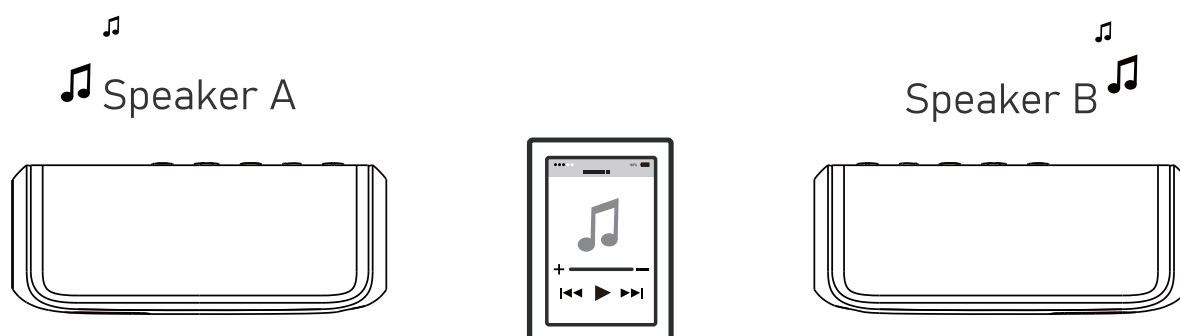

• Listening to music through AUX IN

1. Power on the speaker.
2. Use the AUX Cable to connect your external device to the AUX IN port on the speaker.
3. The speaker will automatically turn into the AUX IN mode, and the LED Indicators turn solid green.

- **Sound mode**

1. Insert the AUX cable plug as AUX IN mode.
2. Pull out the AUX cable plug and switch to Bluetooth mode.
3. AUX IN mode, the LED indicator keeps solid green.

- **Specifications**

Model	ZK606 Pro
Bluetooth version	5.0
Output power	25W
Frequency response	115Hz-15kHz
Battery type	7.2/2600 mAh
Charging time	≤4 hours@ 5V/2A
Waterproof Grade	IPX7
Dimensions	189 x 77 x 74 mm

• FCC Statement

Changes or modifications not expressly approved by the party responsible for compliance could void the user's authority to operate the equipment. This equipment has been tested and found to comply with the limits for a Class B digital device, pursuant to Part 15 of the FCC Rules. These limits are designed to provide reasonable protection against harmful interference in a residential installation. This equipment generates uses and can radiate radio frequency energy and, If not installed and used in accordance with the instructions, may cause harmful interference to radio communications. However, there is no guarantee that interference will not occur in a particular installation. If this equipment does cause harmful interference to radio or television reception, which can be determined by turning the equipment off and on, the user is encouraged to try to correct the interference by one or more of the following measures:

- Reorient or relocate the receiving antenna.
 - Increase the separation between the equipment and receiver.
 - Connect the equipment into an outlet on a circuit different from that to which the receiver is connected.
 - Consult the dealer or an experienced radio/TV technician for help.
- This device complies with part 15 of the FCC rules. Operation is subject to the following two conditions (1) this device may not cause harmful interference, and (2) this device must accept any interference received, including interference that may cause undesired operation.

- Contenu

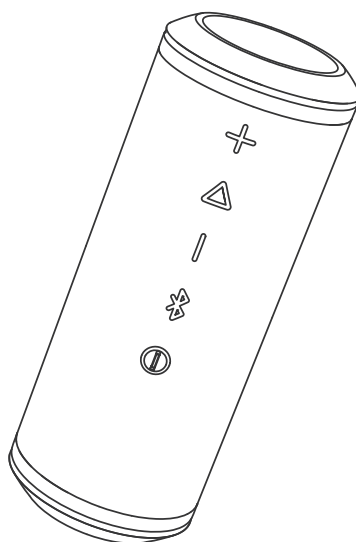

Zamkol ZK606 Pro

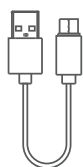

Câble de Chargement
USB-C



Manuel
d'Utilisation

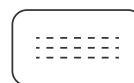

Carte de
Garantie

• Vue d'Ensemble du Produit

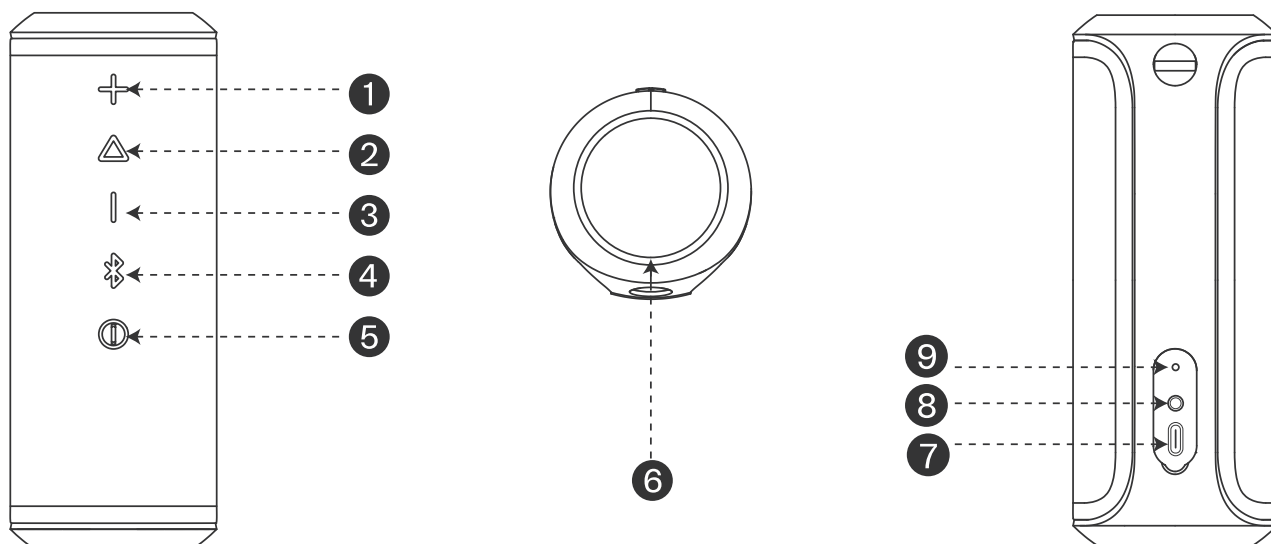

- ① Volume +/Chanson Suivante
- ② 2.Bouton MTF (Lecture/Pause /Appel)
- ③ Volume -/Chanson Précédente
- ④ Bouton Bluetooth
- ⑤ Bouton ON

- ⑥ Voyant Mode + Voyant de Charge
- ⑦ Port Type-C
- ⑧ Port Jack AUX IN
- ⑨ Reset

- Mise en Charge

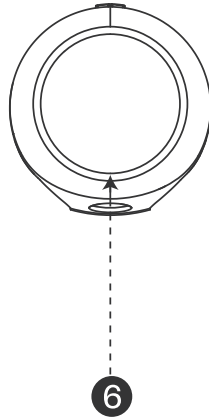



Voyant LED	Statut Batterie
Rouge Clignotant	Batterie Faible (< 20%)
Rouge Continu	En Charge
LED Rouge Eteinte	Batterie Rechargée

NOTE: 1. Veuillez charger votre appareil avant de l'utiliser pour la première fois.

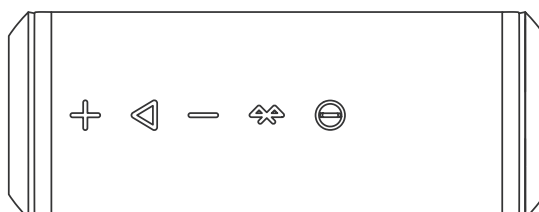

2. Lorsque la batterie de l'appareil est en dessous de 10%, l'enceinte s'éteint automatiquement.

• Vue d'ensemble des Boutons



	Maintenez appuyé 2sec	Allumer	Le voyant bleu clignote
	Maintenez appuyé 2sec	Eteindre	Tous les voyants s'éteignent

• Connexion Bluetooth

 Mode Bluetooth	Appuyez pendant une seconde	Synchronisation
 Mode Bluetooth TWS	Maintenez appuyé 3se Entrer en mode	Synchronisation TWS

Assurez-vous que l'enceinte se trouve à moins de 10 mètres de votre appareil mobile.

1. Lorsque votre haut-parleur est éteint, maintenez le bouton “  ” appuyé jusqu’à entendre une tonalité et que les voyants LED clignotent en bleu.

2. Accédez aux paramètres Bluetooth de votre appareil mobile, dans la liste des appareils, recherchez et sélectionnez “ Zamkol ZK606Pro ”.

3. Une fois les appareils synchronisés, les voyants LED brille fixement en bleu.

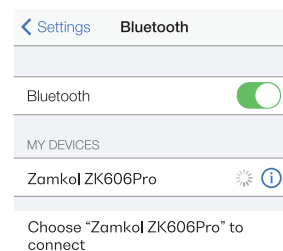



Note: Lorsqu'elle est allumée, l'enceinte se reconnecte automatiquement au dernier appareil connecté.

• Réglage du Volume

+	Appuyez Brièvement	Augmenter le volume
	Maintenez appuyé 2sec	Chanson suivante
-	Appuyez Brièvement	Diminuer le volume
	Maintenez appuyé 2sec	Chanson Précédente

• Bouton MULTIFONCTION (MTF)

 Music mode	Appuyez Brièvement	Lecture/Pause
	Maintenez appuyé 2sec	Activez Siri
 Conversation mode	Appuyez Brièvement	Décrocher un Appel
	Maintenez appuyé 2sec	Refuser un Appel
	Appuyez Brièvement	Terminer un Appel

• Synchronisation Bluetooth TWS

Fonctionnement Connexion TWS

- Maintenez le bouton “  ” appuyé pour activer le mode de synchronisation stéréo sans fil en tant que haut-parleur principal. Si l'un d'eux échoue, effacez les informations de synchronisation.

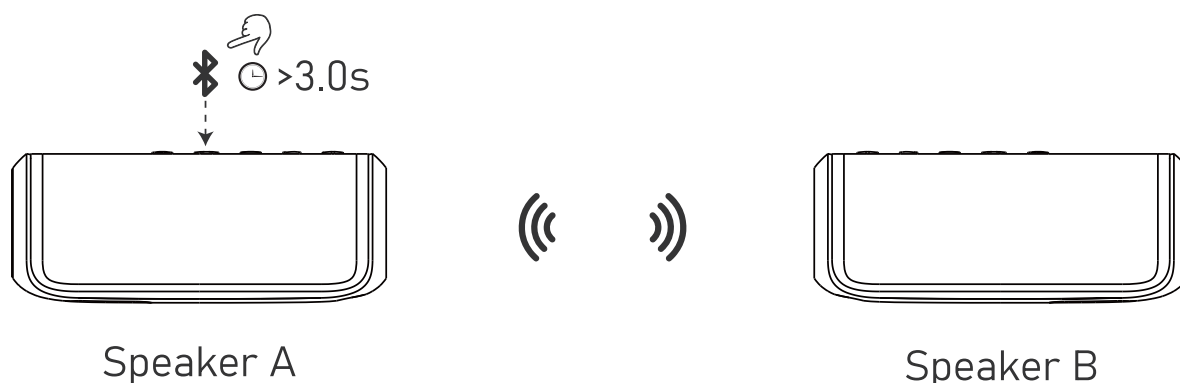

2. Activez le Bluetooth sur votre appareil et connectez-vous à "Zamkol ZK606Pro", le son stéréo sera joué par les deux haut-parleurs.



3. Une fois synchronisé, le voyant bleu de l'enceinte PRINCIPALE reste constamment allumé.

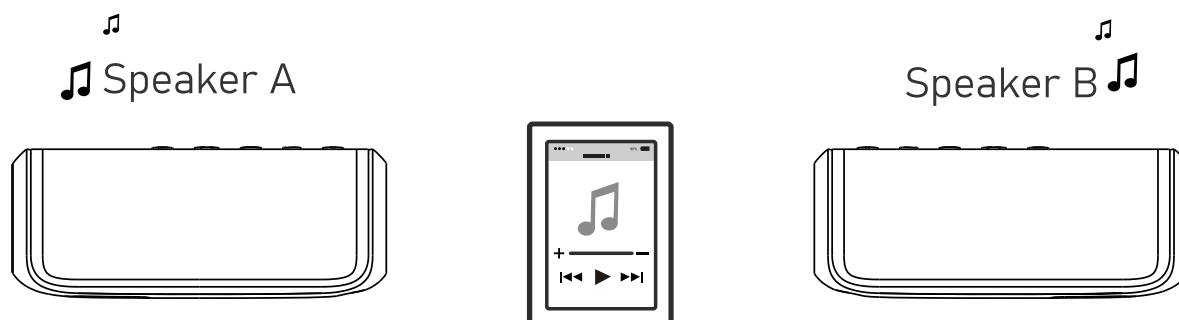

• Lecture via AUX IN

1. Allumez l'enceinte.
2. Utilisez le câble AUX pour connecter votre appareil au port AUX IN du haut-parleur.
3. L'enceinte passera automatiquement en mode AUX IN et les voyants LED brilleront en vert continuellement.

• Mode Son

1. Insérez le câble AUX dans le port AUX-IN
2. Retirez le câble AUX pour passer en mode Bluetooth.
3. En mode AUX IN, les voyants LED brilleront en vert continuellement.

• Caractéristiques

Modèle	ZK606 Pro
Version Bluetooth	5.0
Puissance de Sortie	25W
Plage de Fréquence	115Hz-15kHz
Capacité de la Batterie	7.2/2600 mAh
Durée de Charge - 3.5 Heures	≤4 hours@ 5V/2A
Étanchéité	IPX7
Dimensions	189 x 77 x 74 mm

- **Inclusi nella confezione**

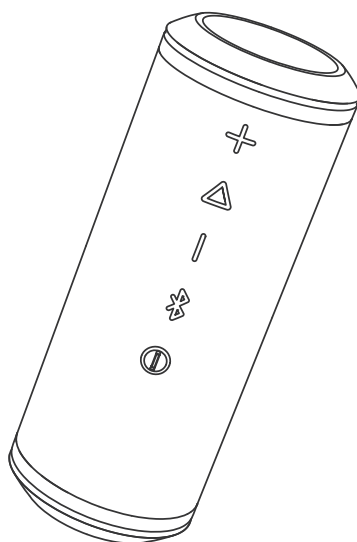

Zamkol ZK606 Pro

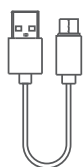

Cavo di ricarica
USB-C



Manuale
d'istruzioni

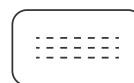

Libretto
di garanzia

• Panoramica del prodotto

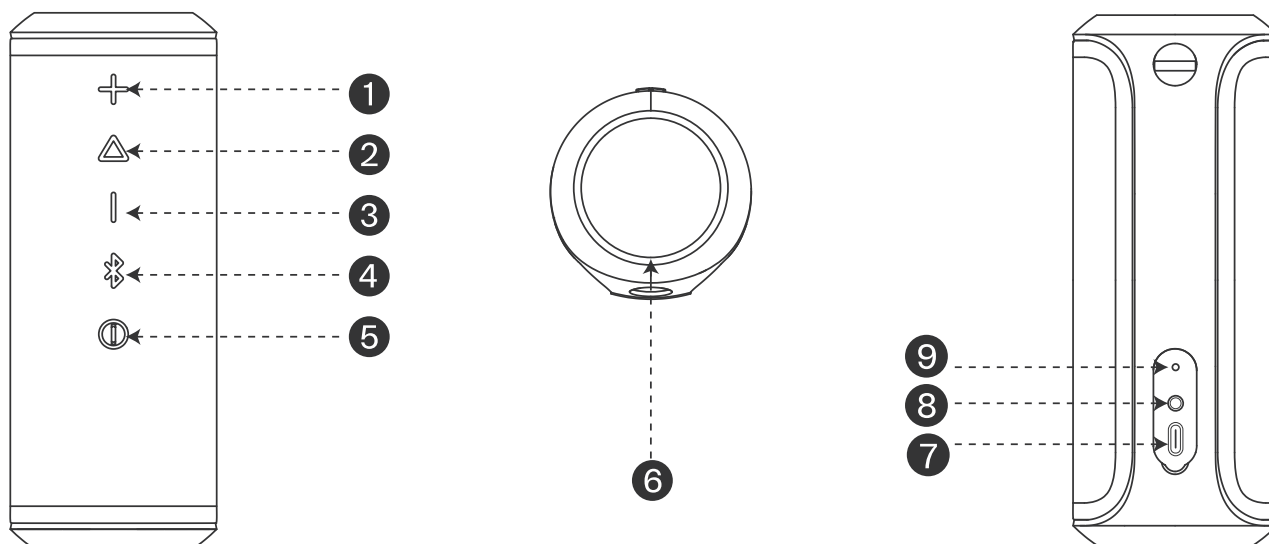

- | | |
|--|------------------------------------|
| ① Volume +/Traccia successiva | ⑥ Mode light + Luce di ricarica |
| ② 2.MFB (Riproduzione/Pausa /Chiamata) | ⑦ Connettore di ricarica di tipo C |
| ③ Volume -/Traccia precedente | ⑧ AUX IN Jack |
| ④ Pulsante Bluetooth | ⑨ Reimpostare |
| ⑤ Pulsante di accensione | |

• Caricamento

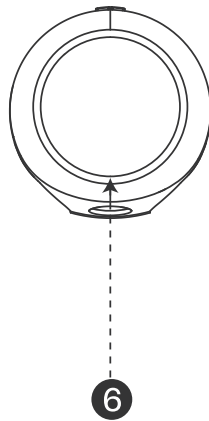

Indicatore LED	Stato batteria
Rosso lampeggiante	Batteria scarica (<20%)
Rosso solido	Ricarica
Led rosso si spegne	Completamente carico

NOTE: 1. Prima di utilizzare l'altoparlante per la prima volta, si prega di caricare completamente la batteria
2. Quando la batteria è inferiore al 10%, l'altoparlante si spegnerà automaticamente.

• Pulsante Panoramica



	Tenere premuto per 2 secondi	Power on	Spia blu lampeggia
	Tenere premuto per 2 secondi	Power off	Tutti gli indicatori si spegneranno

• Connessione Bluetooth

 Modalità Bluetooth	Premere brevemente 1 secondo	Bluetooth attivato
 Modalità Bluetooth TWS	Tenere premuto per 3 secondi	Host entra in modalità di associazione TWS

Assicurarsi che l'altoparlante si trova a 10 metri dal dispositivo mobile.

1. Quando l'altoparlante è spento, tenere premuto il pulsante “  ” fino a quando non si sente un tono crescente e gli indicatori LED lampeggiano in blu lampeggiante.

2. Accedere alle impostazioni Bluetooth sul tuo dispositivo mobile, cerca e seleziona " Zamkol ZK606Pro " dall'elenco dei dispositivi.

3. Una volta accoppiati, gli indicatori LED diventano blu fisso.

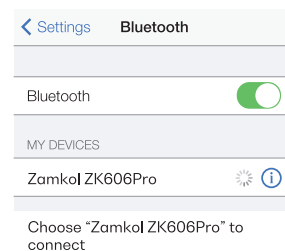



Note: quando è acceso, l'altoparlante si riconnette automaticamente al dispositivo collegato in precedenza.

• Regolazione del volume

+	Premere brevemente	Aumenta il volume
	Tenere premuto per 2 secondi	Prossima traccia
-	Premere brevemente	Diminuisce il volume
	Tenere premuto per 2 secondi	Traccia precedente

• Pulsante multifunzionale (MFB)

 Modalità Music	Premere brevemente per 1 secondo	Play/pause
	Tenere premuto per 2 secondi	Attiva SIRI
 Modalità di chiamata	Premere brevemente per 1 secondo	Rispondere alla chiamata
	Tenere premuto per 2 secondi	Rifiuta chiamata
	Premere brevemente	Termina chiamata

• Associazione Bluetooth TWS

Operazione di connessione TWS

1. Premere a lungo il tasto “” per entrare nella modalità di accoppiamento stereo wireless come altoparlante principale. Se uno di loro ha esito negativo, riprovare l’associazione o ripulire informazioni.

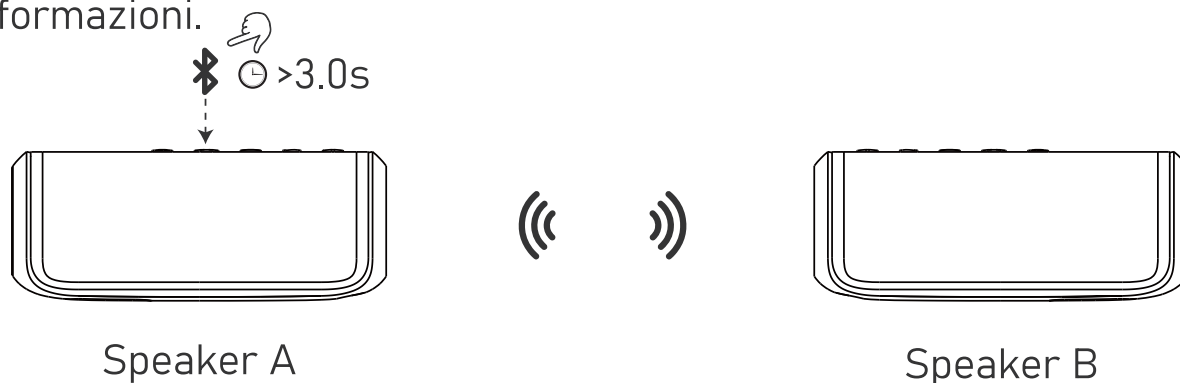

2. Abilitare il Bluetooth sul tuo dispositivo e connettere a "Zamkol ZK606Pro", il suono stereo verrà riprodotto da entrambi gli altoparlanti.



3. Una volta accoppiato, la spia blu dell'altoparlante MAIN è sempre attiva.

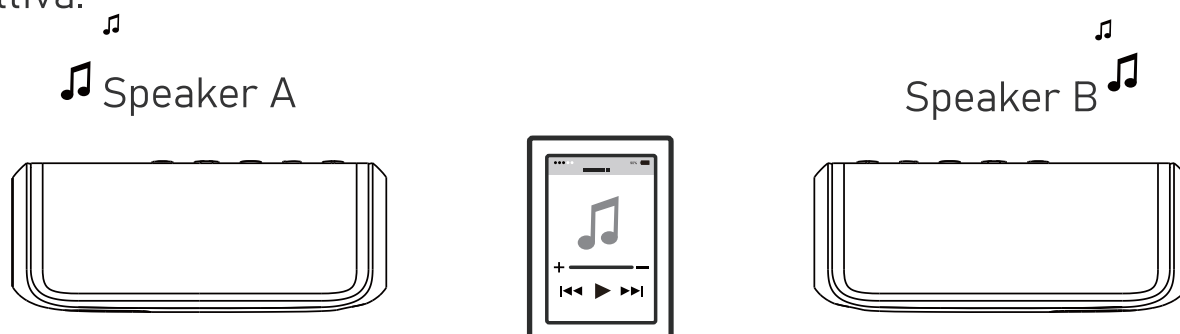

• Ascolto di musica tramite AUX IN

1. Accensione dell'altoparlante.
2. Utilizzare il cavo AUX per collegare il dispositivo esterno alla porta AUX IN sull'altoparlante.
3. L'altoparlante si trasformerà automaticamente in modalità AUX IN e gli indicatori LED diventano verdi fisso.

• Modalità audio

1. Inserire la spina del cavo AUX in modalità AUX IN.
2. Estrarre la spina del cavo AUX e passare alla modalità Bluetooth.
3. Modalità AUX IN, l'indicatore LED mantiene verde solido.

• Specifiche

Modello	ZK606 Pro
Versione Bluetooth	5.0
Potenza di uscita	25W
Risposta frequenza	115Hz-15kHz
Capacità batteria	7.2/2600 mah
Tempi di ricarica	≤4 ore 5V/2°
Impermeabilità	IPX7
Dimensioni	189*77*74 mm

- **Verpackungsliste**

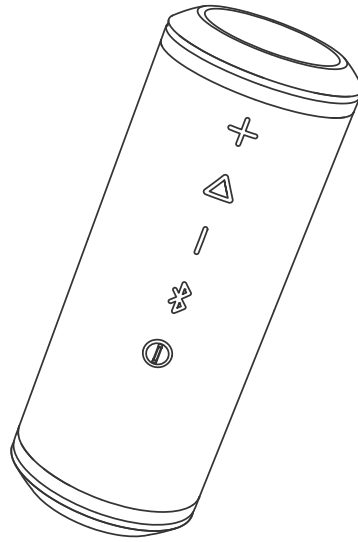

Zamkol ZK606 Pro

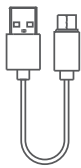

USB-C-Ladekabel



Benutzerhandbuch



Garantiekarte

• Produktübersicht

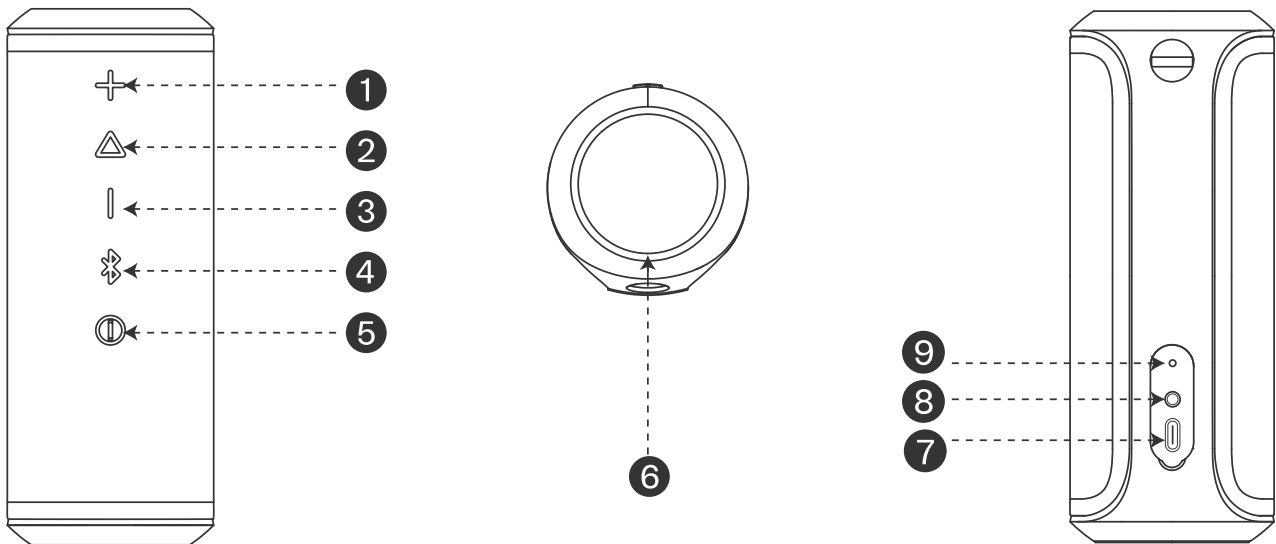

- | | |
|----------------------------------|------------------------------|
| ① Lautstärke +/Nächster Titel | ⑥ Modusleuchte + Ladeleuchte |
| ② 2.MFB (Wiedergabe/Pause/Anruf) | ⑦ Typ-C-Ladeanschluss |
| ③ Lautstärke -/Vorheriger Titel | ⑧ AUX IN Buchse |
| ④ Bluetooth-Taste | ⑨ Reset |
| ⑤ Einschalttaste | |

- Aufladen

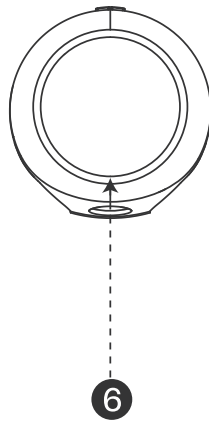

LED-Anzeige	Batteriestatus
Blinkt rot	Schwache Batterie (< 20 %)
Durchgehend rot	Laden
Rote LED schaltet sich aus	Voll geladen



HINWEIS: 1. vor der ersten Benutzung laden Sie bitte den eingebauten Akku vollständig auf. eingebauten Akku vollständig auf.
2. wenn der Akku weniger als 10 % Restkapazität hat, schaltet sich der Lautsprecher automatisch aus.

• Übersichtstaste



	Drücken und halten Sie für 2s	Einschalten	Blaue Kontrollleuchte blinkt
	Drücken und halten Sie für 2s	Ausschalten	Alle Anzeigen schalten sich ein

• Bluetooth-Verbindung

 Bluetooth-Modus	Kurzes Drücken für 1 Sekunde	Aktive Eingabe des Pairing-Status
 Bluetooth-TWS-Modus	Drücken und halten Sie 3s lang	Host wechselt in den TWS-Pairing-Modus

Stellen Sie sicher, dass der Lautsprecher nicht weiter als 10 Meter von Ihrem Mobilgerät entfernt ist.

1. Wenn Ihr Lautsprecher ausgeschaltet ist, halten Sie die Taste “” gedrückt, bis Sie einen ansteigenden Ton hören und die LED-Anzeigen blau blinken.

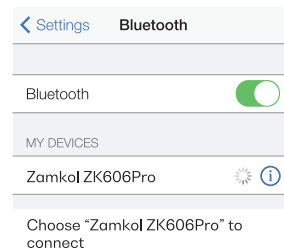

2. Gehen Sie zu den Bluetooth-Einstellungen auf Ihrem Mobilgerät, suchen Sie und wählen Sie "Zamkol ZK606Pro" aus der Liste der Geräte.

3. Sobald die Verbindung hergestellt ist, leuchten die LED-Anzeigen durchgehend blau.





Hinweis: : Nach dem Einschalten verbindet sich der Lautsprecher automatisch wieder mit dem zuvor verbundenen Gerät.

• Lautstärkeregelung

	Kurz drücken	Lautstärke erhöhen
	Drücken und halten Sie 2s lang	Nächster Titel
	Kurz drücken	Lautstärke vermindern
	Drücken und halten Sie 2s lang	Vorheriger Titel

• Multifunktionstaste (MFB)

 Musikmodus	Kurz drücken für 1s	Wiedergabe/Pause
	Drücken und halten Sie 2s lang	Siri aktivieren
 Gesprächsmodus	Kurz drücken für 1s	Telefonat annehmen
	Drücken und halten Sie 2s lang	Abgelehnter Telefonanruf
	Kurz drücken	Anruf beenden

• Bluetooth TWS-Kopplung

Betrieb der TWS-Verbindung

1. Drücken Sie lange auf die Taste “” um als Master-Lautsprecher in den True Wireless Stereo Pairing-Modus zu gelangen. Wenn eine Verbindung fehlschlägt, bereinigen Sie die Paarungsinformationen.

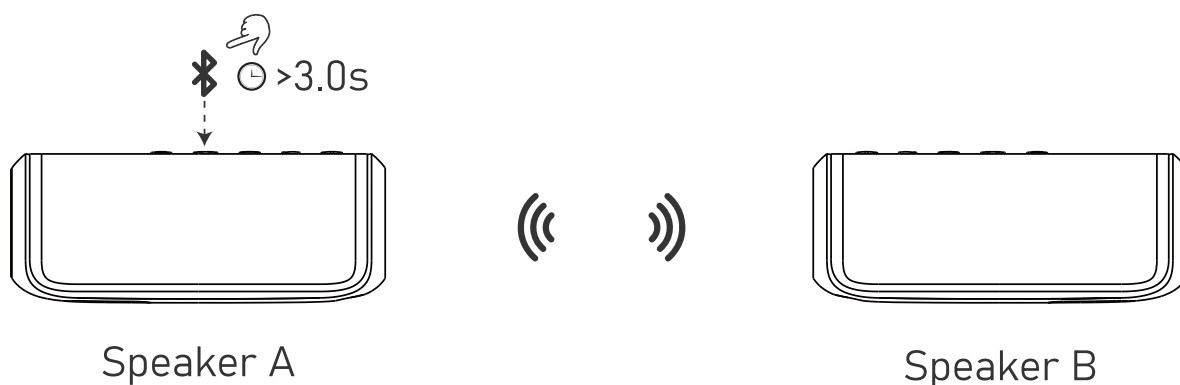

2. Aktivieren Sie Bluetooth auf Ihrem Gerät und verbinden Sie es mit dem "Zamkol ZK606Pro", der Stereoton wird von beiden Lautsprechern wiedergegeben.



3. Nach dem Pairing leuchtet die blaue Kontrollleuchte des MAIN-Lautsprechers immer.

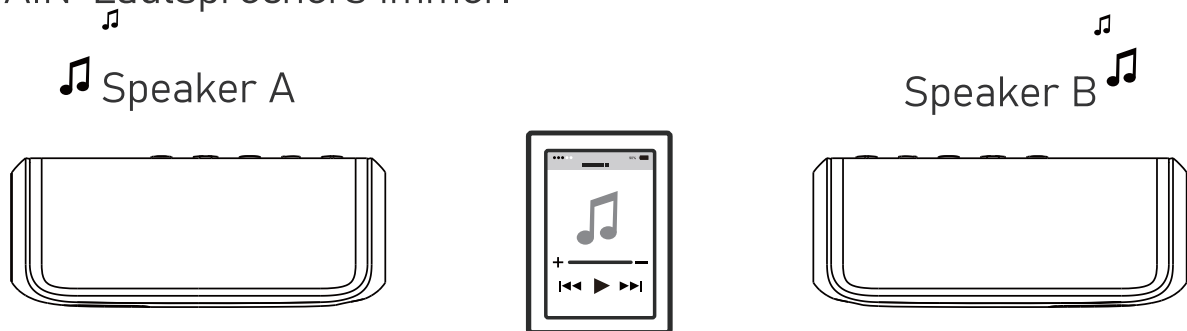

• Hören von Musik über AUX IN

1. Schalten Sie den Lautsprecher ein.
2. Verwenden Sie das AUX-Kabel, um Ihr externes Gerät mit dem AUX IN-Anschluss des Lautsprechers zu verbinden.
3. Der Lautsprecher schaltet automatisch in den AUX IN-Modus, und die LED-Anzeigen leuchten grün.

• Sound-Modus

1. Stecken Sie den Stecker des AUX-Kabels als AUX IN-Modus ein.
2. Ziehen Sie den Stecker des AUX-Kabels heraus und wechseln Sie in den Bluetooth-Modus.
3. Im AUX IN-Modus leuchtet die LED-Anzeige dauerhaft grün.

• Spezifikationen

Modell	ZK606 Pro
Bluetooth-Version	5.0
Ausgangsleistung	25W
Frequenzgang	115Hz-15kHz
Akku-Typ	7.2/2600 mAh
Aufladezeit	≤4 Stunden @ 5V/2A
Wasserdichte Klasse	IPX7
Abmessungen	189 x 77 x 74 mm

• パッキングリスト

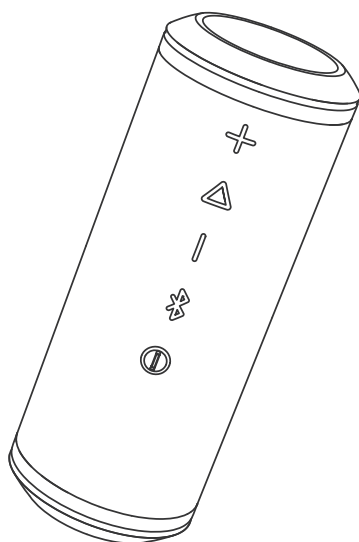

Zamkol ZK606 Pro

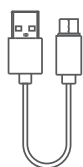

USBケーブル・
タイプC

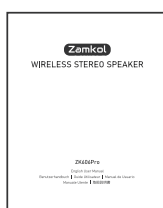

ユーザーマニュアル

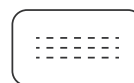

保証証

• 製品概要

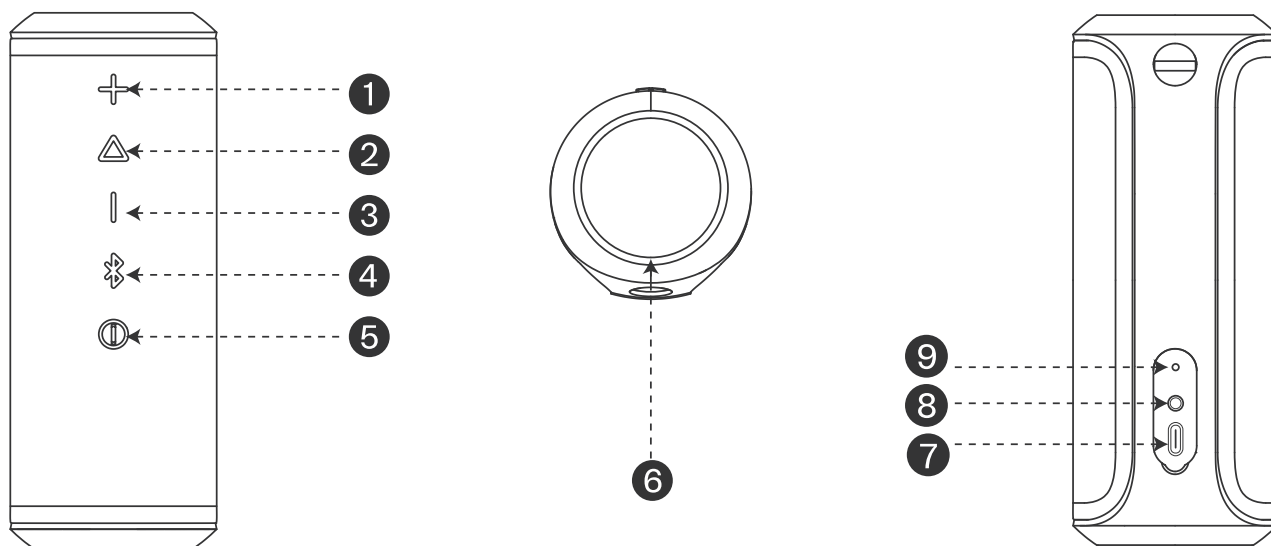

- ① ボリューム+/次曲
- ② 2MFB (プレイ/停止/コール)
- ③ ボリューム-/前曲
- ④ Bluetooth® ボタン
- ⑤ 電源ボタン

- ⑥ モードライト+充電ライト
- ⑦ USBケーブル・タイプCコネクタ
- ⑧ AUXジャック
- ⑨ リセット

- 充電

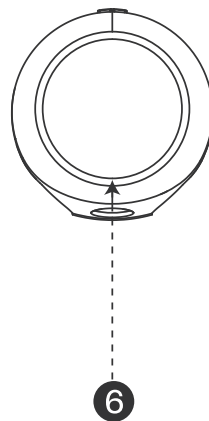

LEDインジケーター	バッテリー状態
赤点滅	バッテリー低下（20%以下）
赤点灯	充電中
赤消灯	充電完了

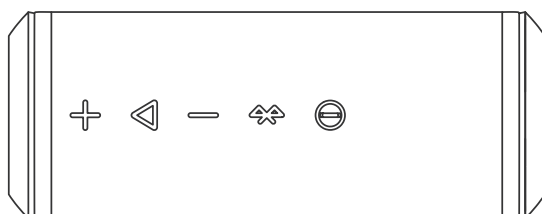

- 注記: 1. 最初にご使用になる前に、バッテリーの充電を完了させてください。
2. バッテリー残量が10%以下になったら、スピーカーは自動的にオフになります。

• ボタンについて



	2秒間長押し	電源オン	青色点滅
	2秒間長押し	電源オフ	ライト消灯

• Bluetooth®について

 Bluetooth®モード	1秒間長押し	ペアリング可能
 Bluetooth® TWSモード	3秒間長押し	ペアリング成功

Bluetooth®につなげるデバイスは、本スピーカーの10m以内にあることを確かめてください。

1. スピーカーの電源がオフの時、“” ボタンを起動音と青色のLEDが点滅するまで長押ししてください。

2. Bluetooth®つなげるデバイスの設定では、“Zamkol ZK606Pro”を探しつけて下さい。

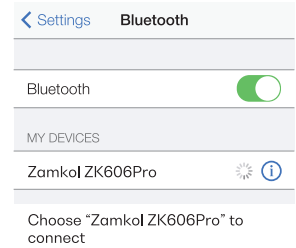



3. ペアリングが完了すると、青色のLEDが点灯します。

注記：電源オフの時、スピーカーは自動でBluetooth®接続が解除されます。

• ボリューム設定

+	通常ボタン押し	ボリュームアップ
	2秒間長押し	次曲
-	通常ボタン押し	ボリュームダウン
	2秒間長押し	前曲

• 多機能ボタン

 Music mode	1秒間長押し	プレイ/一時停止
	2秒間長押し	Siri起動
 Conversation mode	1秒間長押し	電話に出る
	2秒間長押し	電話に出ない
	通常押し	電話を切る

• Bluetooth® TWSペアリング

ペアリング方法

1. “” ボタンを長押しして、マスター スピーカーとしてワイヤレスステレオ ペアリング モードに入ります。ペアリングに失敗した場合は、ペアリング情報をクリーンアップしてください。

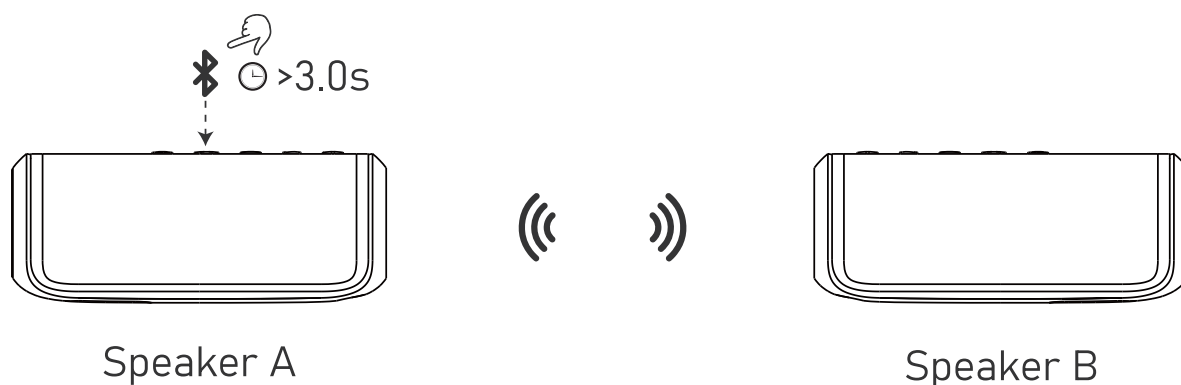

2. “Zamkol ZK606Pro”に繋がったら、ステレオサウンドが両方のスピーカーから流れます。



3. ペアリングが成功し、メインスピーカーの青色ライトが常時点灯します。

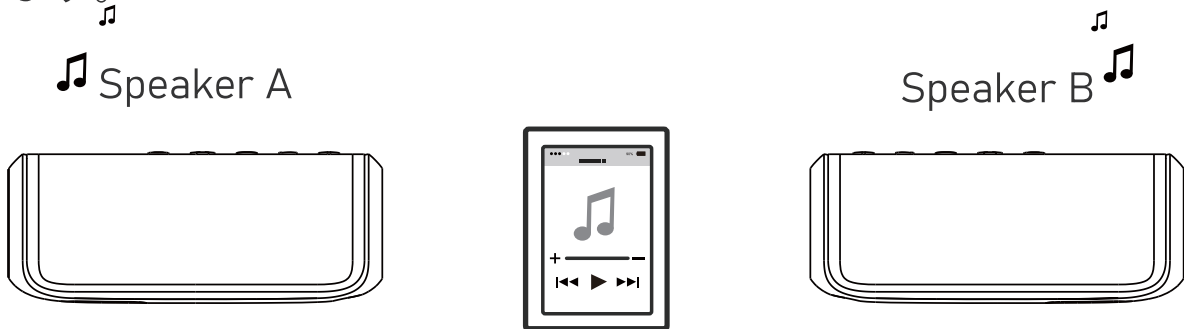

• AUXで音楽を聞くとき

1. スピーカーの電源を入れてください。
2. AUXケーブルを使って、対象のデバイスとスピーカーをつなげてください。
3. スピーカーが自動でAUXモードに切り替わり、LEDライトが緑色に点灯します。

• サウンドモード

1. AUXケーブルをつなげてください。
2. AUXケーブル抜き、Bluetooth®モードに切り替えてください。
3. LEDライトが緑色のまま点灯します。

• Specifications

モデル	ZK606 Pro
Bluetooth®バージョン	5.0
出力	25W
周波数	115Hz-15kHz
バッテリータイプ	7.2/2600 mAh
充電時間	≤4 hours@ 5V/2A
防水性能	IPX7
寸法	189 x 77 x 74 mm

- Lista de empaque

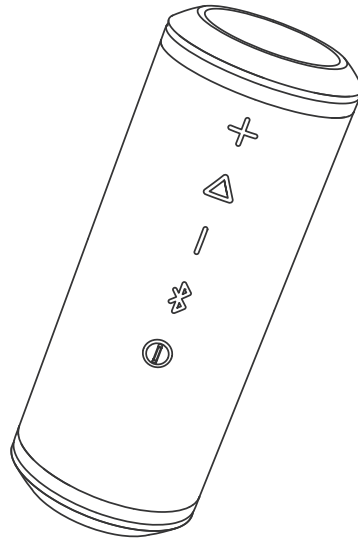

Zamkol ZK606 Pro

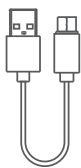

Cable de carga
USB-C



Manual de usuario

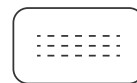

Tarjeta de garantía

• Descripción general del producto

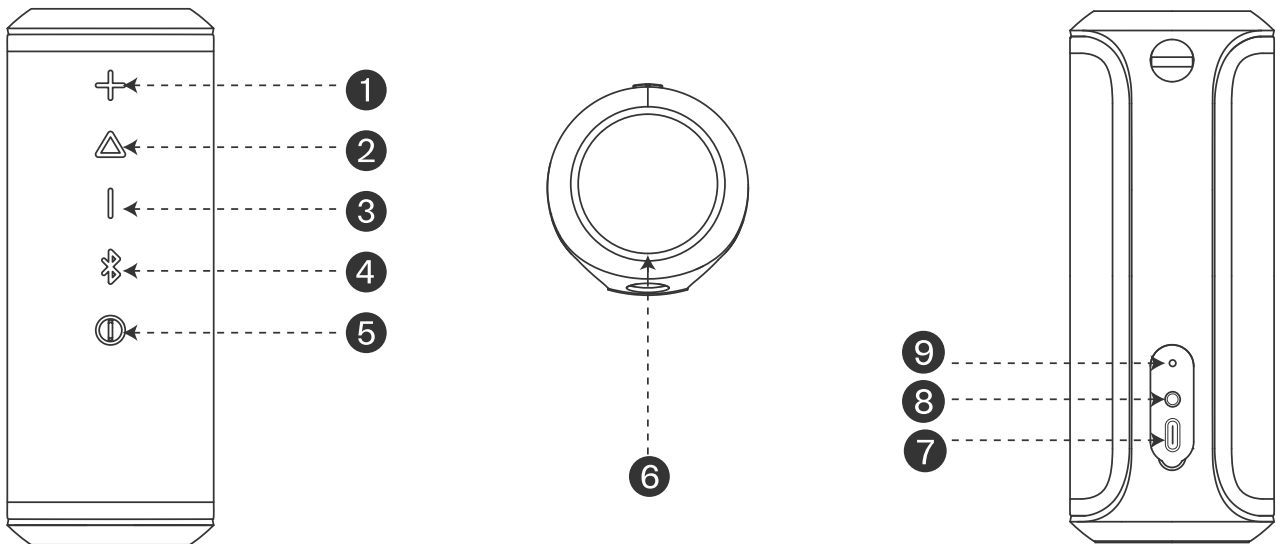

- ① Volumen + / Siguiendo pista
- ② MFB (Reproducir / Pausar / Llamar)
- ③ Volumen - / Pista anterior
- ④ Botón de Bluetooth
- ⑤ Botón de encendido

- ⑥ Luz indicadora de modo + luz de carga
- ⑦ Cable de carga Tipo C
- ⑧ Cable AUX-IN
- ⑨ Restablecer

- Carga

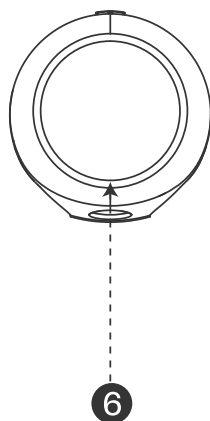

Indicador LED	Estado de la batería
Rojo parpadeante	Batería baja (< 20%)
Rojo fijo	Cargando
El indicador LED se ha apagado	completamente cargado

NOTA: 1. Antes de usarlo por primera vez, cargue completamente la batería integrada.

2. Cuando la batería tenga menos del 10% de energía restante, el altavoz se apagará automáticamente.

• Botón General

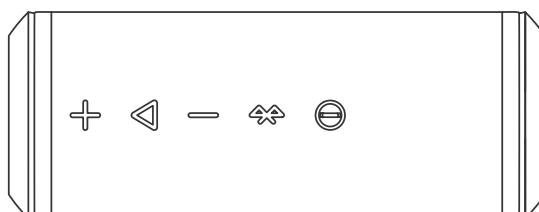

	Mantenga presionado durante 2 segundos	Encendido	El indicador LED Azul parpadeará
	Mantenga presionado durante 2 segundos	Apagado	Todos los indicadores se apagarán

• Conexión Bluetooth

 Modo Bluetooth	Presione brevemente durante un segundo	Entrada activa al estado de emparejamiento
 Modo Bluetooth TWS	Mantenga presionado durante 3 segundos	El host ingresa al modo de emparejamiento TWS

Asegúrese de que el altavoz esté a menos de 10 metros de su dispositivo móvil.

1. Cuando su altavoz esté apagado, mantenga presionado el botón “” hasta que escuche el tono ascendente y los indicadores LED parpadeen en azul.

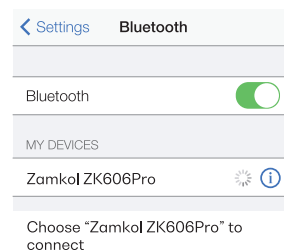

2. Vaya a la configuración de Bluetooth de su dispositivo móvil, busque y seleccione "Zamkol ZK606Pro" de la lista de dispositivos.

3. Una vez emparejados, los indicadores LED se volverán azules fijos.





Nota: al encender nuevamente su altavoz, este se vuelve a conectar automáticamente al dispositivo anterior conectado.

• Ajuste de volumen

	Presione brevemente	Para aumentar el volumen
	Mantenga presionado durante 2 segundos	Siguiente pista
	Presione brevemente	Para disminuir el volumen
	Mantenga presionado durante 2 segundos	Pista anterior

• Botón multifuncional (MFB)

 Modo Música	Presione durante 1 segundo	Reproducir/pausar
	Mantenga presionado durante 2 segundos	Para activar Siri
 Modo de Conversación	Presione durante 1 segundo	Contestar llamada telefónica
	Mantenga presionado durante 2 segundos	Rechazar llamada telefónica
	Presione brevemente	Finalizar llamada telefónica

• Emparejamiento Bluetooth TWS

Forma de conexión TWS

1. Mantenga presionado el botón “” para ingresar al modo de emparejamiento estéreo inalámbrico como altavoz principal. Si algo falla en uno de los dos, borre la información de emparejamiento..

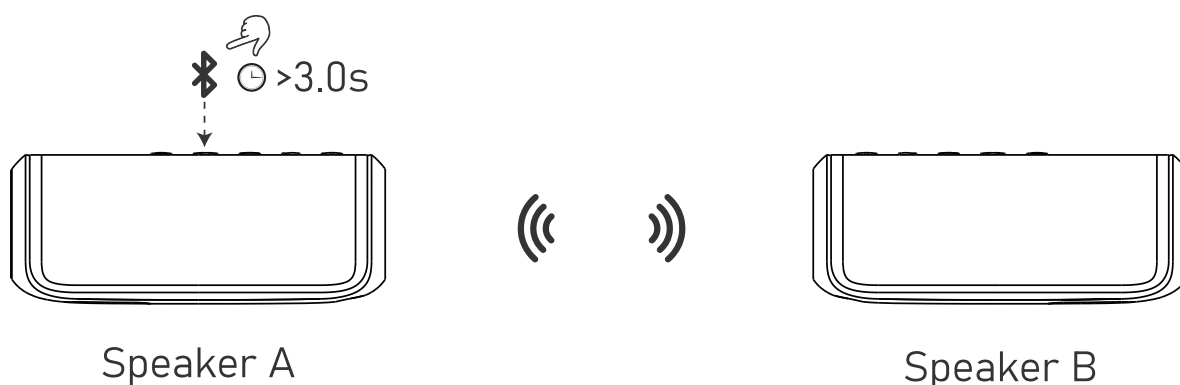

2. Habilite el Bluetooth en su dispositivo y conéctese a “Zamkol ZK606Pro”, el sonido estéreo se reproducirá en ambos altavoces.



3. Una vez emparejados, la luz indicadora azul del altavoz PRINCIPAL estará siempre encendida.

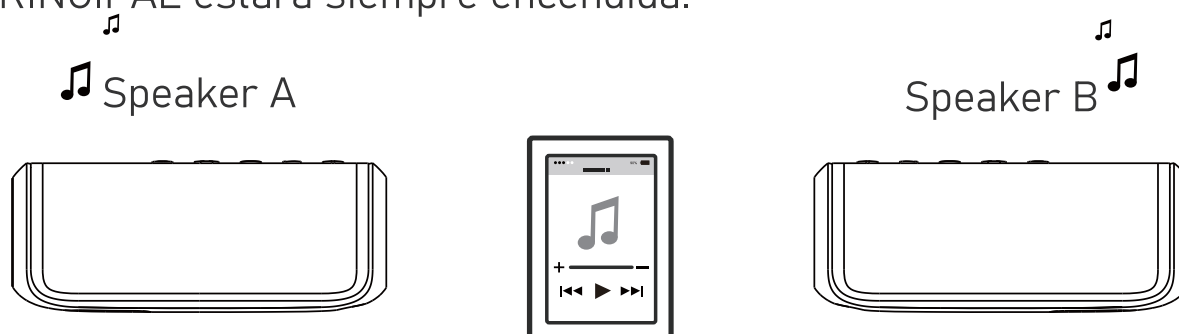

• Escuchar música usando el cable AUX-IN

1. Encienda el altavoz
2. Utilice el cable AUX para conectar su dispositivo externo al puerto AUX IN del altavoz.
3. El altavoz cambiará automáticamente al modo AUX IN y los indicadores LED se volverán en color verde fijo.

• Modo de sonido

1. Inserte el enchufe del cable AUX como modo AUX IN
2. Saque el enchufe del cable AUX y cambie al modo Bluetooth.
3. En el modo AUX IN, el indicador LED siempre permanecerá en verde fijo.

• Especificaciones

Modelo	ZK606 Pro
Versión del Bluetooth	5.0
Potencia de salida	25W
Frecuencia de respuesta	115Hz-15kHz
Tipo de Batería	7.2/2600 mAh
Tiempo de carga	≤ 4 horas 5V/2A
Grado de Impermeabilidad	IPX7
Dimensiones	189 x 77 x 74 mm

DOC:

Learn more about the UK Declaration of Conformity, Please click below link to download:

<https://www.zamkol.com/upload/doc/ZK606PRO-DOC-UK.pdf>

Learn more about the EU Declaration of Conformity, Please click below link to download:

<https://www.zamkol.com/upload/doc/ZK606PRO-DOC-EN.pdf>

Erfahren Sie mehr über die EU-Konformitätserklärung. Klicken Sie zum Herunterladen auf den folgenden Link:

<https://www.zamkol.com/upload/doc/ZK606PRO-DOC-DE.pdf>