

Smart PTZ Battery Camera

Operation Instruction

What's in the box

1. Camera*1
2. Bracket*1
3. Mounting kit*1
4. USB charging cable *1
5. Operation instruction*1
6. Solar panel pack(optional)*1

Product appearance

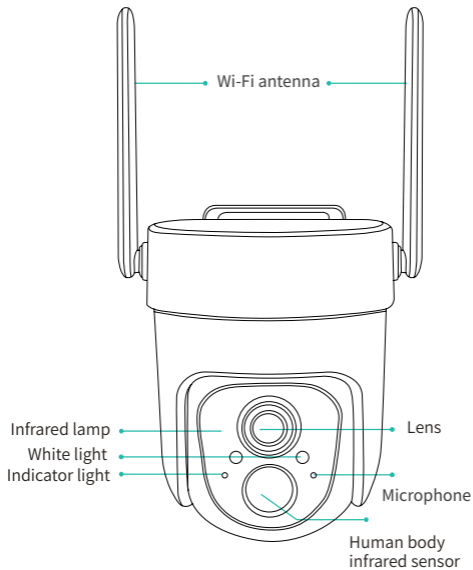

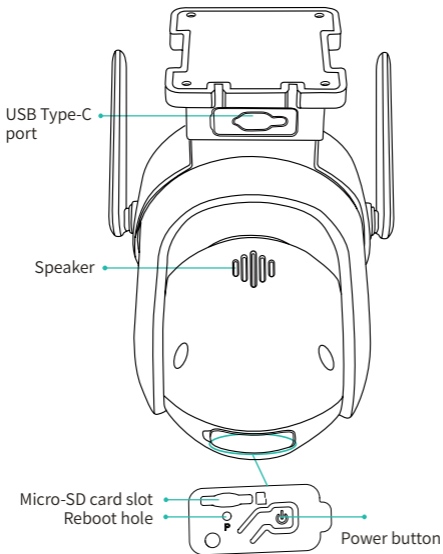

Quick start

1. Download and install the app

The camera supports Android and iOS apps. For your best experience, please download and install the app with your mobile phone as instructed below, and complete the user registration process in the app.

a) Go to the following link in your system browser to download:

app.vicohome.io

OR

b) Scan the QR code to go to the link to download:



Download app

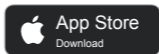

! DO NOT use 3rd party QR code scanning tool or app to avoid scam or malware. Use QR code scanning app provided by your mobile phone system, e.g. the system camera app.

2. Add the device

Sign in to the app, connect to Wi-Fi and add the device according to the prompts (please bring the device close to the router when configuring).

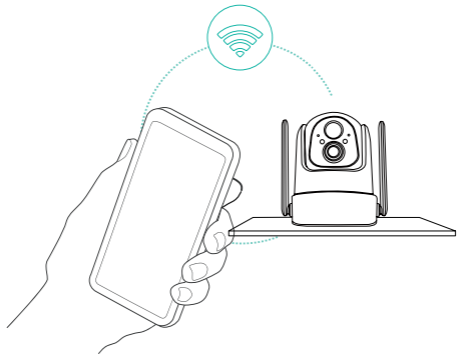

Bind the camera

1) Click the "Add Now" button in the app, press and hold the camera Power button for 3 seconds to turn on the camera, and the app will automatically search for devices that are on and not bound. Select the device you want to bind in the search results for the next step.

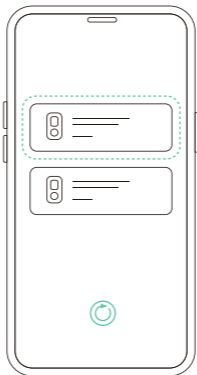

2) Please follow the guidance of the app, select or enter the Wi-Fi name you want the camera to connect to, and then enter the password. To ensure long-distance connection, the

camera only supports 2.4 GHz WiFi network with stronger wall penetration capability and does not support Wi-Fi with enterprise-level authentication. Please make sure that the Wi-Fi meets the requirements, click Next after completion, and the app can try to connect the camera to the Wi-Fi. support Wi-Fi with enterprise-level authentication. Please make sure that the Wi-Fi meets the requirements, click Next after completion, and the app can try to connect the camera to the Wi-Fi.



3)After a while, the camera will play a sound indicating that the connection is successful. At this point, please set a name for the camera on the app and select the location where you want to place the camera. Click Finish to complete the pairing.

Note: Due to the update of the app, the actual steps may be different. Please follow the instructions in the current app.

! Possible problems with binding:

Please check the information on the binding failure page on the app for relevant solutions.

- When you hear the "**Wi-Fi Password Error**", please check whether the Wi-Fi password you entered in the App is correct;
- When you hear the "**Authentication error**", please ensure that your Wi-Fi network is not an enterprise-level network, and the device supports only the network with the security level below WPA-2;
- When you hear the "**Wi-Fi not found**", please check whether you select or enter the correct Wi-Fi name, and place the device near the Wi-Fi router and ensure that the router is powered on. Please note that 5GHz Wi-Fi cannot be searched by the device;

- When you hear the "**Retrieving IP timeout**", it indicates that the number of devices connected to the router in your home is too many to connect more devices. Please remove some of the connected devices that are not commonly used or restart the router to clear the unconnected devices. You may need to contact the router administrator;
- When you hear the "**Cloud service connection fail**", please check whether your router is connected properly to the external network. When you hear this error prompt, it is common on the condition of network disconnection or that the selected router in your home is a local area network server. Please ensure that the network connection is normal, and try to temporarily turn off the firewall to connect again.

Install the camera

Please install the camera in a position where its view is not blocked and ensure that it is within the coverage of the Wi-Fi network.

(1) Select a good spot for your camera

1) For outdoor use, please install the camera upside down in order to maximize waterproof performance and the PIR motion sensor's efficiency.

- ! The PIR infrared sensor is more sensitive to movements across the camera's field of view than movements toward or away from the camera.

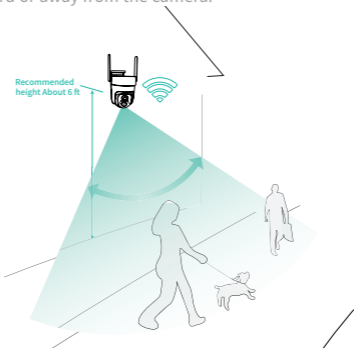

2) For indoor use, the camera can be installed on the wall.

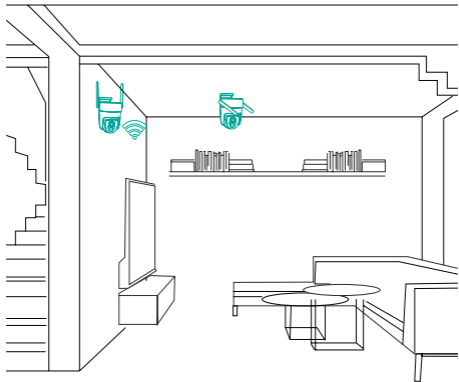

(2) Installation method

Bracket installation:

You can choose the bracket installation method to fix the camera in a suitable installation position.

1) Mark the spot

Place the Mounting kit mark where you plan to install, and mark the screw hole positions lightly with a pencil.

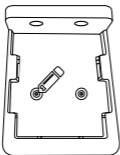

mounted on wall

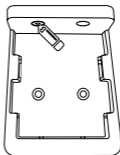

mounted on ceiling

2) Drill the holes

Optional: You may opt to use a drill bit to drill the holes where you have previously marked.

For mounting surfaces that are brick, concrete, or stucco, please use the plastic anchors. You may need to use a hammer to install the anchors.

For mounting surfaces that are wood or vinyl, you can omit the anchors, and use the screws directly.

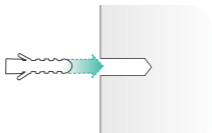

3) Install the mounting kit

Use a screwdriver to secure the mounting kit to the wall, tighten securely.

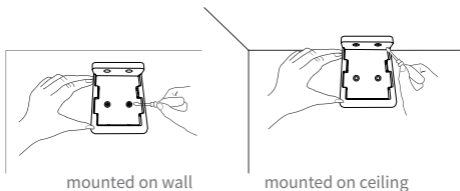

4) Attach the camera

Finally, align the camera with the fixed bracket and push it down to the bottom.

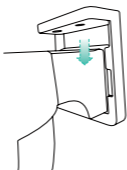

(3) Connect the solar charging panel to the camera (optional)

Open the rubber plug of the camera, then insert the cable of the solar charger to the Type-C USB port of the camera.

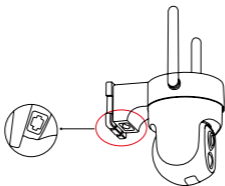

i For solar panel installation methods, please refer to the solar panel manual.

Share the camera

You can use this feature when you need to use the camera with other family members or friends. Only the admin user who has bound the camera for the first time can share and set up the camera, while other members can only view the live video or video playback feature of the camera.

1)For admin user of the camera, find the camera you wish to share on the app homepage or camera settings screen, then click the share button and enter the Share page. Click "Device Sharing" to generate a shared QR code.

2)For users who need to be shared with, click "+" on the homepage and select "Add Friend's Device" to enter the scan code page.

3)After the shared user successfully scans the QR code on the admin user's mobile phone, the admin user will receive a confirmation notification, then click "Accept" to complete the camera sharing.

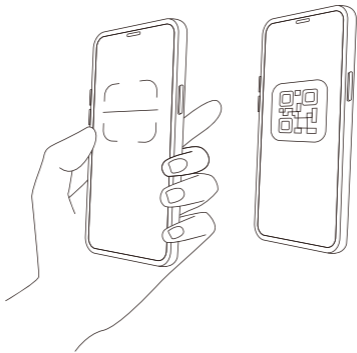

Charge the camera

The App will remind you to charge your camera when the battery is low. Please use the USB Type-C cable to plug into the 5V/1.5A charging adapter to charge the camera. During charging, the camera's indicator light is solid yellow, and when the camera is fully charged, the indicator light will turn into solid green. It will take 7 hours to fully charge the camera.

Indicator light status

Mode	Status
Working mode	Blue
Sleep mode	Off
Charging mode	Yellow
Fully charged mode	Green

Product specification

Item	Specification
Field of view	127°
Image resolution	Max. 2304×1296
Video bit rate	Adaptive
Storage media	Micro SD card (Up to 128GB)
Rotation Angle	355° pan, 90° tilt
Battery capacity	5200mAh
Adapter requirement	5V/1.5A
Size(without bracket)	5.57×5.08×4.72 (in)

Firmware upgrade

When you connect your camera through the app, it will prompt you if the latest firmware is available. You can also manually check the firmware version in the settings of the App.

- ⓘ Please make sure that your camera is fully charged or connected to the power adapter before upgrading the firmware, please do not cut off the power supply during the upgrading.

FAQ

1.Q:Camera permission management: How to invite family and friends to use my camera together?

A: Open the App and select your camera on the home page. Click the share button on the home page or the "Share" in the camera settings to enter the sharing page, and then click "Invite " to generate a QR code. Your friends can now get some of the access rights by scanning the QR code in your phone.

2.Q:Why doesn't the Wi-Fi name appear when I connect to Wi-Fi?

A: On Apple devices with iOS 13 and above, you need to turn on the "location permission" for the app in the system settings and change it to " allow when using" .

3.Q:Will the camera show red lights when night vision is activated?

A: A: The built-in infrared lamp beads make the camera only show some dim red lights when night vision is activated, but the image quality is still clear under no light environment.

4.Q:What are the requirements for Wi-Fi?

A: Please use a 2.4GHz wireless network. The device does not support the 5GHz wireless network. Meanwhile, please set the Wi-Fi authentication method to WPA2-PSK or other lower level of security method. A password is required.

5.Q:How far should the camera be placed from the router?

A: After testing, the Wi-Fi connection distance can normally reach up to 150 meters in the open area. However, the actual situation depends on the strength of Wi-Fi and its surrounding environment (thick walls, electromagnetic devices, large metal objects will all cause interference to the Wi-Fi signal). If the camera connection signal is weak or unstable, please place the camera as close to the router as possible.

6.Q:How to quickly view videos by category?

A: Click the icon in the upper left corner of the "Library" page to start filtering videos by category. Select the category you want to see and then click"Save" to view the video playbacks.

7.Q:What should I do when the device is in malfunction?

A: Long press the power button for 3 seconds to restart it. If there is no response, you can remove the rubber plug at the bottom of the camera. Press the reboot hole with a pointed object to restart the camera.

Safety

- Do not use the device in extreme temperatures, and never expose the device to strong sunshine or a humid,wet environment.
- The suitable temperature for CQ4 and its accessories is -10° C / 14° F to 45° C / 113° F (The temperature for charging is 0° C / 32° F to 45° C / 113° F).
- The best environment is a temperature range between 5° C / 41° F ~ 25° C / 77° F.
- When charging, please place the device(s) at room temperature in a place with good ventilation.

Warning

- Replacing the battery with an incorrect version can destroy the safety mechanisms within the device.
- Inappropriate battery disposal, for example, into a fire or a hot oven, or mechanically crushing or cutting the battery, can result in an explosion.
- Leaving a battery in a very high-temperature environment can result in an explosion or the leakage of flammable liquid or gas.
- A battery subjected to extremely low air pressure may result in an explosion or the leakage of flammable liquid or gas.

Attention

- Le remplacement de la batterie par un type incorrect peut détruire les mécanismes de sécurité à l'intérieur de l'appareil.
- L'élimination inappropriée de la batterie —par exemple, dans un feu ou dans un four, ou par écrasement ou coupure—peut provoquer une explosion.
- Le maintien de la batterie dans un environnement à très haute température peut provoquer une explosion ou la fuite de liquide ou de gaz inflammables.
- Une batterie soumise à une pression d'air extrêmement faible peut provoquer une explosion ou la fuite de liquide ou de gaz inflammables.



CAUTION: RISK OF EXPLOSION IF BATTERY IS REPLACED BY AN INCORRECT MODEL. DISPOSES OF USED BATTERIES ACCORDING TO THE INSTRUCTIONS.



ATTENTION: RISQUE D'EXPLOSION SI LA BATTERIE EST REMPLACÉE PAR UN TYPE INCORRECT. ÉLIMINER LES BATTERIES USÉES SELON LES INSTRUCTIONS.

Notice

FCC Statement

This device complies with Part 15 of the FCC Rules. Operation is subject to the following two conditions:

- (1) this device may not cause harmful interference;
- (2) this device must accept any interference received, including interference that may cause undesired operation.

Warning: Changes or modifications not expressly approved by the party responsible for compliance could void the user's authority to operate the equipment.

Note: This equipment has been tested and found to comply with the limits for a Class B digital device, pursuant to Part 15 of the FCC Rules. These limits are designed to provide reasonable protection against harmful interference in a residential installation.

FCC Radio Frequency Exposure Statement

The device has been evaluated to meet general RF exposure requirements. The device can be used in fixed/mobile exposure condition. The min separation distance is 20 cm.



Notice: Shielded cables

This equipment generates,uses and can radiate radio frequency energy and,if not installed and used in accordance with the instructions,may cause harmful interference to radio communications.

However, there is no guarantee that interference will not occur in a particular installation.If this equipment does cause harmful interference to radio or television reception, which can be determined by turning the equipment off and on, the user is encouraged to try to correct the interference by one or more of the following measures:

- (1) Reorient or relocate the receiving antenna.
- (2) Increase the separation between the equipment and receiver.
- (3) Connect the equipment into an outlet on a circuit different from that to which the receiver is connected.
- (4) Consult the dealer or an experienced radio/ TV technician for help.

All connections to other computing devices must be made using shielded cables to maintain compliance with FCC regulations.

IC Statement

This device complies with Industry Canada Licence-exempt RSS standard(s). Operation is subject to the following two conditions:

- (1) this device may not cause interference, and
- (2) this device must accept any interference, including interference that may cause undesired operation of the device.

Le présent appareil est conforme aux CNR d'Industrie Canada applicables aux appareils radio exemptés de licence. L'exploitation est soumise aux deux conditions suivantes:

- (1) l'appareil ne doit pas produire de brouillage, et
- (2) l'utilisateur de l'appareil doit accepter tout brouillage radioélectrique subi, même si le brouillage est susceptible d'en compromettre le fonctionnement.

This Class B digital apparatus complies with Canadian ICES-003.

Cet appareil numérique de la classe B est conforme à la norme NMB-003 du Canada.

IC RF Statement

When using the product, maintain a distance of 20cm from the body to ensure compliance with RF exposure requirements.

Lors de l'utilisation du produit, maintenez une distance de 20 cm du corps afin de vous conformer aux exigences en matière d'exposition RF

EU Statement



This product complies with the radio interference requirements of the European Community.

Hereby, This device is in compliance with the essential requirements and other relevant provisions of Directive 2014/53/EU. For the declaration of conformity.

This product can be used across EU member states.

RF exposure information:

The Maximum Permissible Exposure (MPE) level has been calculated based on a distance of $d=20$ cm between the device and the human body. To maintain compliance with RF exposure requirement, use product that maintain a 20cm distance between the device and human body.

CQ4 Wi-Fi Operating Frequency
Range:2412~2472 MHz(2.4G),Wi-Fi Max
Output Power:20dBm(ERIP) ;

CQ4 Bluetooth Operating Frequency
Range:2402~2480 MHz;
Bluetooth Max Output Power:8 dBm(EIRP) ;



This product is designed and manufactured with high quality materials and components, which can be recycled and reused.



This symbol means the product must not be discarded as household waste, and should be delivered to an appropriate collection facility for recycling.

Proper disposal and recycling helps protect natural resources, human health and the environment. For more information on disposal and recycling of this product, contact your local municipality, disposal service, or the shop where you bought this product.

UK Statement



This product complies with the radio interference requirements of the United Kingdom Declaration of Conformity.

Hereby, This product is in compliance with Radio Equipment Regulations 2017.