

SAR

Dipole & Waveguide

Performance Measurement Report

ISSUED BY
Shenzhen BALUN Technology Co., Ltd.



FOR
Validation Dipoles & Waveguide



Tested by: *Zong Liyao*

Zong Liyao
(Engineer)

Approved by: *Liao Jianming*

Liao Jianming
(Technical Director)



Report No.: LW-SZ1930992

EUT Type: SAR Validation Dipole and Waveguide

Model Name: DIP 0G750-446, DIP 0G835-447
DIP 0G900-448, DIP 1G800-449
DIP 1G900-450, DIP 2G000-451
DIP 2G450-452, DIP 2G600-453
SWG5500-WGA 42

Brand Name: SATIMO

Test Conclusion: Pass

Test Date: Mar. 19, 2019 ~ Mar. 21, 2019

Date of Issue: Mar. 22, 2019

NOTE: This test report can be duplicated completely for the legal use with the approval of the applicant; it shall not be reproduced except in full, without the written approval of Shenzhen BALUN Technology Co., Ltd. BALUN Laboratory. Any objections should be raised within thirty days from the date of issue. To validate the report, please visit BALUN website.



1 GENERAL INFORMATION

1.1 Introduction

This document contains a summary of the requirements set forth by the IEEE 1528, FCC KDB 865664 D01 for reference dipoles used for SAR measurement system validations. Instead of the typical annual calibration recommended by measurement standards, the reference dipoles were demonstrated that the SAR target, impedance and return loss have remain stable, so the longer calibration interval is acceptable.

1.2 General Description for Equipment under Test (EUT)

Model	Frequency	Serial Number	Product Condition(New/Used)	Last Cal. Date	Last Meas. Date
Dipole					
DIP 0G750	750 MHz	SN 11/17 DIP 0G750-446	Used	2017/03/17	2019/03/21
DIP 0G835	835 MHz	SN 11/17 DIP 0G835-447	Used	2017/03/17	2019/03/21
DIP 0G900	900 MHz	SN 11/17 DIP 0G900-448	Used	2017/03/17	2019/03/21
DIP 1G800	1800 MHz	SN 11/17 DIP 1G900-449	Used	2017/03/17	2019/03/19
DIP 1G900	1900 MHz	SN 11/17 DIP 1G900-450	Used	2017/03/17	2019/03/19
DIP 2G000	2000 MHz	SN 11/17 DIP 2G000-451	Used	2017/03/17	2019/03/19
DIP 2G450	2450 MHz	SN 11/17 DIP 2G450-452	Used	2017/03/17	2019/03/19
DIP 2G600	2600 MHz	SN 11/17 DIP 2G600-453	Used	2017/03/17	2019/03/19
Waveguide					
SWG5500	5GHz-6GHz	SN 49/16 WGA42	Used	2017/03/17	2019/03/20



1.3 Test Equipment List

Description	Manufacturer	Model	Serial No.	Cal. Date	Cal. Due
PC	Dell	N/A	N/A	N/A	N/A
E-Field Probe	MVG	SSE2	SN 34/15 SSE2 EPGO265	2019/03/19	2019/03/18
Phantom1	SATIMO	SAM	SN 30/13 SAM103	N/A	N/A
Phantom2	SATIMO	SAM	SN 30/13 SAM104	N/A	N/A
MultiMeter	Keithley	MultiMeter 2000	4024022	2018/06/15	2019/06/14
Signal Generator	R&S	SMBV100A	260592	2018/06/15	2019/06/14
Power Meter	Agilent	E4419B	GB40201833	2018/11/02	2019/11/01
Power Sensor	Agilent	E9300A	MY41498012	2018/11/02	2019/11/01
Power Sensor	Agilent	E9300A	MY41499891	2018/11/02	2019/11/01
Network Analyzer	R&S	ZVL-6	101380	2018/06/15	2019/06/14
Thermometer	Elitech	RC-4HC	N/A	2018/11/13	2019/11/12
Power Amplifier	SATIMO	6552B	22374	N/A	N/A
Dielectric Probe Kit	SATIMO	SCLMP	SN 25/13 OCPG56	N/A	N/A
Attenuator	COM-MW	ZA-S1-31	1305003187	N/A	N/A
Directional coupler	AA-MCS	AAMCS-UDC	000272	N/A	N/A

1.4 EUT Photos

DIP 0G750-446



DIP 0G835-447



DIP 0G900-448



DIP 1G800-449



DIP 1G900-450



DIP 2G000-451



DIP 2G450-452



DIP 2G600-453



Waveguide SWG5500





2 DIPOLE IMPEDANCE AND RETURN LOSS

The dipoles are designed to have low return loss when presented against a flat phantom at the specified distance. A Vector Network Analyzer was used to perform a return loss measurement on the specific dipole when in the measurement location against the phantom and the distance was specified by the manufacturer with a special, low loss and low relative permittivity spacer.

The impedance was measured at the SMA-connector with the network analyzer.

The measurement of verification with return loss should not deviate by more than 20% and minimum of 20 dB of the return loss, and the impedance (real or imaginary parts) should not deviate by more than 5 Ohms from the previous measurement using network analyzer.

Note:

The "Previous Meas." in the following table refer to dipoles or other equivalent RF sources calibration reports.



2.1 DIP 0G750

RETURN LOSS AND IMPEDANCE IN HEAD LIQUID

Meas. Results	Current Meas.	Previous Meas.	Max. Deviation
Return Loss(dB)	-26.12	-26.40	1.1 %
Impedance	53.2 Ω +2.7 j Ω	53.7 Ω +1.9 j Ω	0.8 Ω (Imaginary part)

Return Loss

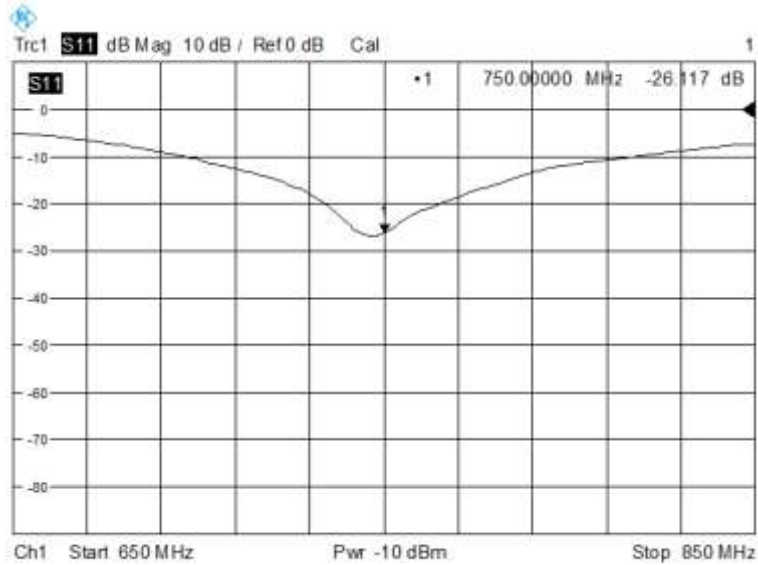

Impedance

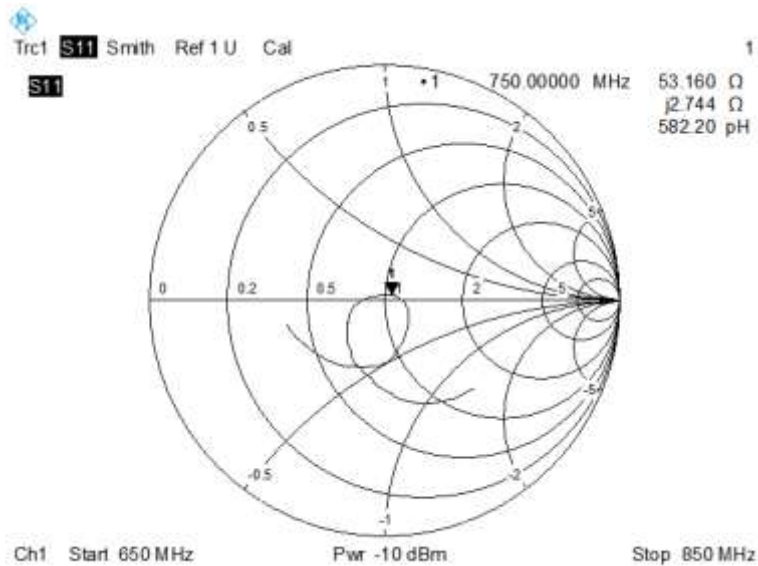

RETURN LOSS AND IMPEDANCE IN BODY LIQUID

Meas. Results	Current Meas.	Previous Meas.	Max. Deviation
Return Loss(dB)	-26.69	-27.73	3.8 %
Impedance	50.1 Ω + 5.4 j Ω	51.1 Ω + 5.9 j Ω	1.0 Ω (Real part)

Return Loss

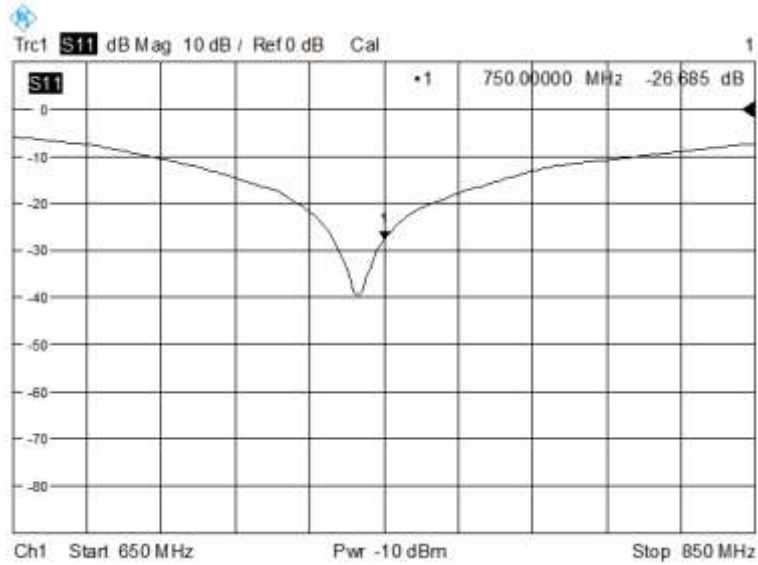

Impedance

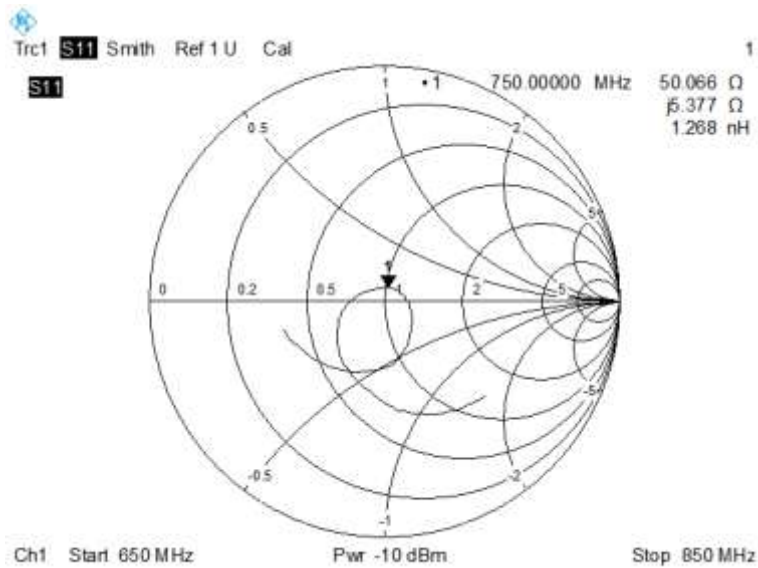



2.2 DIP 0G835

RETURN LOSS AND IMPEDANCE IN HEAD LIQUID

Meas. Results	Current Meas.	Previous Meas.	Max. Deviation
Return Loss(dB)	-31.42	-30.45	3.1%
Impedance	55.6 Ω -3.4 j Ω	53.5 Ω -1.1 j Ω	2.3 Ω (Imaginary part)

Return Loss

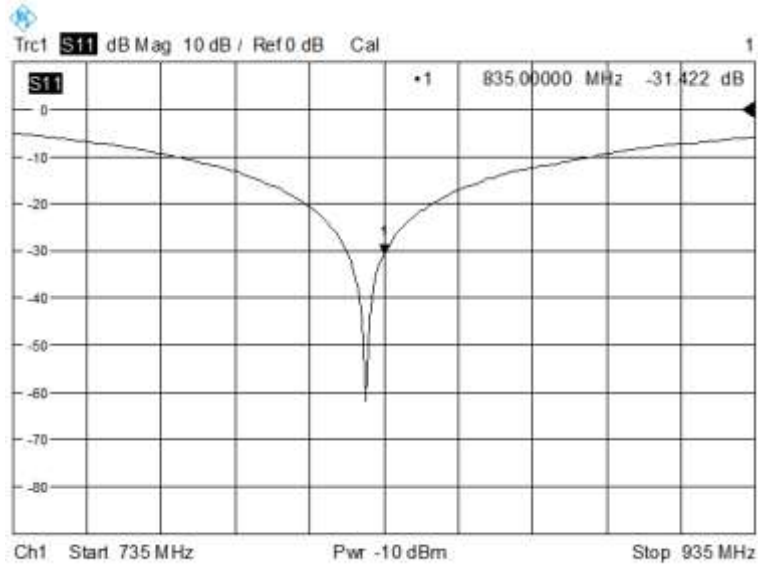

Impedance

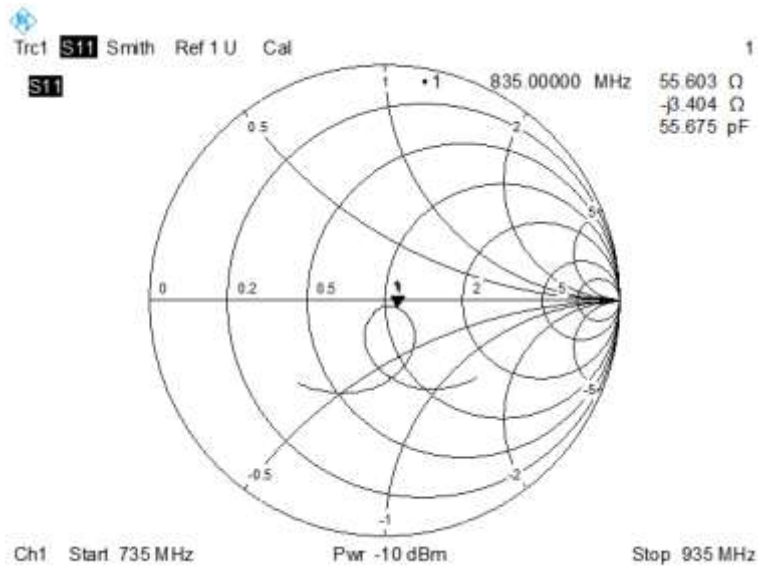



RETURN LOSS AND IMPEDANCE IN BODY LIQUID

Meas. Results	Current Meas.	Previous Meas.	Max. Deviation
Return Loss(dB)	-24.02	-23.10	4.0%
Impedance	47.3Ω+5.0 jΩ	48.2Ω+5.2 jΩ	0.9 Ω (Real part)

Return Loss

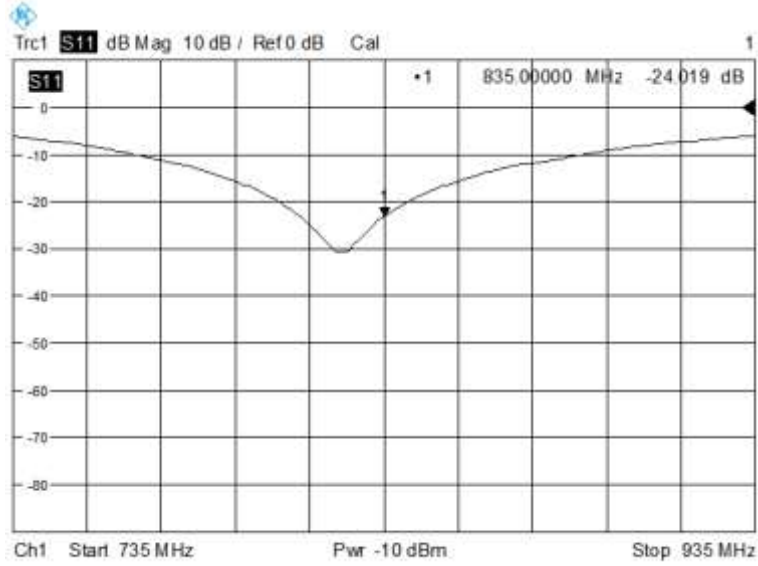

Impedance

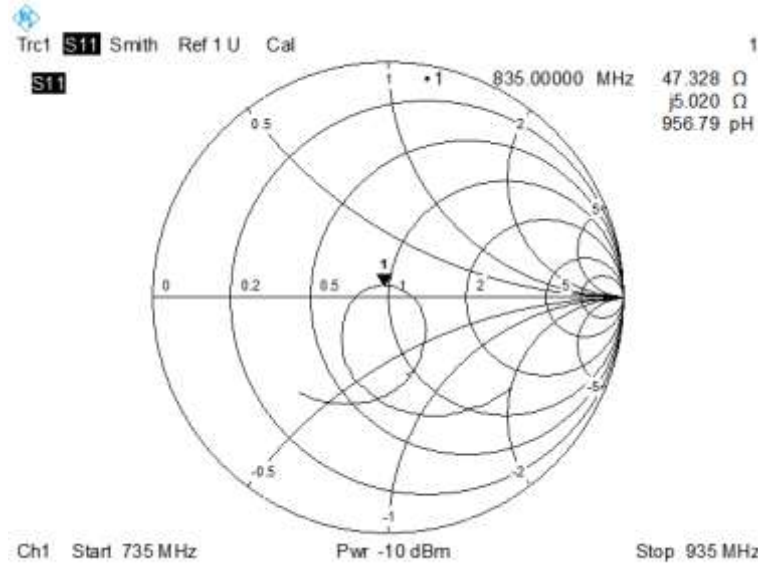



2.3 DIP 0G900

RETURN LOSS AND IMPEDANCE IN HEAD LIQUID

Meas. Results	Current Meas.	Previous Meas.	Max. Deviation
Return Loss(dB)	-30.91	-31.55	2.0%
Impedance	50.39 Ω - 2.4 j Ω	51.8 Ω - 2.1 j Ω	1.4 Ω (Real part)

Return Loss

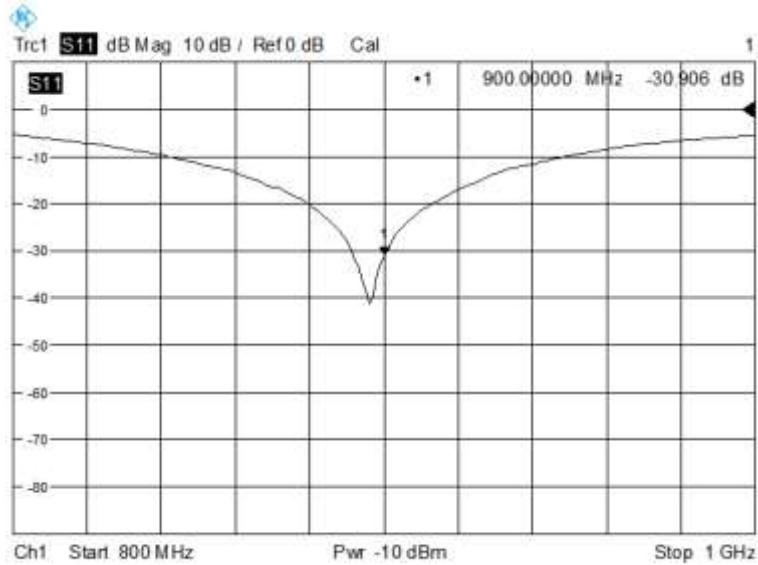

Impedance

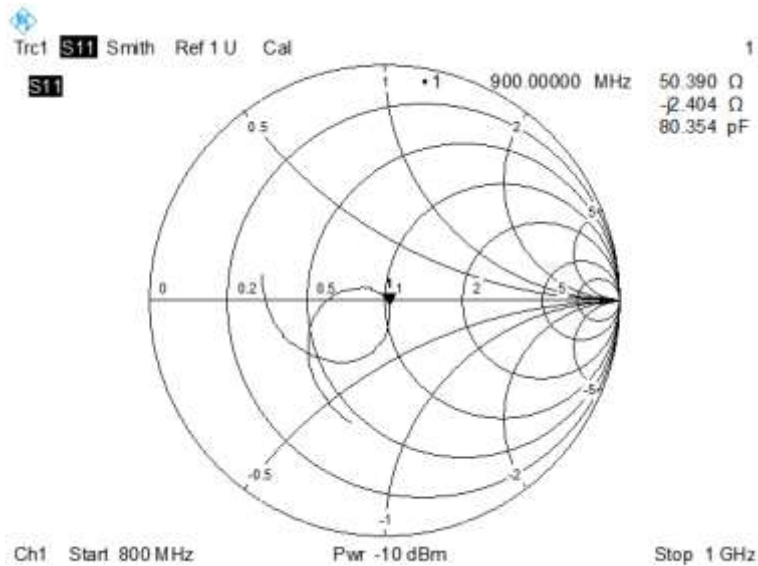

RETURN LOSS AND IMPEDANCE IN BODY LIQUID

Meas. Results	Current Meas.	Previous Meas.	Max. Deviation
Return Loss(dB)	-28.58	-27.62	3.5%
Impedance	54.4 Ω +2.1 j Ω	54.7 Ω +2.2 j Ω	0.3 Ω (Real part)

Return Loss

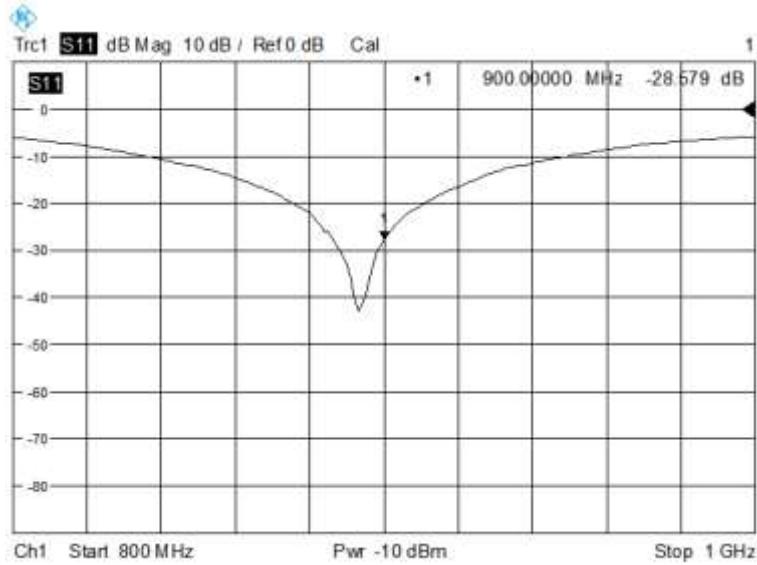

Impedance

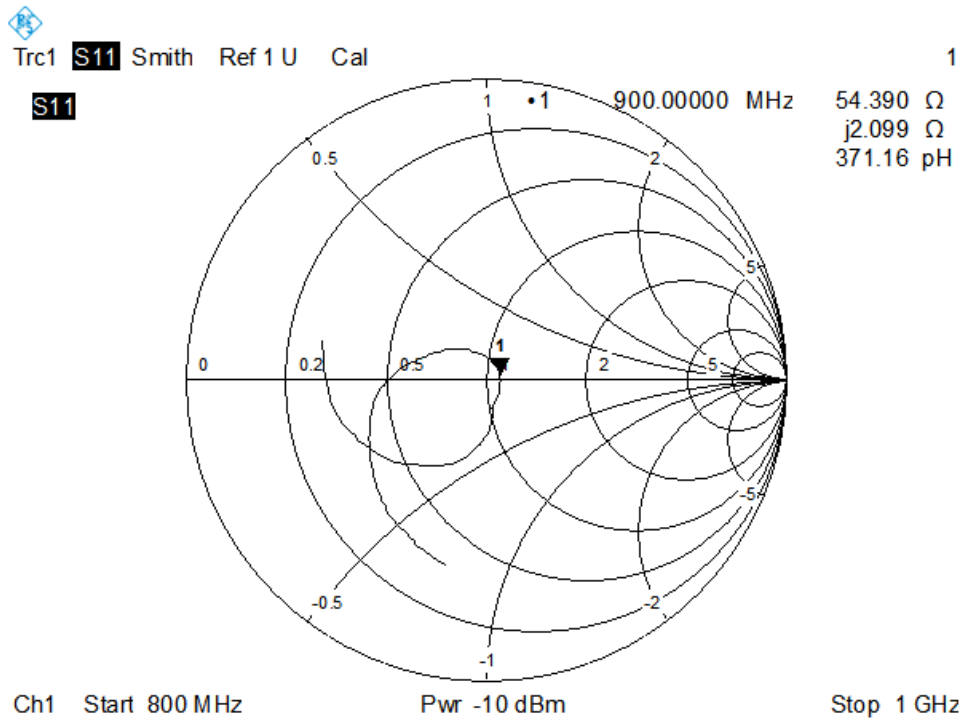

2.4 DIP 1G800

RETURN LOSS AND IMPEDANCE IN HEAD LIQUID

Meas. Results	Current Meas.	Previous Meas.	Max. Deviation
Return Loss(dB)	-23.52	-24.28	3.1%
Impedance	41.6Ω + 3.3 jΩ	44.8Ω + 3.9 jΩ	3.2 Ω (Real part)

Return Loss

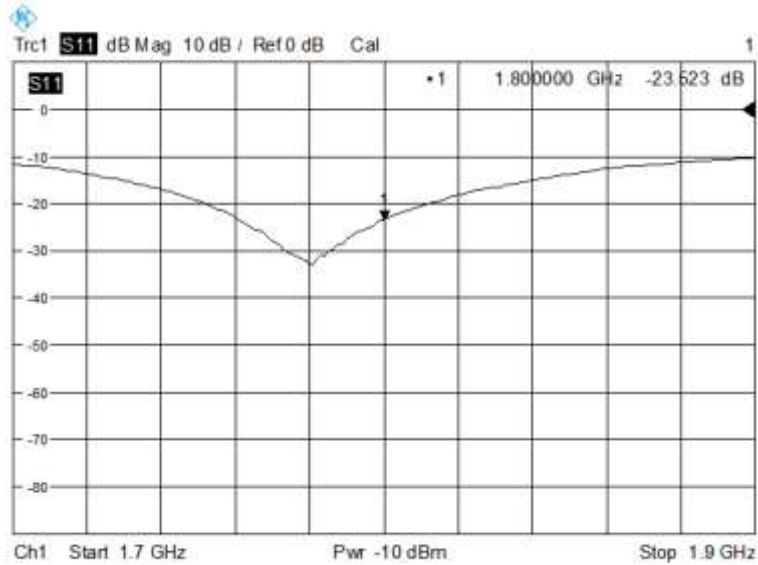

Impedance

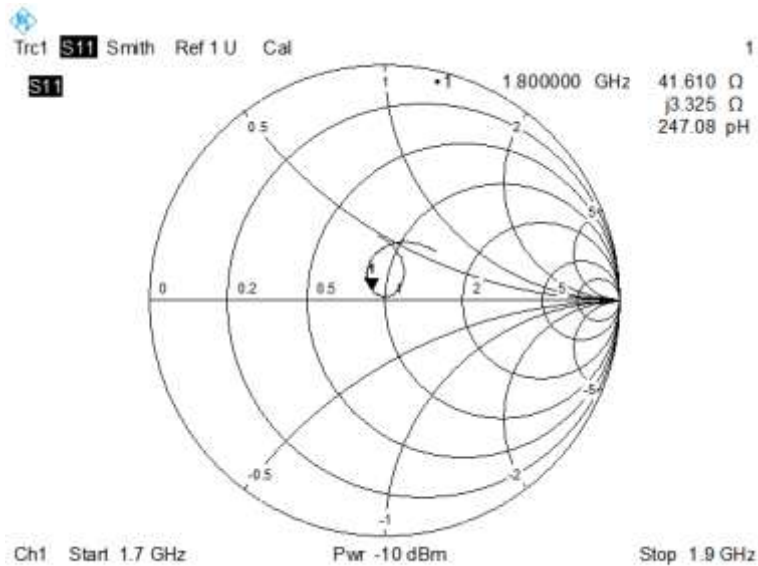

RETURN LOSS AND IMPEDANCE IN BODY LIQUID

Meas. Results	Current Meas.	Previous Meas.	Max. Deviation
Return Loss(dB)	-26.39	-27.41	3.7%
Impedance	46.0Ω +3.4 jΩ	47.8Ω +3.4 jΩ	1.8 Ω (Real part)

Return Loss

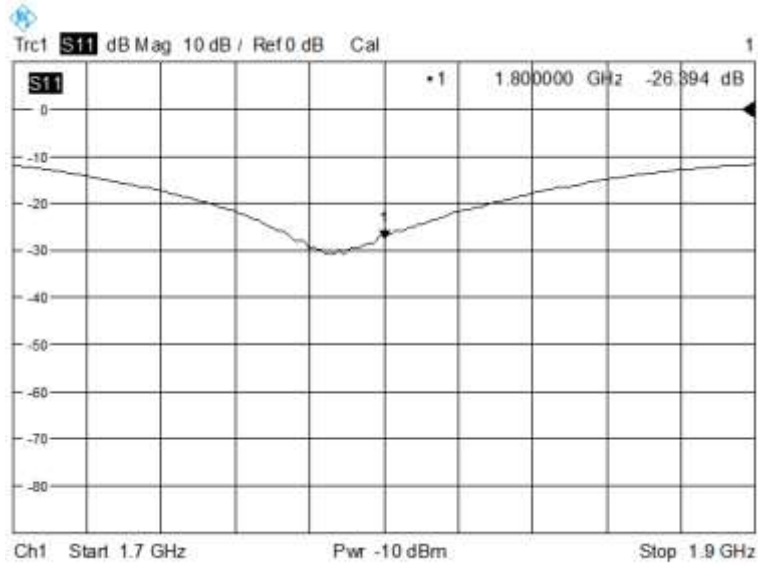

Impedance

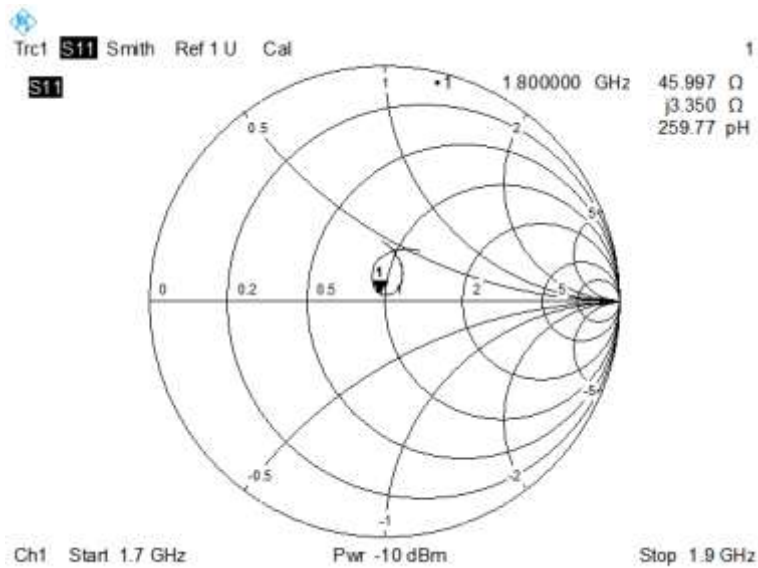

2.5 DIP 1G900

RETURN LOSS AND IMPEDANCE IN HEAD LIQUID

Meas. Results	Current Meas.	Previous Meas.	Max. Deviation
Return Loss(dB)	-27.40	-23.59	16.2 %
Impedance	52.4Ω+6.6 jΩ	52.7Ω+8.0 jΩ	1.4 Ω (Imaginary part)

Return Loss

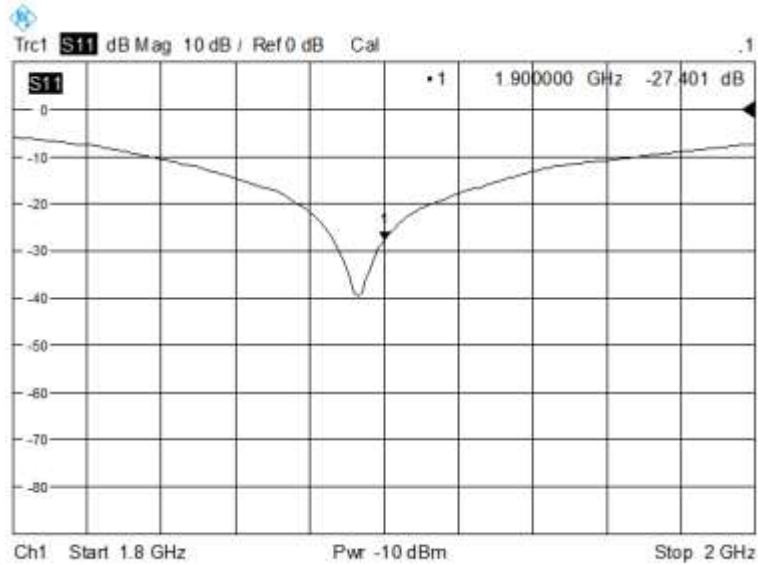

Impedance

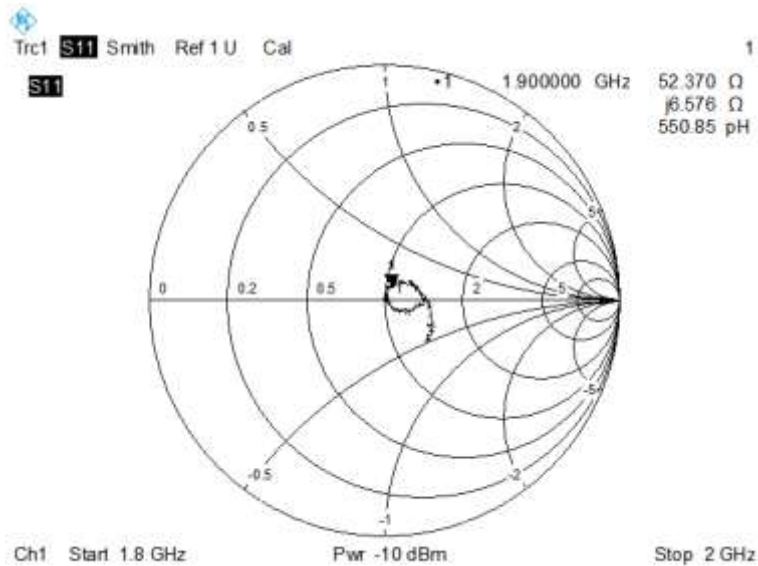



RETURN LOSS AND IMPEDANCE IN BODY LIQUID

Meas. Results	Current Meas.	Previous Meas.	Max. Deviation
Return Loss(dB)	-25.02	-22.29	12.2 %
Impedance	50.4 Ω +6.6 j Ω	47.6 Ω +4.5 j Ω	2.8 Ω (Real part)

Return Loss

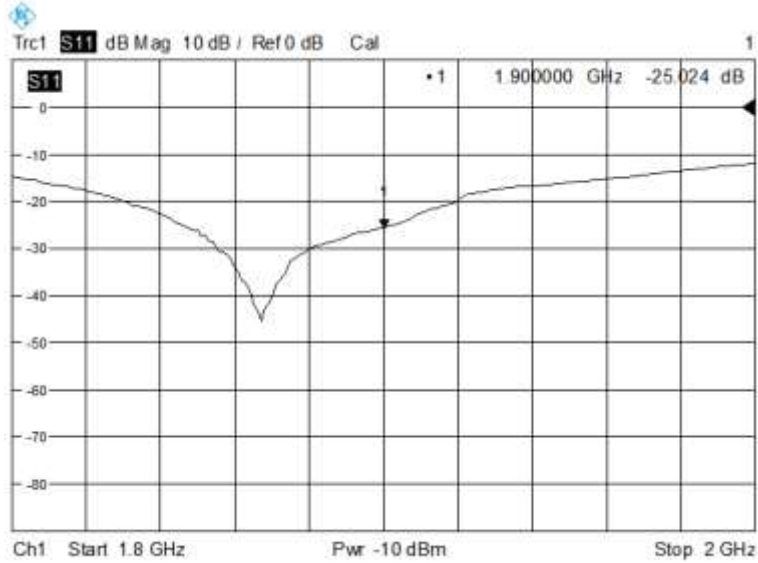

Impedance

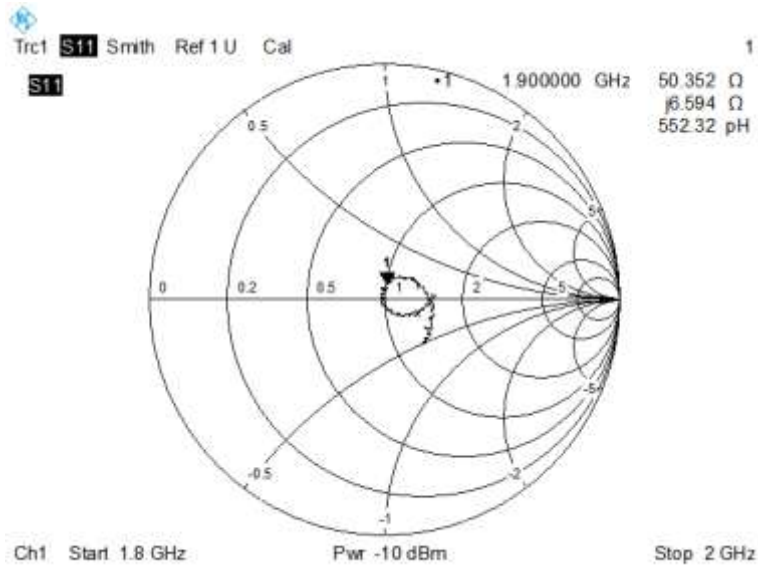

2.6 DIP 2G000

RETURN LOSS AND IMPEDANCE IN HEAD LIQUID

Meas. Results	Current Meas.	Previous Meas.	Max. Deviation
Return Loss(dB)	-24.19	-25.10	3.6%
Impedance	$53.8\Omega - 1.0\text{ j}\Omega$	$55.7\Omega - 1.2\text{ j}\Omega$	1.9 Ω (Real part)

Return Loss

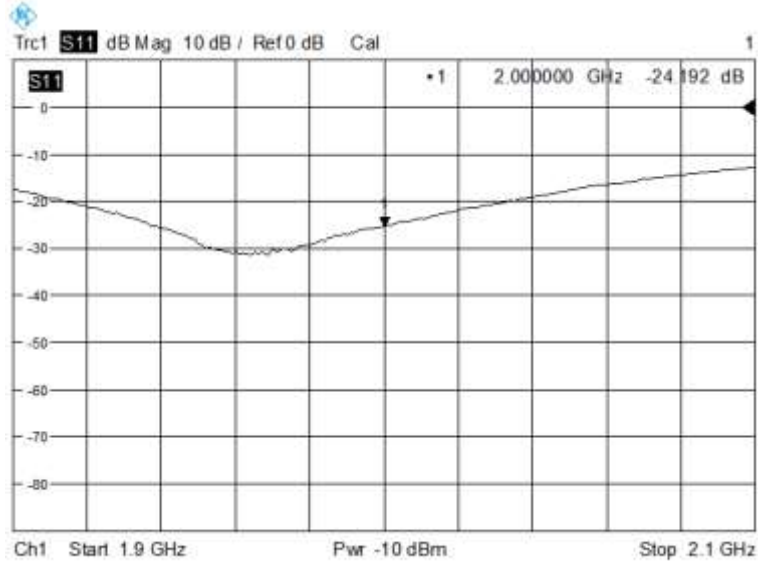

Impedance

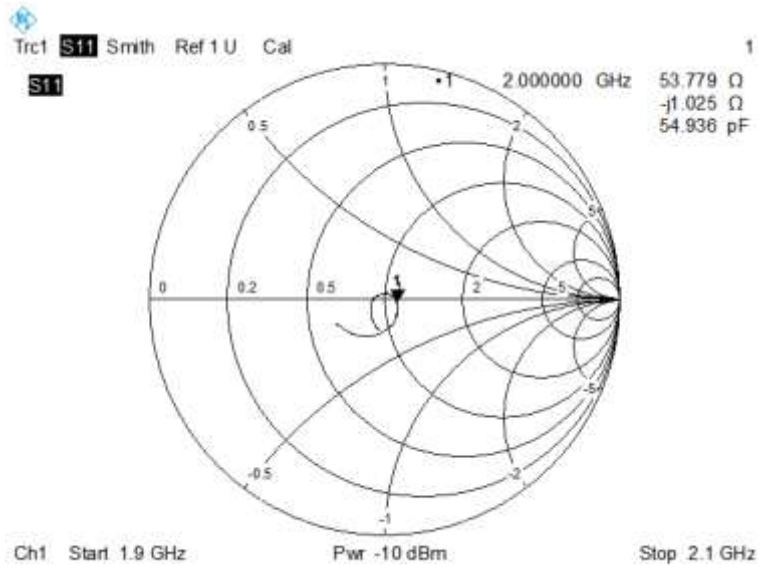



RETURN LOSS AND IMPEDANCE IN BODY LIQUID

Meas. Results	Current Meas.	Previous Meas.	Max. Deviation
Return Loss(dB)	-24.48	-25.32	3.3 %
Impedance	55.9Ω-0.3 jΩ	54.8Ω-0.4 jΩ	1.1 Ω (Real part)

Return Loss

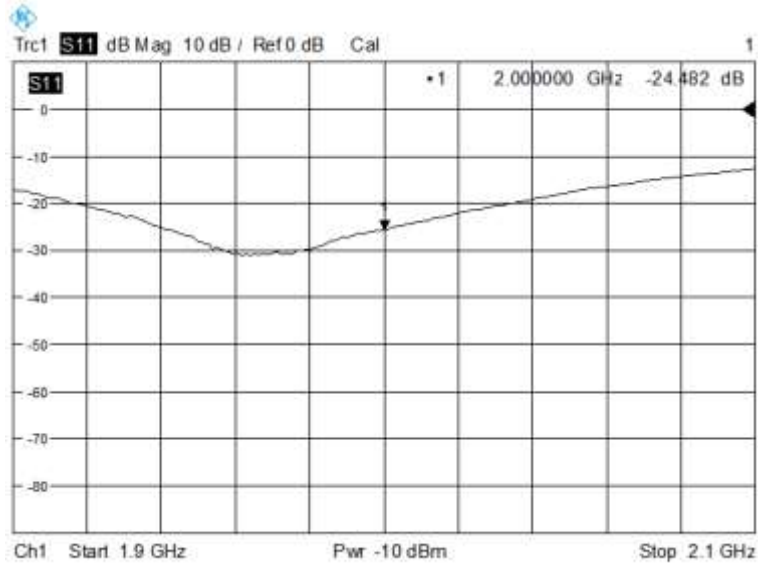

Impedance

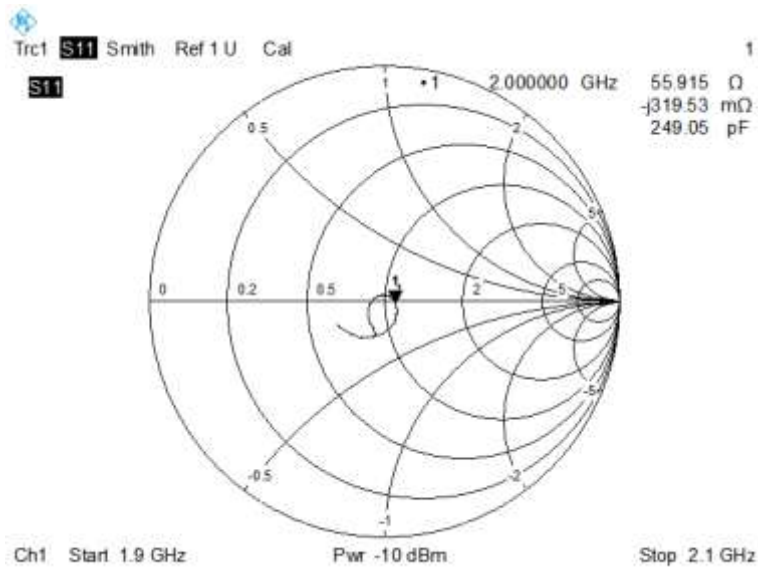

2.7 DIP 2G450

RETURN LOSS AND IMPEDANCE IN HEAD LIQUID

Meas. Results	Current Meas.	Previous Meas.	Max. Deviation
Return Loss(dB)	-24.10	-25.06	3.8 %
Impedance	43.2 Ω + 1.1 j Ω	44.3 Ω + 1.4 j Ω	1.1 Ω (Real part)

Return Loss

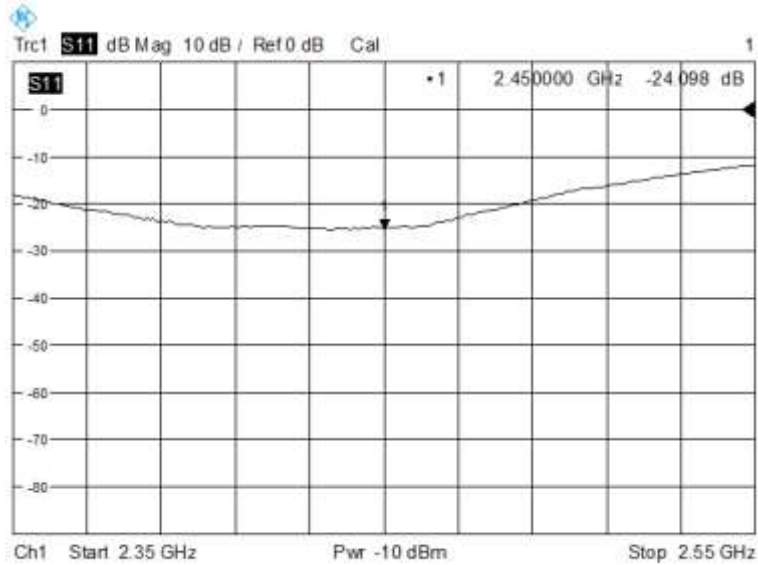

Impedance

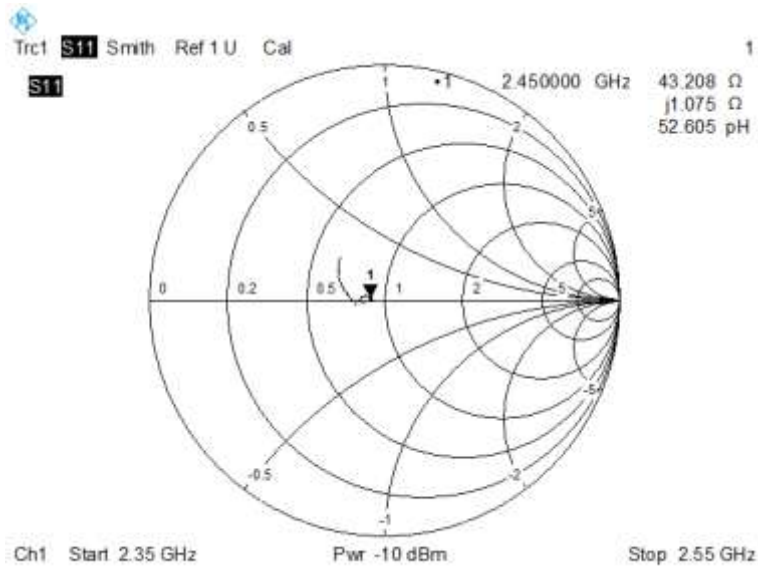

RETURN LOSS AND IMPEDANCE IN BODY LIQUID

Meas. Results	Current Meas.	Previous Meas.	Max. Deviation
Return Loss(dB)	-30.26	-31.03	2.5%
Impedance	50.8 Ω - 1.9 j Ω	48.7 Ω - 1.2 j Ω	2.1 Ω (Real part)

Return Loss

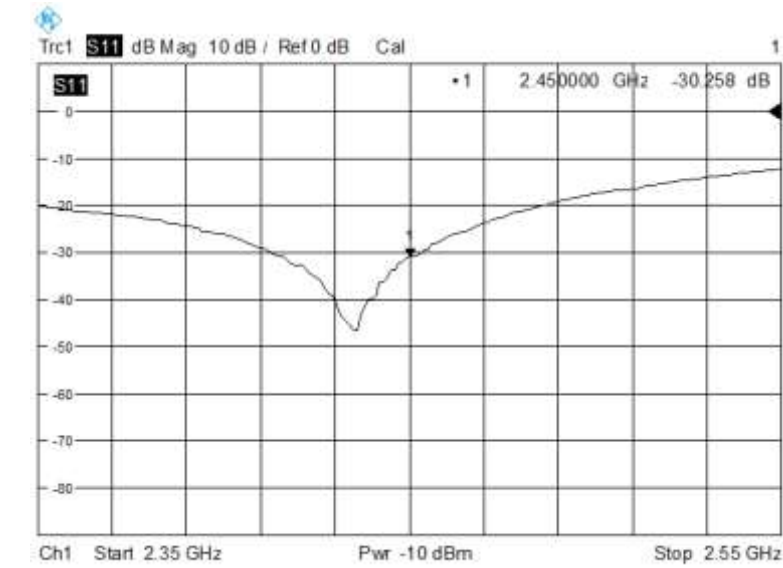

.0

Impedance

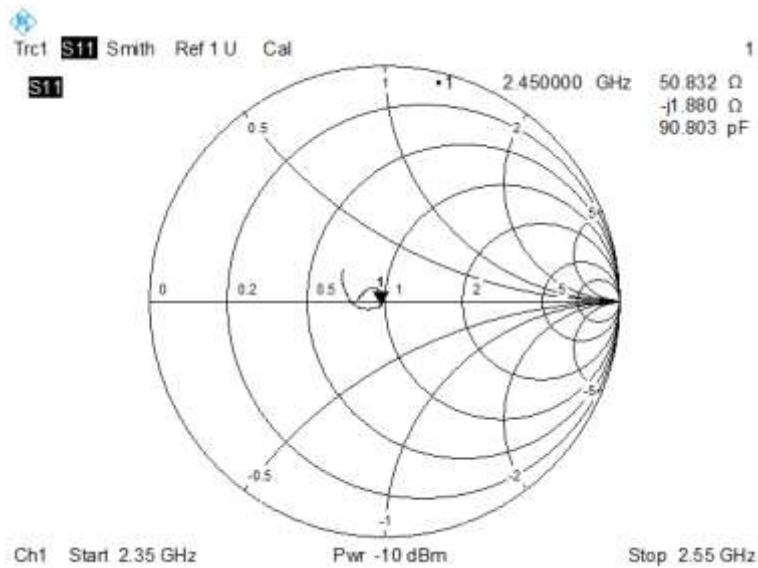

2.8 DIP 2G600

RETURN LOSS AND IMPEDANCE IN HEAD LIQUID

Meas. Results	Current Meas.	Previous Meas.	Max. Deviation
Return Loss(dB)	-21.23	-22.30	4.8%
Impedance	46.2 Ω +7.0 j Ω	47 Ω +7.8 j Ω	0.8 Ω (Imaginary part)

Return Loss

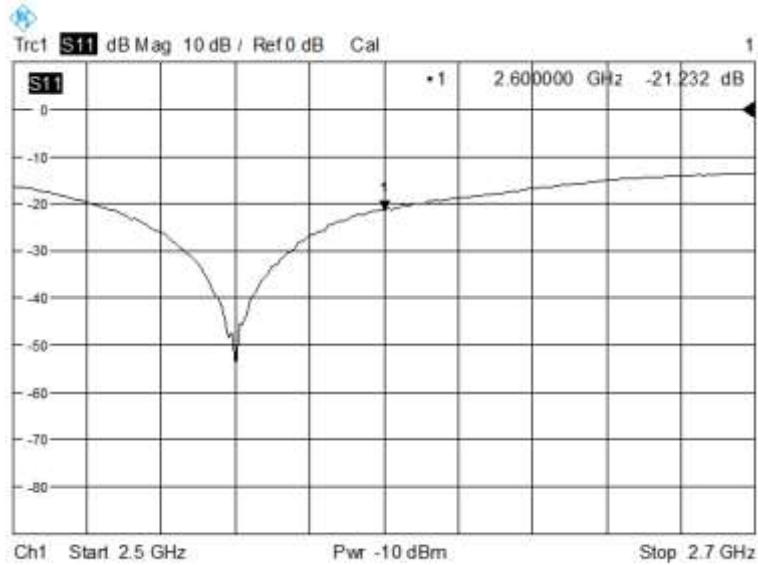

Impedance

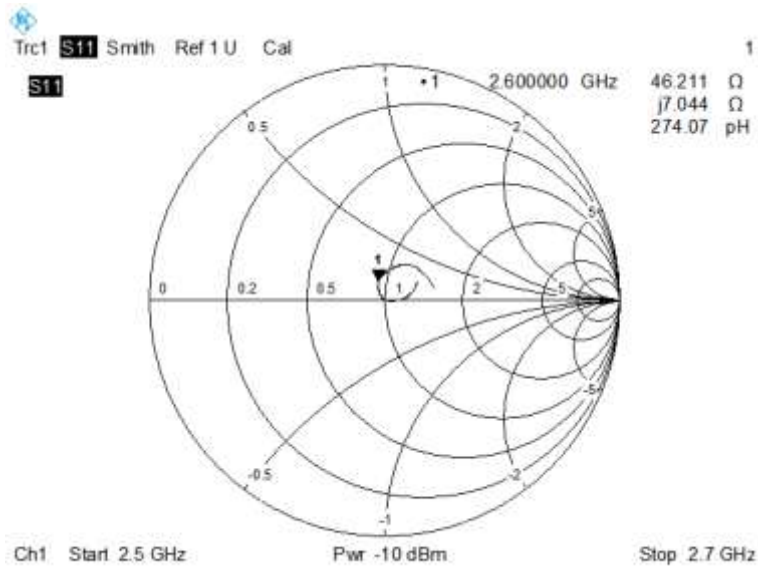

RETURN LOSS AND IMPEDANCE IN BODY LIQUID

Meas. Results	Current Meas.	Previous Meas.	Max. Deviation
Return Loss(dB)	-23.27	-22.37	4.0 %
Impedance	48.8Ω +5.0 jΩ	46.1Ω +6.4 jΩ	2.7 Ω (Real part)

Return Loss

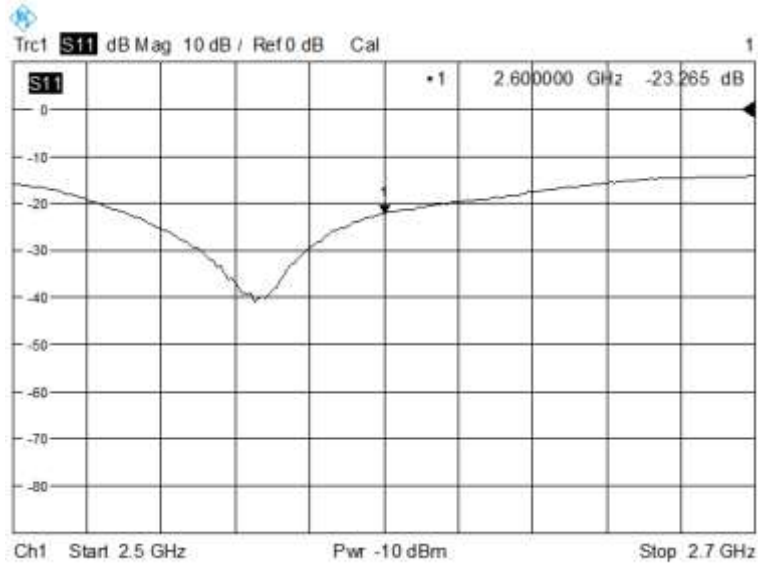

Impedance

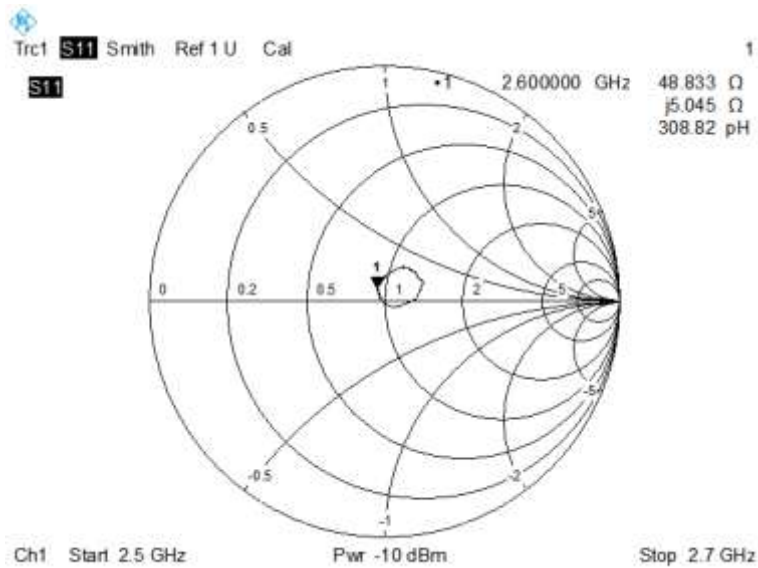

3 WAVEGUIDE IMPEDANCE AND RETURN LOSS

The waveguide are designed to have low return loss when presented against a flat phantom at the specified distance. A Vector Network Analyzer was used to perform a return loss measurement on the specific waveguide when in the measurement location against the phantom and the distance was specified by the manufacturer with a special, low loss and low relative permittivity spacer.

The impedance was measured at the SMA-connector with the network analyzer.

3.1 SWG5500

RETURN LOSS AND IMPEDANCE IN HEAD LIQUID

Frequency (MHz)	Return Loss(dB)	Requirement (dB)	Impedance
5200	-8.6	-8.0	30.6Ω+13.1jΩ
5400	-13.3	-8.0	73.0Ω-6.3jΩ
5600	-14.7	-8.0	36.8Ω-1.1jΩ
5800	-13.0	-8.0	65.2Ω+7.8jΩ

Return Loss

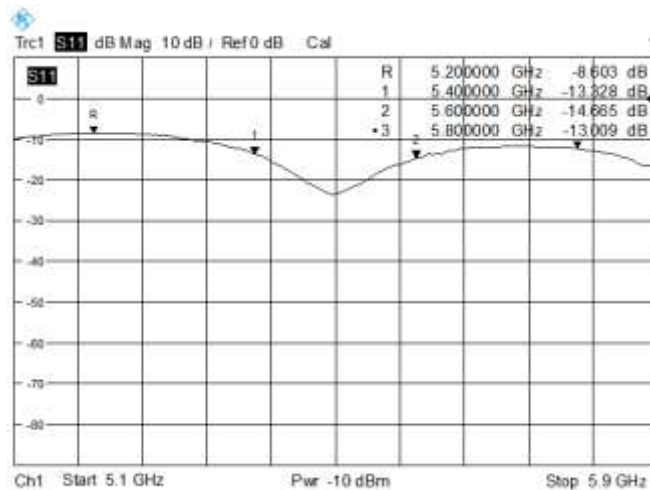

Impedance

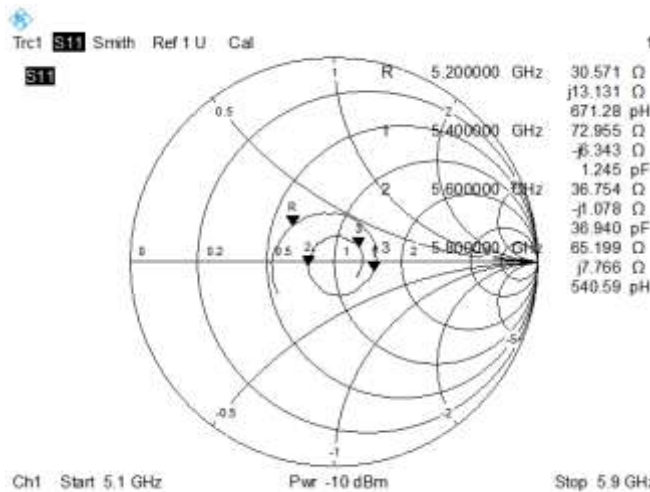

RETURN LOSS AND IMPEDANCE IN BODY LIQUID

Frequency (MHz)	Return Loss(dB)	Requirement (dB)	Impedance
5200	-10.5	-8.0	32.1Ω+14.5jΩ
5400	-12.5	-8.0	78.8Ω-9.9jΩ
5600	-15.4	-8.0	37.9Ω-3.0jΩ
5800	-15.5	-8.0	63.4Ω+13.8jΩ

Return Loss

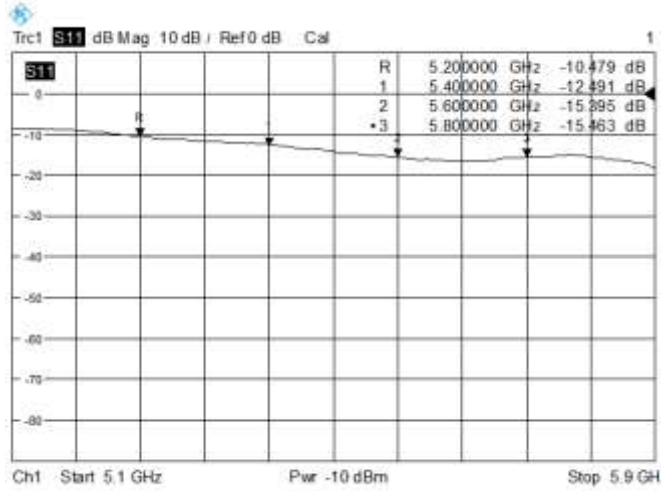

Impedance

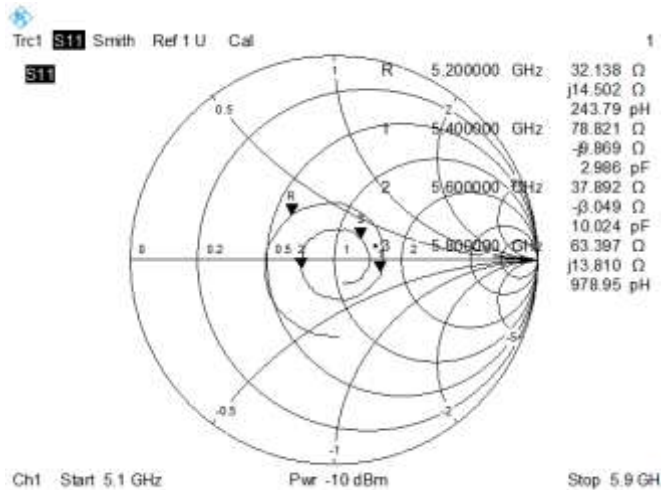

4 VALIDATION MEASUREMENT

The IEEE Std. 1528, FCC KDBs and CEI/IEC 62209 standards state that the system validation measurements must be performed using a reference dipole meeting the fore mentioned return loss and mechanical dimension requirements. The validation measurement must be performed against a liquid filled flat phantom, with the phantom constructed as outlined in the fore mentioned standards. Per the standards, the dipole shall be positioned below the bottom of the phantom, with the dipole length centered and parallel to the longest dimension of the flat phantom, with the top surface of the dipole at the described distance from the bottom surface of the phantom.

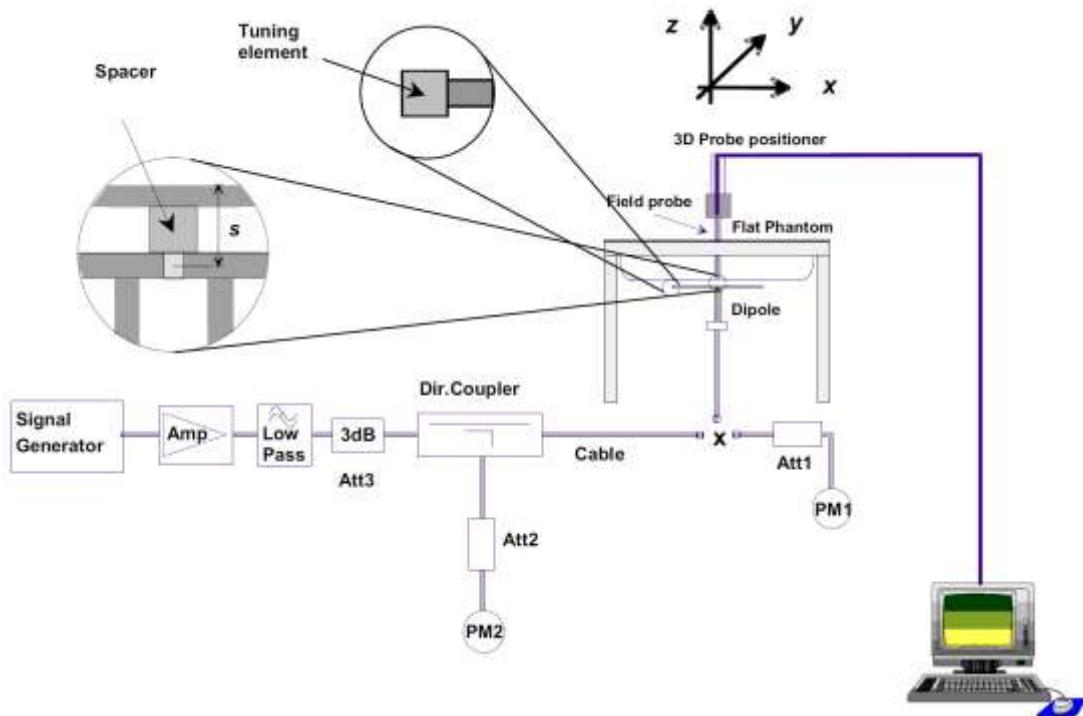



4.1 Simulating Liquid Verification

Liquid Type	Fre. (MHz)	Meas. Conductivity (σ) (S/m)	Meas. Permittivity (ϵ)	Target Conductivity (σ) (S/m)	Target Permittivity (ϵ)	Conductivity Tolerance (%)	Permittivity Tolerance (%)
Head	750	0.87	42.74	0.89	41.94	1.91	-2.25
Body		0.98	56.98	0.96	55.53	2.61	2.08
Head	835	0.89	41.58	0.90	41.50	0.19	-1.11
Body		0.99	56.24	0.97	55.20	1.88	2.06
Head	900	0.98	40.94	0.97	41.50	-1.35	1.03
Body		1.09	55.43	1.05	55.00	0.78	3.81
Head	1800	1.38	41.52	1.40	40.00	3.80	-1.43
Body		1.48	52.99	1.52	53.30	-0.58	-2.63
Head	1900	1.39	40.86	1.40	40.00	2.15	-0.71
Body		1.49	51.87	1.52	53.30	-2.68	-1.97
Head	2000	1.41	40.39	1.40	40.00	0.98	0.71
Body		1.51	50.91	1.52	53.30	-4.48	-0.66
Head	2450	1.84	38.55	1.80	39.20	-1.66	2.22
Body		1.97	51.35	1.95	52.70	-2.56	1.03
Head	2600	1.94	37.95	1.96	39.01	-2.72	-1.02
Body		2.11	50.68	2.16	52.51	-3.49	-2.31
Head	5200	4.72	35.86	4.66	35.99	-0.36	1.29
Body		5.25	50.35	5.30	49.01	2.73	-0.94
Head	5400	4.95	35.33	4.86	35.76	-1.20	1.85
Body		5.56	49.30	5.53	48.74	1.15	0.54
Head	5600	5.17	34.75	5.07	35.53	-2.20	1.97
Body		5.91	48.11	5.77	48.47	-0.74	2.43
Head	5800	5.40	33.92	5.27	35.30	-3.91	2.47
Body		6.18	46.94	6.00	48.20	-2.61	3.00



4.2 Dipole and Waveguide SAR Validation Measurement Result

Freq. (MHz)	Liquid Type	Power (mW)	1 g Measured SAR (W/kg)	Normalized SAR (W/kg)	10 g Measured SAR (W/kg)	Normalized SAR (W/kg)	1 g Targeted SAR (W/kg)	Tolerance (%)	10 g Targeted SAR (W/kg)	Tolerance (%)
750	Head	100	0.829	8.29	0.551	5.51	8.78	-5.58	5.72	-3.67
	Body	100	0.878	8.78	0.591	5.91	8.59	2.21	5.74	2.96
835	Head	100	0.972	9.72	0.644	6.44	9.58	1.46	6.10	5.57
	Body	100	1.031	10.31	0.672	6.72	9.78	5.42	6.39	5.16
900	Head	100	1.044	10.44	0.673	6.73	11.31	-7.69	6.98	-3.58
	Body	100	1.036	10.36	0.670	6.70	11.29	-8.24	7.21	-7.07
1800	Head	100	4.082	40.82	2.130	21.30	38.76	5.31	20.29	4.98
	Body	100	3.893	38.93	2.065	20.65	38.90	0.08	20.84	-0.91
1900	Head	100	3.759	37.59	1.981	19.81	39.49	-4.81	20.25	-2.17
	Body	100	4.172	41.72	2.146	21.46	40.01	4.27	20.84	2.98
2000	Head	100	4.402	44.02	2.211	22.11	43.26	1.76	21.18	4.39
	Body	100	4.436	44.36	2.224	22.24	41.93	5.80	21.11	5.35
2450	Head	100	5.068	50.68	2.328	23.28	54.31	-6.68	24.20	-3.80
	Body	100	5.299	52.99	2.478	24.78	53.67	-1.27	24.37	1.68
2600	Head	100	5.658	56.58	2.525	25.25	56.32	0.46	24.55	2.85
	Body	100	5.613	56.13	2.514	25.14	55.20	1.68	24.62	2.11
5200	Head	100	15.803	158.03	5.397	53.97	161.03	-1.86	56.23	-4.02
	Body	100	15.817	158.17	5.415	54.15	158.91	-0.47	56.35	-3.90
5400	Head	100	17.203	172.03	5.795	57.95	168.17	2.30	57.98	-0.05
	Body	100	15.363	153.63	5.384	53.84	164.39	-6.55	57.72	-6.72
5600	Head	100	18.248	182.48	5.545	55.45	175.43	4.02	59.94	-7.49
	Body	100	16.737	167.37	5.658	56.58	170.90	-2.07	59.37	-4.70
5800	Head	100	18.468	184.68	6.035	60.35	182.30	1.31	61.84	-2.41
	Body	100	17.517	175.17	5.804	58.04	177.09	-1.08	61.19	-5.15

4.3 DIP 0G750

4.3.1 Dipole 750 MHz Validation Measurement for Head Tissue

System Performance Check Data(750 MHz Head)

Type: Phone measurement (Complete)
 E-Field Probe: SN 34/15 SSE2 EPGO265
 Area scan resolution: dx=8mm,dy=8mm
 Zoom scan resolution: dx=8mm, dy=8mm, dz=5mm
 Date of measurement: 2019.03.21
 Measurement duration: 13 minutes 41 seconds

Experimental conditions.

Phantom File	surf_sam_plan.txt
Phantom	Validation plane
Band	750MHz
Signal	CW
Frequency (MHz)	750.000000
Relative permittivity (real part)	42.743175
Conductivity (S/m)	0.874280
Power drift (%)	0.340000
Ambient Temperature:	22.3°C
Liquid Temperature:	21.1°C
ConvF:	1.89
Crest factor:	1:1

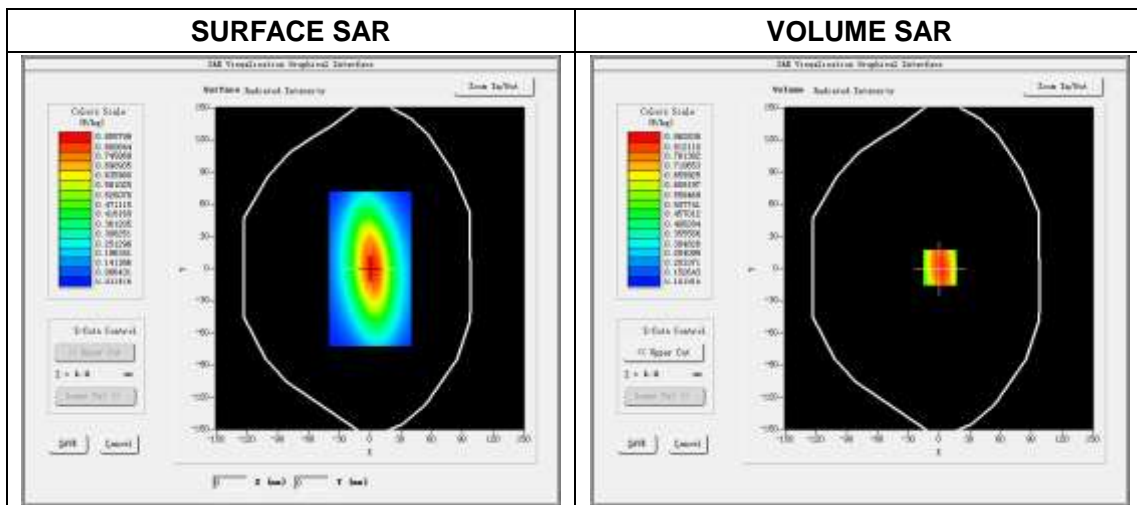

Maximum location: X=1.00, Y=1.00
 SAR Peak: 1.16 W/kg

SAR 10 g (W/Kg)	0.551374
SAR 1g (W/Kg)	0.828750

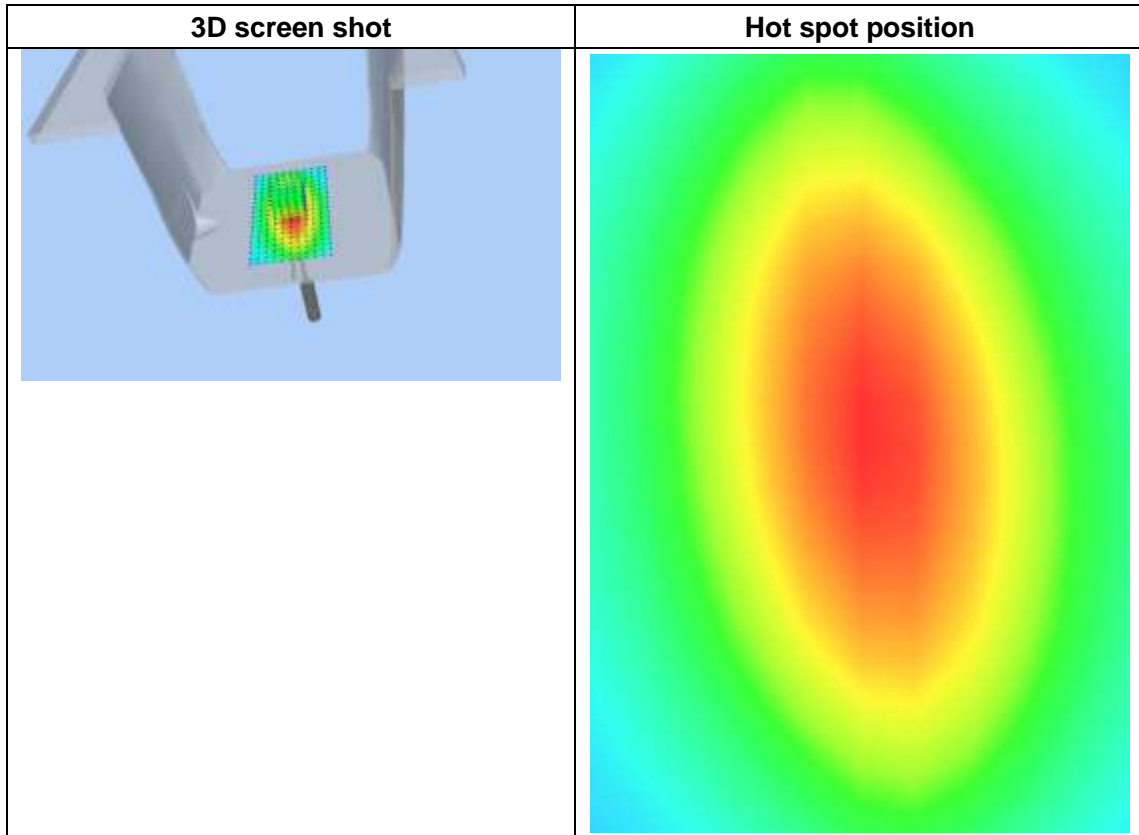
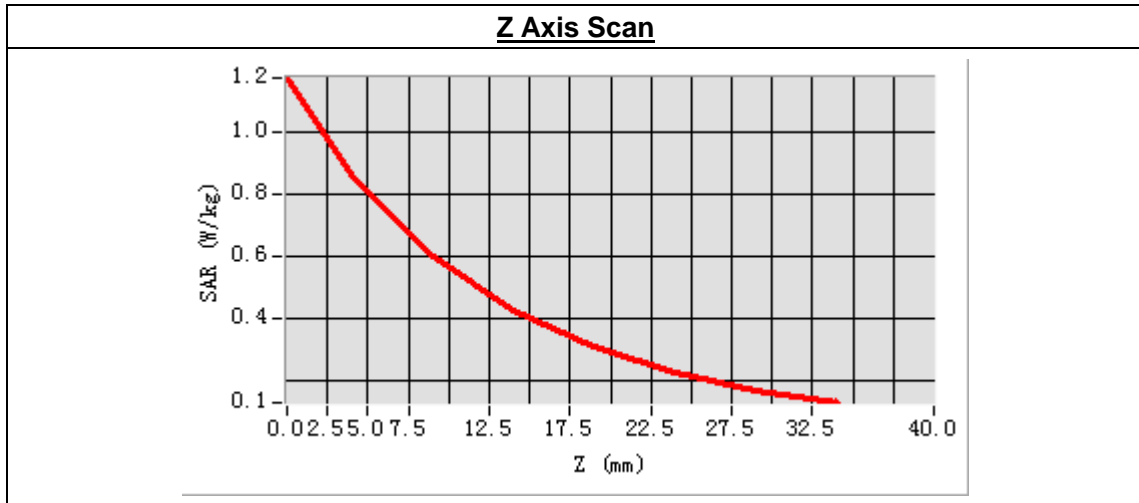

4.3.2 Dipole 750 MHz Validation Measurement for Body Tissue

System Performance Check Data(750 MHz Body)

Type: Phone measurement (Complete)
 E-Field Probe: SN 34/15SSE2 EPGO265
 Area scan resolution: dx=8mm,dy=8mm
 Zoom scan resolution: dx=8mm, dy=8mm, dz=5mm
 Date of measurement:2019.03.21
 Measurement duration: 13 minutes 43 seconds

Experimental conditions.

Phantom File	surf_sam_plan.txt
Phantom	Validation plane
Band	750MHz
Signal	CW
Frequency (MHz)	750.000000
Relative permittivity (real part)	56.981305
Conductivity (S/m)	0.976372
Power drift (%)	-0.090000
Ambient Temperature:	22.3°C
Liquid Temperature:	21.1°C
ConvF:	1.96
Crest factor:	1:1

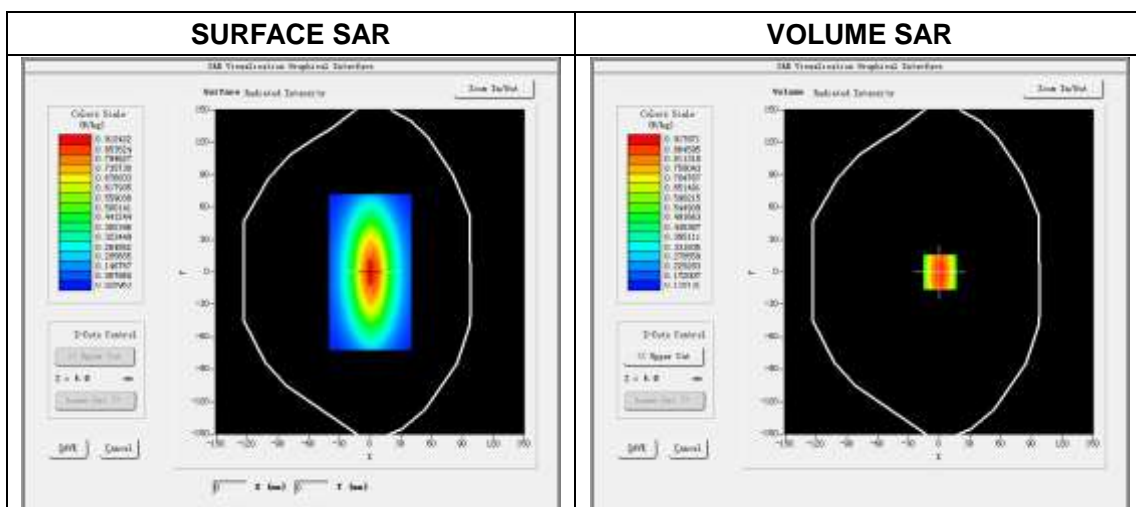

Maximum location: X=1.00, Y=0.00

SAR Peak: 1.19 W/kg

SAR 10 g (W/Kg)	0.590582
SAR 1g (W/Kg)	0.878134

Z Axis Scan

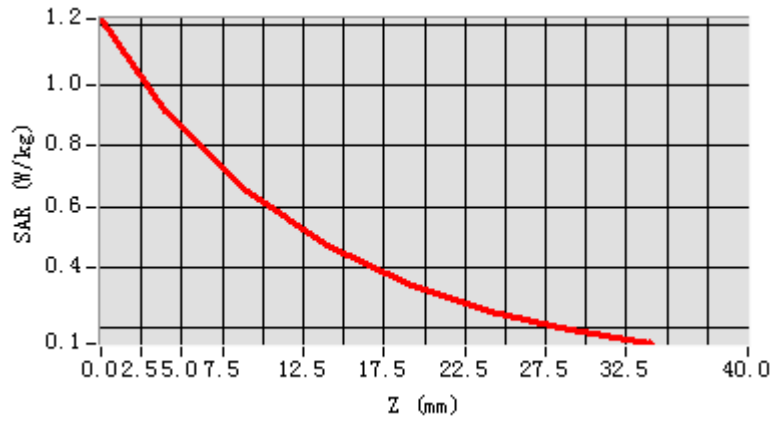

3D screen shot

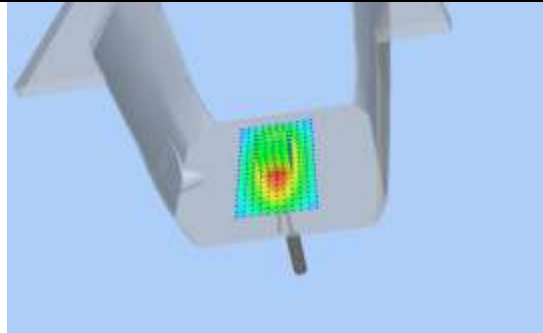

Hot spot position

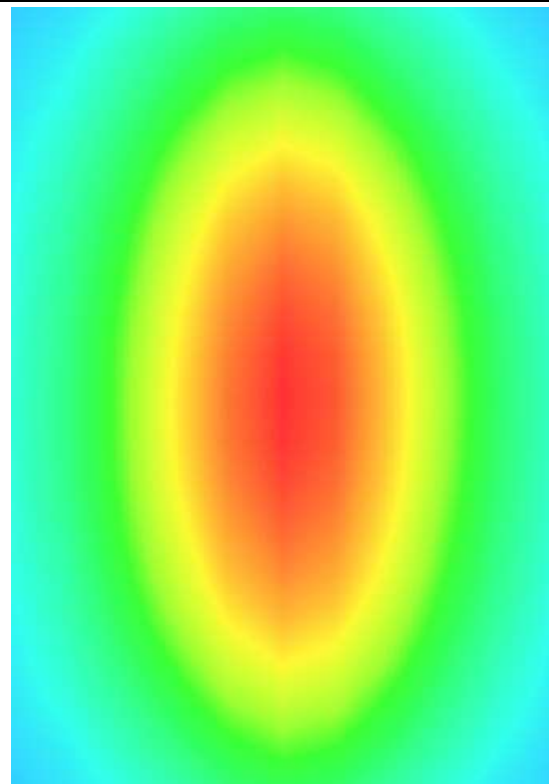

4.4 DIP 0G835

4.4.1 Dipole 835 MHz Validation Measurement for Head Tissue

System Performance Check Data(835 MHz Head)

Type: Phone measurement (Complete)
 E-Field Probe: SN 34/15SSE2 EPGO265
 Area scan resolution: dx=8mm,dy=8mm
 Zoom scan resolution: dx=8mm, dy=8mm, dz=5mm
 Date of measurement: 2019.03.21
 Measurement duration: 13 minutes 54 seconds

Experimental conditions.

Phantom File	surf_sam_plan.txt
Phantom	Validation plane
Band	835 MHz
Signal	CW
Frequency (MHz)	835.000000
Relative permittivity (real part)	41.579051
Conductivity (S/m)	0.893249
Power drift (%)	0.130000
Ambient Temperature:	22.3°C
Liquid Temperature:	21.1°C
ConvF:	1.93
Crest factor:	1:1

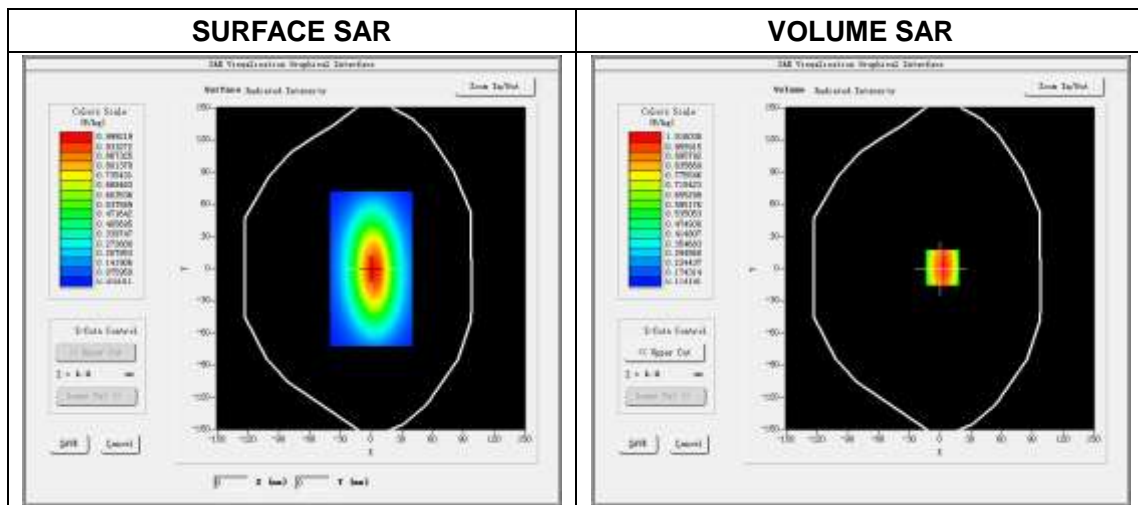

Maximum location: X=0.00, Y=0.00

SAR Peak: 1.36 W/kg

SAR 10 g (W/Kg)	0.643850
SAR 1g (W/Kg)	0.972256

Z Axis Scan

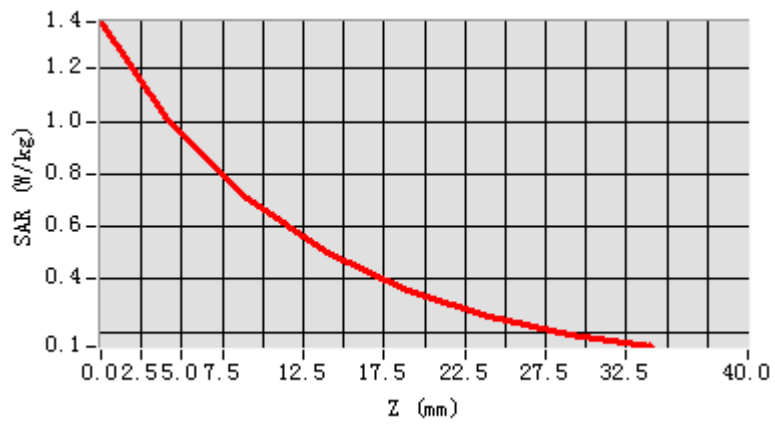

3D screen shot

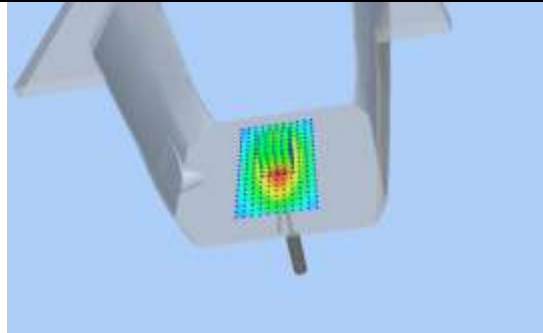

Hot spot position

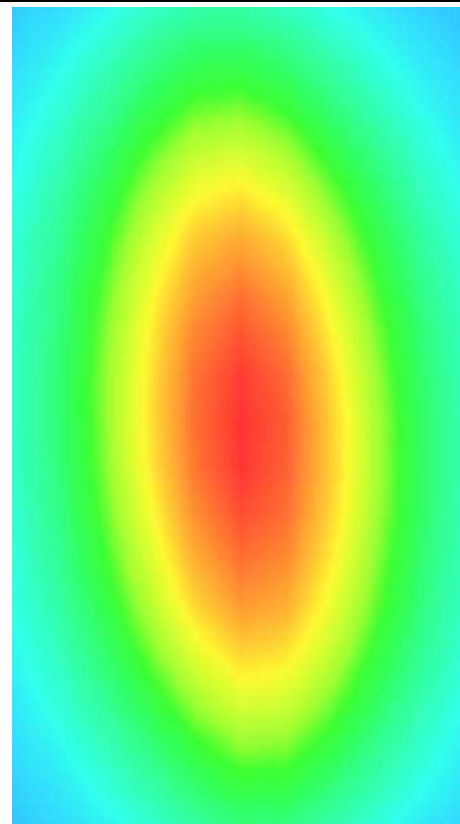

4.4.2 Dipole 835 MHz Validation Measurement for Body Tissue

System Performance Check Data(835 MHz Body)

Type: Phone measurement (Complete)
 E-Field Probe: SN 34/15 SSE2 EPGO265
 Area scan resolution: dx=8mm,dy=8mm
 Zoom scan resolution: dx=8mm, dy=8mm, dz=5mm
 Date of measurement:2019.03.21
 Measurement duration: 13 minutes 54 seconds

Experimental conditions.

Phantom File	surf_sam_plan.txt
Phantom	Validation plane
Band	835MHz
Signal	CW
Frequency (MHz)	835.000000
Relative permittivity (real part)	56.239253
Conductivity (S/m)	0.993138
Power drift (%)	-0.350000
Ambient Temperature:	22.3°C
Liquid Temperature:	21.1°C
ConvF:	1.98
Crest factor:	1:1

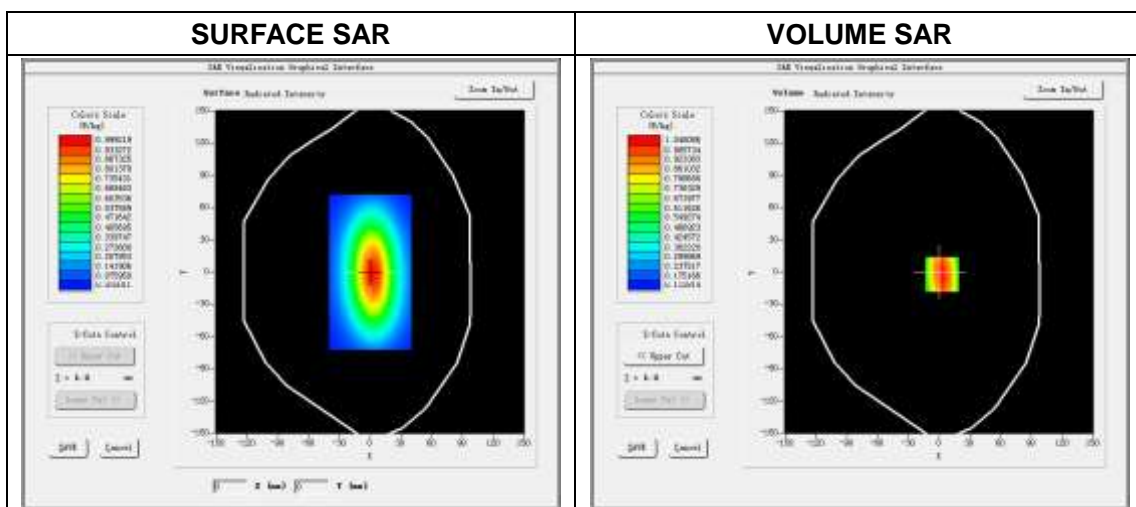

Maximum location: X=3.00, Y=-2.00

SAR Peak: 1.36 W/kg

SAR 10 g (W/Kg)	0.671632
SAR 1g (W/Kg)	1.030569

Z Axis Scan

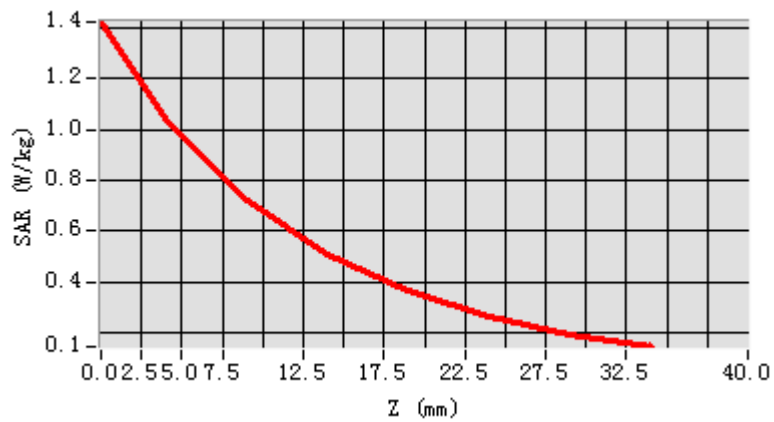

3D screen shot

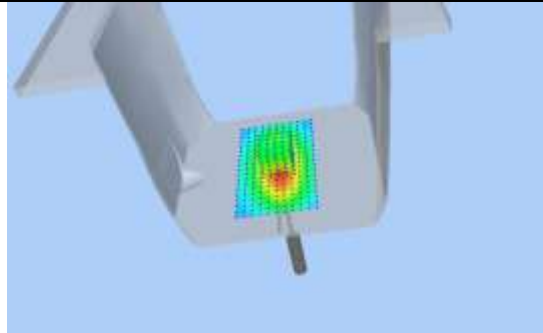

Hot spot position

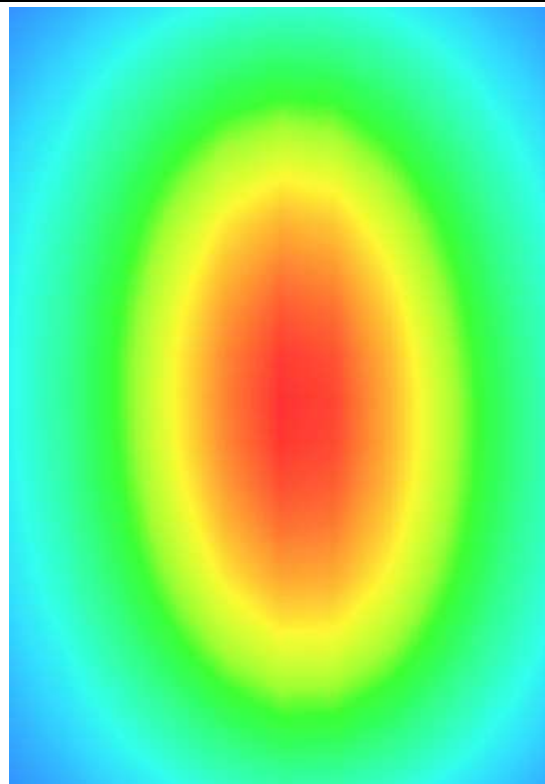

4.5 DIP 0G900

4.5.1 Dipole 900 MHz Validation Measurement for Head Tissue

System Performance Check Data(900 MHz Head)

Type: Phone measurement (Complete)
 E-Field Probe: SN 34/15 SSE2 EPGO265
 Area scan resolution: dx=8mm,dy=8mm
 Zoom scan resolution: dx=8mm, dy=8mm, dz=5mm
 Date of measurement:2019.03.21
 Measurement duration: 13 minutes 35 seconds

Experimental conditions.

Phantom File	surf_sam_plan.txt
Phantom	Validation plane
Band	900MHz
Signal	CW
Frequency (MHz)	900.000000
Relative permittivity (real part)	40.938260
Conductivity (S/m)	0.980352
Power drift (%)	-0.080000
Ambient Temperature:	22.3°C
Liquid Temperature:	21.1°C
ConvF:	1.95
Crest factor:	1:1

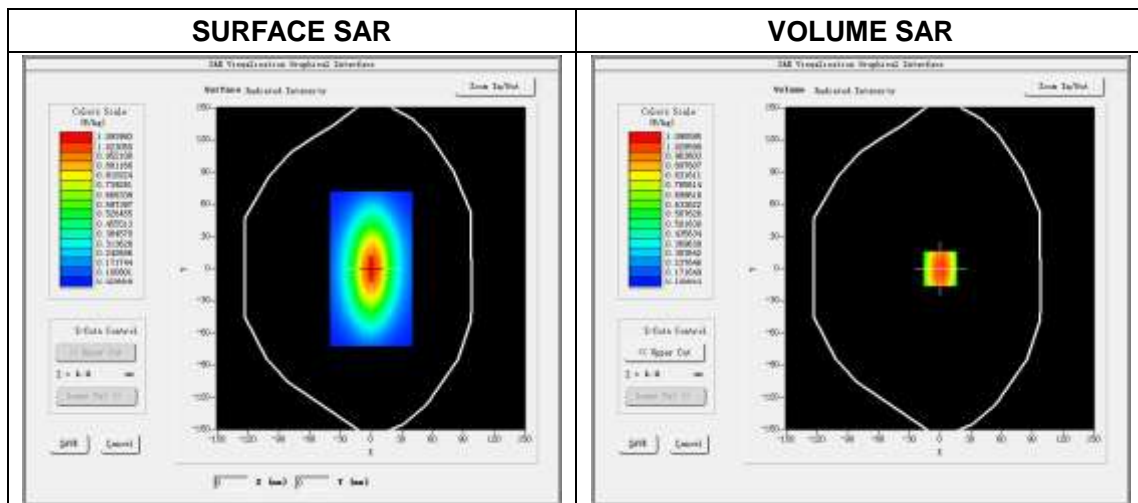

Maximum location: X=0.00, Y=0.00

SAR Peak: 1.48 W/kg

SAR 10 g (W/Kg)	0.672928
SAR 1g (W/Kg)	1.043652

Z Axis Scan

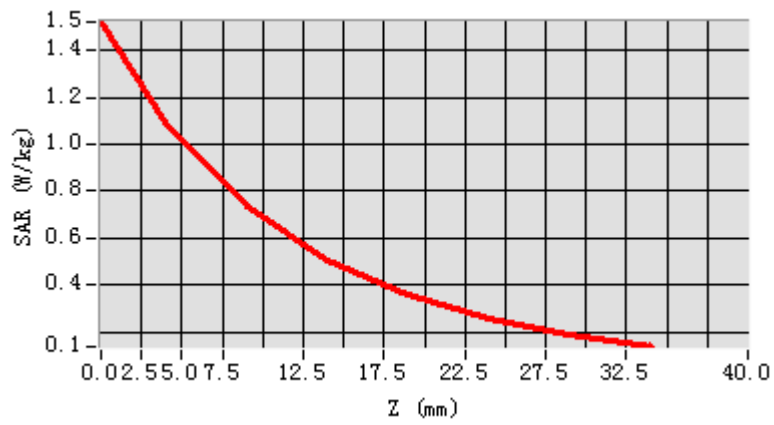

3D screen shot

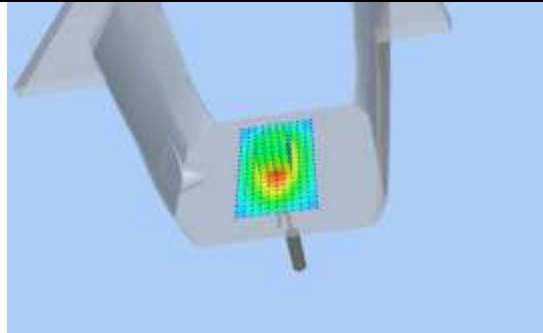

Hot spot position

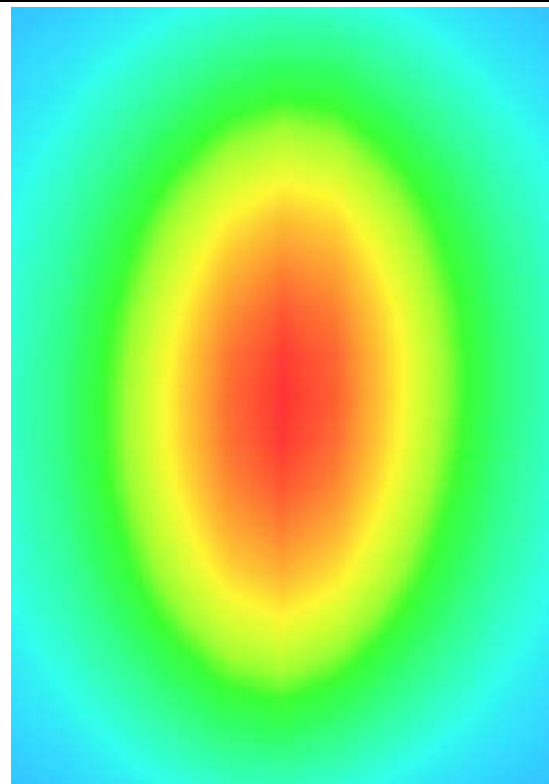

4.5.2 Dipole 900 MHz Validation Measurement for Body Tissue

System Performance Check Data(900 MHz Body)

Type: Phone measurement (Complete)
 E-Field Probe: SN 34/15SSE2 EPGO265
 Area scan resolution: dx=8mm,dy=8mm
 Zoom scan resolution: dx=8mm, dy=8mm, dz=5mm
 Date of measurement: 2019.03.21
 Measurement duration: 14 minutes 7 seconds

Experimental conditions.

Phantom File	surf_sam_plan.txt
Phantom	Validation plane
Band	900 MHz
Signal	CW
Frequency (MHz)	900.000000
Relative permittivity (real part)	55.431208
Conductivity (S/m)	1.087154
Power drift (%)	-0.140000
Ambient Temperature:	22.3°C
Liquid Temperature:	21.1C
ConvF:	2.02
Crest factor:	1:1

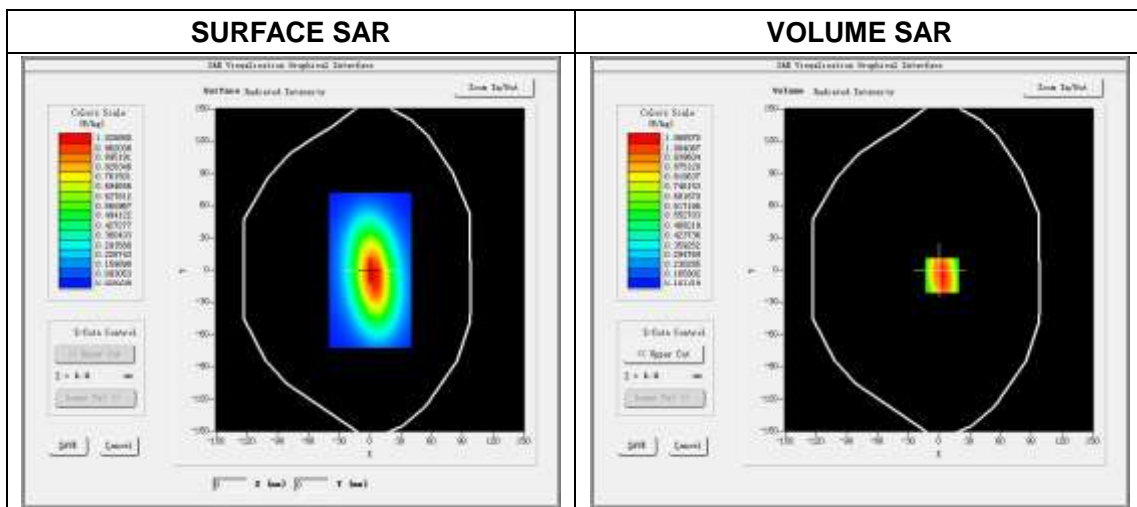

Maximum location: X=0.00, Y=0.00

SAR Peak: 1.49 W/kg

SAR 10 g (W/Kg)	0.670375
SAR 1g (W/Kg)	1.036038

Z Axis Scan

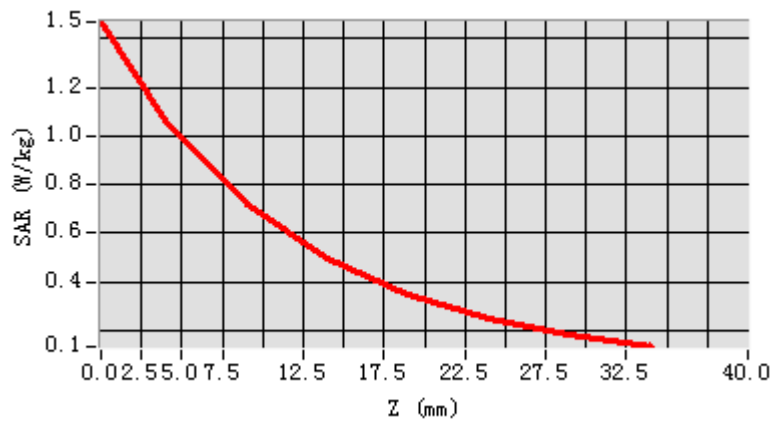

3D screen shot

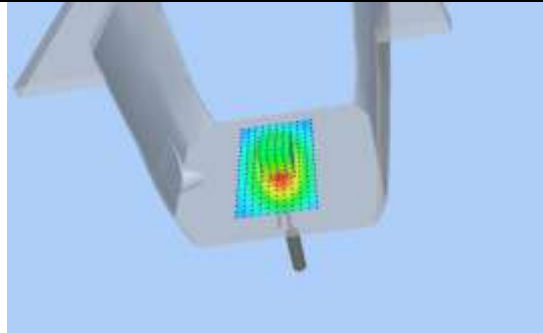

Hot spot position

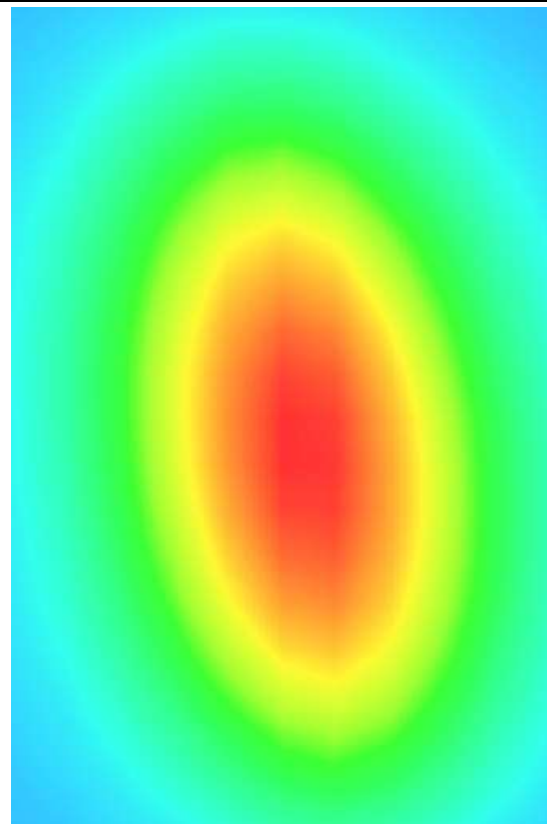

4.6 DIP 1G800

4.6.1 Dipole 1800 MHz Validation Measurement for Head Tissue

System Performance Check Data(1800 MHz Head)

Type: Phone measurement (Complete)
 E-Field Probe: SN 34/15 SSE2 EPGO265
 Area scan resolution: dx=8mm,dy=8mm
 Zoom scan resolution: dx=8mm, dy=8mm, dz=5mm
 Date of measurement:2019.03.19
 Measurement duration: 14 minutes 15 seconds

Experimental conditions.

Phantom File	surf_sam_plan.txt
Phantom	Validation plane
Band	1800MHz
Signal	CW
Frequency (MHz)	1800.000000
Relative permittivity (real part)	41.524163
Conductivity (S/m)	1.375105
Power drift (%)	-0.220000
Ambient Temperature:	22.2°C
Liquid Temperature:	20.9°C
ConvF:	2.18
Crest factor:	1:1

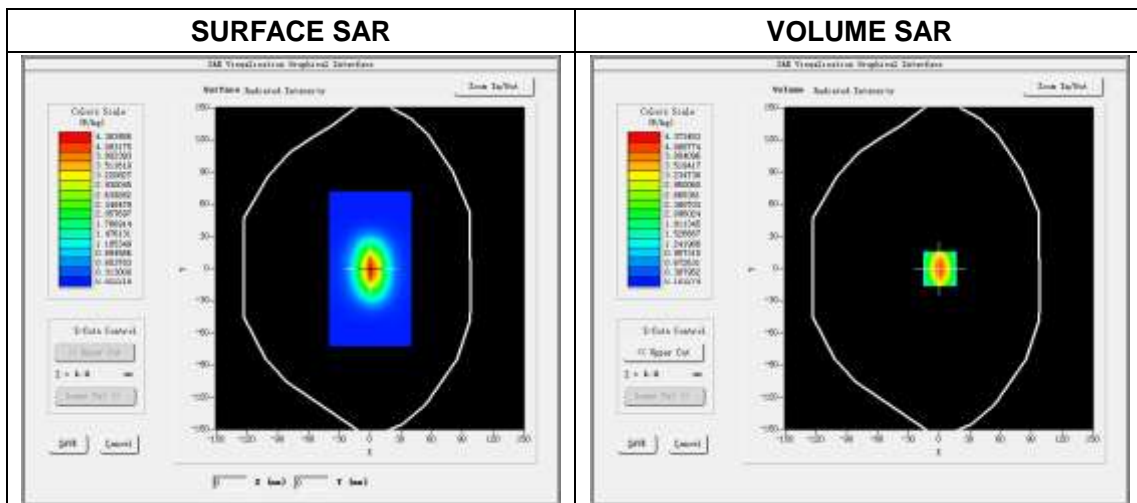

Maximum location: X=1.00, Y=0.00

SAR Peak: 6.85 W/kg

SAR 10 g (W/Kg)	2.130358
SAR 1g (W/Kg)	4.081673

Z Axis Scan

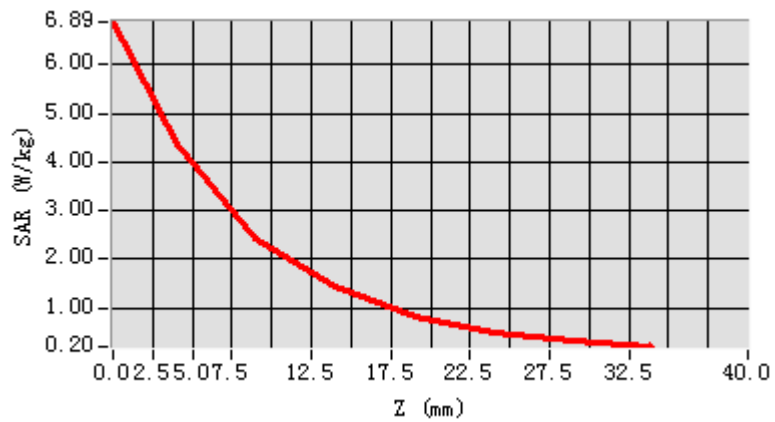

3D screen shot

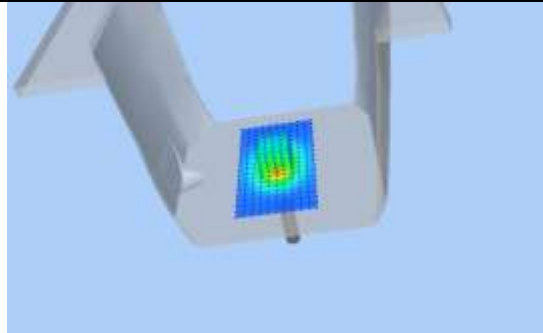

Hot spot position

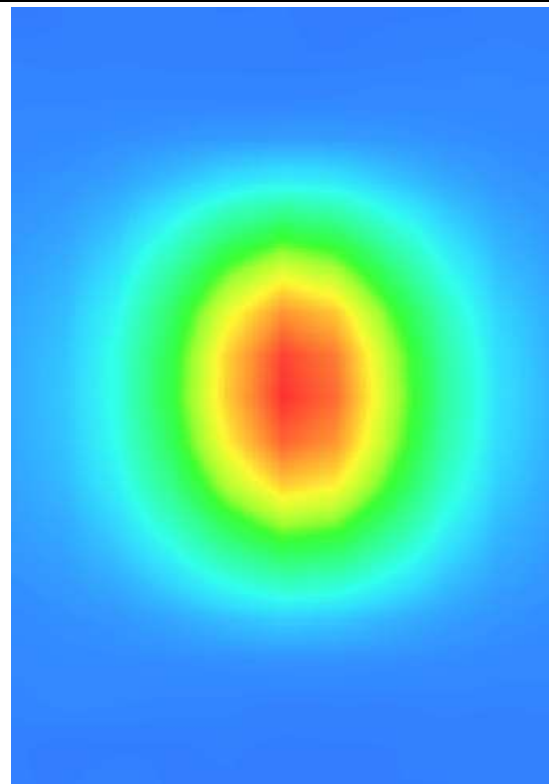

4.6.2 Dipole 1800 MHz Validation Measurement for Body Tissue

System Performance Check Data(1800 MHz Body)

Type: Phone measurement (Complete)
 E-Field Probe: SN 34/15SSE2 EPGO265
 Area scan resolution: dx=8mm,dy=8mm
 Zoom scan resolution: dx=8mm, dy=8mm, dz=5mm
 Date of measurement:2019.03.19
 Measurement duration: 14 minutes 5 seconds

Experimental conditions.

Phantom File	surf_sam_plan.txt
Phantom	Validation plane
Band	1800MHz
Signal	CW
Frequency (MHz)	1800.000000
Relative permittivity (real part)	52.986371
Conductivity (S/m)	1.476350
Power drift (%)	-0.410000
Ambient Temperature:	22.2°C
Liquid Temperature:	20.9°C
ConvF:	2.25
Crest factor:	1:1

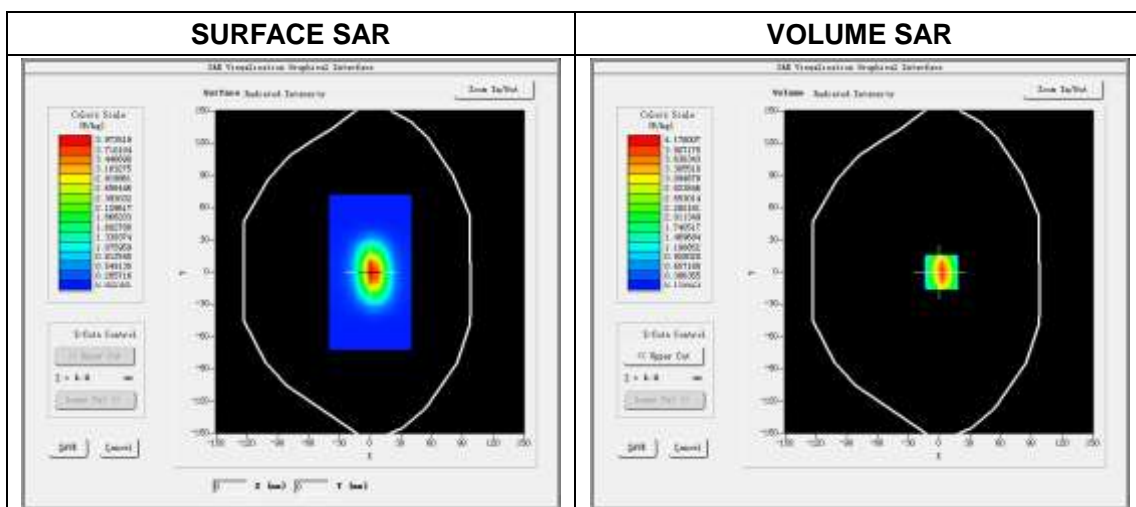

Maximum location: X=2.00, Y=0.00

SAR Peak: 6.36 W/kg

SAR 10 g (W/Kg)	2.065043
SAR 1g (W/Kg)	3.893028

Z Axis Scan

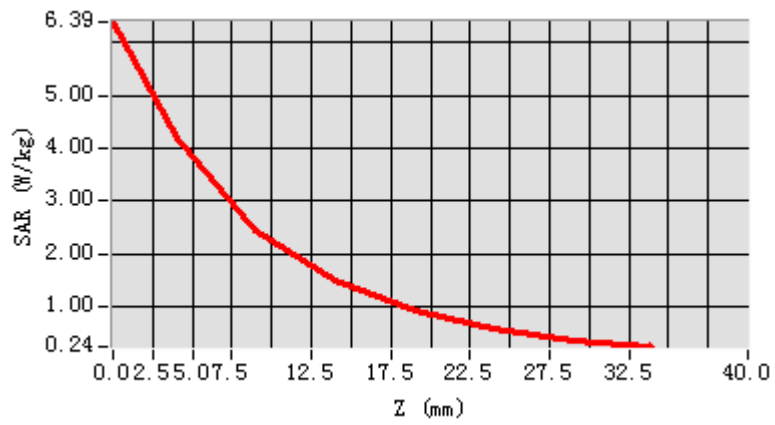

3D screen shot

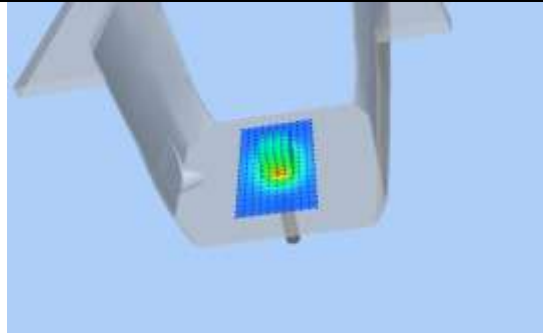

Hot spot position

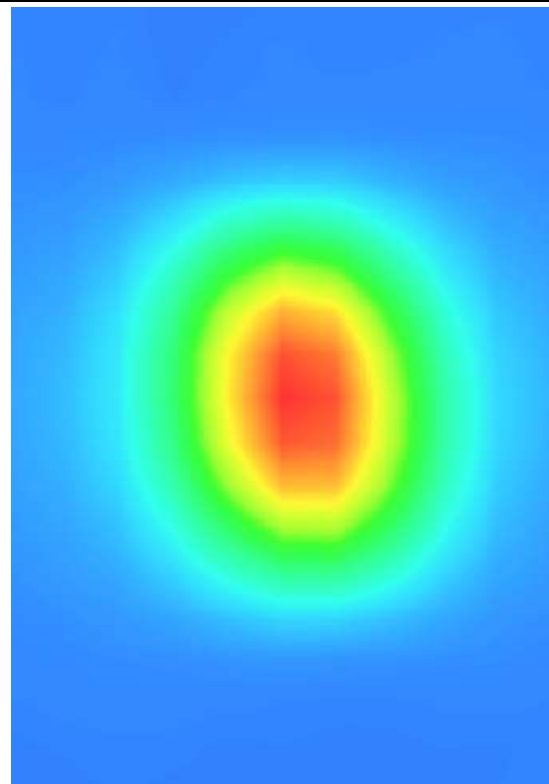

4.7 DIP 1G900

4.7.1 Dipole 1900 MHz Validation Measurement for Head Tissue

System Performance Check Data(1900 MHz Head)

Type: Phone measurement (Complete)
 E-Field Probe: SN 34/15 SSE2 EPGO265
 Area scan resolution: dx=8mm,dy=8mm
 Zoom scan resolution: dx=8mm, dy=8mm, dz=5mm
 Date of measurement: 2019.03.19
 Measurement duration: 14 minutes 34 seconds

Experimental conditions.

Phantom File	surf_sam_plan.txt
Phantom	Validation plane
Band	1900MHz
Signal	CW
Frequency (MHz)	1900.000000
Relative permittivity (real part)	40.858239
Conductivity (S/m)	1.392194
Power drift (%)	-0.850000
Ambient Temperature:	22.2°C
Liquid Temperature:	20.9°C
ConvF:	2.46
Crest factor:	1:1

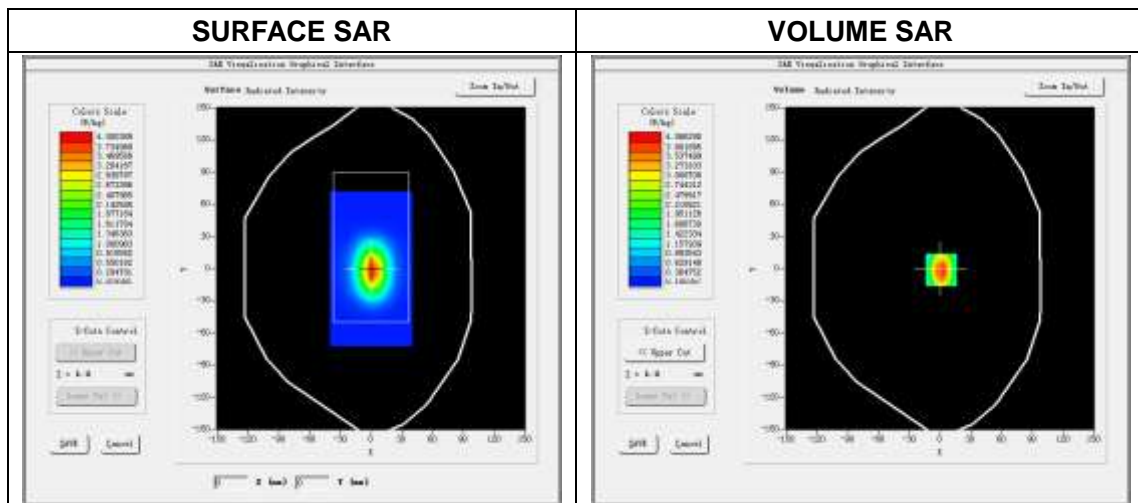

Maximum location: X=-1.00, Y=-1.00

SAR Peak: 6.31W/kg

SAR 10g (W/Kg)	1.981154
SAR 1g (W/Kg)	3.758530

Z Axis Scan

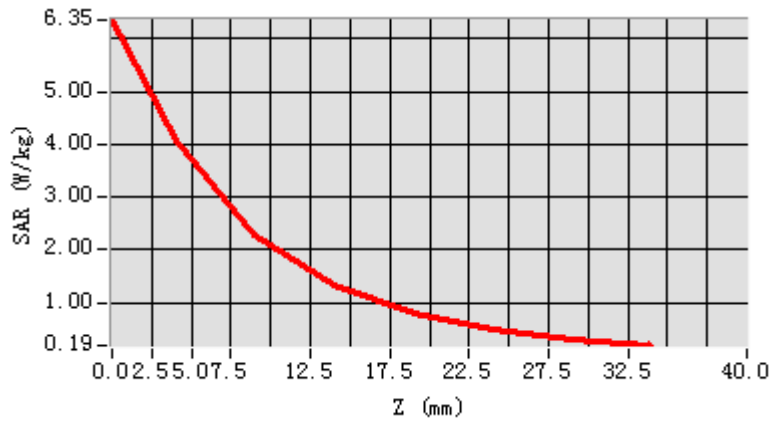

3D screen shot

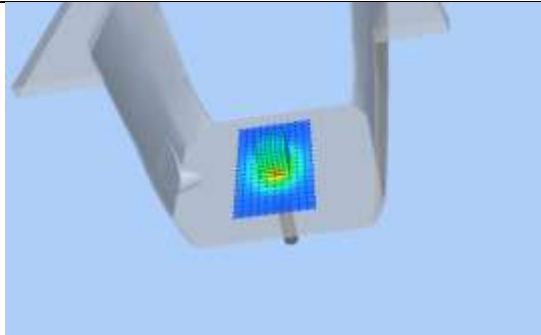

Hot spot position

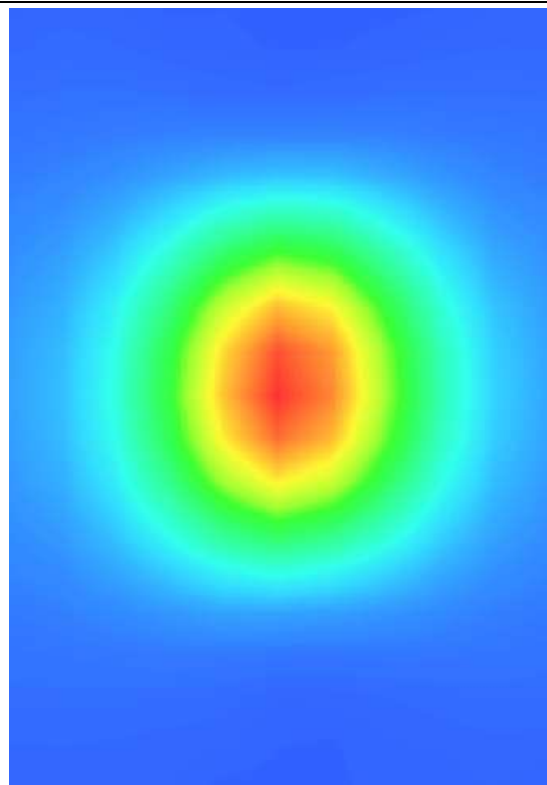

4.7.2 Dipole 1900 MHz Validation Measurement for Body Tissue

System Performance Check Data(1900MHz Body)

Type: Phone measurement (Complete)
 E-Field Probe: SN 34/15 SSE2 EPGO265
 Area scan resolution: dx=8mm,dy=8mm
 Zoom scan resolution: dx=8mm, dy=8mm, dz=5mm
 Date of measurement: 2019.03.19
 Measurement duration: 13 minutes 53 seconds

Experimental conditions.

Phantom File	surf_sam_plan.txt
Phantom	Validation plane
Band	1900MHz
Signal	CW
Frequency (MHz)	1900.000000
Relative permittivity (real part)	51.873291
Conductivity (S/m)	1.492383
Power drift (%)	-0.160000
Ambient Temperature:	22.2°C
Liquid Temperature:	20.9°C
ConvF:	2.57
Crest factor:	1:1

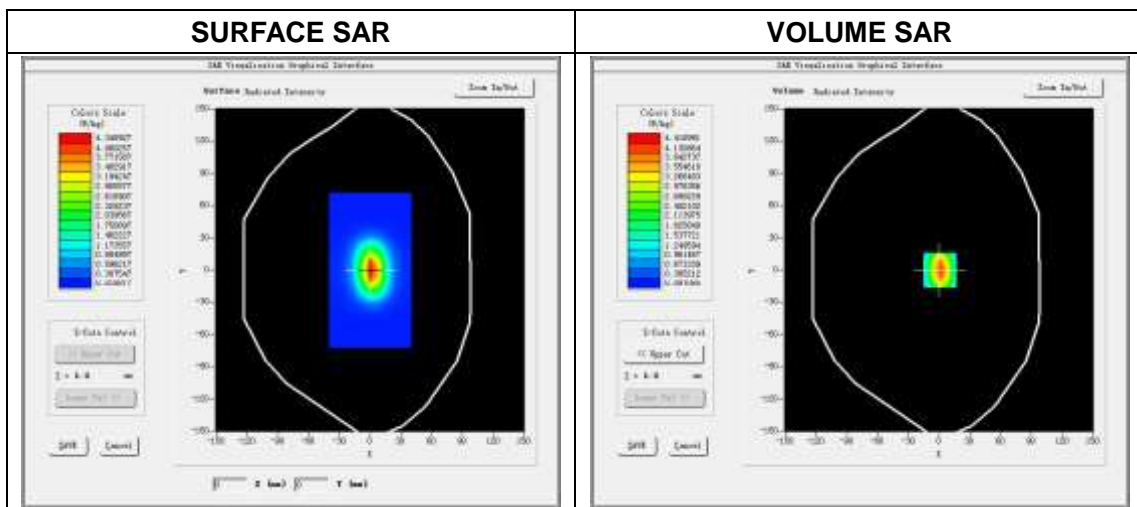

Maximum location: X=1.00, Y=0.00

SAR Peak: 6.81W/kg

SAR 10g (W/Kg)	2.146084
SAR 1g (W/Kg)	4.172396

Z Axis Scan

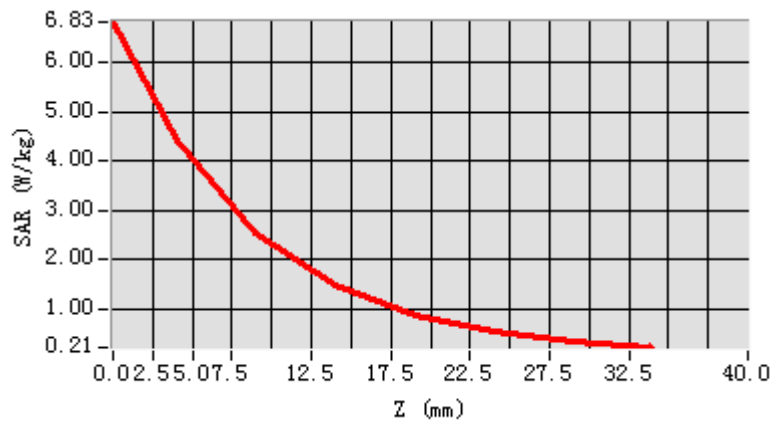

3D screen shot

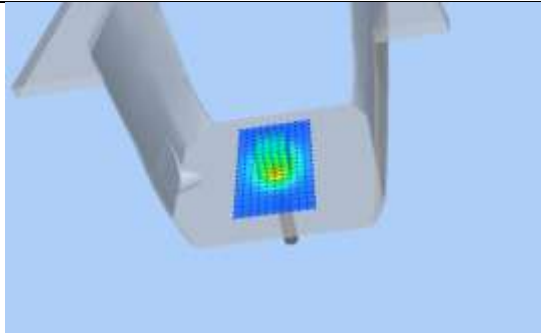

Hot spot position

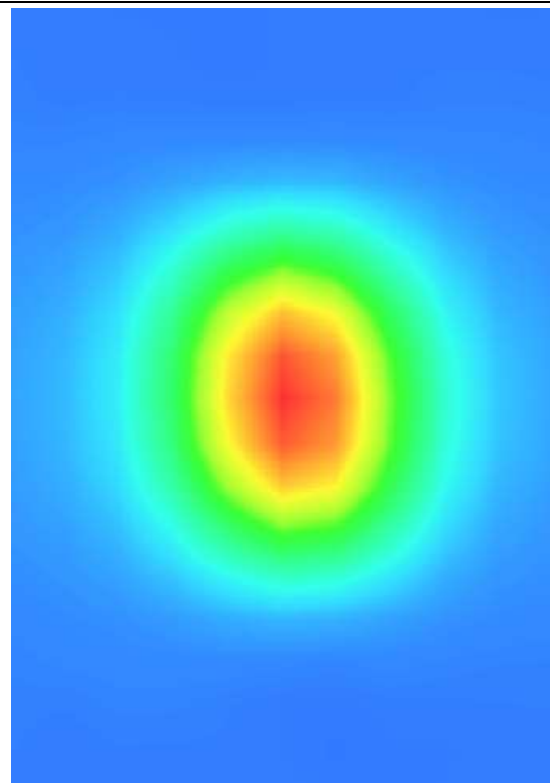

4.8 DIP 2G000

4.8.1 Dipole 2000 MHz Validation Measurement for Head Tissue

System Performance Check Data(2000 MHz Head)

Type: Phone measurement (Complete)
 E-Field Probe: SN 34/15 SSE2 EPGO265
 Area scan resolution: dx=8mm,dy=8mm
 Zoom scan resolution: dx=8 mm, dy=8 mm, dz=5mm
 Date of measurement: 2019.03.19
 Measurement duration: 13 minutes 44 seconds

Experimental conditions.

Phantom File	surf_sam_plan.txt
Phantom	Validation plane
Band	2000 MHz
Signal	CW
Frequency (MHz)	2000.000000
Relative permittivity (real part)	40.391259
Conductivity (S/m)	1.413235
Power drift (%)	-0.370000
Ambient Temperature:	22.2°C
Liquid Temperature:	20.9°C
ConvF:	2.24
Crest factor:	1:1

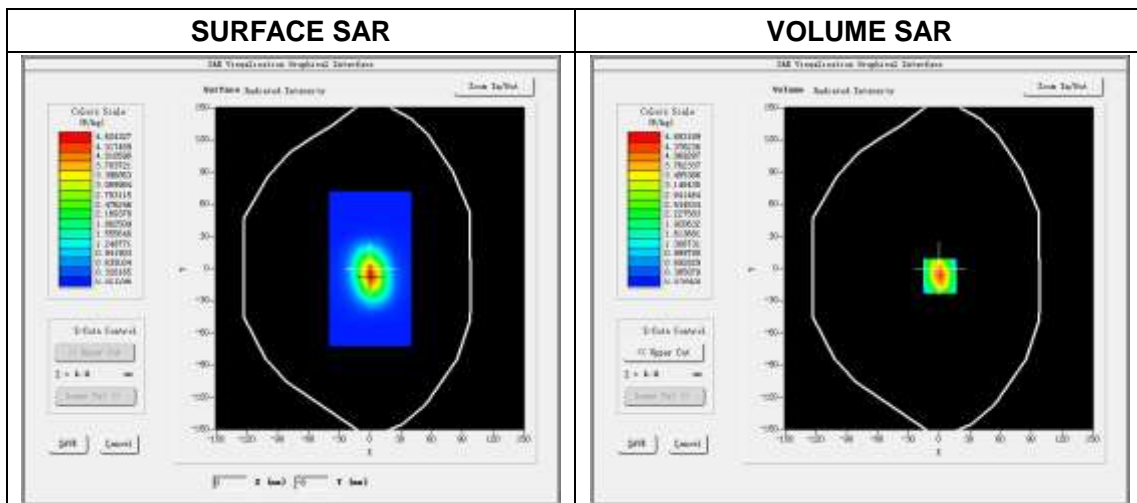

Maximum location: X=1.00, Y=-7.00

SAR Peak: 7.37 W/kg

SAR 10 g (W/Kg)	2.210635
SAR 1g (W/Kg)	4.401516

Z Axis Scan

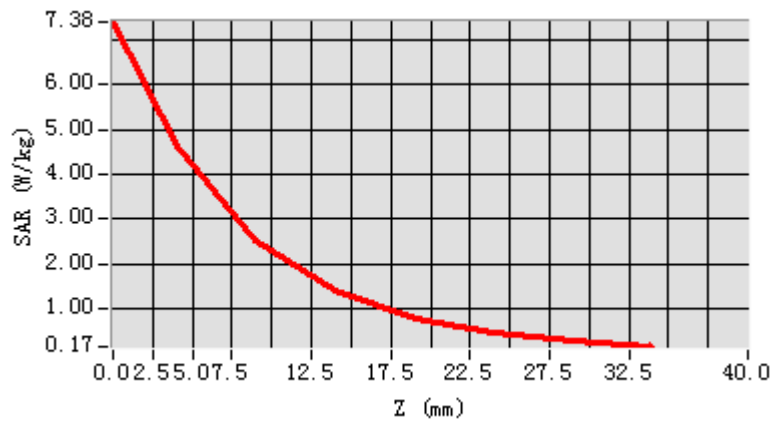

3D screen shot

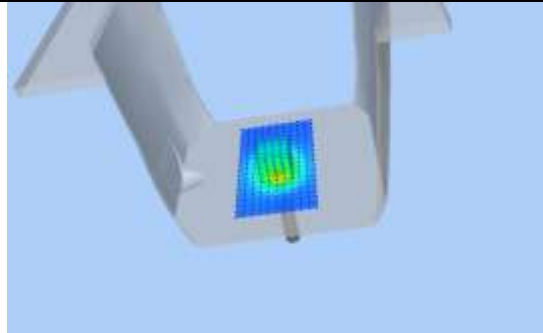

Hot spot position

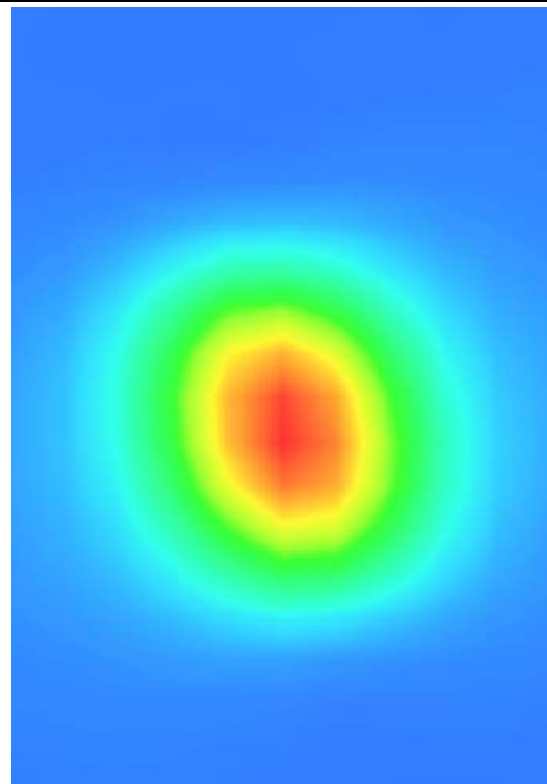

4.8.2 Dipole 2000 MHz Validation Measurement for Body Tissue

System Performance Check Data(2000 MHz Body)

Type: Phone measurement (Complete)
 E-Field Probe: SN 34/15 SSE2 EPGO265
 Area scan resolution: dx=8mm,dy=8mm
 Zoom scan resolution: dx=8 mm, dy=8 mm, dz=5mm
 Date of measurement: 2019.03.19
 Measurement duration: 13 minutes 41 seconds

Experimental conditions.

Phantom File	surf_sam_plan.txt
Phantom	Validation plane
Band	2000 MHz
Signal	CW
Frequency (MHz)	2000.000000
Relative permittivity (real part)	50.910358
Conductivity (S/m)	1.513480
Power drift (%)	0.130000
Ambient Temperature:	22.2°C
Liquid Temperature:	20.9°C
ConvF:	2.31
Crest factor:	1:1

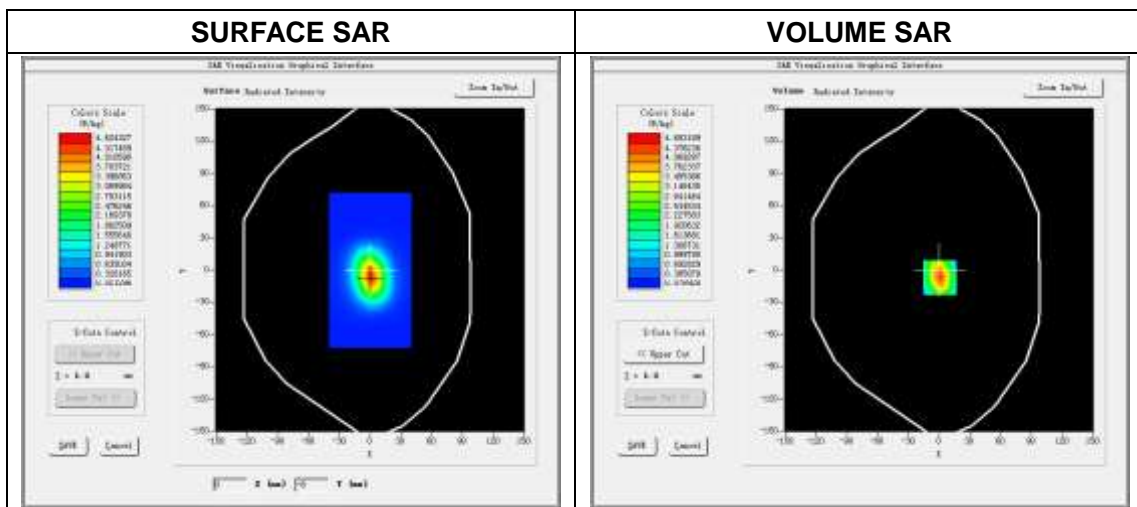

Maximum location: X=1.00, Y=-7.00

SAR Peak: 7.47 W/kg

SAR 10 g (W/Kg)	2.223596
SAR 1g (W/Kg)	4.435738

Z Axis Scan

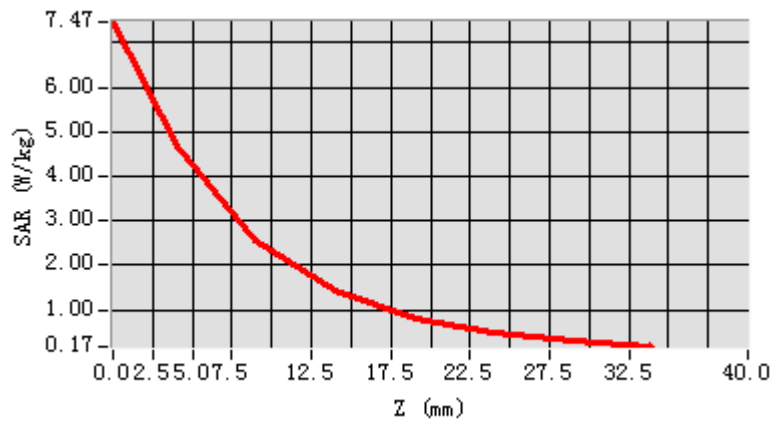

3D screen shot

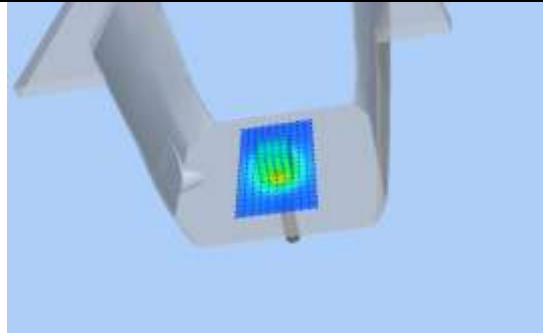

Hot spot position

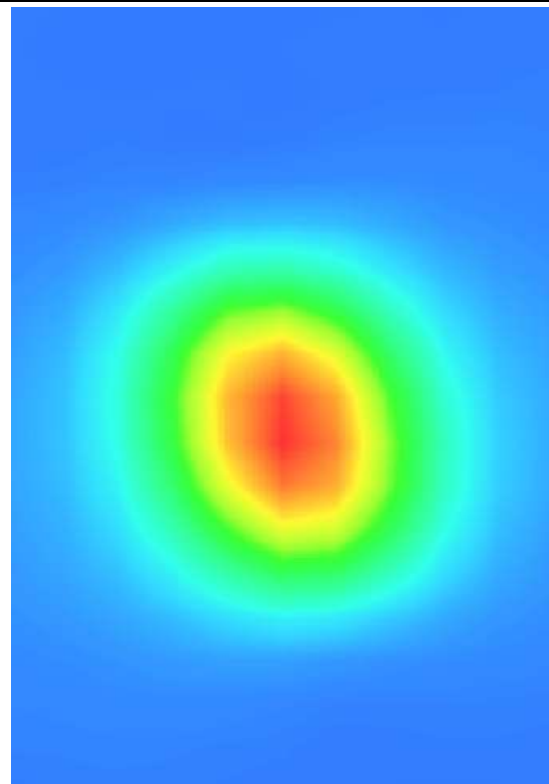

4.9 DIP 2G450

4.9.1 Dipole 2450 MHz Validation Measurement for Head Tissue

System Performance Check Data(2450MHz Head)

Type: Phone measurement (Complete)
 E-Field Probe: SN 34/15 SSE2 EPGO265
 Area scan resolution: dx=8mm,dy=8mm
 Zoom scan resolution: dx=5mm, dy=5mm, dz=5mm
 Date of measurement: 2019.03.19
 Measurement duration: 17 minutes 13 seconds

Experimental conditions.

Phantom File	surf_sam_plan.txt
Phantom	Validation plane
Band	2450MHz
Signal	CW
Frequency (MHz)	2450.000000
Relative permittivity (real part)	38.547382
Conductivity (S/m)	1.836217
Power drift (%)	-0.280000
Ambient Temperature:	22.2°C
Liquid Temperature:	20.9°C
ConvF:	2.55
Crest factor:	1:1

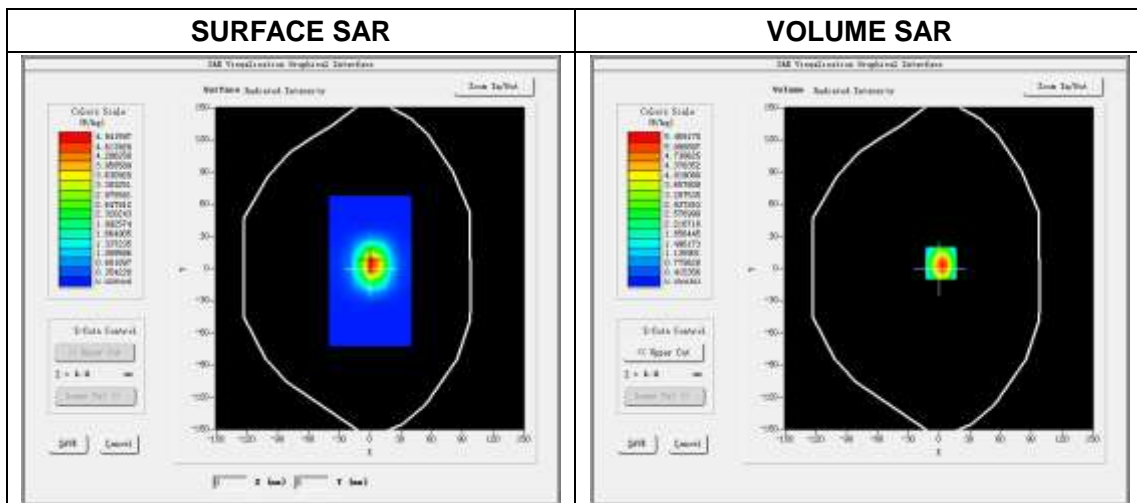

Maximum location: X=0.00, Y=8.00

SAR Peak: 9.33 W/kg

SAR 10g (W/Kg)	2.327542
SAR 1g (W/Kg)	5.067805

Z Axis Scan

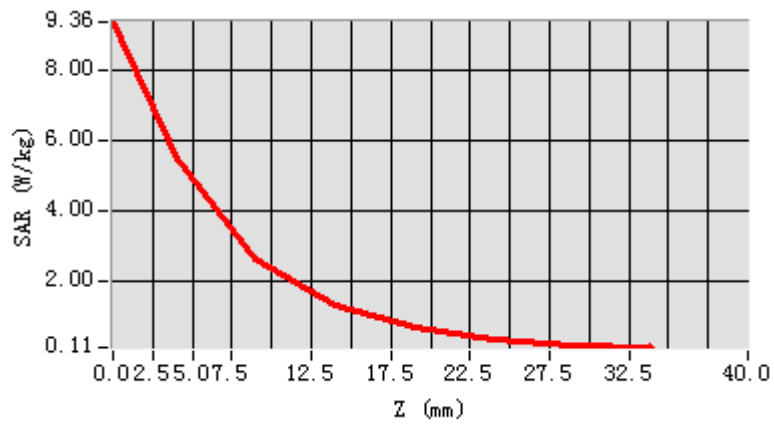

3D screen shot

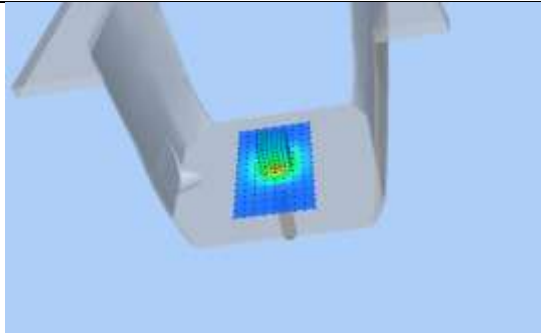

Hot spot position

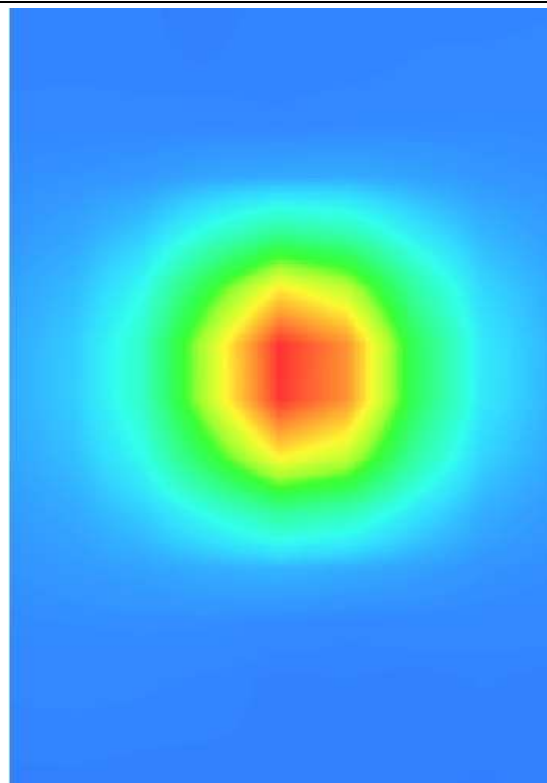

4.9.2 Dipole 2450 MHz Validation Measurement for Body Tissue

System Performance Check Data(2450 MHz Body)

Type: Phone measurement (Complete)
 E-Field Probe: SN 34/15 SSE2 EPGO265
 Area scan resolution: dx=8mm,dy=8mm
 Zoom scan resolution: dx=5mm, dy=5mm, dz=5mm
 Date of measurement: 2019.03.19
 Measurement duration: 18 minutes 49 seconds

Experimental conditions.

Phantom File	surf_sam_plan.txt
Phantom	Validation plane
Band	2450MHz
Signal	CW
Frequency (MHz)	2450.000000
Relative permittivity (real part)	51.352435
Conductivity (S/m)	1.973137
Power drift (%)	0.590000
Ambient Temperature:	22.2°C
Liquid Temperature:	20.9°C
ConvF:	2.63
Crest factor:	1:1

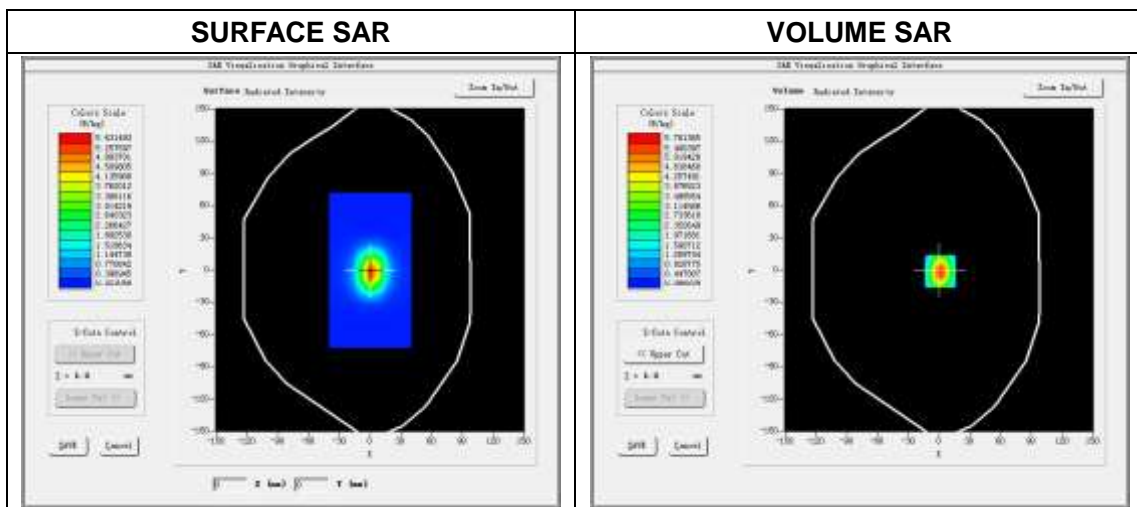

Maximum location: X=1.00, Y=-1.00

SAR Peak: 9.38W/kg

SAR 10g (W/Kg)	2.478358
SAR 1g (W/Kg)	5.298750

Z Axis Scan

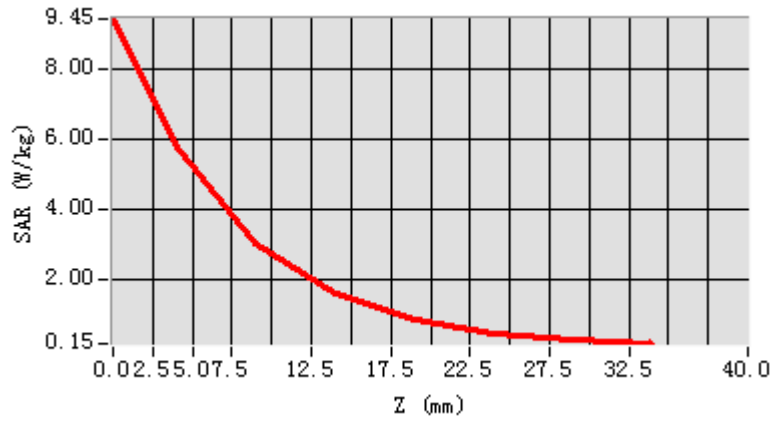

3D screen shot

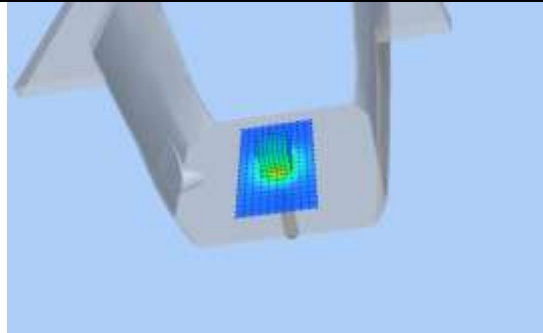

Hot spot position

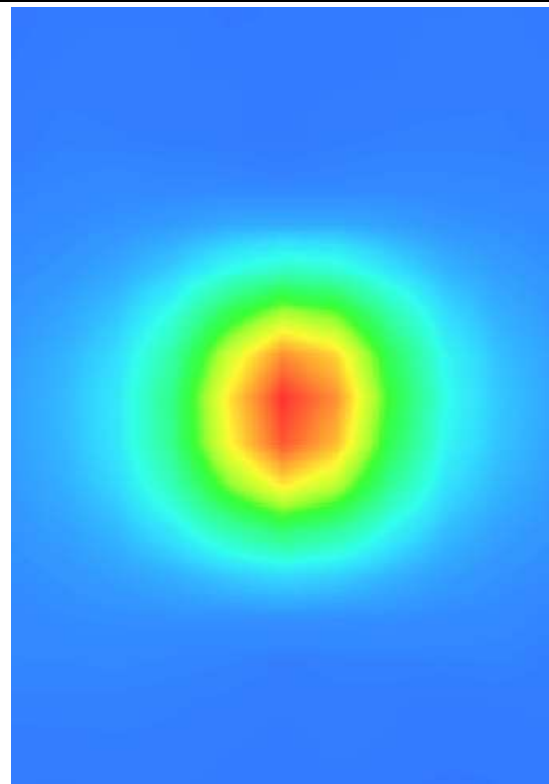

4.10DIP 2G600

4.10.1 Dipole 2600 MHz Validation Measurement for Head Tissue

System Performance Check Data(2600 MHz Head)

Type: Phone measurement (Complete)
 E-Field Probe: SN 34/15 SSE2 EPGO265
 Area scan resolution: dx=8mm,dy=8mm
 Zoom scan resolution: dx=5mm, dy=5mm, dz=5mm
 Date of measurement: 2019.03.19
 Measurement duration: 18 minutes 41 seconds

Experimental conditions.

Phantom File	surf_sam_plan.txt
Phantom	Validation plane
Band	2600MHz
Signal	CW
Frequency (MHz)	2600.000000
Relative permittivity (real part)	37.953275
Conductivity (S/m)	1.939158
Power drift (%)	0.270000
Ambient Temperature:	22.2°C
Liquid Temperature:	20.9°C
ConvF:	2.38
Crest factor:	1:1

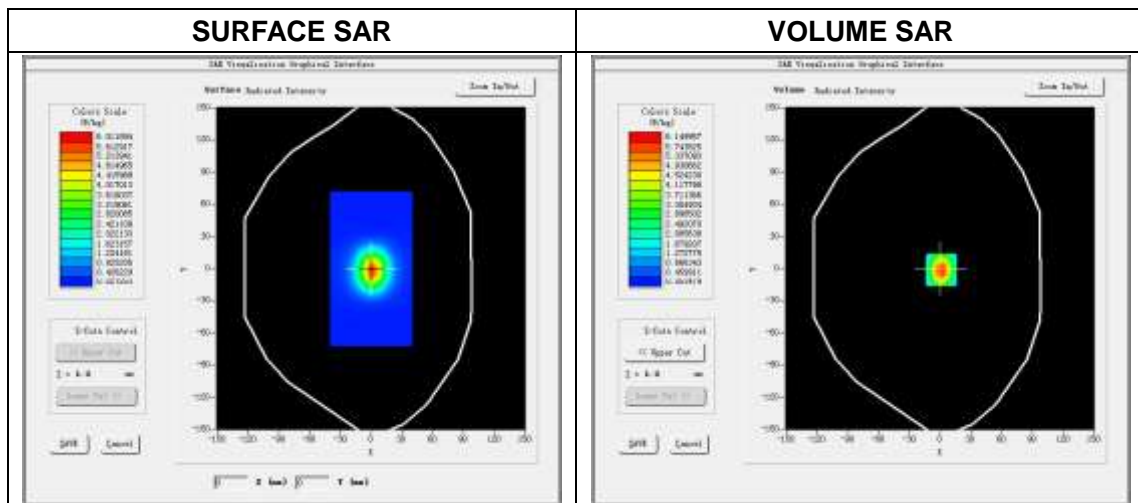

Maximum location: X=1.00, Y=-1.00
 SAR Peak: 10.85W/kg

SAR 10g (W/Kg)	2.525319
SAR 1g (W/Kg)	5.658230

Z Axis Scan

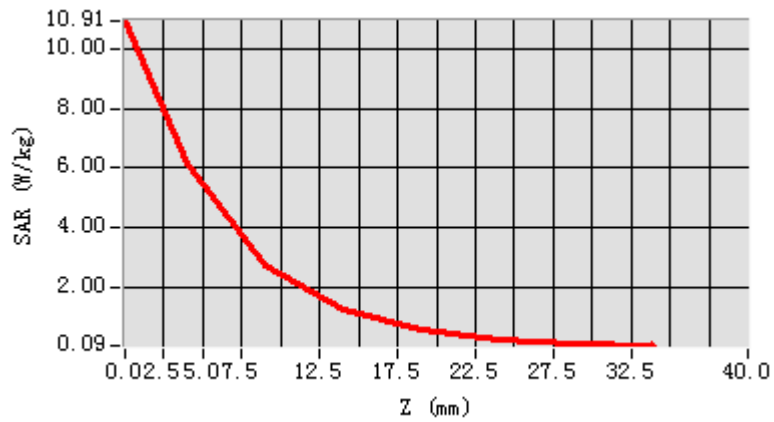

3D screen shot

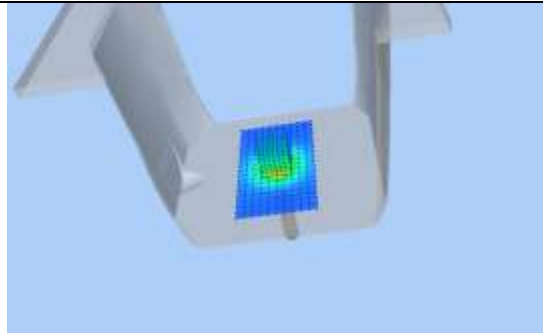

Hot spot position

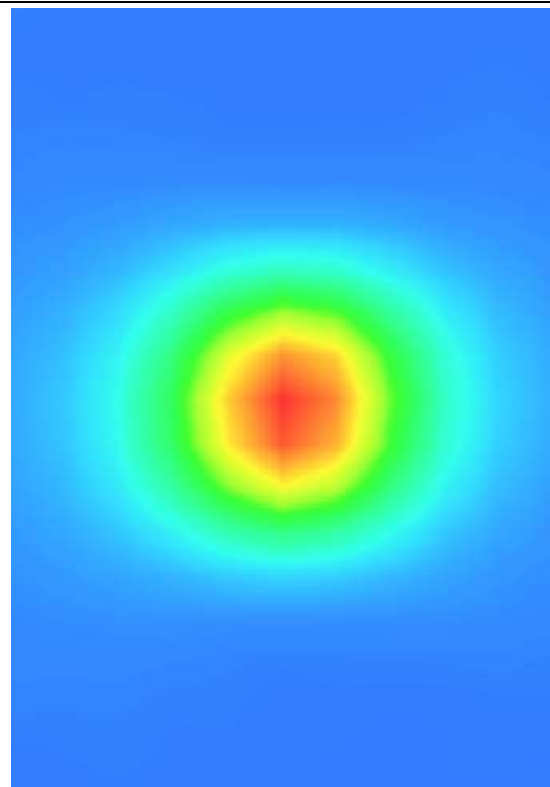

4.10.2 Dipole 2600 MHz Validation Measurement for Body Tissue

System Performance Check Data(2600 MHz Body)

Type: Phone measurement (Complete)
 E-Field Probe: SN 34/15 SSE2 EPGO265
 Area scan resolution: dx=8mm,dy=8mm
 Zoom scan resolution: dx=5mm, dy=5mm, dz=5mm
 Date of measurement: 2019.03.19
 Measurement duration: 18 minutes 48 seconds

Experimental conditions.

Phantom File	surf_sam_plan.txt
Phantom	Validation plane
Band	2600MHz
Signal	CW
Frequency (MHz)	2600.000000
Relative permittivity (real part)	50.677054
Conductivity (S/m)	2.106129
Power drift (%)	0.380000
Ambient Temperature:	22.2°C
Liquid Temperature:	20.9°C
ConvF:	2.46
Crest factor:	1:1

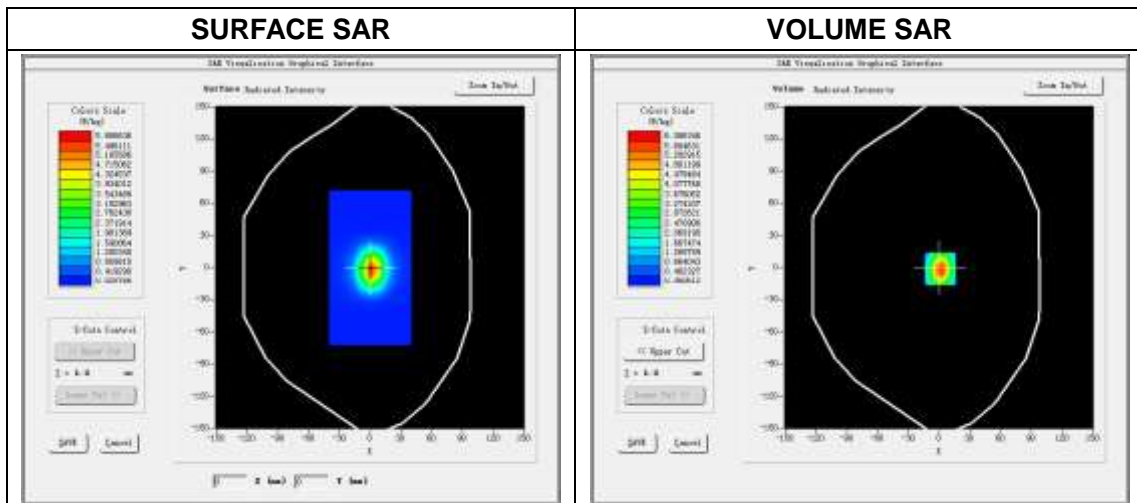

Maximum location: X=1.00, Y=-1.00

SAR Peak: 10.19W/kg

SAR 10g (W/Kg)	2.513824
SAR 1g (W/Kg)	5.613058

Z Axis Scan

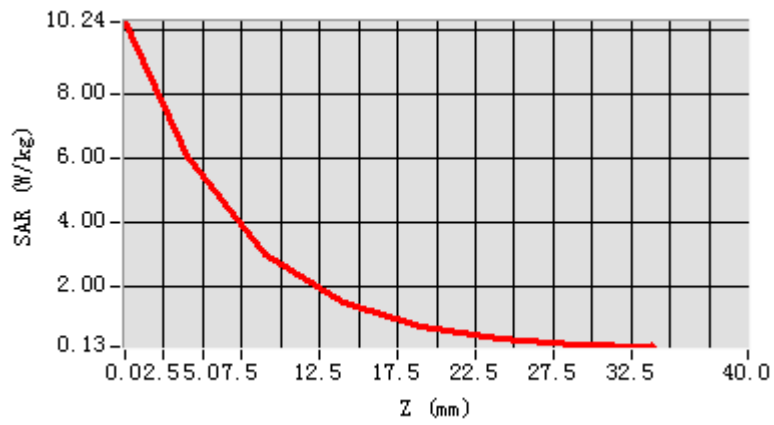

3D screen shot

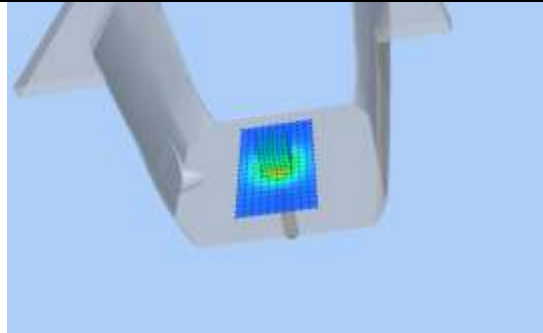

Hot spot position

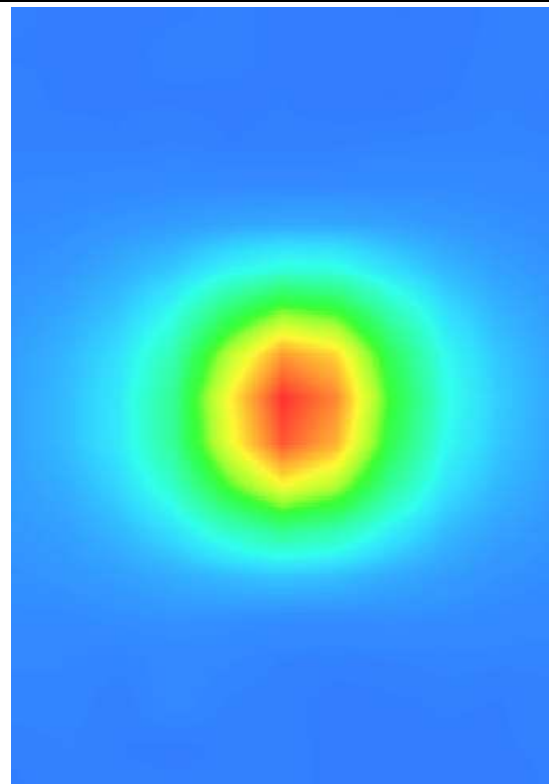

4.11 SWG5200

4.11.1 Waveguide 5200 MHz Validation Measurement for Head Tissue

System Performance Check Data(5200 MHz Head)

Type: Phone measurement (Complete)
 E-Field Probe: SN 34/15 SSE2 EPGO265
 Area scan resolution: dx=8mm,dy=8mm
 Zoom scan resolution: dx=4 mm, dy=4 mm, dz=2 mm
 Date of measurement: 2019.03.20
 Measurement duration: 29 minutes 32 seconds

Experimental conditions.

Phantom File	surf_sam_plan.txt
Phantom	Validation plane
Band	5200 MHz
Signal	CW
Frequency (MHz)	5200.000000
Relative permittivity (real part)	35.857245
Conductivity (S/m)	4.718406
Power drift (%)	-0.940000
Ambient Temperature:	22.5°C
Liquid Temperature:	21.3°C
ConvF:	2.09
Crest factor:	1:1

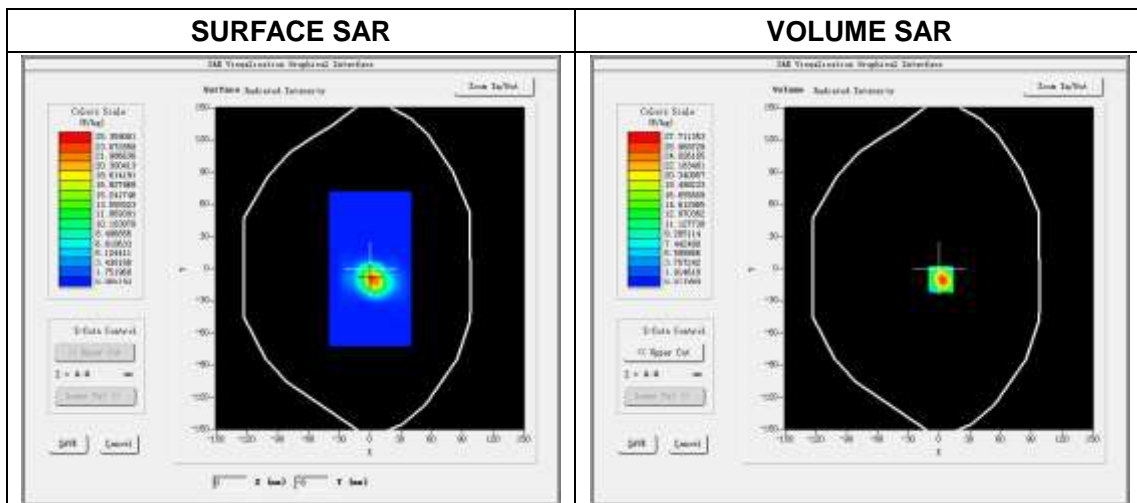

Maximum location: X=0.00, Y=-8.00

SAR Peak: 44.89 W/kg

SAR 10 g (W/Kg)	5.397451
SAR 1g (W/Kg)	15.802760

Z Axis Scan

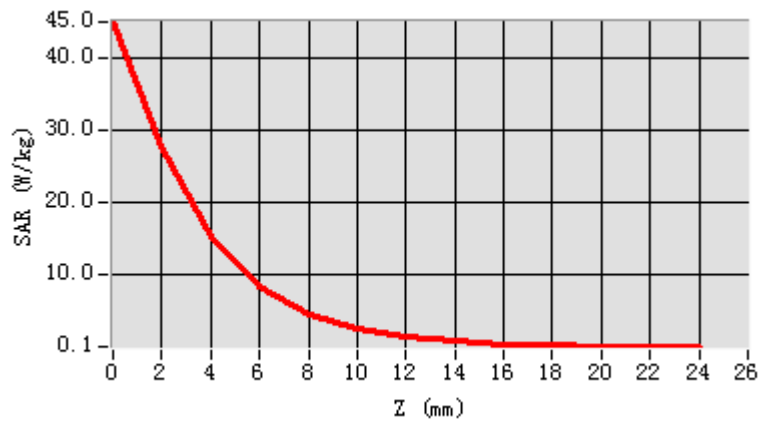

3D screen shot

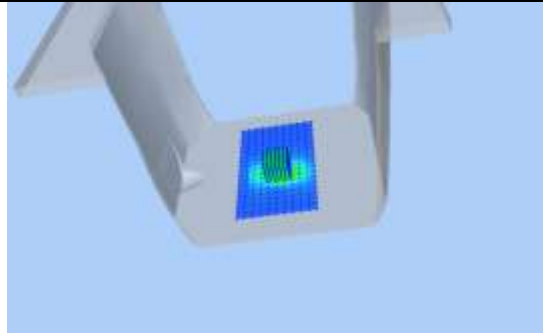

Hot spot position

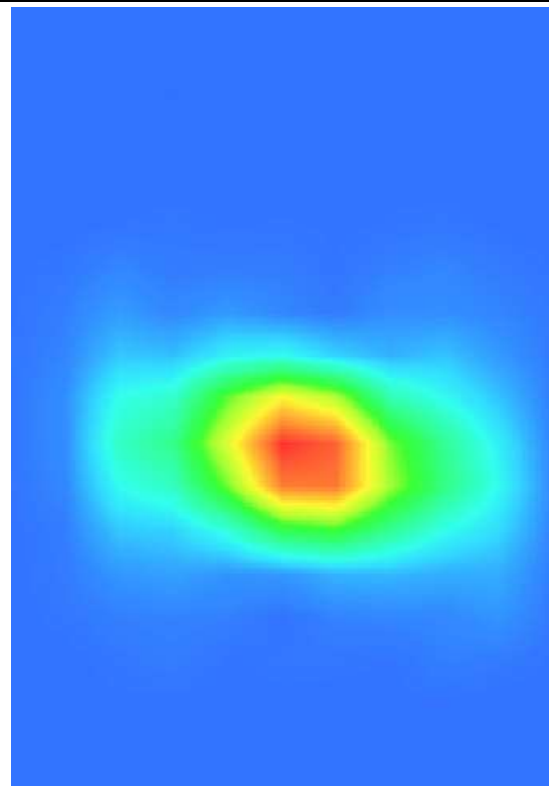

4.11.2 Waveguide 5200 MHz Validation Measurement for Body Tissue

System Performance Check Data(5200 MHz Body)

Type: Phone measurement (Complete)
 E-Field Probe: SN 34/15 SSE2 EPGO265
 Area scan resolution: dx=8mm,dy=8mm
 Zoom scan resolution: dx=4 mm, dy=4 mm, dz=2 mm
 Date of measurement: 2019.03.20
 Measurement duration: 29 minutes 35 seconds

Experimental conditions.

Phantom File	surf_sam_plan.txt
Phantom	Validation plane
Band	5200 MHz
Signal	CW
Frequency (MHz)	5200.000000
Relative permittivity (real part)	50.351258
Conductivity (S/m)	5.251308
Power drift (%)	-0.170000
Ambient Temperature:	22.5°C
Liquid Temperature:	21.3°C
ConvF:	2.14
Crest factor:	1:1

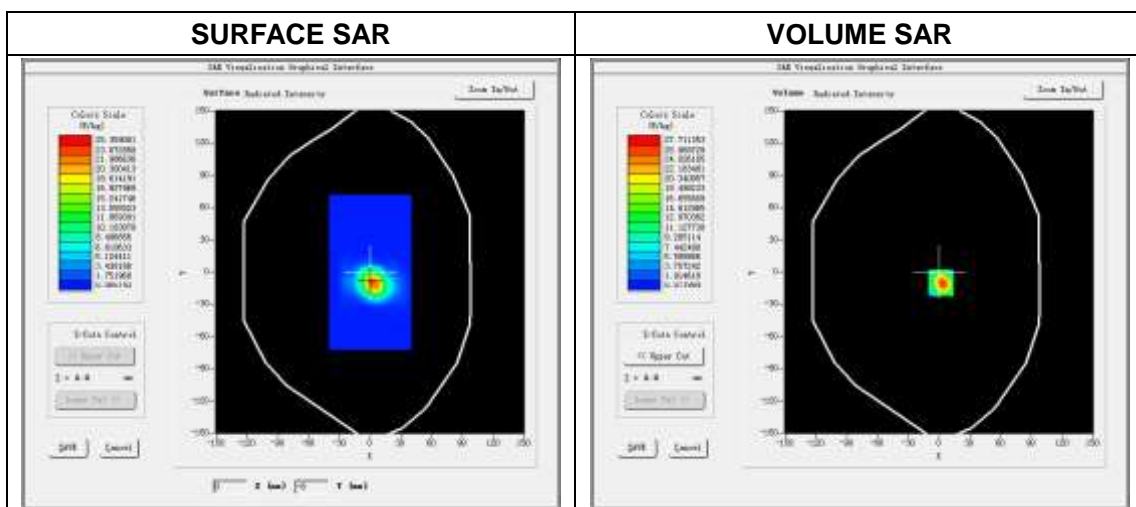

Maximum location: X=0.00, Y=-8.00

SAR Peak: 44.98 W/kg

SAR 10 g (W/Kg)	5.414572
SAR 1g (W/Kg)	15.817085

Z Axis Scan

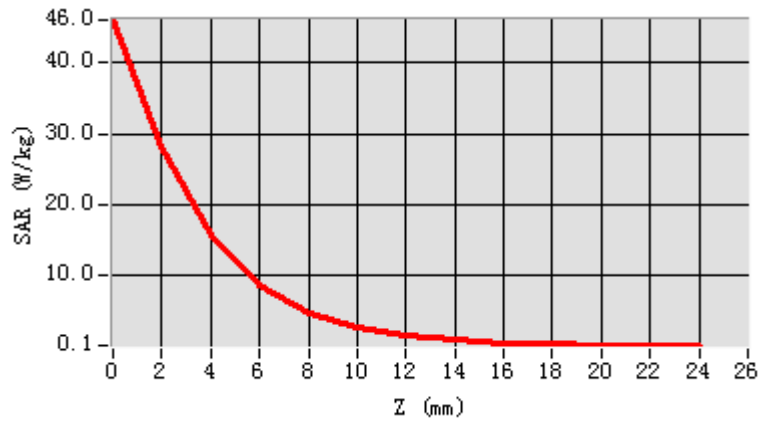

3D screen shot

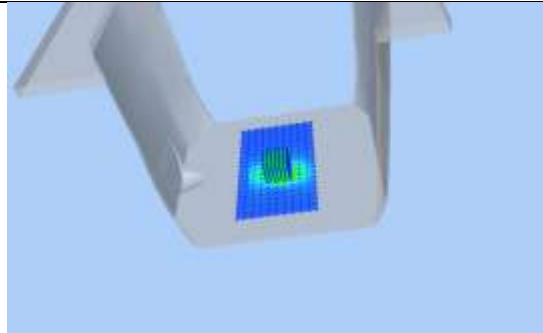

Hot spot position

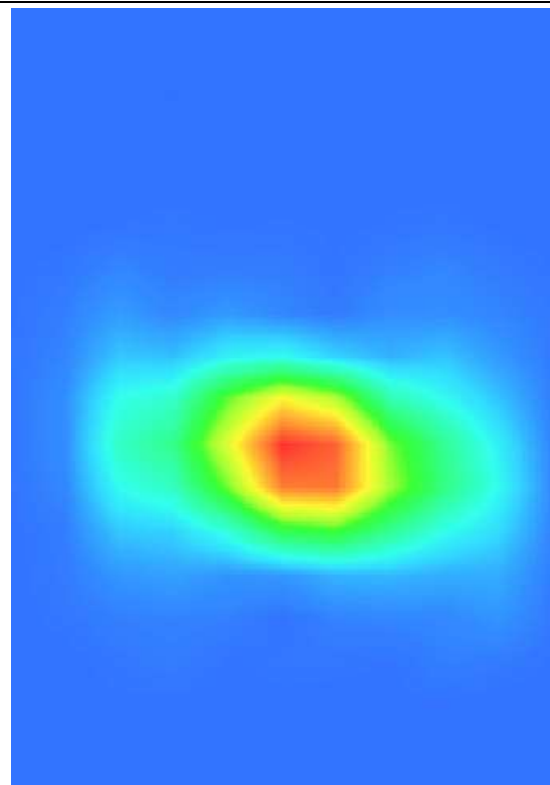

4.12SWG5400

4.12.1 Waveguide 5400 MHz Validation Measurement for Head Tissue

System Performance Check Data(5400 MHz Head)

Type: Phone measurement (Complete)
 E-Field Probe: SN 34/15 SSE2 EPGO265
 Area scan resolution: dx=8mm,dy=8mm
 Zoom scan resolution: dx=4 mm, dy=4 mm, dz=2 mm
 Date of measurement: 2019.03.20
 Measurement duration: 29 minutes 49 seconds

Experimental conditions.

Phantom File	surf_sam_plan.txt
Phantom	Validation plane
Band	5400 MHz
Signal	CW
Frequency (MHz)	5400.000000
Relative permittivity (real part)	35.329158
Conductivity (S/m)	4.954093
Power drift (%)	-0.480000
Ambient Temperature:	22.5°C
Liquid Temperature:	21.3°C
ConvF:	2.04
Crest factor:	1:1

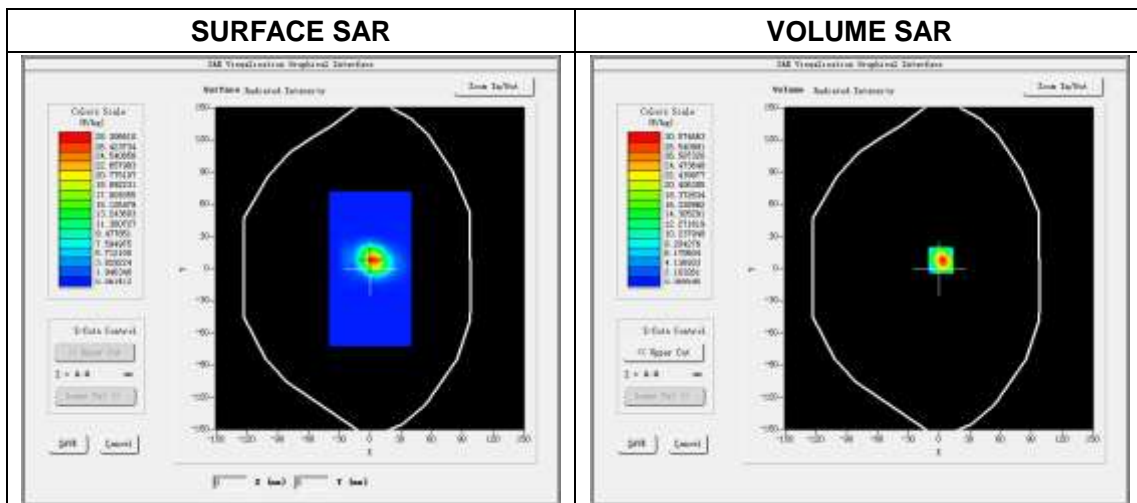

Maximum location: X=0.00, Y=8.00

SAR Peak: 50.73 W/kg

SAR 10 g (W/Kg)	5.795411
SAR 1g (W/Kg)	17.202529

Z Axis Scan

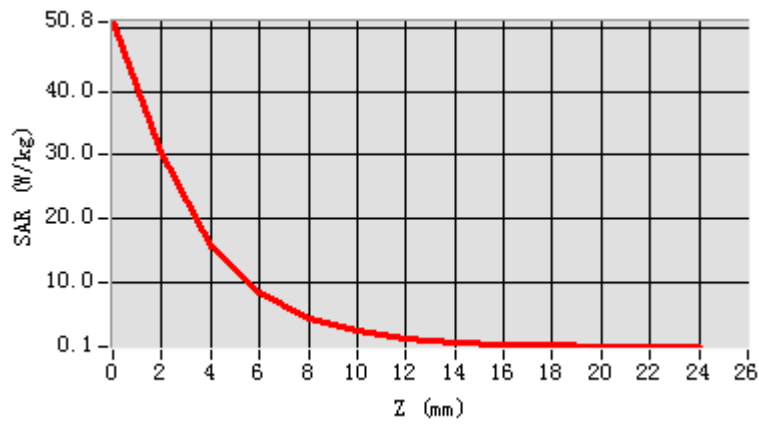

3D screen shot

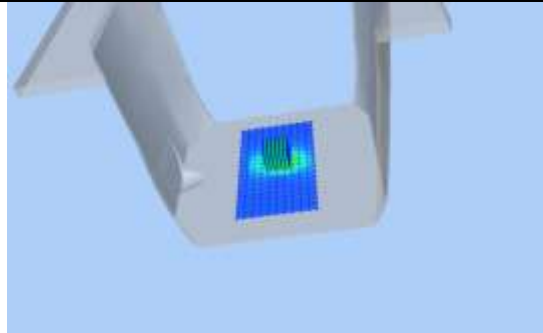

Hot spot position

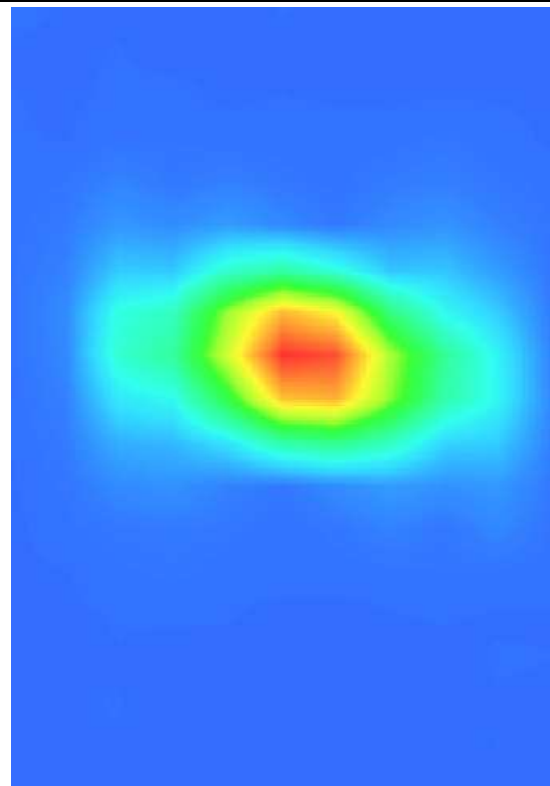

4.12.2 Waveguide 5400 MHz Validation Measurement for Body Tissue

System Performance Check Data(5400 MHz Body)

Type: Phone measurement (Complete)
 E-Field Probe: SN 34/15SSE2 EPGO265
 Area scan resolution: dx=8mm,dy=8mm
 Zoom scan resolution: dx=4 mm, dy=4 mm, dz=2 mm
 Date of measurement: 2019.03.20
 Measurement duration: 28 minutes 43 seconds

Experimental conditions.

Phantom File	surf_sam_plan.txt
Phantom	Validation plane
Band	5400 MHz
Signal	CW
Frequency (MHz)	5400.000000
Relative permittivity (real part)	49.304192
Conductivity (S/m)	5.558064
Power drift (%)	0.330000
Ambient Temperature:	22.5°C
Liquid Temperature:	21.3°C
ConvF:	2.12
Crest factor:	1:1



Maximum location: X=0.00, Y=0.00

SAR Peak: 43.34 W/kg

SAR 10 g (W/Kg)	5.383784
SAR 1g (W/Kg)	15.362730

Z Axis Scan

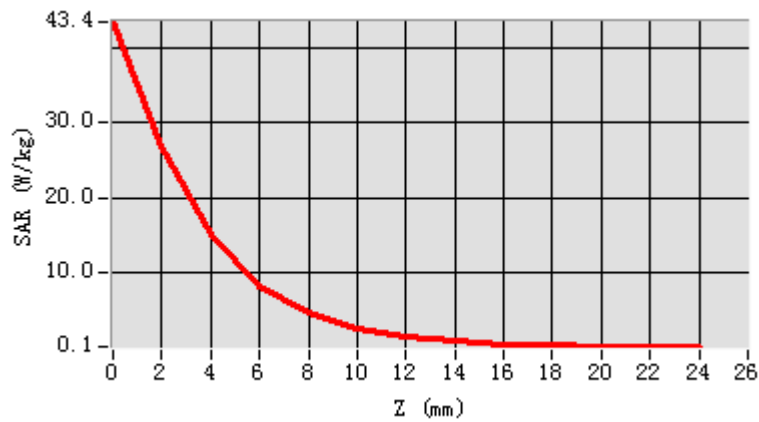

3D screen shot

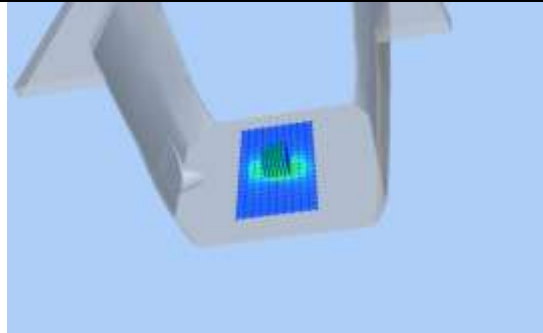

Hot spot position

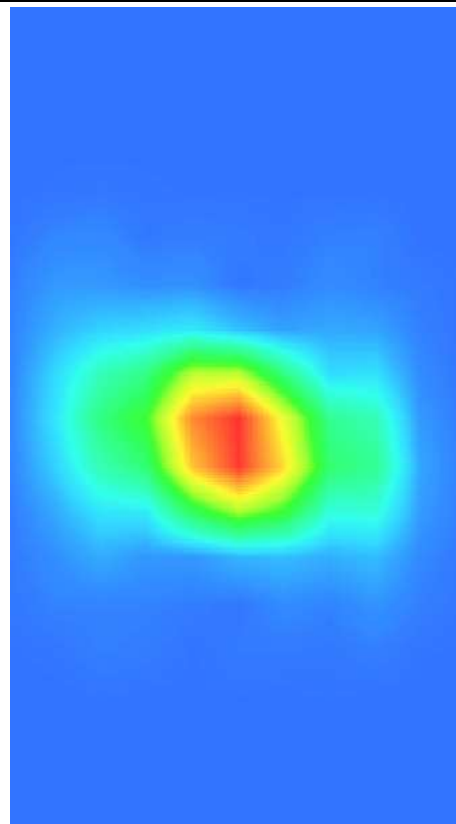

4.13SWG5600

4.13.1 Waveguide 5600 MHz Validation Measurement for Head Tissue

System Performance Check Data(5600MHz Head)

Type: Phone measurement (Complete)
 E-Field Probe: SN 34/15 SSE2 EPGO265
 Area scan resolution: dx=8mm,dy=8mm
 Zoom scan resolution: dx=4 mm, dy=4 mm, dz=2 mm
 Date of measurement: 2019.03.20
 Measurement duration: 30 minutes 13 seconds

Experimental conditions.

Phantom File	surf_sam_plan.txt
Phantom	Validation plane
Band	5600 MHz
Signal	CW
Frequency (MHz)	5600.000000
Relative permittivity (real part)	34.751285
Conductivity (S/m)	5.172040
Power drift (%)	-0.670000
Ambient Temperature:	22.5°C
Liquid Temperature:	21.3°C
ConvF:	2.20
Crest factor:	1:1

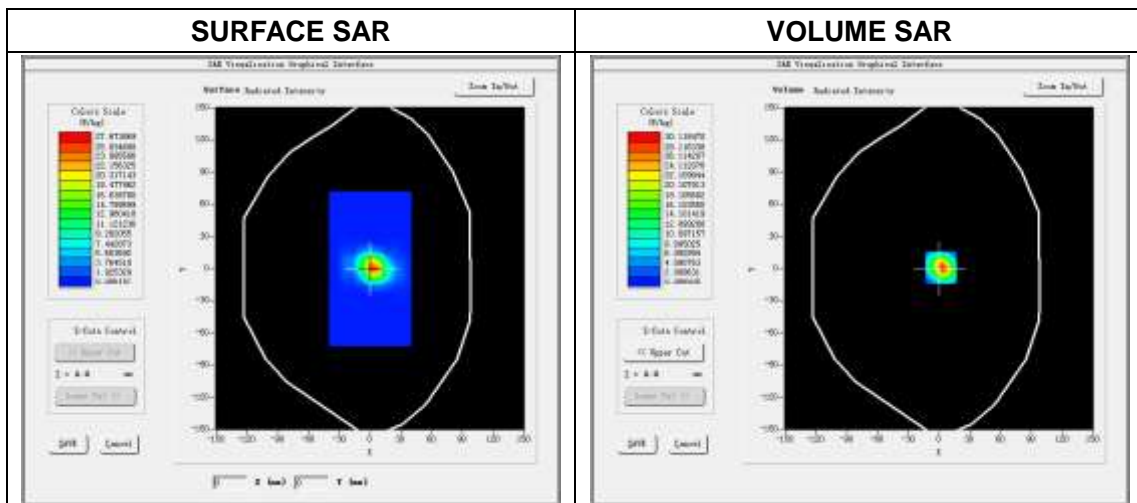

Maximum location: X=2.00, Y=1.00

SAR Peak: 47.23 W/kg

SAR 10 g (W/Kg)	5.545079
SAR 1g (W/Kg)	18.247688

Z Axis Scan

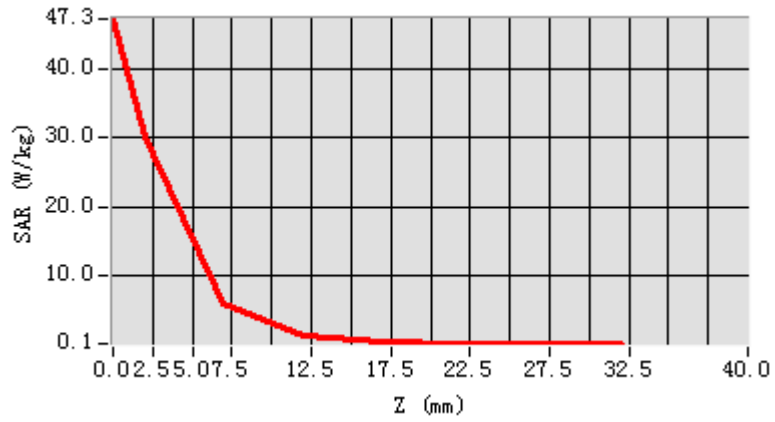

3D screen shot

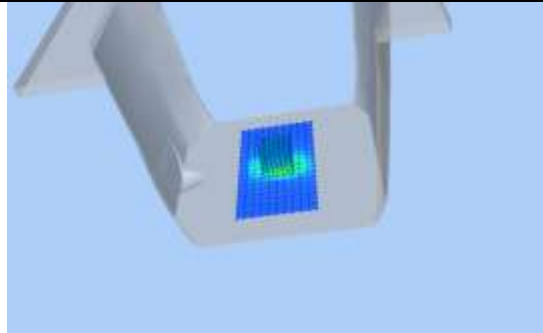

Hot spot position

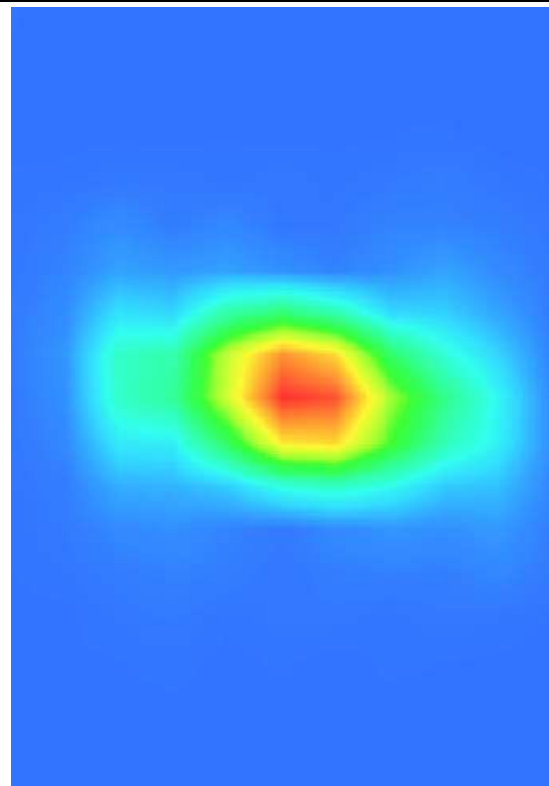

4.13.2 Waveguide 5600 MHz Validation Measurement for Body Tissue

System Performance Check Data (5600MHz Body)

Type: Phone measurement (Complete)
 E-Field Probe: SN 34/15 SSE2 EPGO265
 Area scan resolution: dx=8mm,dy=8mm
 Zoom scan resolution: dx=4 mm, dy=4 mm, dz=2 mm
 Date of measurement: 2019.03.20
 Measurement duration: 27 minutes 32 seconds

Experimental conditions.

Phantom File	surf_sam_plan.txt
Phantom	Validation plane
Band	5600 MHz
Signal	CW
Frequency (MHz)	5600.000000
Relative permittivity (real part)	48.110358
Conductivity (S/m)	5.912359
Power drift (%)	-0.710000
Ambient Temperature:	22.5°C
Liquid Temperature:	21.3°C
ConvF:	2.27
Crest factor:	1:1

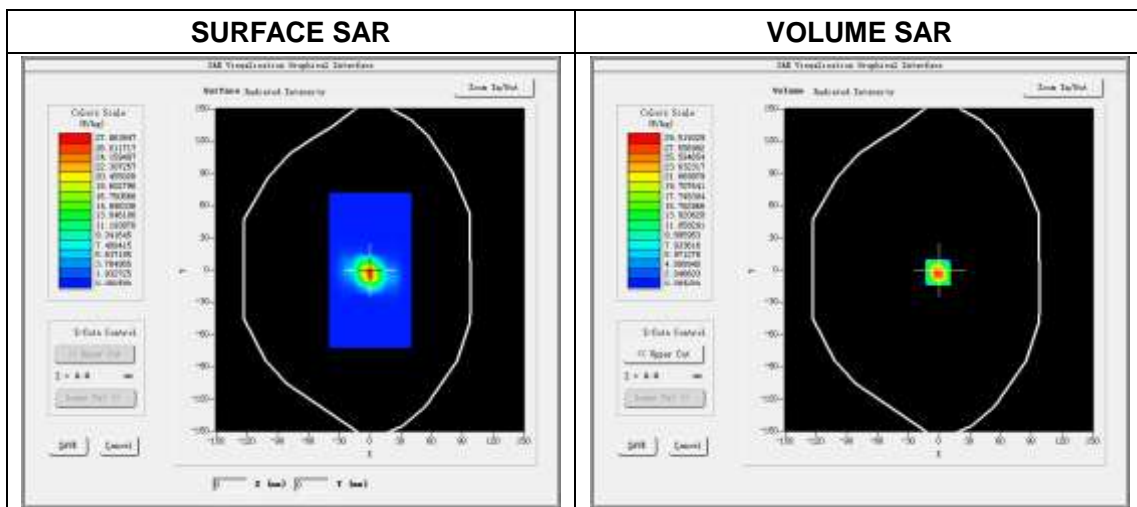

Maximum location: X=0.00, Y=0.00

SAR Peak: 48.58 W/kg

SAR 10 g (W/Kg)	5.658057
SAR 1g (W/Kg)	16.736740

Z Axis Scan

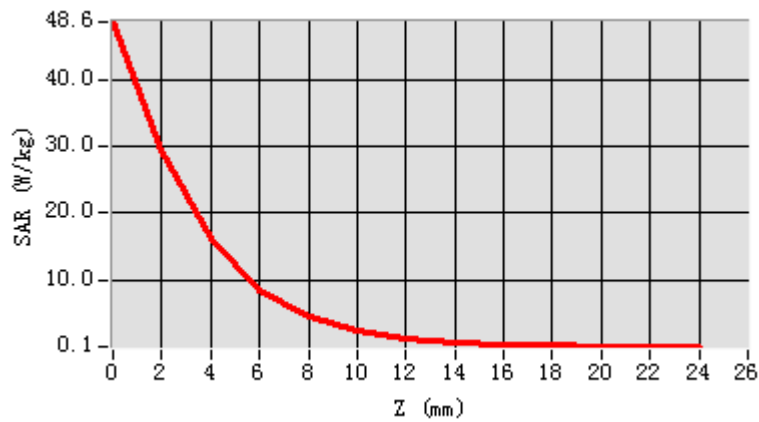

3D screen shot

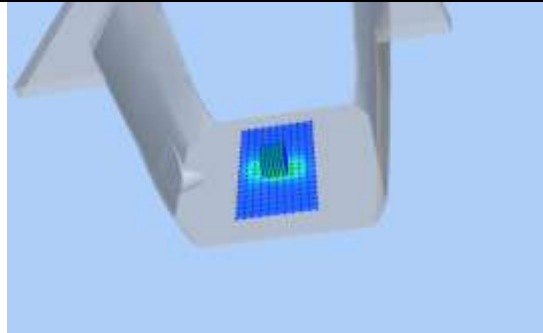

Hot spot position

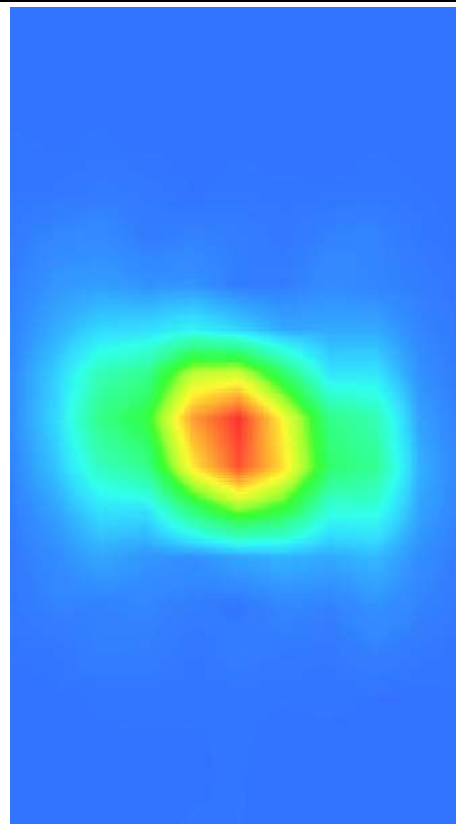

4.14SWG5800

4.14.1 Waveguide 5800 MHz Validation Measurement for Head Tissue

System Performance Check Data (5800MHz Head)

Type: Phone measurement (Complete)
 E-Field Probe: SN 34/15 SSE2 EPGO265
 Area scan resolution: dx=8mm,dy=8mm
 Zoom scan resolution: dx=4 mm, dy=4 mm, dz=2 mm
 Date of measurement: 2019.03.20
 Measurement duration: 26 minutes 59 seconds

Experimental conditions.

Phantom File	surf_sam_plan.txt
Phantom	Validation plane
Band	5800 MHz
Signal	CW
Frequency (MHz)	5800.000000
Relative permittivity (real part)	33.923448
Conductivity (S/m)	5.398460
Power drift (%)	-1.250000
Ambient Temperature:	22.5°C
Liquid Temperature:	21.3°C
ConvF:	2.17
Crest factor:	1:1

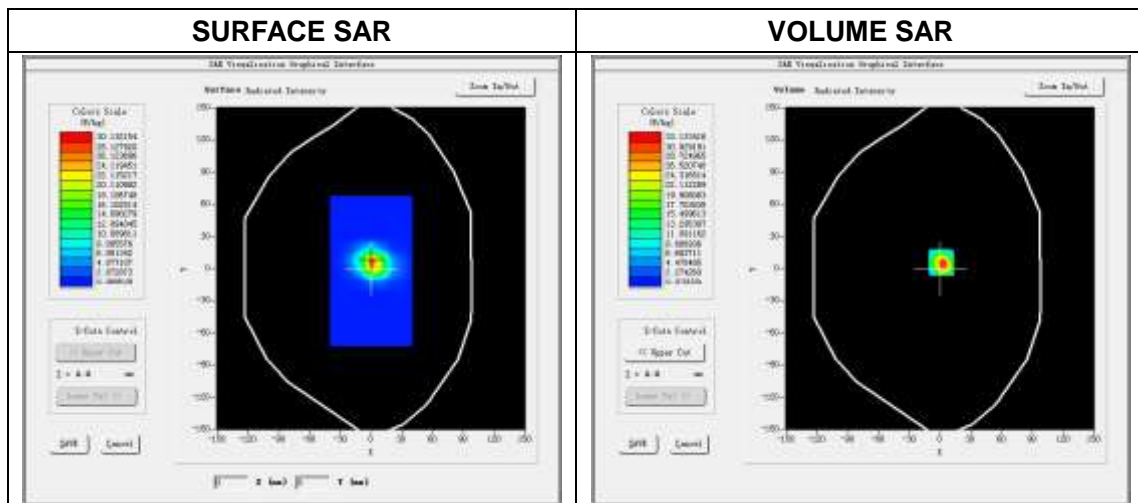

Maximum location: X=0.00, Y=8.00

SAR Peak: 56.52 W/kg

SAR 10 g (W/Kg)	6.034581
SAR 1g (W/Kg)	18.468425

Z Axis Scan

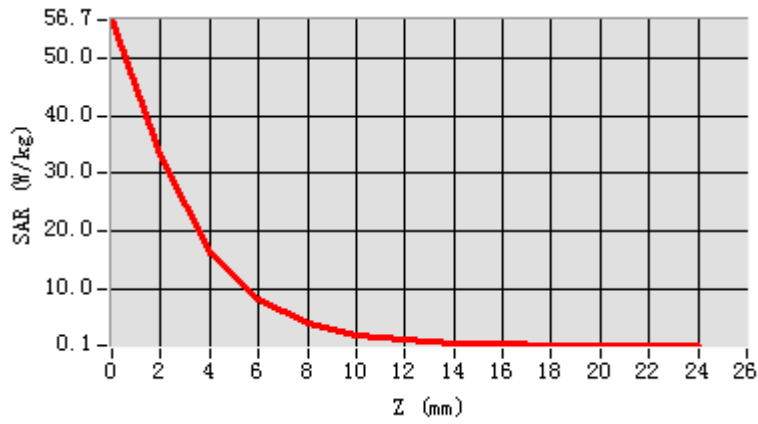

3D screen shot

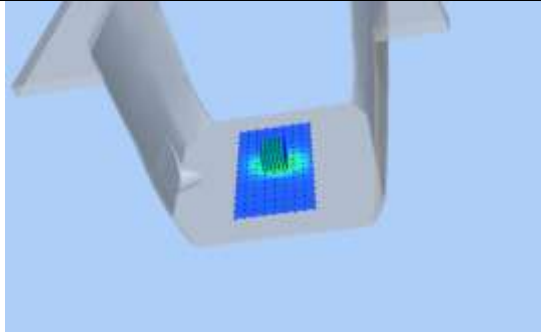

Hot spot position

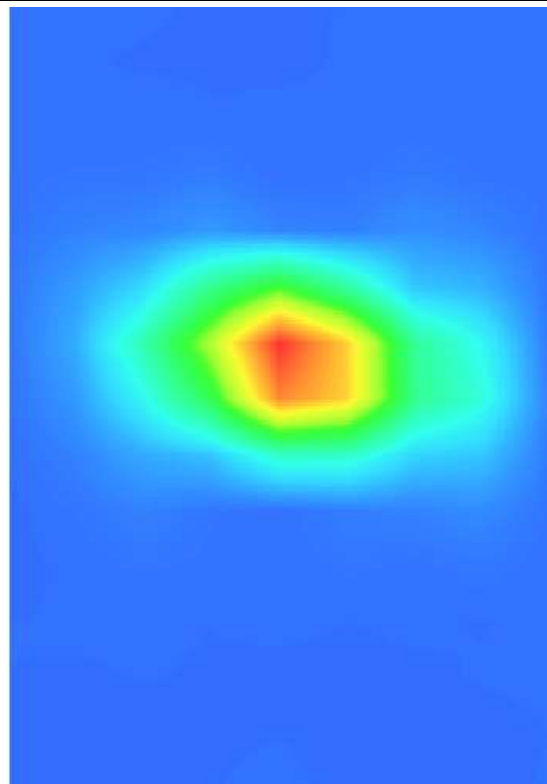

4.14.2 Waveguide 5800 MHz Validation Measurement for Body Tissue

System Performance Check Data (5800MHz Body)

Type: Phone measurement (Complete)
 E-Field Probe: SN 34/15 SSE2 EPGO265
 Area scan resolution: dx=8mm,dy=8mm
 Zoom scan resolution: dx=4 mm, dy=4 mm, dz=2 mm
 Date of measurement: 2019.03.20
 Measurement duration: 27 minutes 43 seconds

Experimental conditions.

Phantom File	surf_sam_plan.txt
Phantom	Validation plane
Band	5800 MHz
Signal	CW
Frequency (MHz)	5800.000000
Relative permittivity (real part)	46.938374
Conductivity (S/m)	6.175258
Power drift (%)	0.410000
Ambient Temperature:	22.5°C
Liquid Temperature:	21.3°C
ConvF:	2.22
Crest factor:	1:1

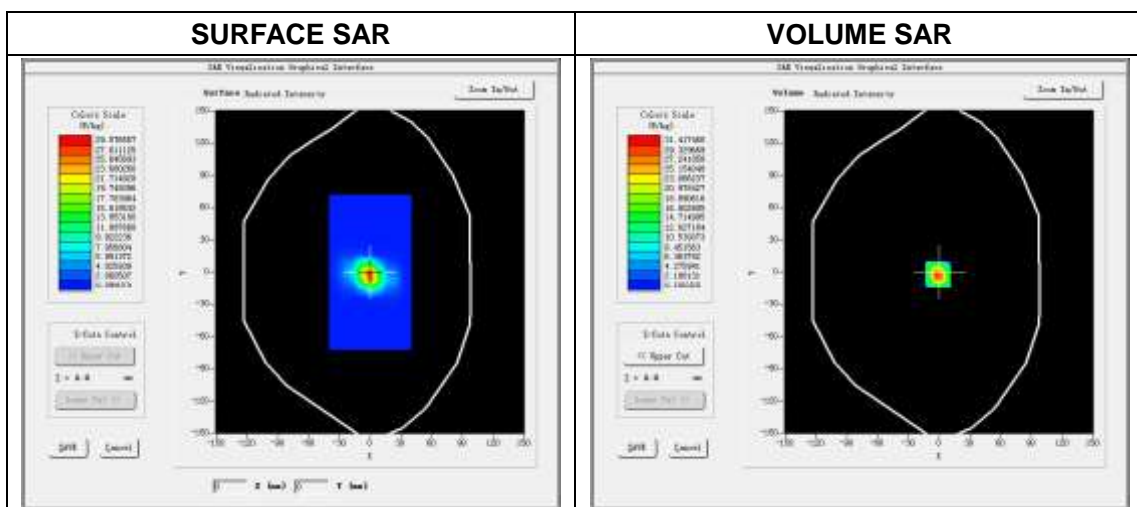

Maximum location: X=0.00, Y=0.00

SAR Peak: 52.38 W/kg

SAR 10 g (W/Kg)	5.804359
SAR 1g (W/Kg)	17.517314

Z Axis Scan

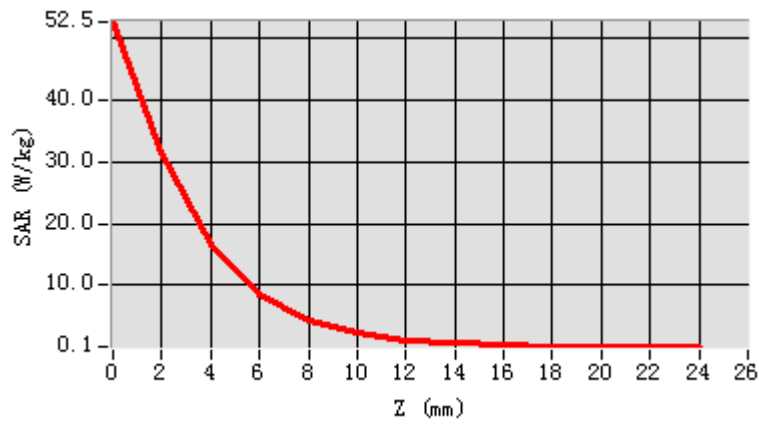

3D screen shot

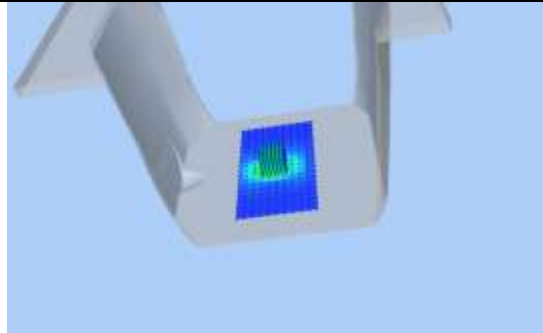

Hot spot position

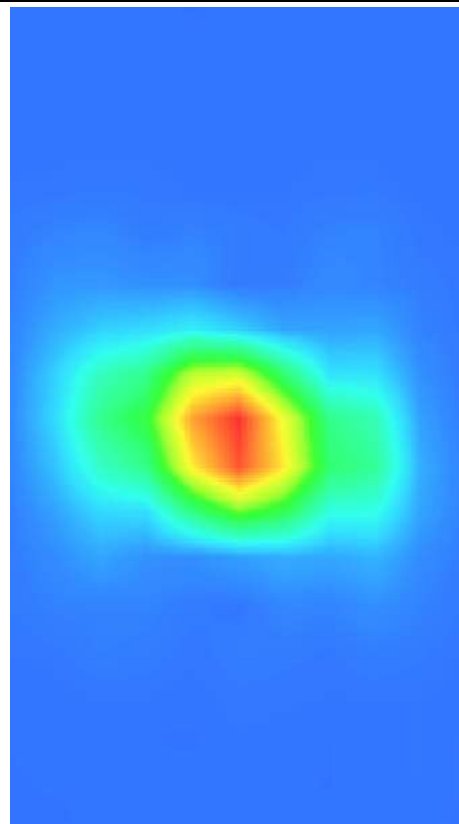

--END OF REPORT--