



FCC RF Test Report

APPLICANT : vivo Mobile Communication Co., Ltd.
EQUIPMENT : Mobile Phone
BRAND NAME : vivo
MODEL NAME : V2349
FCC ID : 2AUCY-V2349
STANDARD : 47 CFR Part 2, and 90(S)
CLASSIFICATION : PCS Licensed Transmitter Held to Ear (PCE)
TEST DATE(S) : Jan. 16, 2024 ~ Jan. 17, 2024

We, Sporton International Inc. (Shenzhen), would like to declare that the tested sample has been evaluated in accordance with the procedures given in ANSI C63.26-2015 and shown compliance with the applicable technical standards.

The test results in this report apply exclusively to the tested model / sample. Without written approval of Sporton International Inc. (Shenzhen), the test report shall not be reproduced except in full.

Jason Jia



Approved by: Jason Jia

Sporton International Inc. (ShenZhen)

1/F, 2/F, Bldg 5, Shiling Industrial Zone, Xinwei Village, Xili, Nanshan, Shenzhen, 518055

People's Republic of China



TABLE OF CONTENTS

REVISION HISTORY..... 3

SUMMARY OF TEST RESULT 4

1 GENERAL DESCRIPTION 5

1.1 Applicant..... 5

1.2 Manufacturer 5

1.3 Feature of Equipment Under Test..... 5

1.4 Product Specification of Equipment Under Test 5

1.5 Modification of EUT 6

1.6 Maximum Conducted Power and Emission Designator 6

1.7 Testing Site..... 6

1.8 Test Software 7

1.9 Applied Standards 7

2 TEST CONFIGURATION OF EQUIPMENT UNDER TEST 8

2.1 Test Mode..... 8

2.2 Connection Diagram of Test System 9

2.3 Support Unit used in test configuration and system 9

2.4 Measurement Results Explanation Example 9

2.5 Frequency List of Low/Middle/High Channels 10

3 TEST RESULT 11

3.1 Conducted Output Power Measurement 11

3.2 99% Occupied Bandwidth and 26dB Bandwidth Measurement..... 12

3.3 Emissions Mask Measurement 13

3.4 Emissions Mask – Out Of Band Emissions Measurement..... 15

3.5 Field Strength of Spurious Radiation Measurement 16

3.6 Frequency Stability Measurement..... 19

4 LIST OF MEASURING EQUIPMENT 21

5 MEASUREMENT UNCERTAINTY 22

APPENDIX A. TEST RESULTS OF CONDUCTED TEST

APPENDIX B. TEST RESULTS OF RADIATED TEST

APPENDIX C. TEST SETUP PHOTOGRAPHS



SUMMARY OF TEST RESULT

Report Section	FCC Rule	Description	Limit	Result	Remark
3.1	§2.1046	Conducted Output Power	—	Report only	-
3.2	§2.1049 §90.209	Occupied Bandwidth and 26dB Bandwidth	—	Report only	-
3.3	§2.1051 §90.691	Emission masks – In-band emissions	$< 50+10\log_{10}(P[\text{Watts}])$	PASS	-
3.4	§2.1051 §90.691	Emission masks – Out of band emissions	$< 43+10\log_{10}(P[\text{Watts}])$	PASS	-
3.5	§2.1053 §90.691	Field Strength of Spurious Radiation	$< 43+10\log_{10}(P[\text{Watts}])$	PASS	Under limit 51.16 dB at 3258.00 MHz
3.6	§2.1055 §90.213	Frequency Stability for Temperature & Voltage	$< 2.5 \text{ ppm}$	PASS	-

Conformity Assessment Condition:

1. The test results (PASS/FAIL) with all measurement uncertainty excluded are presented against the regulation limits or in accordance with the requirements stipulated by the applicant/matrix manufacturer who shall bear all the risks of non-compliance that may potentially occur if measurement uncertainty is taken into account.
2. The measurement uncertainty please refer to each test result in the section "Measurement Uncertainty"

Disclaimer:

The product specifications of the EUT presented in the test report that may affect the test assessments are declared by the manufacturer who shall take full responsibility for the authenticity.



1 General Description

1.1 Applicant

vivo Mobile Communication Co., Ltd.
No.1, vivo Road, Chang'an, Dongguan, Guangdong, China

1.2 Manufacturer

vivo Mobile Communication Co., Ltd.
No.1, vivo Road, Chang'an, Dongguan, Guangdong, China

1.3 Feature of Equipment Under Test

Product Feature	
Equipment	Mobile Phone
Brand Name	vivo
Model Name	V2349
FCC ID	2AUCY-V2349
IMEI Code	Conducted: 355199400022373/355199400022381 Radiation: 865264079978645/865264079978652
HW Version	MP_0.1
SW Version	PD2341EF_EX_A_14.0.6.16.W30
EUT Stage	Identical Prototype

Remark: The above EUT's information was declared by manufacturer. Please refer to the specifications or user's manual for more detailed description.

1.4 Product Specification of Equipment Under Test

Product Specification subjective to this standard	
Tx Frequency	814 ~ 824 MHz
Rx Frequency	859 ~ 869 MHz
Bandwidth	1.4MHz / 3MHz / 5MHz / 10MHz / 15MHz
Maximum Output Power to Antenna	<Ant.13> 23.40 dBm <Ant.31> 23.38 dBm
Antenna Gain	<Ant.13> -3.91 dBi <Ant.31> -5.38 dBi
Type of Modulation	QPSK / 16QAM / 64QAM / 256QAM

Note: Only maximum conducted Power of Ant.13 is shown in the report.



1.5 Modification of EUT

No modifications are made to the EUT during all test items.

1.6 Maximum Conducted Power and Emission Designator

LTE Band 26		QPSK		16QAM/64QAM/256QAM	
BW (MHz)	Frequency Range (MHz)	Maximum Conducted Power (W)	Emission Designator (99%OBW)	Maximum Conducted Power (W)	Emission Designator (99%OBW)
1.4	814.7 ~ 823.3	0.2168	1M09G7D	0.1901	1M09W7D
3	815.5 ~ 822.5	0.2138	2M72G7D	0.1875	2M73W7D
5	816.5 ~ 821.5	0.2148	4M51G7D	0.1875	4M52W7D
10	819.0	0.2138	9M01G7D	0.1866	8M99W7D
15	824	0.2188	13M5G7D	0.1982	13M5W7D

Note: All modulations have been tested, and only the worst test results are shown in the report.

1.7 Testing Site

Sporton International Inc. (ShenZhen) is accredited to ISO/IEC 17025:2017 by American Association for Laboratory Accreditation with Certificate Number 5145.01.

Test Firm	Sporton International Inc. (ShenZhen)		
Test Site Location	1/F, 2/F, Bldg 5, Shiling Industrial Zone, Xinwei Village, Xili, Nanshan, Shenzhen, 518055 People’s Republic of China TEL: +86-755-86379589 FAX: +86-755-86379595		
Test Site No.	Sporton Site No.	FCC Designation No.	FCC Test Firm Registration No.
	TH01-SZ	CN1256	421272

Test Firm	Sporton International Inc. (ShenZhen)		
Test Site Location	101, 1st Floor, Block B, Building 1, No. 2, Tengfeng 4th Road, Fenghuang Community, Fuyong Street, Baoan District, Shenzhen City, Guangdong Province 518103 People’s Republic of China TEL: +86-755-86066985		
Test Site No.	Sporton Site No.	FCC Designation No.	FCC Test Firm Registration No.
	03CH03-SZ	CN1256	421272



1.8 Test Software

Item	Site	Manufacture	Name	Version
1.	03CH03-SZ	AUDIX	E3	6.2009-8-24

1.9 Applied Standards

According to the specifications of the manufacturer, the EUT must comply with the requirements of the following standards:

- ♦ 47 CFR Part 2, 90(S)
- ♦ ANSI C63.26-2015
- ♦ FCC KDB 971168 D01 Power Meas. License Digital Systems v03r01
- ♦ FCC KDB 971168 D02 Misc Rev Approv License Devices v02r01

Remark:

1. All test items were verified and recorded according to the standards and without any deviation during the test.
2. This EUT has also been tested and complied with the requirements of FCC Part 15, Subpart B, recorded in a separate test report.



2 Test Configuration of Equipment Under Test

2.1 Test Mode

During all testing, EUT is in link mode with base station emulator at maximum power level. The spurious emission measurements were carried out in semi-anechoic chamber with 3-meter test range, and EUT is rotated on three test planes to find out the worst emission.

Frequency range investigated for radiated emission is 30 MHz to 9000 MHz. (X Plane)

Test Items	Band	Bandwidth (MHz)						Modulation				RB #			Test Channel		
		1.4	3	5	10	15	20	QPSK	16 QAM	64 QAM	256 QAM	1	Half	Full	L	M	H
Max. Output Power	26	v	v	v	v	v	-	v	v	v	v	v	v	v			
26dB and 99% Bandwidth	26	v	v	v	v	v	-	v	v					v		v	v
Emission masks In-band emissions	26	v	v	v	v	v	-	v	v	v		v		v	v		v
Emission masks – Out of band emissions	26	v	v	v	v	v	-	v				v			v	v	v
Frequency Stability	26				v		-	v						v		v	
Radiated Spurious Emission	26				v		-	v				v				v	
Note	<ol style="list-style-type: none"> The mark “v ” means that this configuration is chosen for testing The mark “-“ means that this bandwidth is not supported. LTE Band26 transmit frequency for part22 rule is 824MHz-849MHz, for part90 rule is 814MHz-824MHz. ERP over 15MHz bandwidth complies the ERP limit line of part22 rule, therefore ERP of the partial frequency spectrum which falls within part 22 also complies. For QAM modulation mode, the whole testing has assessed 16QAM&64QAM mode by referring to the higher conducted power. 																

2.2 Connection Diagram of Test System

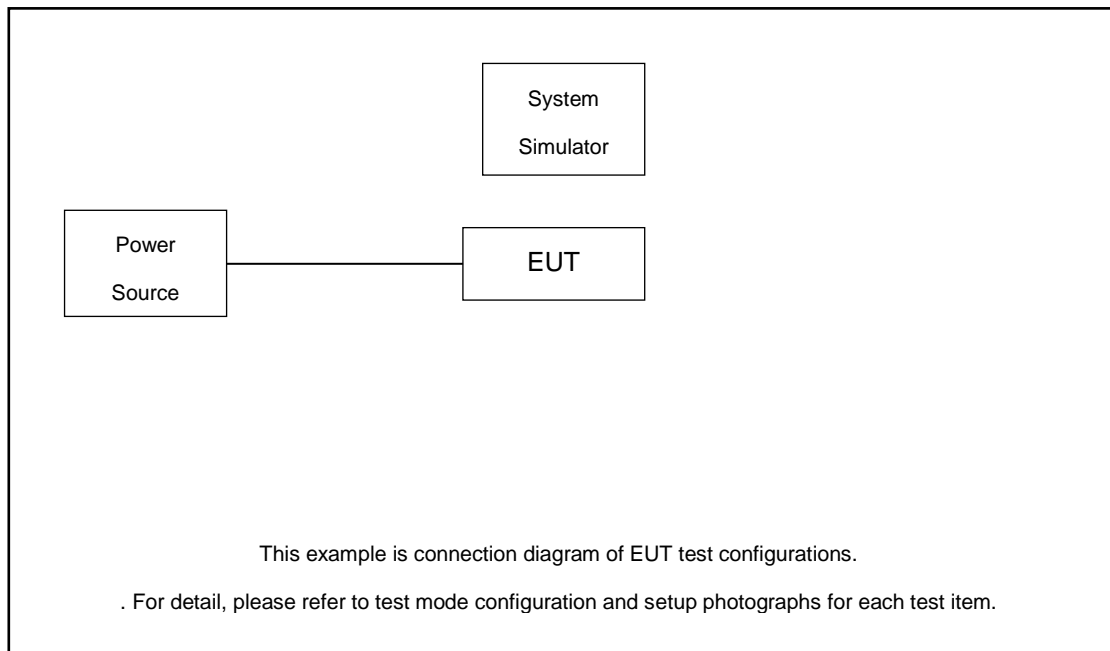

2.3 Support Unit used in test configuration and system

Item	Equipment	Trade Name	Model No.	FCC ID	Data Cable	Power Cord
1.	System Simulator	Anritsu	MT8820C	N/A	N/A	Unshielded, 1.8 m

2.4 Measurement Results Explanation Example

For all conducted test items:

The offset level is set in the spectrum analyzer to compensate the RF cable loss and attenuator factor between RF conducted output port and spectrum analyzer. With the offset compensation, the spectrum analyzer reading level will be exactly the RF output level.

The spectrum analyzer offset is derived from RF cable loss and attenuator factor.

Offset = RF cable loss + attenuator factor.

The following shows an offset computation example with RF cable loss 4.0 dB and a 10dB attenuator.

Example :

$$\begin{aligned} \text{Offset(dB)} &= \text{RF cable loss(dB)} + \text{attenuator factor(dB)}. \\ &= 4.0 + 10 = 14.0 \text{ (dB)} \end{aligned}$$



2.5 Frequency List of Low/Middle/High Channels

LTE Band 26 Channel and Frequency List				
BW [MHz]	Channel/Frequency(MHz)	Lowest	Middle	Highest
10	Channel	-	26740	-
	Frequency	-	819	-
5	Channel	26715	26740	26765
	Frequency	816.5	819	821.5
3	Channel	26705	26740	26775
	Frequency	815.5	819	822.5
1.4	Channel	26697	26740	26783
	Frequency	814.7	819	823.3

LTE Band 26 Cross-rule Channel and Frequency List				
BW [MHz]	Channel/Frequency(MHz)	-	Middle	-
15	Channel	-	26790	-
	Frequency	-	824	-
10	Channel	-	26790	-
	Frequency	-	824	-
5	Channel	-	26790	-
	Frequency	-	824	-
3	Channel	-	26790	-
	Frequency	-	824	-
1.4	Channel	-	26790	-
	Frequency	-	824	-

3 Test Result

3.1 Conducted Output Power Measurement

3.1.1 Description of the Conducted Output Power Measurement

A system simulator was used to establish communication with the EUT. Its parameters were set to enforce EUT transmitting at the maximum power. The measured power in the radio frequency on the transmitter output terminals shall be reported.

3.1.2 Measuring Instruments

The measuring equipment is listed in the section 4 of this test report.

3.1.3 Test Procedures

1. The transmitter output port was connected to the system simulator.
2. Set EUT at maximum power through the system simulator.
3. Select lowest, middle, and highest channels for each band and different modulation.
4. Measure and record the power level from the system simulator.

3.1.4 Test Setup

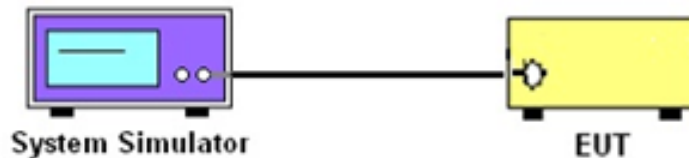

3.1.5 Test Result of Conducted Output Power

Please refer to Appendix A.

3.2 99% Occupied Bandwidth and 26dB Bandwidth Measurement

3.2.1 Description of (Occupied) Bandwidth Limitations Measurement

The 99% occupied bandwidth is the width of a frequency band such that, below the lower and above the upper frequency limits, the mean powers emitted are each equal to a specified percentage 0.5% of the total mean transmitted power.

The emission bandwidth is defined as the width of the signal between two points, located at the 2 sides of the carrier frequency, outside of which all emissions are attenuated at least 26 dB below the transmitter power.

3.2.2 Measuring Instruments

The measuring equipment is listed in the section 4 of this test report.

3.2.3 Test Procedures

1. The EUT was connected to spectrum analyzer and system simulator via a power divider.
2. The 26dB and 99% occupied bandwidth (BW) of the middle channel for the highest RF power with full RB sizes were measured.

3.2.4 Test Setup

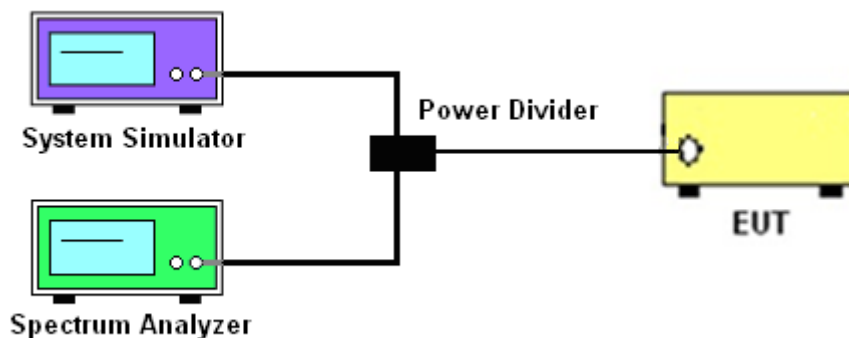

3.2.5 Test Result of 99% Occupied Bandwidth and 26dB Bandwidth

Please refer to Appendix A.



3.3 Emissions Mask Measurement

3.3.1 Description of Emissions Mask Measurement

Equipment used in this licensed to EA or non-EA systems shall comply with the emission mask provisions of FCC Part 90.691.(a):

(a) Out-of-band emission requirement shall apply only to the “outer” channels included in an EA license and to spectrum adjacent to interior channels used by incumbent licensees. The emission limits are as follows:

(1) For any frequency removed from the EA licensee's frequency block by up to and including 37.5 kHz, the power of any emission shall be attenuated below the transmitter power (P) in watts by at least $116 \text{ Log}_{10}(f/6.1)$ decibels or $50 + 10 \text{ Log}_{10}(P)$ decibels or 80 decibels, whichever is the lesser attenuation, where f is the frequency removed from the center of the outer channel in the block in kilohertz and where f is greater than 12.5 kHz.

(2) For any frequency removed from the EA licensee's frequency block greater than 37.5 kHz, the power of any emission shall be attenuated below the transmitter power (P) in watts by at least $43 + 10 \text{ Log}_{10}(P)$ decibels or 80 decibels, whichever is the lesser attenuation, where f is the frequency removed from the center of the outer channel in the block in kilohertz and where f is greater than 37.5 kHz.

3.3.2 Measuring Instruments

The measuring equipment is listed in the section 4 of this test report.

3.3.3 Test Procedures

1. The EUT was connected to spectrum analyzer and base station via power divider.
2. The emissions mask of low and high channels for the highest RF powers were measured.
3. The measured RBW and the VBW set 3 times of RBW are then set in spectrum analyzer, and the RBW correction factor $10 \log (1\% \text{ of OBW}/\text{measured RBW})(\text{dB})$ was compensated, if required.
4. The test results were shown below plots with a correction offset factor including cable loss, insertion loss of power divider.

3.3.4 Test Setup

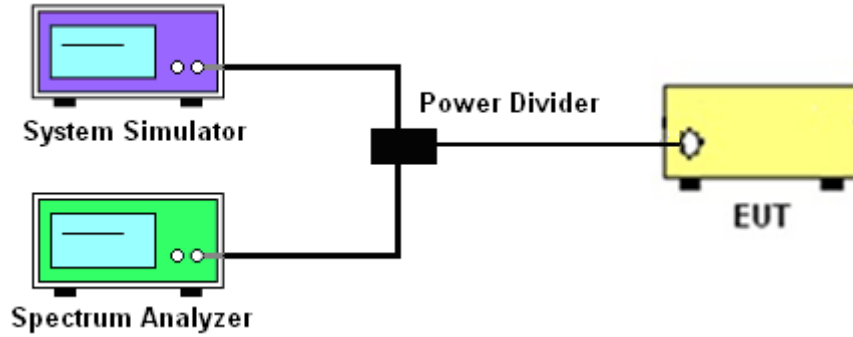

3.3.5 Test Result (Plots) of Conducted Emissions Mask

Please refer to Appendix A.

3.4 Emissions Mask – Out Of Band Emissions Measurement

3.4.1 Description of Conducted Emissions Out of band emissions measurement

The power of any emission FCC Part 90.691 (a)(2) on any frequency removed from the assigned frequency by out of the authorized bandwidth at least $43 + 10 \log (P)$ dB. It is measured by means of a calibrated spectrum analyzer and scanned from 30 MHz up to a frequency including its 10th harmonic.

3.4.2 Measuring Instruments

The measuring equipment is listed in the section 4 of this test report.

3.4.3 Test Procedures

1. The EUT was connected to spectrum analyzer and system simulator via a power divider.
2. The RF output of EUT was connected to the spectrum analyzer by RF cable and attenuator. The path loss was compensated to the results for each measurement.
3. The middle channel for the highest RF power within the transmitting frequency was measured.
4. The conducted spurious emission for the whole frequency range was taken.
5. Make the measurement with the spectrum analyzer's RBW = 1MHz, VBW = 3MHz, taking the record of maximum spurious emission.
6. The RF fundamental frequency should be excluded against the limit line in the operating frequency band.
7. The limit line is derived from $43 + 10\log(P)$ dB below the transmitter power P(Watts)

3.4.4 Test Setup

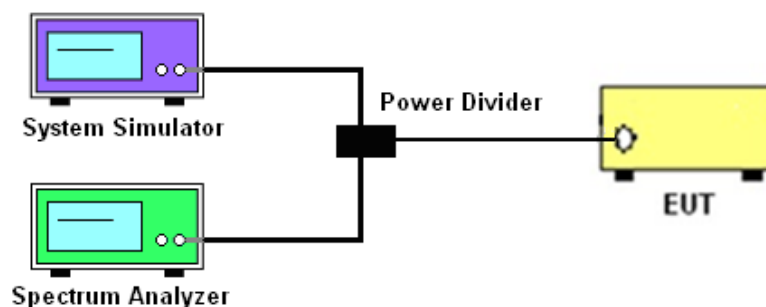

3.4.5 Test Result (Plots) of Conducted Emission

Please refer to Appendix A.



3.5 Field Strength of Spurious Radiation Measurement

3.5.1 Description of Field Strength of Spurious Radiated Measurement

The radiated spurious emission was measured by substitution method according to ANSI/TIA-603-E. The power of any emission FCC Part 90.691 on any frequency removed from the assigned frequency by more than 250 percent of the authorized bandwidth at least $43 + 10 \log (P)$ dB. The spectrum is scanned from 30 MHz up to a frequency including its 10th harmonic.

The power of any emission outside of the authorized operating frequency ranges must be attenuated below the transmitter power (P) by a factor of at least $43 + 10 \log_{10}(P[\text{Watts}])$ dB. The spectrum is scanned from 30 MHz up to a frequency including its 10th harmonic.

3.5.2 Measuring Instruments

The measuring equipment is listed in the section 4 of this test report.

3.5.3 Test Procedures

1. The EUT was placed on a turntable with 0.8 meter for frequency below 1GHz and 1.5 meter for frequency above 1GHz respectively above ground.
2. The EUT was set 3 meters from the receiving antenna, which was mounted on the antenna tower.
3. The table was rotated 360 degrees to determine the position of the highest spurious emission.
4. The height of the receiving antenna is varied between one meter and four meters to search the maximum spurious emission for both horizontal and vertical polarizations.
5. Make the measurement with the spectrum analyzer's RBW = 1MHz, VBW = 3MHz, Sweep = 500ms, Taking the record of maximum spurious emission.
6. A horn antenna was substituted in place of the EUT and was driven by a signal generator.
7. Tune the output power of signal generator to the same emission level with EUT maximum spurious emission.
8. Taking the record of output power at antenna port.
9. Repeat step 7 to step 8 for another polarization.
10. $\text{EIRP (dBm)} = \text{S.G. Power} - \text{Tx Cable Loss} + \text{Tx Antenna Gain}$
11. $\text{ERP (dBm)} = \text{EIRP} - 2.15$
12. The RF fundamental frequency should be excluded against the limit line in the operating frequency band.
13. The limit line is derived from $43 + 10 \log(P)$ dB below the transmitter power P(Watts)

3.5.4 Test Setup

For radiated test from 30MHz

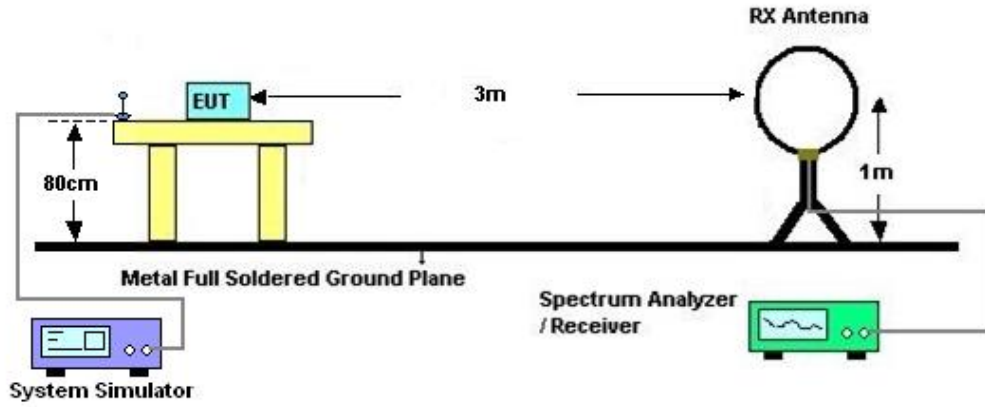

For radiated test from 30MHz to 1GHz

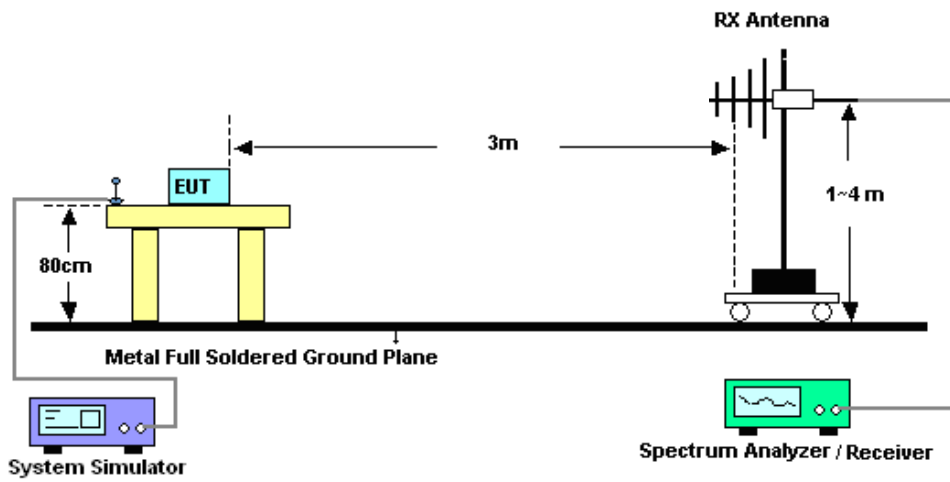

For radiated test above 1GHz

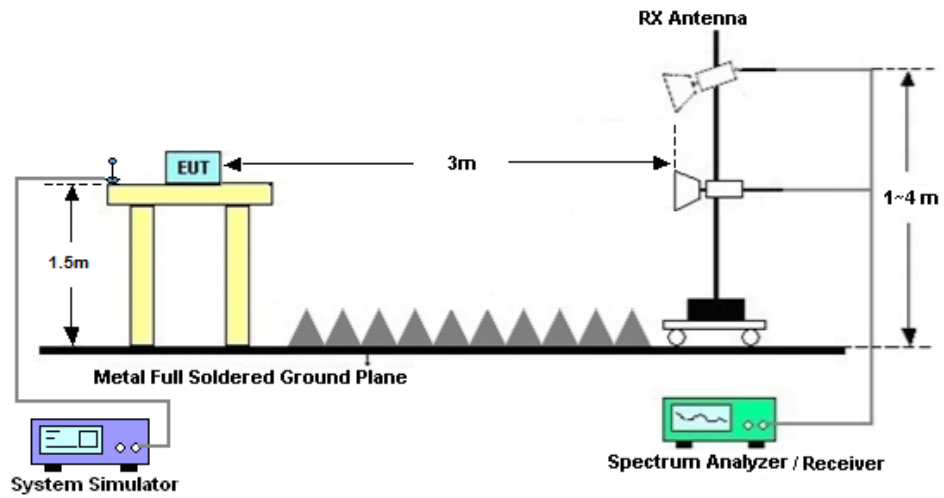

3.5.5 Test Result of Field Strength of Spurious Radiated

The low frequency, which started from 9 kHz to 30MHz, was pre-scanned and the result which was 20dB lower than the limit line was not reported.

Please refer to Appendix B.

3.6 Frequency Stability Measurement

3.6.1 Description of Frequency Stability Measurement

The frequency stability shall be measured by variation of ambient temperature and variation of primary supply voltage to ensure that the fundamental emission stays within the authorized frequency block. The frequency stability of the transmitter shall be maintained within $\pm 0.00025\%$ ($\pm 2.5\text{ppm}$) of the center frequency according to FCC Part 90.213.

3.6.2 Measuring Instruments

The measuring equipment is listed in the section 4 of this test report.

3.6.3 Test Procedures for Temperature Variation

1. The EUT was set up in the thermal chamber and connected with the base station.
2. With power OFF, the temperature was decreased to -30°C and the EUT was stabilized for three hours. Power was applied and the maximum change in frequency was recorded within one minute.
3. With power OFF, the temperature was raised in 10°C step up to 50°C . The EUT was stabilized at each step for at least half an hour. Power was applied and the maximum frequency change was recorded within one minute.

3.6.4 Test Procedures for Voltage Variation

1. The EUT was placed in a temperature chamber at $20\pm 5^{\circ}\text{C}$ and connected with the system simulator.
2. The power supply voltage to the EUT was varied from 85% to 115% of the nominal value for other than hand carried battery equipment.
3. For hand carried, battery powered equipment, reduce the primary ac or dc supply voltage to the battery operating end point, which shall be specified by the manufacturer.
4. The variation in frequency was measured for the worst case.

3.6.5 Test Setup

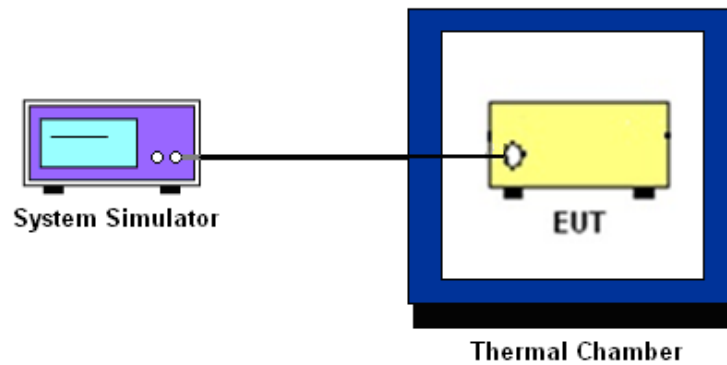

3.6.6 Test Result of Temperature Variation

Please refer to Appendix A.



4 List of Measuring Equipment

Instrument	Manufacturer	Model No.	Serial No.	Characteristics	Calibration Date	Test Date	Due Date	Remark
Spectrum Analyzer	R&S	FSV40	101078	10Hz~40GHz	Apr. 06, 2023	Jan. 16, 2024	Apr. 05, 2024	Conducted (TH01-SZ)
DC Power Supply	TTI	PL330P	290070	Max 32V , 3A	Oct. 16, 2023	Jan. 16, 2024	Oct. 15, 2024	Conducted (TH01-SZ)
Power Divider	TOJOIN	PS-2SM-04 265	60.06.020.0 077	0.4GHz~26.5G Hz	Dec. 25, 2023	Jan. 16, 2024	Dec. 24, 2024	Conducted (TH01-SZ)
Thermal Chamber	Ten Billion Hongzhangrou P	LP-150U	H201408180 3	-40~+150°C	Jul. 05, 2023	Jan. 16, 2024	Jul. 04, 2024	Conducted (TH01-SZ)
EMI Test Receiver&SA	KEYSIGHT	N9038A	MY5445008 3	20Hz~8.4GHz	Apr. 04, 2023	Jan. 17, 2024	Apr. 03, 2024	Radiation (03CH03-SZ)
EXA Spectrum Analyzer	KEYSIGHT	N9010A	MY5515024 6	10Hz~44GHz;	Apr. 04, 2023	Jan. 17, 2024	Apr. 03, 2024	Radiation (03CH03-SZ)
Loop Antenna	R&S	HFH2-Z2	100354	9kHz~30MHz	Jun. 28, 2022	Jan. 17, 2024	Jun. 27, 2024	Radiation (03CH03-SZ)
Bilog Antenna	TeseQ	CBL6112D	35408	30MHz~2GHz	Aug. 20, 2023	Jan. 17, 2024	Aug. 19, 2025	Radiation (03CH03-SZ)
Double Ridge Horn Antenna	SCHWARZBE CK	BBHA9120 D	9120D-1355	1GHz~18GHz	Apr. 08, 2023	Jan. 17, 2024	Apr. 07, 2024	Radiation (03CH03-SZ)
SHF-EHF Horn	com-power	AH-840	101071	18Ghz~40GHz	Apr. 08, 2023	Jan. 17, 2024	Apr. 07, 2024	Radiation (03CH03-SZ)
Amplifier	Burgeon	BPA-530	102211	0.01Hz ~3000MHz	Oct. 18, 2023	Jan. 17, 2024	Oct. 17, 2024	Radiation (03CH03-SZ)
HF Amplifier	MITEQ	TTA1840-35 -HG	1871923	18GHz~40GHz	Jul. 07, 2023	Jan. 17, 2024	Jul. 06, 2024	Radiation (03CH03-SZ)
Amplifier	Agilent Technologies	83017A	MY3950130 2	500MHz~26.5G Hz	Dec. 27, 2023	Jan. 17, 2024	Dec. 26, 2024	Radiation (03CH03-SZ)
AC Power Source	Chroma	61601	6160100027 29	N/A	Oct. 18, 2023	Jan. 17, 2024	Oct. 17, 2024	Radiation (03CH03-SZ)
Turn Table	EM	EM1000	N/A	0~360 degree	NCR	Jan. 17, 2024	NCR	Radiation (03CH03-SZ)
Antenna Mast	EM	EM1000	N/A	1 m~4 m	NCR	Jan. 17, 2024	NCR	Radiation (03CH03-SZ)
Thermo meter	Anymetre	JR593	#11	- 10°C ~ 50°C 10%RH~99%RH	Oct. 19, 2023	Jan. 17, 2024	Oct. 18, 2024	Radiation (03CH03-SZ)

NCR: No Calibration Required



5 Measurement Uncertainty

The measurement uncertainties shown below were calculated in accordance with the requirements of ANSI 63.26-2015. All the measurement uncertainty value were shown with a coverage K=2 to indicate 95% level of confidence. The measurement data show herein meets or exceeds the CISPR measurement uncertainty values specified in CISPR 16-4-2 and can be compared directly to specified limit to determine compliance.

Uncertainty of Conducted Measurement

Test Item	Uncertainty
Conducted Spurious Emission & Bandedge	±1.34 dB
Occupied Channel Bandwidth	±0.012 MHz
Conducted Power	±1.34 dB
Peak to Average Ratio	±1.34 dB
Frequency Stability	±1.3 Hz

Uncertainty of Radiated Emission Measurement (9 KHz ~ 30 MHz)

Measuring Uncertainty for a Level of Confidence of 95% (U = 2Uc(y))	2.8 dB
---	--------

Uncertainty of Radiated Emission Measurement (30 MHz ~ 1 GHz)

Measuring Uncertainty for a Level of Confidence of 95% (U = 2Uc(y))	3.0 dB
---	--------

Uncertainty of Radiated Emission Measurement (1 GHz ~ 18 GHz)

Measuring Uncertainty for a Level of Confidence of 95% (U = 2Uc(y))	3.6 dB
---	--------

Uncertainty of Radiated Emission Measurement (18 GHz ~ 40 GHz)

Measuring Uncertainty for a Level of Confidence of 95% (U = 2Uc(y))	3.8 dB
---	--------

----- THE END -----



Appendix A. Test Results of Conducted Test

Test Engineer :	Hank Lin	Temperature :	24~26°C
		Relative Humidity :	50~53%

Conducted Output Power (Average power)

LTE Band 26_Part 90S_Ant.13:

BW [MHz]	Modulation	RB Size	RB Offset	Power Low Ch. / Freq.	Power Middle Ch. / Freq.	Power High Ch. / Freq.
Channel				26765		
Frequency (MHz)				821.5		
15	QPSK	1	0	23.36		
15	QPSK	1	37	23.40		
15	QPSK	1	74	23.34		
15	QPSK	36	0	22.51		
15	QPSK	36	20	22.47		
15	QPSK	36	39	22.47		
15	QPSK	75	0	22.40		
15	16QAM	1	0	22.58		
15	16QAM	1	37	22.97		
15	16QAM	1	74	22.38		
15	16QAM	36	0	21.46		
15	16QAM	36	20	21.50		
15	16QAM	36	39	21.63		
15	16QAM	75	0	21.47		
15	64QAM	1	0	21.71		
15	64QAM	1	37	21.35		
15	64QAM	1	74	21.23		
15	64QAM	36	0	20.56		
15	64QAM	36	20	20.63		
15	64QAM	36	39	20.52		
15	64QAM	75	0	20.54		
15	256QAM	1	0	18.89		
15	256QAM	1	37	18.90		
15	256QAM	1	74	19.06		
15	256QAM	36	0	18.93		
15	256QAM	36	20	18.95		
15	256QAM	36	39	19.02		
15	256QAM	75	0	18.83		
Channel					26740	
Frequency (MHz)					819	
10	QPSK	1	0		23.04	



10	QPSK	1	25		23.30	
10	QPSK	1	49		23.11	
10	QPSK	25	0		22.15	
10	QPSK	25	12		22.21	
10	QPSK	25	25		22.33	
10	QPSK	50	0		22.17	
10	16QAM	1	0		22.71	
10	16QAM	1	25		22.65	
10	16QAM	1	49		22.67	
10	16QAM	25	0		21.26	
10	16QAM	25	12		21.31	
10	16QAM	25	25		21.24	
10	16QAM	50	0		21.24	
10	64QAM	1	0		21.52	
10	64QAM	1	25		21.12	
10	64QAM	1	49		21.00	
10	64QAM	25	0		20.26	
10	64QAM	25	12		20.24	
10	64QAM	25	25		20.27	
10	64QAM	50	0		20.25	
10	256QAM	1	0		18.85	
10	256QAM	1	25		18.79	
10	256QAM	1	49		19.03	
10	256QAM	25	0		18.94	
10	256QAM	25	12		18.95	
10	256QAM	25	25		18.97	
10	256QAM	50	0		18.87	
Channel				26715	26740	26765
Frequency (MHz)				816.5	819	821.5
5	QPSK	1	0	23.14	23.05	23.02
5	QPSK	1	12	23.15	23.32	23.18
5	QPSK	1	24	23.11	23.07	23.05
5	QPSK	12	0	22.25	22.11	22.25
5	QPSK	12	7	22.28	22.20	22.27
5	QPSK	12	13	22.28	22.34	22.32
5	QPSK	25	0	22.43	22.19	22.23
5	16QAM	1	0	22.41	22.70	22.13
5	16QAM	1	12	22.73	22.60	22.41
5	16QAM	1	24	22.21	22.60	22.41
5	16QAM	12	0	21.21	21.26	21.29
5	16QAM	12	7	21.25	21.30	21.36
5	16QAM	12	13	21.41	21.25	21.27
5	16QAM	25	0	21.30	21.23	21.17
5	64QAM	1	0	21.46	21.53	21.36
5	64QAM	1	12	21.17	21.07	21.64
5	64QAM	1	24	21.01	21.07	21.47
5	64QAM	12	0	20.36	20.20	20.25



5	64QAM	12	7	20.44	20.22	20.23
5	64QAM	12	13	20.34	20.29	20.27
5	64QAM	25	0	20.29	20.19	20.20
5	256QAM	1	0	18.82	18.96	18.81
5	256QAM	1	12	18.87	18.79	18.91
5	256QAM	1	24	18.97	19.08	19.02
5	256QAM	12	0	18.89	18.87	18.81
5	256QAM	12	7	18.87	18.92	18.80
5	256QAM	12	13	18.96	19.06	18.95
5	256QAM	25	0	18.77	18.99	18.78
Channel				26705	26740	26775
Frequency (MHz)				815.5	819	822.5
3	QPSK	1	0	23.15	23.09	23.03
3	QPSK	1	8	23.18	23.30	23.20
3	QPSK	1	14	23.18	23.07	23.05
3	QPSK	8	0	22.31	22.18	22.23
3	QPSK	8	4	22.22	22.12	22.28
3	QPSK	8	7	22.28	22.36	22.32
3	QPSK	15	0	22.41	22.16	22.24
3	16QAM	1	0	22.39	22.68	22.07
3	16QAM	1	8	22.73	22.67	22.36
3	16QAM	1	14	22.14	22.62	22.41
3	16QAM	8	0	21.28	21.26	21.28
3	16QAM	8	4	21.28	21.33	21.41
3	16QAM	8	7	21.44	21.23	21.24
3	16QAM	15	0	21.26	21.28	21.20
3	64QAM	1	0	21.51	21.54	21.41
3	64QAM	1	8	21.14	21.11	21.64
3	64QAM	1	14	21.05	21.07	21.52
3	64QAM	8	0	20.36	20.23	20.29
3	64QAM	8	4	20.41	20.26	20.18
3	64QAM	8	7	20.32	20.28	20.26
3	64QAM	15	0	20.36	20.26	20.15
3	256QAM	1	0	18.81	18.86	18.82
3	256QAM	1	8	18.89	18.89	18.86
3	256QAM	1	14	18.94	19.07	19.04
3	256QAM	8	0	18.79	18.85	18.96
3	256QAM	8	4	18.82	18.96	18.87
3	256QAM	8	7	19.02	18.95	18.84
3	256QAM	15	0	18.68	18.96	18.73
Channel				26697	26740	26783
Frequency (MHz)				814.7	819	823.3
1.4	QPSK	1	0	23.18	23.05	23.02
1.4	QPSK	1	3	23.24	23.36	23.20
1.4	QPSK	1	5	23.11	23.08	23.07
1.4	QPSK	3	0	23.08	23.01	23.02
1.4	QPSK	3	1	23.19	23.29	23.15



1.4	QPSK	3	3	23.10	23.02	23.00
1.4	QPSK	6	0	22.43	22.18	22.26
1.4	16QAM	1	0	22.38	22.68	22.06
1.4	16QAM	1	3	22.79	22.60	22.41
1.4	16QAM	1	5	22.16	22.60	22.36
1.4	16QAM	3	0	22.36	22.63	22.05
1.4	16QAM	3	1	22.69	22.55	22.32
1.4	16QAM	3	3	22.09	22.50	22.34
1.4	16QAM	6	0	21.23	21.29	21.22
1.4	64QAM	1	0	21.52	21.47	21.38
1.4	64QAM	1	3	21.16	21.07	21.68
1.4	64QAM	1	5	21.00	21.08	21.53
1.4	64QAM	3	0	21.50	21.40	21.31
1.4	64QAM	3	1	21.14	21.00	21.63
1.4	64QAM	3	3	21.02	21.01	21.46
1.4	64QAM	6	0	20.37	20.26	20.23
1.4	256QAM	1	0	18.86	18.89	18.95
1.4	256QAM	1	3	18.93	18.94	18.82
1.4	256QAM	1	5	19.03	18.92	19.03
1.4	256QAM	3	0	18.91	18.96	18.82
1.4	256QAM	3	1	18.94	18.86	18.73
1.4	256QAM	3	3	18.95	19.04	18.89
1.4	256QAM	6	0	18.86	18.86	18.75



LTE Band 26_Part 90S

26dB Bandwidth

Mode	LTE Band 26 : 26dB BW(MHz)											
	1.4MHz		3MHz		5MHz		10MHz		15MHz			
BW	1.4MHz	1.4MHz	3MHz	3MHz	5MHz	5MHz	10MHz	10MHz	15MHz	15MHz		
Mod.	QPSK	16QAM	QPSK	16QAM	QPSK	16QAM	QPSK	16QAM	QPSK	16QAM		
Middle CH	1.31	1.34	3.10	3.09	5.05	4.96	10.09	9.95	-	-	-	-
High CH	-	-	-	-	-	-	-	-	14.42	14.72	-	-

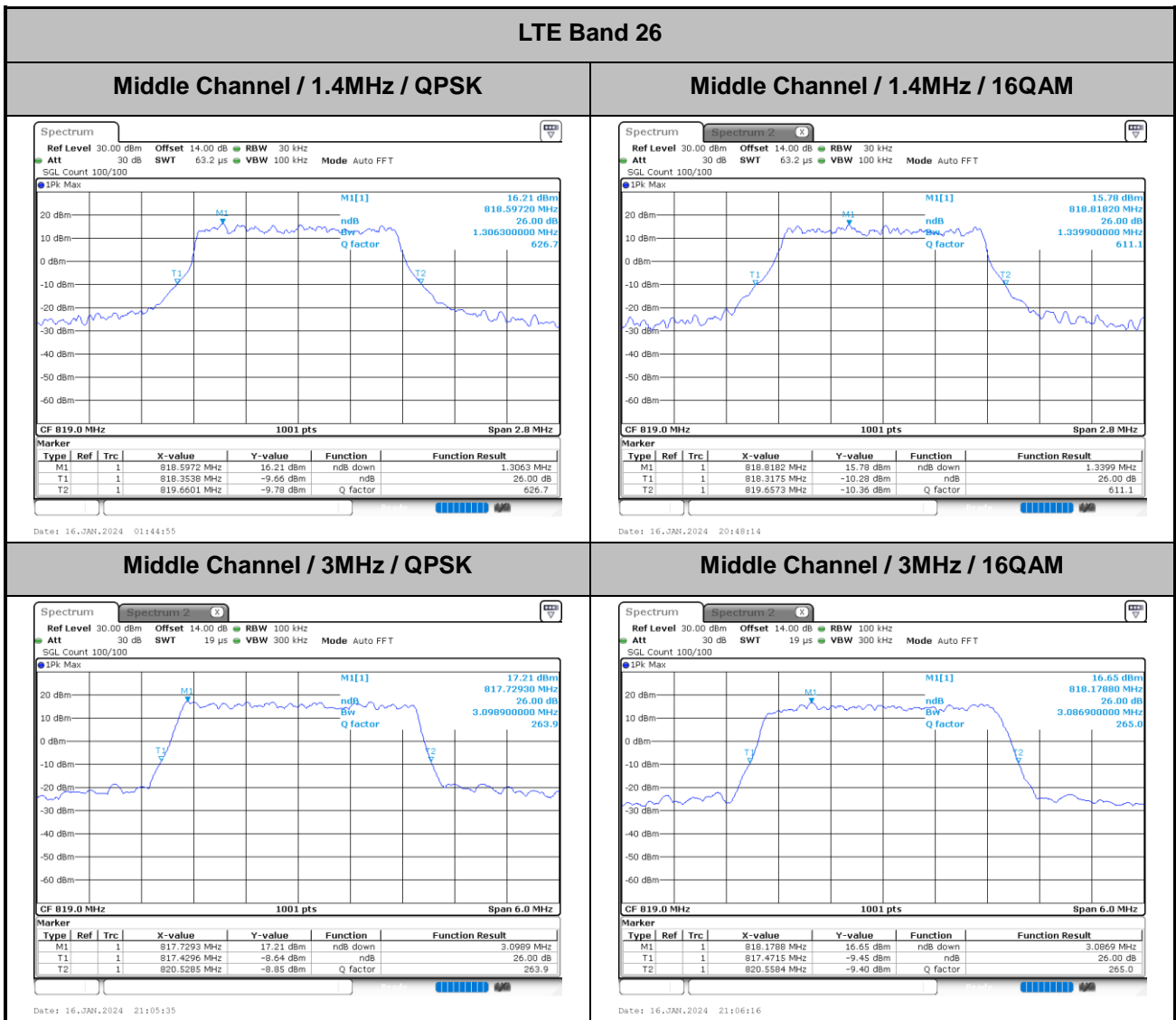



Middle Channel / 5MHz / QPSK

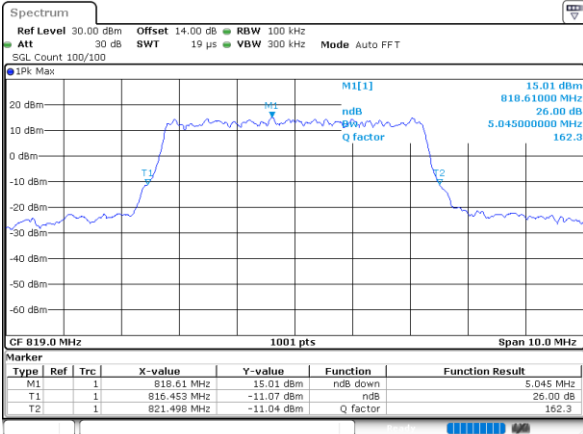

Date: 16_JAN.2024 21:23:56

Middle Channel / 5MHz / 16QAM

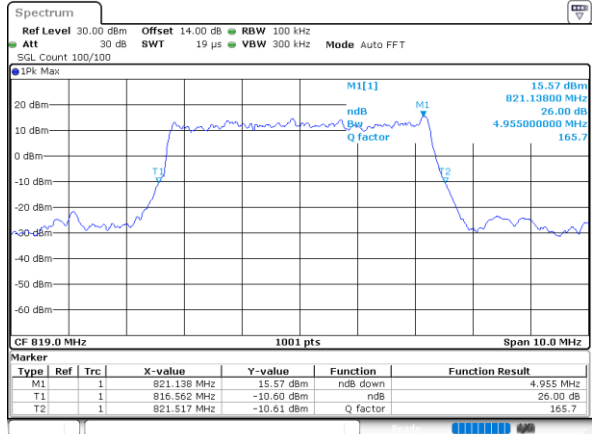

Date: 16_JAN.2024 21:24:17

LTE Band 26

Middle Channel / 10MHz / QPSK

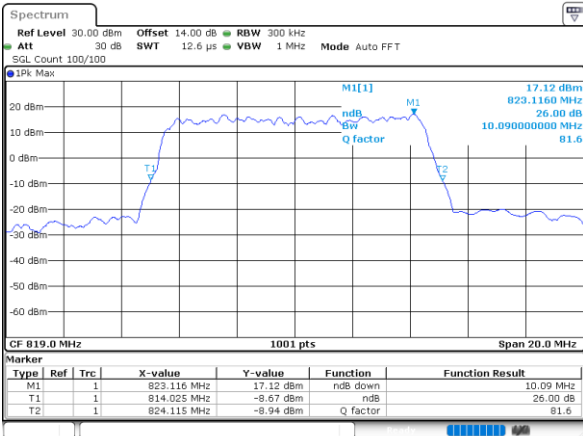

Date: 16_JAN.2024 21:42:17

Middle Channel / 10MHz / 16QAM

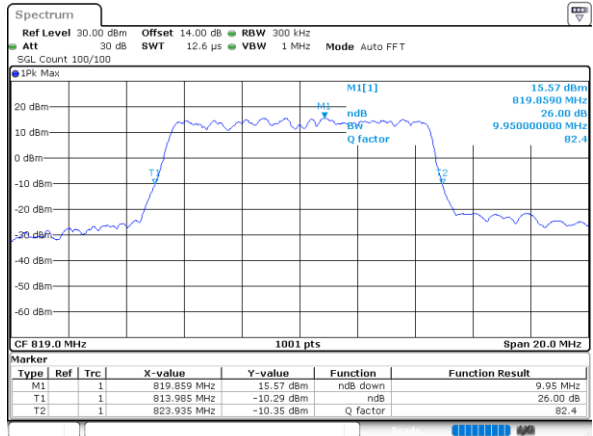

Date: 16_JAN.2024 21:42:58

High Channel / 15MHz / QPSK

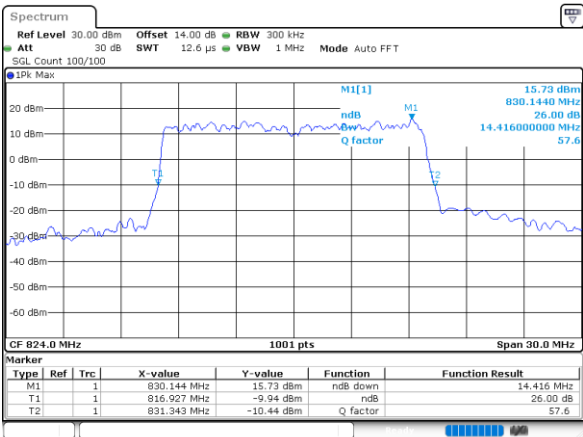

Date: 16_JAN.2024 22:12:10

High Channel / 15MHz / 16QAM

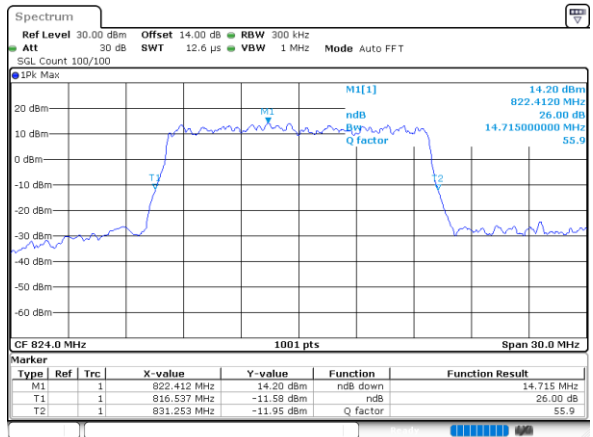

Date: 16_JAN.2024 22:17:05



Occupied Bandwidth

Mode	LTE Band 26 : 99%OBW(MHz)											
	1.4MHz		3MHz		5MHz		10MHz		15MHz		20MHz	
Mod.	QPSK	16QAM	QPSK	16QAM	QPSK	16QAM	QPSK	16QAM	QPSK	16QAM	QPSK	16QAM
Middle CH	1.09	1.09	2.72	2.73	4.51	4.52	9.01	8.99	-	-	-	-
High CH	-	-	-	-	-	-	-	-	13.46	13.46	-	-



LTE Band 26

Middle Channel / 1.4MHz / QPSK

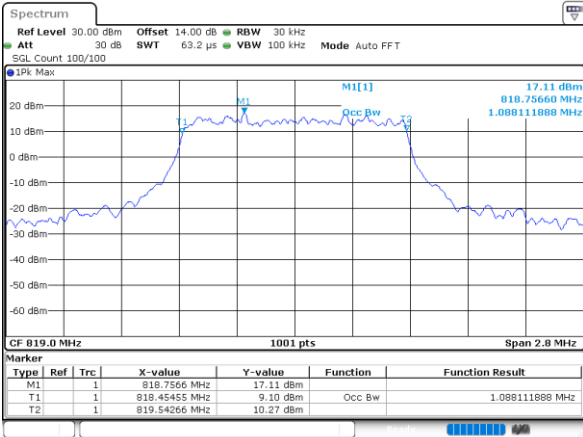

Date: 16_JAN.2024 01:44:41

Middle Channel / 1.4MHz / 16QAM

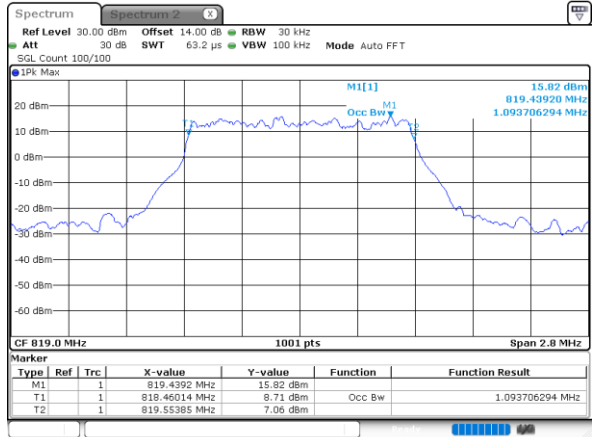

Date: 16_JAN.2024 20:48:00

Middle Channel / 3MHz / QPSK

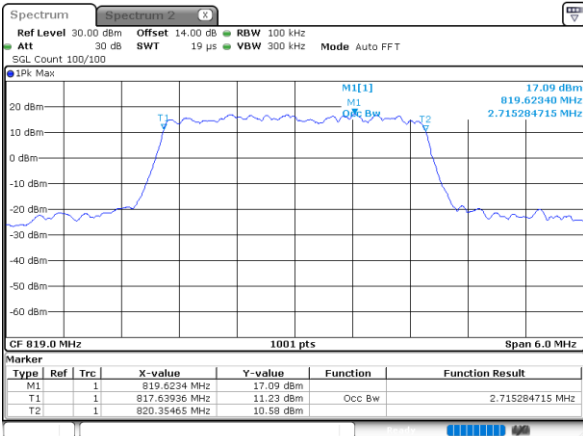

Date: 16_JAN.2024 21:05:23

Middle Channel / 3MHz / 16QAM

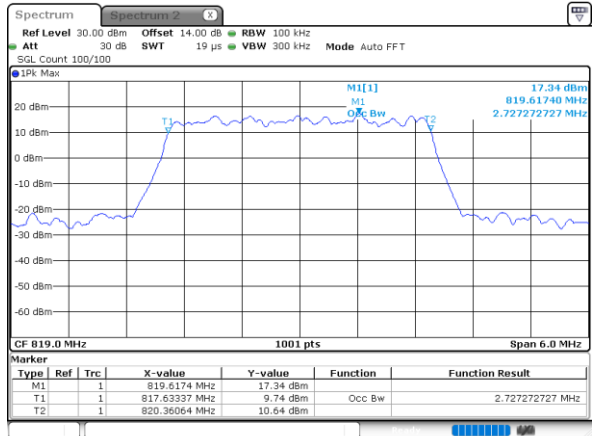

Date: 16_JAN.2024 21:06:02

Middle Channel / 5MHz / QPSK

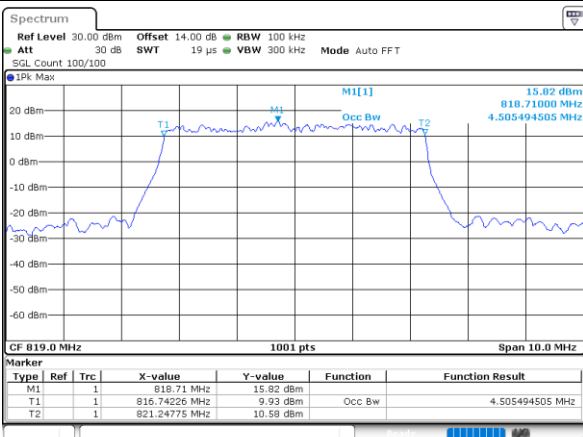

Date: 16_JAN.2024 21:23:22

Middle Channel / 5MHz / 16QAM

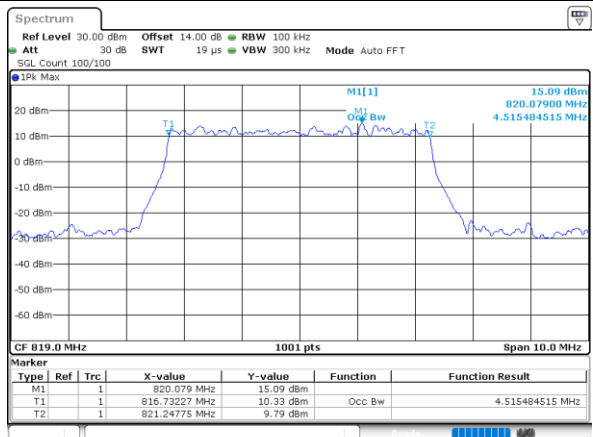

Date: 16_JAN.2024 21:24:03



LTE Band 26

Middle Channel / 10MHz / QPSK

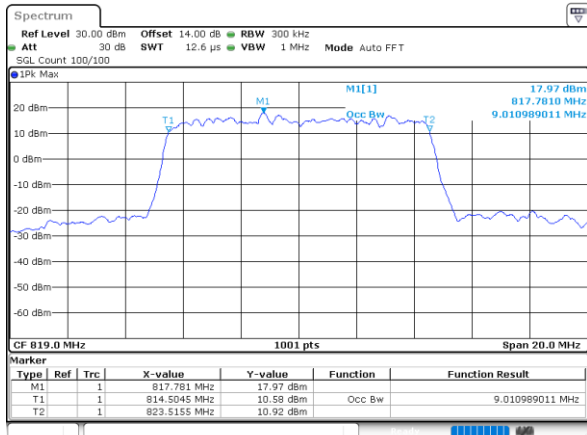

Date: 16, JAN, 2024 21:42:03

Middle Channel / 10MHz / 16QAM

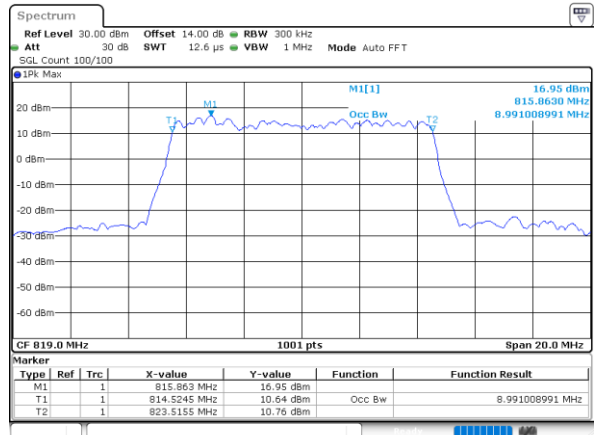

Date: 16, JAN, 2024 21:42:44

High Channel / 15MHz / QPSK

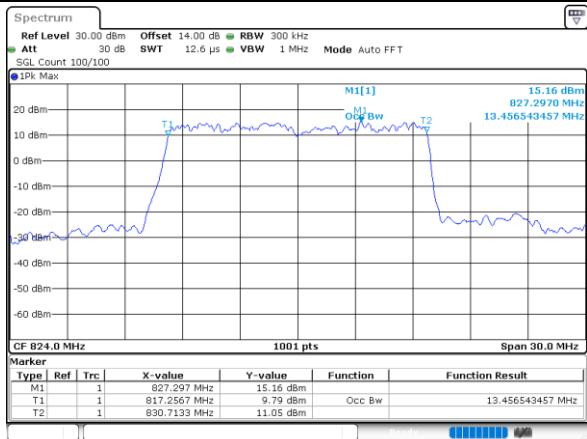

Date: 16, JAN, 2024 22:26:24

High Channel / 15MHz / 16QAM

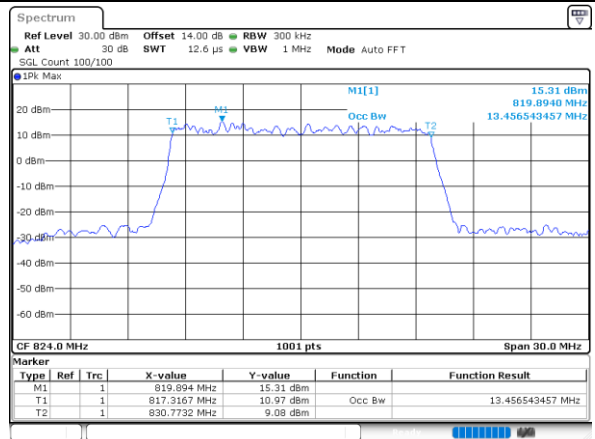

Date: 16, JAN, 2024 22:26:51



Emission masks – In-band emissions

LTE Band 26 / 1.4MHz / QPSK

Lowest Band Edge / 1RB

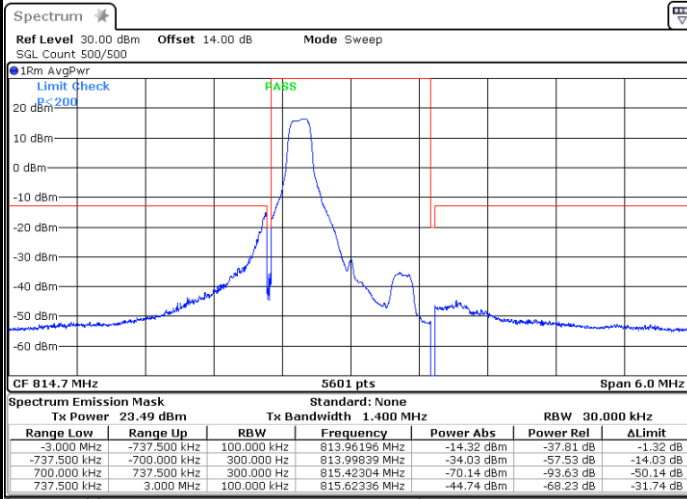

Date: 16. JAN. 2024 22:07:22

Highest Band Edge / 1RB

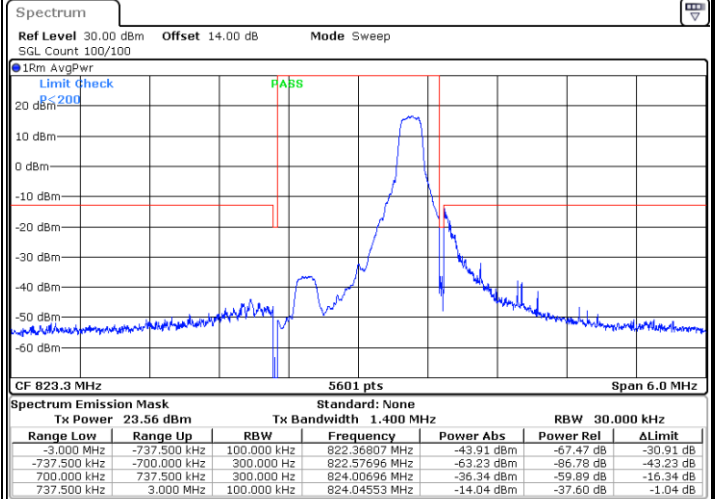

Date: 16. JAN. 2024 22:08:50

Lowest Band Edge / Full RB

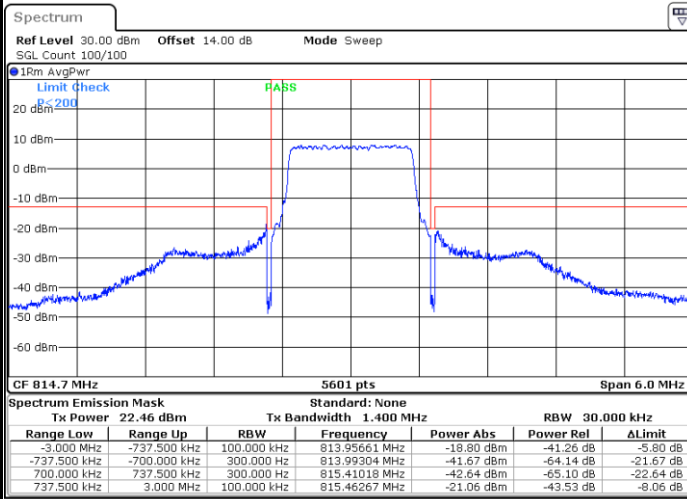

Date: 16. JAN. 2024 01:41:49

Highest Band Edge / Full RB

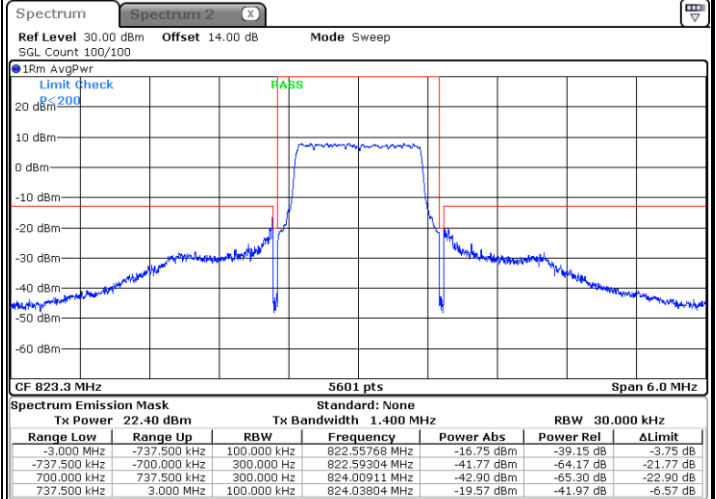

Date: 16. JAN. 2024 20:54:20



LTE Band 26 / 1.4MHz / 16QAM

Lowest Band Edge / 1 RB

Highest Band Edge / 1 RB

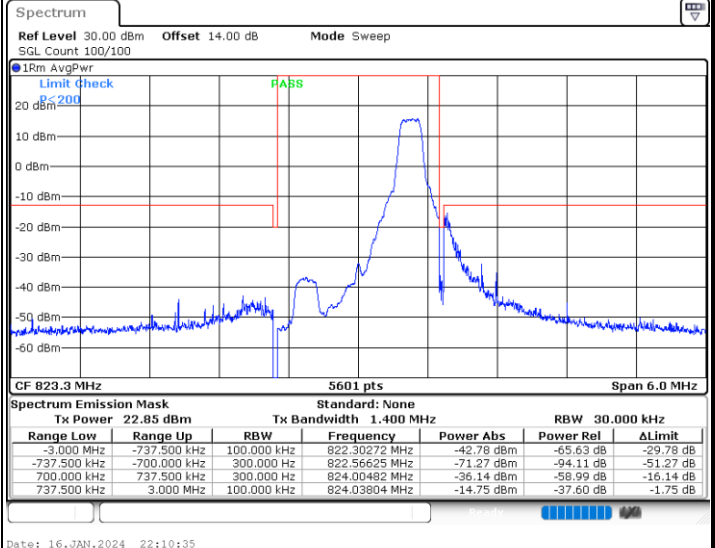
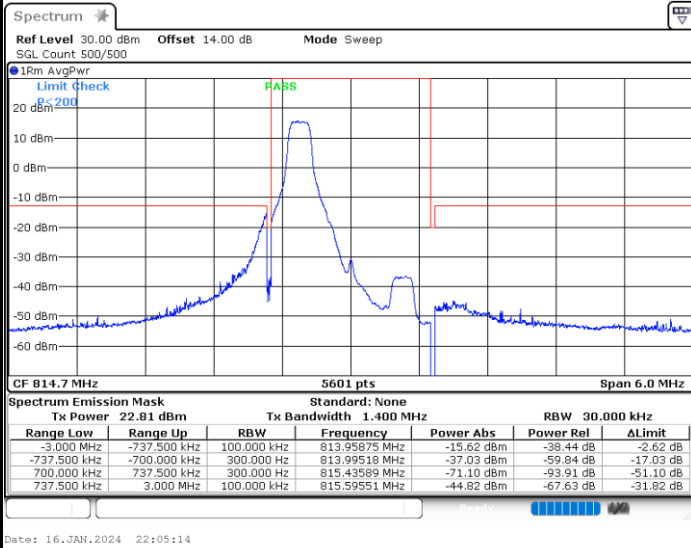

Lowest Band Edge / Full RB

Highest Band Edge / Full RB

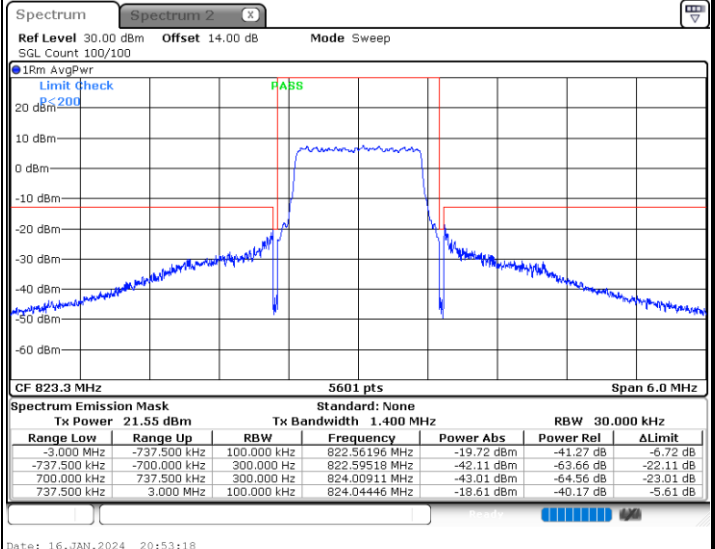
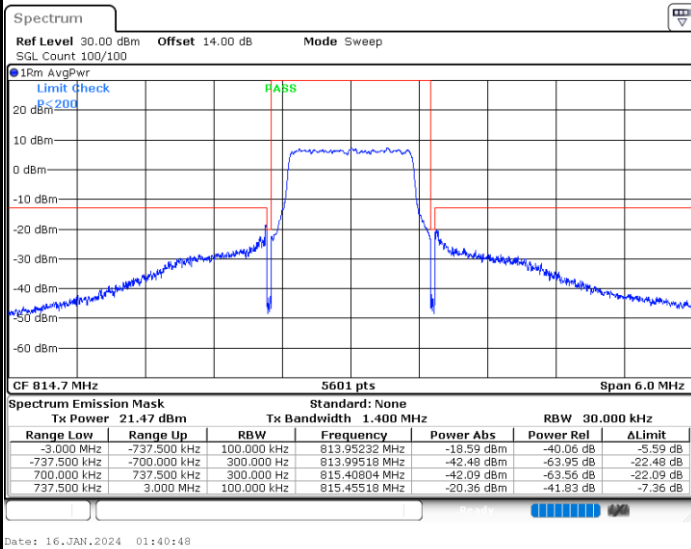



LTE Band 26 / 1.4MHz / 64QAM

Lowest Band Edge / 1 RB

Highest Band Edge / 1 RB

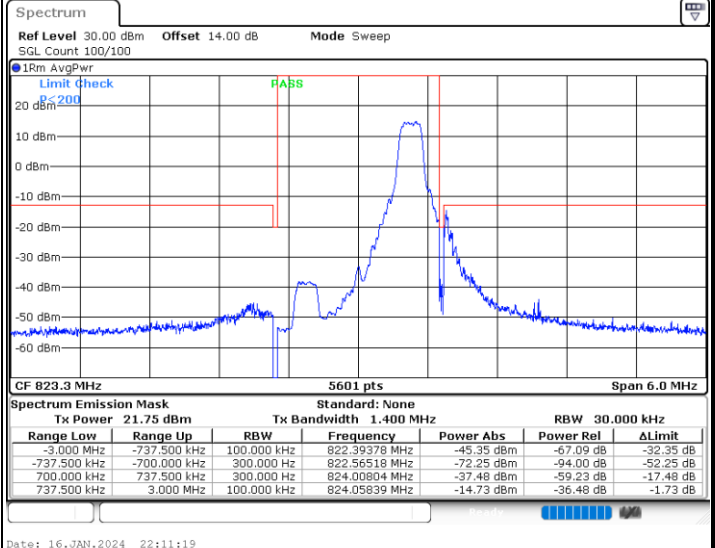
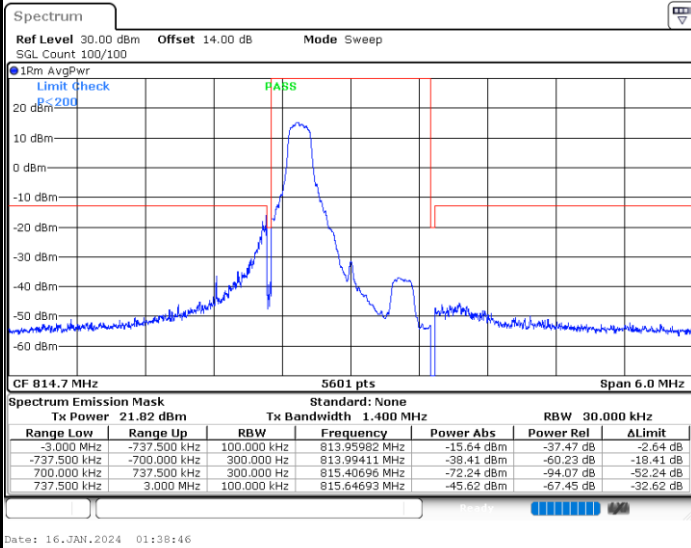

Date: 16.JAN.2024 01:38:46

Date: 16.JAN.2024 22:11:19

Lowest Band Edge / Full RB

Highest Band Edge / Full RB

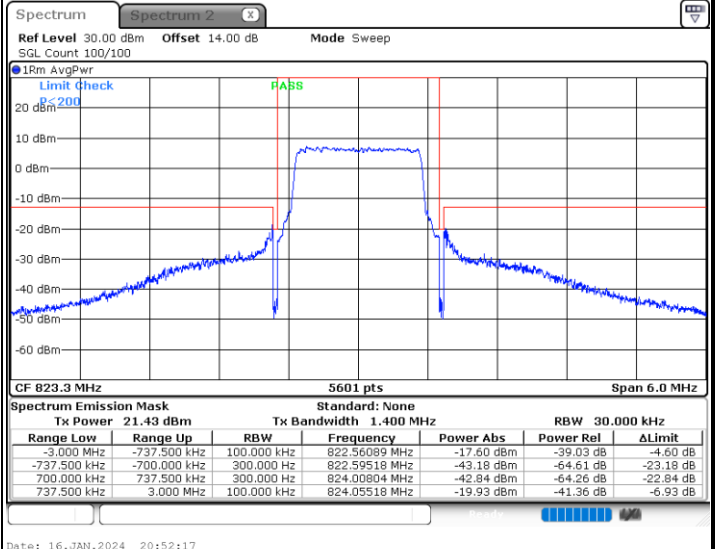
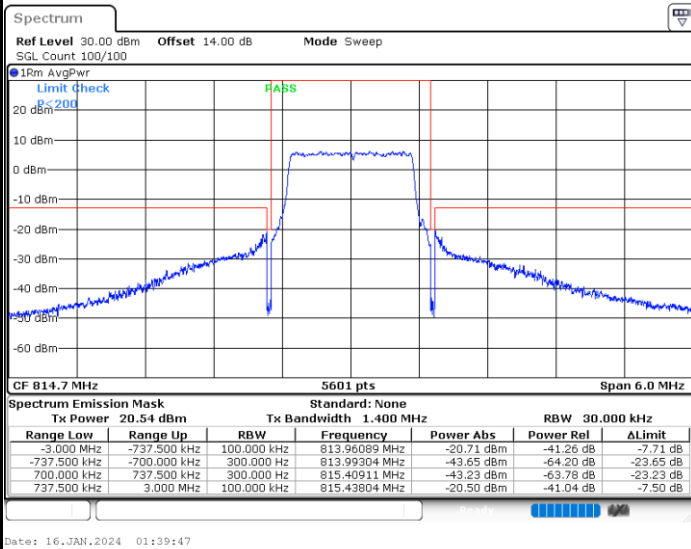

Date: 16.JAN.2024 01:39:47

Date: 16.JAN.2024 20:52:17



LTE Band 26 / 3MHz / QPSK

Lowest Band Edge / 1RB

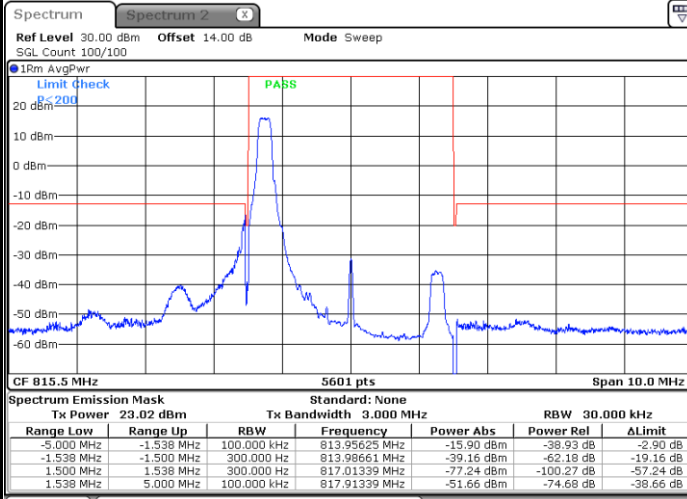

Date: 16. JAN. 2024 20:57:22

Highest Band Edge / 1RB

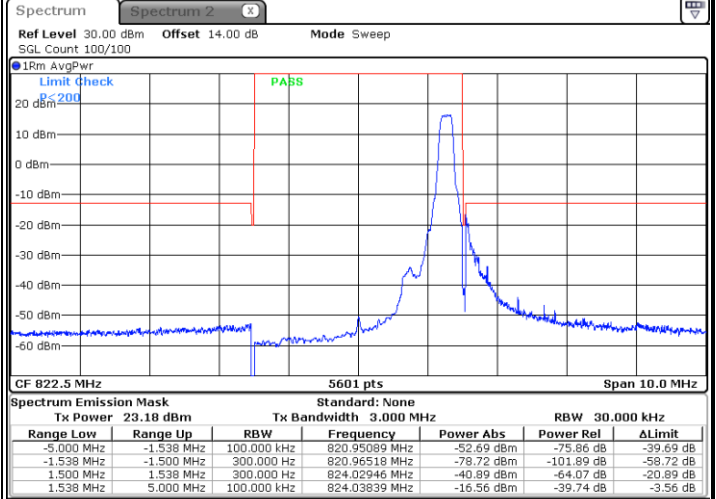

Date: 16. JAN. 2024 21:07:16

Lowest Band Edge / Full RB

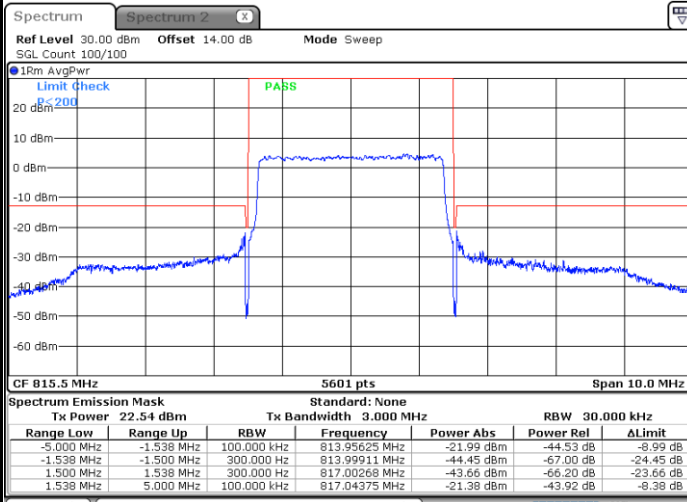

Date: 16. JAN. 2024 21:02:29

Highest Band Edge / Full RB

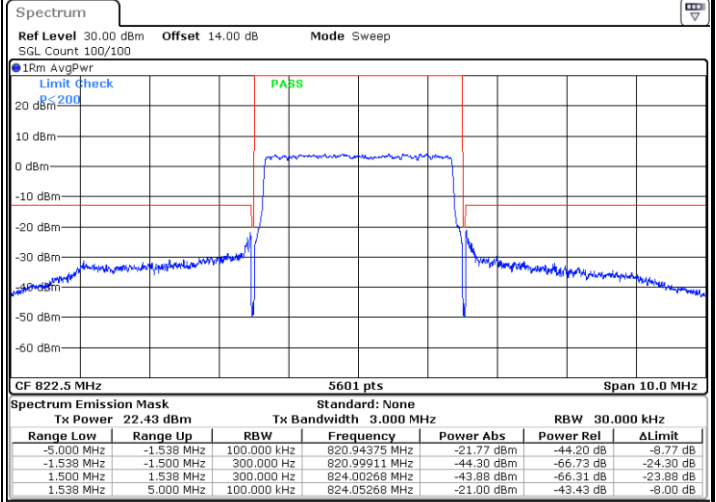

Date: 16. JAN. 2024 21:12:23



LTE Band 26 / 3MHz / 16QAM

Lowest Band Edge / 1 RB

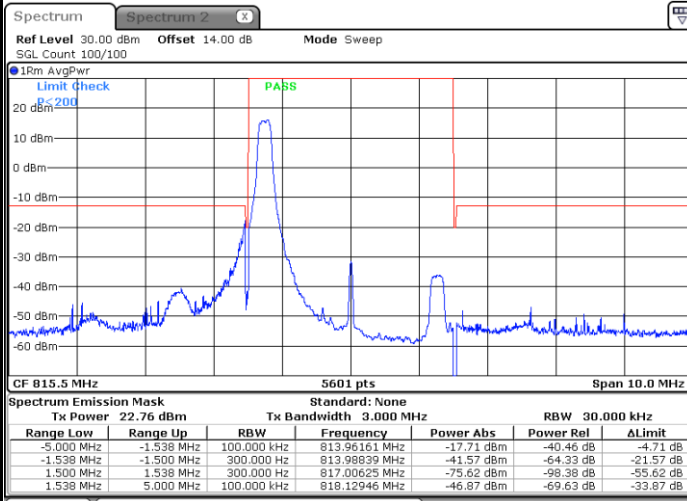

Date: 16. JAN. 2024 20:58:23

Highest Band Edge / 1 RB

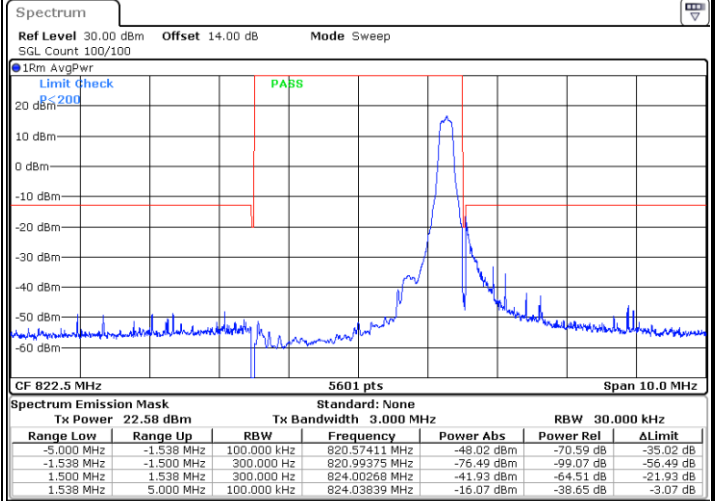

Date: 16. JAN. 2024 21:08:17

Lowest Band Edge / Full RB

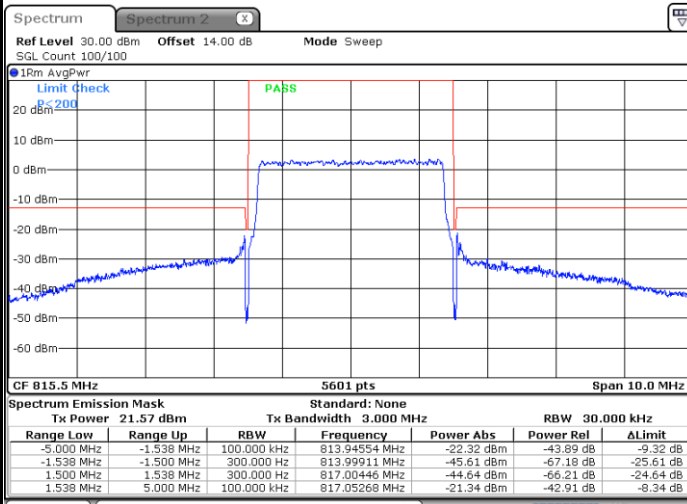

Date: 16. JAN. 2024 21:01:27

Highest Band Edge / Full RB

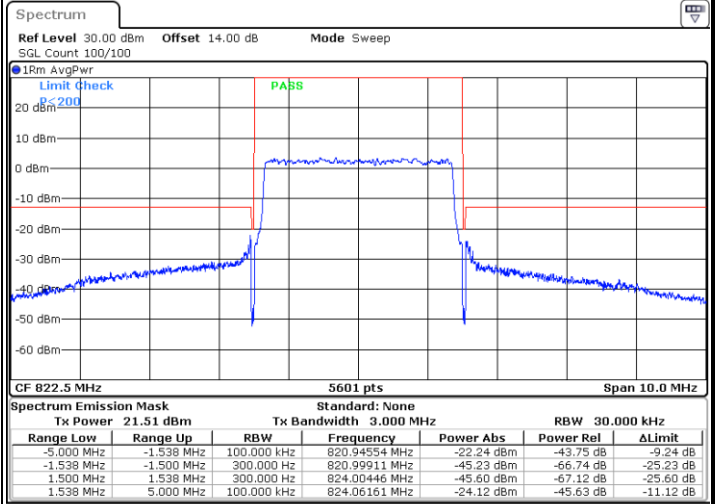

Date: 16. JAN. 2024 21:11:21



LTE Band 26 / 3MHz / 64QAM

Lowest Band Edge / 1 RB

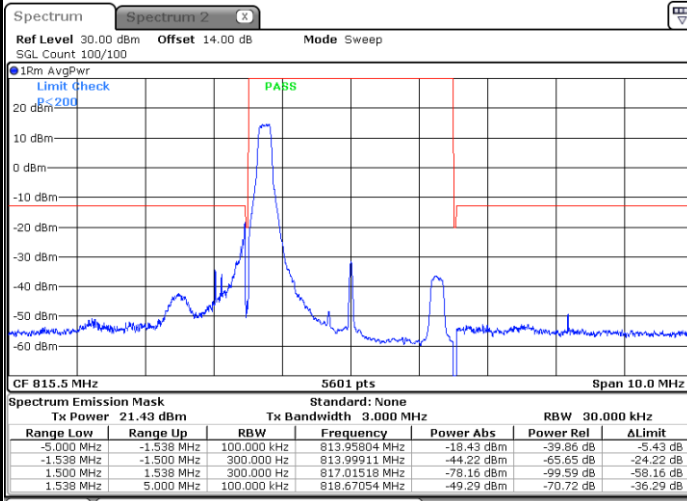

Date: 16. JAN. 2024 20:59:25

Highest Band Edge / 1 RB

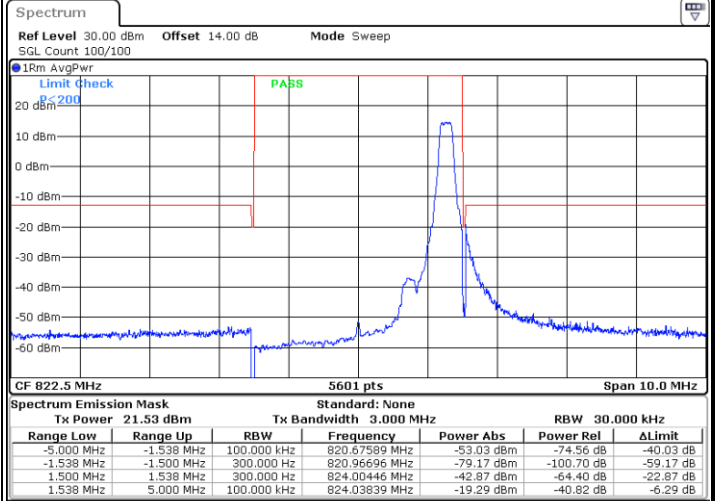

Date: 16. JAN. 2024 21:09:19

Lowest Band Edge / Full RB

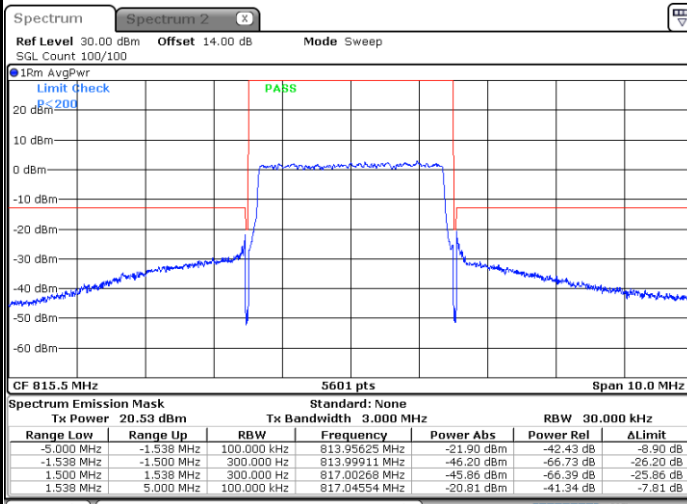

Date: 16. JAN. 2024 21:00:26

Highest Band Edge / Full RB

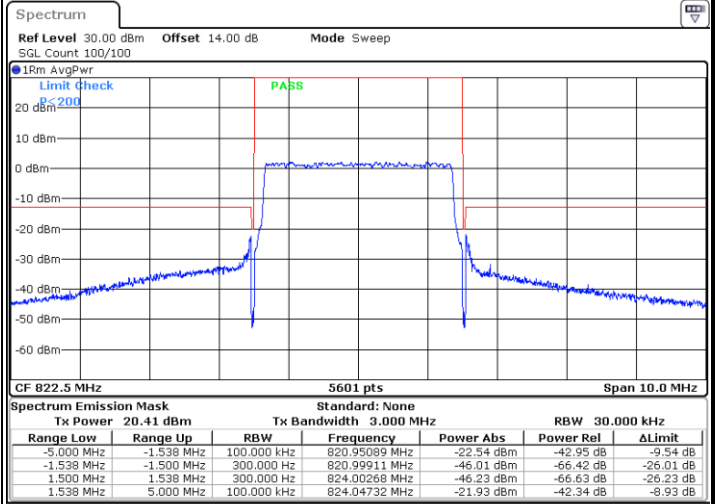

Date: 16. JAN. 2024 21:10:20



LTE Band 26 / 5MHz / QPSK

Lowest Band Edge / 1RB

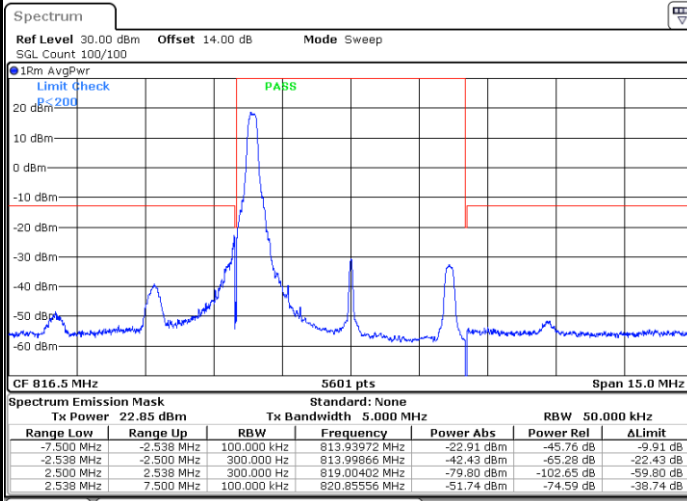

Date: 16.JAN.2024 21:15:24

Highest Band Edge / 1RB

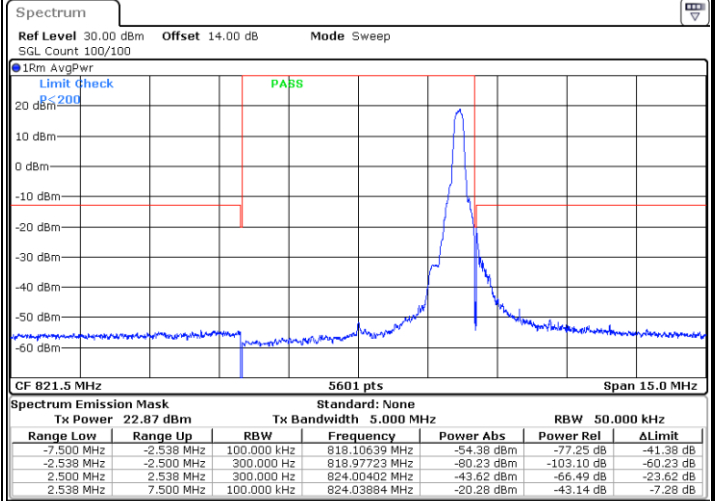

Date: 16.JAN.2024 21:25:18

Lowest Band Edge / Full RB

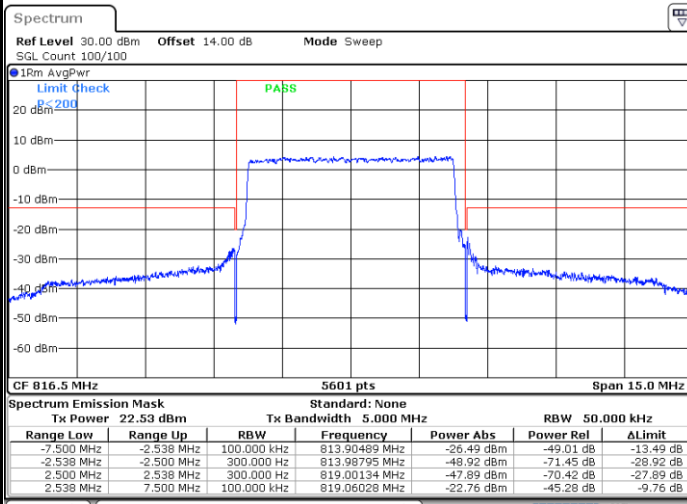

Date: 16.JAN.2024 21:20:30

Highest Band Edge / Full RB

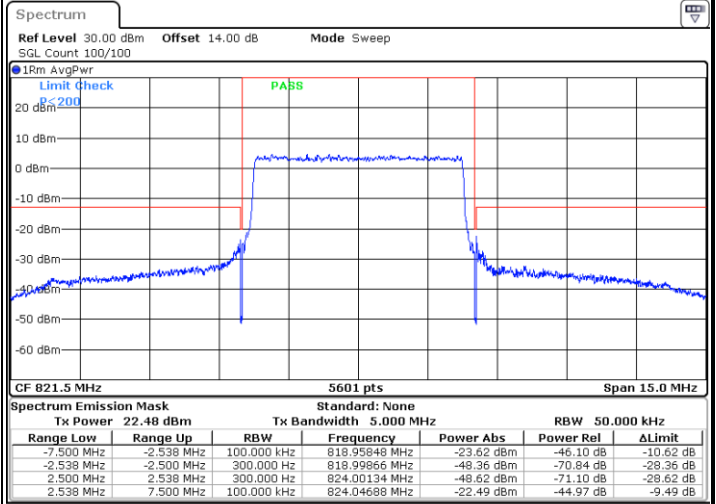

Date: 16.JAN.2024 21:30:24



LTE Band 26 / 5MHz / 16QAM

Lowest Band Edge / 1 RB

Highest Band Edge / 1 RB

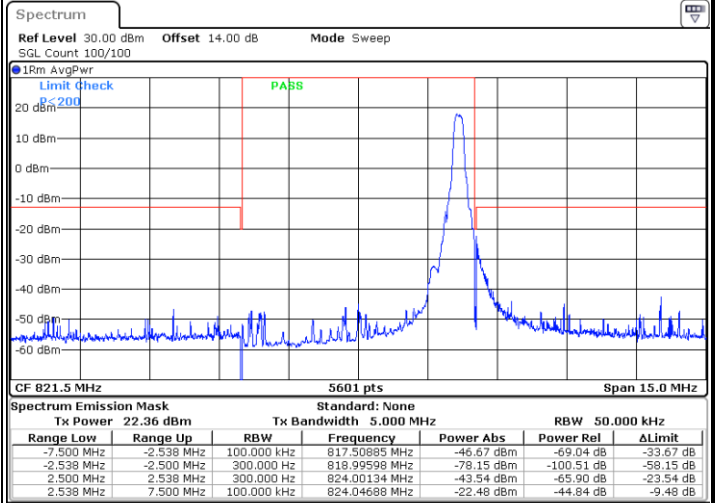
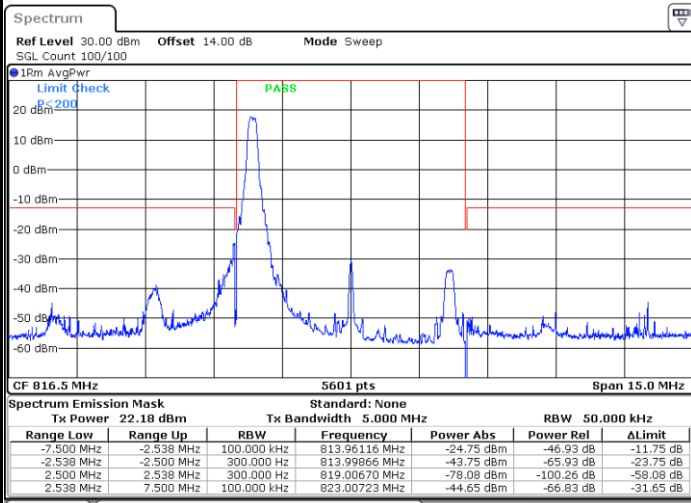

Date: 16.JAN.2024 21:16:25

Date: 16.JAN.2024 21:26:19

Lowest Band Edge / Full RB

Highest Band Edge / Full RB

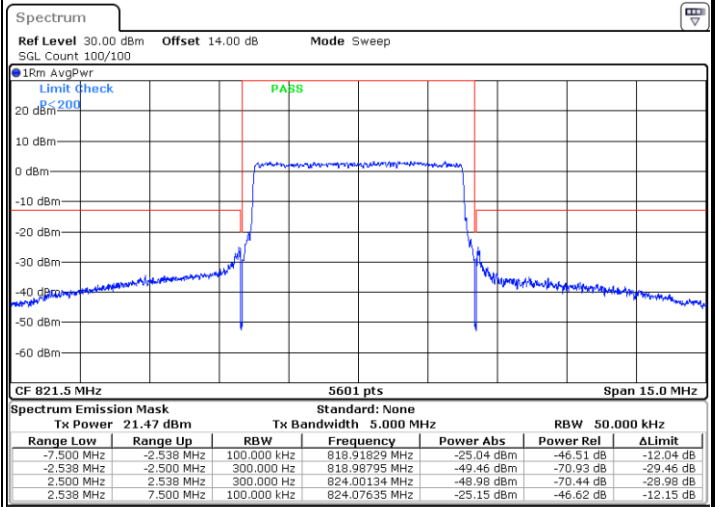
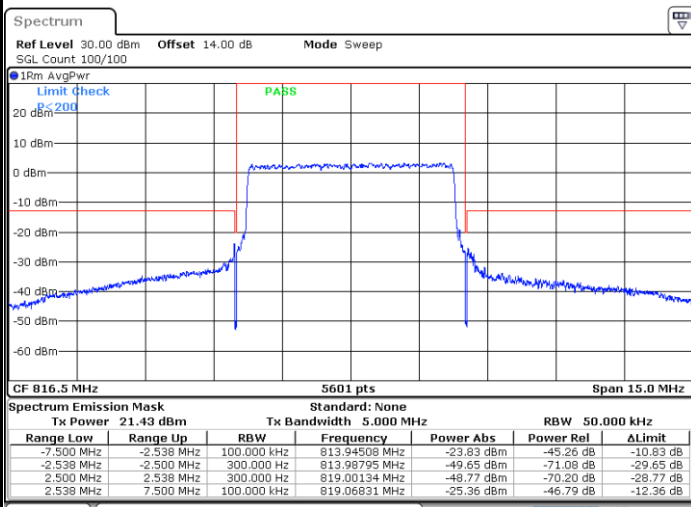

Date: 16.JAN.2024 21:19:29

Date: 16.JAN.2024 21:29:23



LTE Band 26 / 5MHz / 64QAM

Lowest Band Edge / 1 RB

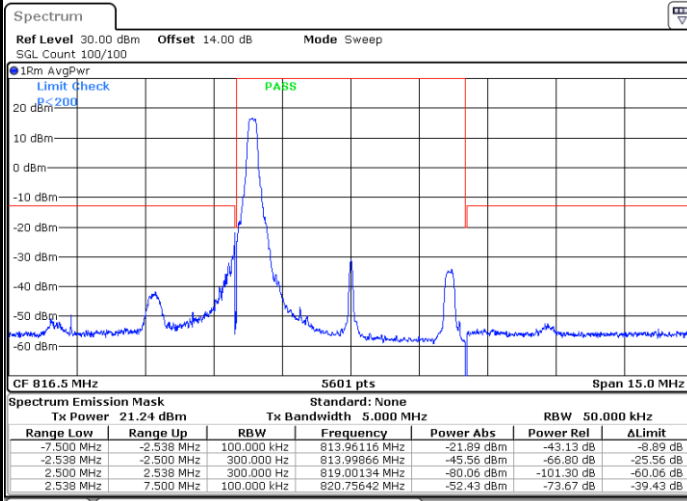

Date: 16.JAN.2024 21:17:27

Highest Band Edge / 1 RB

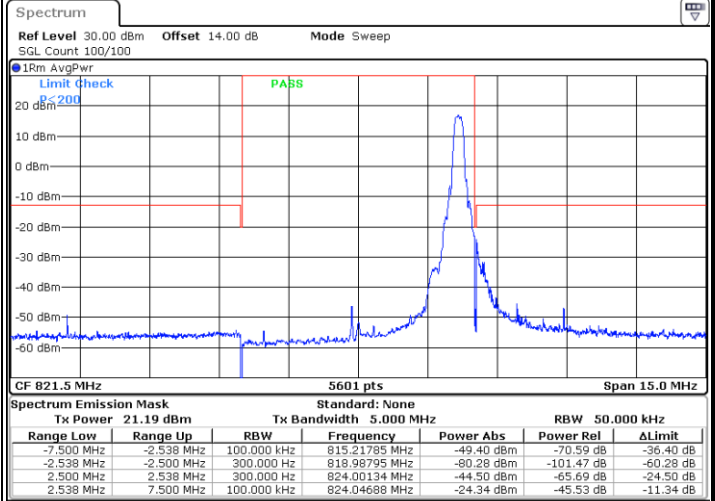

Date: 16.JAN.2024 21:27:20

Lowest Band Edge / Full RB

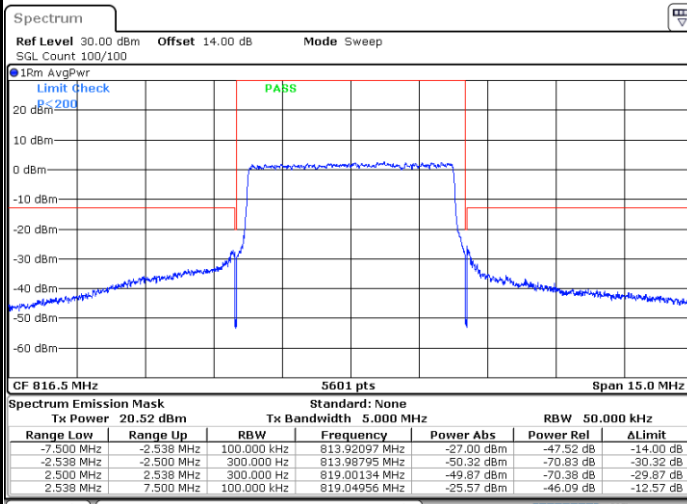

Date: 16.JAN.2024 21:18:28

Highest Band Edge / Full RB

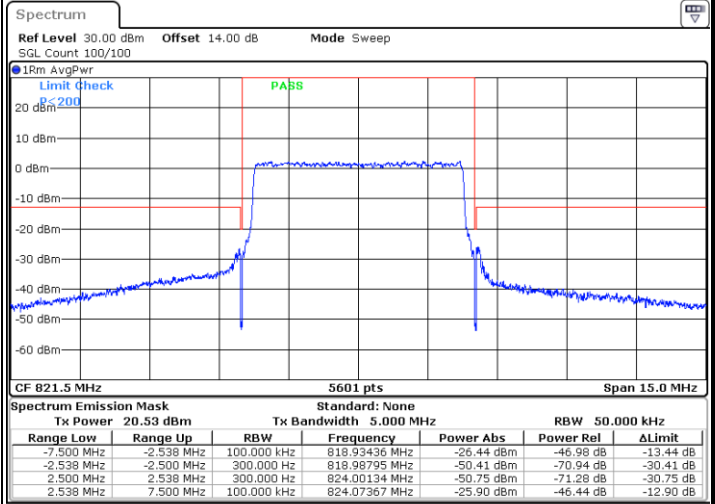

Date: 16.JAN.2024 21:28:22



LTE Band 26 / 10MHz / QPSK

Lowest Band Edge / 1RB

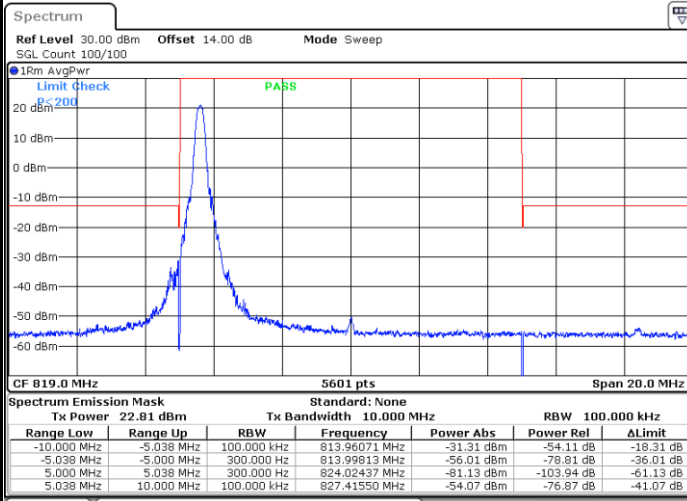

Date: 16.JAN.2024 21:33:26

Lowest Band Edge / 1RB

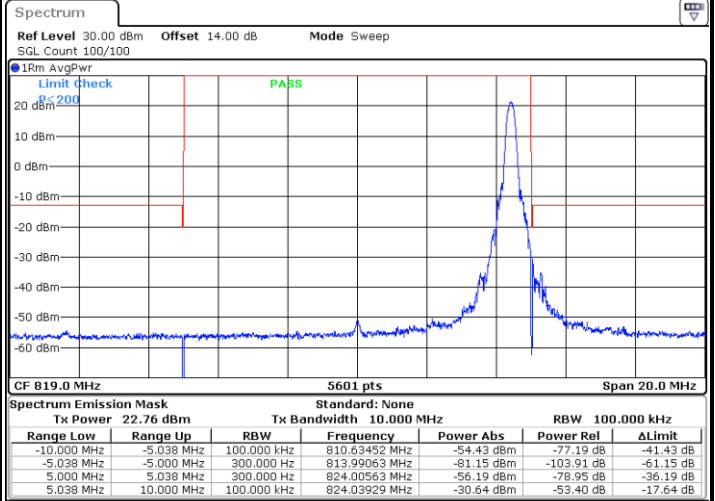

Date: 16.JAN.2024 21:38:32

Lowest Band Edge / Full RB

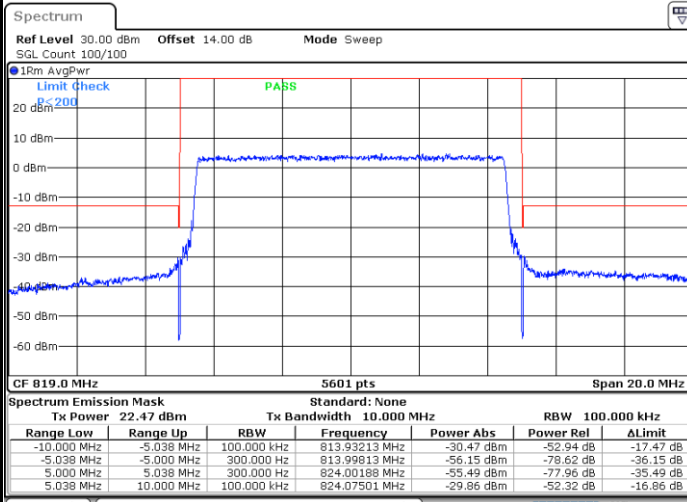

Date: 16.JAN.2024 21:39:33

NA



LTE Band 26 / 10MHz / 16QAM

Lowest Band Edge / 1 RB

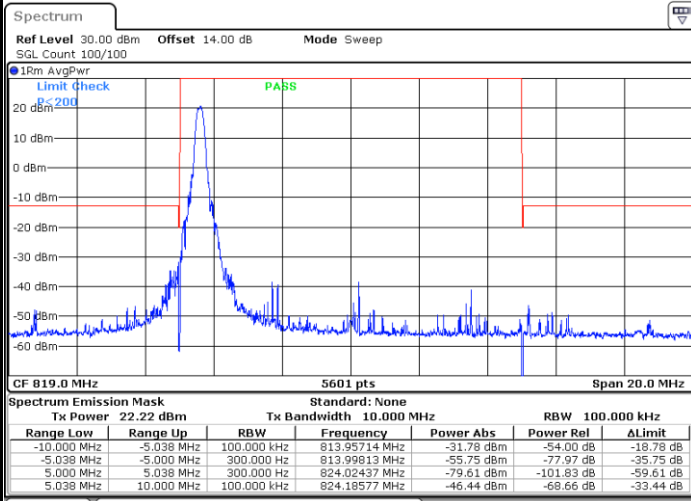

Date: 16.JAN.2024 21:34:27

Lowest Band Edge / 1 RB

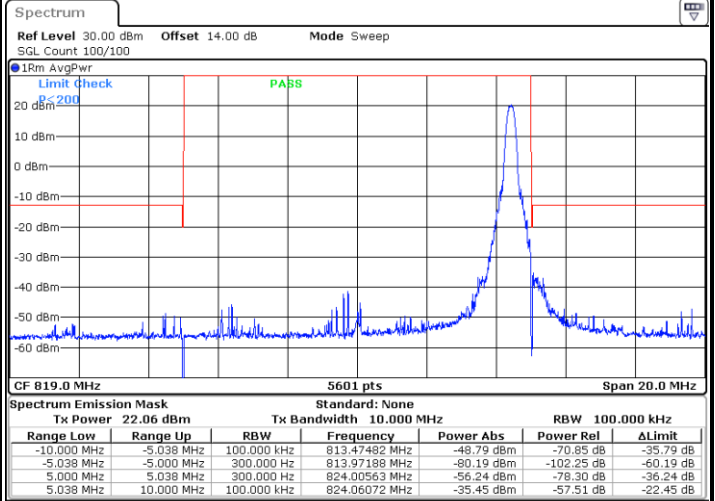

Date: 16.JAN.2024 21:37:31

Lowest Band Edge / Full RB

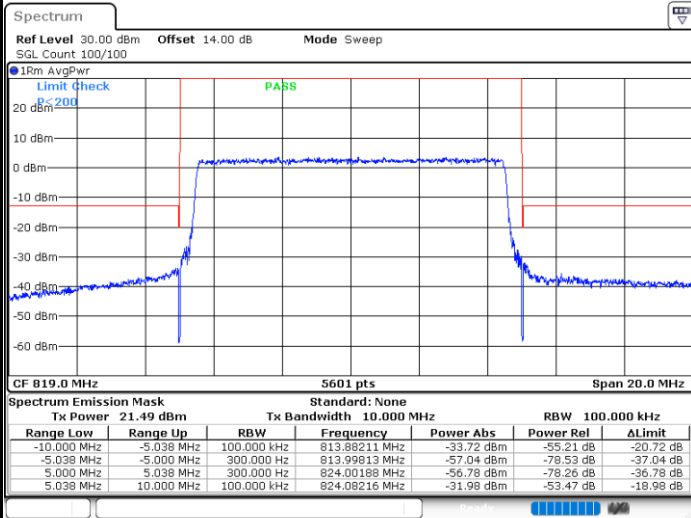

Date: 16.JAN.2024 21:40:34

NA



LTE Band 26 / 10MHz / 64QAM

Lowest Band Edge / 1 RB

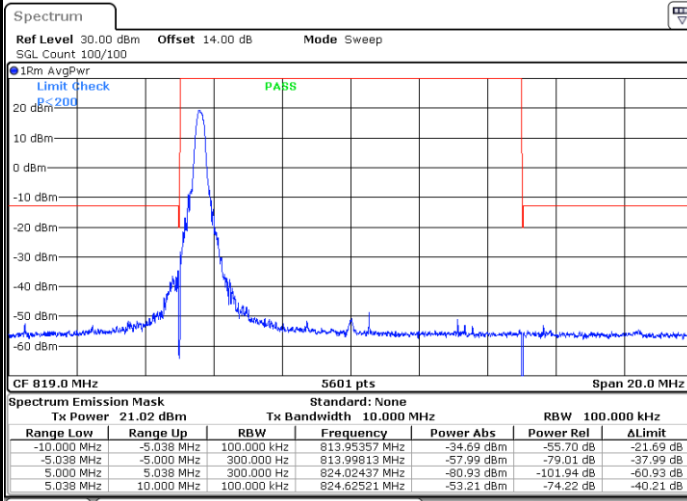

Date: 16. JAN. 2024 21:35:28

Lowest Band Edge / 1 RB

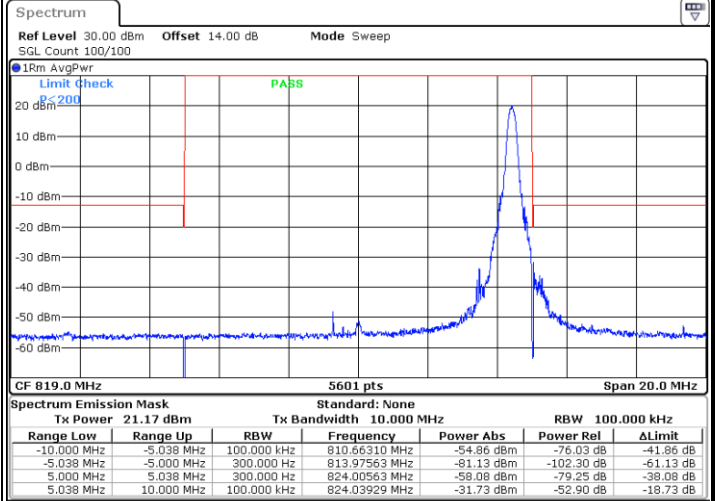

Date: 16. JAN. 2024 21:36:29

Lowest Band Edge / Full RB

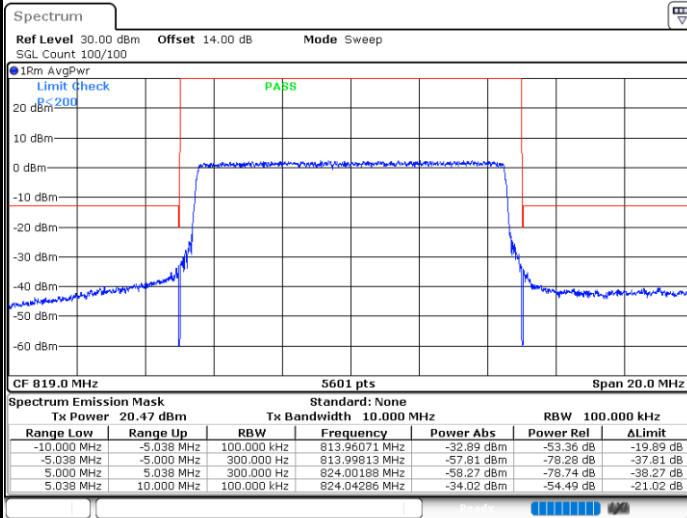

Date: 16. JAN. 2024 21:41:35

NA



LTE Band 26 / 15MHz

Highest Band Edge / 1RB QPSK

Highest Band Edge / Full RB QPSK

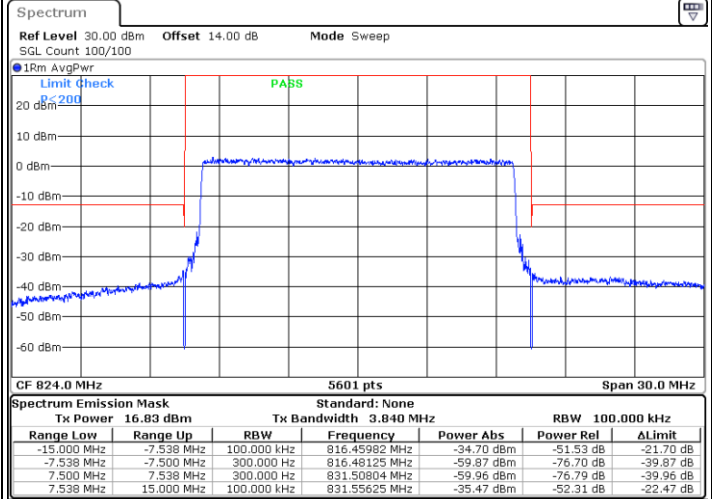
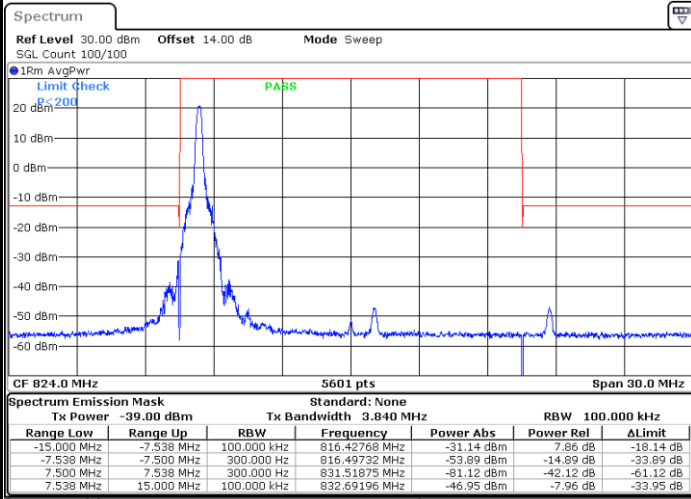

Date: 16.JAN.2024 22:31:07

Date: 16.JAN.2024 22:28:05

Highest Band Edge / 1 RB 16QAM

Highest Band Edge / Full RB 16QAM

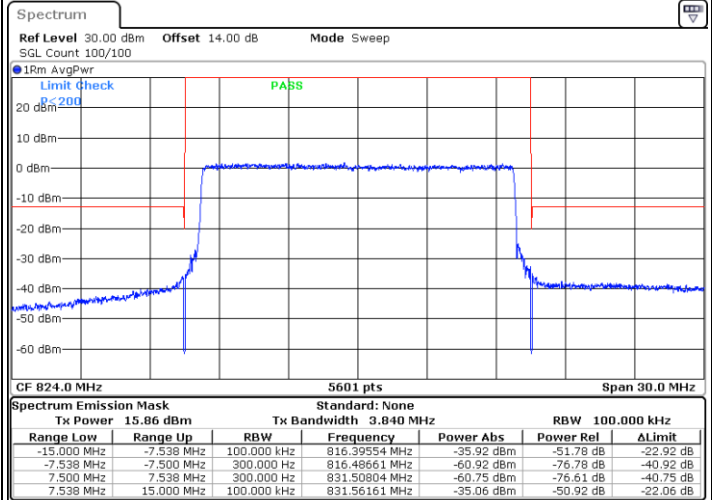
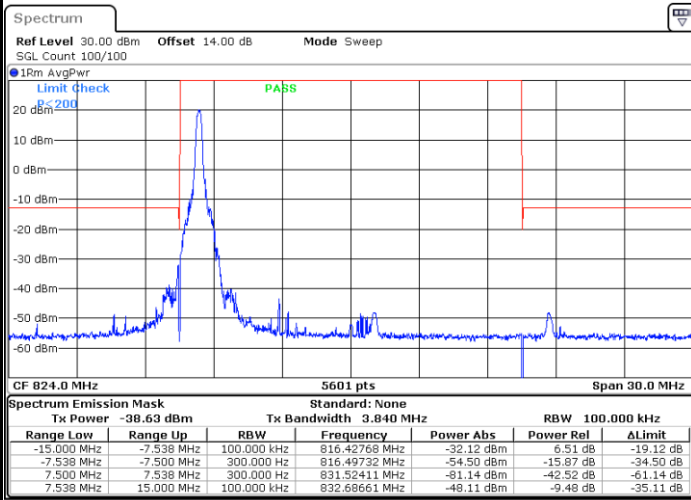

Date: 16.JAN.2024 22:32:08

Date: 16.JAN.2024 22:29:06



LTE Band 26 / 15MHz

Highest Band Edge / 1 RB 64QAM

Highest Band Edge / Full RB 64QAM

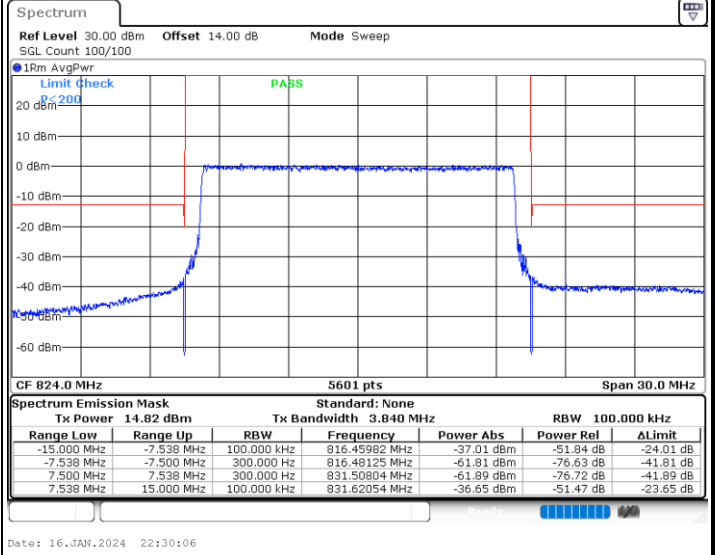
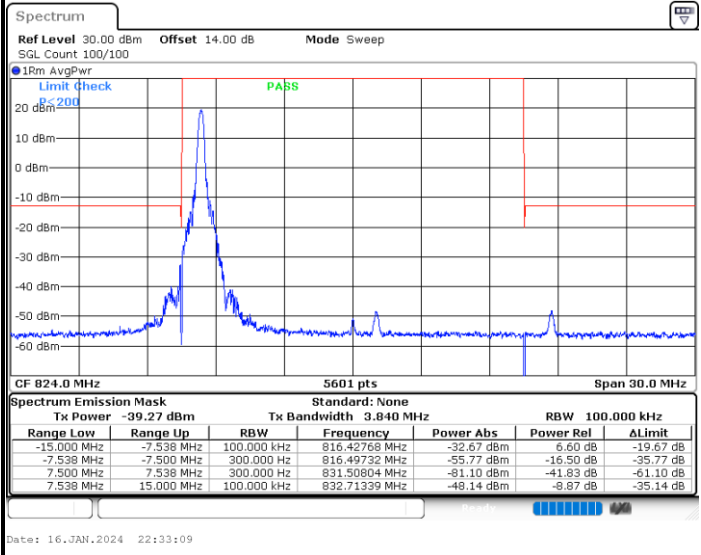



Emission masks – Out of band emissions

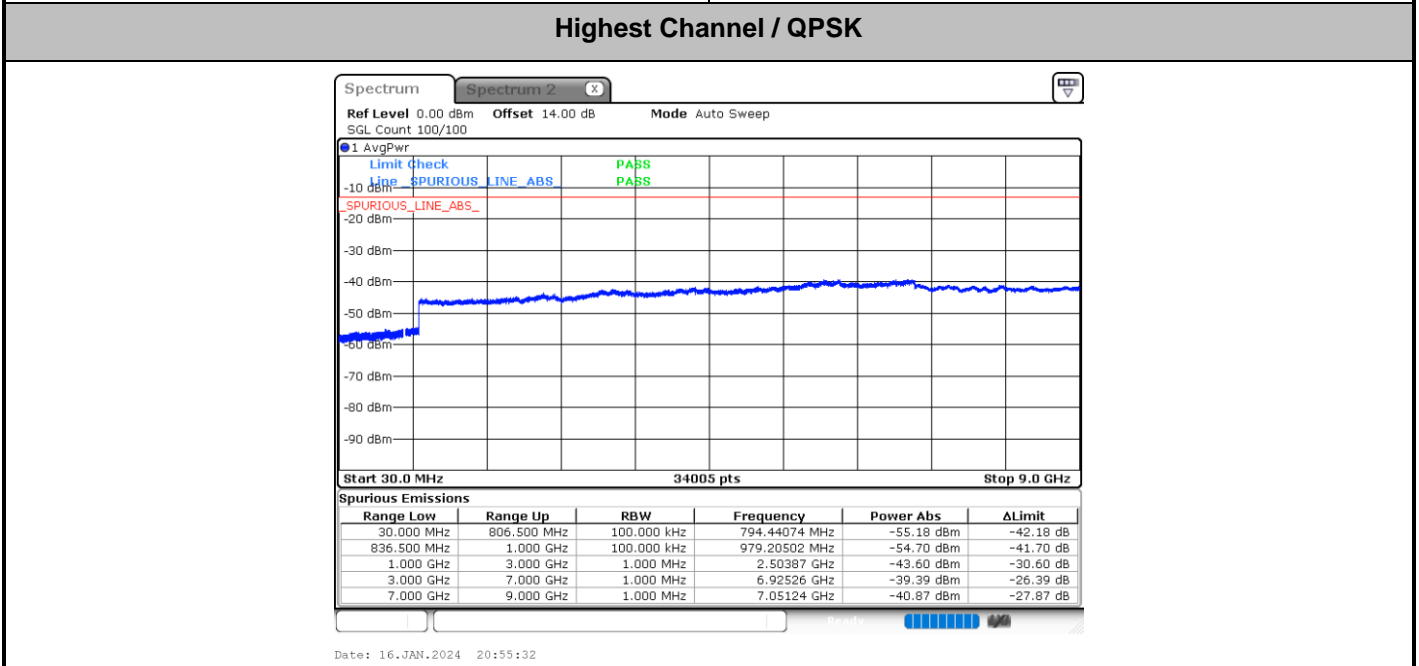
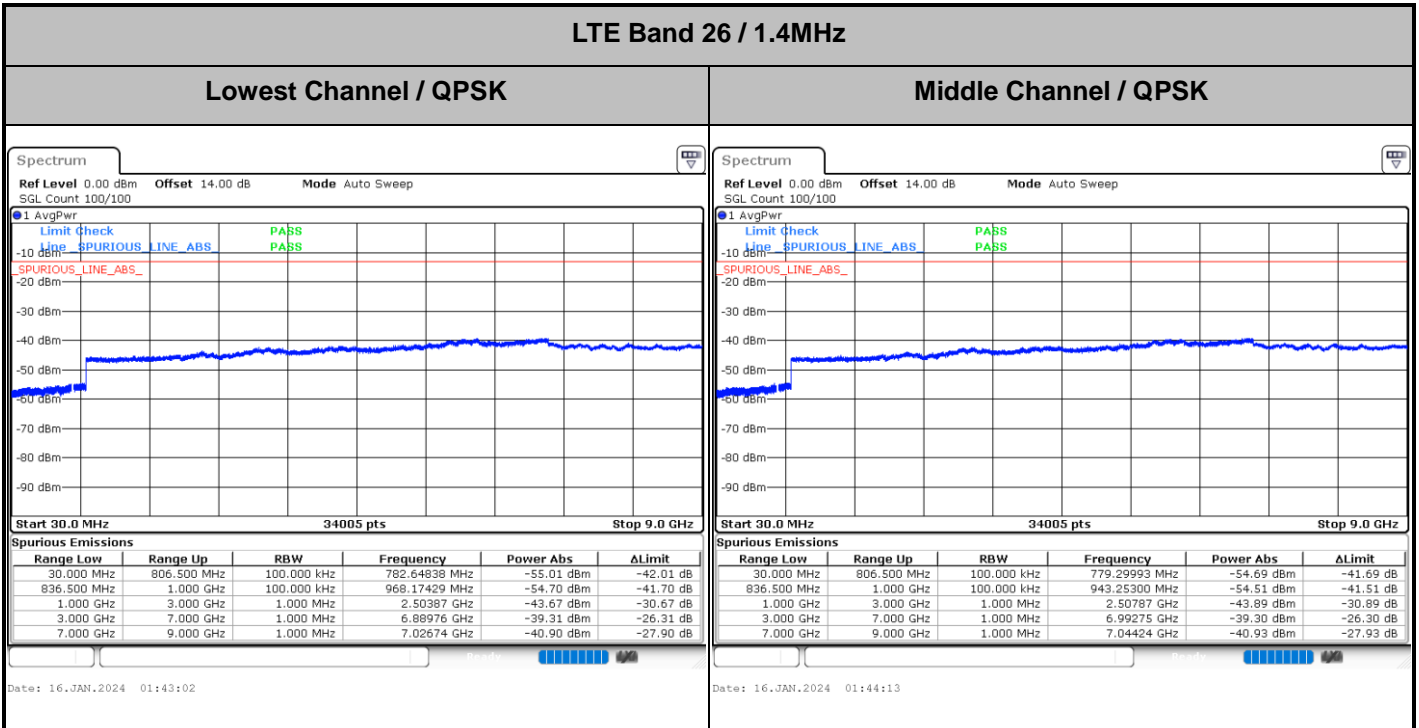



LTE Band 26 / 3MHz

Lowest Channel / QPSK

Middle Channel / QPSK

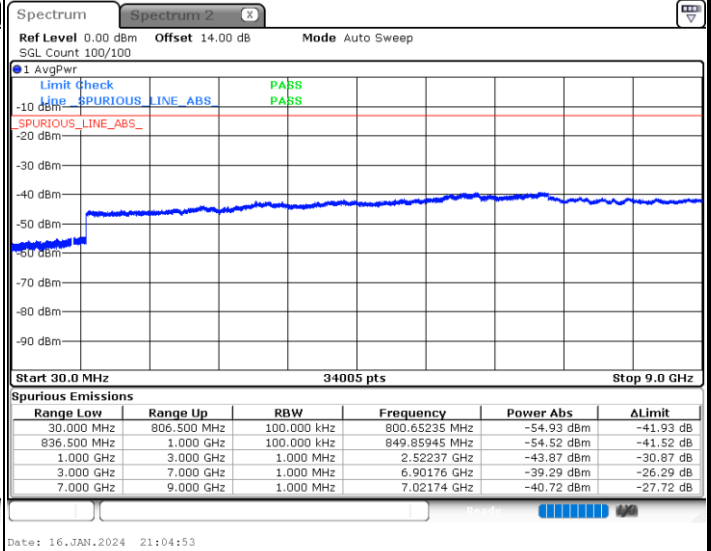
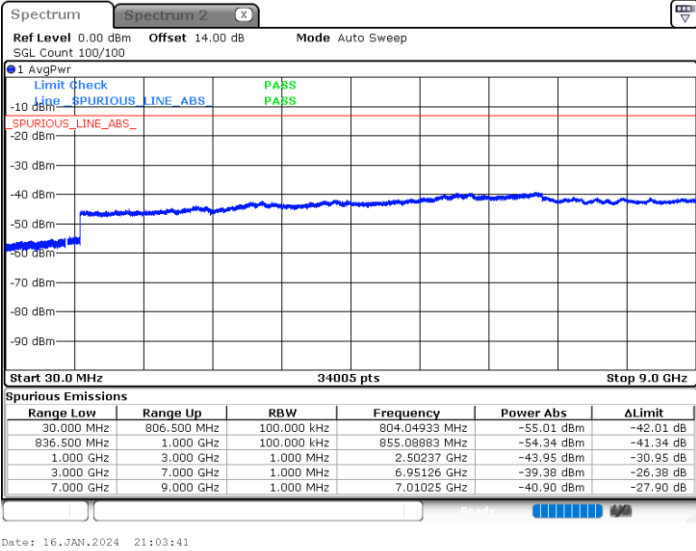

Highest Channel / QPSK

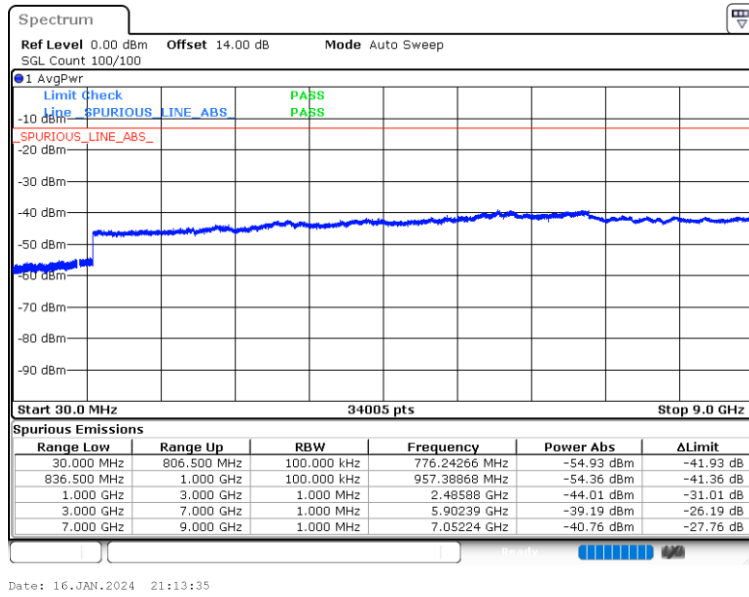



LTE Band 26 / 5MHz

Lowest Channel / QPSK

Middle Channel / QPSK

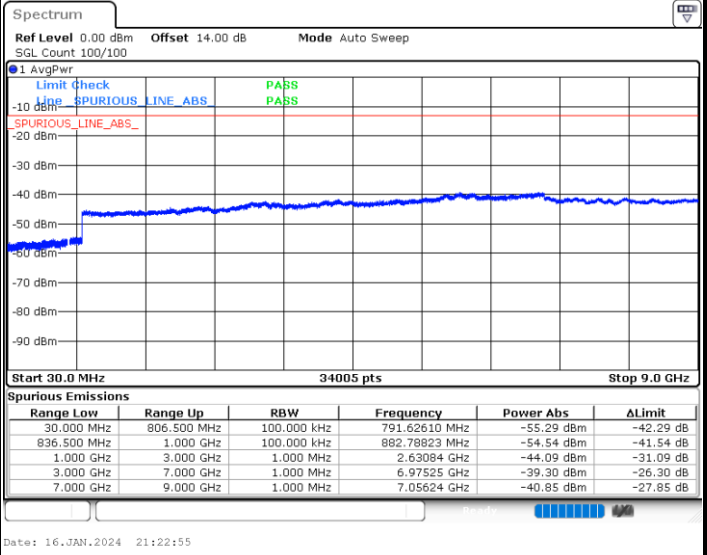
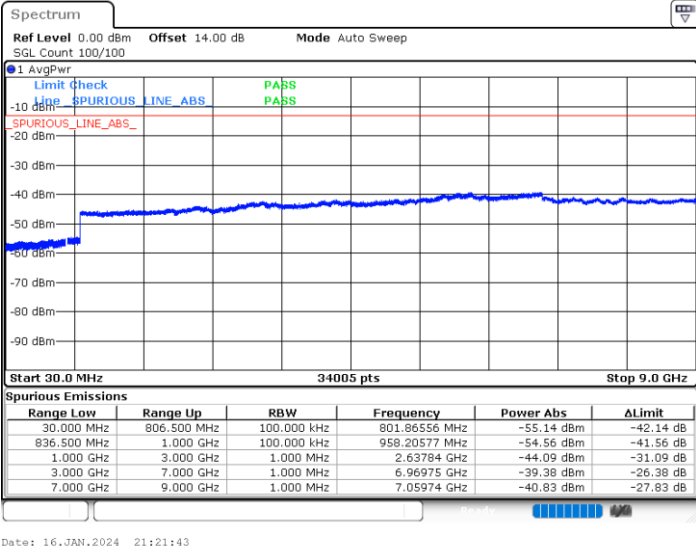

Highest Channel / QPSK

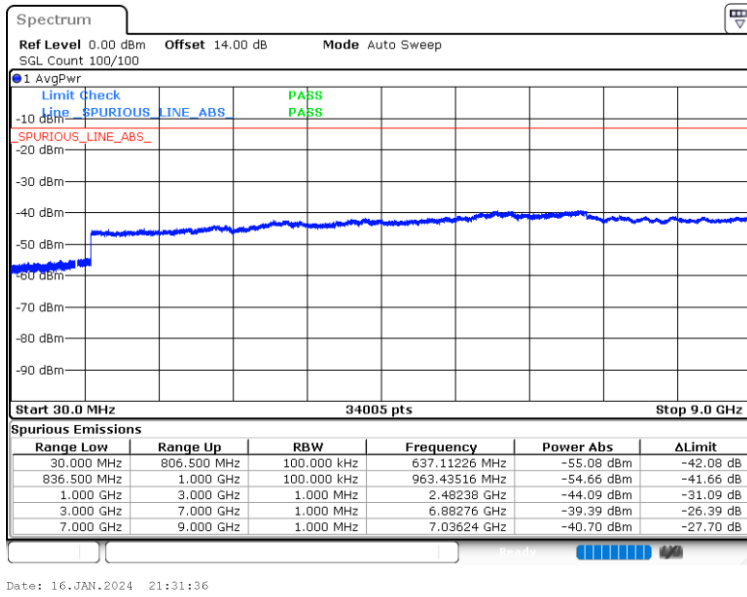



LTE Band 26 / 10MHz

Middle Channel / QPSK

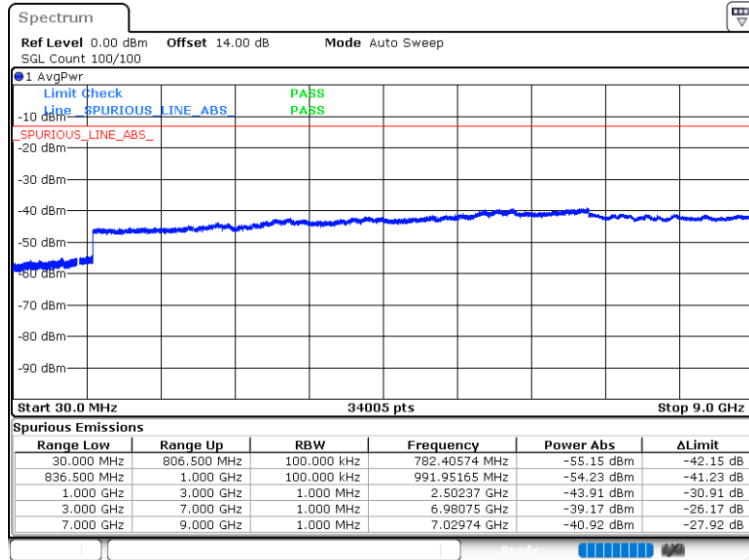

Date: 16. JAN. 2024 21:45:38

LTE Band 26 / 15MHz

High Channel / QPSK

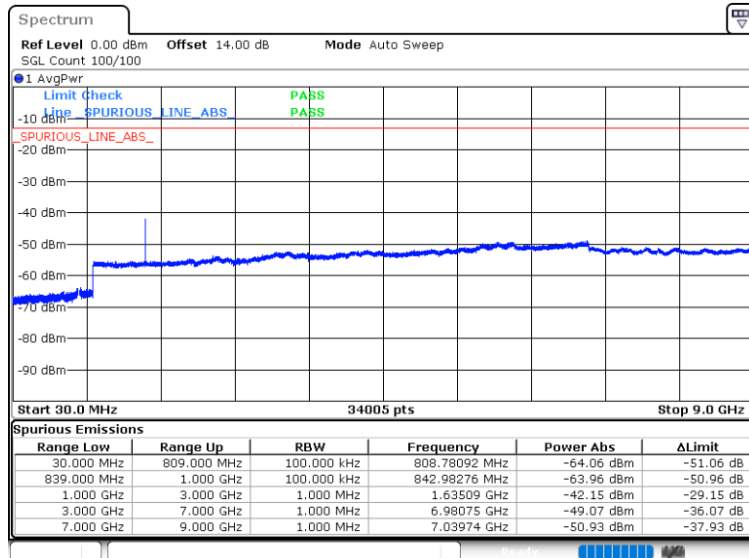

Date: 16. JAN. 2024 22:34:22



Frequency Stability

Test Conditions		LTE Band 26 (QPSK) / Middle Channel	Limit
Temperature (°C)	Voltage (Volt)	BW 10MHz	Note 2.
		Deviation (ppm)	Result
50	Normal Voltage	0.0076	PASS
40	Normal Voltage	0.0070	
30	Normal Voltage	0.0000	
20(Ref.)	Normal Voltage	0.0000	
10	Normal Voltage	0.0002	
0	Normal Voltage	0.0076	
-10	Normal Voltage	0.0000	
-20	Normal Voltage	0.0075	
-30	Normal Voltage	0.0072	
20	Maximum Voltage	0.0002	
20	Normal Voltage	0.0000	
20	Battery End Point	0.0073	

Note:

1. Normal Voltage = 3.91 V. ; Battery End Point (BEP) = 3.7 V. ; Maximum Voltage = 4.4 V.
2. The frequency fundamental emissions stay within the authorized frequency block.



Appendix B. Test Results of Radiated Test

Radiated Spurious Emission

Test Engineer :	Qingsheng He	Temperature :	22~25°C
		Relative Humidity :	48~52%

RSE pre-scanned harmonic for the different antennas, we choose the worst antenna mode to perform final test and record in the report.

LTE Band 26 / 10MHz / QPSK / Ant. 13									
Channel	Frequency (MHz)	ERP (dBm)	Limit (dBm)	Over Limit (dB)	SPA Reading (dBm)	S.G. Power (dBm)	TX Cable loss (dB)	TX Antenna Gain (dBi)	Polarization (H/V)
Middle	1629	-68.67	-13	-55.67	-73.71	-71.92	4.00	9.40	H
	2443.5	-65.33	-13	-52.33	-74.46	-68.90	4.88	10.60	H
	3258	-64.56	-13	-51.56	-76.36	-69.49	5.52	12.60	H
	1629	-68.61	-13	-55.61	-73.69	-71.86	4.00	9.40	V
	2443.5	-65.43	-13	-52.43	-74.94	-69.00	4.88	10.60	V
	3258	-64.16	-13	-51.16	-76.48	-69.09	5.52	12.60	V

Remark: Spurious emissions within 30-1000MHz were found more than 20dB below limit line.

LTE Band 26 / 15MHz / QPSK / Ant. 13									
Channel	Frequency (MHz)	ERP (dBm)	Limit (dBm)	Over Limit (dB)	SPA Reading (dBm)	S.G. Power (dBm)	TX Cable loss (dB)	TX Antenna Gain (dBi)	Polarization (H/V)
Middle	1634.4	-69.12	-13	-56.12	-74.19	-72.37	4.00	9.40	H
	2451.74	-65.28	-13	-52.28	-74.38	-68.85	4.88	10.60	H
	3269	-64.78	-13	-51.78	-76.49	-69.71	5.52	12.60	H
	1634.4	-68.72	-13	-55.72	-73.78	-71.97	4.00	9.40	V
	2451.74	-65.11	-13	-52.11	-74.59	-68.68	4.88	10.60	V
	3269	-64.25	-13	-51.25	-76.46	-69.18	5.52	12.60	V

Remark: Spurious emissions within 30-1000MHz were found more than 20dB below limit line.