


 Report No.: ZEWM2303000343RG05  
 Page: 1 of 136

## TEST REPORT

**Application No.:** ZEWM2303000343RG  
**Applicant:** vivo Mobile Communication Co., Ltd.  
**Address of Applicant:** No.1, vivo Road, Chang'an, Dongguan,Guangdong,China  
**Manufacturer:** vivo Mobile Communication Co., Ltd.  
**Address of Manufacturer:** No.1, vivo Road, Chang'an, Dongguan,Guangdong,China  
**EUT Description:** Mobile Phone  
**Model No.:** V2247  
**Trade Mark:** vivo  
**FCC ID:** 2AUCY-V2247  
**Standards:** FCC 47 CFR Part 2, Subpart J  
 FCC 47 CFR Part 15, Subpart C  
**Date of Receipt:** 2023/04/21  
**Date of Test:** 2023/04/21 to 2023/05/18  
**Date of Issue:** 2023/05/19

<b>Test Result :</b>	<b>PASS *</b>
----------------------	---------------

\* In the configuration tested, the EUT detailed in this report complied with the standards specified above.

Authorized Signature:

 Ervin Li  
 Regulatory Manager


Unless otherwise agreed in writing, this document is issued by the Company subject to its General Conditions of Service printed overleaf, available on request or accessible at <https://www.sgs.com/en/Terms-and-Conditions>. Attention is drawn to the limitation of liability, indemnification and jurisdiction issues defined therein. Any holder of this document is advised that information contained hereon reflects the Company's findings at the time of its intervention only and within the limits of Client's instructions, if any. The Company's sole responsibility is to its Client and this document does not exonerate parties to a transaction from exercising all their rights and obligations under the transaction documents. This document cannot be reproduced except in full, without prior written approval of the Company. Any unauthorized alteration, forgery or falsification of the content or appearance of this document is unlawful and offenders may be prosecuted to the fullest extent of the law. Unless otherwise stated the results shown in this test report refer only to the sample(s) tested and such sample(s) are retained for 30 days only.

Attention: To check the authenticity of testing /inspection report & certificate, please contact us at telephone: (86-755)8307 1443, or email: [CN.Doccheck@sgs.com](mailto:CN.Doccheck@sgs.com)

No.1 Workshop, M-10, Middle Section, Science & Technology Park, Nanshan District, Shenzhen, Guangdong, China 518057 t (86-755) 26012053 www.sgs.com.cn  
 中国·广东·深圳市南山区科技园中区M-10栋1号厂房 邮编: 518057 t (86-755) 26012053 sgs.china@sgs.com




# SGS-CSTC Standards Technical Services Co., Ltd. Shenzhen Branch

Report No.: ZEWM2303000343RG05  
Page: 2 of 136

## 1 Version

Revision Record				
Version	Chapter	Date	Modifier	Remark
01		2023/05/19		Original

Prepared By	 _____ (Dee Zheng) / Test Engineer
Checked By	 _____ (Daniel Wang) / Reviewer



Unless otherwise agreed in writing, this document is issued by the Company subject to its General Conditions of Service printed overleaf, available on request or accessible at <https://www.sgs.com/en/Terms-and-Conditions>. Attention is drawn to the limitation of liability, indemnification and jurisdiction issues defined therein. Any holder of this document is advised that information contained hereon reflects the Company's findings at the time of its intervention only and within the limits of Client's instructions, if any. The Company's sole responsibility is to its Client and this document does not exonerate parties to a transaction from exercising all their rights and obligations under the transaction documents. This document cannot be reproduced except in full, without prior written approval of the Company. Any unauthorized alteration, forgery or falsification of the content or appearance of this document is unlawful and offenders may be prosecuted to the fullest extent of the law. Unless otherwise stated the results shown in this test report refer only to the sample(s) tested and such sample(s) are retained for 30 days only.

Attention: To check the authenticity of testing / inspection report & certificate, please contact us at telephone: (86-755) 8307 1443, or email: [CN.Doccheck@sgs.com](mailto:CN.Doccheck@sgs.com)

No. 1 Workshop, M-10, Middle Section, Science & Technology Park, Nanshan District, Shenzhen, Guangdong, China 518057 t (86-755) 26012053 www.sgs.com.cn  
中国·广东·深圳市南山区科技园中区M-10栋1号厂房 邮编: 518057 t (86-755) 26012053 sgs.china@sgs.com



## 2 Test Summary

Test Item	FCC Rule No.	Test Method	Test Result	Result	Test Lab*
Antenna Requirement	15.203/15.247(b)	--	Clause 4.1	PASS	--
AC Power Line Conducted Emission	15.207	ANSI C63.10-2020 Section 6.2	Clause 4.2	PASS	B
Duty Cycle	--	--	Clause 4.3	For Report Purpose	A
Conducted Output Power	15.247 (b)(3)	ANSI C63.10-2020 Section 11.9.1.2	Clause 4.4	PASS	A
DTS (6 dB) Bandwidth & 99% Occupied Bandwidth	15.247 (a)(2)	ANSI C63.10-2020 Section 11.8 Option 2 / 6.9.3	Clause 4.5	PASS	A
Power Spectral Density	15.247 (e)	ANSI C63.10-2020 Section 11.10.2	Clause 4.6	PASS	A
Band-edge for RF Conducted Emissions	15.247(d)	ANSI C63.10-2020 Section 11.11	Clause 4.7	PASS	A
RF Conducted Spurious Emissions	15.247(d)	ANSI C63.10-2020 Section 11.11	Clause 4.8	PASS	A
Radiated Spurious Emissions	15.247(d);15.205/15.209	ANSI C63.10-2020 Section 11.12	Clause 4.9	PASS	B
Restricted bands around fundamental frequency (Radiated Emission)	15.247(d);15.205/15.209	ANSI C63.10-2020 Section 11.12	Clause 4.10	PASS	B

\*Remark:  
 Lab A SGS-CSTC Standards Technical Services Co., Ltd. Shenzhen Branch  
 Lab B SGS-CSTC Standards Technical Services (Xi'an) Co., Ltd.



Unless otherwise agreed in writing, this document is issued by the Company subject to its General Conditions of Service printed overleaf, available on request or accessible at <https://www.sgs.com/en/Terms-and-Conditions>. Attention is drawn to the limitation of liability, indemnification and jurisdiction issues defined therein. Any holder of this document is advised that information contained hereon reflects the Company's findings at the time of its intervention only and within the limits of Client's instructions, if any. The Company's sole responsibility is to its Client and this document does not exonerate parties to a transaction from exercising all their rights and obligations under the transaction documents. This document cannot be reproduced except in full, without prior written approval of the Company. Any unauthorized alteration, forgery or falsification of the content or appearance of this document is unlawful and offenders may be prosecuted to the fullest extent of the law. Unless otherwise stated the results shown in this test report refer only to the sample(s) tested and such sample(s) are retained for 30 days only.

Attention: To check the authenticity of testing / inspection report & certificate, please contact us at telephone: (86-755)83071443, or email: [CN.Doccheck@sgs.com](mailto:CN.Doccheck@sgs.com)

No. 1 Workshop, M-10, Middle Section, Science & Technology Park, Nanshan District, Shenzhen, Guangdong, China 518057 t (86-755) 26012053 www.sgs.com.cn  
 中国·广东·深圳市南山区科技园中区M-10栋1号厂房 邮编: 518057 t (86-755) 26012053 sgs.china@sgs.com



## Contents

1	Version .....	2
2	Test Summary .....	3
3	General Information.....	5
3.1	Details of Client.....	5
3.2	Test Location .....	5
3.3	Test Facility.....	6
3.4	General Description of EUT .....	7
3.5	Test Environment and Mode .....	9
3.6	Description of Support Units .....	9
3.7	Worst-case configuration and mode.....	9
4	Test results and Measurement Data.....	10
4.1	Antenna Requirement.....	10
4.2	AC Power Line Conducted Emissions.....	11
4.3	Duty Cycle.....	15
4.4	Conducted Output Power.....	16
4.5	DTS (6 dB) Bandwidth & 99% Occupied Bandwidth .....	17
4.6	Power Spectral Density.....	18
4.7	Band-edge for RF Conducted Emissions .....	19
4.8	RF Conducted Spurious Emissions.....	20
4.9	Radiated Spurious Emissions .....	21
4.10	Restricted bands around fundamental frequency.....	24
5	Measurement Uncertainty (95% confidence levels, k=2).....	27
6	Equipment List.....	28
7	Photographs - Setup Photos.....	30



Unless otherwise agreed in writing, this document is issued by the Company subject to its General Conditions of Service printed overleaf, available on request or accessible at <https://www.sgs.com/en/Terms-and-Conditions>. Attention is drawn to the limitation of liability, indemnification and jurisdiction issues defined therein. Any holder of this document is advised that information contained hereon reflects the Company's findings at the time of its intervention only and within the limits of Client's instructions, if any. The Company's sole responsibility is to its Client and this document does not exonerate parties to a transaction from exercising all their rights and obligations under the transaction documents. This document cannot be reproduced except in full, without prior written approval of the Company. Any unauthorized alteration, forgery or falsification of the content or appearance of this document is unlawful and offenders may be prosecuted to the fullest extent of the law. Unless otherwise stated the results shown in this test report refer only to the sample(s) tested and such sample(s) are retained for 30 days only.

Attention: To check the authenticity of testing / inspection report & certificate, please contact us at telephone: (86-755) 8307 1443, or email: [CN.Doccheck@sgs.com](mailto:CN.Doccheck@sgs.com)

No. 1 Workshop, M-10, Middle Section, Science & Technology Park, Nanshan District, Shenzhen, Guangdong, China 518057 t (86-755) 26012053 www.sgs.com.cn  
 中国·广东·深圳市南山区科技园中区M-10栋1号厂房 邮编: 518057 t (86-755) 26012053 sgs.china@sgs.com



# SGS-CSTC Standards Technical Services Co., Ltd. Shenzhen Branch

Report No.: ZEWM2303000343RG05  
Page: 5 of 136

## 3 General Information

### 3.1 Details of Client

Applicant:	vivo Mobile Communication Co., Ltd.
Address of Applicant:	No.1, vivo Road, Chang'an, Dongguan,Guangdong,China
Manufacturer:	vivo Mobile Communication Co., Ltd.
Address of Manufacturer:	No.1, vivo Road, Chang'an, Dongguan,Guangdong,China

### 3.2 Test Location

<b>Lab A:</b>	
Company:	SGS-CSTC Standards Technical Services Co., Ltd. Shenzhen Branch
Address:	No. 1 Workshop, M-10, Middle section, Science & Technology Park, Nanshan District, Shenzhen, Guangdong, China
Post code:	518057
Test engineer:	Jerry Zeng
<b>Lab B:</b>	
Company:	SGS-CSTC Standards Technical Services (Xi'an) Co., Ltd.
Address:	1/F, Unit D, Building 1, Kanghong Orange Science Park, No.137, Keyuan 3rd Road, Fengdong New Town, Xi' an, Shaanxi China
Post code:	710086
Test engineer:	Ken Liu



Unless otherwise agreed in writing, this document is issued by the Company subject to its General Conditions of Service printed overleaf, available on request or accessible at <https://www.sgs.com/en/Terms-and-Conditions>. Attention is drawn to the limitation of liability, indemnification and jurisdiction issues defined therein. Any holder of this document is advised that information contained hereon reflects the Company's findings at the time of its intervention only and within the limits of Client's instructions, if any. The Company's sole responsibility is to its Client and this document does not exonerate parties to a transaction from exercising all their rights and obligations under the transaction documents. This document cannot be reproduced except in full, without prior written approval of the Company. Any unauthorized alteration, forgery or falsification of the content or appearance of this document is unlawful and offenders may be prosecuted to the fullest extent of the law. Unless otherwise stated the results shown in this test report refer only to the sample(s) tested and such sample(s) are retained for 30 days only.

Attention: To check the authenticity of testing / inspection report & certificate, please contact us at telephone: (86-755) 8307 1443, or email: [CN\\_Doccheck@sgs.com](mailto:CN_Doccheck@sgs.com)

No.1 Workshop, M-10, Middle Section, Science & Technology Park, Nanshan District, Shenzhen, Guangdong, China 518057 t (86-755) 26012053 www.sgs.com.cn  
中国·广东·深圳市南山区科技园中区M-10栋1号厂房 邮编: 518057 t (86-755) 26012053 sgs.china@sgs.com





### 3.3 Test Facility

The test facility is recognized, certified, or accredited by the following organizations:

#### Lab A:

- **A2LA (Certificate No. 3816.01)**

SGS-CSTC Standards Technical Services Co., Ltd. Shenzhen Branch is accredited by the American Association for Laboratory Accreditation(A2LA). Certificate No. 3816.01.

- **VCCI**

The 3m Fully-anechoic chamber for above 1GHz, 10m Semi-anechoic chamber for below 1GHz, Shielded Room for Mains Port Conducted Interference Measurement and Telecommunication Port Conducted Interference Measurement of SGS-CSTC Standards Technical Services Co., Ltd. have been registered in accordance with the Regulations for Voluntary Control Measures with Registration No.: G-20026, R-14188, C-12383 and T-11153 respectively.

- **Innovation, Science and Economic Development Canada**

SGS-CSTC Standards Technical Services Co., Ltd. Shenzhen Branch has been recognized by ISED as an accredited testing laboratory.

CAB identifier: CN0006.

IC#: 4620C.

- **FCC –Designation Number: CN1336**

SGS-CSTC Standards Technical Services Co., Ltd. Shenzhen Branch has been recognized as an accredited testing laboratory.

Designation Number: CN1336.

Test Firm Registration Number: 787754

#### Lab B:

- **A2LA (Certificate No. 4854.01)**

SGS-CSTC Standards Technical Services (Xi'an) Co., Ltd. is accredited by the American Association for Laboratory Accreditation(A2LA). Certificate No. 4854.01.

- **Innovation, Science and Economic Development Canada**

SGS-CSTC Standards Technical Services (Xi'an) Co., Ltd. has been recognized by ISED as an accredited testing laboratory.

CAB identifier: CN0095.

IC#: 25613.

- **FCC –Designation Number: CN1337**

SGS-CSTC Standards Technical Services (Xi'an) Co., Ltd. has been recognized as an accredited testing laboratory.

Designation Number: CN1337.

Test Firm Registration Number: 917410



Unless otherwise agreed in writing, this document is issued by the Company subject to its General Conditions of Service printed overleaf, available on request or accessible at <https://www.sgs.com/en/Terms-and-Conditions>. Attention is drawn to the limitation of liability, indemnification and jurisdiction issues defined therein. Any holder of this document is advised that information contained hereon reflects the Company's findings at the time of its intervention only and within the limits of Client's instructions, if any. The Company's sole responsibility is to its Client and this document does not exonerate parties to a transaction from exercising all their rights and obligations under the transaction documents. This document cannot be reproduced except in full, without prior written approval of the Company. Any unauthorized alteration, forgery or falsification of the content or appearance of this document is unlawful and offenders may be prosecuted to the fullest extent of the law. Unless otherwise stated the results shown in this test report refer only to the sample(s) tested and such sample(s) are retained for 30 days only.

Attention: To check the authenticity of testing / inspection report & certificate, please contact us at telephone: (86-755) 8307 1443, or email: [CN\\_Doccheck@sgs.com](mailto:CN_Doccheck@sgs.com)

No.1 Workshop, M-10, Middle Section, Science & Technology Park, Nanshan District, Shenzhen, Guangdong, China 518057 t (86-755) 26012053 www.sgsgroup.com.cn  
 中国·广东·深圳市南山区科技园中区M-10栋1号厂房 邮编: 518057 t (86-755) 26012053 sgs.china@sgs.com



# SGS-CSTC Standards Technical Services Co., Ltd. Shenzhen Branch

Report No.: ZEWM2303000343RG05  
Page: 7 of 136

## 3.4 General Description of EUT

EUT Description:	Mobile Phone	
Model No.:	V2247	
Trade Mark:	vivo	
Hardware Version:	MP_0.1	
Software Version:	PD2280IF_EX_A_13.0.6.1.W30	
IMEI:	RF Conducted	IMEI1:863548060194275 IMEI2:863548060194267
	RSE & AC power line	863548060194937
Operation Frequency:	802.11b/g/n(HT20):	2412MHz to 2462MHz
	802.11n(HT40):	2422MHz to 2452MHz
Modulation Type:	802.11b:	DSSS (DBPSK, DQPSK, CCK)
	802.11g/n:	OFDM (BPSK, QPSK, 16QAM, 64QAM)
Number of Channels:	802.11b/g/n(HT20): 11 802.11n(HT40): 7	
Channel Spacing:	5MHz	
Smart System:	<input checked="" type="checkbox"/> SISO	802.11b/g/n
	<input type="checkbox"/> MIMO	CDD: 802.11b/g/n: Tx & Rx
		STBC: 802.11n: Tx & Rx
	<input type="checkbox"/> Diversity	TXBF: 802.11n: Tx & Rx
Antenna Type:	PIFA Antenna	
Antenna Gain:	-3.2dBi(Ant22)	
	Note: The antenna gain are derived from the gain information report provided by the manufacturer.	
RF Cable:	2000MHz ~ 3000MHz(1.1dB)	
Remark:	As above information is provided and confirmed by the applicant. SGS is not liable to the accuracy, suitability, reliability or/and integrity of the information.	



Unless otherwise agreed in writing, this document is issued by the Company subject to its General Conditions of Service printed overleaf, available on request or accessible at <https://www.sgs.com/en/Terms-and-Conditions>. Attention is drawn to the limitation of liability, indemnification and jurisdiction issues defined therein. Any holder of this document is advised that information contained hereon reflects the Company's findings at the time of its intervention only and within the limits of Client's instructions, if any. The Company's sole responsibility is to its Client and this document does not exonerate parties to a transaction from exercising all their rights and obligations under the transaction documents. This document cannot be reproduced except in full, without prior written approval of the Company. Any unauthorized alteration, forgery or falsification of the content or appearance of this document is unlawful and offenders may be prosecuted to the fullest extent of the law. Unless otherwise stated the results shown in this test report refer only to the sample(s) tested and such sample(s) are retained for 30 days only.

Attention: To check the authenticity of testing /inspection report & certificate, please contact us at telephone: (86-755)8307 1443, or email: [CM.Doccheck@sgs.com](mailto:CM.Doccheck@sgs.com)

No.1 Workshop, M-10, Middle Section, Science & Technology Park, Nanshan District, Shenzhen, Guangdong, China 518057 t (86-755) 26012053 www.sgs.com.cn

中国·广东·深圳市南山区科技园中区M-10栋1号厂房 邮编: 518057 t (86-755) 26012053 sgs.china@sgs.com



# SGS-CSTC Standards Technical Services Co., Ltd. Shenzhen Branch

Report No.: ZEWM2303000343RG05  
Page: 8 of 136

Operation Frequency of each channel (802.11b/g/n HT20)							
Channel	Frequency	Channel	Frequency	Channel	Frequency	Channel	Frequency
1	2412MHz	4	2427MHz	7	2442MHz	10	2457MHz
2	2417MHz	5	2432MHz	8	2447MHz	11	2462MHz
3	2422MHz	6	2437MHz	9	2452MHz		
Operation Frequency of each channel (802.11n HT40)							
Channel	Frequency	Channel	Frequency	Channel	Frequency	Channel	Frequency
3	2422MHz	6	2437MHz	9	2452MHz		
4	2427MHz	7	2442MHz				
5	2432MHz	8	2447MHz				
Remark: In section 15.31(m), regards to the operating frequency range over 10 MHz, the Lowest frequency, the middle frequency, and the highest frequency of channel were selected to perform the test, and the selected channel see below:							
Channel	Frequency for 802.11 b/g/n (HT20)			Frequency for 802.11n (HT40)			
The Lowest channel	2412MHz			2422MHz			
The Middle channel	2437MHz			2437MHz			
The Highest channel	2462MHz			2452MHz			



Unless otherwise agreed in writing, this document is issued by the Company subject to its General Conditions of Service printed overleaf, available on request or accessible at <https://www.sgs.com/en/Terms-and-Conditions>. Attention is drawn to the limitation of liability, indemnification and jurisdiction issues defined therein. Any holder of this document is advised that information contained hereon reflects the Company's findings at the time of its intervention only and within the limits of Client's instructions, if any. The Company's sole responsibility is to its Client and this document does not exonerate parties to a transaction from exercising all their rights and obligations under the transaction documents. This document cannot be reproduced except in full, without prior written approval of the Company. Any unauthorized alteration, forgery or falsification of the content or appearance of this document is unlawful and offenders may be prosecuted to the fullest extent of the law. Unless otherwise stated the results shown in this test report refer only to the sample(s) tested and such sample(s) are retained for 30 days only.

Attention: To check the authenticity of testing / inspection report & certificate, please contact us at telephone: (86-755) 8307 1443, or email: [CN.Doccheck@sgs.com](mailto:CN.Doccheck@sgs.com)

No. 1 Workshop, M-10, Middle Section, Science & Technology Park, Nanshan District, Shenzhen, Guangdong, China 518057 t (86-755) 26012053 www.sgs.com.cn  
中国·广东·深圳市南山区科技园中区M-10栋1号厂房 邮编: 518057 t (86-755) 26012053 sgs.china@sgs.com





### 3.5 Test Environment and Mode

Environment Parameter	96~101 kPa Selected Values During Tests	
Relative Humidity	40-60 % RH Ambient	
Value	Temperature(°C)	Voltage(V)
NTNV	22~25	3.89
Remark: NV: Normal Voltage NT: Normal Temperature		

### 3.6 Description of Support Units

The EUT has been tested as an independent unit.

### 3.7 Worst-case configuration and mode

Low data rate was used to test on antenna port conducted tests and radiated spurious emissions since it has the highest maximum power. Following are the worst-case data rates set for test:

Modulation Type	SISO - Data Rate	MIMO - Data Rate
802.11b	1 Mbps	/
802.11g	6 Mbps	/
802.11n (HT 20)	MCS0 (6.5 Mbps)	/
802.11n (HT 40)	MCS0 (13.5 Mbps)	/



Unless otherwise agreed in writing, this document is issued by the Company subject to its General Conditions of Service printed overleaf, available on request or accessible at <https://www.sgs.com/en/Terms-and-Conditions>. Attention is drawn to the limitation of liability, indemnification and jurisdiction issues defined therein. Any holder of this document is advised that information contained hereon reflects the Company's findings at the time of its intervention only and within the limits of Client's instructions, if any. The Company's sole responsibility is to its Client and this document does not exonerate parties to a transaction from exercising all their rights and obligations under the transaction documents. This document cannot be reproduced except in full, without prior written approval of the Company. Any unauthorized alteration, forgery or falsification of the content or appearance of this document is unlawful and offenders may be prosecuted to the fullest extent of the law. Unless otherwise stated the results shown in this test report refer only to the sample(s) tested and such sample(s) are retained for 30 days only.

Attention: To check the authenticity of testing / inspection report & certificate, please contact us at telephone: (86-755) 8307 1443, or email: [CN.Doccheck@sgs.com](mailto:CN.Doccheck@sgs.com)

No. 1 Workshop, M-10, Middle Section, Science & Technology Park, Nanshan District, Shenzhen, Guangdong, China 518057 t (86-755) 26012053 www.sgs.com.cn  
 中国·广东·深圳市南山区科技园中区M-10栋1号厂房 邮编: 518057 t (86-755) 26012053 sgs.china@sgs.com



## 4 Test results and Measurement Data

### 4.1 Antenna Requirement

<b>Standard requirement:</b>	47 CFR Part 15C Section 15.203 /247(b)
<p>15.203 requirement:          An intentional radiator shall be designed to ensure that no antenna other than that furnished by the responsible party shall be used with the device. The use of a permanently attached antenna or of an antenna that uses a unique coupling to the intentional radiator, the manufacturer may design the unit so that a broken antenna can be replaced by the user, but the use of a standard antenna jack or electrical connector is prohibited.</p> <p>15.247(b) (4) requirement:          The conducted output power limit specified in paragraph (b) of this section is based on the use of antennas with directional gains that do not exceed 6 dBi. Except as shown in paragraph (c) of this section, if transmitting antennas of directional gain greater than 6 dBi are used, the conducted output power from the intentional radiator shall be reduced below the stated values in paragraphs (b)(1), (b)(2), and (b)(3) of this section, as appropriate, by the amount in dB that the directional gain of the antenna exceeds 6 dBi.</p>	
<p>The antenna is PIFA Antenna and no consideration of replacement. The best case gain of the antenna is -3.2dBi.*</p> <p><i>*Note:</i>  <i>The antenna gain are derived from the gain information report provided by the manufacturer.</i></p> <p><i>Remark:</i>  <i>As above information is provided and confirmed by the applicant. SGS is not liable to the accuracy, suitability, reliability or/and integrity of the information.</i></p>	



Unless otherwise agreed in writing, this document is issued by the Company subject to its General Conditions of Service printed overleaf, available on request or accessible at <https://www.sgs.com/en/Terms-and-Conditions>. Attention is drawn to the limitation of liability, indemnification and jurisdiction issues defined therein. Any holder of this document is advised that information contained hereon reflects the Company's findings at the time of its intervention only and within the limits of Client's instructions, if any. The Company's sole responsibility is to its Client and this document does not exonerate parties to a transaction from exercising all their rights and obligations under the transaction documents. This document cannot be reproduced except in full, without prior written approval of the Company. Any unauthorized alteration, forgery or falsification of the content or appearance of this document is unlawful and offenders may be prosecuted to the fullest extent of the law. Unless otherwise stated the results shown in this test report refer only to the sample(s) tested and such sample(s) are retained for 30 days only.

Attention: To check the authenticity of testing /inspection report & certificate, please contact us at telephone: (86-755)8307 1443, or email: [CM.Doccheck@sgs.com](mailto:CM.Doccheck@sgs.com)

No.1 Workshop, M-10, Middle Section, Science & Technology Park, Nanshan District, Shenzhen, Guangdong, China 518057 t (86-755) 26012053 www.sgs.com.cn  
 中国·广东·深圳市南山区科技园中区M-10栋1号厂房 邮编: 518057 t (86-755) 26012053 sgs.china@sgs.com



## 4.2 AC Power Line Conducted Emissions

Test Requirement:	47 CFR Part 15C Section 15.207		
Test Method:	ANSI C63.10-2020 Section 6.2		
Test Frequency Range:	150kHz to 30MHz		
Receiver Setup:	RBW = 9kHz, VBW = 30kHz		
Limit:	Frequency range (MHz)	Limit (dBuV)	
		Quasi-peak	Average
	0.15-0.5	66 to 56*	56 to 46*
	0.5-5	56	46
	5-30	60	50
	* Decreases with the logarithm of the frequency.		
Test Procedure:	<p>1) The mains terminal disturbance voltage test was conducted in a shielded room.</p> <p>2) The EUT was connected to AC power source through a LISN 1 (Line Impedance Stabilization Network) which provides a 50Ω/50μH + 5Ω linear impedance. The power cables of all other units of the EUT were connected to a second LISN 2, which was bonded to the ground reference plane in the same way as the LISN 1 for the unit being measured. A multiple socket outlet strip was used to connect multiple power cables to a single LISN provided the rating of the LISN was not exceeded.</p> <p>3) The tabletop EUT was placed upon a non-metallic table 0.8m above the ground reference plane. And for floor-standing arrangement, the EUT was placed on the horizontal ground reference plane,</p> <p>4) The test was performed with a vertical ground reference plane. The rear of the EUT shall be 0.4 m from the vertical ground reference plane. The vertical ground reference plane was bonded to the horizontal ground reference plane. The LISN 1 was placed 0.8 m from the boundary of the unit under test and bonded to a ground reference plane for LISNs mounted on top of the ground reference plane. This distance was between the closest points of the LISN 1 and the EUT. All other units of the EUT and associated equipment was at least 0.8 m from the LISN 2. In order to find the maximum emission, the relative positions of equipment and all of the interface cables must be changed according to ANSI C63.10-2020 on conducted measurement.</p>		



Unless otherwise agreed in writing, this document is issued by the Company subject to its General Conditions of Service printed overleaf, available on request or accessible at <https://www.sgs.com/en/Terms-and-Conditions>. Attention is drawn to the limitation of liability, indemnification and jurisdiction issues defined therein. Any holder of this document is advised that information contained hereon reflects the Company's findings at the time of its intervention only and within the limits of Client's instructions, if any. The Company's sole responsibility is to its Client and this document does not exonerate parties to a transaction from exercising all their rights and obligations under the transaction documents. This document cannot be reproduced except in full, without prior written approval of the Company. Any unauthorized alteration, forgery or falsification of the content or appearance of this document is unlawful and offenders may be prosecuted to the fullest extent of the law. Unless otherwise stated the results shown in this test report refer only to the sample(s) tested and such sample(s) are retained for 30 days only.

Attention: To check the authenticity of testing / inspection report & certificate, please contact us at telephone: (86-755) 8307 1443, or email: [CN.Doccheck@sgs.com](mailto:CN.Doccheck@sgs.com)

No. 1 Workshop, M-10, Middle Section, Science & Technology Park, Nanshan District, Shenzhen, Guangdong, China 518057 t (86-755) 26012053 www.sgs.com.cn  
 中国·广东·深圳市南山区科技园中区M-10栋1号厂房 邮编: 518057 t (86-755) 26012053 sgs.china@sgs.com



# SGS-CSTC Standards Technical Services Co., Ltd. Shenzhen Branch

Report No.: ZEWM2303000343RG05  
Page: 12 of 136

Test Setup:	
Exploratory Test Mode:	Transmitting with all kind of modulations, data rates at lowest, middle and highest channel. Charge + Transmitting mode.
Final Test Mode:	Refer to section 3.7 for details. Only the worst case is recorded in the report.
Instruments Used:	Refer to section 6 for details.
Test Results:	Pass



Unless otherwise agreed in writing, this document is issued by the Company subject to its General Conditions of Service printed overleaf, available on request or accessible at <https://www.sgs.com/en/Terms-and-Conditions>. Attention is drawn to the limitation of liability, indemnification and jurisdiction issues defined therein. Any holder of this document is advised that information contained hereon reflects the Company's findings at the time of its intervention only and within the limits of Client's instructions, if any. The Company's sole responsibility is to its Client and this document does not exonerate parties to a transaction from exercising all their rights and obligations under the transaction documents. This document cannot be reproduced except in full, without prior written approval of the Company. Any unauthorized alteration, forgery or falsification of the content or appearance of this document is unlawful and offenders may be prosecuted to the fullest extent of the law. Unless otherwise stated the results shown in this test report refer only to the sample(s) tested and such sample(s) are retained for 30 days only.

Attention: To check the authenticity of testing / inspection report & certificate, please contact us at telephone: (86-755) 8307 1443, or email: [CN\\_Doccheck@sgs.com](mailto:CN_Doccheck@sgs.com)

No. 1 Workshop, M-10, Middle Section, Science & Technology Park, Nanshan District, Shenzhen, Guangdong, China 518057 t (86-755) 26012053 www.sgsgroup.com.cn  
中国·广东·深圳市南山区科技园中区M-10栋1号厂房 邮编: 518057 t (86-755) 26012053 sgs.china@sgs.com



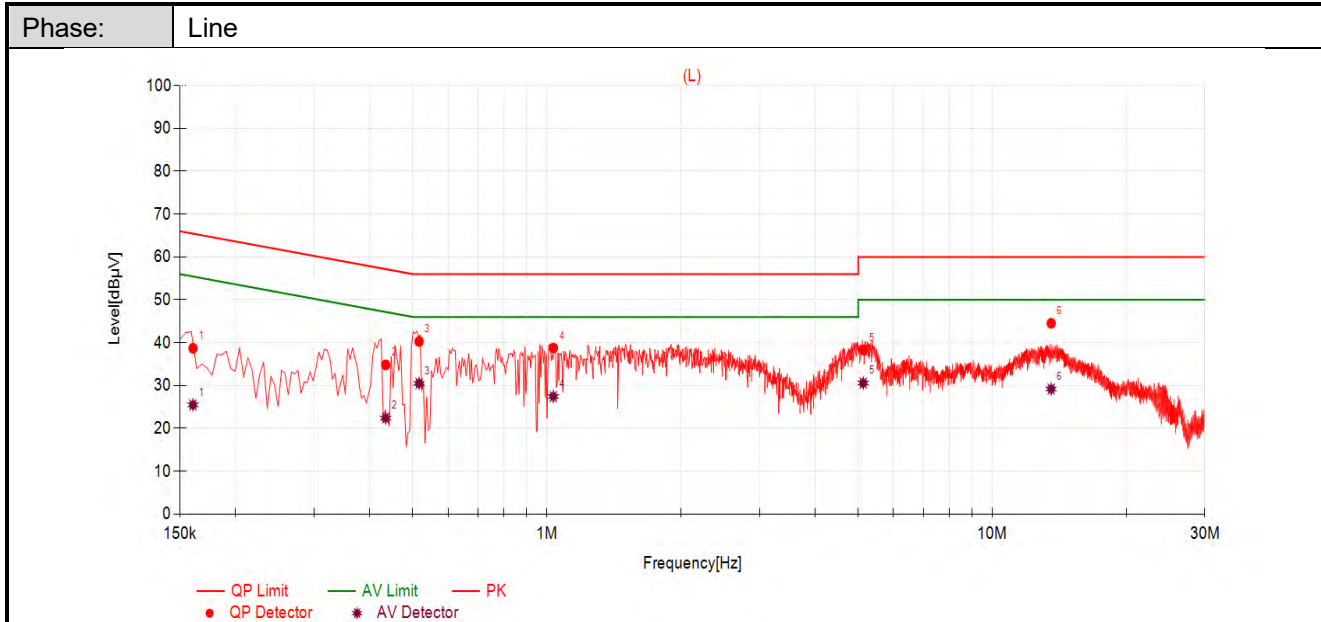


# SGS-CSTC Standards Technical Services Co., Ltd. Shenzhen Branch

Report No.: ZEWM2303000343RG05  
Page: 13 of 136

## Measurement Data

An initial pre-scan was performed on the live and neutral lines with peak detector. Quasi-Peak and Average measurement were performed at the frequencies with maximized peak emission were detected.



### Final Data List

NO.	Frequency [MHz]	Factor [dB]	QP Reading [dBµV]	QP Value [dBµV]	QP Limit [dBµV]	QP Margin [dB]	AV Reading [dBµV]	AV Value [dBµV]	AV Limit [dBµV]	AV Margin [dB]	Verdict
1	0.1604	9.86	28.84	38.70	65.45	26.75	15.63	25.49	55.45	29.96	PASS
2	0.4343	9.86	24.96	34.82	57.17	22.35	12.54	22.40	47.17	24.77	PASS
3	0.5163	9.89	30.40	40.29	56.00	15.71	20.61	30.50	46.00	15.50	PASS
4	1.0337	9.84	28.91	38.75	56.00	17.25	17.60	27.44	46.00	18.56	PASS
5	5.1318	9.88	28.42	38.30	60.00	21.70	20.71	30.59	50.00	19.41	PASS
6	13.5602	10.14	34.39	44.53	60.00	15.47	19.06	29.20	50.00	20.80	PASS

### Remark:

- The following Quasi-Peak and Average measurements were performed on the EUT:
- Value = Reading[dBµV] + Factor(Lisn factor[dB] + cable loss[dB]).
- Margin = Limit[dBµV] – Value[dBµV]



Unless otherwise agreed in writing, this document is issued by the Company subject to its General Conditions of Service printed overleaf, available on request or accessible at <https://www.sgs.com/en/Terms-and-Conditions>. Attention is drawn to the limitation of liability, indemnification and jurisdiction issues defined therein. Any holder of this document is advised that information contained hereon reflects the Company's findings at the time of its intervention only and within the limits of Client's instructions, if any. The Company's sole responsibility is to its Client and this document does not exonerate parties to a transaction from exercising all their rights and obligations under the transaction documents. This document cannot be reproduced except in full, without prior written approval of the Company. Any unauthorized alteration, forgery or falsification of the content or appearance of this document is unlawful and offenders may be prosecuted to the fullest extent of the law. Unless otherwise stated the results shown in this test report refer only to the sample(s) tested and such sample(s) are retained for 30 days only.

Attention: To check the authenticity of testing / inspection report & certificate, please contact us at telephone: (86-755) 8307 1443, or email: [CN.Doccheck@sgs.com](mailto:CN.Doccheck@sgs.com)

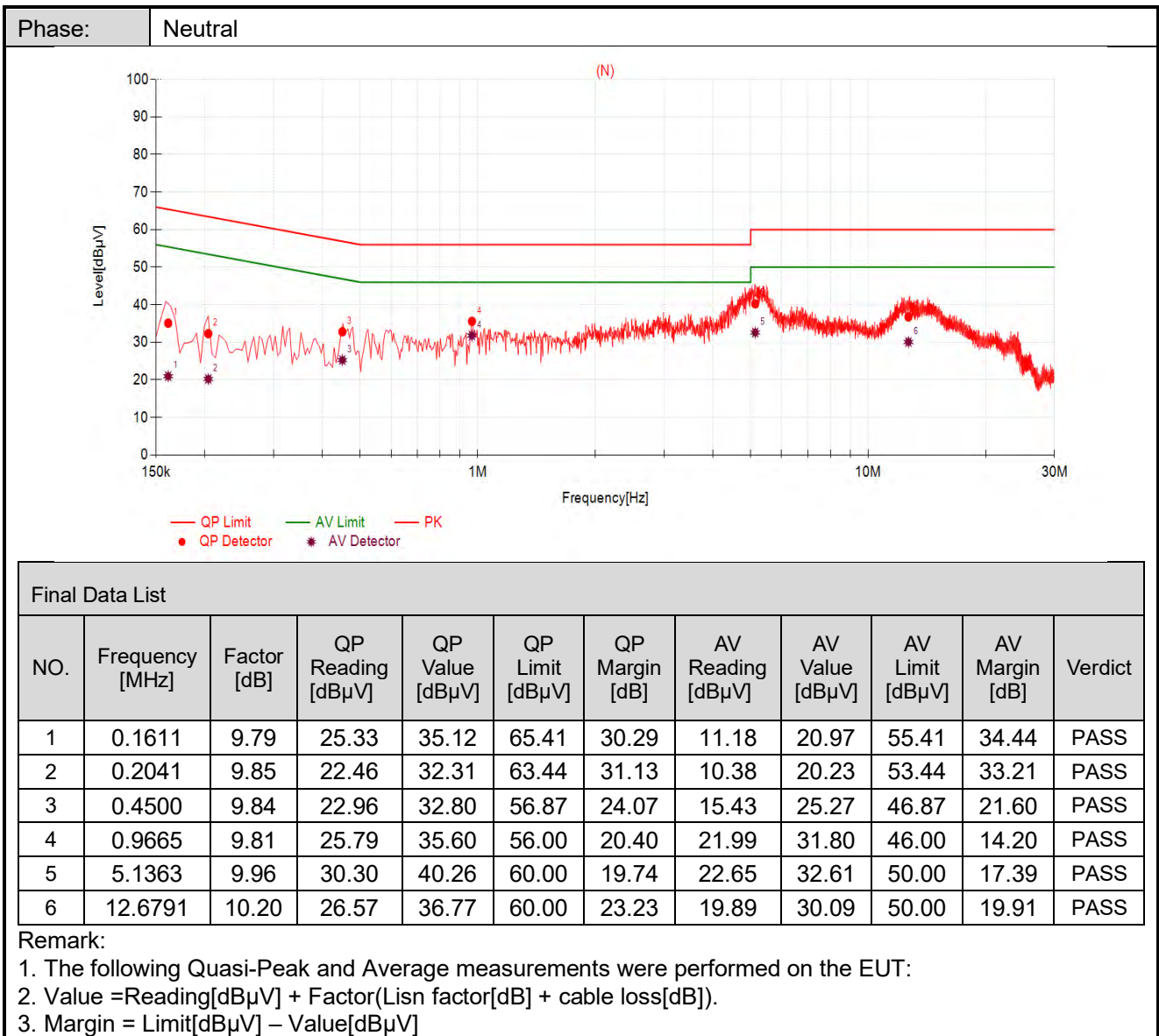
No. 1 Workshop, M-10, Middle Section, Science & Technology Park, Nanshan District, Shenzhen, Guangdong, China 518057 t (86-755) 26012053 www.sgs.com.cn  
中国·广东·深圳市南山区科技园中区M-10栋1号厂房 邮编: 518057 t (86-755) 26012053 sgs.china@sgs.com





**SGS-CSTC Standards Technical Services Co., Ltd.**  
**Shenzhen Branch**

Report No.: ZEWM2303000343RG05  
 Page: 14 of 136



Unless otherwise agreed in writing, this document is issued by the Company subject to its General Conditions of Service printed overleaf, available on request or accessible at <https://www.sgs.com/en/Terms-and-Conditions>. Attention is drawn to the limitation of liability, indemnification and jurisdiction issues defined therein. Any holder of this document is advised that information contained hereon reflects the Company's findings at the time of its intervention only and within the limits of Client's instructions, if any. The Company's sole responsibility is to its Client and this document does not exonerate parties to a transaction from exercising all their rights and obligations under the transaction documents. This document cannot be reproduced except in full, without prior written approval of the Company. Any unauthorized alteration, forgery or falsification of the content or appearance of this document is unlawful and offenders may be prosecuted to the fullest extent of the law. Unless otherwise stated the results shown in this test report refer only to the sample(s) tested and such sample(s) are retained for 30 days only.

Attention: To check the authenticity of testing / inspection report & certificate, please contact us at telephone: (86-755) 8307 1443, or email: [CM.Doccheck@sgs.com](mailto:CM.Doccheck@sgs.com)

No. 1 Workshop, M-10, Middle Section, Science & Technology Park, Nanshan District, Shenzhen, Guangdong, China 518057 t (86-755) 26012053 www.sgs.com.cn  
 中国·广东·深圳市南山区科技园中区M-10栋1号厂房 邮编: 518057 t (86-755) 26012053 sgs.china@sgs.com


 Report No.: ZEWM2303000343RG05  
 Page: 15 of 136

### 4.3 Duty Cycle

The detailed test data see: **Appendix**



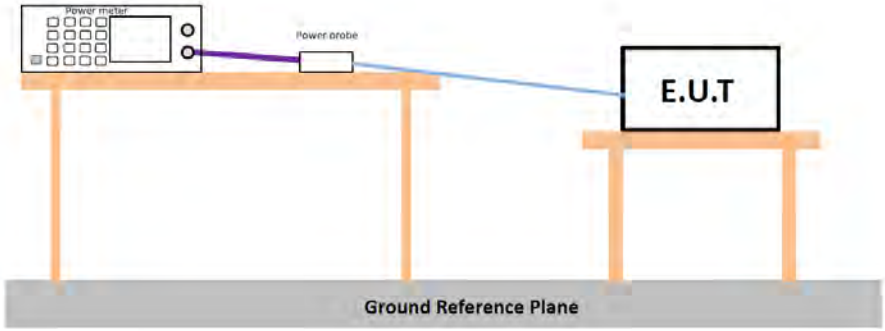
Unless otherwise agreed in writing, this document is issued by the Company subject to its General Conditions of Service printed overleaf, available on request or accessible at <https://www.sgs.com/en/Terms-and-Conditions>. Attention is drawn to the limitation of liability, indemnification and jurisdiction issues defined therein. Any holder of this document is advised that information contained hereon reflects the Company's findings at the time of its intervention only and within the limits of Client's instructions, if any. The Company's sole responsibility is to its Client and this document does not exonerate parties to a transaction from exercising all their rights and obligations under the transaction documents. This document cannot be reproduced except in full, without prior written approval of the Company. Any unauthorized alteration, forgery or falsification of the content or appearance of this document is unlawful and offenders may be prosecuted to the fullest extent of the law. Unless otherwise stated the results shown in this test report refer only to the sample(s) tested and such sample(s) are retained for 30 days only.

Attention: To check the authenticity of testing / inspection report & certificate, please contact us at telephone: (86-755) 8307 1443, or email: [CN.Doccheck@sgs.com](mailto:CN.Doccheck@sgs.com)

No. 1 Workshop, M-10, Middle Section, Science & Technology Park, Nanshan District, Shenzhen, Guangdong, China 518057 t (86-755) 26012053 www.sgs.com.cn  
 中国·广东·深圳市南山区科技园中区M-10栋1号厂房 邮编: 518057 t (86-755) 26012053 sgs.china@sgs.com



#### 4.4 Conducted Output Power

Test Requirement:	47 CFR Part 15C Section 15.247 (b)(3)
Test Method:	ANSI C63.10-2020 Section 11.9.1.2
Test Setup:	 <p>* Test with power meter (Detector function: Peak)</p>
Test Instruments:	Refer to section 6 for details.
Exploratory Test Mode:	Transmitting with all kind of modulations, data rates
Final Test Mode:	Refer to section 3.7 for details.
Limit:	30dBm
Test Results:	Pass
The detailed test data see: <b>Appendix</b>	



Unless otherwise agreed in writing, this document is issued by the Company subject to its General Conditions of Service printed overleaf, available on request or accessible at <https://www.sgs.com/en/Terms-and-Conditions>. Attention is drawn to the limitation of liability, indemnification and jurisdiction issues defined therein. Any holder of this document is advised that information contained hereon reflects the Company's findings at the time of its intervention only and within the limits of Client's instructions, if any. The Company's sole responsibility is to its Client and this document does not exonerate parties to a transaction from exercising all their rights and obligations under the transaction documents. This document cannot be reproduced except in full, without prior written approval of the Company. Any unauthorized alteration, forgery or falsification of the content or appearance of this document is unlawful and offenders may be prosecuted to the fullest extent of the law. Unless otherwise stated the results shown in this test report refer only to the sample(s) tested and such sample(s) are retained for 30 days only.

Attention: To check the authenticity of testing / inspection report & certificate, please contact us at telephone: (86-755) 8307 1443, or email: [CN.Doccheck@sgs.com](mailto:CN.Doccheck@sgs.com)

No. 1 Workshop, M-10, Middle Section, Science & Technology Park, Nanshan District, Shenzhen, Guangdong, China 518057 t (86-755) 26012053 www.sgs.com.cn  
 中国·广东·深圳市南山区科技园中区M-10栋1号厂房 邮编: 518057 t (86-755) 26012053 sgs.china@sgs.com



#### 4.5 DTS (6 dB) Bandwidth & 99% Occupied Bandwidth

Test Requirement:	47 CFR Part 15C Section 15.247 (a)(2)
Test Method:	ANSI C63.10-2020 Section 11.8 Option 2 / 6.9.3
Test Setup:	
Instruments Used:	Refer to section 6 for details.
Exploratory Test Mode:	Transmitting with all kind of modulations, data rates
Final Test Mode:	Refer to section 3.7 for details.
Limit:	$\geq 500$ kHz
Test Results:	Pass
The detailed test data see: <b>Appendix</b>	



Unless otherwise agreed in writing, this document is issued by the Company subject to its General Conditions of Service printed overleaf, available on request or accessible at <https://www.sgs.com/en/Terms-and-Conditions>. Attention is drawn to the limitation of liability, indemnification and jurisdiction issues defined therein. Any holder of this document is advised that information contained hereon reflects the Company's findings at the time of its intervention only and within the limits of Client's instructions, if any. The Company's sole responsibility is to its Client and this document does not exonerate parties to a transaction from exercising all their rights and obligations under the transaction documents. This document cannot be reproduced except in full, without prior written approval of the Company. Any unauthorized alteration, forgery or falsification of the content or appearance of this document is unlawful and offenders may be prosecuted to the fullest extent of the law. Unless otherwise stated the results shown in this test report refer only to the sample(s) tested and such sample(s) are retained for 30 days only.

Attention: To check the authenticity of testing / inspection report & certificate, please contact us at telephone: (86-755) 8307 1443, or email: [CN.Doccheck@sgs.com](mailto:CN.Doccheck@sgs.com)

No. 1 Workshop, M-10, Middle Section, Science & Technology Park, Nanshan District, Shenzhen, Guangdong, China 518057 t (86-755) 26012053 www.sgsgroup.com.cn  
 中国·广东·深圳市南山区科技园中区M-10栋1号厂房 邮编: 518057 t (86-755) 26012053 sgs.china@sgs.com



## 4.6 Power Spectral Density

Test Requirement:	47 CFR Part 15C Section 15.247 (e)
Test Method:	ANSI C63.10-2020 Section 11.10.2
Test Setup:	
Test Instruments:	Refer to section 6 for details.
Exploratory Test Mode:	Transmitting with all kind of modulations, data rates
Final Test Mode:	Refer to section 3.7 for details.
Limit:	$\leq 8.00\text{dBm}/3\text{kHz}$
Test Results:	Pass
The detailed test data see: <b>Appendix</b>	



Unless otherwise agreed in writing, this document is issued by the Company subject to its General Conditions of Service printed overleaf, available on request or accessible at <https://www.sgs.com/en/Terms-and-Conditions>. Attention is drawn to the limitation of liability, indemnification and jurisdiction issues defined therein. Any holder of this document is advised that information contained hereon reflects the Company's findings at the time of its intervention only and within the limits of Client's instructions, if any. The Company's sole responsibility is to its Client and this document does not exonerate parties to a transaction from exercising all their rights and obligations under the transaction documents. This document cannot be reproduced except in full, without prior written approval of the Company. Any unauthorized alteration, forgery or falsification of the content or appearance of this document is unlawful and offenders may be prosecuted to the fullest extent of the law. Unless otherwise stated the results shown in this test report refer only to the sample(s) tested and such sample(s) are retained for 30 days only.

Attention: To check the authenticity of testing / inspection report & certificate, please contact us at telephone: (86-755) 8307 1443, or email: [CN\\_Docscheck@sgs.com](mailto:CN_Docscheck@sgs.com)

No. 1 Workshop, M-10, Middle Section, Science & Technology Park, Nanshan District, Shenzhen, Guangdong, China 518057 t (86-755) 26012053 www.sgsgroup.com.cn  
 中国·广东·深圳市南山区科技园中区M-10栋1号厂房 邮编: 518057 t (86-755) 26012053 sgs.china@sgs.com





#### 4.7 Band-edge for RF Conducted Emissions

Test Requirement:	47 CFR Part 15C Section 15.247 (d)
Test Method:	ANSI C63.10-2020 Section 11.11
Test Setup:	
Instruments Used:	Refer to section 6 for details.
Exploratory Test Mode:	Transmitting with all kind of modulations, data rates
Final Test Mode:	Refer to section 3.7 for details.
Limit:	In any 100 kHz bandwidth outside the frequency band in which the spread spectrum intentional radiator is operating, the radio frequency power that is produced by the intentional radiator shall be at least 20 dB below that in the 100 kHz bandwidth within the band that contains the highest level of the desired power, based on either an RF conducted or a radiated measurement.
Test Results:	Pass
The detailed test data see: <b>Appendix</b>	



Unless otherwise agreed in writing, this document is issued by the Company subject to its General Conditions of Service printed overleaf, available on request or accessible at <https://www.sgs.com/en/Terms-and-Conditions>. Attention is drawn to the limitation of liability, indemnification and jurisdiction issues defined therein. Any holder of this document is advised that information contained hereon reflects the Company's findings at the time of its intervention only and within the limits of Client's instructions, if any. The Company's sole responsibility is to its Client and this document does not exonerate parties to a transaction from exercising all their rights and obligations under the transaction documents. This document cannot be reproduced except in full, without prior written approval of the Company. Any unauthorized alteration, forgery or falsification of the content or appearance of this document is unlawful and offenders may be prosecuted to the fullest extent of the law. Unless otherwise stated the results shown in this test report refer only to the sample(s) tested and such sample(s) are retained for 30 days only.

Attention: To check the authenticity of testing / inspection report & certificate, please contact us at telephone: (86-755) 8307 1443, or email: [CN.Doccheck@sgs.com](mailto:CN.Doccheck@sgs.com)

No. 1 Workshop, M-10, Middle Section, Science & Technology Park, Nanshan District, Shenzhen, Guangdong, China 518057 t (86-755) 26012053 www.sgsgroup.com.cn  
 中国·广东·深圳市南山区科技园中区M-10栋1号厂房 邮编: 518057 t (86-755) 26012053 sgs.china@sgs.com



#### 4.8 RF Conducted Spurious Emissions

Test Requirement:	47 CFR Part 15C Section 15.247 (d)
Test Method:	ANSI C63.10-2020 Section 11.11
Test Setup:	
Instruments Used:	Refer to section 6 for details.
Exploratory Test Mode:	Transmitting with all kind of modulations, data rates
Final Test Mode:	Refer to section 3.7 for details.
Limit:	In any 100 kHz bandwidth outside the frequency band in which the spread spectrum intentional radiator is operating, the radio frequency power that is produced by the intentional radiator shall be at least 20 dB below that in the 100 kHz bandwidth within the band that contains the highest level of the desired power, based on either an RF conducted or a radiated measurement.
Test Results:	Pass
The detailed test data see: <b>Appendix</b>	



Unless otherwise agreed in writing, this document is issued by the Company subject to its General Conditions of Service printed overleaf, available on request or accessible at <https://www.sgs.com/en/Terms-and-Conditions>. Attention is drawn to the limitation of liability, indemnification and jurisdiction issues defined therein. Any holder of this document is advised that information contained hereon reflects the Company's findings at the time of its intervention only and within the limits of Client's instructions, if any. The Company's sole responsibility is to its Client and this document does not exonerate parties to a transaction from exercising all their rights and obligations under the transaction documents. This document cannot be reproduced except in full, without prior written approval of the Company. Any unauthorized alteration, forgery or falsification of the content or appearance of this document is unlawful and offenders may be prosecuted to the fullest extent of the law. Unless otherwise stated the results shown in this test report refer only to the sample(s) tested and such sample(s) are retained for 30 days only.

Attention: To check the authenticity of testing / inspection report & certificate, please contact us at telephone: (86-755) 8307 1443, or email: [CN\\_Doccheck@sgs.com](mailto:CN_Doccheck@sgs.com)

No. 1 Workshop, M-10, Middle Section, Science & Technology Park, Nanshan District, Shenzhen, Guangdong, China 518057 t (86-755) 26012053 www.sgsgroup.com.cn  
 中国·广东·深圳市南山区科技园中区M-10栋1号厂房 邮编: 518057 t (86-755) 26012053 sgs.china@sgs.com



# SGS-CSTC Standards Technical Services Co., Ltd. Shenzhen Branch

Report No.: ZEWM2303000343RG05  
Page: 21 of 136

## 4.9 Radiated Spurious Emissions

Test Requirement:	47 CFR Part 15C Section 15.209 and 15.205				
Test Method:	ANSI C63.10-2020 Section 11.12				
Test Site:	Measurement Distance: 3m (Semi-Anechoic Chamber)				
Test Frequency:	9kHz ~ 25GHz				
Receiver Setup:	Frequency	Detector	RBW	VBW	Remark
	0.009MHz-0.090MHz	Peak	10kHz	30kHz	Peak
	0.009MHz-0.090MHz	Average	10kHz	30kHz	Average
	0.090MHz-0.110MHz	Quasi-peak	10kHz	30kHz	Quasi-peak
	0.110MHz-0.490MHz	Peak	10kHz	30kHz	Peak
	0.110MHz-0.490MHz	Average	10kHz	30kHz	Average
	0.490MHz -30MHz	Quasi-peak	10kHz	30kHz	Quasi-peak
	30MHz-1GHz	Quasi-peak	120kHz	300kHz	Quasi-peak
Above 1GHz	Peak	1MHz	3MHz	Peak	
	Peak	1MHz	3MHz	Peak	
Limit:	Frequency	Field strength (microvolt/meter)	Limit (dBuV/m)	Remark	Measurement distance (m)
	0.009MHz-0.490MHz	2400/F(kHz)	-	-	300
	0.490MHz-1.705MHz	24000/F(kHz)	-	-	30
	1.705MHz-30MHz	30	-	-	30
	30MHz-88MHz	100	40.0	Quasi-peak	3
	88MHz-216MHz	150	43.5	Quasi-peak	3
	216MHz-960MHz	200	46.0	Quasi-peak	3
	960MHz-1GHz	500	54.0	Quasi-peak	3
	Above 1GHz	500	54.0	Average	3
Remark: 15.35(b), Unless otherwise specified, the limit on peak radio frequency emissions is 20dB above the maximum permitted average emission limit applicable to the equipment under test. This peak limit applies to the total peak emission level radiated by the device.					



Unless otherwise agreed in writing, this document is issued by the Company subject to its General Conditions of Service printed overleaf, available on request or accessible at <https://www.sgs.com/en/Terms-and-Conditions>. Attention is drawn to the limitation of liability, indemnification and jurisdiction issues defined therein. Any holder of this document is advised that information contained hereon reflects the Company's findings at the time of its intervention only and within the limits of Client's instructions, if any. The Company's sole responsibility is to its Client and this document does not exonerate parties to a transaction from exercising all their rights and obligations under the transaction documents. This document cannot be reproduced except in full, without prior written approval of the Company. Any unauthorized alteration, forgery or falsification of the content or appearance of this document is unlawful and offenders may be prosecuted to the fullest extent of the law. Unless otherwise stated the results shown in this test report refer only to the sample(s) tested and such sample(s) are retained for 30 days only.

Attention: To check the authenticity of testing / inspection report & certificate, please contact us at telephone: (86-755) 8307 1443, or email: [CN.Doccheck@sgs.com](mailto:CN.Doccheck@sgs.com)

No. 1 Workshop, M-10, Middle Section, Science & Technology Park, Nanshan District, Shenzhen, Guangdong, China 518057 t (86-755) 26012053 www.sgs.com.cn  
中国·广东·深圳市南山区科技园中区M-10栋1号厂房 邮编: 518057 t (86-755) 26012053 sgs.china@sgs.com

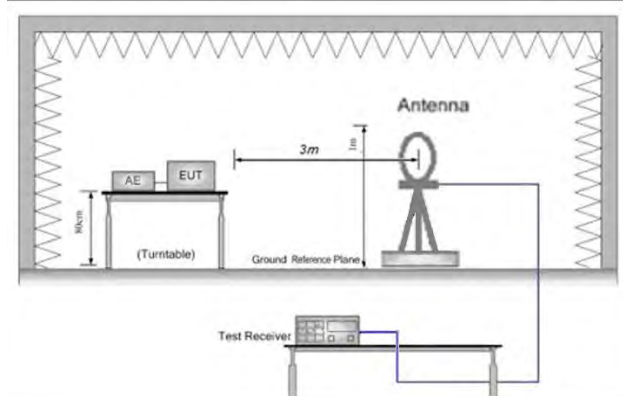
**Test Setup:**


Figure 1. Below 30MHz

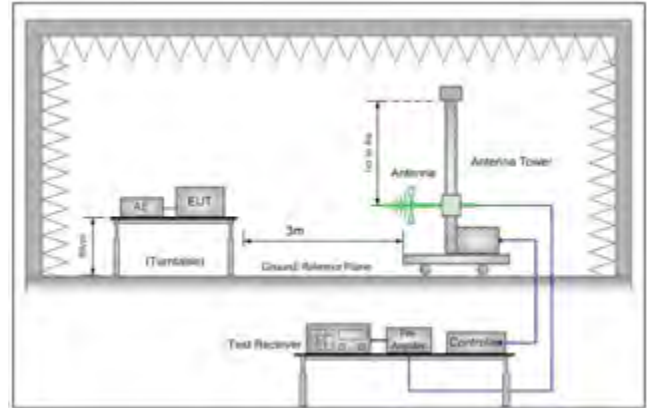


Figure 2. 30MHz to 1GHz

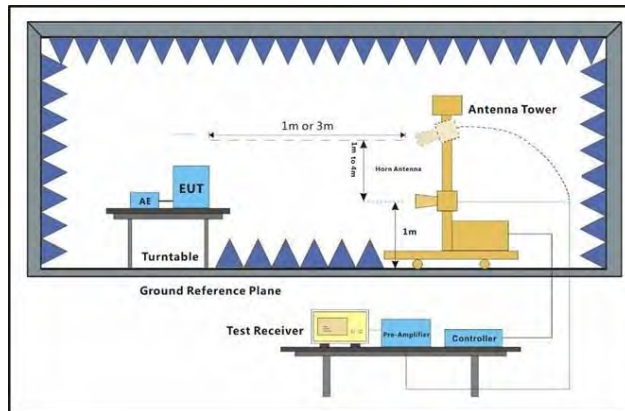


Figure 3. Above 1 GHz

**Test Procedure:**

- For below 1GHz, the EUT was placed on the top of a rotating table 0.8 meters above the ground at a 3 or 10 meter semi-anechoic chamber. The table was rotated 360 degrees to determine the position of the highest radiation.
- For above 1GHz, the EUT was placed on the top of a rotating table 1.5 meters above the ground at a 3 meter semi-anechoic chamber. The table was rotated 360 degrees to determine the position of the highest radiation (Distance from antenna to EUT is 1m for measurements >18GHz).
- The EUT was set 3 or 10 meters away from the interference-receiving antenna, which was mounted on the top of a variable-height antenna tower.
- The antenna height is varied from one meter to four meters above the ground to determine the maximum value of the field strength. Both horizontal and vertical polarizations of the antenna are set to make the measurement.
- For each suspected emission, the EUT was arranged to its worst case and then the antenna was tuned to heights from 1 meter to 4 meters (for the test frequency of below 30MHz, the antenna was tuned to heights 1 meter) and





# SGS-CSTC Standards Technical Services Co., Ltd. Shenzhen Branch

Report No.: ZEWM2303000343RG05  
Page: 23 of 136

	<p>the rotatable table was turned from 0 degrees to 360 degrees to find the maximum reading.</p> <p>f. The test-receiver system was set to Peak Detect Function and Specified Bandwidth with Maximum Hold Mode.</p> <p>g. Test the EUT in the lowest channel, the middle channel ,the Highest channel.</p> <p>h. The radiation measurements are performed in X, Y, Z axis positioning for Transmitting mode, And found the X axis positioning which it is worse case.</p> <p>i. Repeat above procedures until all frequencies measured was complete.</p> <p>j. The low frequency, which started from 9 kHz to 30MHz, was pre-scanned and the result which was 20dB lower than the limit line was not reported</p> <p>k. The disturbance above 18GHz was very low, and the harmonics were the highest point could be found when testing, so only the harmonics had been displayed.</p> <p>l. At a measurement distance of 1 meter the limit line was increased by <math>20 \cdot \text{LOG}(3/1) = 9.54 \text{ dB}</math>.</p>
Test Configuration:	<p>Measurements below 30MHz</p> <ul style="list-style-type: none"> <li>• RBW = 10 kHz</li> <li>• VBW = 30 kHz</li> <li>• Detector = Peak &amp; Average &amp; Quasi-peak</li> <li>• Trace mode = max hold</li> </ul> <p>Measurements Below 1000MHz</p> <ul style="list-style-type: none"> <li>• RBW = 120 kHz</li> <li>• VBW = 300 kHz</li> <li>• Detector = Quasi-peak</li> <li>• Trace mode = max hold</li> </ul> <p>Peak Measurements Above 1000 MHz</p> <ul style="list-style-type: none"> <li>• RBW = 1 MHz</li> <li>• VBW <math>\geq</math> 3 MHz</li> <li>• Detector = Peak</li> <li>• Sweep time = auto</li> <li>• Trace mode = max hold</li> </ul> <p>Average Measurements Above 1000MHz</p> <ul style="list-style-type: none"> <li>• RBW = 1 MHz</li> <li>• VBW = 10 Hz, when duty cycle is no less than 98 percent.</li> <li>• VBW <math>\geq</math> 1/T, when duty cycle is less than 98 percent where T is the minimum transmission duration over which the transmitter is on and is transmitting at its maximum power control level for the tested mode of operation.</li> </ul>
Exploratory Test Mode:	Transmitting with all kind of modulations, data rates. Charge + Transmitting mode.
Final Test Mode:	Refer to section 3.7 for details.
Instruments Used:	Refer to section 6 for details.
Test Results:	Pass
The detailed test data see: <b>Appendix</b>	



Unless otherwise agreed in writing, this document is issued by the Company subject to its General Conditions of Service printed overleaf, available on request or accessible at <https://www.sgs.com/en/Terms-and-Conditions>. Attention is drawn to the limitation of liability, indemnification and jurisdiction issues defined therein. Any holder of this document is advised that information contained hereon reflects the Company's findings at the time of its intervention only and within the limits of Client's instructions, if any. The Company's sole responsibility is to its Client and this document does not exonerate parties to a transaction from exercising all their rights and obligations under the transaction documents. This document cannot be reproduced except in full, without prior written approval of the Company. Any unauthorized alteration, forgery or falsification of the content or appearance of this document is unlawful and offenders may be prosecuted to the fullest extent of the law. Unless otherwise stated the results shown in this test report refer only to the sample(s) tested and such sample(s) are retained for 30 days only.

Attention: To check the authenticity of testing /inspection report & certificate, please contact us at telephone: (86-755)8307 1443, or email: [CN.Doccheck@sgs.com](mailto:CN.Doccheck@sgs.com)

No.1 Workshop, M-10, Middle Section, Science & Technology Park, Nanshan District, Shenzhen, Guangdong, China 518057 t (86-755) 26012053 www.sgsgroup.com.cn  
中国·广东·深圳市南山区科技园中区M-10栋1号厂房 邮编: 518057 t (86-755) 26012053 sgs.china@sgs.com





#### 4.10 Restricted bands around fundamental frequency

Test Requirement:	47 CFR Part 15C Section 15.209 and 15.205		
Test Method:	ANSI C63.10-2020 Section 11.12		
Test Site:	Measurement Distance: 3m (Semi-Anechoic Chamber)		
Limit:	Frequency	Limit (dBuV/m)	Remark
	30MHz-88MHz	40.0	Quasi-peak
	88MHz-216MHz	43.5	Quasi-peak
	216MHz-960MHz	46.0	Quasi-peak
	960MHz-1GHz	54.0	Quasi-peak
	Above 1GHz	54.0	Average Value
		74.0	Peak Value

#### Test Setup:

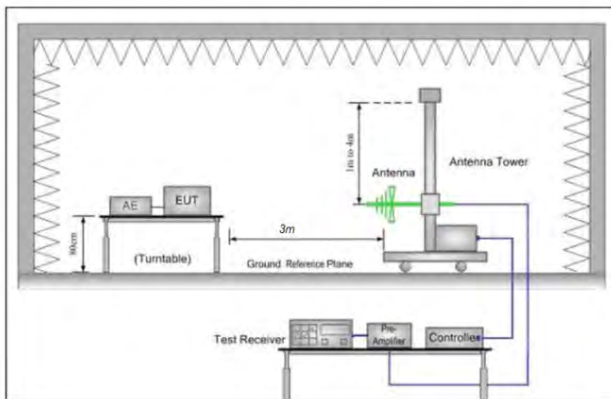


Figure 1. 30MHz to 1GHz

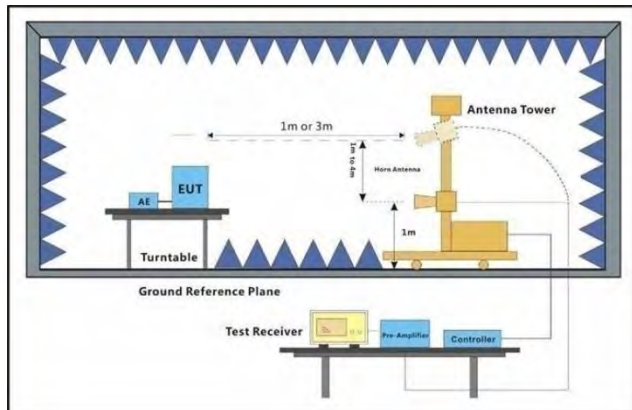


Figure 2. Above 1 GHz



Unless otherwise agreed in writing, this document is issued by the Company subject to its General Conditions of Service printed overleaf, available on request or accessible at <https://www.sgs.com/en/Terms-and-Conditions>. Attention is drawn to the limitation of liability, indemnification and jurisdiction issues defined therein. Any holder of this document is advised that information contained hereon reflects the Company's findings at the time of its intervention only and within the limits of Client's instructions, if any. The Company's sole responsibility is to its Client and this document does not exonerate parties to a transaction from exercising all their rights and obligations under the transaction documents. This document cannot be reproduced except in full, without prior written approval of the Company. Any unauthorized alteration, forgery or falsification of the content or appearance of this document is unlawful and offenders may be prosecuted to the fullest extent of the law. Unless otherwise stated the results shown in this test report refer only to the sample(s) tested and such sample(s) are retained for 30 days only.

Attention: To check the authenticity of testing / inspection report & certificate, please contact us at telephone: (86-755) 8307 1443, or email: [CM\\_Doccheck@sgs.com](mailto:CM_Doccheck@sgs.com)

No. 1 Workshop, M-10, Middle Section, Science & Technology Park, Nanshan District, Shenzhen, Guangdong, China 518057 t (86-755) 26012053 www.sgs.com.cn  
 中国·广东·深圳市南山区科技园中区M-10栋1号厂房 邮编: 518057 t (86-755) 26012053 sgs.china@sgs.com



# SGS-CSTC Standards Technical Services Co., Ltd. Shenzhen Branch

Report No.: ZEWM2303000343RG05  
Page: 25 of 136

Test Procedure:	<ol style="list-style-type: none"> <li>For below 1GHz, the EUT was placed on the top of a rotating table 0.8 meters above the ground at a 3 or 10 meter semi-anechoic chamber. The table was rotated 360 degrees to determine the position of the highest radiation.</li> <li>For above 1GHz, the EUT was placed on the top of a rotating table 1.5 meters above the ground at a 3 meter semi-anechoic chamber. The table was rotated 360 degrees to determine the position of the highest radiation.</li> <li>The EUT was set 3 or 10 meters away from the interference-receiving antenna, which was mounted on the top of a variable-height antenna tower.</li> <li>The antenna height is varied from one meter to four meters above the ground to determine the maximum value of the field strength. Both horizontal and vertical polarizations of the antenna are set to make the measurement.</li> <li>For each suspected emission, the EUT was arranged to its worst case and then the antenna was tuned to heights from 1 meter to 4 meters and the rotatable table was turned from 0 degrees to 360 degrees to find the maximum reading.</li> <li>The test-receiver system was set to Peak Detect Function and Specified Bandwidth with Maximum Hold Mode.</li> <li>Place a marker at the end of the restricted band closest to the transmit frequency to show compliance. Also measure any emissions in the restricted bands. Save the spectrum analyzer plot. Repeat for each power and modulation for lowest and highest channel</li> <li>Test the EUT in the lowest channel , the Highest channel</li> <li>The radiation measurements are performed in X, Y, Z axis positioning for Transmitting mode,And found the X axis positioning which it is worse case.</li> <li>Repeat above procedures until all frequencies measured was complete.</li> </ol>
Test Configuration:	<p>Measurements Below 1000MHz</p> <ul style="list-style-type: none"> <li>• RBW = 120 kHz</li> <li>• VBW = 300 kHz</li> <li>• Detector = Quasi-peak</li> <li>• Trace mode = max hold</li> </ul> <p>Peak Measurements Above 1000 MHz</p> <ul style="list-style-type: none"> <li>• RBW = 1 MHz</li> <li>• VBW ≥ 3 MHz</li> <li>• Detector = Peak</li> <li>• Sweep time = auto</li> <li>• Trace mode = max hold</li> </ul> <p>Average Measurements Above 1000MHz</p> <ul style="list-style-type: none"> <li>• RBW = 1 MHz</li> <li>• VBW = 10 Hz, when duty cycle is no less than 98 percent.</li> <li>• VBW ≥ 1/T, when duty cycle is less than 98 percent where T is the minimum transmission duration over which the transmitter is on and is transmitting at its maximum power control level for the tested mode of operation.</li> </ul>
Exploratory Test Mode:	<p>Transmitting with all kind of modulations, data rates. Charge + Transmitting mode.</p>
Final Test Mode:	<p>Refer to section 3.7 for details.</p>



Unless otherwise agreed in writing, this document is issued by the Company subject to its General Conditions of Service printed overleaf, available on request or accessible at <https://www.sgs.com/en/Terms-and-Conditions>. Attention is drawn to the limitation of liability, indemnification and jurisdiction issues defined therein. Any holder of this document is advised that information contained hereon reflects the Company's findings at the time of its intervention only and within the limits of Client's instructions, if any. The Company's sole responsibility is to its Client and this document does not exonerate parties to a transaction from exercising all their rights and obligations under the transaction documents. This document cannot be reproduced except in full, without prior written approval of the Company. Any unauthorized alteration, forgery or falsification of the content or appearance of this document is unlawful and offenders may be prosecuted to the fullest extent of the law. Unless otherwise stated the results shown in this test report refer only to the sample(s) tested and such sample(s) are retained for 30 days only.

Attention: To check the authenticity of testing /inspection report & certificate, please contact us at telephone: (86-755)8307 1443, or email: [CN\\_Doccheck@sgs.com](mailto:CN_Doccheck@sgs.com)

No.1 Workshop, M-10, Middle Section, Science & Technology Park, Nanshan District, Shenzhen, Guangdong, China 518057 t (86-755) 26012053 www.sgsgroup.com.cn  
中国·广东·深圳市南山区科技园中区M-10栋1号厂房 邮编: 518057 t (86-755) 26012053 sgs.china@sgs.com



# SGS-CSTC Standards Technical Services Co., Ltd. Shenzhen Branch

Report No.: ZEWM2303000343RG05  
Page: 26 of 136

Instruments Used:	Refer to section 6 for details.
Test Results:	Pass
The detailed test data see: <b>Appendix</b>	



Unless otherwise agreed in writing, this document is issued by the Company subject to its General Conditions of Service printed overleaf, available on request or accessible at <https://www.sgs.com/en/Terms-and-Conditions>. Attention is drawn to the limitation of liability, indemnification and jurisdiction issues defined therein. Any holder of this document is advised that information contained hereon reflects the Company's findings at the time of its intervention only and within the limits of Client's instructions, if any. The Company's sole responsibility is to its Client and this document does not exonerate parties to a transaction from exercising all their rights and obligations under the transaction documents. This document cannot be reproduced except in full, without prior written approval of the Company. Any unauthorized alteration, forgery or falsification of the content or appearance of this document is unlawful and offenders may be prosecuted to the fullest extent of the law. Unless otherwise stated the results shown in this test report refer only to the sample(s) tested and such sample(s) are retained for 30 days only.

Attention: To check the authenticity of testing / inspection report & certificate, please contact us at telephone: (86-755) 8307 1443, or email: [CN\\_Doccheck@sgs.com](mailto:CN_Doccheck@sgs.com)

No. 1 Workshop, M-10, Middle Section, Science & Technology Park, Nanshan District, Shenzhen, Guangdong, China 518057 t (86-755) 26012053 www.sgs.com.cn  
中国·广东·深圳市南山区科技园中区M-10栋1号厂房 邮编: 518057 t (86-755) 26012053 sgs.china@sgs.com



## 5 Measurement Uncertainty (95% confidence levels, k=2)

Lab A		
No.	Item	Measurement Uncertainty
1	Radio Frequency	$\pm 9.84\text{Hz}$
2	Duty cycle	$\pm 0.185\%$
3	Occupied Bandwidth	$\pm 0.20\%$
4	RF conducted power	$\pm 0.42\text{dB}$
5	RF power density	$\pm 1.97\text{dB}$
6	Conducted Spurious emissions	$\pm 0.42\text{dB}$

Remark:  
 The  $U_{\text{lab}}$  (lab Uncertainty) is less than  $U_{\text{CISPR/ETSI}}$  (CISPR/ETSI Uncertainty), so the test results  
 – compliance is deemed to occur if no measured disturbance level exceeds the disturbance limit;  
 – non-compliance is deemed to occur if any measured disturbance level exceeds the disturbance limit.

Lab B		
No.	Item	Measurement Uncertainty
1	Conduction Emission	$\pm 3.0\text{dB}$ (150kHz to 30MHz)
2	Radiated Emission	$\pm 4.6\text{dB}$ (9kHz to 30MHz)
		$\pm 4.9\text{dB}$ (30MHz to 1GHz)
		$\pm 4.9\text{dB}$ (1GHz to 6GHz)
		$\pm 4.7\text{dB}$ (6GHz to 18GHz)
		$\pm 5.26\text{dB}$ (Above 18GHz)

Remark:  
 The  $U_{\text{lab}}$  (lab Uncertainty) is less than  $U_{\text{CISPR/ETSI}}$  (CISPR/ETSI Uncertainty), so the test results  
 – compliance is deemed to occur if no measured disturbance level exceeds the disturbance limit;  
 – non-compliance is deemed to occur if any measured disturbance level exceeds the disturbance limit.



Unless otherwise agreed in writing, this document is issued by the Company subject to its General Conditions of Service printed overleaf, available on request or accessible at <https://www.sgs.com/en/Terms-and-Conditions>. Attention is drawn to the limitation of liability, indemnification and jurisdiction issues defined therein. Any holder of this document is advised that information contained hereon reflects the Company's findings at the time of its intervention only and within the limits of Client's instructions, if any. The Company's sole responsibility is to its Client and this document does not exonerate parties to a transaction from exercising all their rights and obligations under the transaction documents. This document cannot be reproduced except in full, without prior written approval of the Company. Any unauthorized alteration, forgery or falsification of the content or appearance of this document is unlawful and offenders may be prosecuted to the fullest extent of the law. Unless otherwise stated the results shown in this test report refer only to the sample(s) tested and such sample(s) are retained for 30 days only.

Attention: To check the authenticity of testing / inspection report & certificate, please contact us at telephone: (86-755) 8307 1443, or email: [CN.Doccheck@sgs.com](mailto:CN.Doccheck@sgs.com)

No. 1 Workshop, M-10, Middle Section, Science & Technology Park, Nanshan District, Shenzhen, Guangdong, China 518057 t (86-755) 26012053 www.sgs.com.cn

中国·广东·深圳市南山区科技园中区M-10栋1号厂房 邮编: 518057 t (86-755) 26012053 sgs.china@sgs.com





# SGS-CSTC Standards Technical Services Co., Ltd. Shenzhen Branch

Report No.: ZEWM2303000343RG05  
Page: 28 of 136

## 6 Equipment List

Lab A RF Test System					
Test Equipment	Manufacturer	Model No.	Inventory No.	Cal. date (yyyy/mm/dd)	Cal.Due date (yyyy/mm/dd)
Spectrum Analyzer	Keysight	N9020A	SZ-WRG-M-002	2022/11/18	2023/11/17
Signal Generator	Keysight	N5181A	SZ-WRG-M-005	2022/11/18	2023/11/17
DC power supply	Tonscend	TS0806-4ADC	SZ-WRG-A-007	NCR	NCR
RF Control Unit	Tonscend	JS0806-2	SZ-WRG-M-008	2022/11/18	2023/11/17
Radio Communication Tester	Rohde & Schwarz	CMW270	SZ-WRG-M-009	2023/02/16	2024/02/15
Radio Communication Tester	Rohde & Schwarz	CMW-Z800A	SZ-WRG-M-010	NCR	NCR
Signal Generator	Rohde & Schwarz	SMM100A	SZ-WRG-M-011	2023/02/22	2024/02/21
Test Software	Tonscend	JS1120 V3.2.22	N/A	NCR	NCR
Humidity/Temperature Indicator	Shanghai Meteorological Industry Factory	HTC-1	SZ-WRG-M-077	2022/07/06	2023/07/05
Spectrum Analyzer	Rohde & Schwarz	FSV	SZ-WRG-M-012	2023/02/16	2024/02/15

Lab B CE Test System					
Test Equipment	Manufacturer	Model No.	Inventory No.	Cal. date (yyyy/mm/dd)	Cal.Due date (yyyy/mm/dd)
Shielding Room	Brilliant-emc	N/A	XAW04-03-01	N/A	N/A
Test receiver	ROHDE&SCHWARZ	ESR	XAW01-08-01	2022/09/08	2023/09/07
Artificial network	ROHDE&SCHWARZ	ENV216	XAW01-04-01	2022/06/30	2023/06/29
Temperature and humidity meter	MingGao	TH101B	XAW01-01-02	2022/09/18	2023/09/17
Measurement Software	Tonscend	TS+ V4.0.0.0	XAW02-07-01	NCR	NCR
Radio communication analyzer	ROHDE&SCHWARZ	CMW 500	XAW01-03-02	2023/02/16	2024/02/15
Artificial network	ROHDE&SCHWARZ	ENV216	XAW01-04-02	2022/06/30	2023/06/29



Unless otherwise agreed in writing, this document is issued by the Company subject to its General Conditions of Service printed overleaf, available on request or accessible at <https://www.sgs.com/en/Terms-and-Conditions>. Attention is drawn to the limitation of liability, indemnification and jurisdiction issues defined therein. Any holder of this document is advised that information contained hereon reflects the Company's findings at the time of its intervention only and within the limits of Client's instructions, if any. The Company's sole responsibility is to its Client and this document does not exonerate parties to a transaction from exercising all their rights and obligations under the transaction documents. This document cannot be reproduced except in full, without prior written approval of the Company. Any unauthorized alteration, forgery or falsification of the content or appearance of this document is unlawful and offenders may be prosecuted to the fullest extent of the law. Unless otherwise stated the results shown in this test report refer only to the sample(s) tested and such sample(s) are retained for 30 days only.

Attention: To check the authenticity of testing / inspection report & certificate, please contact us at telephone: (86-755) 8307 1443, or email: [CN.Doccheck@sgs.com](mailto:CN.Doccheck@sgs.com)

No. 1 Workshop, M-10, Middle Section, Science & Technology Park, Nanshan District, Shenzhen, Guangdong, China 518057 t (86-755) 26012053 www.sgsgroup.com.cn  
中国·广东·深圳市南山区科技园中区M-10栋1号厂房 邮编: 518057 t (86-755) 26012053 sgs.china@sgs.com





# SGS-CSTC Standards Technical Services Co., Ltd. Shenzhen Branch

Report No.: ZEWM2303000343RG05  
Page: 29 of 136

Lab B RSE Test System					
Test Equipment	Manufacturer	Model No.	Inventory No.	Cal. date (yyyy/mm/dd)	Cal. Due date (yyyy/mm/dd)
Semi-Anechoic Chamber	Brilliant-emc	N/A	XAW03-35-01	2021/09/09	2024/09/08
MXA signal analyzer	Keysight	N9020A	XAW01-06-01	2023/02/16	2024/02/15
Spectrum Analyzer	ROHDE &SCHWARZ	FSV3044	XAW01-13-05	2022/05/24	2023/05/23
Test receiver	ROHDE &SCHWARZ	ESR	XAW01-08-01	2022/09/08	2023/09/07
Receiving antenna (30MHz-3GHz)	Schwarzbeck	VULB 9163	XAW01-09-01	2022/07/28	2024/07/27
Receiving antenna (1GHz~18GHz)	Schwarzbeck	BBHA 9120D	XAW01-09-02	2022/07/28	2024/07/27
Receiving antenna (15GHz~40GHz)	Schwarzbeck	BBHA 9170	XAW01-09-03	2022/07/23	2024/07/22
Directional antenna rack controller	Max-Full	MF-7802BS	XAW03-03-01	NCR	NCR
High-speed antenna rack controller	Max-Full	MF-7802	XAW03-04-01	NCR	NCR
Filter bank	Tonscend	JS0806-F	XAW03-05-01	NCR	NCR
Filter bank	Tonscend	JS0806s	XAW03-05-02	NCR	NCR
Amplifier	Tonscend	TAP9K3G32	XAW01-41-01	2022/05/24	2023/05/23
Amplifier	Tonscend	TAP01018048	XAW01-41-02	2022/09/14	2023/09/13
Amplifier	Tonscend	TAP18040048	XAW01-41-03	2022/09/14	2023/09/13
Amplifier	Shanghai Steed	YX28980930	XAW01-41-06	2022/09/14	2023/09/13
Temperature and humidity meter	MingGao	TH101B	XAW01-01-02	2022/09/18	2023/09/17
Radio communication analyzer	ROHDE&SCHWARZ	CMW 500	XAW01-03-02	2023/02/16	2024/02/15
Measurement Software	Tonscend	TS+ V4.0.0.0	XAW02-05-01	NCR	NCR
Loop Antenna	Schwarzbeck	FMZB 1519B	XAW01-48-02	2022/05/26	2023/05/25



Unless otherwise agreed in writing, this document is issued by the Company subject to its General Conditions of Service printed overleaf, available on request or accessible at <https://www.sgs.com/en/Terms-and-Conditions>. Attention is drawn to the limitation of liability, indemnification and jurisdiction issues defined therein. Any holder of this document is advised that information contained hereon reflects the Company's findings at the time of its intervention only and within the limits of Client's instructions, if any. The Company's sole responsibility is to its Client and this document does not exonerate parties to a transaction from exercising all their rights and obligations under the transaction documents. This document cannot be reproduced except in full, without prior written approval of the Company. Any unauthorized alteration, forgery or falsification of the content or appearance of this document is unlawful and offenders may be prosecuted to the fullest extent of the law. Unless otherwise stated the results shown in this test report refer only to the sample(s) tested and such sample(s) are retained for 30 days only.

Attention: To check the authenticity of testing / inspection report & certificate, please contact us at telephone: (86-755) 8307 1443, or email: [CN.Doccheck@sgs.com](mailto:CN.Doccheck@sgs.com)

No. 1 Workshop, M-10, Middle Section, Science & Technology Park, Nanshan District, Shenzhen, Guangdong, China 518057 t (86-755) 26012053 www.sgs.com.cn  
中国·广东·深圳市南山区科技园中区M-10栋1号厂房 邮编: 518057 t (86-755) 26012053 sgs.china@sgs.com

Report No.: ZEWM2303000343RG05  
 Page: 30 of 136

## 7 Photographs - Setup Photos

Refer to Appendix A.2 WLAN Setup Photos.



Unless otherwise agreed in writing, this document is issued by the Company subject to its General Conditions of Service printed overleaf, available on request or accessible at <https://www.sgs.com/en/Terms-and-Conditions>. Attention is drawn to the limitation of liability, indemnification and jurisdiction issues defined therein. Any holder of this document is advised that information contained hereon reflects the Company's findings at the time of its intervention only and within the limits of Client's instructions, if any. The Company's sole responsibility is to its Client and this document does not exonerate parties to a transaction from exercising all their rights and obligations under the transaction documents. This document cannot be reproduced except in full, without prior written approval of the Company. Any unauthorized alteration, forgery or falsification of the content or appearance of this document is unlawful and offenders may be prosecuted to the fullest extent of the law. Unless otherwise stated the results shown in this test report refer only to the sample(s) tested and such sample(s) are retained for 30 days only.

Attention: To check the authenticity of testing / inspection report & certificate, please contact us at telephone: (86-755) 8307 1443, or email: [CN.Doccheck@sgs.com](mailto:CN.Doccheck@sgs.com)

No. 1 Workshop, M-10, Middle Section, Science & Technology Park, Nanshan District, Shenzhen, Guangdong, China 518057 t (86-755) 26012053 www.sgs.com.cn  
 中国·广东·深圳市南山区科技园中区M-10栋1号厂房 邮编: 518057 t (86-755) 26012053 sgs.china@sgs.com



**SGS-CSTC Standards Technical Services Co., Ltd.**  
**Shenzhen Branch**

Report No.: ZEWM2303000343RG05  
Page: 31 of 136

# Appendix



Unless otherwise agreed in writing, this document is issued by the Company subject to its General Conditions of Service printed overleaf, available on request or accessible at <https://www.sgs.com/en/Terms-and-Conditions>. Attention is drawn to the limitation of liability, indemnification and jurisdiction issues defined therein. Any holder of this document is advised that information contained hereon reflects the Company's findings at the time of its intervention only and within the limits of Client's instructions, if any. The Company's sole responsibility is to its Client and this document does not exonerate parties to a transaction from exercising all their rights and obligations under the transaction documents. This document cannot be reproduced except in full, without prior written approval of the Company. Any unauthorized alteration, forgery or falsification of the content or appearance of this document is unlawful and offenders may be prosecuted to the fullest extent of the law. Unless otherwise stated the results shown in this test report refer only to the sample(s) tested and such sample(s) are retained for 30 days only.

Attention: To check the authenticity of testing / inspection report & certificate, please contact us at telephone: (86-755) 8307 1443, or email: [CN\\_Doccheck@sgs.com](mailto:CN_Doccheck@sgs.com)

No. 1 Workshop, M-10, Middle Section, Science & Technology Park, Nanshan District, Shenzhen, Guangdong, China 518057 t (86-755) 26012053 www.sgs.com.cn  
中国·广东·深圳市南山区科技园中区M-10栋1号厂房 邮编: 518057 t (86-755) 26012053 sgs.china@sgs.com



# SGS-CSTC Standards Technical Services Co., Ltd. Shenzhen Branch

Report No.: ZEWM2303000343RG05  
Page: 32 of 136

## DTS Bandwidth Test Result

TestMode	Antenna	Channel	DTS BW [MHz]	FL[MHz]	FH[MHz]	Limit[MHz]	Verdict
11b	Ant22	2412	9.12	2407.92	2417.04	≥0.5	PASS
		2437	9.12	2432.44	2441.56	≥0.5	PASS
		2462	8.64	2457.92	2466.56	≥0.5	PASS
11g	Ant22	2412	16.36	2403.84	2420.20	≥0.5	PASS
		2437	15.12	2429.68	2444.80	≥0.5	PASS
		2462	16.00	2453.80	2469.80	≥0.5	PASS
11n20SISO	Ant22	2412	16.00	2404.44	2420.44	≥0.5	PASS
		2437	16.08	2429.36	2445.44	≥0.5	PASS
		2462	16.04	2453.60	2469.64	≥0.5	PASS
11n40SISO	Ant22	2422	35.84	2404.40	2440.24	≥0.5	PASS
		2437	35.84	2419.40	2455.24	≥0.5	PASS
		2452	35.92	2433.76	2469.68	≥0.5	PASS



Unless otherwise agreed in writing, this document is issued by the Company subject to its General Conditions of Service printed overleaf, available on request or accessible at <https://www.sgs.com/en/Terms-and-Conditions>. Attention is drawn to the limitation of liability, indemnification and jurisdiction issues defined therein. Any holder of this document is advised that information contained hereon reflects the Company's findings at the time of its intervention only and within the limits of Client's instructions, if any. The Company's sole responsibility is to its Client and this document does not exonerate parties to a transaction from exercising all their rights and obligations under the transaction documents. This document cannot be reproduced except in full, without prior written approval of the Company. Any unauthorized alteration, forgery or falsification of the content or appearance of this document is unlawful and offenders may be prosecuted to the fullest extent of the law. Unless otherwise stated the results shown in this test report refer only to the sample(s) tested and such sample(s) are retained for 30 days only.

Attention: To check the authenticity of testing / inspection report & certificate, please contact us at telephone: (86-755) 8307 1443, or email: [CN.Doccheck@sgs.com](mailto:CN.Doccheck@sgs.com)

No. 1 Workshop, M-10, Middle Section, Science & Technology Park, Nanshan District, Shenzhen, Guangdong, China 518057 t (86-755) 26012053 www.sgs.com.cn  
中国·广东·深圳市南山区科技园中区M-10栋1号厂房 邮编: 518057 t (86-755) 26012053 sgs.china@sgs.com

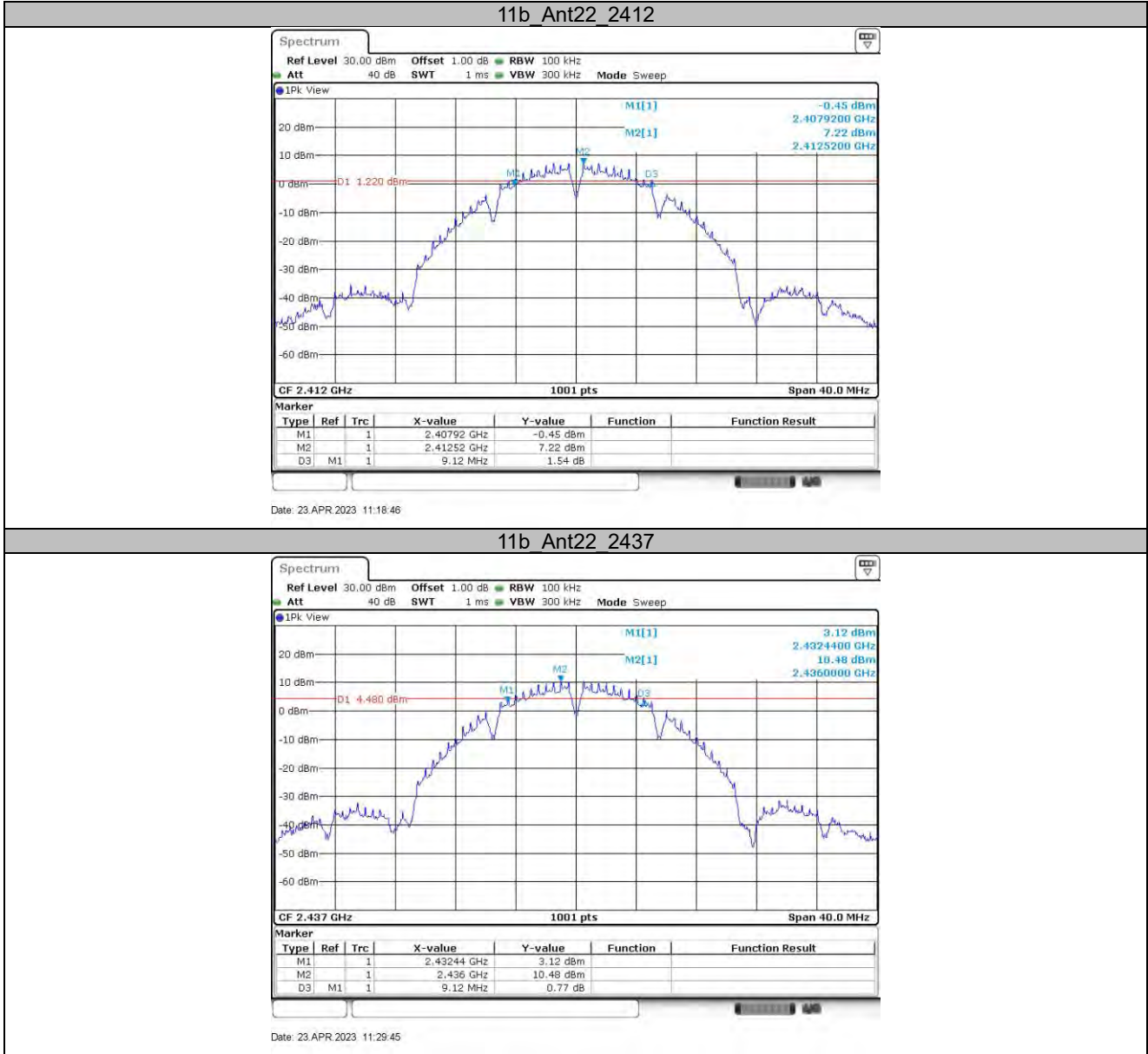




# SGS-CSTC Standards Technical Services Co., Ltd. Shenzhen Branch

Report No.: ZEWM2303000343RG05  
Page: 33 of 136

## Test Graphs



Unless otherwise agreed in writing, this document is issued by the Company subject to its General Conditions of Service printed overleaf, available on request or accessible at <https://www.sgs.com/en/Terms-and-Conditions>. Attention is drawn to the limitation of liability, indemnification and jurisdiction issues defined therein. Any holder of this document is advised that information contained hereon reflects the Company's findings at the time of its intervention only and within the limits of Client's instructions, if any. The Company's sole responsibility is to its Client and this document does not exonerate parties to a transaction from exercising all their rights and obligations under the transaction documents. This document cannot be reproduced except in full, without prior written approval of the Company. Any unauthorized alteration, forgery or falsification of the content or appearance of this document is unlawful and offenders may be prosecuted to the fullest extent of the law. Unless otherwise stated the results shown in this test report refer only to the sample(s) tested and such sample(s) are retained for 30 days only.

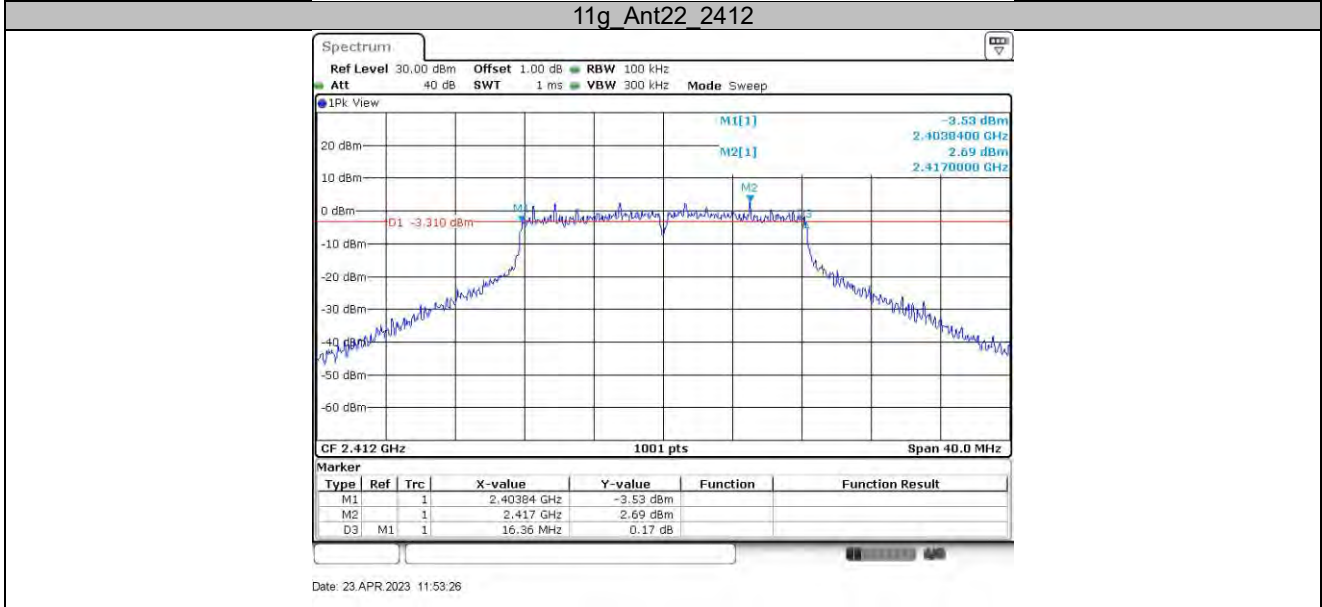
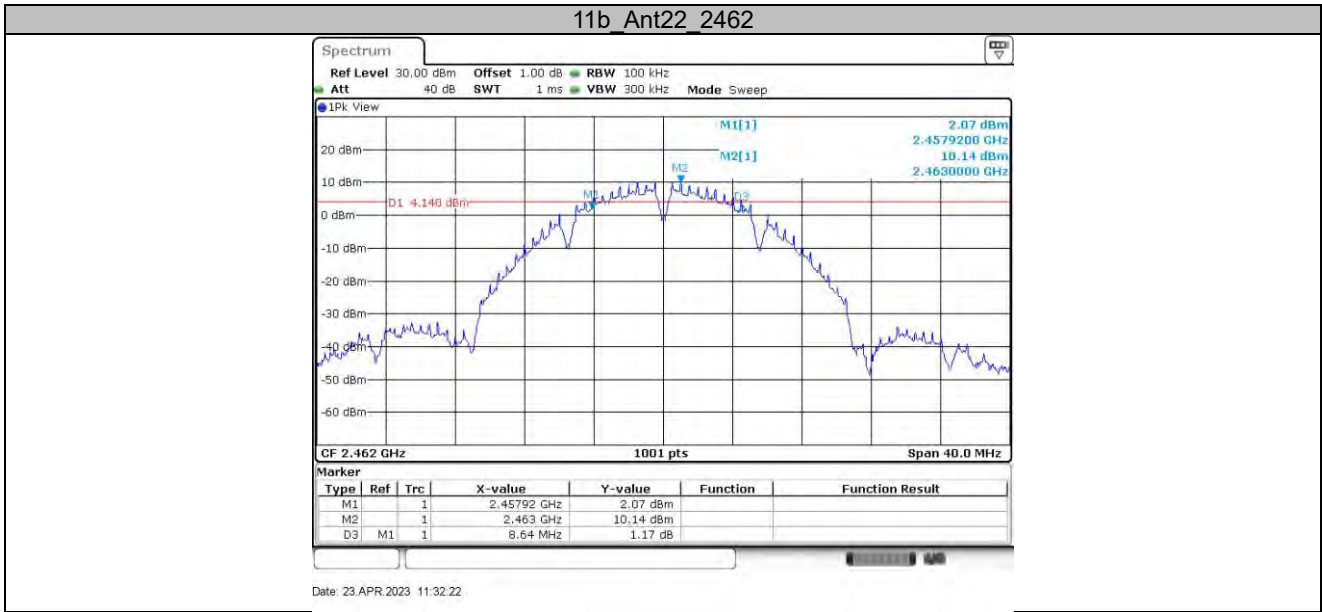
Attention: To check the authenticity of testing / inspection report & certificate, please contact us at telephone: (86-755) 8307 1443, or email: [CM.Doccheck@sgs.com](mailto:CM.Doccheck@sgs.com)

No. 1 Workshop, M-10, Middle Section, Science & Technology Park, Nanshan District, Shenzhen, Guangdong, China 518057 t (86-755) 26012053 www.sgs.com.cn  
中国·广东·深圳市南山区科技园中区M-10栋1号厂房 邮编: 518057 t (86-755) 26012053 sgs.china@sgs.com



**SGS-CSTC Standards Technical Services Co., Ltd.**  
**Shenzhen Branch**

Report No.: ZEWM2303000343RG05  
 Page: 34 of 136



Unless otherwise agreed in writing, this document is issued by the Company subject to its General Conditions of Service printed overleaf, available on request or accessible at <https://www.sgs.com/en/Terms-and-Conditions>. Attention is drawn to the limitation of liability, indemnification and jurisdiction issues defined therein. Any holder of this document is advised that information contained hereon reflects the Company's findings at the time of its intervention only and within the limits of Client's instructions, if any. The Company's sole responsibility is to its Client and this document does not exonerate parties to a transaction from exercising all their rights and obligations under the transaction documents. This document cannot be reproduced except in full, without prior written approval of the Company. Any unauthorized alteration, forgery or falsification of the content or appearance of this document is unlawful and offenders may be prosecuted to the fullest extent of the law. Unless otherwise stated the results shown in this test report refer only to the sample(s) tested and such sample(s) are retained for 30 days only.

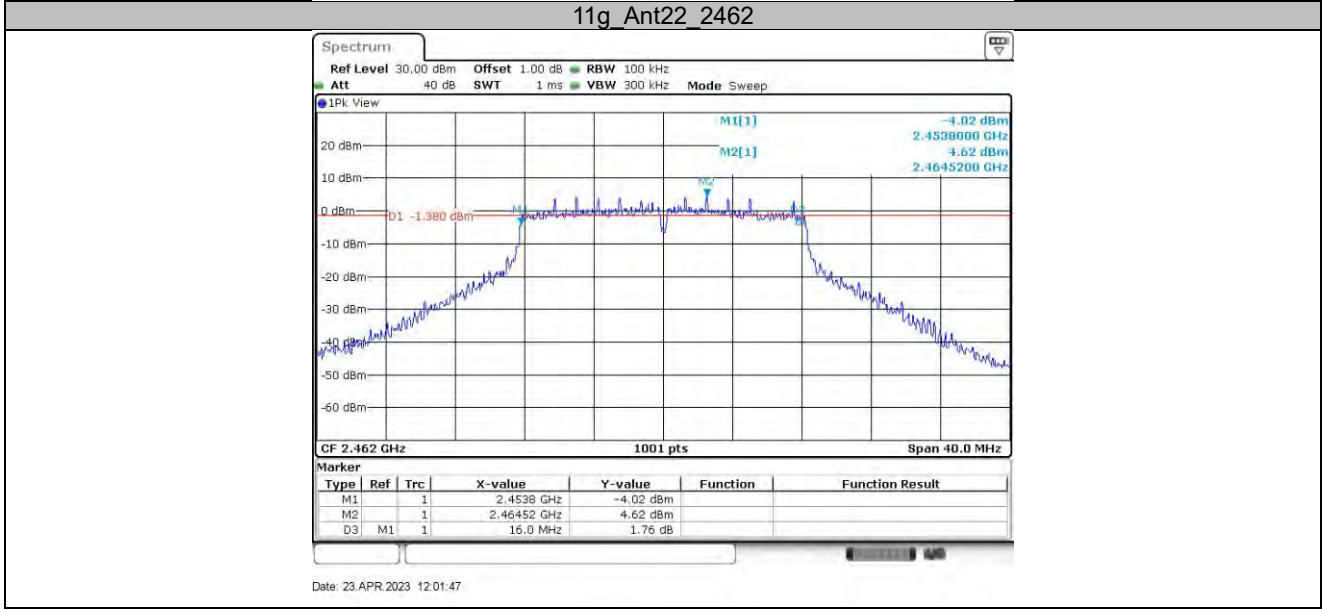
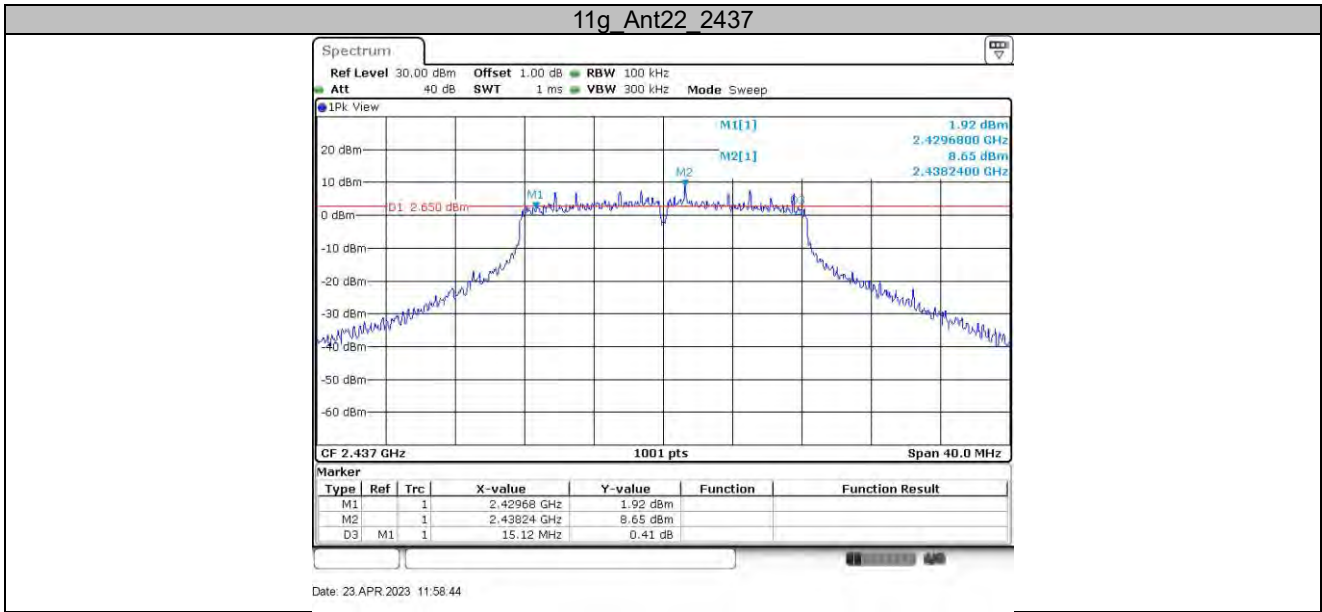
Attention: To check the authenticity of testing / inspection report & certificate, please contact us at telephone: (86-755) 8307 1443, or email: [CN.Doccheck@sgs.com](mailto:CN.Doccheck@sgs.com)

No. 1 Workshop, M-10, Middle Section, Science & Technology Park, Nanshan District, Shenzhen, Guangdong, China 518057 t (86-755) 26012053 www.sgs.com.cn  
 中国·广东·深圳市南山区科技园中区M-10栋1号厂房 邮编: 518057 t (86-755) 26012053 sgs.china@sgs.com



**SGS-CSTC Standards Technical Services Co., Ltd.**  
**Shenzhen Branch**

Report No.: ZEWM2303000343RG05  
 Page: 35 of 136



Unless otherwise agreed in writing, this document is issued by the Company subject to its General Conditions of Service printed overleaf, available on request or accessible at <https://www.sgs.com/en/Terms-and-Conditions>. Attention is drawn to the limitation of liability, indemnification and jurisdiction issues defined therein. Any holder of this document is advised that information contained hereon reflects the Company's findings at the time of its intervention only and within the limits of Client's instructions, if any. The Company's sole responsibility is to its Client and this document does not exonerate parties to a transaction from exercising all their rights and obligations under the transaction documents. This document cannot be reproduced except in full, without prior written approval of the Company. Any unauthorized alteration, forgery or falsification of the content or appearance of this document is unlawful and offenders may be prosecuted to the fullest extent of the law. Unless otherwise stated the results shown in this test report refer only to the sample(s) tested and such sample(s) are retained for 30 days only.

Attention: To check the authenticity of testing / inspection report & certificate, please contact us at telephone: (86-755) 8307 1443, or email: [CN.Doccheck@sgs.com](mailto:CN.Doccheck@sgs.com)

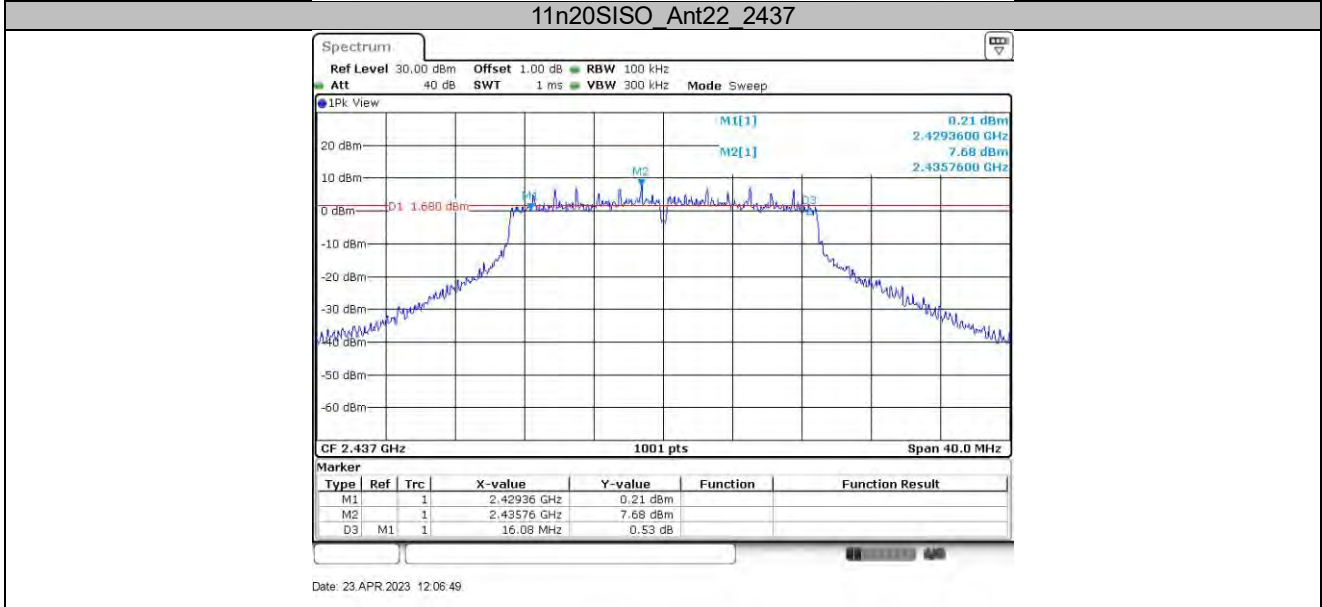
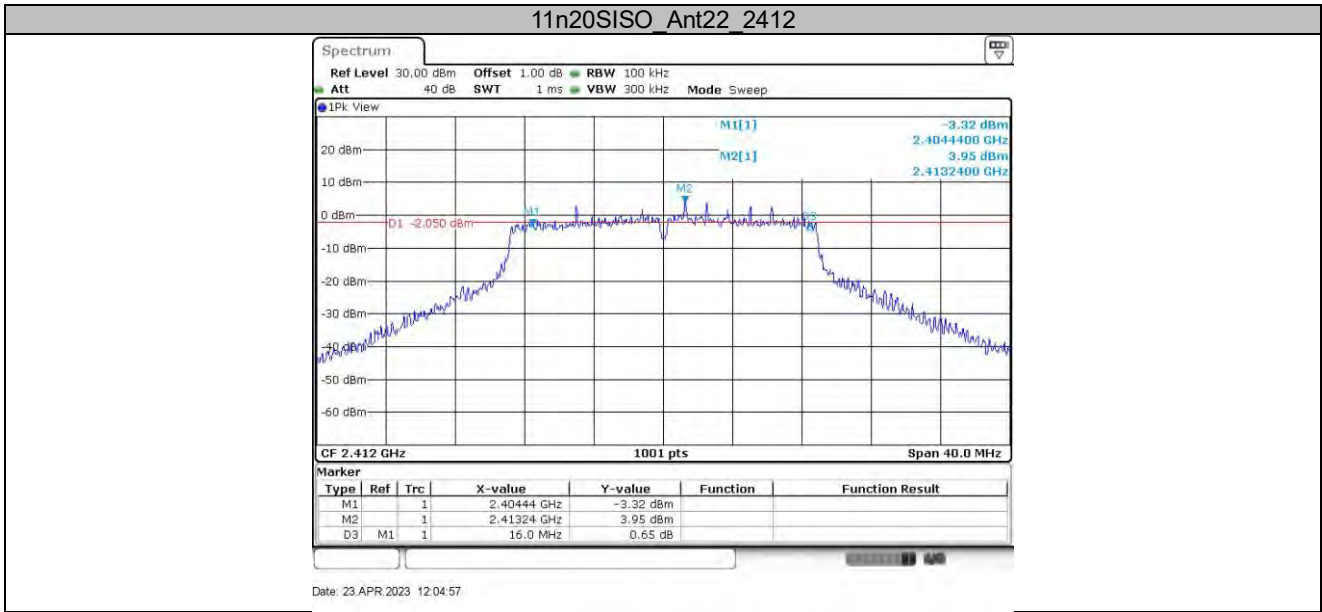
No. 1 Workshop, M-10, Middle Section, Science & Technology Park, Nanshan District, Shenzhen, Guangdong, China 518057 t (86-755) 26012053 www.sgsgroup.com.cn  
 中国·广东·深圳市南山区科技园中区M-10栋1号厂房 邮编: 518057 t (86-755) 26012053 sgs.china@sgs.com





**SGS-CSTC Standards Technical Services Co., Ltd.**  
**Shenzhen Branch**

Report No.: ZEWM2303000343RG05  
 Page: 36 of 136



Unless otherwise agreed in writing, this document is issued by the Company subject to its General Conditions of Service printed overleaf, available on request or accessible at <https://www.sgs.com/en/Terms-and-Conditions>. Attention is drawn to the limitation of liability, indemnification and jurisdiction issues defined therein. Any holder of this document is advised that information contained hereon reflects the Company's findings at the time of its intervention only and within the limits of Client's instructions, if any. The Company's sole responsibility is to its Client and this document does not exonerate parties to a transaction from exercising all their rights and obligations under the transaction documents. This document cannot be reproduced except in full, without prior written approval of the Company. Any unauthorized alteration, forgery or falsification of the content or appearance of this document is unlawful and offenders may be prosecuted to the fullest extent of the law. Unless otherwise stated the results shown in this test report refer only to the sample(s) tested and such sample(s) are retained for 30 days only.

Attention: To check the authenticity of testing / inspection report & certificate, please contact us at telephone: (86-755) 8307 1443, or email: [CN\\_Doccheck@sgs.com](mailto:CN_Doccheck@sgs.com)

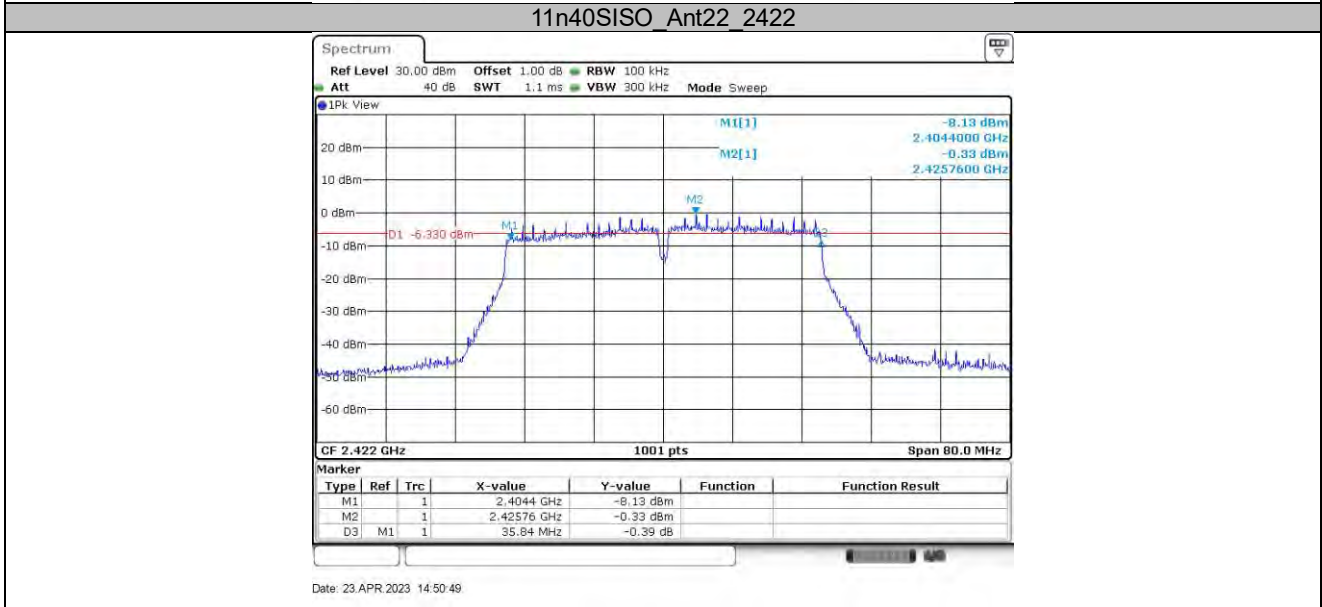
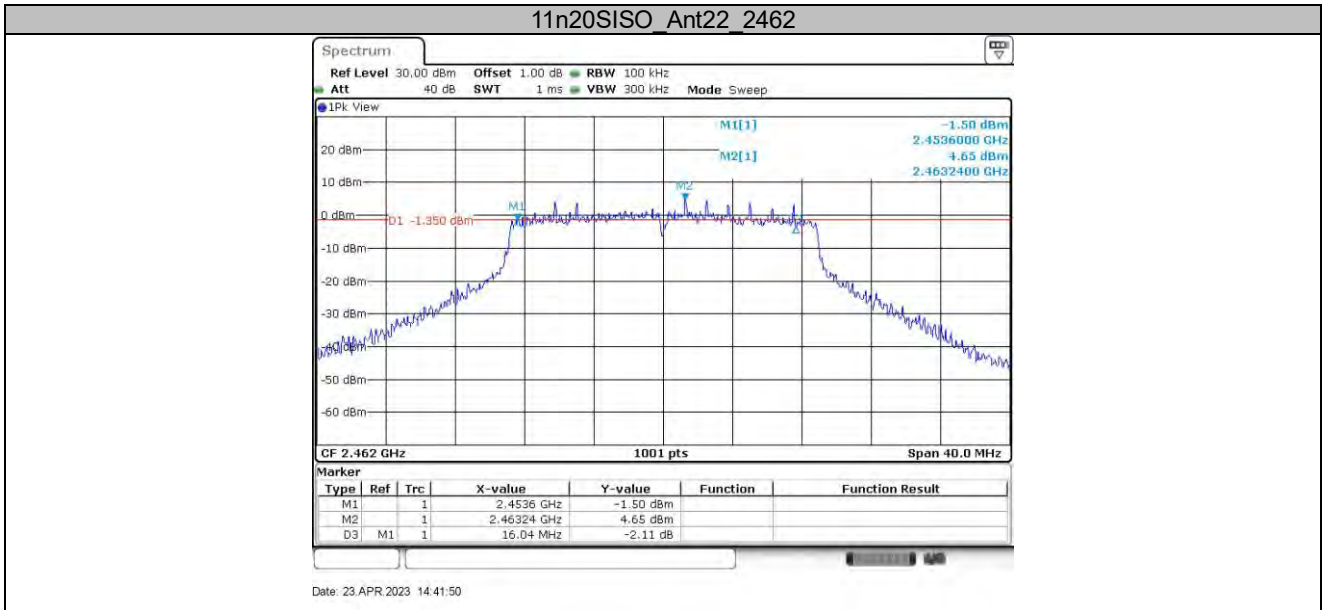
No. 1 Workshop, M-10, Middle Section, Science & Technology Park, Nanshan District, Shenzhen, Guangdong, China 518057 t (86-755) 26012053 www.sgs.com.cn  
 中国·广东·深圳市南山区科技园中区M-10栋1号厂房 邮编: 518057 t (86-755) 26012053 sgs.china@sgs.com





**SGS-CSTC Standards Technical Services Co., Ltd.**  
**Shenzhen Branch**

Report No.: ZEWM2303000343RG05  
 Page: 37 of 136



Unless otherwise agreed in writing, this document is issued by the Company subject to its General Conditions of Service printed overleaf, available on request or accessible at <https://www.sgs.com/en/Terms-and-Conditions>. Attention is drawn to the limitation of liability, indemnification and jurisdiction issues defined therein. Any holder of this document is advised that information contained hereon reflects the Company's findings at the time of its intervention only and within the limits of Client's instructions, if any. The Company's sole responsibility is to its Client and this document does not exonerate parties to a transaction from exercising all their rights and obligations under the transaction documents. This document cannot be reproduced except in full, without prior written approval of the Company. Any unauthorized alteration, forgery or falsification of the content or appearance of this document is unlawful and offenders may be prosecuted to the fullest extent of the law. Unless otherwise stated the results shown in this test report refer only to the sample(s) tested and such sample(s) are retained for 30 days only.

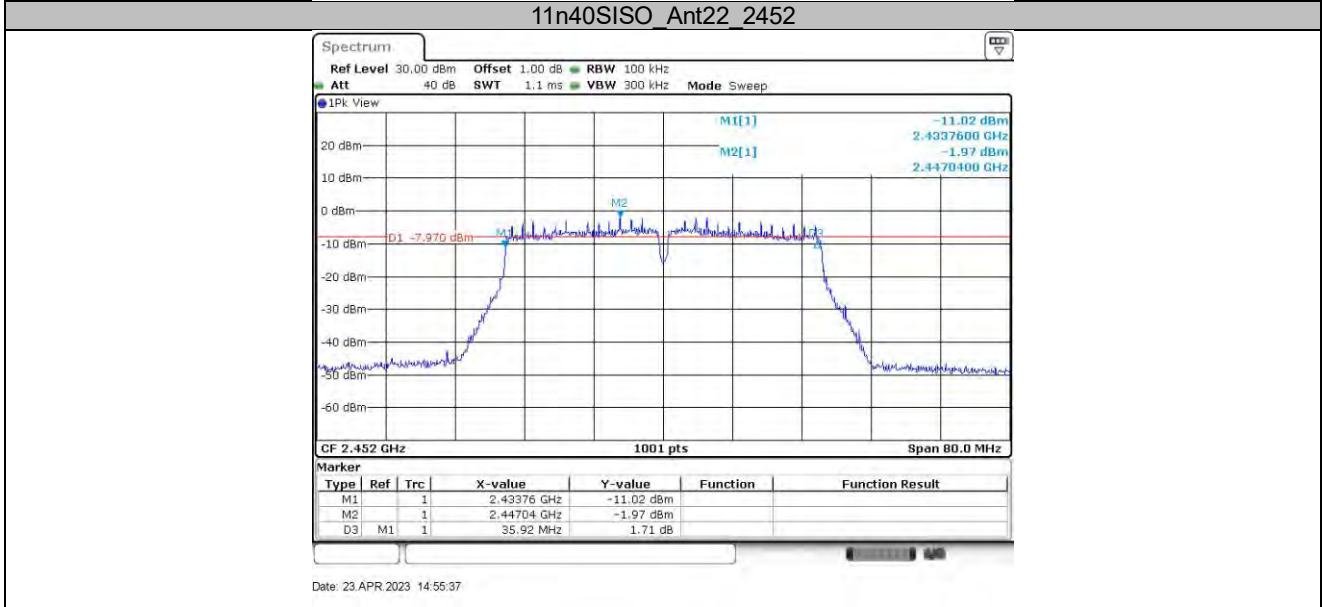
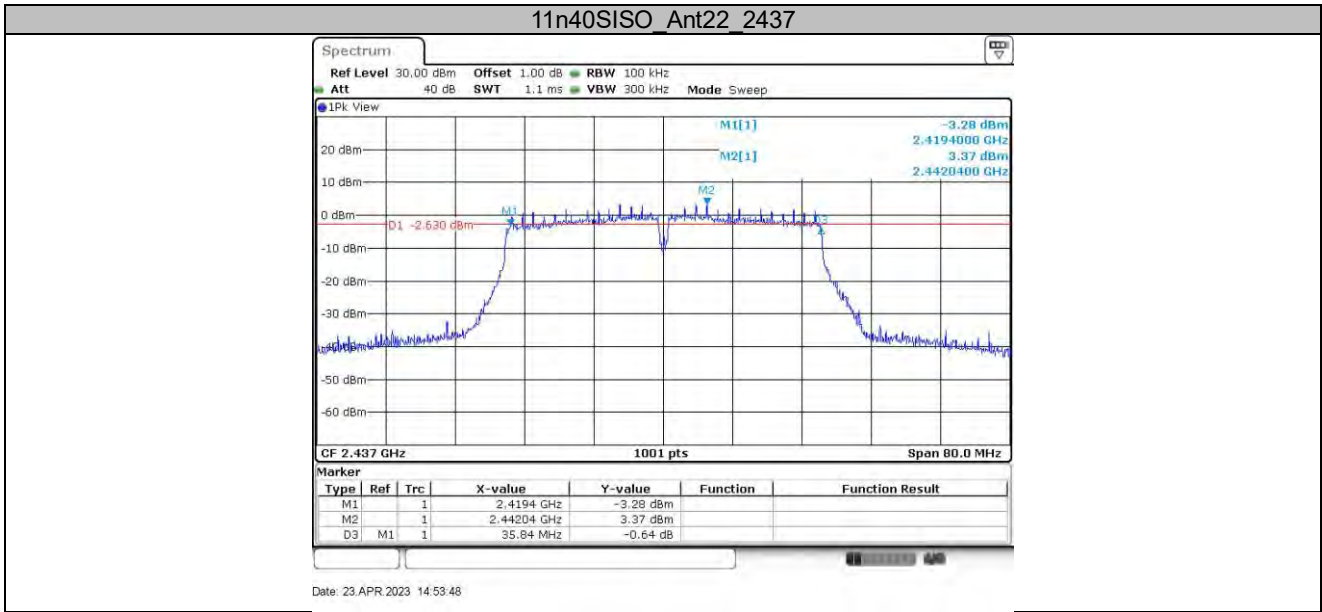
Attention: To check the authenticity of testing / inspection report & certificate, please contact us at telephone: (86-755) 8307 1443, or email: [CN.Doccheck@sgs.com](mailto:CN.Doccheck@sgs.com)

No. 1 Workshop, M-10, Middle Section, Science & Technology Park, Nanshan District, Shenzhen, Guangdong, China 518057 t (86-755) 26012053 www.sgs.com.cn  
 中国·广东·深圳市南山区科技园中区M-10栋1号厂房 邮编: 518057 t (86-755) 26012053 sgs.china@sgs.com



**SGS-CSTC Standards Technical Services Co., Ltd.**  
**Shenzhen Branch**

Report No.: ZEWM2303000343RG05  
 Page: 38 of 136



Unless otherwise agreed in writing, this document is issued by the Company subject to its General Conditions of Service printed overleaf, available on request or accessible at <https://www.sgs.com/en/Terms-and-Conditions>. Attention is drawn to the limitation of liability, indemnification and jurisdiction issues defined therein. Any holder of this document is advised that information contained hereon reflects the Company's findings at the time of its intervention only and within the limits of Client's instructions, if any. The Company's sole responsibility is to its Client and this document does not exonerate parties to a transaction from exercising all their rights and obligations under the transaction documents. This document cannot be reproduced except in full, without prior written approval of the Company. Any unauthorized alteration, forgery or falsification of the content or appearance of this document is unlawful and offenders may be prosecuted to the fullest extent of the law. Unless otherwise stated the results shown in this test report refer only to the sample(s) tested and such sample(s) are retained for 30 days only.

Attention: To check the authenticity of testing / inspection report & certificate, please contact us at telephone: (86-755) 8307 1443, or email: [CN.Doccheck@sgs.com](mailto:CN.Doccheck@sgs.com)

No. 1 Workshop, M-10, Middle Section, Science & Technology Park, Nanshan District, Shenzhen, Guangdong, China 518057 t (86-755) 26012053 www.sgs.com.cn  
 中国·广东·深圳市南山区科技园中区M-10栋1号厂房 邮编: 518057 t (86-755) 26012053 sgs.china@sgs.com


 Report No.: ZEWM2303000343RG05  
 Page: 39 of 136

## Occupied Channel Bandwidth Test Result

TestMode	Antenna	Channel Frequency[MHz]	OCB [MHz]	FL[MHz]	FH[MHz]	Verdict
11b	Ant22	2412	13.986	2405.1269	2419.1129	For Report Purpose
		2437	13.946	2430.0470	2443.9930	
		2462	13.946	2455.0070	2468.9530	
11g	Ant22	2412	17.502	2403.3686	2420.8711	
		2437	17.103	2428.4885	2445.5914	
		2462	17.143	2453.4086	2470.5514	
11n20SISO	Ant22	2412	18.462	2402.8492	2421.3107	
		2437	18.262	2427.9291	2446.1908	
		2462	18.302	2452.8092	2471.1109	
11n40SISO	Ant22	2422	36.444	2403.9381	2440.3816	
		2437	36.364	2418.9381	2455.3017	
		2452	36.444	2433.7782	2470.2218	



Unless otherwise agreed in writing, this document is issued by the Company subject to its General Conditions of Service printed overleaf, available on request or accessible at <https://www.sgs.com/en/Terms-and-Conditions>. Attention is drawn to the limitation of liability, indemnification and jurisdiction issues defined therein. Any holder of this document is advised that information contained hereon reflects the Company's findings at the time of its intervention only and within the limits of Client's instructions, if any. The Company's sole responsibility is to its Client and this document does not exonerate parties to a transaction from exercising all their rights and obligations under the transaction documents. This document cannot be reproduced except in full, without prior written approval of the Company. Any unauthorized alteration, forgery or falsification of the content or appearance of this document is unlawful and offenders may be prosecuted to the fullest extent of the law. Unless otherwise stated the results shown in this test report refer only to the sample(s) tested and such sample(s) are retained for 30 days only.

Attention: To check the authenticity of testing / inspection report & certificate, please contact us at telephone: (86-755) 8307 1443, or email: [CN.Doccheck@sgs.com](mailto:CN.Doccheck@sgs.com)

No. 1 Workshop, M-10, Middle Section, Science & Technology Park, Nanshan District, Shenzhen, Guangdong, China 518057 t (86-755) 26012053 www.sgs.com.cn  
 中国·广东·深圳市南山区科技园中区M-10栋1号厂房 邮编: 518057 t (86-755) 26012053 sgs.china@sgs.com





**SGS-CSTC Standards Technical Services Co., Ltd.**  
**Shenzhen Branch**

Report No.: ZEWM2303000343RG05  
 Page: 40 of 136

**Test Graphs**



Unless otherwise agreed in writing, this document is issued by the Company subject to its General Conditions of Service printed overleaf, available on request or accessible at <https://www.sgs.com/en/Terms-and-Conditions>. Attention is drawn to the limitation of liability, indemnification and jurisdiction issues defined therein. Any holder of this document is advised that information contained hereon reflects the Company's findings at the time of its intervention only and within the limits of Client's instructions, if any. The Company's sole responsibility is to its Client and this document does not exonerate parties to a transaction from exercising all their rights and obligations under the transaction documents. This document cannot be reproduced except in full, without prior written approval of the Company. Any unauthorized alteration, forgery or falsification of the content or appearance of this document is unlawful and offenders may be prosecuted to the fullest extent of the law. Unless otherwise stated the results shown in this test report refer only to the sample(s) tested and such sample(s) are retained for 30 days only.

Attention: To check the authenticity of testing / inspection report & certificate, please contact us at telephone: (86-755) 8307 1443, or email: [CM.Doccheck@sgs.com](mailto:CM.Doccheck@sgs.com)

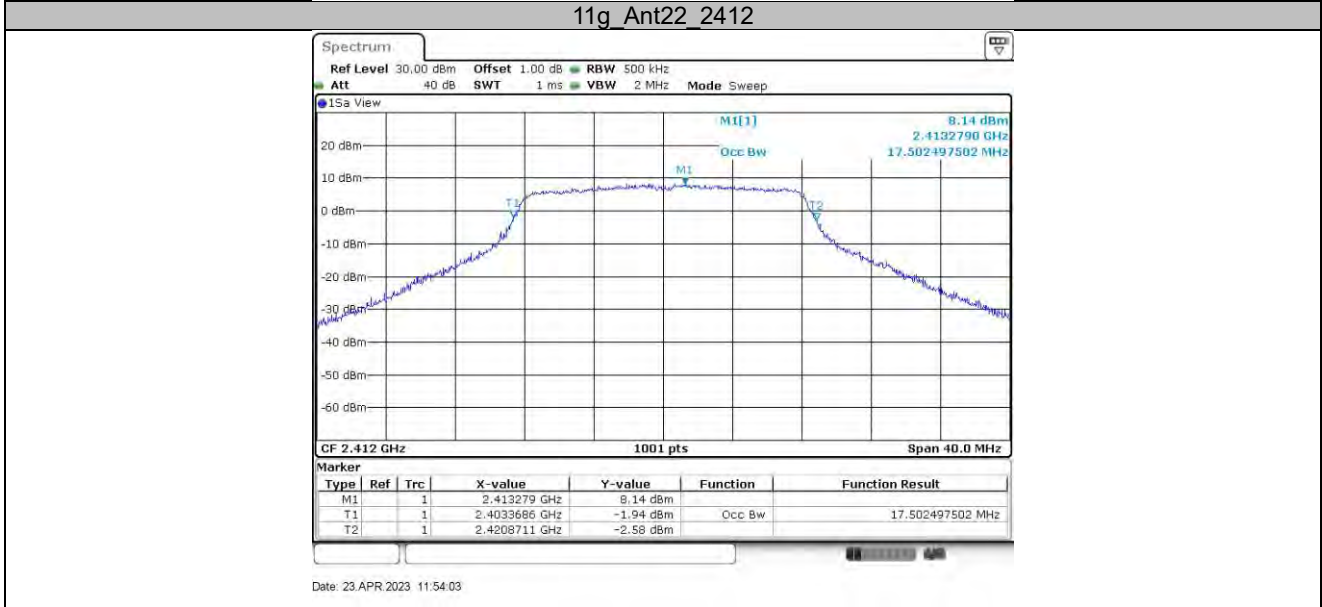
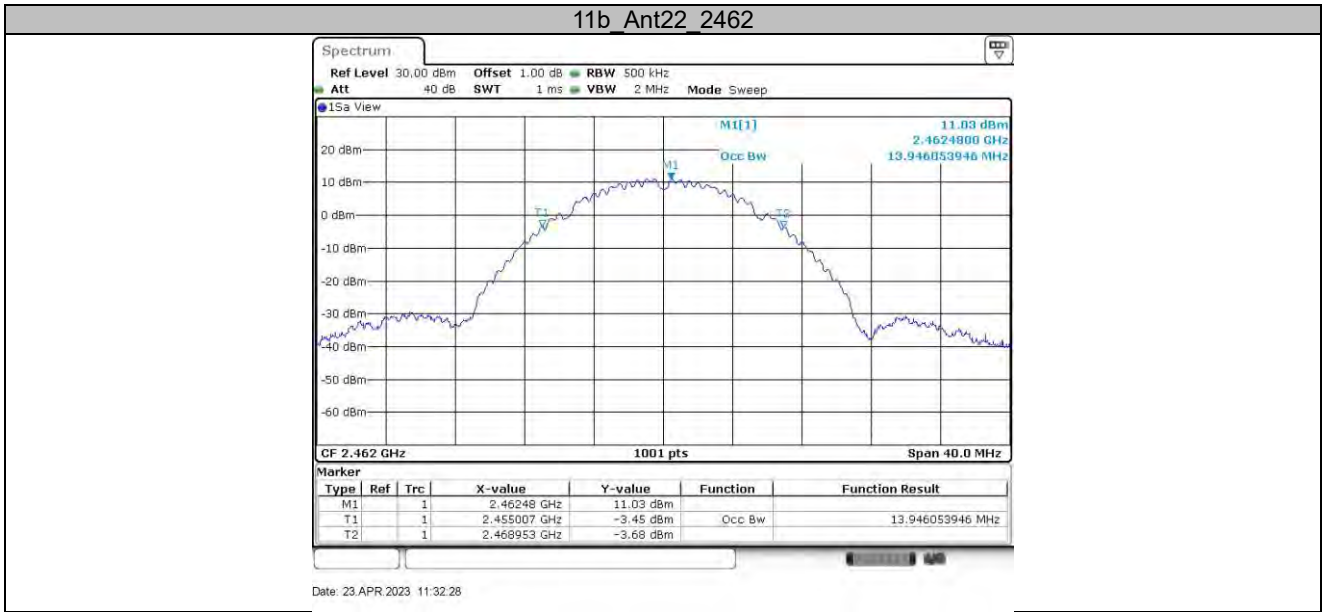
No. 1 Workshop, M-10, Middle Section, Science & Technology Park, Nanshan District, Shenzhen, Guangdong, China 518057 t (86-755) 26012053 www.sgs.com.cn  
 中国·广东·深圳市南山区科技园中区M-10栋1号厂房 邮编: 518057 t (86-755) 26012053 sgs.china@sgs.com





**SGS-CSTC Standards Technical Services Co., Ltd.**  
**Shenzhen Branch**

Report No.: ZEWM2303000343RG05  
 Page: 41 of 136



Unless otherwise agreed in writing, this document is issued by the Company subject to its General Conditions of Service printed overleaf, available on request or accessible at <https://www.sgs.com/en/Terms-and-Conditions>. Attention is drawn to the limitation of liability, indemnification and jurisdiction issues defined therein. Any holder of this document is advised that information contained hereon reflects the Company's findings at the time of its intervention only and within the limits of Client's instructions, if any. The Company's sole responsibility is to its Client and this document does not exonerate parties to a transaction from exercising all their rights and obligations under the transaction documents. This document cannot be reproduced except in full, without prior written approval of the Company. Any unauthorized alteration, forgery or falsification of the content or appearance of this document is unlawful and offenders may be prosecuted to the fullest extent of the law. Unless otherwise stated the results shown in this test report refer only to the sample(s) tested and such sample(s) are retained for 30 days only.

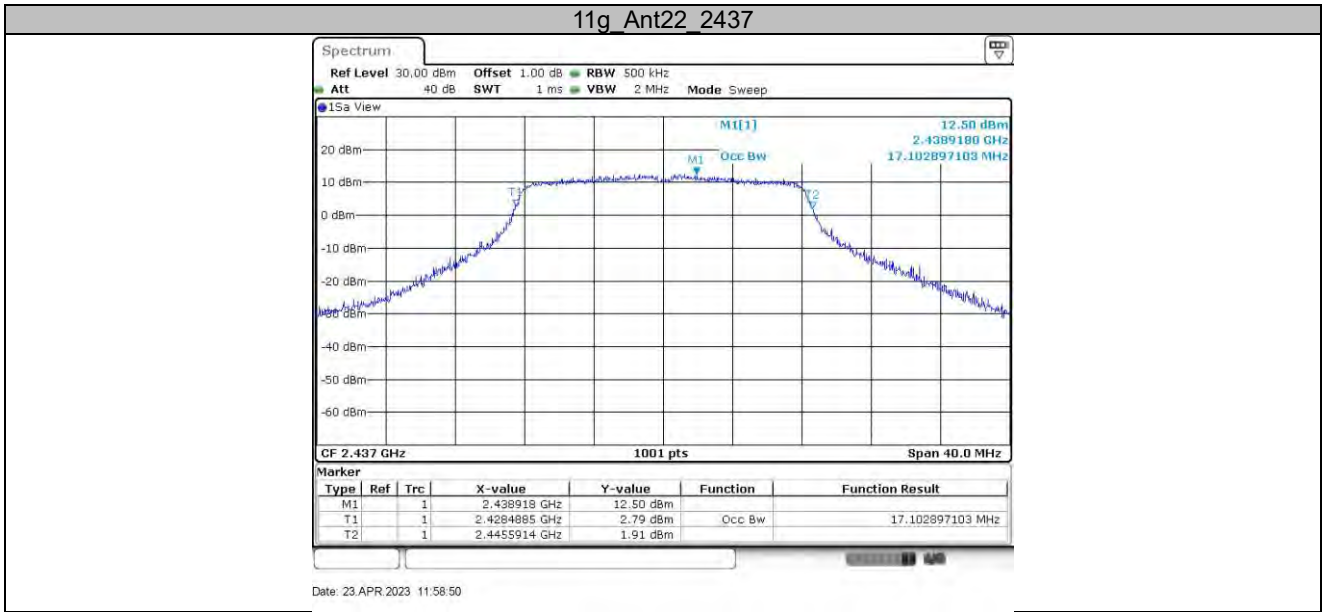
Attention: To check the authenticity of testing / inspection report & certificate, please contact us at telephone: (86-755) 8307 1443, or email: [CN.Doccheck@sgs.com](mailto:CN.Doccheck@sgs.com)

No. 1 Workshop, M-10, Middle Section, Science & Technology Park, Nanshan District, Shenzhen, Guangdong, China 518057 t (86-755) 26012053 www.sgsgroup.com.cn  
 中国·广东·深圳市南山区科技园中区M-10栋1号厂房 邮编: 518057 t (86-755) 26012053 sgs.china@sgs.com



**SGS-CSTC Standards Technical Services Co., Ltd.**  
**Shenzhen Branch**

Report No.: ZEWM2303000343RG05  
 Page: 42 of 136



Unless otherwise agreed in writing, this document is issued by the Company subject to its General Conditions of Service printed overleaf, available on request or accessible at <https://www.sgs.com/en/Terms-and-Conditions>. Attention is drawn to the limitation of liability, indemnification and jurisdiction issues defined therein. Any holder of this document is advised that information contained hereon reflects the Company's findings at the time of its intervention only and within the limits of Client's instructions, if any. The Company's sole responsibility is to its Client and this document does not exonerate parties to a transaction from exercising all their rights and obligations under the transaction documents. This document cannot be reproduced except in full, without prior written approval of the Company. Any unauthorized alteration, forgery or falsification of the content or appearance of this document is unlawful and offenders may be prosecuted to the fullest extent of the law. Unless otherwise stated the results shown in this test report refer only to the sample(s) tested and such sample(s) are retained for 30 days only.

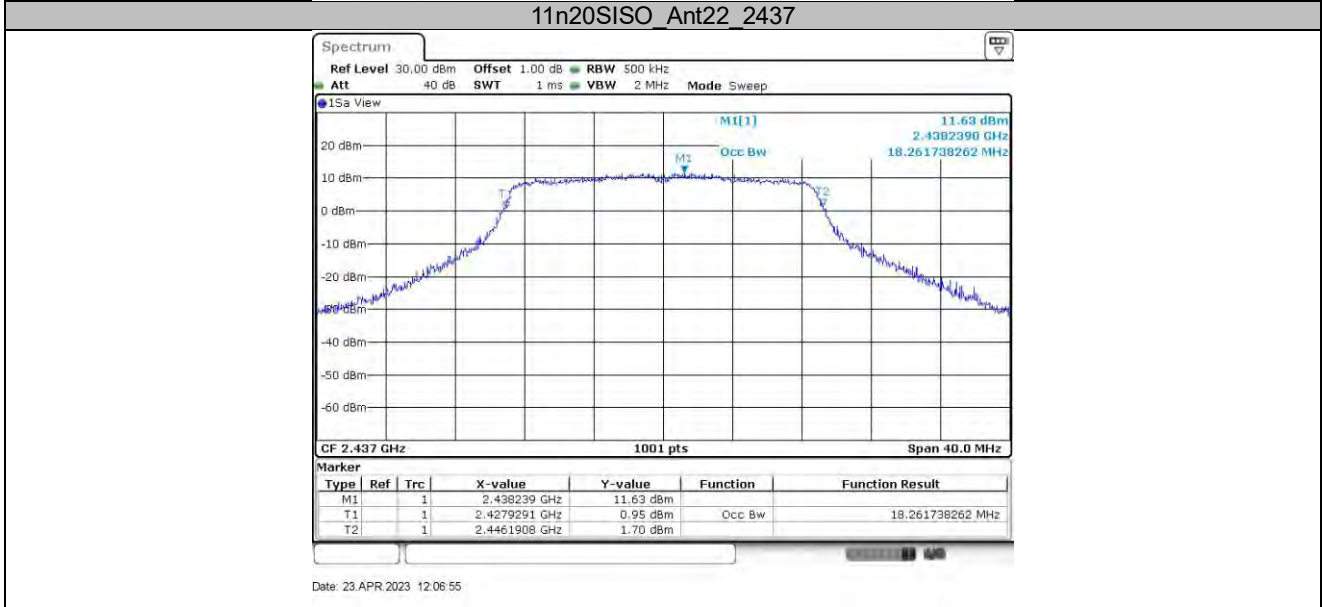
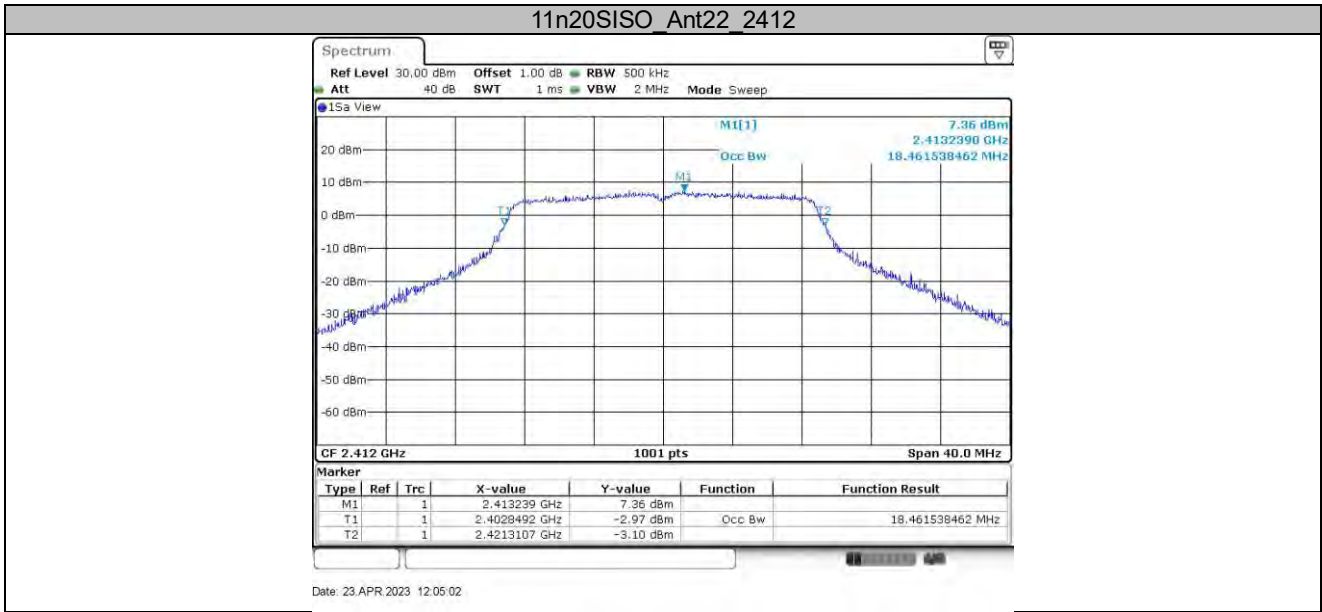
Attention: To check the authenticity of testing / inspection report & certificate, please contact us at telephone: (86-755) 8307 1443, or email: [CN.Doccheck@sgs.com](mailto:CN.Doccheck@sgs.com)

No. 1 Workshop, M-10, Middle Section, Science & Technology Park, Nanshan District, Shenzhen, Guangdong, China 518057 t (86-755) 26012053 www.sgsgroup.com.cn  
 中国·广东·深圳市南山区科技园中区M-10栋1号厂房 邮编: 518057 t (86-755) 26012053 sgs.china@sgs.com



**SGS-CSTC Standards Technical Services Co., Ltd.**  
**Shenzhen Branch**

Report No.: ZEWM2303000343RG05  
 Page: 43 of 136



Unless otherwise agreed in writing, this document is issued by the Company subject to its General Conditions of Service printed overleaf, available on request or accessible at <https://www.sgs.com/en/Terms-and-Conditions>. Attention is drawn to the limitation of liability, indemnification and jurisdiction issues defined therein. Any holder of this document is advised that information contained hereon reflects the Company's findings at the time of its intervention only and within the limits of Client's instructions, if any. The Company's sole responsibility is to its Client and this document does not exonerate parties to a transaction from exercising all their rights and obligations under the transaction documents. This document cannot be reproduced except in full, without prior written approval of the Company. Any unauthorized alteration, forgery or falsification of the content or appearance of this document is unlawful and offenders may be prosecuted to the fullest extent of the law. Unless otherwise stated the results shown in this test report refer only to the sample(s) tested and such sample(s) are retained for 30 days only.

Attention: To check the authenticity of testing / inspection report & certificate, please contact us at telephone: (86-755) 8307 1443, or email: [CN.Doccheck@sgs.com](mailto:CN.Doccheck@sgs.com)

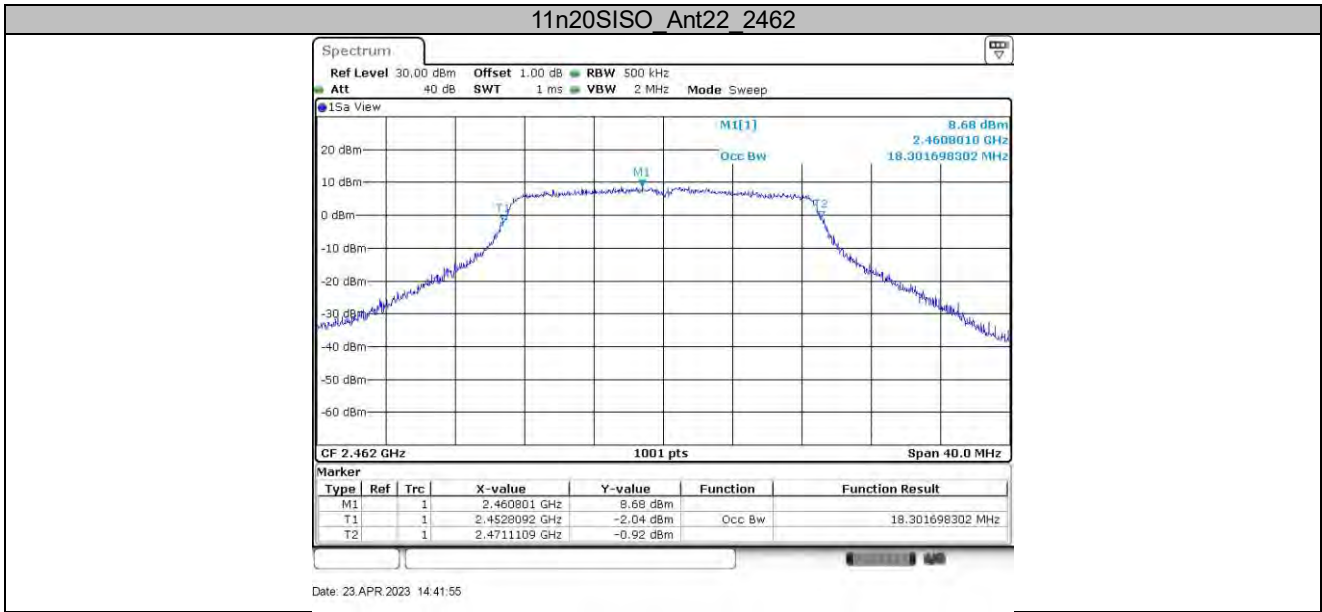
No. 1 Workshop, M-10, Middle Section, Science & Technology Park, Nanshan District, Shenzhen, Guangdong, China 518057 t (86-755) 26012053 www.sgsgroup.com.cn  
 中国·广东·深圳市南山区科技园中区M-10栋1号厂房 邮编: 518057 t (86-755) 26012053 sgs.china@sgs.com





**SGS-CSTC Standards Technical Services Co., Ltd.**  
**Shenzhen Branch**

Report No.: ZEWM2303000343RG05  
 Page: 44 of 136



Unless otherwise agreed in writing, this document is issued by the Company subject to its General Conditions of Service printed overleaf, available on request or accessible at <https://www.sgs.com/en/Terms-and-Conditions>. Attention is drawn to the limitation of liability, indemnification and jurisdiction issues defined therein. Any holder of this document is advised that information contained hereon reflects the Company's findings at the time of its intervention only and within the limits of Client's instructions, if any. The Company's sole responsibility is to its Client and this document does not exonerate parties to a transaction from exercising all their rights and obligations under the transaction documents. This document cannot be reproduced except in full, without prior written approval of the Company. Any unauthorized alteration, forgery or falsification of the content or appearance of this document is unlawful and offenders may be prosecuted to the fullest extent of the law. Unless otherwise stated the results shown in this test report refer only to the sample(s) tested and such sample(s) are retained for 30 days only.

Attention: To check the authenticity of testing / inspection report & certificate, please contact us at telephone: (86-755) 8307 1443, or email: [CN.Doccheck@sgs.com](mailto:CN.Doccheck@sgs.com)

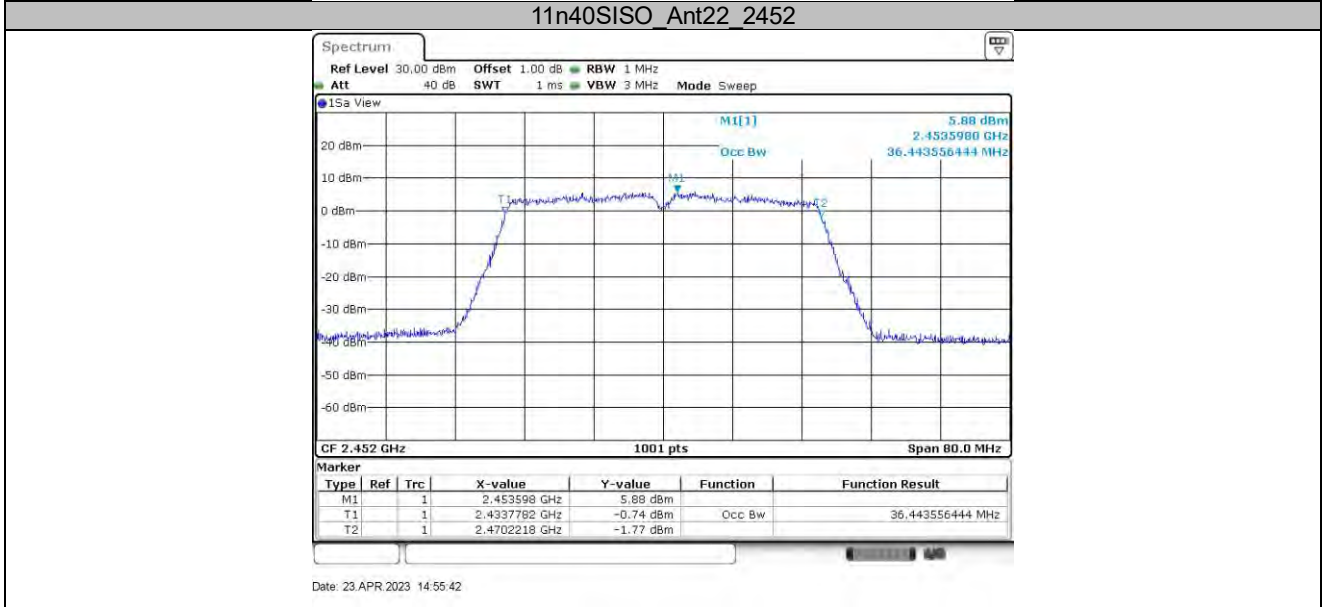
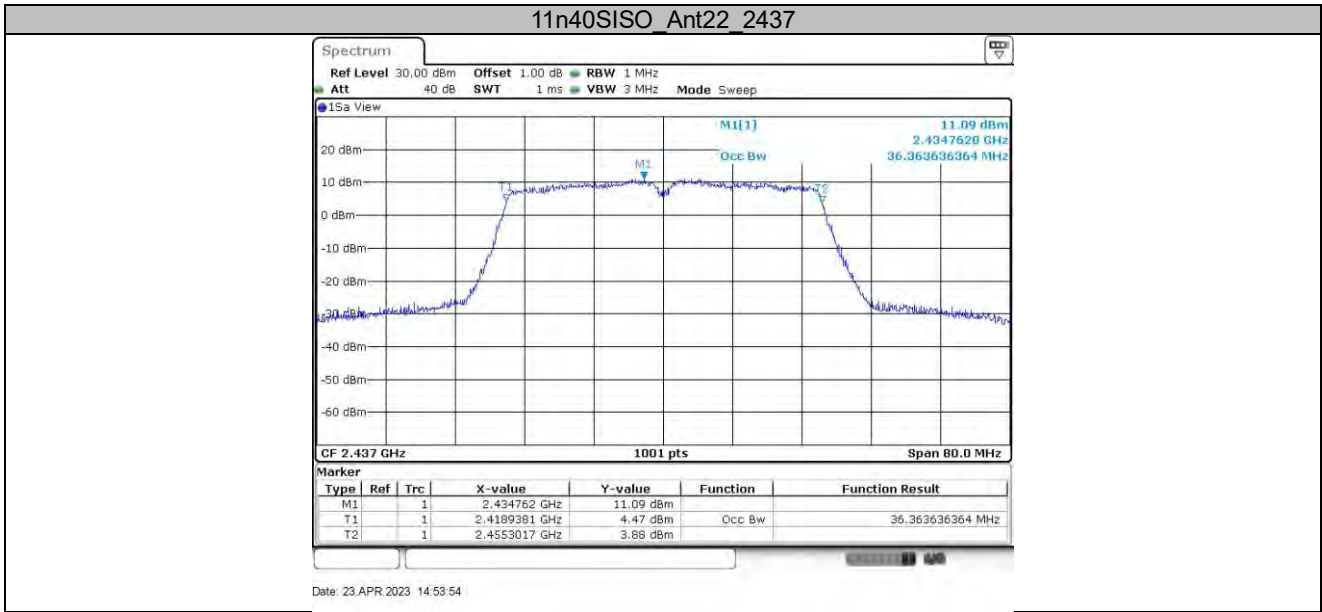
No.1 Workshop, M-10, Middle Section, Science & Technology Park, Nanshan District, Shenzhen, Guangdong, China 518057 t (86-755) 26012053 www.sgsgroup.com.cn  
 中国·广东·深圳市南山区科技园中区M-10栋1号厂房 邮编: 518057 t (86-755) 26012053 sgs.china@sgs.com





**SGS-CSTC Standards Technical Services Co., Ltd.**  
**Shenzhen Branch**

Report No.: ZEWM2303000343RG05  
 Page: 45 of 136



Unless otherwise agreed in writing, this document is issued by the Company subject to its General Conditions of Service printed overleaf, available on request or accessible at <https://www.sgs.com/en/Terms-and-Conditions>. Attention is drawn to the limitation of liability, indemnification and jurisdiction issues defined therein. Any holder of this document is advised that information contained hereon reflects the Company's findings at the time of its intervention only and within the limits of Client's instructions, if any. The Company's sole responsibility is to its Client and this document does not exonerate parties to a transaction from exercising all their rights and obligations under the transaction documents. This document cannot be reproduced except in full, without prior written approval of the Company. Any unauthorized alteration, forgery or falsification of the content or appearance of this document is unlawful and offenders may be prosecuted to the fullest extent of the law. Unless otherwise stated the results shown in this test report refer only to the sample(s) tested and such sample(s) are retained for 30 days only.

Attention: To check the authenticity of testing / inspection report & certificate, please contact us at telephone: (86-755) 8307 1443, or email: [CN.Doccheck@sgs.com](mailto:CN.Doccheck@sgs.com)

No.1 Workshop, M-10, Middle Section, Science & Technology Park, Nanshan District, Shenzhen, Guangdong, China 518057 t (86-755) 26012053 www.sgsgroup.com.cn  
 中国·广东·深圳市南山区科技园中区M-10栋1号厂房 邮编: 518057 t (86-755) 26012053 sgs.china@sgs.com


 Report No.: ZEWM2303000343RG05  
 Page: 46 of 136

**Maximum conducted output power**  
**Test Result**

TestMode	Antenna	Channel	Peak Power[dBm]	Limit[dBm]	Verdict
11b	Ant22	2412	19.06	≤30.00	PASS
		2437	21.87	≤30.00	PASS
		2462	21.55	≤30.00	PASS
11g	Ant22	2412	18.74	≤30.00	PASS
		2437	23.63	≤30.00	PASS
		2462	19.98	≤30.00	PASS
11n20	Ant22	2412	18.73	≤30.00	PASS
		2437	23.04	≤30.00	PASS
		2462	19.96	≤30.00	PASS
11n40	Ant22	2422	18.92	≤30.00	PASS
		2437	23.11	≤30.00	PASS
		2452	17.57	≤30.00	PASS



Unless otherwise agreed in writing, this document is issued by the Company subject to its General Conditions of Service printed overleaf, available on request or accessible at <https://www.sgs.com/en/Terms-and-Conditions>. Attention is drawn to the limitation of liability, indemnification and jurisdiction issues defined therein. Any holder of this document is advised that information contained hereon reflects the Company's findings at the time of its intervention only and within the limits of Client's instructions, if any. The Company's sole responsibility is to its Client and this document does not exonerate parties to a transaction from exercising all their rights and obligations under the transaction documents. This document cannot be reproduced except in full, without prior written approval of the Company. Any unauthorized alteration, forgery or falsification of the content or appearance of this document is unlawful and offenders may be prosecuted to the fullest extent of the law. Unless otherwise stated the results shown in this test report refer only to the sample(s) tested and such sample(s) are retained for 30 days only.

Attention: To check the authenticity of testing / inspection report & certificate, please contact us at telephone: (86-755) 8307 1443, or email: [CN.Doccheck@sgs.com](mailto:CN.Doccheck@sgs.com)

No. 1 Workshop, M-10, Middle Section, Science & Technology Park, Nanshan District, Shenzhen, Guangdong, China 518057 t (86-755) 26012053 www.sgs.com.cn  
 中国·广东·深圳市南山区科技园中区M-10栋1号厂房 邮编: 518057 t (86-755) 26012053 sgs.china@sgs.com


 Report No.: ZEWM2303000343RG05  
 Page: 47 of 136

## Maximum power spectral density Test Result

TestMode	Antenna	Channel	Result[dBm/3kHz]	Limit[dBm/3kHz]	Verdict
11b	Ant22	2412	-5.11	≤8.00	PASS
		2437	-2.68	≤8.00	PASS
		2462	-3.34	≤8.00	PASS
11g	Ant22	2412	-9.56	≤8.00	PASS
		2437	-4.66	≤8.00	PASS
		2462	-9.75	≤8.00	PASS
11n20SISO	Ant22	2412	-10.26	≤8.00	PASS
		2437	-6.78	≤8.00	PASS
		2462	-9.76	≤8.00	PASS
11n40SISO	Ant22	2422	-14.5	≤8.00	PASS
		2437	-11.95	≤8.00	PASS
		2452	-17.21	≤8.00	PASS



Unless otherwise agreed in writing, this document is issued by the Company subject to its General Conditions of Service printed overleaf, available on request or accessible at <https://www.sgs.com/en/Terms-and-Conditions>. Attention is drawn to the limitation of liability, indemnification and jurisdiction issues defined therein. Any holder of this document is advised that information contained hereon reflects the Company's findings at the time of its intervention only and within the limits of Client's instructions, if any. The Company's sole responsibility is to its Client and this document does not exonerate parties to a transaction from exercising all their rights and obligations under the transaction documents. This document cannot be reproduced except in full, without prior written approval of the Company. Any unauthorized alteration, forgery or falsification of the content or appearance of this document is unlawful and offenders may be prosecuted to the fullest extent of the law. Unless otherwise stated the results shown in this test report refer only to the sample(s) tested and such sample(s) are retained for 30 days only.

Attention: To check the authenticity of testing / inspection report & certificate, please contact us at telephone: (86-755) 8307 1443, or email: [CN.Doccheck@sgs.com](mailto:CN.Doccheck@sgs.com)

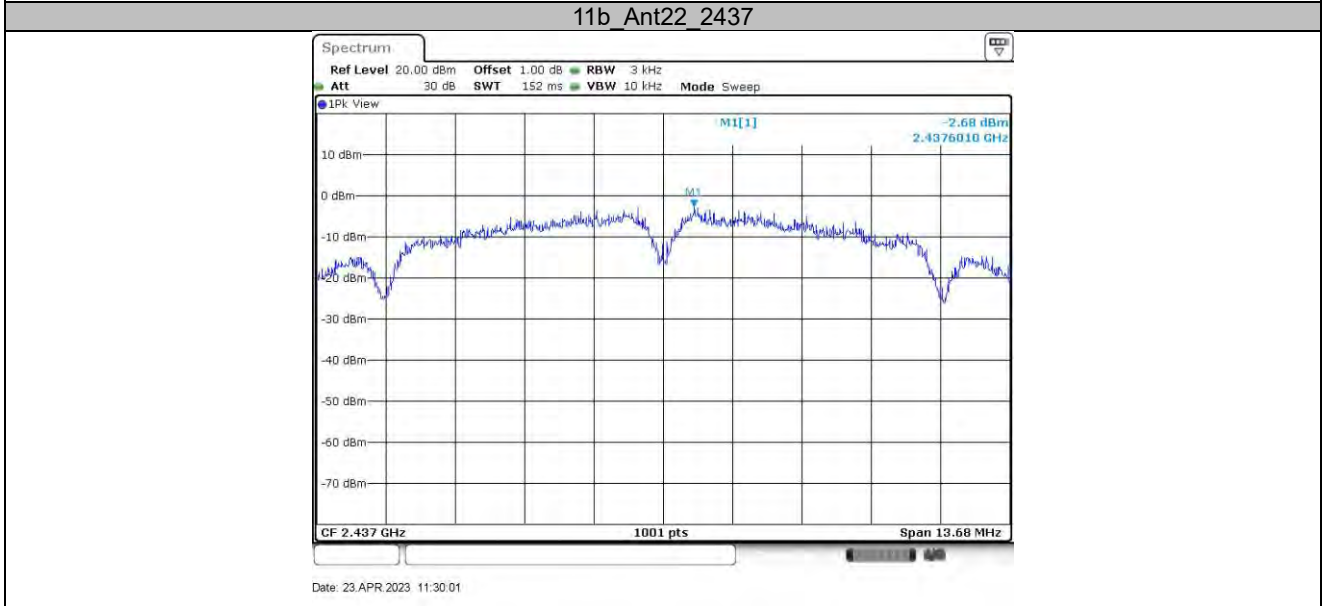
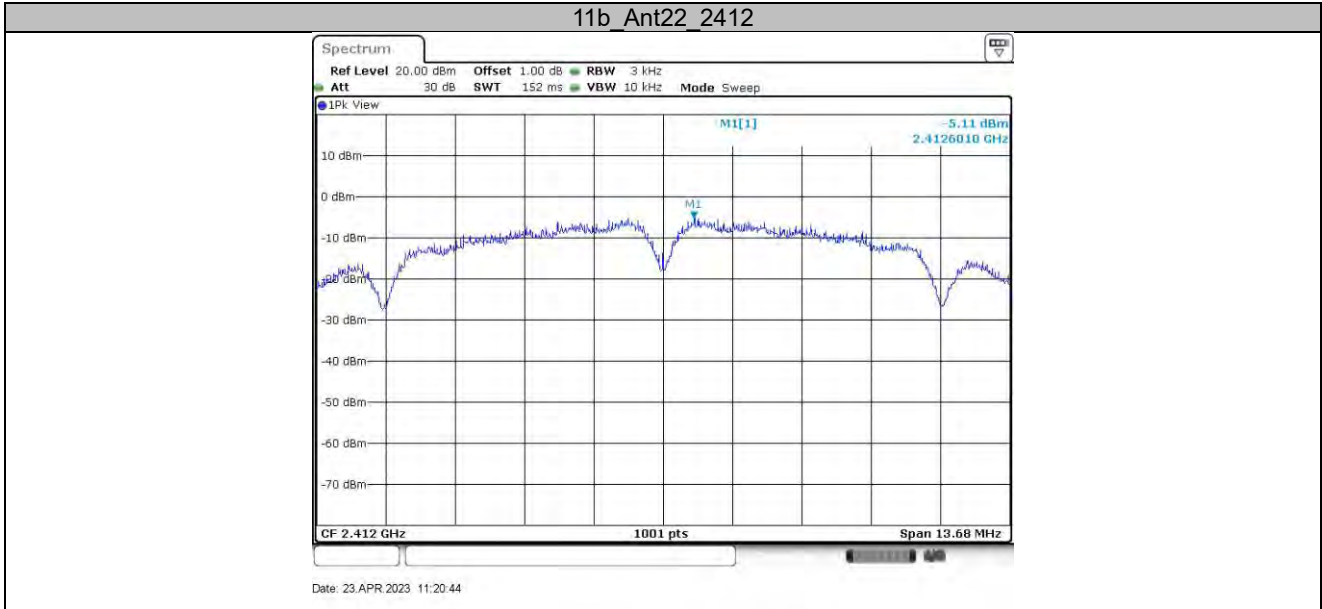
No. 1 Workshop, M-10, Middle Section, Science & Technology Park, Nanshan District, Shenzhen, Guangdong, China 518057 t (86-755) 26012053 www.sgs.com.cn  
 中国·广东·深圳市南山区科技园中区M-10栋1号厂房 邮编: 518057 t (86-755) 26012053 sgs.china@sgs.com



**SGS-CSTC Standards Technical Services Co., Ltd.**  
**Shenzhen Branch**

Report No.: ZEWM2303000343RG05  
 Page: 48 of 136

**Test Graphs**



Unless otherwise agreed in writing, this document is issued by the Company subject to its General Conditions of Service printed overleaf, available on request or accessible at <https://www.sgs.com/en/Terms-and-Conditions>. Attention is drawn to the limitation of liability, indemnification and jurisdiction issues defined therein. Any holder of this document is advised that information contained hereon reflects the Company's findings at the time of its intervention only and within the limits of Client's instructions, if any. The Company's sole responsibility is to its Client and this document does not exonerate parties to a transaction from exercising all their rights and obligations under the transaction documents. This document cannot be reproduced except in full, without prior written approval of the Company. Any unauthorized alteration, forgery or falsification of the content or appearance of this document is unlawful and offenders may be prosecuted to the fullest extent of the law. Unless otherwise stated the results shown in this test report refer only to the sample(s) tested and such sample(s) are retained for 30 days only.

Attention: To check the authenticity of testing / inspection report & certificate, please contact us at telephone: (86-755) 8307 1443, or email: [CM.Doccheck@sgs.com](mailto:CM.Doccheck@sgs.com)

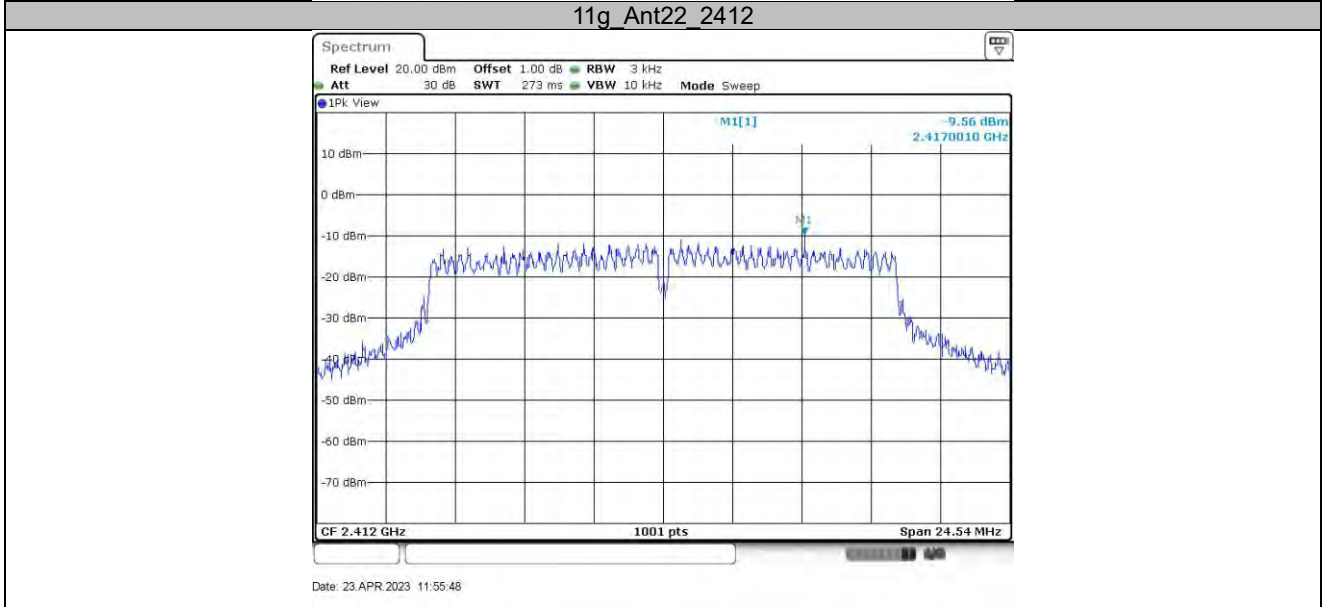
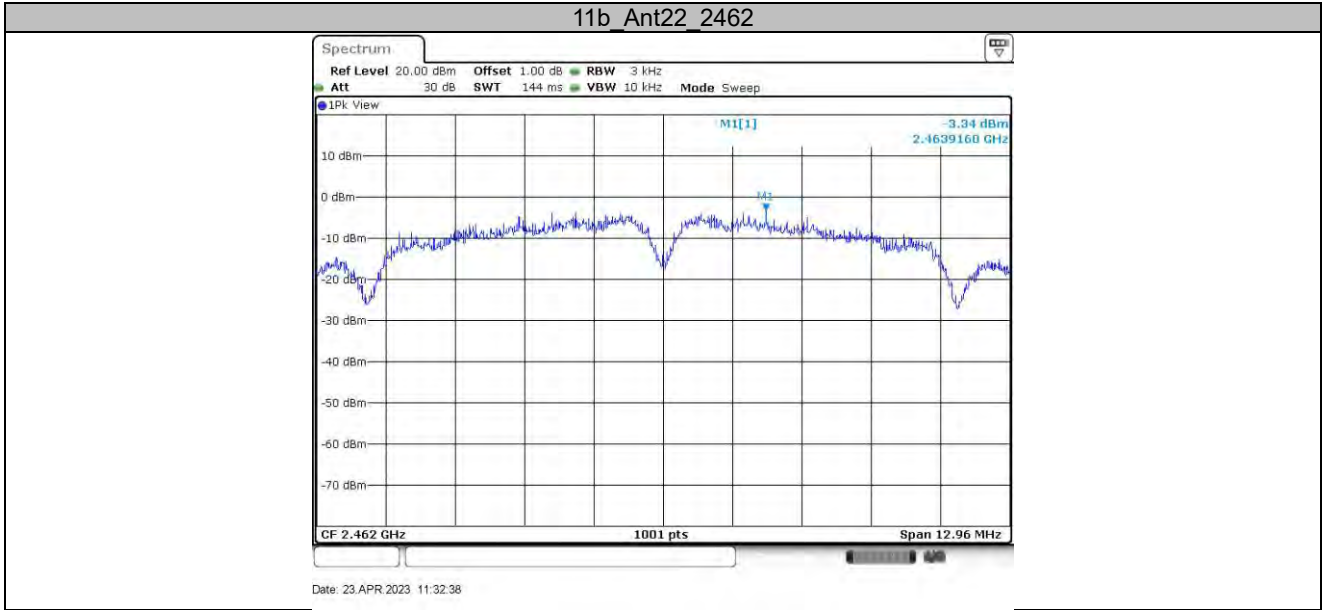
No. 1 Workshop, M-10, Middle Section, Science & Technology Park, Nanshan District, Shenzhen, Guangdong, China 518057 t (86-755) 26012053 www.sgsgroup.com.cn  
 中国·广东·深圳市南山区科技园中区M-10栋1号厂房 邮编: 518057 t (86-755) 26012053 sgs.china@sgs.com





**SGS-CSTC Standards Technical Services Co., Ltd.**  
**Shenzhen Branch**

Report No.: ZEWM2303000343RG05  
 Page: 49 of 136



Unless otherwise agreed in writing, this document is issued by the Company subject to its General Conditions of Service printed overleaf, available on request or accessible at <https://www.sgs.com/en/Terms-and-Conditions>. Attention is drawn to the limitation of liability, indemnification and jurisdiction issues defined therein. Any holder of this document is advised that information contained hereon reflects the Company's findings at the time of its intervention only and within the limits of Client's instructions, if any. The Company's sole responsibility is to its Client and this document does not exonerate parties to a transaction from exercising all their rights and obligations under the transaction documents. This document cannot be reproduced except in full, without prior written approval of the Company. Any unauthorized alteration, forgery or falsification of the content or appearance of this document is unlawful and offenders may be prosecuted to the fullest extent of the law. Unless otherwise stated the results shown in this test report refer only to the sample(s) tested and such sample(s) are retained for 30 days only.

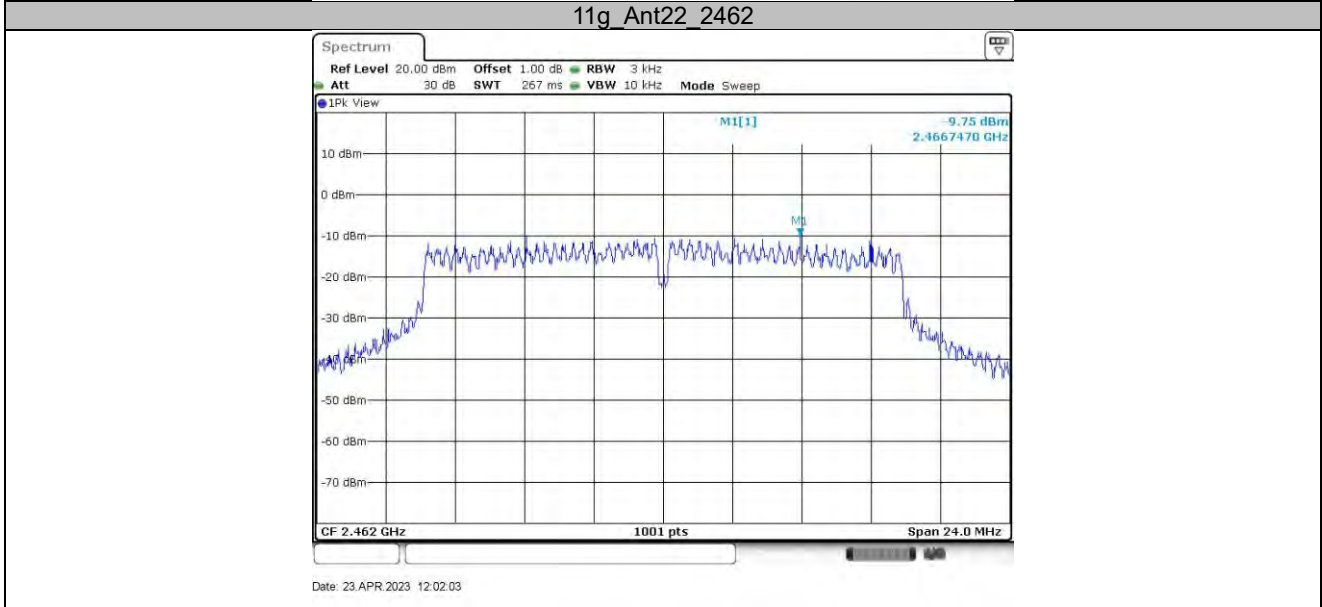
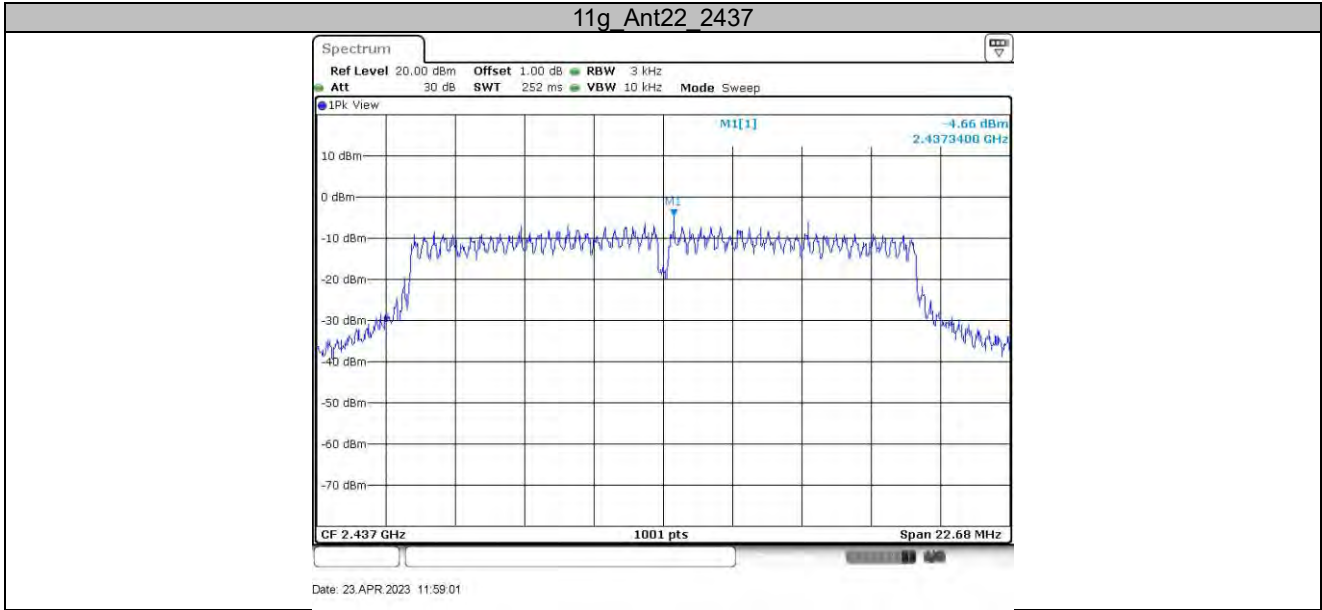
**Attention: To check the authenticity of testing / inspection report & certificate, please contact us at telephone: (86-755) 8307 1443, or email: [CN\\_Doccheck@sgs.com](mailto:CN_Doccheck@sgs.com)**

No. 1 Workshop, M-10, Middle Section, Science & Technology Park, Nanshan District, Shenzhen, Guangdong, China 518057 t (86-755) 26012053 www.sgs.com.cn  
 中国·广东·深圳市南山区科技园中区M-10栋1号厂房 邮编: 518057 t (86-755) 26012053 sgs.china@sgs.com



**SGS-CSTC Standards Technical Services Co., Ltd.**  
**Shenzhen Branch**

Report No.: ZEWM2303000343RG05  
 Page: 50 of 136



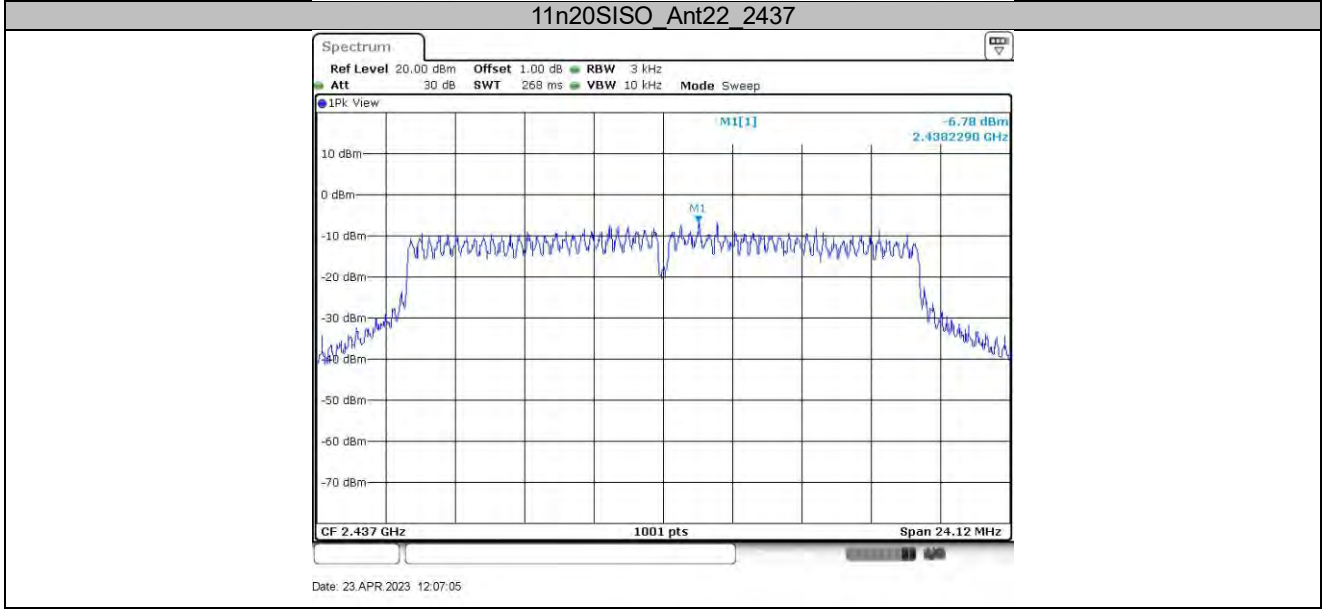
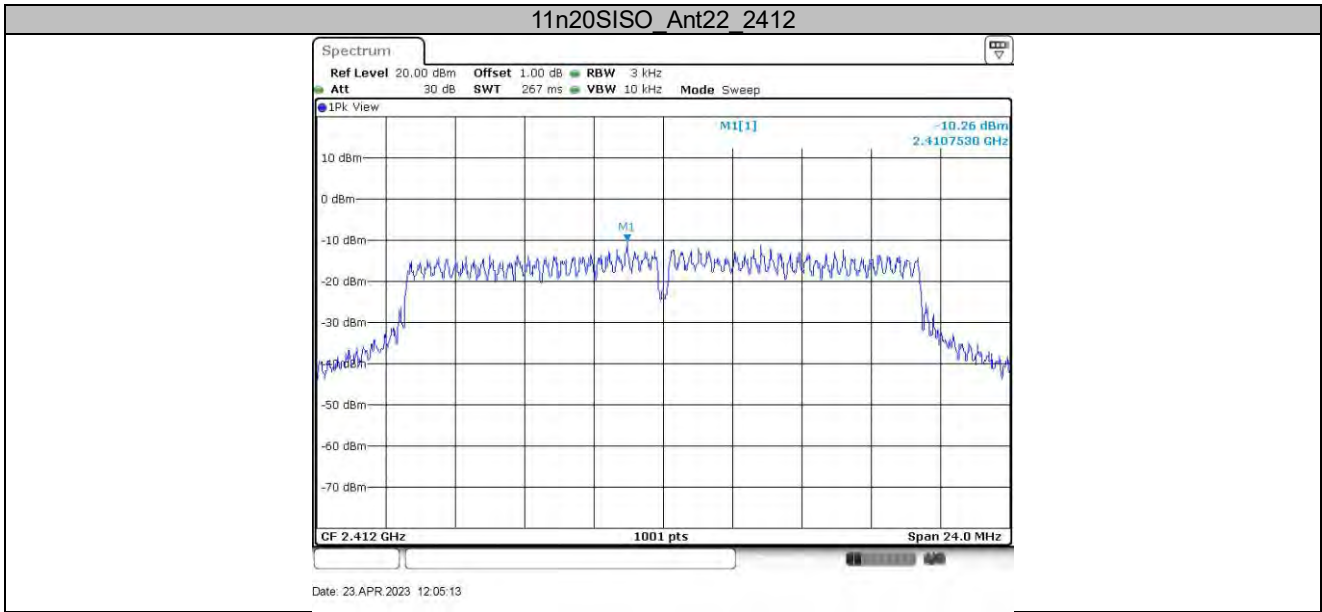
Unless otherwise agreed in writing, this document is issued by the Company subject to its General Conditions of Service printed overleaf, available on request or accessible at <https://www.sgs.com/en/Terms-and-Conditions>. Attention is drawn to the limitation of liability, indemnification and jurisdiction issues defined therein. Any holder of this document is advised that information contained hereon reflects the Company's findings at the time of its intervention only and within the limits of Client's instructions, if any. The Company's sole responsibility is to its Client and this document does not exonerate parties to a transaction from exercising all their rights and obligations under the transaction documents. This document cannot be reproduced except in full, without prior written approval of the Company. Any unauthorized alteration, forgery or falsification of the content or appearance of this document is unlawful and offenders may be prosecuted to the fullest extent of the law. Unless otherwise stated the results shown in this test report refer only to the sample(s) tested and such sample(s) are retained for 30 days only.

Attention: To check the authenticity of testing / inspection report & certificate, please contact us at telephone: (86-755) 8307 1443, or email: [CM\\_Doccheck@sgs.com](mailto:CM_Doccheck@sgs.com)  
 No. 1 Workshop, M-10, Middle Section, Science & Technology Park, Nanshan District, Shenzhen, Guangdong, China 518057 t (86-755) 26012053 www.sgsgroup.com.cn  
 中国·广东·深圳市南山区科技园中区M-10栋1号厂房 邮编: 518057 t (86-755) 26012053 sgs.china@sgs.com



**SGS-CSTC Standards Technical Services Co., Ltd.**  
**Shenzhen Branch**

Report No.: ZEWM2303000343RG05  
 Page: 51 of 136



Unless otherwise agreed in writing, this document is issued by the Company subject to its General Conditions of Service printed overleaf, available on request or accessible at <https://www.sgs.com/en/Terms-and-Conditions>. Attention is drawn to the limitation of liability, indemnification and jurisdiction issues defined therein. Any holder of this document is advised that information contained hereon reflects the Company's findings at the time of its intervention only and within the limits of Client's instructions, if any. The Company's sole responsibility is to its Client and this document does not exonerate parties to a transaction from exercising all their rights and obligations under the transaction documents. This document cannot be reproduced except in full, without prior written approval of the Company. Any unauthorized alteration, forgery or falsification of the content or appearance of this document is unlawful and offenders may be prosecuted to the fullest extent of the law. Unless otherwise stated the results shown in this test report refer only to the sample(s) tested and such sample(s) are retained for 30 days only.

Attention: To check the authenticity of testing / inspection report & certificate, please contact us at telephone: (86-755) 8307 1443, or email: [CN.Doccheck@sgs.com](mailto:CN.Doccheck@sgs.com)

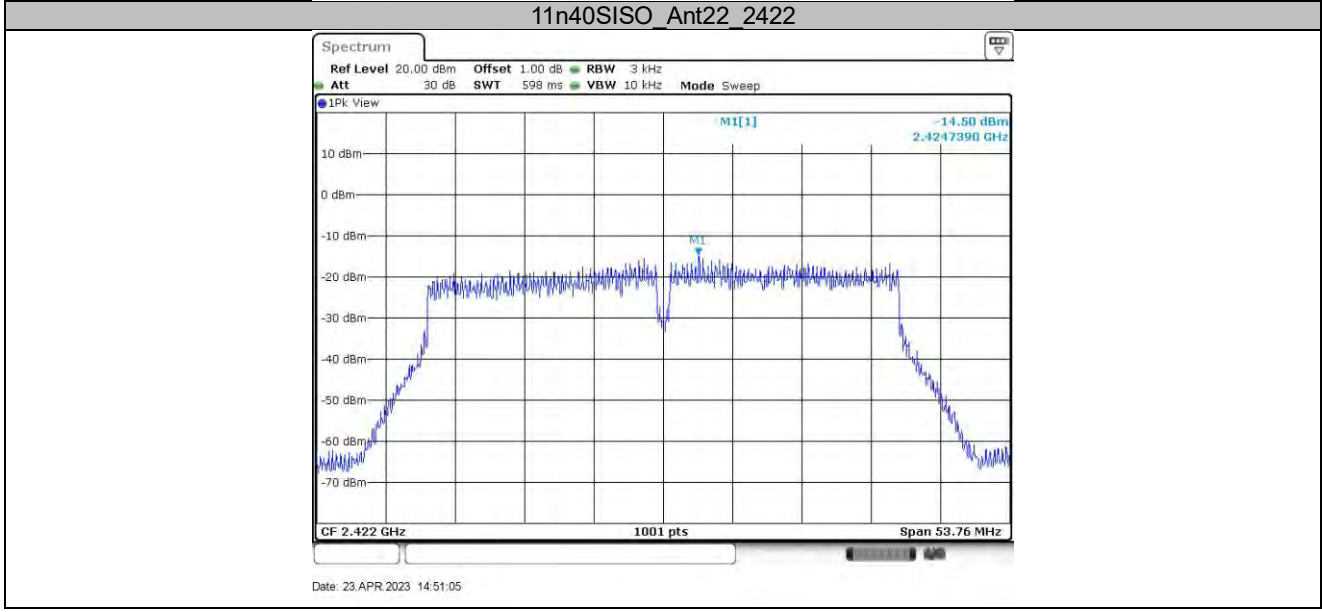
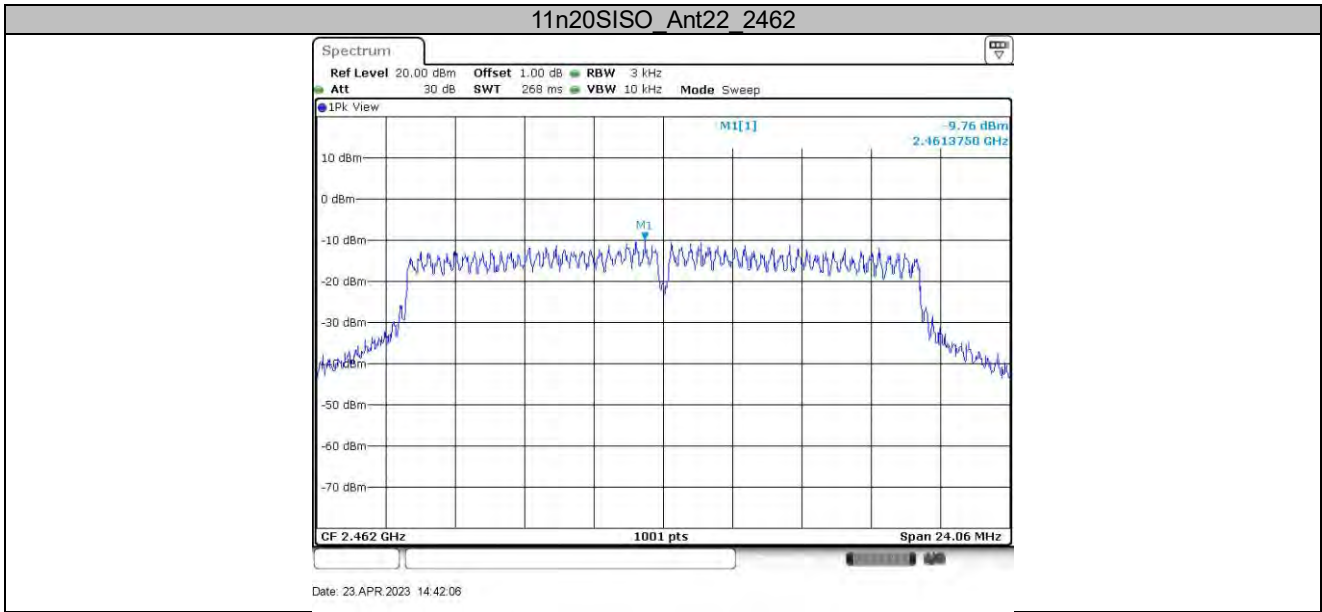
No. 1 Workshop, M-10, Middle Section, Science & Technology Park, Nanshan District, Shenzhen, Guangdong, China 518057 t (86-755) 26012053 www.sgs.com.cn  
 中国·广东·深圳市南山区科技园中区M-10栋1号厂房 邮编: 518057 t (86-755) 26012053 sgs.china@sgs.com





**SGS-CSTC Standards Technical Services Co., Ltd.**  
**Shenzhen Branch**

Report No.: ZEWM2303000343RG05  
 Page: 52 of 136



Unless otherwise agreed in writing, this document is issued by the Company subject to its General Conditions of Service printed overleaf, available on request or accessible at <https://www.sgs.com/en/Terms-and-Conditions>. Attention is drawn to the limitation of liability, indemnification and jurisdiction issues defined therein. Any holder of this document is advised that information contained hereon reflects the Company's findings at the time of its intervention only and within the limits of Client's instructions, if any. The Company's sole responsibility is to its Client and this document does not exonerate parties to a transaction from exercising all their rights and obligations under the transaction documents. This document cannot be reproduced except in full, without prior written approval of the Company. Any unauthorized alteration, forgery or falsification of the content or appearance of this document is unlawful and offenders may be prosecuted to the fullest extent of the law. Unless otherwise stated the results shown in this test report refer only to the sample(s) tested and such sample(s) are retained for 30 days only.

Attention: To check the authenticity of testing / inspection report & certificate, please contact us at telephone: (86-755) 8307 1443, or email: [CM\\_Doccheck@sgs.com](mailto:CM_Doccheck@sgs.com)

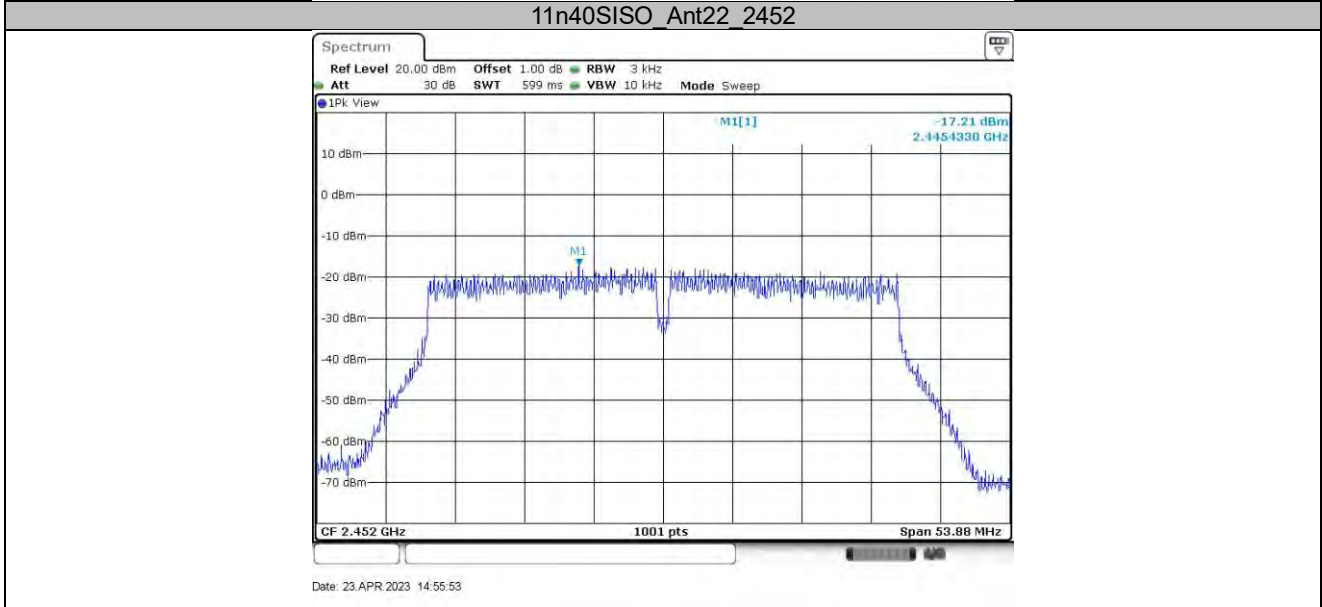
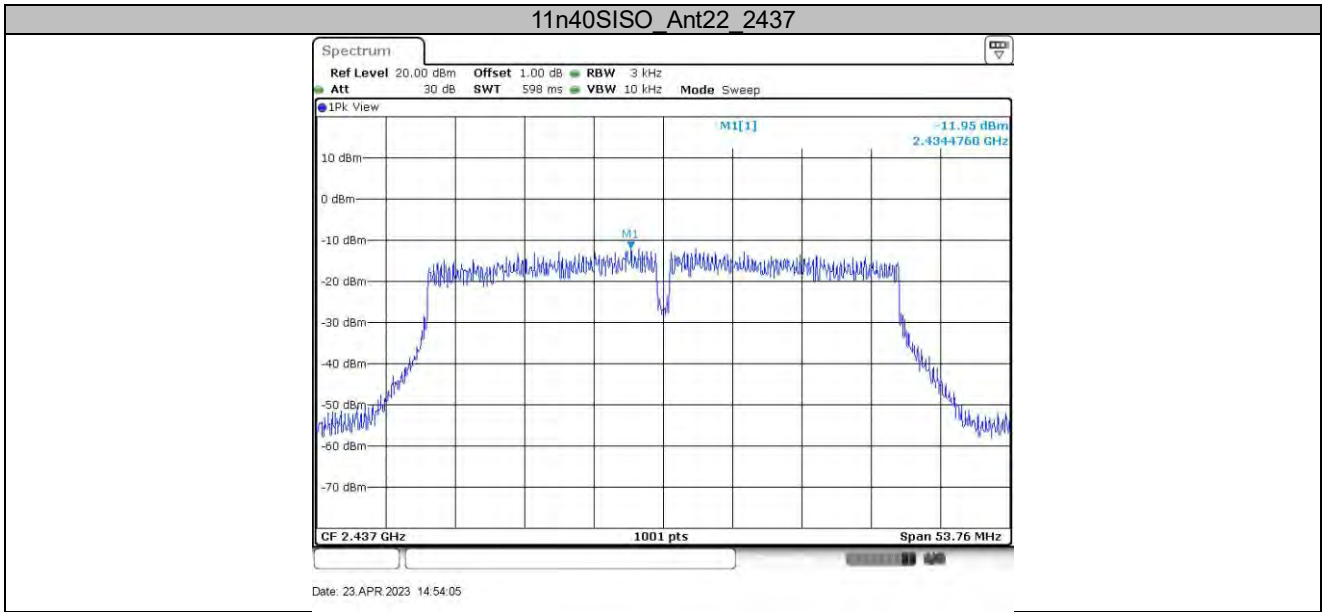
No.1 Workshop, M-10, Middle Section, Science & Technology Park, Nanshan District, Shenzhen, Guangdong, China 518057 t (86-755) 26012053 www.sgsgroup.com.cn  
 中国·广东·深圳市南山区科技园中区M-10栋1号厂房 邮编: 518057 t (86-755) 26012053 sgs.china@sgs.com





**SGS-CSTC Standards Technical Services Co., Ltd.**  
**Shenzhen Branch**

Report No.: ZEWM2303000343RG05  
 Page: 53 of 136



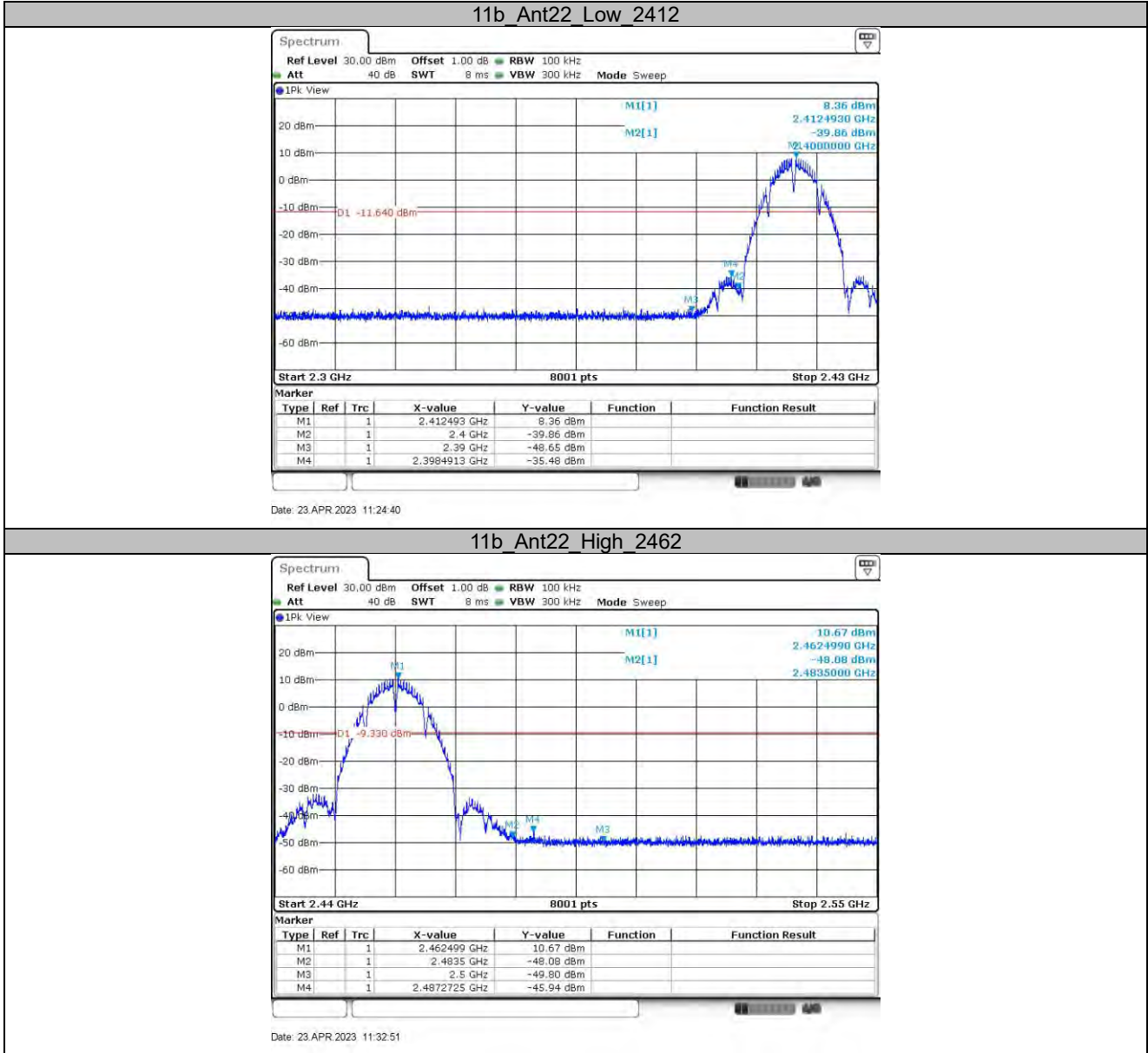
Unless otherwise agreed in writing, this document is issued by the Company subject to its General Conditions of Service printed overleaf, available on request or accessible at <https://www.sgs.com/en/Terms-and-Conditions>. Attention is drawn to the limitation of liability, indemnification and jurisdiction issues defined therein. Any holder of this document is advised that information contained hereon reflects the Company's findings at the time of its intervention only and within the limits of Client's instructions, if any. The Company's sole responsibility is to its Client and this document does not exonerate parties to a transaction from exercising all their rights and obligations under the transaction documents. This document cannot be reproduced except in full, without prior written approval of the Company. Any unauthorized alteration, forgery or falsification of the content or appearance of this document is unlawful and offenders may be prosecuted to the fullest extent of the law. Unless otherwise stated the results shown in this test report refer only to the sample(s) tested and such sample(s) are retained for 30 days only.

Attention: To check the authenticity of testing / inspection report & certificate, please contact us at telephone: (86-755) 8307 1443, or email: [CM\\_Doccheck@sgs.com](mailto:CM_Doccheck@sgs.com)

No.1 Workshop, M-10, Middle Section, Science & Technology Park, Nanshan District, Shenzhen, Guangdong, China 518057 t (86-755) 26012053 www.sgs.com.cn  
 中国·广东·深圳市南山区科技园中区M-10栋1号厂房 邮编: 518057 t (86-755) 26012053 sgs.china@sgs.com



**Band edge measurements**  
**Test Graphs**



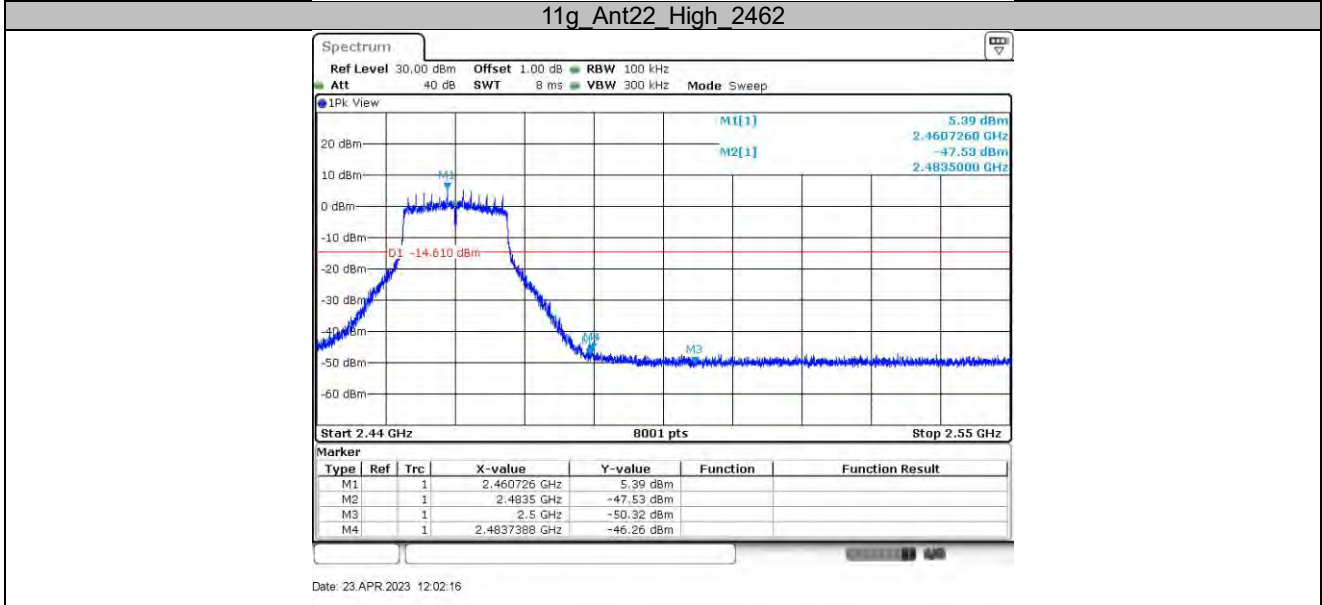
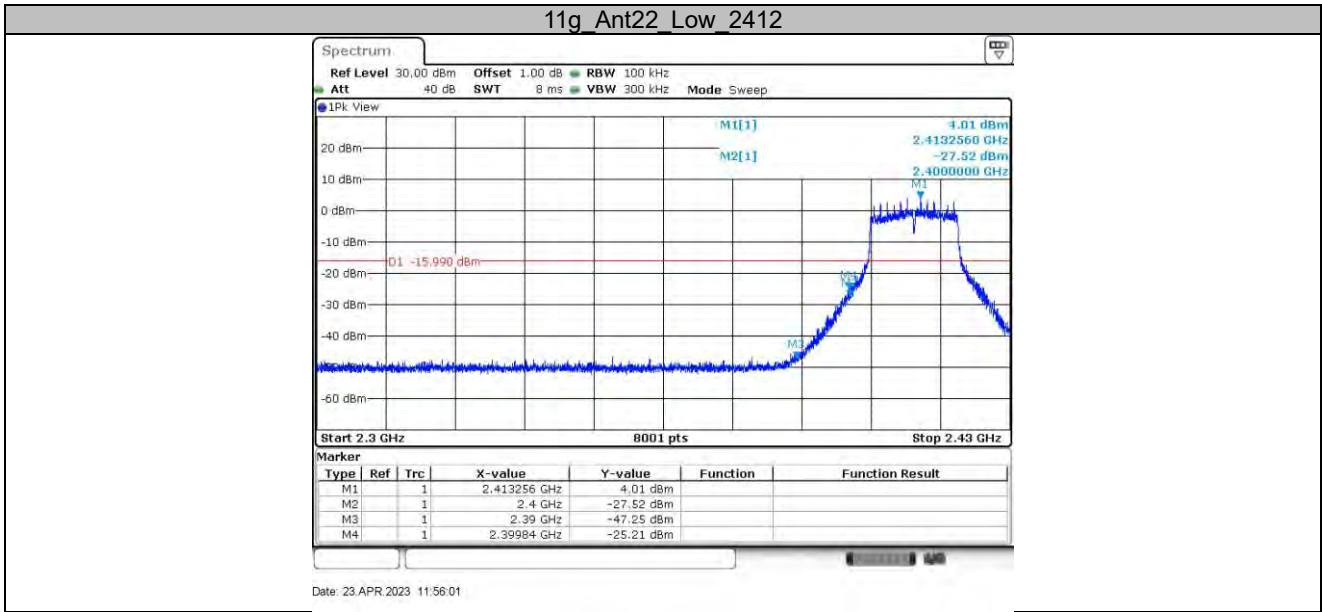
Unless otherwise agreed in writing, this document is issued by the Company subject to its General Conditions of Service printed overleaf, available on request or accessible at <https://www.sgs.com/en/Terms-and-Conditions>. Attention is drawn to the limitation of liability, indemnification and jurisdiction issues defined therein. Any holder of this document is advised that information contained hereon reflects the Company's findings at the time of its intervention only and within the limits of Client's instructions, if any. The Company's sole responsibility is to its Client and this document does not exonerate parties to a transaction from exercising all their rights and obligations under the transaction documents. This document cannot be reproduced except in full, without prior written approval of the Company. Any unauthorized alteration, forgery or falsification of the content or appearance of this document is unlawful and offenders may be prosecuted to the fullest extent of the law. Unless otherwise stated the results shown in this test report refer only to the sample(s) tested and such sample(s) are retained for 30 days only.

Attention: To check the authenticity of testing / inspection report & certificate, please contact us at telephone: (86-755) 8307 1443, or email: [CM\\_Doccheck@sgs.com](mailto:CM_Doccheck@sgs.com)  
 No. 1 Workshop, M-10, Middle Section, Science & Technology Park, Nanshan District, Shenzhen, Guangdong, China 518057 t (86-755) 26012053 www.sgsgroup.com.cn  
 中国·广东·深圳市南山区科技园中区M-10栋1号厂房 邮编: 518057 t (86-755) 26012053 sgs.china@sgs.com



**SGS-CSTC Standards Technical Services Co., Ltd.**  
**Shenzhen Branch**

Report No.: ZEWM2303000343RG05  
 Page: 55 of 136



Unless otherwise agreed in writing, this document is issued by the Company subject to its General Conditions of Service printed overleaf, available on request or accessible at <https://www.sgs.com/en/Terms-and-Conditions>. Attention is drawn to the limitation of liability, indemnification and jurisdiction issues defined therein. Any holder of this document is advised that information contained hereon reflects the Company's findings at the time of its intervention only and within the limits of Client's instructions, if any. The Company's sole responsibility is to its Client and this document does not exonerate parties to a transaction from exercising all their rights and obligations under the transaction documents. This document cannot be reproduced except in full, without prior written approval of the Company. Any unauthorized alteration, forgery or falsification of the content or appearance of this document is unlawful and offenders may be prosecuted to the fullest extent of the law. Unless otherwise stated the results shown in this test report refer only to the sample(s) tested and such sample(s) are retained for 30 days only.

Attention: To check the authenticity of testing / inspection report & certificate, please contact us at telephone: (86-755) 8307 1443, or email: [CN.Doccheck@sgs.com](mailto:CN.Doccheck@sgs.com)

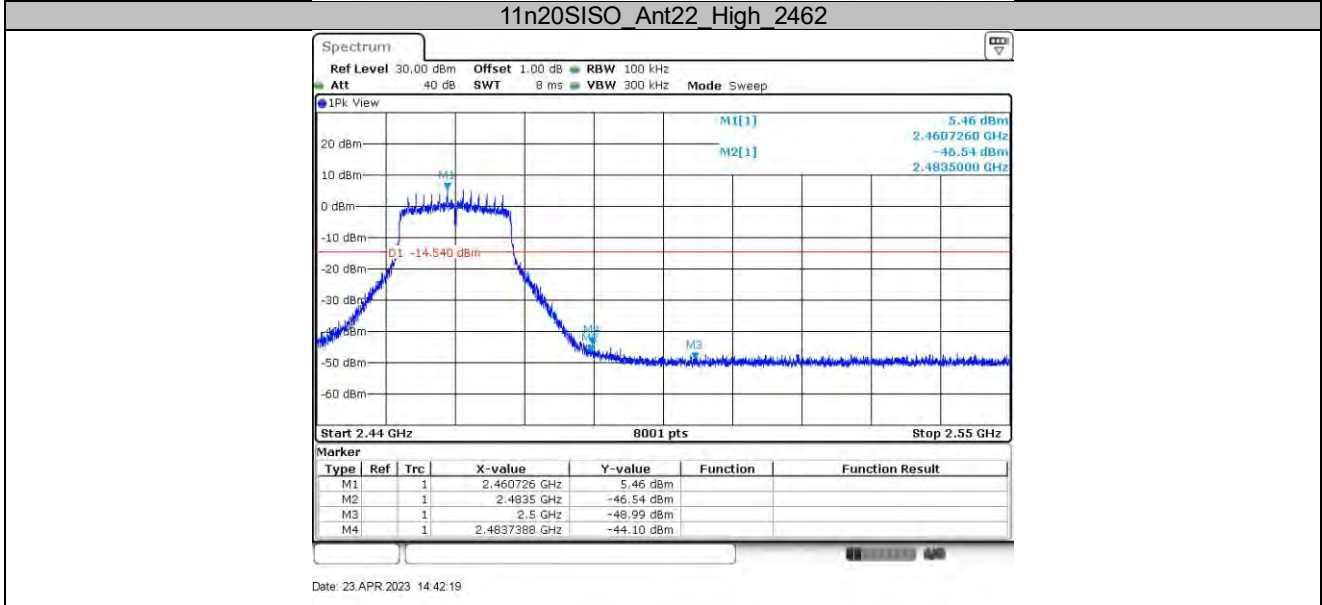
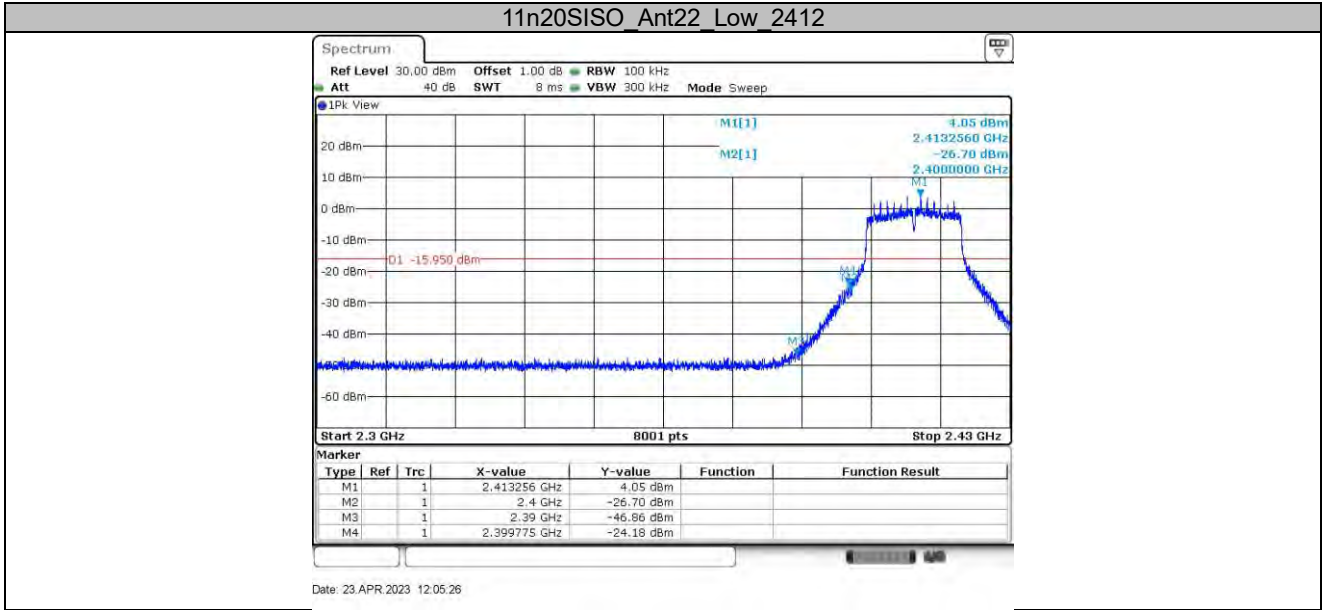
No. 1 Workshop, M-10, Middle Section, Science & Technology Park, Nanshan District, Shenzhen, Guangdong, China 518057 t (86-755) 26012053 www.sgsgroup.com.cn  
 中国·广东·深圳市南山区科技园中区M-10栋1号厂房 邮编: 518057 t (86-755) 26012053 sgs.china@sgs.com





**SGS-CSTC Standards Technical Services Co., Ltd.**  
**Shenzhen Branch**

Report No.: ZEWM2303000343RG05  
 Page: 56 of 136



Unless otherwise agreed in writing, this document is issued by the Company subject to its General Conditions of Service printed overleaf, available on request or accessible at <https://www.sgs.com/en/Terms-and-Conditions>. Attention is drawn to the limitation of liability, indemnification and jurisdiction issues defined therein. Any holder of this document is advised that information contained hereon reflects the Company's findings at the time of its intervention only and within the limits of Client's instructions, if any. The Company's sole responsibility is to its Client and this document does not exonerate parties to a transaction from exercising all their rights and obligations under the transaction documents. This document cannot be reproduced except in full, without prior written approval of the Company. Any unauthorized alteration, forgery or falsification of the content or appearance of this document is unlawful and offenders may be prosecuted to the fullest extent of the law. Unless otherwise stated the results shown in this test report refer only to the sample(s) tested and such sample(s) are retained for 30 days only.

Attention: To check the authenticity of testing / inspection report & certificate, please contact us at telephone: (86-755) 8307 1443, or email: [CN.Doccheck@sgs.com](mailto:CN.Doccheck@sgs.com)

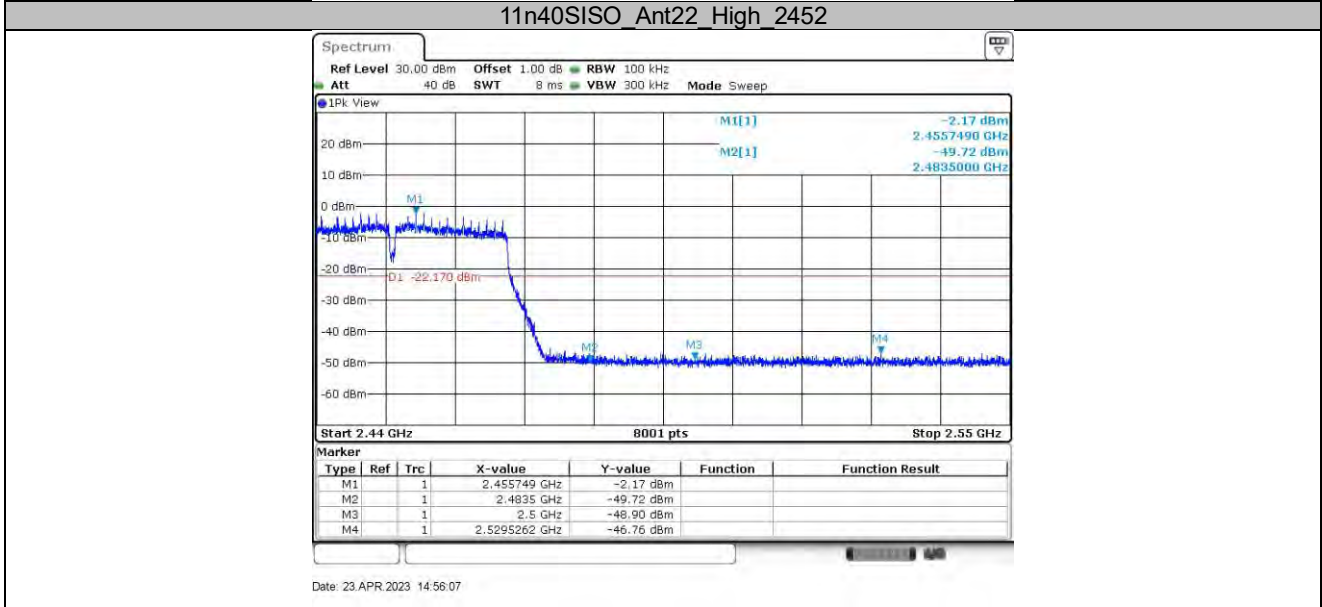
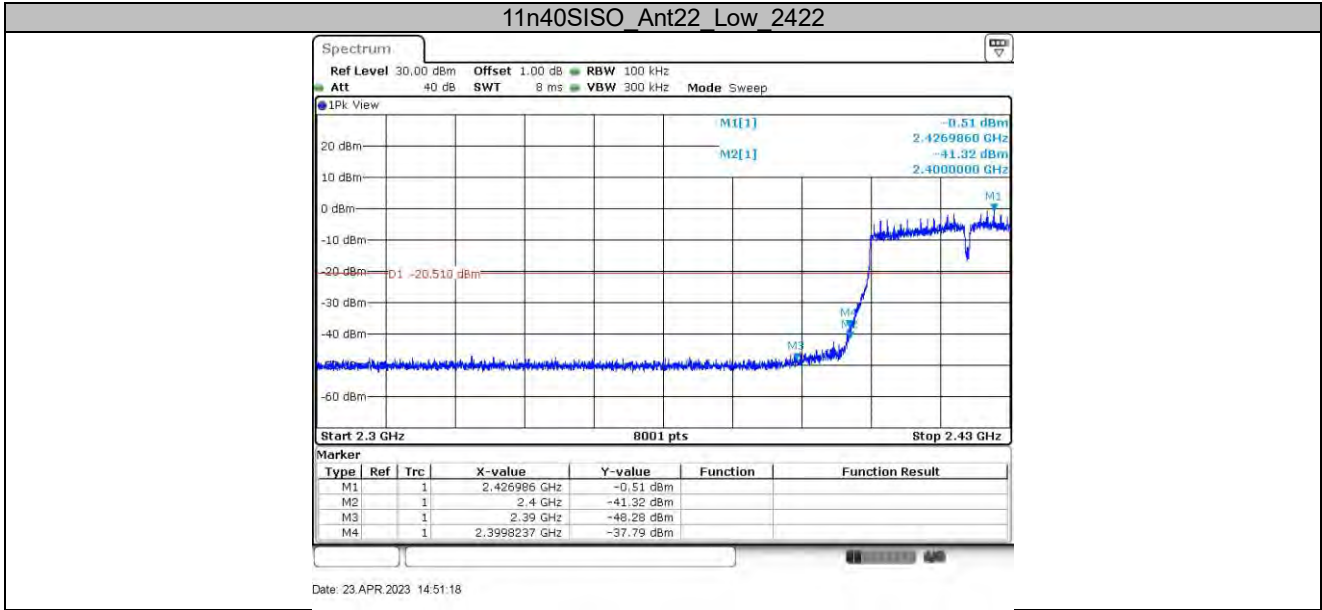
No. 1 Workshop, M-10, Middle Section, Science & Technology Park, Nanshan District, Shenzhen, Guangdong, China 518057 t (86-755) 26012053 www.sgsgroup.com.cn  
 中国·广东·深圳市南山区科技园中区M-10栋1号厂房 邮编: 518057 t (86-755) 26012053 sgs.china@sgs.com





**SGS-CSTC Standards Technical Services Co., Ltd.**  
**Shenzhen Branch**

Report No.: ZEWM2303000343RG05  
 Page: 57 of 136



Unless otherwise agreed in writing, this document is issued by the Company subject to its General Conditions of Service printed overleaf, available on request or accessible at <https://www.sgs.com/en/Terms-and-Conditions>. Attention is drawn to the limitation of liability, indemnification and jurisdiction issues defined therein. Any holder of this document is advised that information contained hereon reflects the Company's findings at the time of its intervention only and within the limits of Client's instructions, if any. The Company's sole responsibility is to its Client and this document does not exonerate parties to a transaction from exercising all their rights and obligations under the transaction documents. This document cannot be reproduced except in full, without prior written approval of the Company. Any unauthorized alteration, forgery or falsification of the content or appearance of this document is unlawful and offenders may be prosecuted to the fullest extent of the law. Unless otherwise stated the results shown in this test report refer only to the sample(s) tested and such sample(s) are retained for 30 days only.

Attention: To check the authenticity of testing / inspection report & certificate, please contact us at telephone: (86-755) 8307 1443, or email: [CN.Doccheck@sgs.com](mailto:CN.Doccheck@sgs.com)

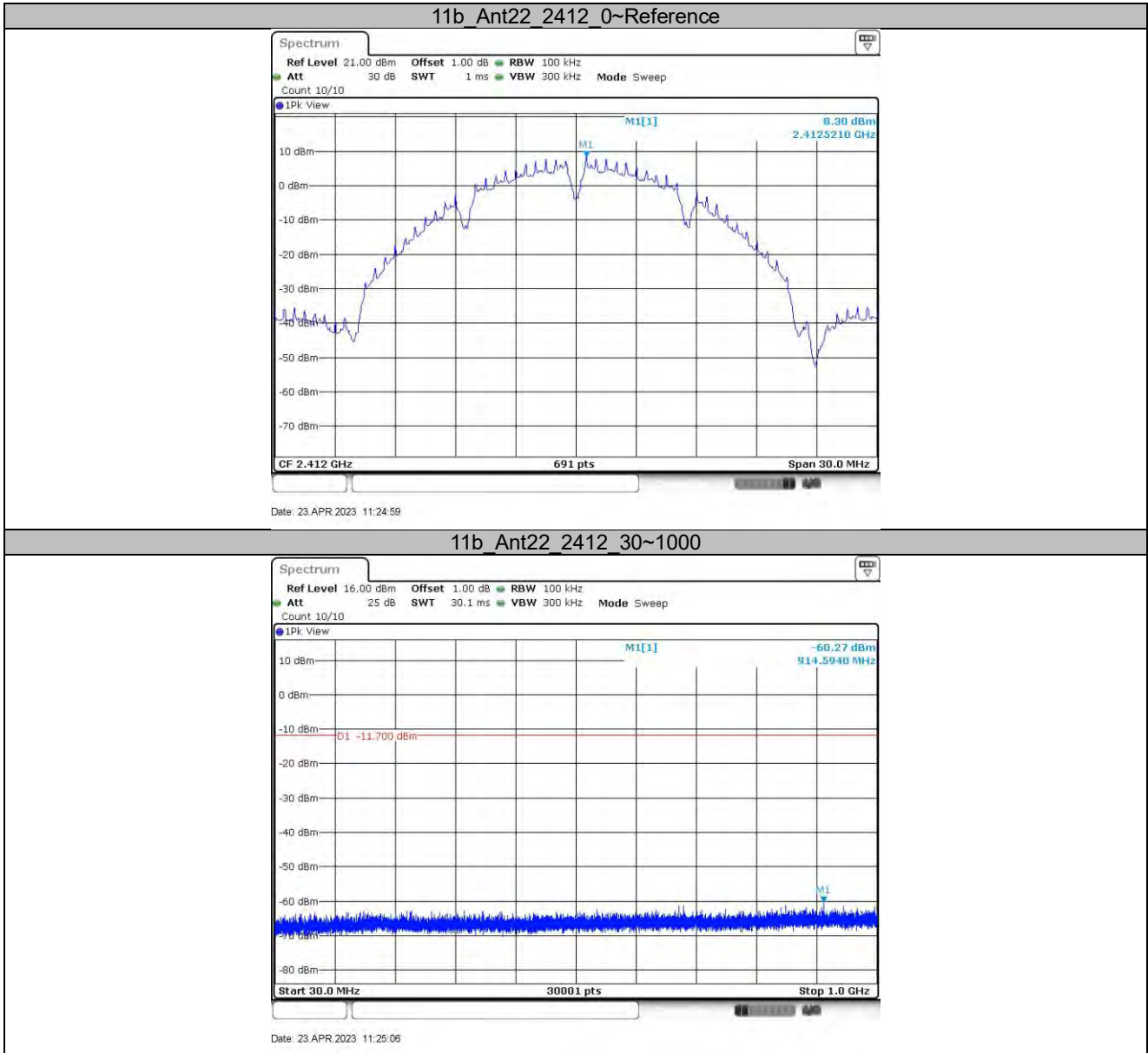
No.1 Workshop, M-10, Middle Section, Science & Technology Park, Nanshan District, Shenzhen, Guangdong, China 518057 t (86-755) 26012053 www.sgsgroup.com.cn  
 中国·广东·深圳市南山区科技园中区M-10栋1号厂房 邮编: 518057 t (86-755) 26012053 sgs.china@sgs.com



**SGS-CSTC Standards Technical Services Co., Ltd.**  
**Shenzhen Branch**

Report No.: ZEWM2303000343RG05  
 Page: 58 of 136

**Conducted Spurious Emission  
 Test Graphs**



Unless otherwise agreed in writing, this document is issued by the Company subject to its General Conditions of Service printed overleaf, available on request or accessible at <https://www.sgs.com/en/Terms-and-Conditions>. Attention is drawn to the limitation of liability, indemnification and jurisdiction issues defined therein. Any holder of this document is advised that information contained hereon reflects the Company's findings at the time of its intervention only and within the limits of Client's instructions, if any. The Company's sole responsibility is to its Client and this document does not exonerate parties to a transaction from exercising all their rights and obligations under the transaction documents. This document cannot be reproduced except in full, without prior written approval of the Company. Any unauthorized alteration, forgery or falsification of the content or appearance of this document is unlawful and offenders may be prosecuted to the fullest extent of the law. Unless otherwise stated the results shown in this test report refer only to the sample(s) tested and such sample(s) are retained for 30 days only.

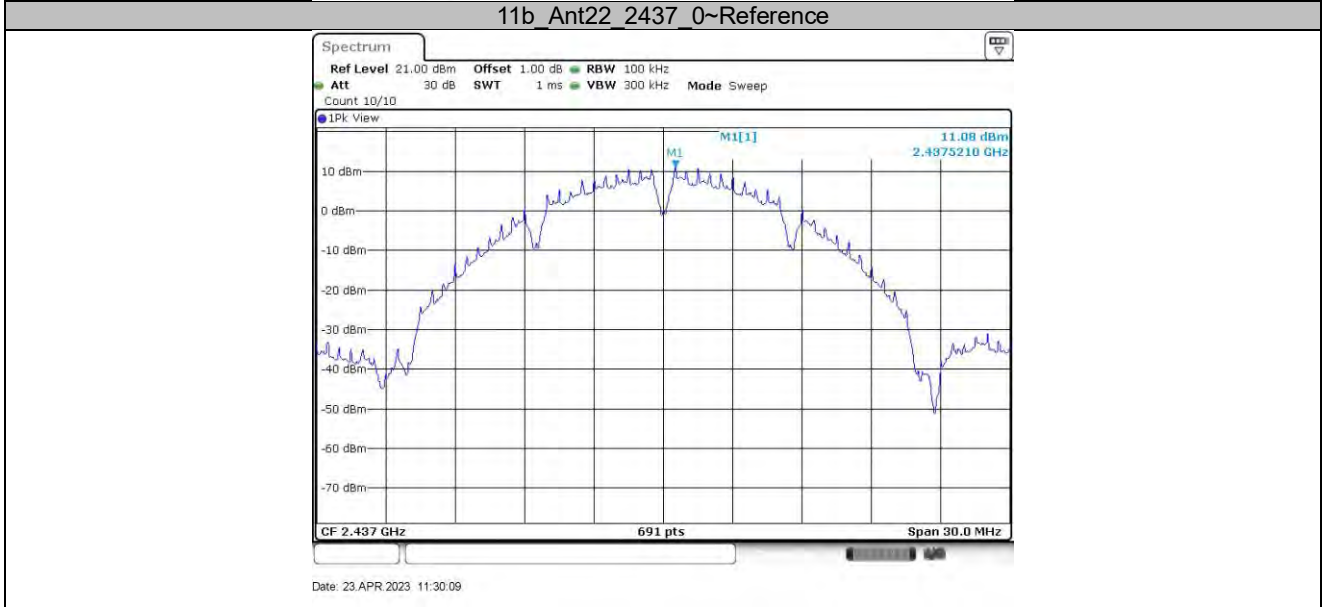
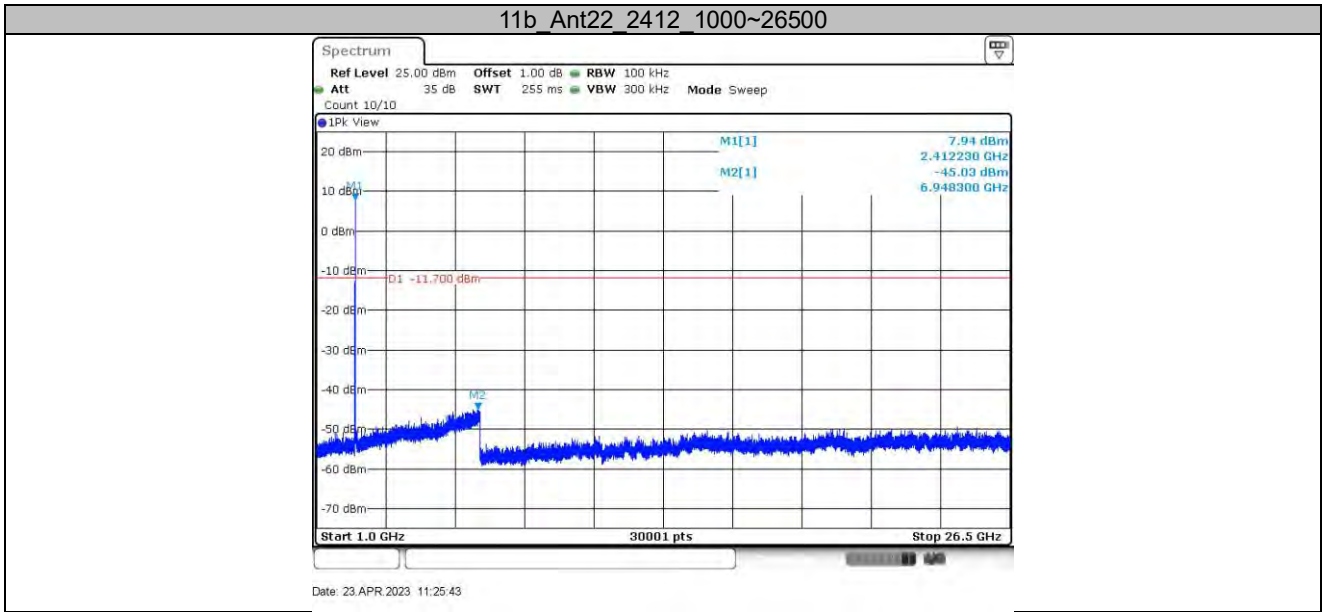
Attention: To check the authenticity of testing / inspection report & certificate, please contact us at telephone: (86-755) 8307 1443, or email: [CN.Doccheck@sgs.com](mailto:CN.Doccheck@sgs.com)

No. 1 Workshop, M-10, Middle Section, Science & Technology Park, Nanshan District, Shenzhen, Guangdong, China 518057 t (86-755) 26012053 www.sgsgroup.com.cn  
 中国·广东·深圳市南山区科技园中区M-10栋1号厂房 邮编: 518057 t (86-755) 26012053 sgs.china@sgs.com



**SGS-CSTC Standards Technical Services Co., Ltd.**  
**Shenzhen Branch**

Report No.: ZEWM2303000343RG05  
 Page: 59 of 136



Unless otherwise agreed in writing, this document is issued by the Company subject to its General Conditions of Service printed overleaf, available on request or accessible at <https://www.sgs.com/en/Terms-and-Conditions>. Attention is drawn to the limitation of liability, indemnification and jurisdiction issues defined therein. Any holder of this document is advised that information contained hereon reflects the Company's findings at the time of its intervention only and within the limits of Client's instructions, if any. The Company's sole responsibility is to its Client and this document does not exonerate parties to a transaction from exercising all their rights and obligations under the transaction documents. This document cannot be reproduced except in full, without prior written approval of the Company. Any unauthorized alteration, forgery or falsification of the content or appearance of this document is unlawful and offenders may be prosecuted to the fullest extent of the law. Unless otherwise stated the results shown in this test report refer only to the sample(s) tested and such sample(s) are retained for 30 days only.

Attention: To check the authenticity of testing / inspection report & certificate, please contact us at telephone: (86-755) 8307 1443, or email: [CN\\_Doccheck@sgs.com](mailto:CN_Doccheck@sgs.com)

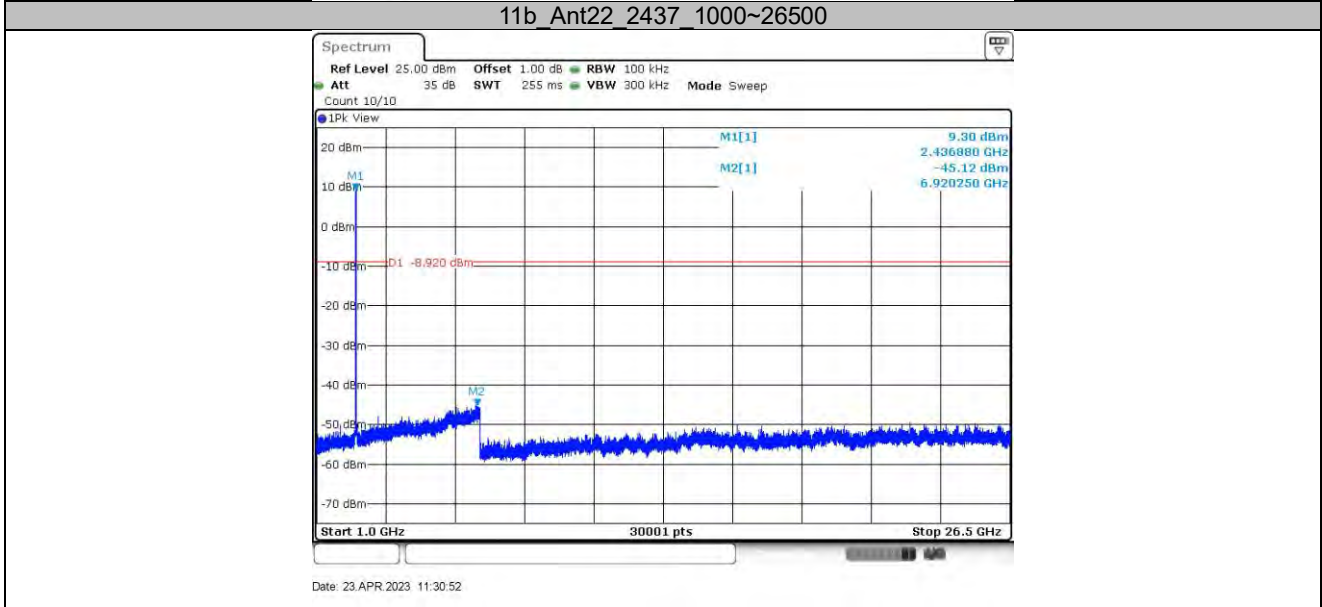
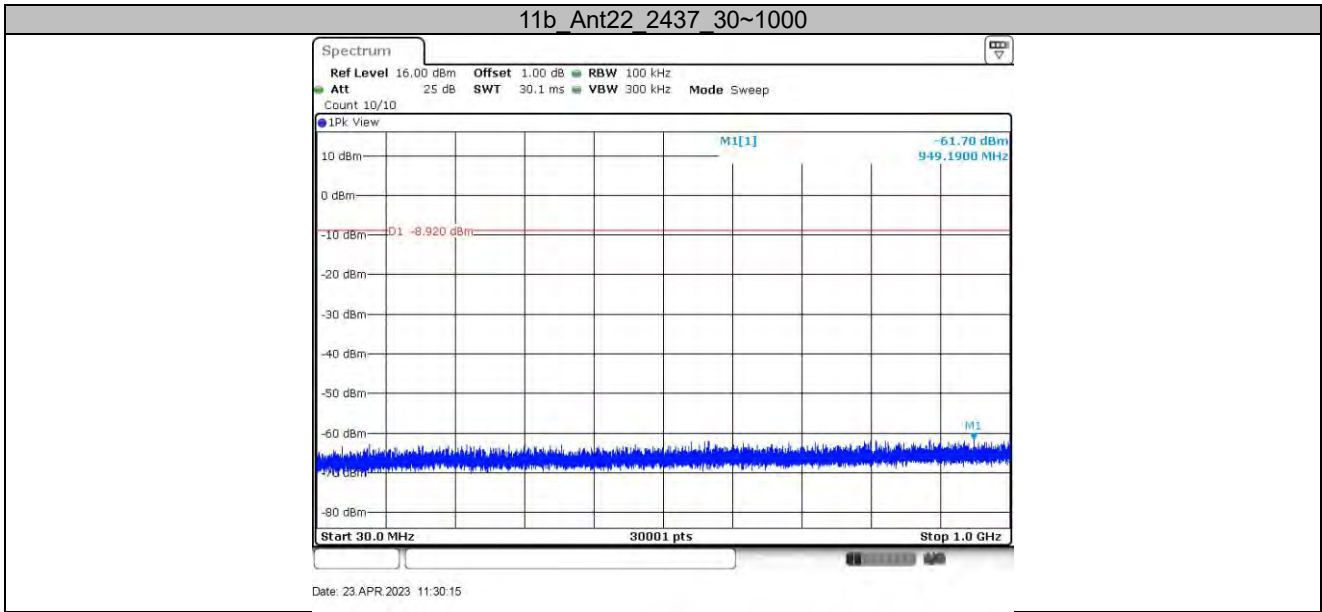
No. 1 Workshop, M-10, Middle Section, Science & Technology Park, Nanshan District, Shenzhen, Guangdong, China 518057 t (86-755) 26012053 www.sgsgroup.com.cn  
 中国·广东·深圳市南山区科技园中区M-10栋1号厂房 邮编: 518057 t (86-755) 26012053 sgs.china@sgs.com





**SGS-CSTC Standards Technical Services Co., Ltd.**  
**Shenzhen Branch**

Report No.: ZEWM2303000343RG05  
 Page: 60 of 136



Unless otherwise agreed in writing, this document is issued by the Company subject to its General Conditions of Service printed overleaf, available on request or accessible at <https://www.sgs.com/en/Terms-and-Conditions>. Attention is drawn to the limitation of liability, indemnification and jurisdiction issues defined therein. Any holder of this document is advised that information contained hereon reflects the Company's findings at the time of its intervention only and within the limits of Client's instructions, if any. The Company's sole responsibility is to its Client and this document does not exonerate parties to a transaction from exercising all their rights and obligations under the transaction documents. This document cannot be reproduced except in full, without prior written approval of the Company. Any unauthorized alteration, forgery or falsification of the content or appearance of this document is unlawful and offenders may be prosecuted to the fullest extent of the law. Unless otherwise stated the results shown in this test report refer only to the sample(s) tested and such sample(s) are retained for 30 days only.

Attention: To check the authenticity of testing / inspection report & certificate, please contact us at telephone: (86-755) 8307 1443, or email: [CN.Doccheck@sgs.com](mailto:CN.Doccheck@sgs.com)

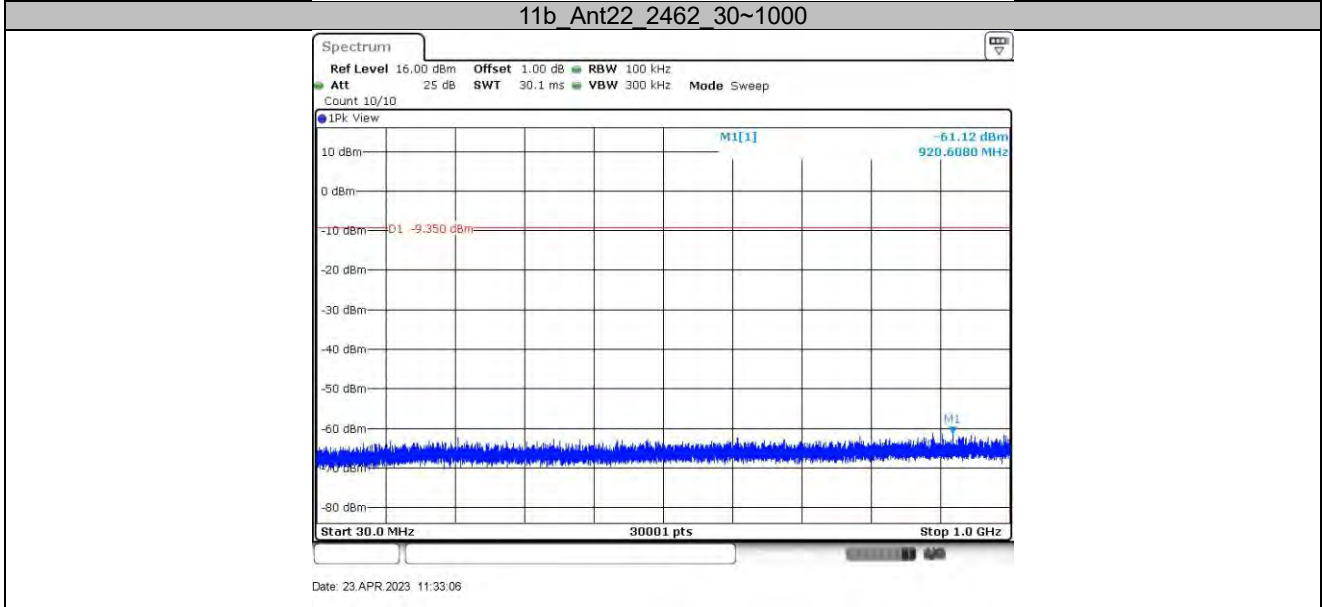
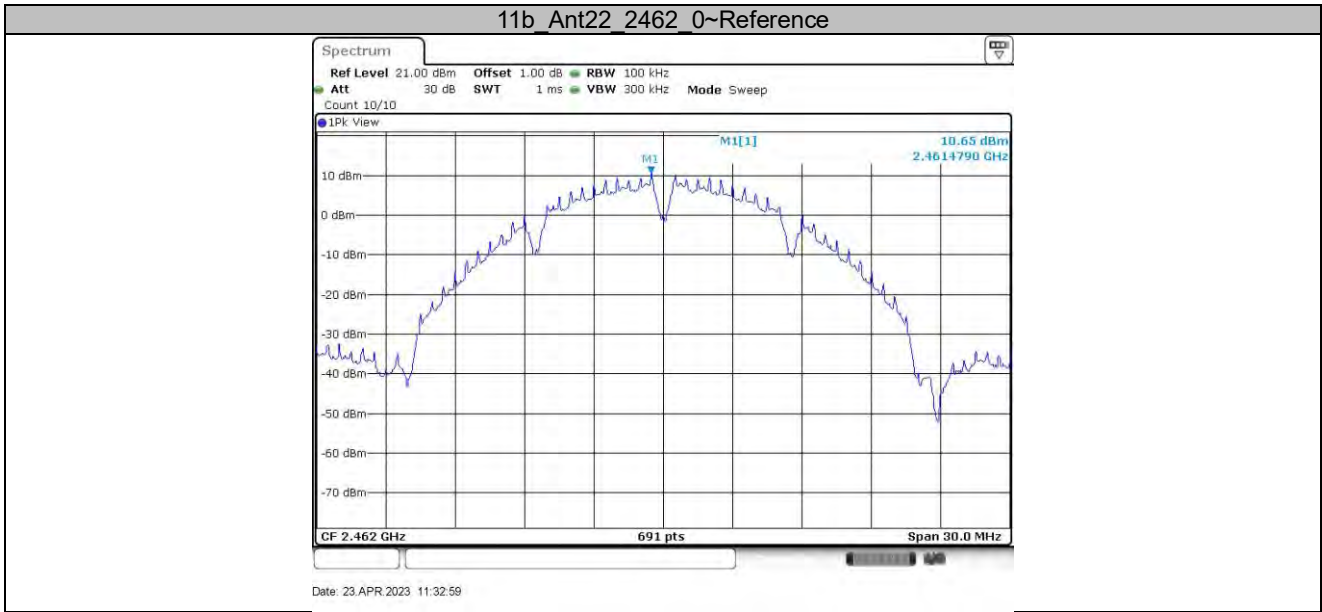
No. 1 Workshop, M-10, Middle Section, Science & Technology Park, Nanshan District, Shenzhen, Guangdong, China 518057 t (86-755) 26012053 www.sgsgroup.com.cn  
 中国·广东·深圳市南山区科技园中区M-10栋1号厂房 邮编: 518057 t (86-755) 26012053 sgs.china@sgs.com





**SGS-CSTC Standards Technical Services Co., Ltd.**  
**Shenzhen Branch**

Report No.: ZEWM2303000343RG05  
 Page: 61 of 136



Unless otherwise agreed in writing, this document is issued by the Company subject to its General Conditions of Service printed overleaf, available on request or accessible at <https://www.sgs.com/en/Terms-and-Conditions>. Attention is drawn to the limitation of liability, indemnification and jurisdiction issues defined therein. Any holder of this document is advised that information contained hereon reflects the Company's findings at the time of its intervention only and within the limits of Client's instructions, if any. The Company's sole responsibility is to its Client and this document does not exonerate parties to a transaction from exercising all their rights and obligations under the transaction documents. This document cannot be reproduced except in full, without prior written approval of the Company. Any unauthorized alteration, forgery or falsification of the content or appearance of this document is unlawful and offenders may be prosecuted to the fullest extent of the law. Unless otherwise stated the results shown in this test report refer only to the sample(s) tested and such sample(s) are retained for 30 days only.

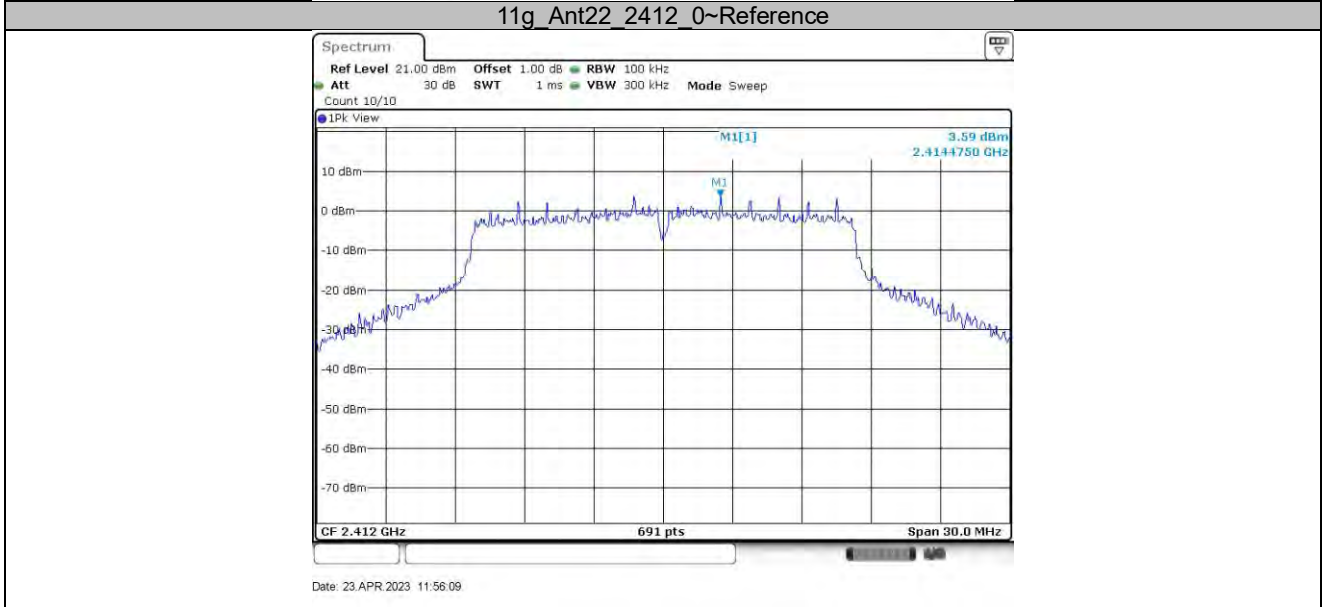
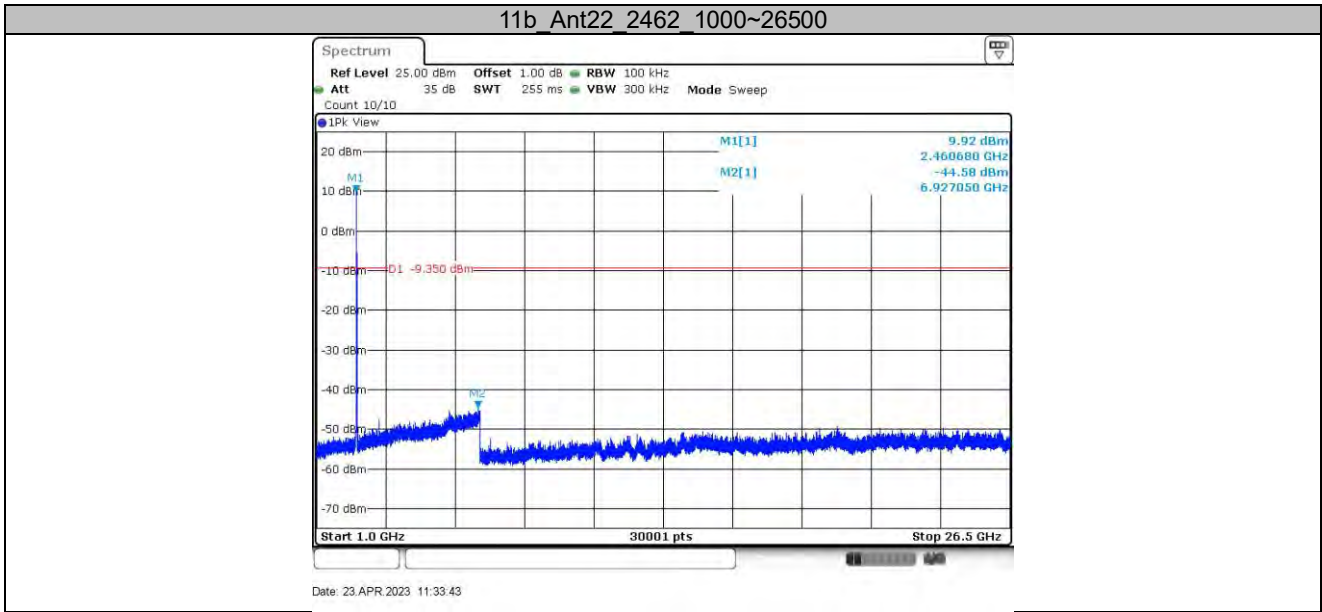
Attention: To check the authenticity of testing / inspection report & certificate, please contact us at telephone: (86-755) 8307 1443, or email: [CN.Doccheck@sgs.com](mailto:CN.Doccheck@sgs.com)

No. 1 Workshop, M-10, Middle Section, Science & Technology Park, Nanshan District, Shenzhen, Guangdong, China 518057 t (86-755) 26012053 www.sgs.com.cn  
 中国·广东·深圳市南山区科技园中区M-10栋1号厂房 邮编: 518057 t (86-755) 26012053 sgs.china@sgs.com



**SGS-CSTC Standards Technical Services Co., Ltd.**  
**Shenzhen Branch**

Report No.: ZEWM2303000343RG05  
 Page: 62 of 136



Unless otherwise agreed in writing, this document is issued by the Company subject to its General Conditions of Service printed overleaf, available on request or accessible at <https://www.sgs.com/en/Terms-and-Conditions>. Attention is drawn to the limitation of liability, indemnification and jurisdiction issues defined therein. Any holder of this document is advised that information contained hereon reflects the Company's findings at the time of its intervention only and within the limits of Client's instructions, if any. The Company's sole responsibility is to its Client and this document does not exonerate parties to a transaction from exercising all their rights and obligations under the transaction documents. This document cannot be reproduced except in full, without prior written approval of the Company. Any unauthorized alteration, forgery or falsification of the content or appearance of this document is unlawful and offenders may be prosecuted to the fullest extent of the law. Unless otherwise stated the results shown in this test report refer only to the sample(s) tested and such sample(s) are retained for 30 days only.

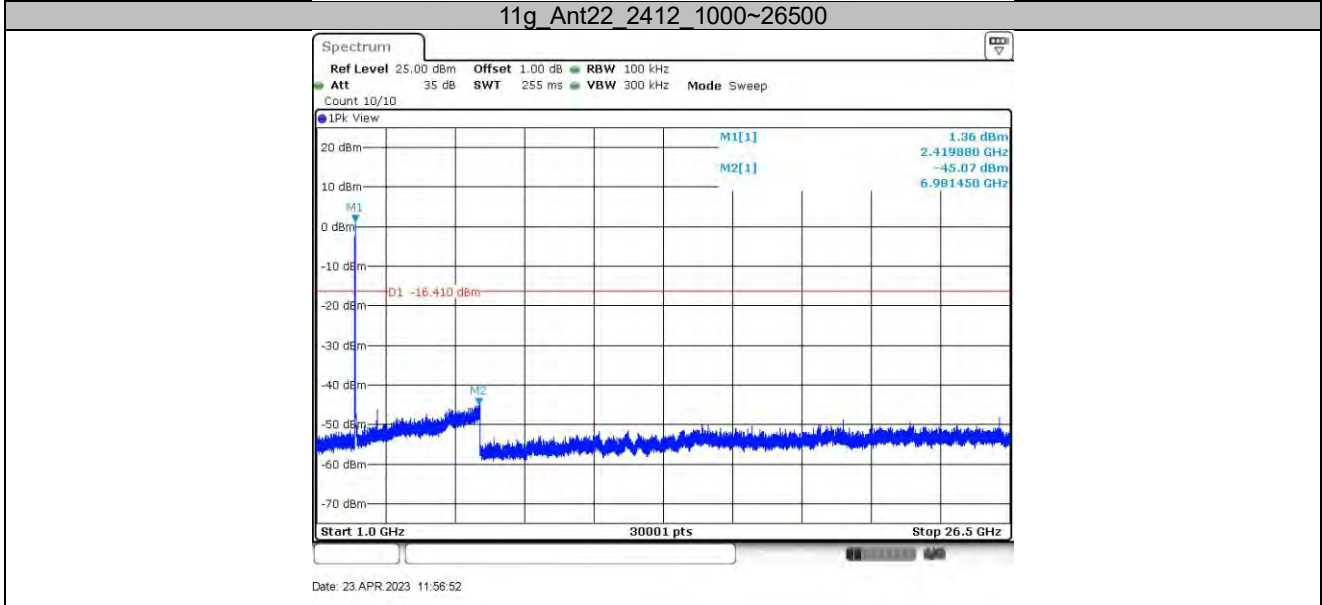
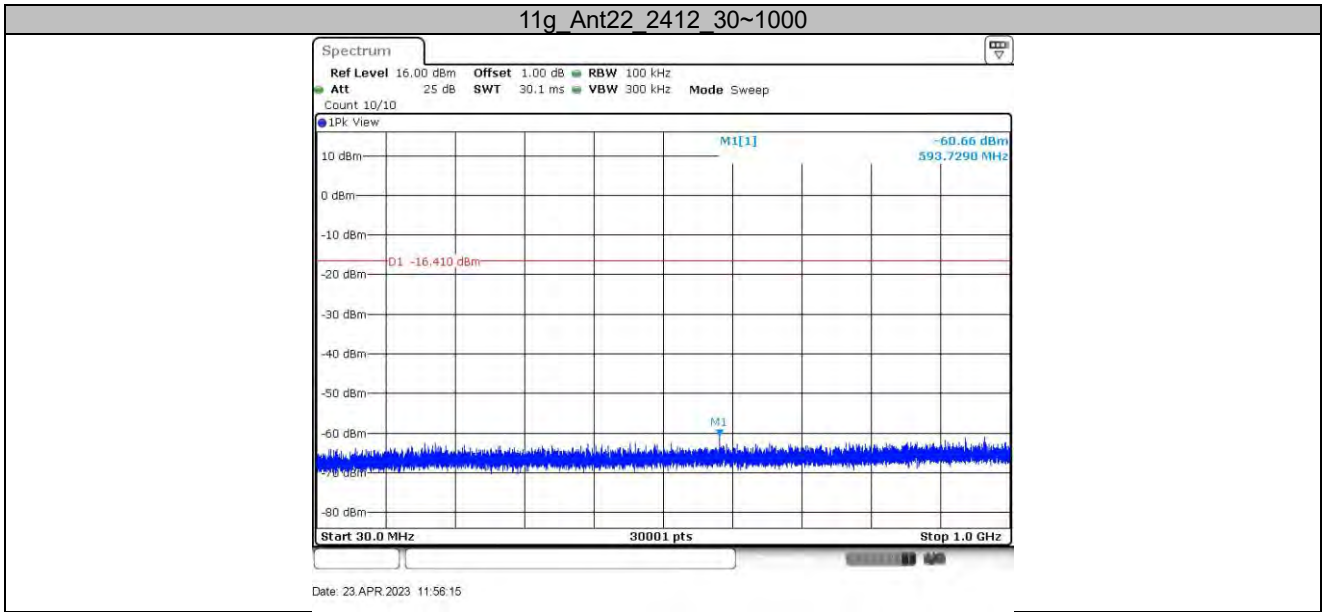
Attention: To check the authenticity of testing / inspection report & certificate, please contact us at telephone: (86-755) 8307 1443, or email: [CM\\_Doccheck@sgs.com](mailto:CM_Doccheck@sgs.com)

No. 1 Workshop, M-10, Middle Section, Science & Technology Park, Nanshan District, Shenzhen, Guangdong, China 518057 t (86-755) 26012053 www.sgsgroup.com.cn  
 中国·广东·深圳市南山区科技园中区M-10栋1号厂房 邮编: 518057 t (86-755) 26012053 sgs.china@sgs.com



**SGS-CSTC Standards Technical Services Co., Ltd.**  
**Shenzhen Branch**

Report No.: ZEWM2303000343RG05  
 Page: 63 of 136



Unless otherwise agreed in writing, this document is issued by the Company subject to its General Conditions of Service printed overleaf, available on request or accessible at <https://www.sgs.com/en/Terms-and-Conditions>. Attention is drawn to the limitation of liability, indemnification and jurisdiction issues defined therein. Any holder of this document is advised that information contained hereon reflects the Company's findings at the time of its intervention only and within the limits of Client's instructions, if any. The Company's sole responsibility is to its Client and this document does not exonerate parties to a transaction from exercising all their rights and obligations under the transaction documents. This document cannot be reproduced except in full, without prior written approval of the Company. Any unauthorized alteration, forgery or falsification of the content or appearance of this document is unlawful and offenders may be prosecuted to the fullest extent of the law. Unless otherwise stated the results shown in this test report refer only to the sample(s) tested and such sample(s) are retained for 30 days only.

Attention: To check the authenticity of testing / inspection report & certificate, please contact us at telephone: (86-755) 8307 1443, or email: [CN.Doccheck@sgs.com](mailto:CN.Doccheck@sgs.com)

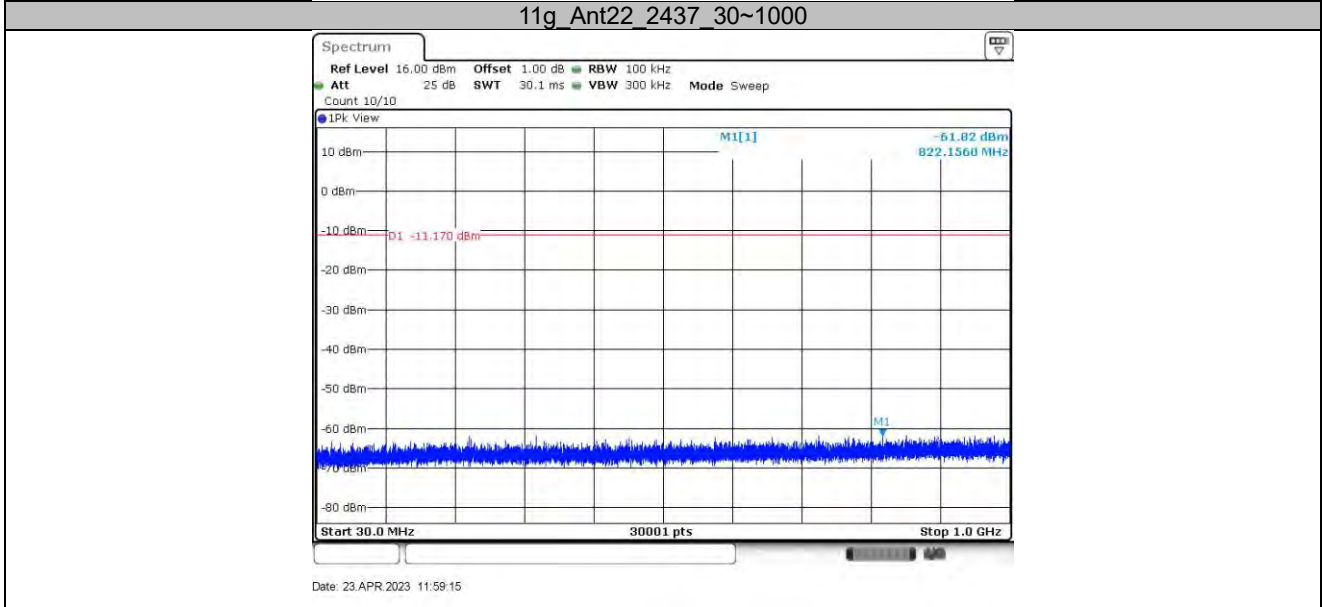
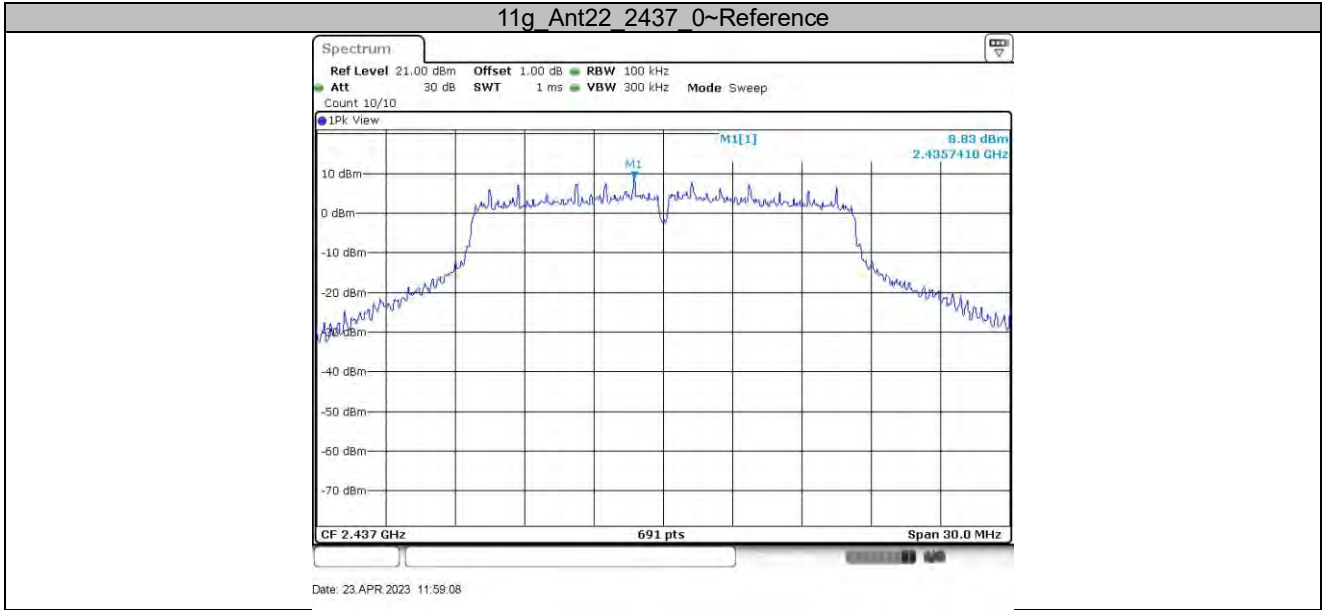
No. 1 Workshop, M-10, Middle Section, Science & Technology Park, Nanshan District, Shenzhen, Guangdong, China 518057 t (86-755) 26012053 www.sgsgroup.com.cn  
 中国·广东·深圳市南山区科技园中区M-10栋1号厂房 邮编: 518057 t (86-755) 26012053 sgs.china@sgs.com





**SGS-CSTC Standards Technical Services Co., Ltd.**  
**Shenzhen Branch**

Report No.: ZEWM2303000343RG05  
 Page: 64 of 136



Unless otherwise agreed in writing, this document is issued by the Company subject to its General Conditions of Service printed overleaf, available on request or accessible at <https://www.sgs.com/en/Terms-and-Conditions>. Attention is drawn to the limitation of liability, indemnification and jurisdiction issues defined therein. Any holder of this document is advised that information contained hereon reflects the Company's findings at the time of its intervention only and within the limits of Client's instructions, if any. The Company's sole responsibility is to its Client and this document does not exonerate parties to a transaction from exercising all their rights and obligations under the transaction documents. This document cannot be reproduced except in full, without prior written approval of the Company. Any unauthorized alteration, forgery or falsification of the content or appearance of this document is unlawful and offenders may be prosecuted to the fullest extent of the law. Unless otherwise stated the results shown in this test report refer only to the sample(s) tested and such sample(s) are retained for 30 days only.

Attention: To check the authenticity of testing / inspection report & certificate, please contact us at telephone: (86-755)8307 1443, or email: [CN\\_Doccheck@sgs.com](mailto:CN_Doccheck@sgs.com)

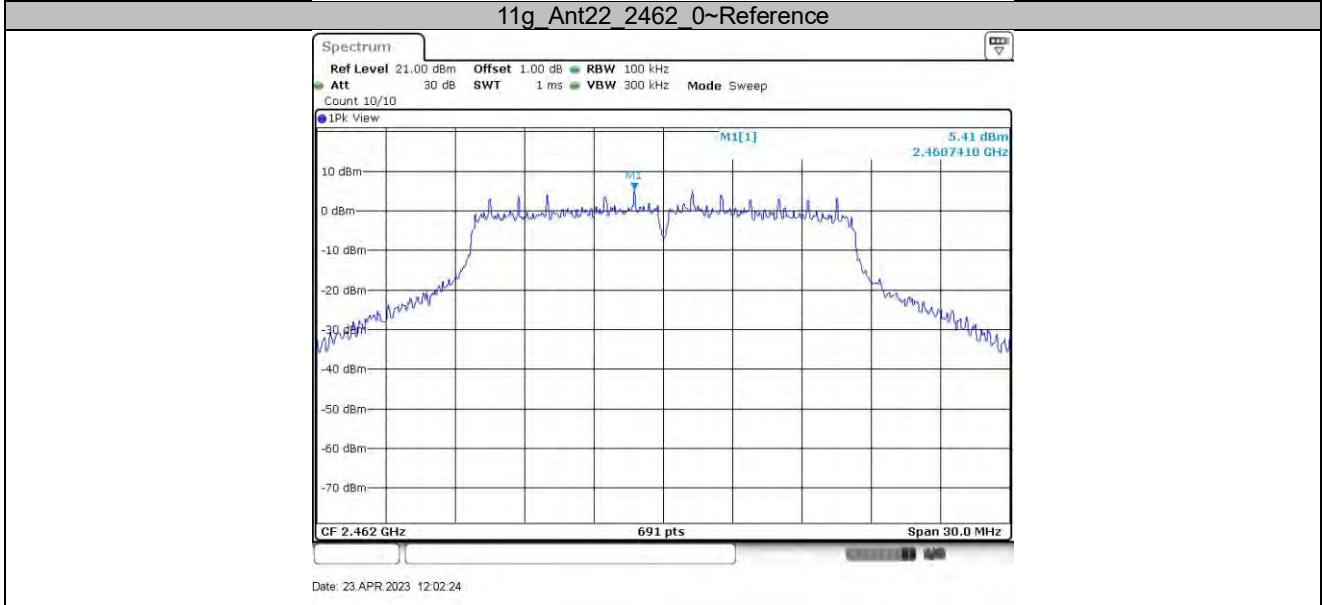
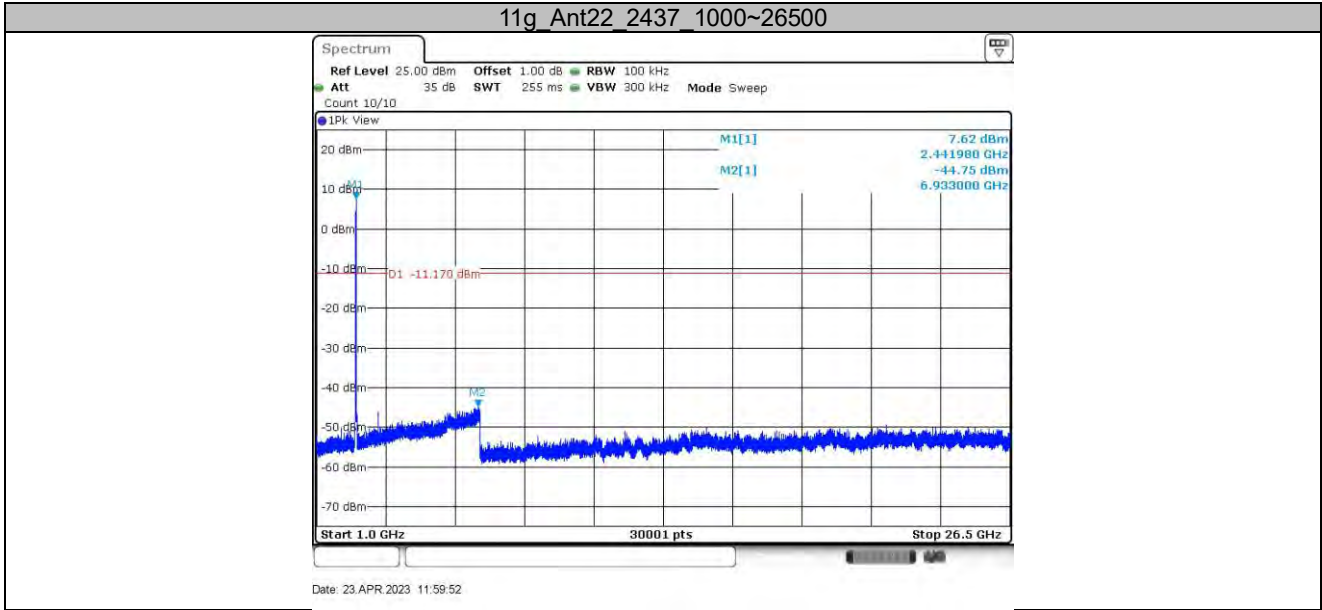
No.1 Workshop, M-10, Middle Section, Science & Technology Park, Nanshan District, Shenzhen, Guangdong, China 518057 t (86-755) 26012053 www.sgs.com.cn  
 中国·广东·深圳市南山区科技园中区M-10栋1号厂房 邮编: 518057 t (86-755) 26012053 sgs.china@sgs.com





**SGS-CSTC Standards Technical Services Co., Ltd.**  
**Shenzhen Branch**

Report No.: ZEWM2303000343RG05  
 Page: 65 of 136



Unless otherwise agreed in writing, this document is issued by the Company subject to its General Conditions of Service printed overleaf, available on request or accessible at <https://www.sgs.com/en/Terms-and-Conditions>. Attention is drawn to the limitation of liability, indemnification and jurisdiction issues defined therein. Any holder of this document is advised that information contained hereon reflects the Company's findings at the time of its intervention only and within the limits of Client's instructions, if any. The Company's sole responsibility is to its Client and this document does not exonerate parties to a transaction from exercising all their rights and obligations under the transaction documents. This document cannot be reproduced except in full, without prior written approval of the Company. Any unauthorized alteration, forgery or falsification of the content or appearance of this document is unlawful and offenders may be prosecuted to the fullest extent of the law. Unless otherwise stated the results shown in this test report refer only to the sample(s) tested and such sample(s) are retained for 30 days only.

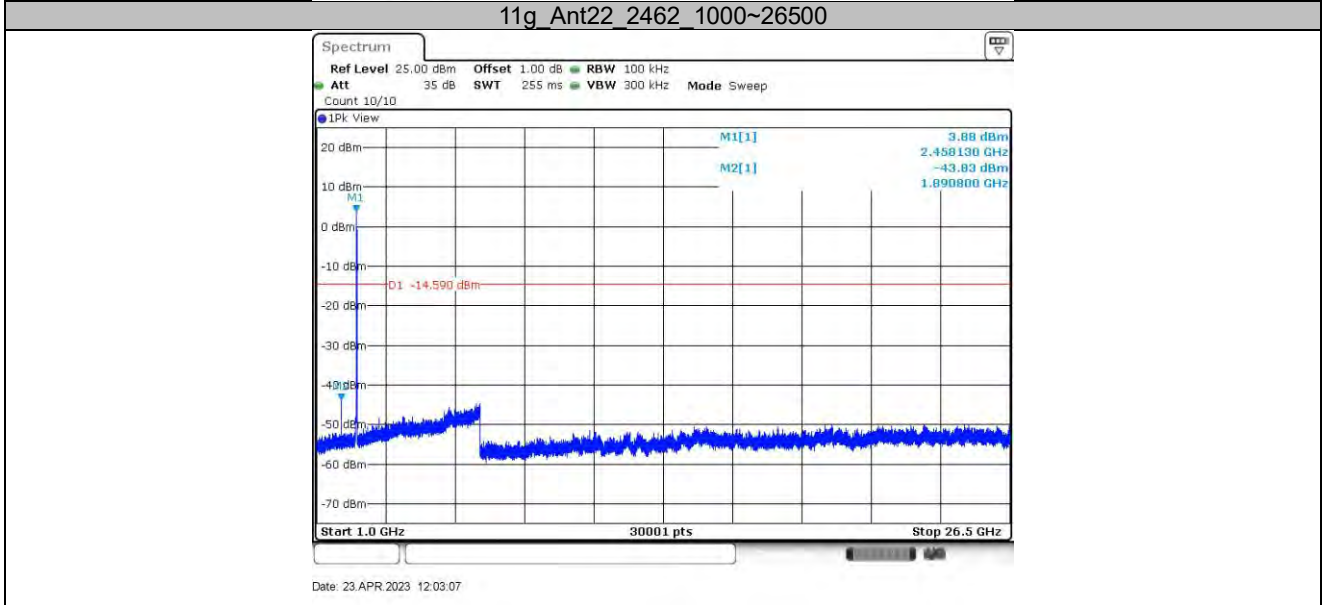
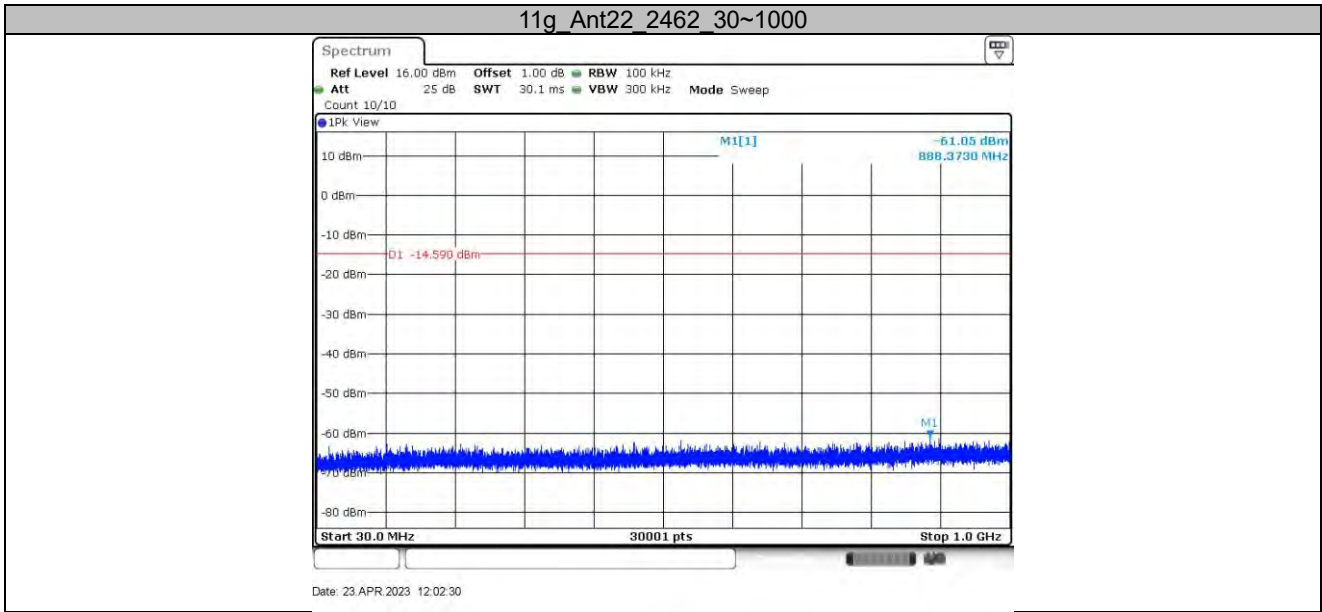
Attention: To check the authenticity of testing / inspection report & certificate, please contact us at telephone: (86-755) 8307 1443, or email: [CM.Doccheck@sgs.com](mailto:CM.Doccheck@sgs.com)

No. 1 Workshop, M-10, Middle Section, Science & Technology Park, Nanshan District, Shenzhen, Guangdong, China 518057 t (86-755) 26012053 www.sgs.com.cn  
 中国·广东·深圳市南山区科技园中区M-10栋1号厂房 邮编: 518057 t (86-755) 26012053 sgs.china@sgs.com



**SGS-CSTC Standards Technical Services Co., Ltd.**  
**Shenzhen Branch**

Report No.: ZEWM2303000343RG05  
 Page: 66 of 136



Unless otherwise agreed in writing, this document is issued by the Company subject to its General Conditions of Service printed overleaf, available on request or accessible at <https://www.sgs.com/en/Terms-and-Conditions>. Attention is drawn to the limitation of liability, indemnification and jurisdiction issues defined therein. Any holder of this document is advised that information contained hereon reflects the Company's findings at the time of its intervention only and within the limits of Client's instructions, if any. The Company's sole responsibility is to its Client and this document does not exonerate parties to a transaction from exercising all their rights and obligations under the transaction documents. This document cannot be reproduced except in full, without prior written approval of the Company. Any unauthorized alteration, forgery or falsification of the content or appearance of this document is unlawful and offenders may be prosecuted to the fullest extent of the law. Unless otherwise stated the results shown in this test report refer only to the sample(s) tested and such sample(s) are retained for 30 days only.

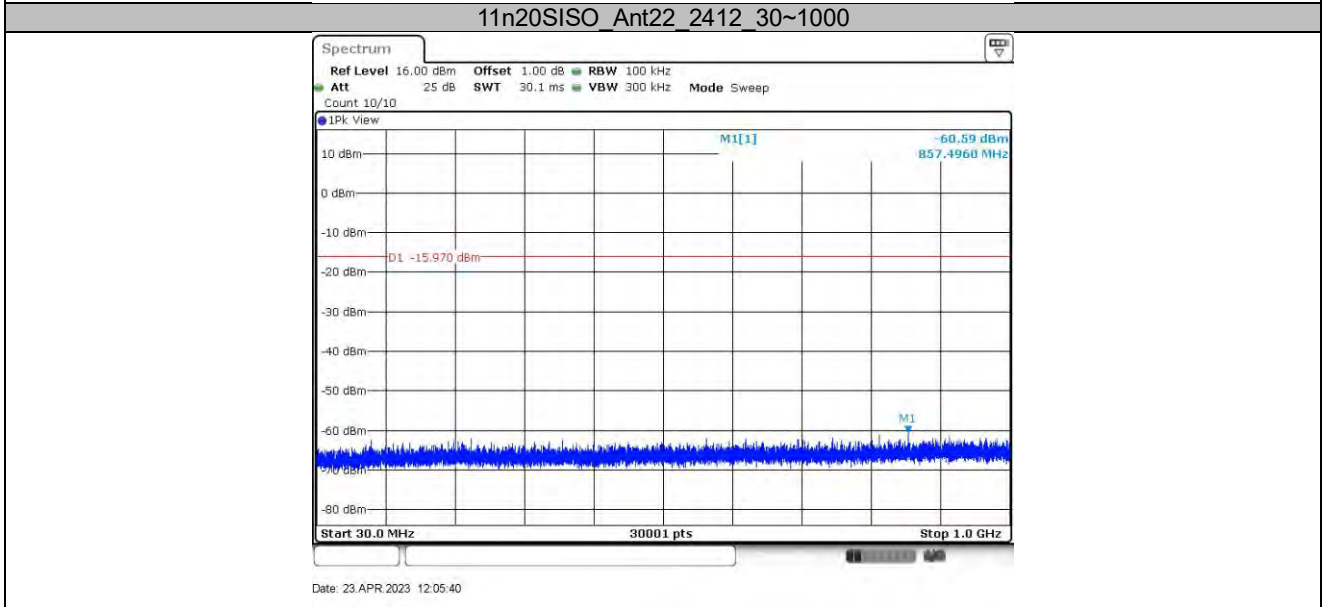
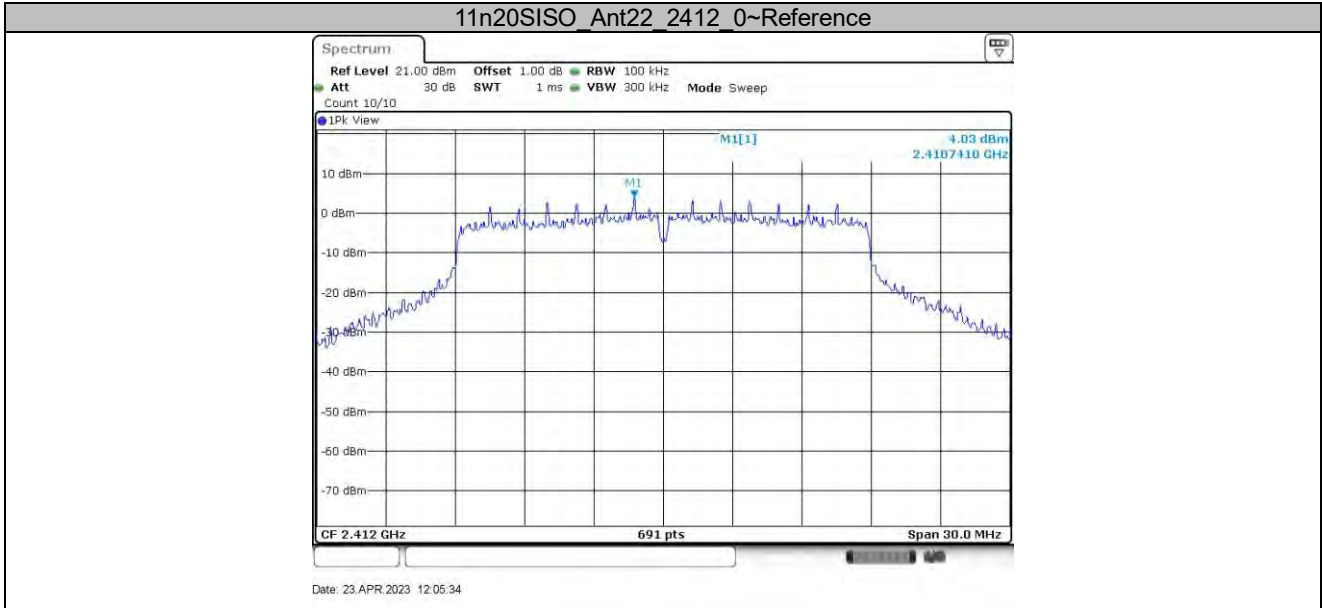
Attention: To check the authenticity of testing / inspection report & certificate, please contact us at telephone: (86-755) 8307 1443, or email: [CM.Doccheck@sgs.com](mailto:CM.Doccheck@sgs.com)

No. 1 Workshop, M-10, Middle Section, Science & Technology Park, Nanshan District, Shenzhen, Guangdong, China 518057    t (86-755) 26012053    www.sgsgroup.com.cn  
 中国 · 广东 · 深圳市南山区科技园中区M-10栋1号厂房    邮编: 518057    t (86-755) 26012053    sgs.china@sgs.com



**SGS-CSTC Standards Technical Services Co., Ltd.**  
**Shenzhen Branch**

Report No.: ZEWM2303000343RG05  
 Page: 67 of 136



Unless otherwise agreed in writing, this document is issued by the Company subject to its General Conditions of Service printed overleaf, available on request or accessible at <https://www.sgs.com/en/Terms-and-Conditions>. Attention is drawn to the limitation of liability, indemnification and jurisdiction issues defined therein. Any holder of this document is advised that information contained hereon reflects the Company's findings at the time of its intervention only and within the limits of Client's instructions, if any. The Company's sole responsibility is to its Client and this document does not exonerate parties to a transaction from exercising all their rights and obligations under the transaction documents. This document cannot be reproduced except in full, without prior written approval of the Company. Any unauthorized alteration, forgery or falsification of the content or appearance of this document is unlawful and offenders may be prosecuted to the fullest extent of the law. Unless otherwise stated the results shown in this test report refer only to the sample(s) tested and such sample(s) are retained for 30 days only.

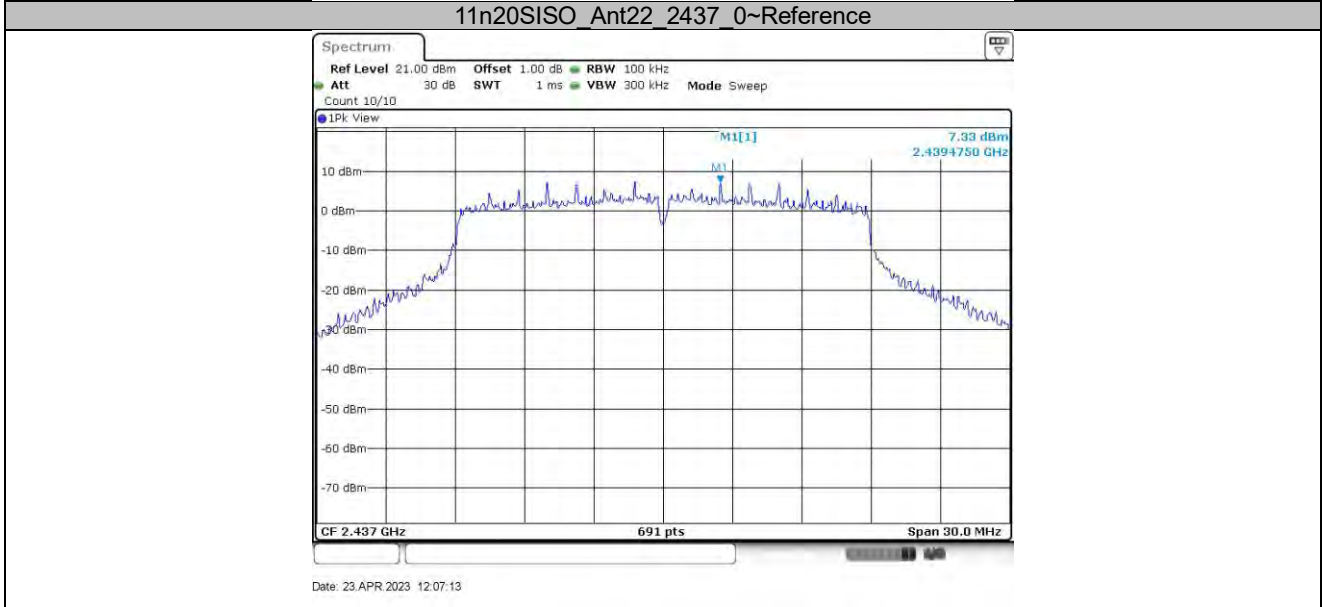
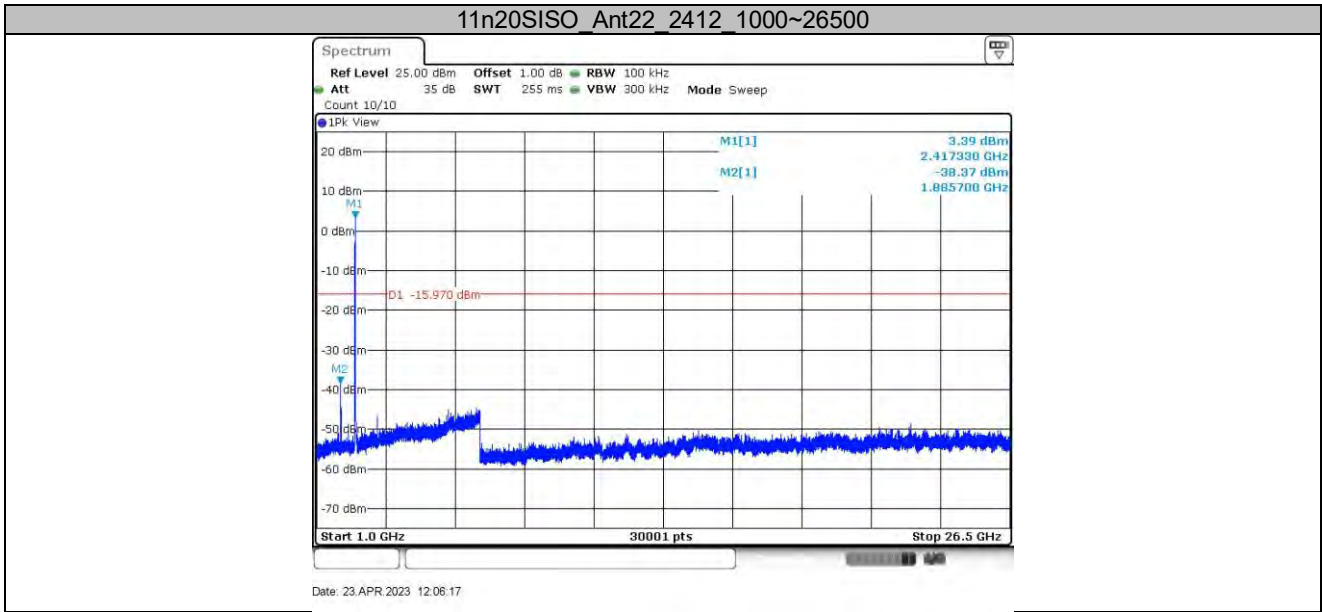
Attention: To check the authenticity of testing / inspection report & certificate, please contact us at telephone: (86-755) 8307 1443, or email: [CN\\_Doccheck@sgs.com](mailto:CN_Doccheck@sgs.com)  
 No. 1 Workshop, M-10, Middle Section, Science & Technology Park, Nanshan District, Shenzhen, Guangdong, China 518057 t (86-755) 26012053 www.sgs.com.cn  
 中国·广东·深圳市南山区科技园中区M-10栋1号厂房 邮编: 518057 t (86-755) 26012053 sgs.china@sgs.com





**SGS-CSTC Standards Technical Services Co., Ltd.**  
**Shenzhen Branch**

Report No.: ZEWM2303000343RG05  
 Page: 68 of 136



Unless otherwise agreed in writing, this document is issued by the Company subject to its General Conditions of Service printed overleaf, available on request or accessible at <https://www.sgs.com/en/Terms-and-Conditions>. Attention is drawn to the limitation of liability, indemnification and jurisdiction issues defined therein. Any holder of this document is advised that information contained hereon reflects the Company's findings at the time of its intervention only and within the limits of Client's instructions, if any. The Company's sole responsibility is to its Client and this document does not exonerate parties to a transaction from exercising all their rights and obligations under the transaction documents. This document cannot be reproduced except in full, without prior written approval of the Company. Any unauthorized alteration, forgery or falsification of the content or appearance of this document is unlawful and offenders may be prosecuted to the fullest extent of the law. Unless otherwise stated the results shown in this test report refer only to the sample(s) tested and such sample(s) are retained for 30 days only.

Attention: To check the authenticity of testing / inspection report & certificate, please contact us at telephone: (86-755) 8307 1443, or email: [CM\\_Doccheck@sgs.com](mailto:CM_Doccheck@sgs.com)

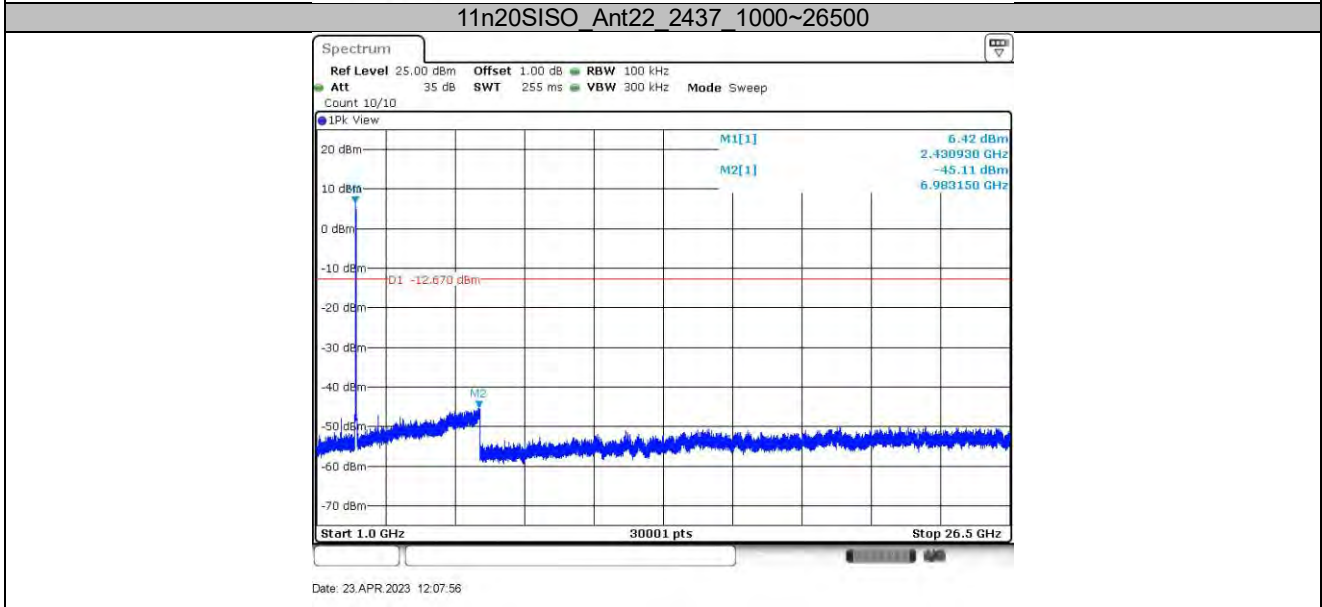
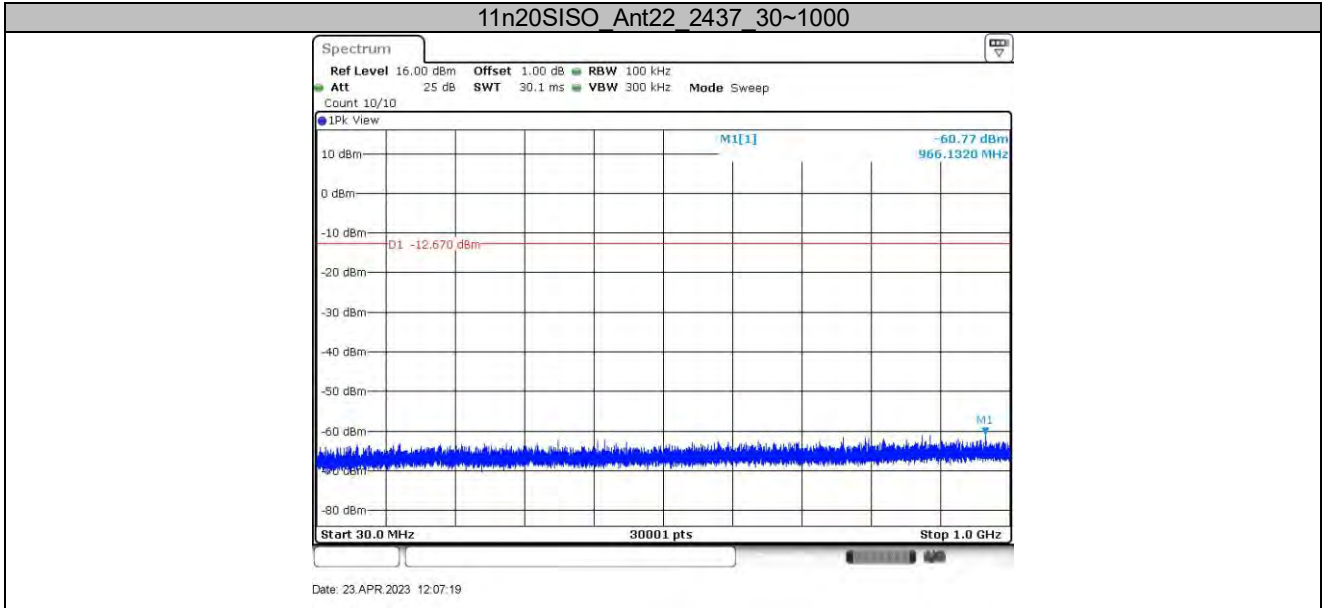
No. 1 Workshop, M-10, Middle Section, Science & Technology Park, Nanshan District, Shenzhen, Guangdong, China 518057 t (86-755) 26012053 www.sgs.com.cn  
 中国·广东·深圳市南山区科技园中区M-10栋1号厂房 邮编: 518057 t (86-755) 26012053 sgs.china@sgs.com





**SGS-CSTC Standards Technical Services Co., Ltd.**  
**Shenzhen Branch**

Report No.: ZEWM2303000343RG05  
 Page: 69 of 136



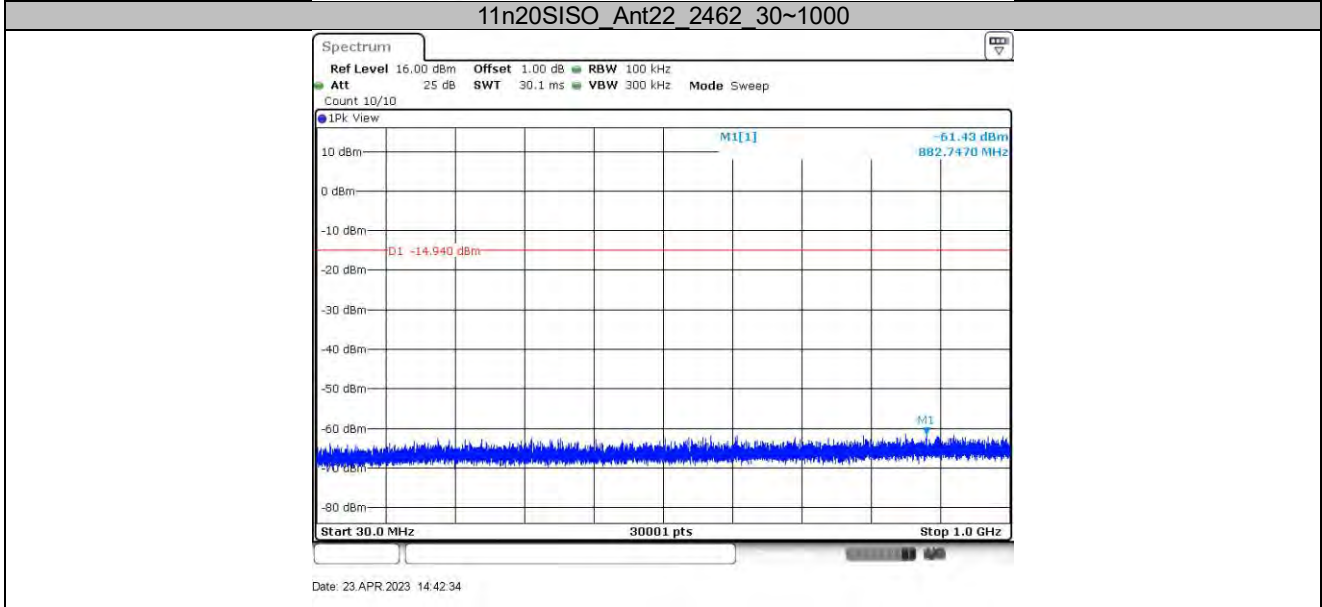
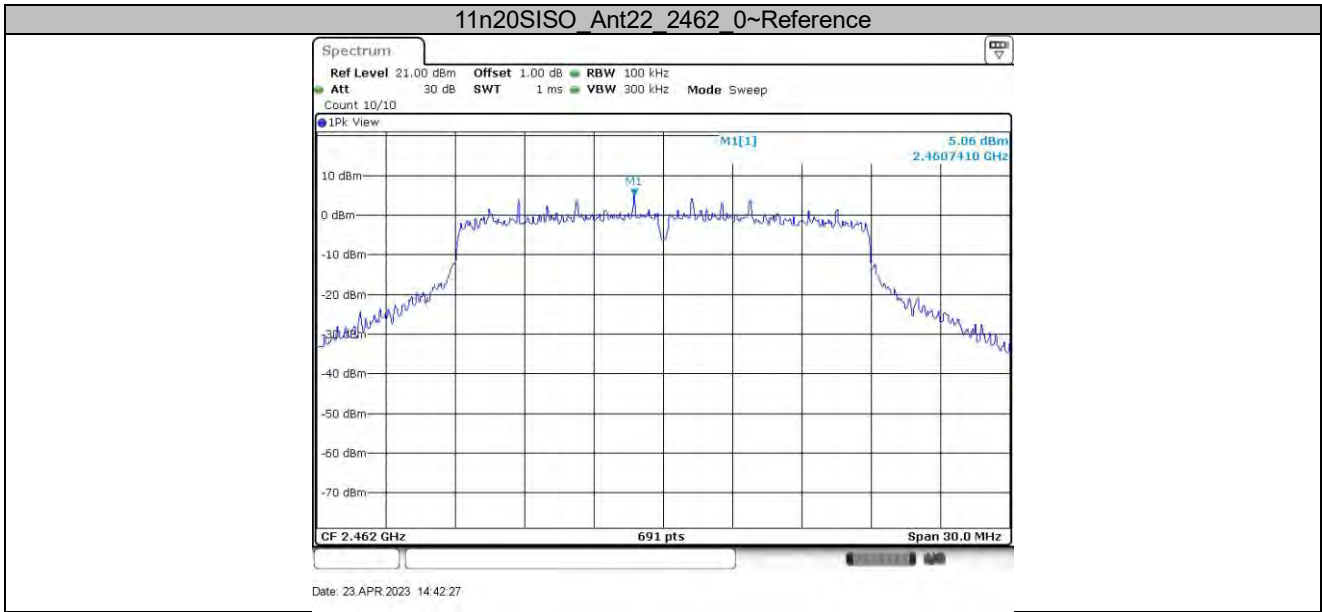
Unless otherwise agreed in writing, this document is issued by the Company subject to its General Conditions of Service printed overleaf, available on request or accessible at <https://www.sgs.com/en/Terms-and-Conditions>. Attention is drawn to the limitation of liability, indemnification and jurisdiction issues defined therein. Any holder of this document is advised that information contained hereon reflects the Company's findings at the time of its intervention only and within the limits of Client's instructions, if any. The Company's sole responsibility is to its Client and this document does not exonerate parties to a transaction from exercising all their rights and obligations under the transaction documents. This document cannot be reproduced except in full, without prior written approval of the Company. Any unauthorized alteration, forgery or falsification of the content or appearance of this document is unlawful and offenders may be prosecuted to the fullest extent of the law. Unless otherwise stated the results shown in this test report refer only to the sample(s) tested and such sample(s) are retained for 30 days only.

Attention: To check the authenticity of testing / inspection report & certificate, please contact us at telephone: (86-755) 8307 1443, or email: [CN\\_Doccheck@sgs.com](mailto:CN_Doccheck@sgs.com)  
 No. 1 Workshop, M-10, Middle Section, Science & Technology Park, Nanshan District, Shenzhen, Guangdong, China 518057 t (86-755) 26012053 www.sgs.com.cn  
 中国·广东·深圳市南山区科技园中区M-10栋1号厂房 邮编: 518057 t (86-755) 26012053 sgs.china@sgs.com



**SGS-CSTC Standards Technical Services Co., Ltd.**  
**Shenzhen Branch**

Report No.: ZEWM2303000343RG05  
 Page: 70 of 136



Unless otherwise agreed in writing, this document is issued by the Company subject to its General Conditions of Service printed overleaf, available on request or accessible at <https://www.sgs.com/en/Terms-and-Conditions>. Attention is drawn to the limitation of liability, indemnification and jurisdiction issues defined therein. Any holder of this document is advised that information contained hereon reflects the Company's findings at the time of its intervention only and within the limits of Client's instructions, if any. The Company's sole responsibility is to its Client and this document does not exonerate parties to a transaction from exercising all their rights and obligations under the transaction documents. This document cannot be reproduced except in full, without prior written approval of the Company. Any unauthorized alteration, forgery or falsification of the content or appearance of this document is unlawful and offenders may be prosecuted to the fullest extent of the law. Unless otherwise stated the results shown in this test report refer only to the sample(s) tested and such sample(s) are retained for 30 days only.

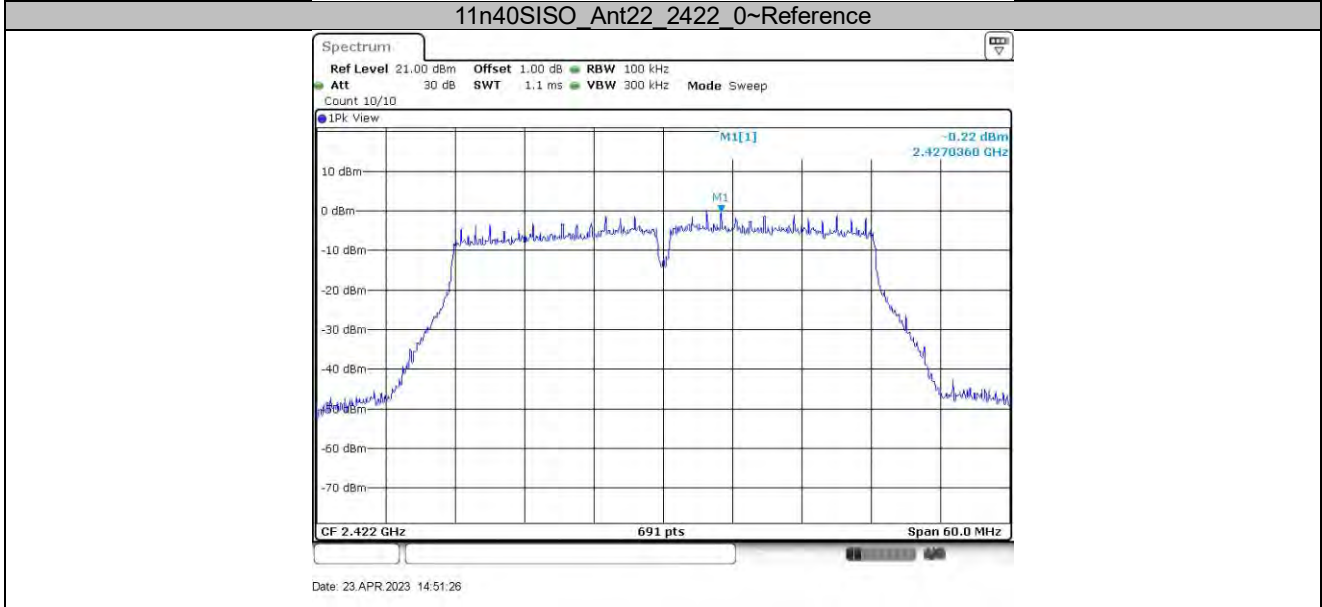
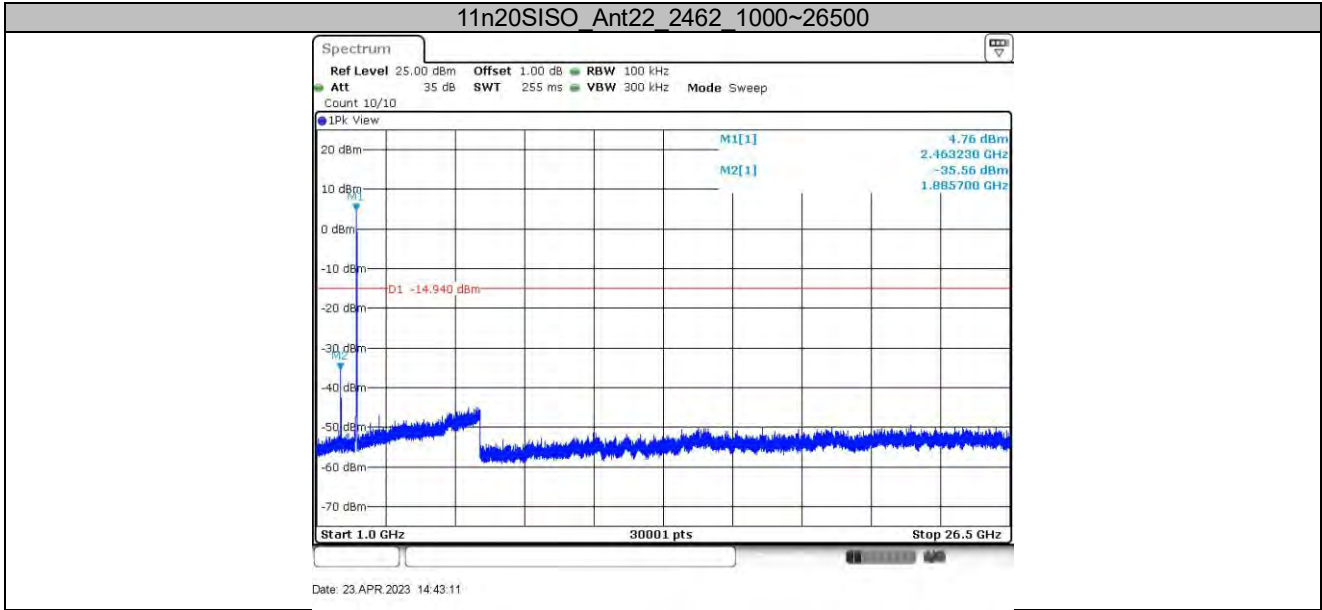
Attention: To check the authenticity of testing / inspection report & certificate, please contact us at telephone: (86-755) 8307 1443, or email: [CM.Doccheck@sgs.com](mailto:CM.Doccheck@sgs.com)

No. 1 Workshop, M-10, Middle Section, Science & Technology Park, Nanshan District, Shenzhen, Guangdong, China 518057 t (86-755) 26012053 www.sgs.com.cn  
 中国·广东·深圳市南山区科技园中区M-10栋1号厂房 邮编: 518057 t (86-755) 26012053 sgs.china@sgs.com



**SGS-CSTC Standards Technical Services Co., Ltd.**  
**Shenzhen Branch**

Report No.: ZEWM2303000343RG05  
 Page: 71 of 136



Unless otherwise agreed in writing, this document is issued by the Company subject to its General Conditions of Service printed overleaf, available on request or accessible at <https://www.sgs.com/en/Terms-and-Conditions>. Attention is drawn to the limitation of liability, indemnification and jurisdiction issues defined therein. Any holder of this document is advised that information contained hereon reflects the Company's findings at the time of its intervention only and within the limits of Client's instructions, if any. The Company's sole responsibility is to its Client and this document does not exonerate parties to a transaction from exercising all their rights and obligations under the transaction documents. This document cannot be reproduced except in full, without prior written approval of the Company. Any unauthorized alteration, forgery or falsification of the content or appearance of this document is unlawful and offenders may be prosecuted to the fullest extent of the law. Unless otherwise stated the results shown in this test report refer only to the sample(s) tested and such sample(s) are retained for 30 days only.

Attention: To check the authenticity of testing / inspection report & certificate, please contact us at telephone: (86-755) 8307 1443, or email: [CN\\_Doccheck@sgs.com](mailto:CN_Doccheck@sgs.com)

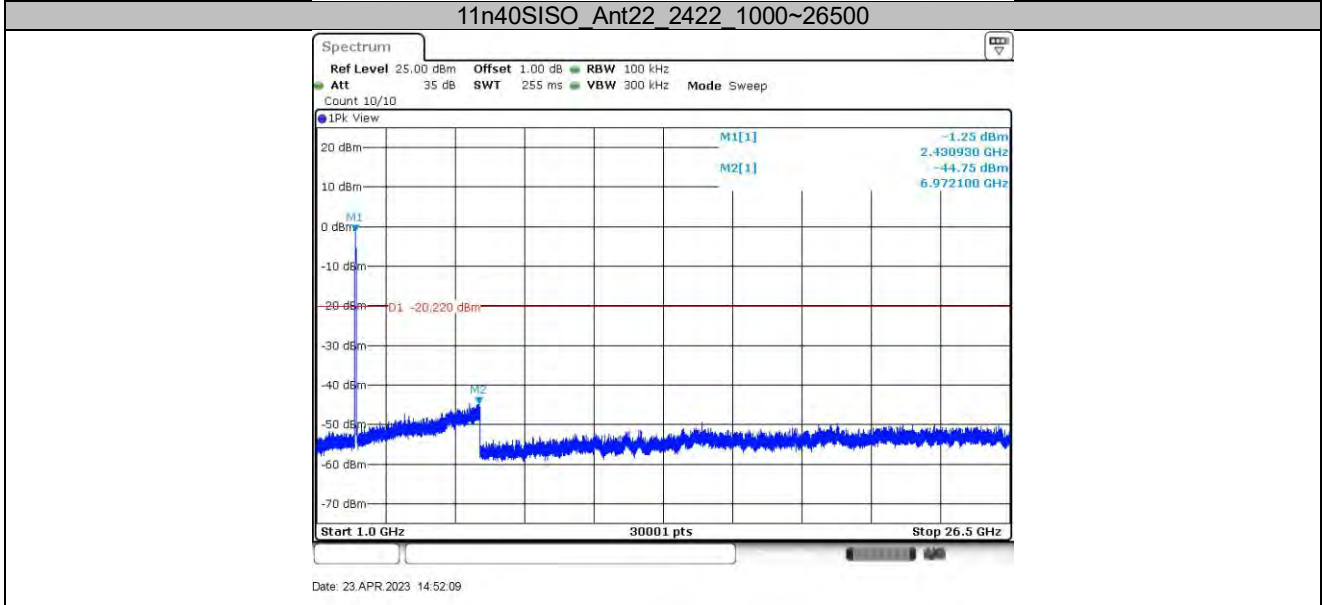
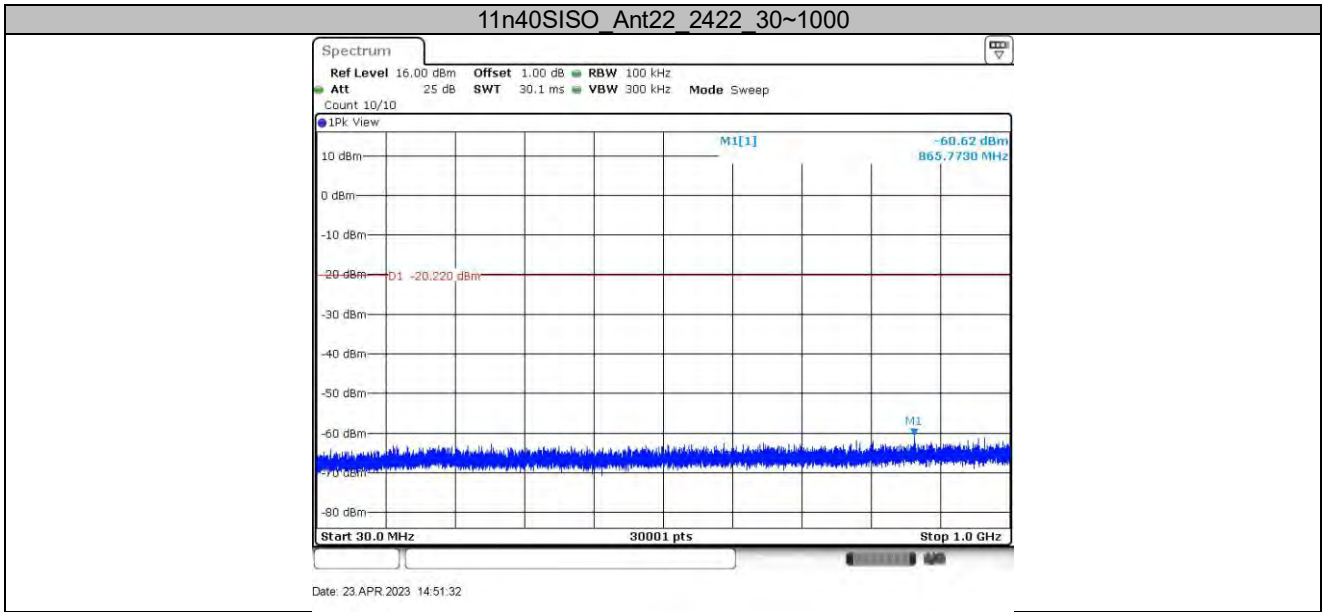
No. 1 Workshop, M-10, Middle Section, Science & Technology Park, Nanshan District, Shenzhen, Guangdong, China 518057 t (86-755) 26012053 www.sgsgroup.com.cn  
 中国·广东·深圳市南山区科技园中区M-10栋1号厂房 邮编: 518057 t (86-755) 26012053 sgs.china@sgs.com





**SGS-CSTC Standards Technical Services Co., Ltd.**  
**Shenzhen Branch**

Report No.: ZEWM2303000343RG05  
 Page: 72 of 136



Unless otherwise agreed in writing, this document is issued by the Company subject to its General Conditions of Service printed overleaf, available on request or accessible at <https://www.sgs.com/en/Terms-and-Conditions>. Attention is drawn to the limitation of liability, indemnification and jurisdiction issues defined therein. Any holder of this document is advised that information contained hereon reflects the Company's findings at the time of its intervention only and within the limits of Client's instructions, if any. The Company's sole responsibility is to its Client and this document does not exonerate parties to a transaction from exercising all their rights and obligations under the transaction documents. This document cannot be reproduced except in full, without prior written approval of the Company. Any unauthorized alteration, forgery or falsification of the content or appearance of this document is unlawful and offenders may be prosecuted to the fullest extent of the law. Unless otherwise stated the results shown in this test report refer only to the sample(s) tested and such sample(s) are retained for 30 days only.

Attention: To check the authenticity of testing / inspection report & certificate, please contact us at telephone: (86-755) 8307 1443, or email: [CN.Doccheck@sgs.com](mailto:CN.Doccheck@sgs.com)

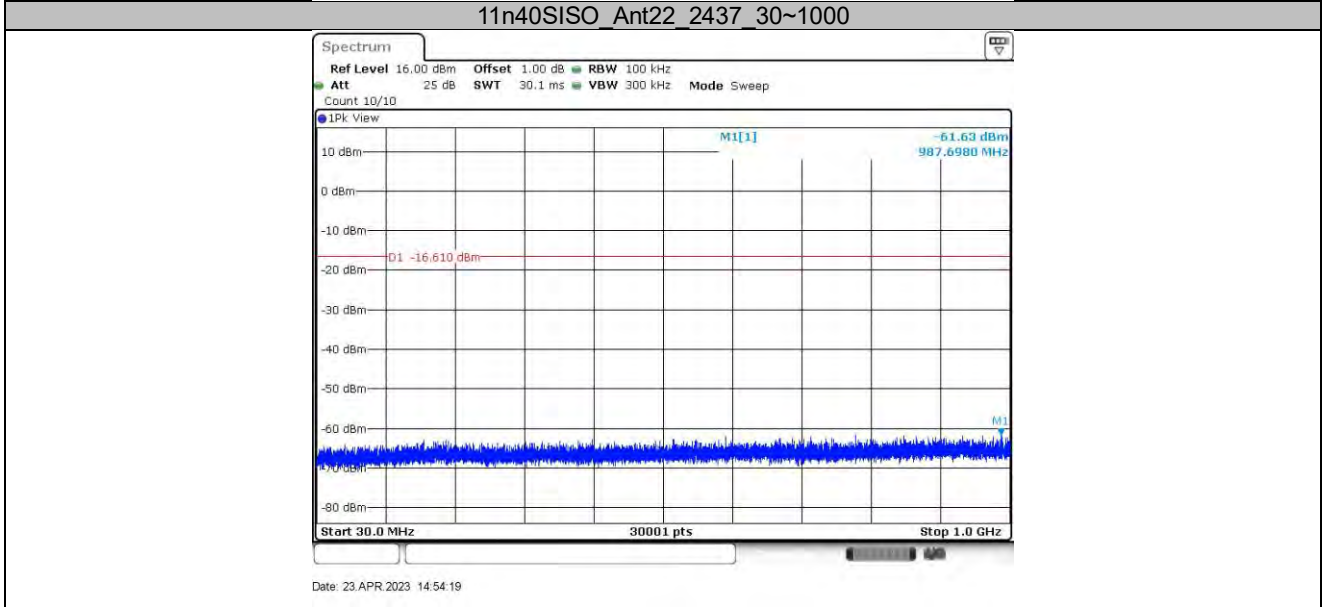
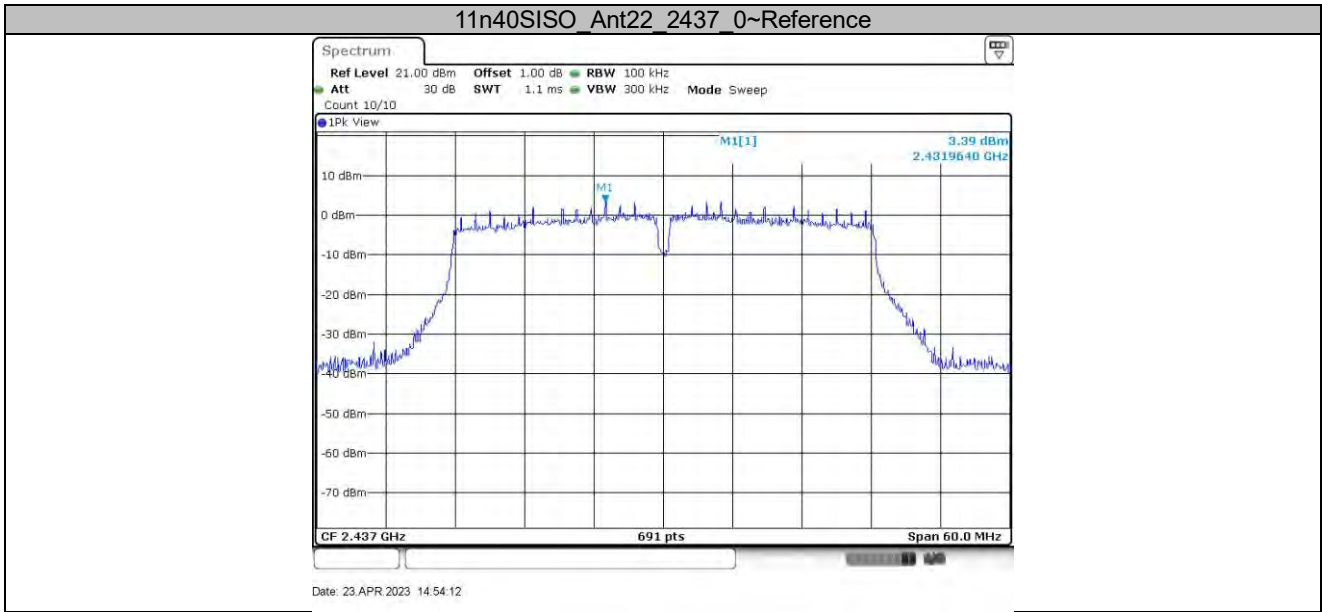
No. 1 Workshop, M-10, Middle Section, Science & Technology Park, Nanshan District, Shenzhen, Guangdong, China 518057 t (86-755) 26012053 www.sgsgroup.com.cn  
 中国·广东·深圳市南山区科技园中区M-10栋1号厂房 邮编: 518057 t (86-755) 26012053 sgs.china@sgs.com





**SGS-CSTC Standards Technical Services Co., Ltd.**  
**Shenzhen Branch**

Report No.: ZEWM2303000343RG05  
 Page: 73 of 136



Unless otherwise agreed in writing, this document is issued by the Company subject to its General Conditions of Service printed overleaf, available on request or accessible at <https://www.sgs.com/en/Terms-and-Conditions>. Attention is drawn to the limitation of liability, indemnification and jurisdiction issues defined therein. Any holder of this document is advised that information contained hereon reflects the Company's findings at the time of its intervention only and within the limits of Client's instructions, if any. The Company's sole responsibility is to its Client and this document does not exonerate parties to a transaction from exercising all their rights and obligations under the transaction documents. This document cannot be reproduced except in full, without prior written approval of the Company. Any unauthorized alteration, forgery or falsification of the content or appearance of this document is unlawful and offenders may be prosecuted to the fullest extent of the law. Unless otherwise stated the results shown in this test report refer only to the sample(s) tested and such sample(s) are retained for 30 days only.

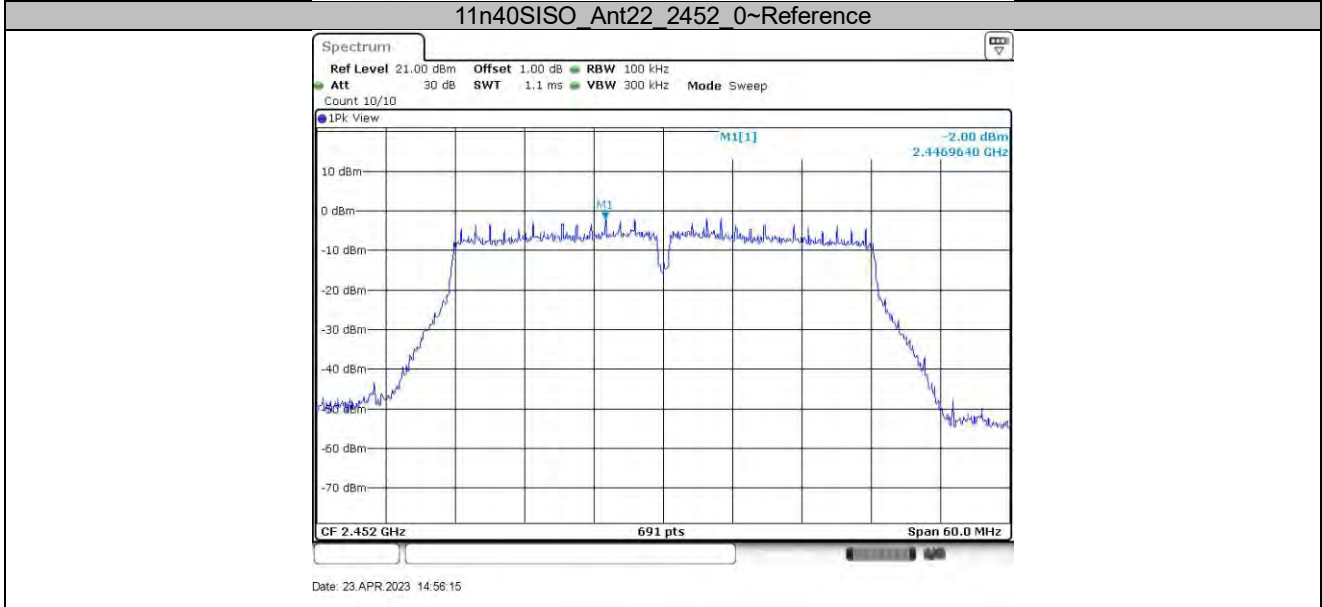
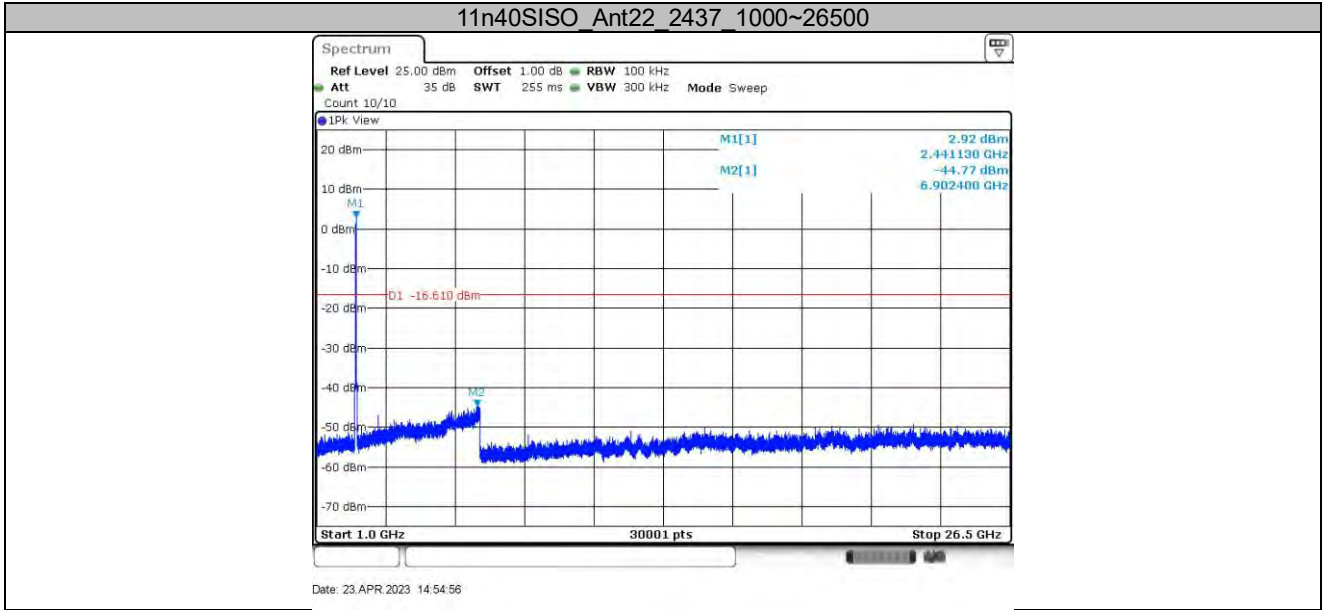
Attention: To check the authenticity of testing / inspection report & certificate, please contact us at telephone: (86-755)8307 1443, or email: [CM\\_Doccheck@sgs.com](mailto:CM_Doccheck@sgs.com)

No.1 Workshop, M-10, Middle Section, Science & Technology Park, Nanshan District, Shenzhen, Guangdong, China 518057 t (86-755) 26012053 www.sgs.com.cn  
 中国·广东·深圳市南山区科技园中区M-10栋1号厂房 邮编: 518057 t (86-755) 26012053 sgs.china@sgs.com



**SGS-CSTC Standards Technical Services Co., Ltd.**  
**Shenzhen Branch**

Report No.: ZEWM2303000343RG05  
 Page: 74 of 136



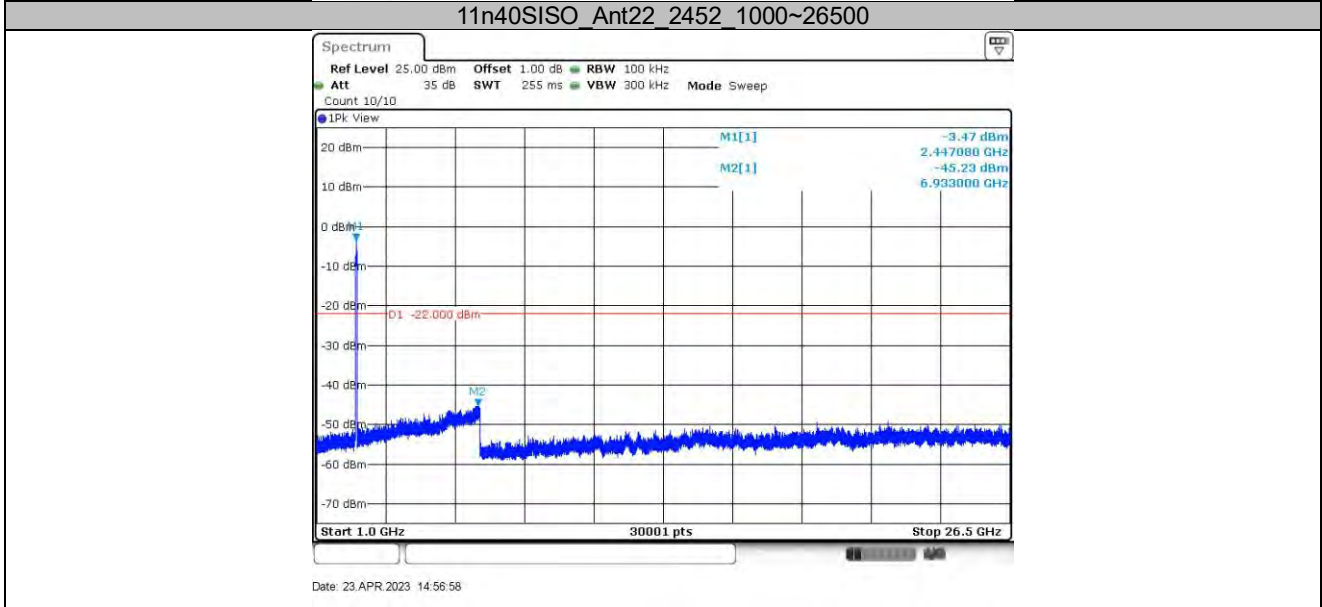
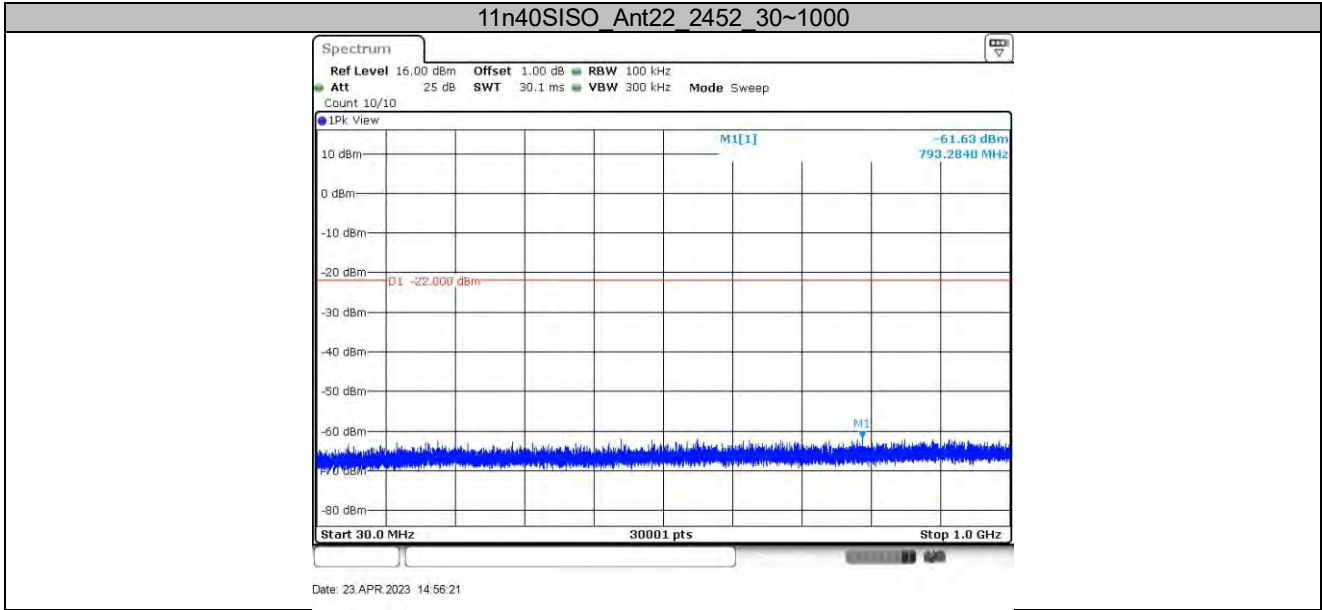
Unless otherwise agreed in writing, this document is issued by the Company subject to its General Conditions of Service printed overleaf, available on request or accessible at <https://www.sgs.com/en/Terms-and-Conditions>. Attention is drawn to the limitation of liability, indemnification and jurisdiction issues defined therein. Any holder of this document is advised that information contained hereon reflects the Company's findings at the time of its intervention only and within the limits of Client's instructions, if any. The Company's sole responsibility is to its Client and this document does not exonerate parties to a transaction from exercising all their rights and obligations under the transaction documents. This document cannot be reproduced except in full, without prior written approval of the Company. Any unauthorized alteration, forgery or falsification of the content or appearance of this document is unlawful and offenders may be prosecuted to the fullest extent of the law. Unless otherwise stated the results shown in this test report refer only to the sample(s) tested and such sample(s) are retained for 30 days only.

Attention: To check the authenticity of testing / inspection report & certificate, please contact us at telephone: (86-755) 8307 1443, or email: [CM.Doccheck@sgs.com](mailto:CM.Doccheck@sgs.com)  
 No. 1 Workshop, M-10, Middle Section, Science & Technology Park, Nanshan District, Shenzhen, Guangdong, China 518057 t (86-755) 26012053 www.sgsgroup.com.cn  
 中国·广东·深圳市南山区科技园中区M-10栋1号厂房 邮编: 518057 t (86-755) 26012053 sgs.china@sgs.com



**SGS-CSTC Standards Technical Services Co., Ltd.**  
**Shenzhen Branch**

Report No.: ZEWM2303000343RG05  
 Page: 75 of 136



Unless otherwise agreed in writing, this document is issued by the Company subject to its General Conditions of Service printed overleaf, available on request or accessible at <https://www.sgs.com/en/Terms-and-Conditions>. Attention is drawn to the limitation of liability, indemnification and jurisdiction issues defined therein. Any holder of this document is advised that information contained hereon reflects the Company's findings at the time of its intervention only and within the limits of Client's instructions, if any. The Company's sole responsibility is to its Client and this document does not exonerate parties to a transaction from exercising all their rights and obligations under the transaction documents. This document cannot be reproduced except in full, without prior written approval of the Company. Any unauthorized alteration, forgery or falsification of the content or appearance of this document is unlawful and offenders may be prosecuted to the fullest extent of the law. Unless otherwise stated the results shown in this test report refer only to the sample(s) tested and such sample(s) are retained for 30 days only.

Attention: To check the authenticity of testing / inspection report & certificate, please contact us at telephone: (86-755) 8307 1443, or email: [CM.Doccheck@sgs.com](mailto:CM.Doccheck@sgs.com)

No. 1 Workshop, M-10, Middle Section, Science & Technology Park, Nanshan District, Shenzhen, Guangdong, China 518057 t (86-755) 26012053 www.sgs.com.cn  
 中国·广东·深圳市南山区科技园中区M-10栋1号厂房 邮编: 518057 t (86-755) 26012053 sgs.china@sgs.com



# SGS-CSTC Standards Technical Services Co., Ltd. Shenzhen Branch

Report No.: ZEWM2303000343RG05  
Page: 76 of 136

## Duty Cycle Test Result

TestMode	Antenna	Channel	Transmission Duration [ms]	Transmission Period [ms]	Duty Cycle [%]
11b	Ant22	2412	12.22	12.40	98.55
11g	Ant22	2412	2.03	2.07	98.07
11n20SISO	Ant22	2412	1.89	1.93	97.93
11n40SISO	Ant22	2422	0.93	0.98	94.90

Note:

Radiated Emission Average VBW = 1 / T

TestMode	T[ms]	Period[ms]	Duty Cycle[%]	1/T[kHz]	VBW Setting
11b	12.21	12.40	98.55	0.08190	10Hz
11g	2.03	2.07	98.07	0.49236	10Hz
11n20SISO	1.89	1.93	97.93	0.52910	10Hz
11n40SISO	0.92	0.98	94.90	1.07561	1.1KHz



Unless otherwise agreed in writing, this document is issued by the Company subject to its General Conditions of Service printed overleaf, available on request or accessible at <https://www.sgs.com/en/Terms-and-Conditions>. Attention is drawn to the limitation of liability, indemnification and jurisdiction issues defined therein. Any holder of this document is advised that information contained hereon reflects the Company's findings at the time of its intervention only and within the limits of Client's instructions, if any. The Company's sole responsibility is to its Client and this document does not exonerate parties to a transaction from exercising all their rights and obligations under the transaction documents. This document cannot be reproduced except in full, without prior written approval of the Company. Any unauthorized alteration, forgery or falsification of the content or appearance of this document is unlawful and offenders may be prosecuted to the fullest extent of the law. Unless otherwise stated the results shown in this test report refer only to the sample(s) tested and such sample(s) are retained for 30 days only.

Attention: To check the authenticity of testing / inspection report & certificate, please contact us at telephone: (86-755) 8307 1443, or email: [CN\\_Doccheck@sgs.com](mailto:CN_Doccheck@sgs.com)

No. 1 Workshop, M-10, Middle Section, Science & Technology Park, Nanshan District, Shenzhen, Guangdong, China 518057 t (86-755) 26012053 www.sgs.com.cn  
中国·广东·深圳市南山区科技园中区M-10栋1号厂房 邮编: 518057 t (86-755) 26012053 sgs.china@sgs.com

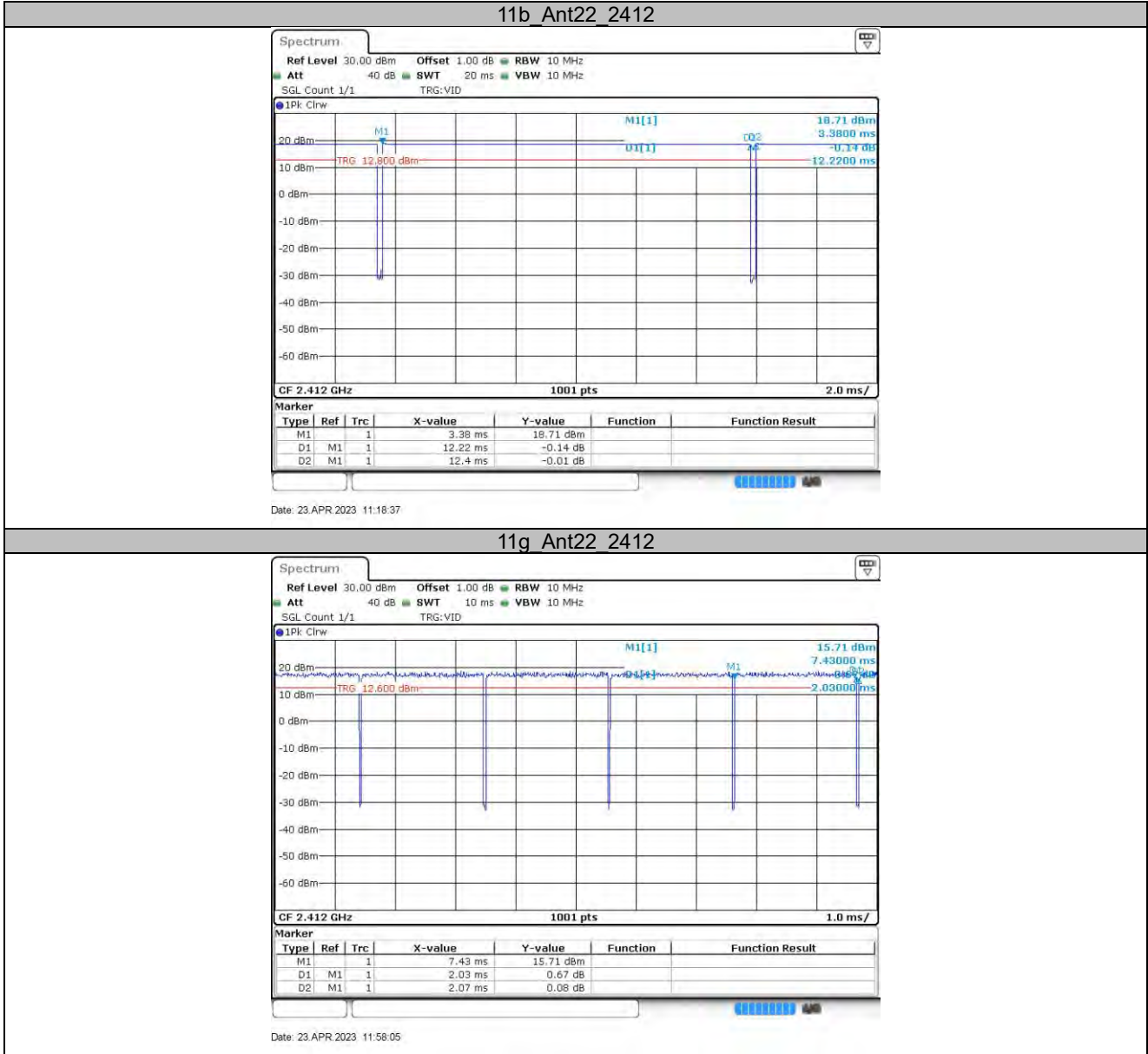




**SGS-CSTC Standards Technical Services Co., Ltd.**  
**Shenzhen Branch**

Report No.: ZEWM2303000343RG05  
 Page: 77 of 136

**Test Graphs**



Unless otherwise agreed in writing, this document is issued by the Company subject to its General Conditions of Service printed overleaf, available on request or accessible at <https://www.sgs.com/en/Terms-and-Conditions>. Attention is drawn to the limitation of liability, indemnification and jurisdiction issues defined therein. Any holder of this document is advised that information contained hereon reflects the Company's findings at the time of its intervention only and within the limits of Client's instructions, if any. The Company's sole responsibility is to its Client and this document does not exonerate parties to a transaction from exercising all their rights and obligations under the transaction documents. This document cannot be reproduced except in full, without prior written approval of the Company. Any unauthorized alteration, forgery or falsification of the content or appearance of this document is unlawful and offenders may be prosecuted to the fullest extent of the law. Unless otherwise stated the results shown in this test report refer only to the sample(s) tested and such sample(s) are retained for 30 days only.

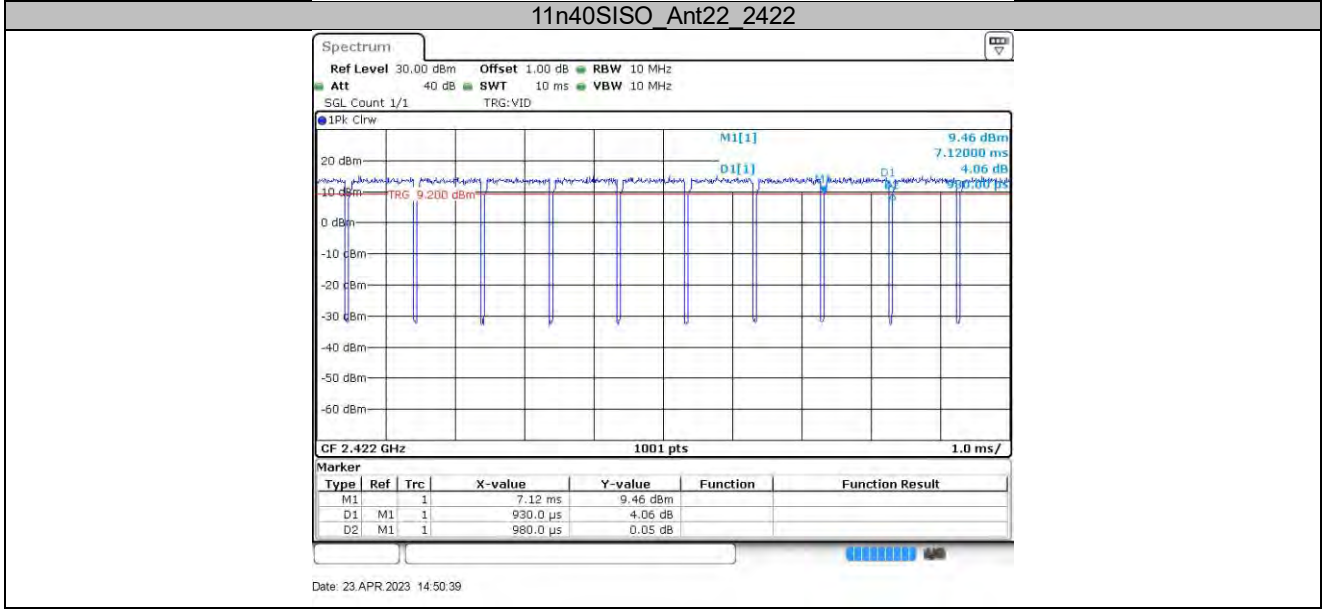
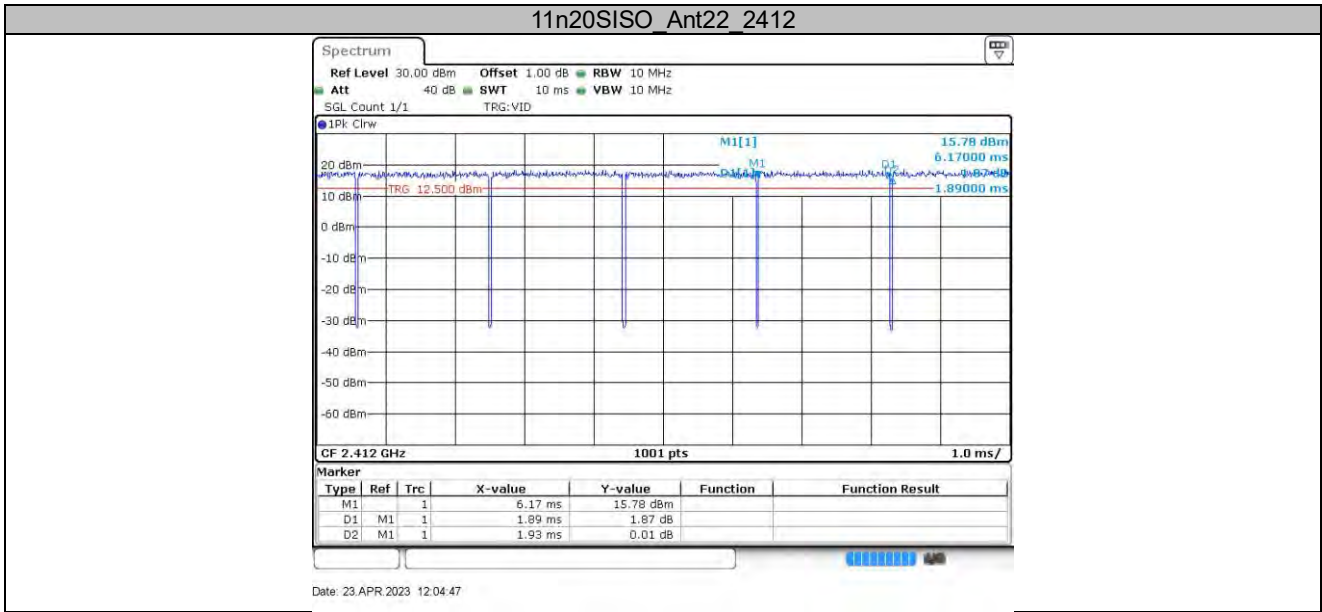
Attention: To check the authenticity of testing / inspection report & certificate, please contact us at telephone: (86-755) 8307 1443, or email: [CN.Doccheck@sgs.com](mailto:CN.Doccheck@sgs.com)

No. 1 Workshop, M-10, Middle Section, Science & Technology Park, Nanshan District, Shenzhen, Guangdong, China 518057 t (86-755) 26012053 www.sgsgroup.com.cn  
 中国·广东·深圳市南山区科技园中区M-10栋1号厂房 邮编: 518057 t (86-755) 26012053 sgs.china@sgs.com



**SGS-CSTC Standards Technical Services Co., Ltd.**  
**Shenzhen Branch**

Report No.: ZEWM2303000343RG05  
 Page: 78 of 136



Unless otherwise agreed in writing, this document is issued by the Company subject to its General Conditions of Service printed overleaf, available on request or accessible at <https://www.sgs.com/en/Terms-and-Conditions>. Attention is drawn to the limitation of liability, indemnification and jurisdiction issues defined therein. Any holder of this document is advised that information contained hereon reflects the Company's findings at the time of its intervention only and within the limits of Client's instructions, if any. The Company's sole responsibility is to its Client and this document does not exonerate parties to a transaction from exercising all their rights and obligations under the transaction documents. This document cannot be reproduced except in full, without prior written approval of the Company. Any unauthorized alteration, forgery or falsification of the content or appearance of this document is unlawful and offenders may be prosecuted to the fullest extent of the law. Unless otherwise stated the results shown in this test report refer only to the sample(s) tested and such sample(s) are retained for 30 days only.

Attention: To check the authenticity of testing / inspection report & certificate, please contact us at telephone: (86-755) 8307 1443, or email: [CN.Doccheck@sgs.com](mailto:CN.Doccheck@sgs.com)

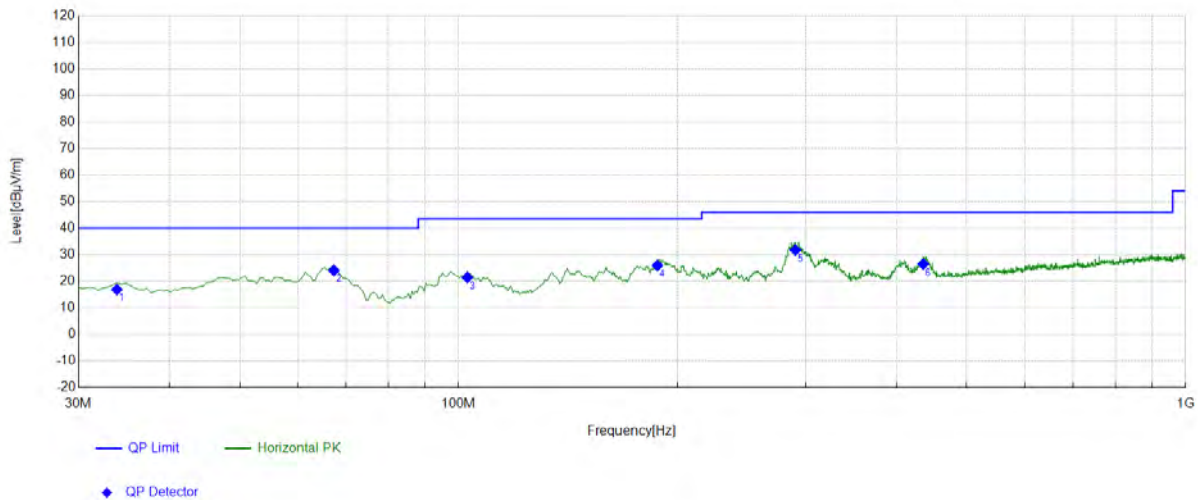
No.1 Workshop, M-10, Middle Section, Science & Technology Park, Nanshan District, Shenzhen, Guangdong, China 518057 t (86-755) 26012053 www.sgsgroup.com.cn  
 中国·广东·深圳市南山区科技园中区M-10栋1号厂房 邮编: 518057 t (86-755) 26012053 sgs.china@sgs.com



## Radiated Spurious Emissions

### Radiated emission below 1GHz

#### Worst case Mode: 802.11b\_Channel 1



Final Data List										
NO.	Freq. [MHz]	AF[dB/m]	Factor [dB]	QP Reading[dBμV]	QP Value [dBμV/m]	QP Limit [dBμV/m]	QP Margin [dB]	Height [cm]	Angle [°]	Polarity
1	33.8819	11.30	-28.00	33.56	16.86	40.00	23.14	344	287	Horizontal
2	67.3637	10.63	-27.51	40.95	24.07	40.00	15.93	322	159	Horizontal
3	102.7864	11.72	-27.12	36.81	21.41	43.50	22.09	380	141	Horizontal
4	187.7039	10.01	-26.64	42.55	25.92	43.50	17.58	120	236	Horizontal
5	290.5753	13.13	-25.67	44.3	31.76	46.00	14.24	119	144	Horizontal
6	435.6628	16.37	-25.20	35.29	26.46	46.00	19.54	102	57	Horizontal



Unless otherwise agreed in writing, this document is issued by the Company subject to its General Conditions of Service printed overleaf, available on request or accessible at <https://www.sgs.com/en/Terms-and-Conditions>. Attention is drawn to the limitation of liability, indemnification and jurisdiction issues defined therein. Any holder of this document is advised that information contained hereon reflects the Company's findings at the time of its intervention only and within the limits of Client's instructions, if any. The Company's sole responsibility is to its Client and this document does not exonerate parties to a transaction from exercising all their rights and obligations under the transaction documents. This document cannot be reproduced except in full, without prior written approval of the Company. Any unauthorized alteration, forgery or falsification of the content or appearance of this document is unlawful and offenders may be prosecuted to the fullest extent of the law. Unless otherwise stated the results shown in this test report refer only to the sample(s) tested and such sample(s) are retained for 30 days only.

Attention: To check the authenticity of testing / inspection report & certificate, please contact us at telephone: (86-755) 8307 1443, or email: [CN\\_Doccheck@sgs.com](mailto:CN_Doccheck@sgs.com)

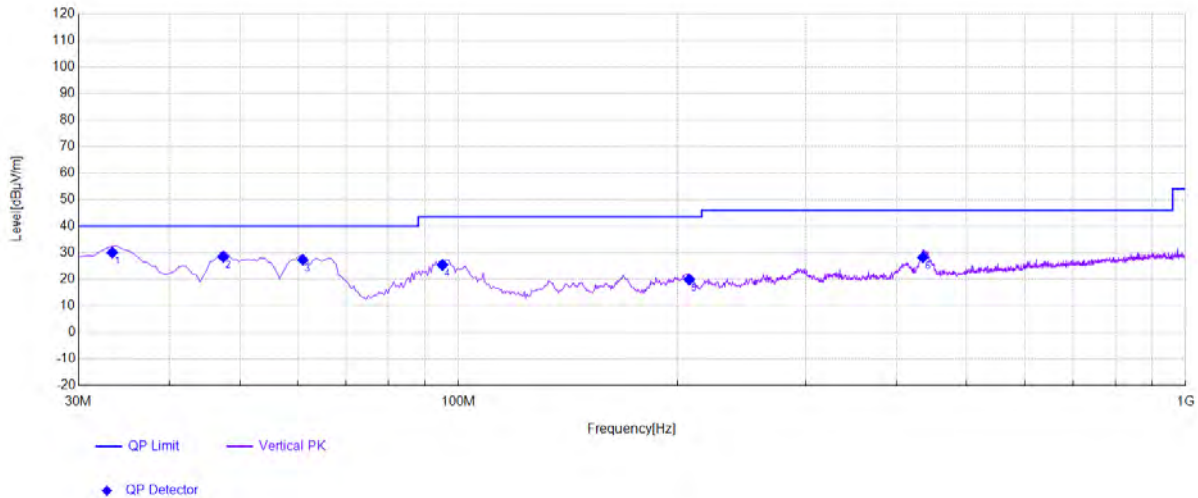
No. 1 Workshop, M-10, Middle Section, Science & Technology Park, Nanshan District, Shenzhen, Guangdong, China 518057 t (86-755) 26012053 www.sgs.com.cn  
 中国·广东·深圳市南山区科技园中区M-10栋1号厂房 邮编: 518057 t (86-755) 26012053 sgs.china@sgs.com





# SGS-CSTC Standards Technical Services Co., Ltd. Shenzhen Branch

Report No.: ZEWM2303000343RG05  
Page: 80 of 136



Final Data List										
NO.	Freq. [MHz]	AF[dB/m]	Factor [dB]	QP Reading[dBµV]	QP Value [dBµV/m]	QP Limit [dBµV/m]	QP Margin [dB]	Height [cm]	Angle [°]	Polarity
1	33.3967	11.30	-28.00	46.76	30.06	40.00	9.94	138	81	Vertical
2	47.4687	14.07	-27.77	42.11	28.41	40.00	11.59	141	13	Vertical
3	61.0555	12.28	-27.90	42.94	27.32	40.00	12.68	163	4	Vertical
4	95.0225	11.00	-27.36	41.73	25.37	43.50	18.13	172	114	Vertical
5	207.5988	11.20	-26.75	35.42	19.87	43.50	23.63	189	358	Vertical
6	435.1776	16.39	-25.20	37.08	28.27	46.00	17.73	135	248	Vertical

### Remark:

- The field strength is calculated by adding the Antenna Factor, Cable Factor & Preamplifier gain. The basic equation with a sample calculation is as follows:  

$$\text{Value} = \text{Reading}(\text{dB}\mu\text{V}) + \text{AF}(\text{dB}/\text{m}) + \text{Factor}(\text{dB})$$

$$\text{AF} = \text{Antenna Factor}(\text{dB}/\text{m})$$

$$\text{Factor} = \text{Cable Factor}(\text{dB}) - \text{Preamplifier gain}(\text{dB})$$

$$\text{Margin} = \text{Limit}(\text{dB}\mu\text{V}/\text{m}) - \text{Value}(\text{dB}\mu\text{V}/\text{m})$$
- All channels have been tested, but only the worst case data displayed in this report.

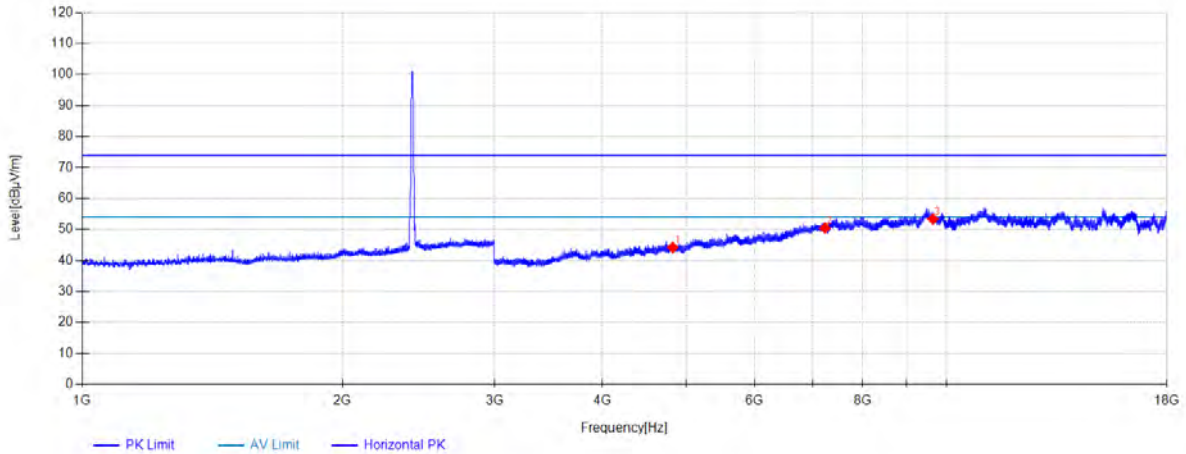


Unless otherwise agreed in writing, this document is issued by the Company subject to its General Conditions of Service printed overleaf, available on request or accessible at <https://www.sgs.com/en/Terms-and-Conditions>. Attention is drawn to the limitation of liability, indemnification and jurisdiction issues defined therein. Any holder of this document is advised that information contained hereon reflects the Company's findings at the time of its intervention only and within the limits of Client's instructions, if any. The Company's sole responsibility is to its Client and this document does not exonerate parties to a transaction from exercising all their rights and obligations under the transaction documents. This document cannot be reproduced except in full, without prior written approval of the Company. Any unauthorized alteration, forgery or falsification of the content or appearance of this document is unlawful and offenders may be prosecuted to the fullest extent of the law. Unless otherwise stated the results shown in this test report refer only to the sample(s) tested and such sample(s) are retained for 30 days only.

Attention: To check the authenticity of testing / inspection report & certificate, please contact us at telephone: (86-755) 8307 1443, or email: [CM\\_Doccheck@sgs.com](mailto:CM_Doccheck@sgs.com)

No. 1 Workshop, M-10, Middle Section, Science & Technology Park, Nanshan District, Shenzhen, Guangdong, China 518057 t (86-755) 26012053 www.sgs.com.cn  
中国·广东·深圳市南山区科技园中区M-10栋1号厂房 邮编: 518057 t (86-755) 26012053 sgs.china@sgs.com




**Transmitter emission Above 1GHz**  
**802.11b\_Channel 1**


Final Data List										
NO.	Frequency [MHz]	Reading [dBμV]	AF[dB/m]	Factor [dB]	Level [dBμV/m]	Limit [dBμV/m]	Margin [dB]	Height [cm]	Angle [°]	Polarity
1	4824	56.44	30.70	-42.93	44.21	74.00	29.79	173	234	Horizontal
2	7236	52.87	36.38	-38.77	50.48	74.00	23.52	150	277	Horizontal
3	9648	51.27	38.09	-35.97	53.39	74.00	20.61	196	23	Horizontal



Unless otherwise agreed in writing, this document is issued by the Company subject to its General Conditions of Service printed overleaf, available on request or accessible at <https://www.sgs.com/en/Terms-and-Conditions>. Attention is drawn to the limitation of liability, indemnification and jurisdiction issues defined therein. Any holder of this document is advised that information contained hereon reflects the Company's findings at the time of its intervention only and within the limits of Client's instructions, if any. The Company's sole responsibility is to its Client and this document does not exonerate parties to a transaction from exercising all their rights and obligations under the transaction documents. This document cannot be reproduced except in full, without prior written approval of the Company. Any unauthorized alteration, forgery or falsification of the content or appearance of this document is unlawful and offenders may be prosecuted to the fullest extent of the law. Unless otherwise stated the results shown in this test report refer only to the sample(s) tested and such sample(s) are retained for 30 days only.

Attention: To check the authenticity of testing / inspection report & certificate, please contact us at telephone: (86-755) 8307 1443, or email: [CN.Doccheck@sgs.com](mailto:CN.Doccheck@sgs.com)

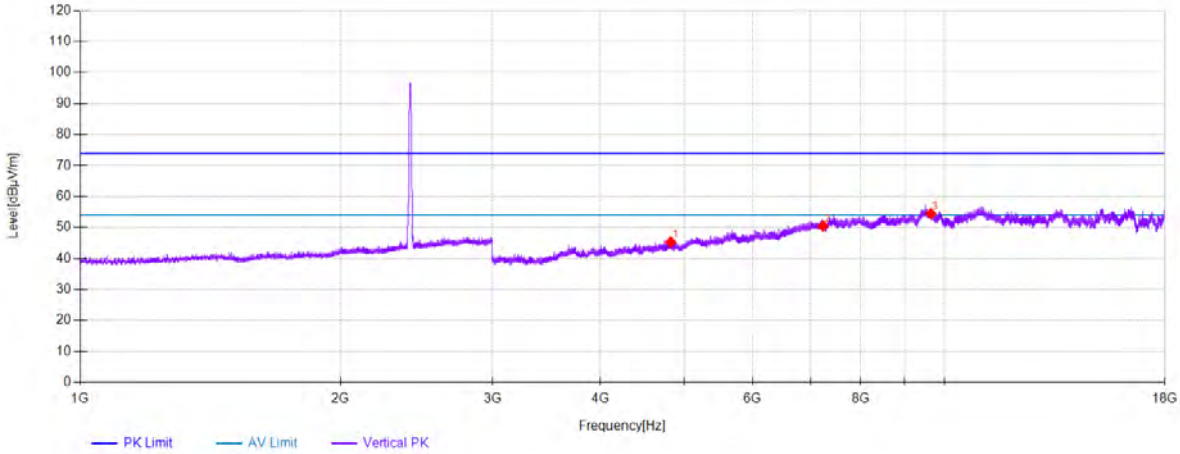
No. 1 Workshop, M-10, Middle Section, Science & Technology Park, Nanshan District, Shenzhen, Guangdong, China 518057 t (86-755) 26012053 www.sgs.com.cn  
 中国·广东·深圳市南山区科技园中区M-10栋1号厂房 邮编: 518057 t (86-755) 26012053 sgs.china@sgs.com



**SGS-CSTC Standards Technical Services Co., Ltd.**  
**Shenzhen Branch**

Report No.: ZEWM2303000343RG05  
 Page: 82 of 136

**802.11b\_Channel 1**



Final Data List										
NO.	Frequency [MHz]	Reading [dBµV]	AF[dB/m]	Factor [dB]	Level [dBµV/m]	Limit [dBµV/m]	Margin [dB]	Height [cm]	Angle [°]	Polarity
1	4824	57.54	30.70	-42.93	45.31	74.00	28.69	345	77	Vertical
2	7236	52.87	36.38	-38.77	50.48	74.00	23.52	245	329	Vertical
3	9648	52.34	38.09	-35.97	54.46	74.00	19.54	287	55	Vertical



Unless otherwise agreed in writing, this document is issued by the Company subject to its General Conditions of Service printed overleaf, available on request or accessible at <https://www.sgs.com/en/Terms-and-Conditions>. Attention is drawn to the limitation of liability, indemnification and jurisdiction issues defined therein. Any holder of this document is advised that information contained hereon reflects the Company's findings at the time of its intervention only and within the limits of Client's instructions, if any. The Company's sole responsibility is to its Client and this document does not exonerate parties to a transaction from exercising all their rights and obligations under the transaction documents. This document cannot be reproduced except in full, without prior written approval of the Company. Any unauthorized alteration, forgery or falsification of the content or appearance of this document is unlawful and offenders may be prosecuted to the fullest extent of the law. Unless otherwise stated the results shown in this test report refer only to the sample(s) tested and such sample(s) are retained for 30 days only.

Attention: To check the authenticity of testing / inspection report & certificate, please contact us at telephone: (86-755) 8307 1443, or email: [CN.Doccheck@sgs.com](mailto:CN.Doccheck@sgs.com)

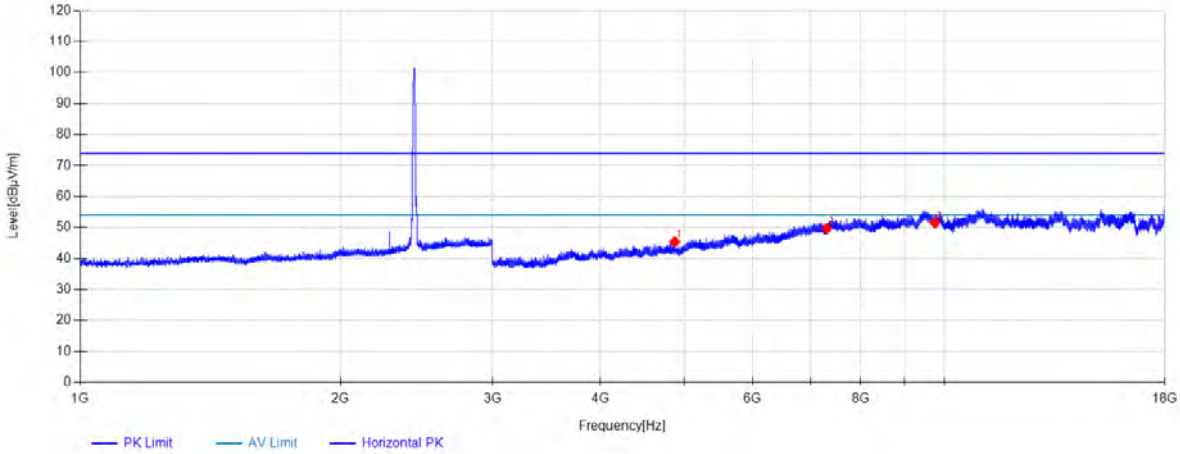
No. 1 Workshop, M-10, Middle Section, Science & Technology Park, Nanshan District, Shenzhen, Guangdong, China 518057 t (86-755) 26012053 www.sgs.com.cn  
 中国·广东·深圳市南山区科技园中区M-10栋1号厂房 邮编: 518057 t (86-755) 26012053 sgs.china@sgs.com



**SGS-CSTC Standards Technical Services Co., Ltd.**  
**Shenzhen Branch**

Report No.: ZEWM2303000343RG05  
 Page: 83 of 136

**802.11b\_Channel 6**



Final Data List										
NO.	Frequency [MHz]	Reading [dBµV]	AF[dB/m]	Factor [dB]	Level [dBµV/m]	Limit [dBµV/m]	Margin [dB]	Height [cm]	Angle [°]	Polarity
1	4874	57.55	30.74	-42.90	45.39	74.00	28.61	125	39	Horizontal
2	7311	52.07	36.42	-38.81	49.68	74.00	24.32	212	49	Horizontal
3	9748	49.39	38.30	-36.04	51.65	74.00	22.35	189	156	Horizontal



Unless otherwise agreed in writing, this document is issued by the Company subject to its General Conditions of Service printed overleaf, available on request or accessible at <https://www.sgs.com/en/Terms-and-Conditions>. Attention is drawn to the limitation of liability, indemnification and jurisdiction issues defined therein. Any holder of this document is advised that information contained hereon reflects the Company's findings at the time of its intervention only and within the limits of Client's instructions, if any. The Company's sole responsibility is to its Client and this document does not exonerate parties to a transaction from exercising all their rights and obligations under the transaction documents. This document cannot be reproduced except in full, without prior written approval of the Company. Any unauthorized alteration, forgery or falsification of the content or appearance of this document is unlawful and offenders may be prosecuted to the fullest extent of the law. Unless otherwise stated the results shown in this test report refer only to the sample(s) tested and such sample(s) are retained for 30 days only.

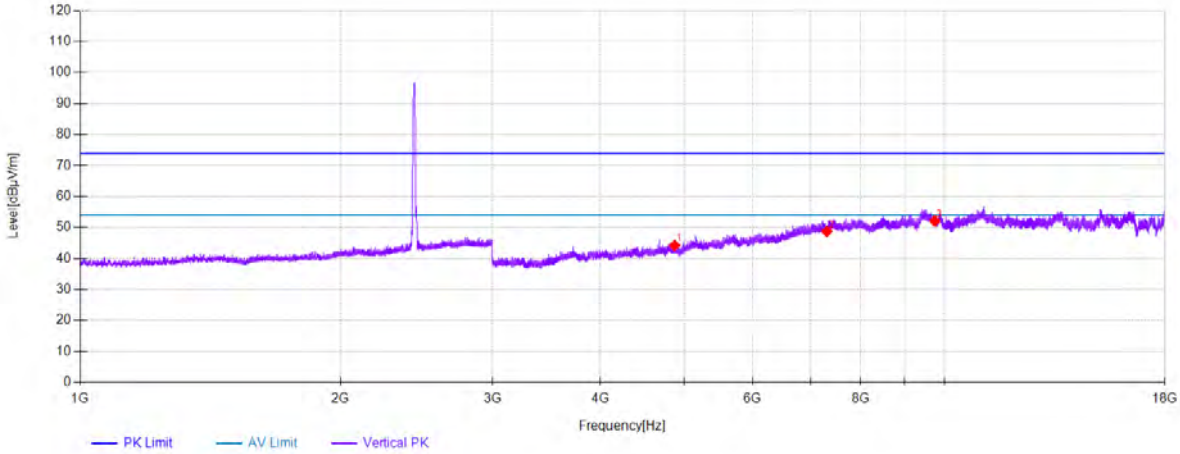
Attention: To check the authenticity of testing / inspection report & certificate, please contact us at telephone: (86-755) 8307 1443, or email: [CN.Doccheck@sgs.com](mailto:CN.Doccheck@sgs.com)  
 No.1 Workshop, M-10, Middle Section, Science & Technology Park, Nanshan District, Shenzhen, Guangdong, China 518057 t (86-755) 26012053 www.sgs.com.cn  
 中国·广东·深圳市南山区科技园中区M-10栋1号厂房 邮编: 518057 t (86-755) 26012053 sgs.china@sgs.com



**SGS-CSTC Standards Technical Services Co., Ltd.**  
**Shenzhen Branch**

Report No.: ZEWM2303000343RG05  
 Page: 84 of 136

**802.11b\_Channel 6**



Final Data List										
NO.	Frequency [MHz]	Reading [dBµV]	AF[dB/m]	Factor [dB]	Level [dBµV/m]	Limit [dBµV/m]	Margin [dB]	Height [cm]	Angle [°]	Polarity
1	4874	56.39	30.74	-42.90	44.23	74.00	29.77	320	135	Vertical
2	7311	51.12	36.42	-38.81	48.73	74.00	25.27	287	92	Vertical
3	9748	49.89	38.30	-36.04	52.15	74.00	21.85	335	242	Vertical



Unless otherwise agreed in writing, this document is issued by the Company subject to its General Conditions of Service printed overleaf, available on request or accessible at <https://www.sgs.com/en/Terms-and-Conditions>. Attention is drawn to the limitation of liability, indemnification and jurisdiction issues defined therein. Any holder of this document is advised that information contained hereon reflects the Company's findings at the time of its intervention only and within the limits of Client's instructions, if any. The Company's sole responsibility is to its Client and this document does not exonerate parties to a transaction from exercising all their rights and obligations under the transaction documents. This document cannot be reproduced except in full, without prior written approval of the Company. Any unauthorized alteration, forgery or falsification of the content or appearance of this document is unlawful and offenders may be prosecuted to the fullest extent of the law. Unless otherwise stated the results shown in this test report refer only to the sample(s) tested and such sample(s) are retained for 30 days only.

Attention: To check the authenticity of testing / inspection report & certificate, please contact us at telephone: (86-755) 8307 1443, or email: [CN.Doccheck@sgs.com](mailto:CN.Doccheck@sgs.com)

No. 1 Workshop, M-10, Middle Section, Science & Technology Park, Nanshan District, Shenzhen, Guangdong, China 518057 t (86-755) 26012053 www.sgs.com.cn  
 中国·广东·深圳市南山区科技园中区M-10栋1号厂房 邮编: 518057 t (86-755) 26012053 sgs.china@sgs.com

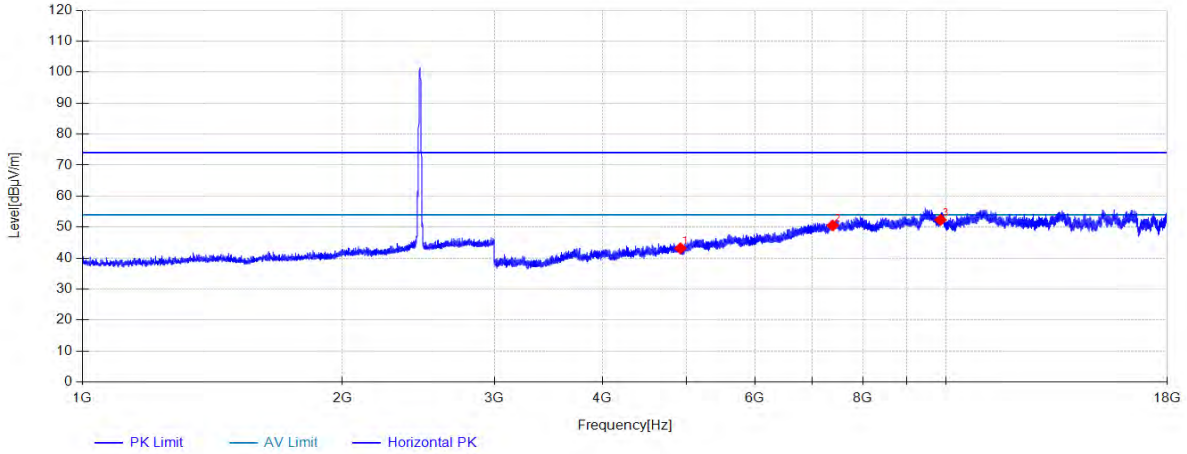




**SGS-CSTC Standards Technical Services Co., Ltd.**  
**Shenzhen Branch**

Report No.: ZEWM2303000343RG05  
 Page: 85 of 136

**802.11b\_Channel 11**

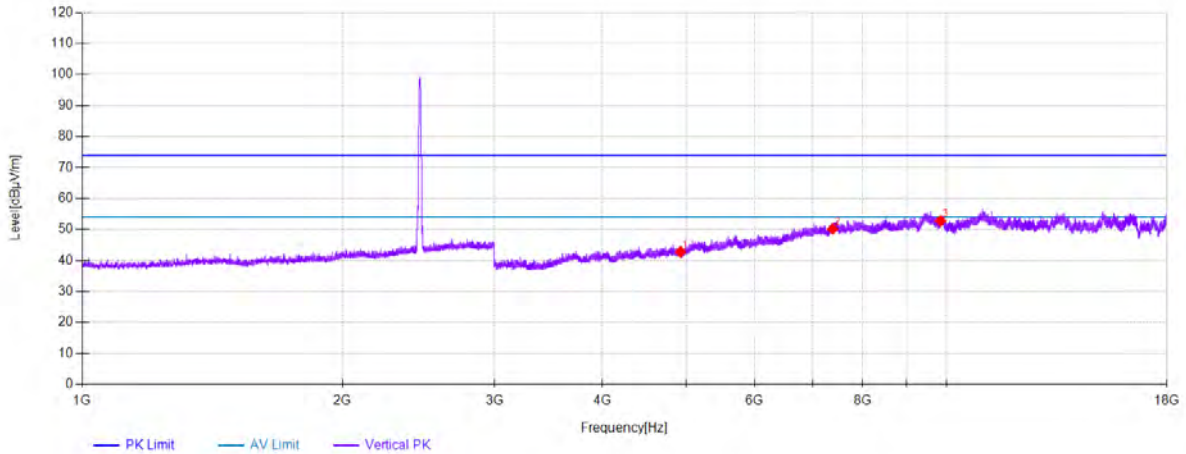


Final Data List										
NO.	Frequency [MHz]	Reading [dBμV]	AF[dB/m]	Factor [dB]	Level [dBμV/m]	Limit [dBμV/m]	Margin [dB]	Height [cm]	Angle [°]	Polarity
1	4924	55.07	30.95	-42.84	43.18	74.00	30.82	198	41	Horizontal
2	7386	52.21	36.65	-38.36	50.50	74.00	23.50	145	136	Horizontal
3	9848	49.49	38.21	-35.36	52.34	74.00	21.66	223	52	Horizontal



Unless otherwise agreed in writing, this document is issued by the Company subject to its General Conditions of Service printed overleaf, available on request or accessible at <https://www.sgs.com/en/Terms-and-Conditions>. Attention is drawn to the limitation of liability, indemnification and jurisdiction issues defined therein. Any holder of this document is advised that information contained hereon reflects the Company's findings at the time of its intervention only and within the limits of Client's instructions, if any. The Company's sole responsibility is to its Client and this document does not exonerate parties to a transaction from exercising all their rights and obligations under the transaction documents. This document cannot be reproduced except in full, without prior written approval of the Company. Any unauthorized alteration, forgery or falsification of the content or appearance of this document is unlawful and offenders may be prosecuted to the fullest extent of the law. Unless otherwise stated the results shown in this test report refer only to the sample(s) tested and such sample(s) are retained for 30 days only.

Attention: To check the authenticity of testing / inspection report & certificate, please contact us at telephone: (86-755) 8307 1443, or email: [CN\\_Doccheck@sgs.com](mailto:CN_Doccheck@sgs.com)  
 No. 1 Workshop, M-10, Middle Section, Science & Technology Park, Nanshan District, Shenzhen, Guangdong, China 518057 t (86-755) 26012053 www.sgs.com.cn  
 中国·广东·深圳市南山区科技园中区M-10栋1号厂房 邮编: 518057 t (86-755) 26012053 sgs.china@sgs.com


**802.11b\_Channel 11**


Final Data List										
NO.	Frequency [MHz]	Reading [dBµV]	AF[dB/m]	Factor [dB]	Level [dBµV/m]	Limit [dBµV/m]	Margin [dB]	Height [cm]	Angle [°]	Polarity
1	4924	54.72	30.95	-42.84	42.83	74.00	31.17	345	262	Vertical
2	7386	51.87	36.65	-38.36	50.16	74.00	23.84	280	294	Vertical
3	9848	49.96	38.21	-35.36	52.81	74.00	21.19	341	241	Vertical



Unless otherwise agreed in writing, this document is issued by the Company subject to its General Conditions of Service printed overleaf, available on request or accessible at <https://www.sgs.com/en/Terms-and-Conditions>. Attention is drawn to the limitation of liability, indemnification and jurisdiction issues defined therein. Any holder of this document is advised that information contained hereon reflects the Company's findings at the time of its intervention only and within the limits of Client's instructions, if any. The Company's sole responsibility is to its Client and this document does not exonerate parties to a transaction from exercising all their rights and obligations under the transaction documents. This document cannot be reproduced except in full, without prior written approval of the Company. Any unauthorized alteration, forgery or falsification of the content or appearance of this document is unlawful and offenders may be prosecuted to the fullest extent of the law. Unless otherwise stated the results shown in this test report refer only to the sample(s) tested and such sample(s) are retained for 30 days only.

Attention: To check the authenticity of testing / inspection report & certificate, please contact us at telephone: (86-755) 8307 1443, or email: [CN.Doccheck@sgs.com](mailto:CN.Doccheck@sgs.com)

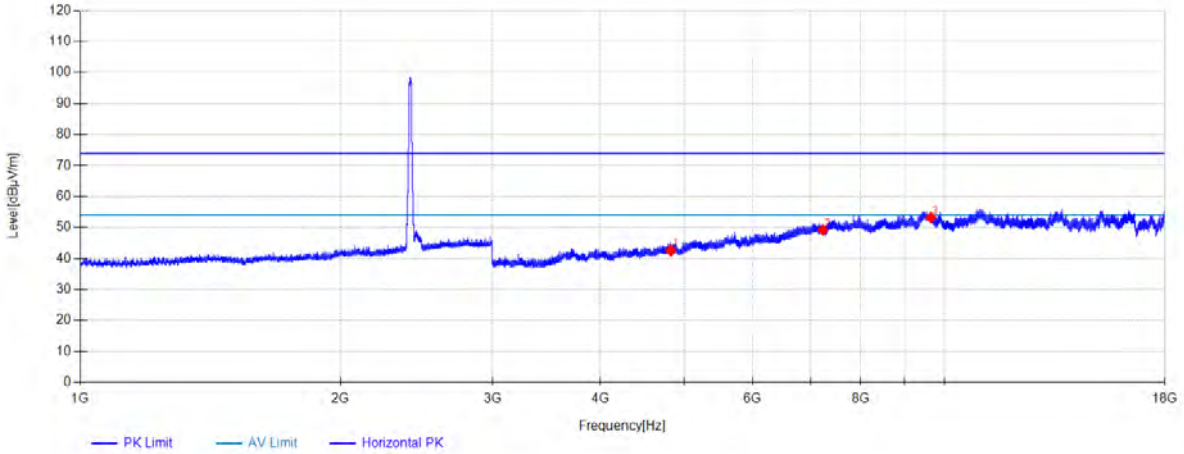
No. 1 Workshop, M-10, Middle Section, Science & Technology Park, Nanshan District, Shenzhen, Guangdong, China 518057 t (86-755) 26012053 www.sgs.com.cn  
 中国·广东·深圳市南山区科技园中区M-10栋1号厂房 邮编: 518057 t (86-755) 26012053 sgs.china@sgs.com



**SGS-CSTC Standards Technical Services Co., Ltd.**  
**Shenzhen Branch**

Report No.: ZEWM2303000343RG05  
 Page: 87 of 136

**802.11g\_Channel 1**



Final Data List										
NO.	Frequency [MHz]	Reading [dBµV]	AF[dB/m]	Factor [dB]	Level [dBµV/m]	Limit [dBµV/m]	Margin [dB]	Height [cm]	Angle [°]	Polarity
1	4824	54.84	30.70	-42.93	42.61	74.00	31.39	180	184	Horizontal
2	7236	51.62	36.38	-38.77	49.23	74.00	24.77	245	184	Horizontal
3	9648	51.09	38.09	-35.97	53.21	74.00	20.79	222	258	Horizontal



Unless otherwise agreed in writing, this document is issued by the Company subject to its General Conditions of Service printed overleaf, available on request or accessible at <https://www.sgs.com/en/Terms-and-Conditions>. Attention is drawn to the limitation of liability, indemnification and jurisdiction issues defined therein. Any holder of this document is advised that information contained hereon reflects the Company's findings at the time of its intervention only and within the limits of Client's instructions, if any. The Company's sole responsibility is to its Client and this document does not exonerate parties to a transaction from exercising all their rights and obligations under the transaction documents. This document cannot be reproduced except in full, without prior written approval of the Company. Any unauthorized alteration, forgery or falsification of the content or appearance of this document is unlawful and offenders may be prosecuted to the fullest extent of the law. Unless otherwise stated the results shown in this test report refer only to the sample(s) tested and such sample(s) are retained for 30 days only.

Attention: To check the authenticity of testing / inspection report & certificate, please contact us at telephone: (86-755) 8307 1443, or email: [CN.Doccheck@sgs.com](mailto:CN.Doccheck@sgs.com)

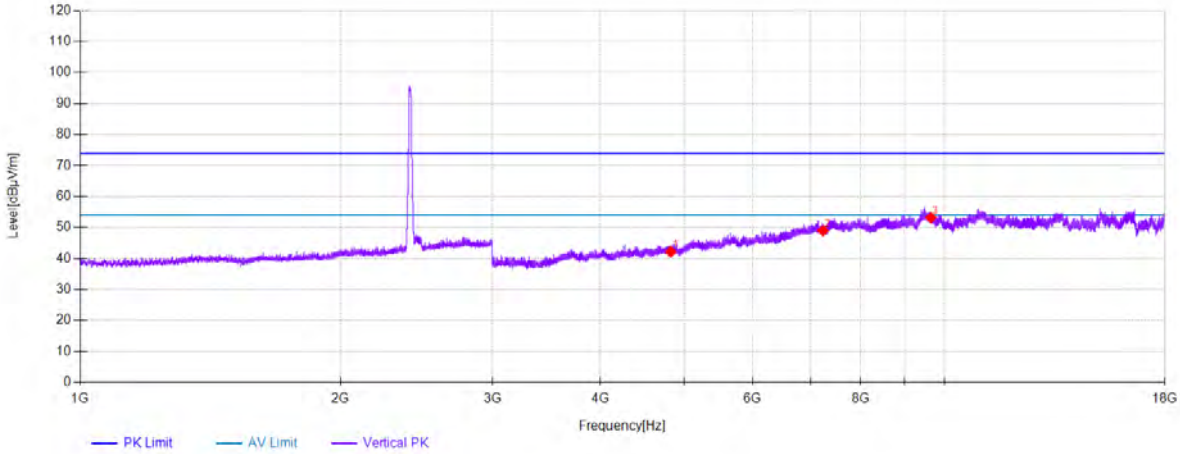
No. 1 Workshop, M-10, Middle Section, Science & Technology Park, Nanshan District, Shenzhen, Guangdong, China 518057 t (86-755) 26012053 www.sgs.com.cn  
 中国·广东·深圳市南山区科技园中区M-10栋1号厂房 邮编: 518057 t (86-755) 26012053 sgs.china@sgs.com



**SGS-CSTC Standards Technical Services Co., Ltd.**  
**Shenzhen Branch**

Report No.: ZEWM2303000343RG05  
 Page: 88 of 136

**802.11g\_Channel 1**



Final Data List										
NO.	Frequency [MHz]	Reading [dBµV]	AF[dB/m]	Factor [dB]	Level [dBµV/m]	Limit [dBµV/m]	Margin [dB]	Height [cm]	Angle [°]	Polarity
1	4824	54.41	30.70	-42.93	42.18	74.00	31.82	380	39	Vertical
2	7236	51.39	36.38	-38.77	49.00	74.00	25.00	287	295	Vertical
3	9648	51.06	38.09	-35.97	53.18	74.00	20.82	315	39	Vertical



Unless otherwise agreed in writing, this document is issued by the Company subject to its General Conditions of Service printed overleaf, available on request or accessible at <https://www.sgs.com/en/Terms-and-Conditions>. Attention is drawn to the limitation of liability, indemnification and jurisdiction issues defined therein. Any holder of this document is advised that information contained hereon reflects the Company's findings at the time of its intervention only and within the limits of Client's instructions, if any. The Company's sole responsibility is to its Client and this document does not exonerate parties to a transaction from exercising all their rights and obligations under the transaction documents. This document cannot be reproduced except in full, without prior written approval of the Company. Any unauthorized alteration, forgery or falsification of the content or appearance of this document is unlawful and offenders may be prosecuted to the fullest extent of the law. Unless otherwise stated the results shown in this test report refer only to the sample(s) tested and such sample(s) are retained for 30 days only.

Attention: To check the authenticity of testing / inspection report & certificate, please contact us at telephone: (86-755) 8307 1443, or email: [CN.Doccheck@sgs.com](mailto:CN.Doccheck@sgs.com)  
 No. 1 Workshop, M-10, Middle Section, Science & Technology Park, Nanshan District, Shenzhen, Guangdong, China 518057 t (86-755) 26012053 www.sgs.com.cn  
 中国·广东·深圳市南山区科技园中区M-10栋1号厂房 邮编: 518057 t (86-755) 26012053 sgs.china@sgs.com

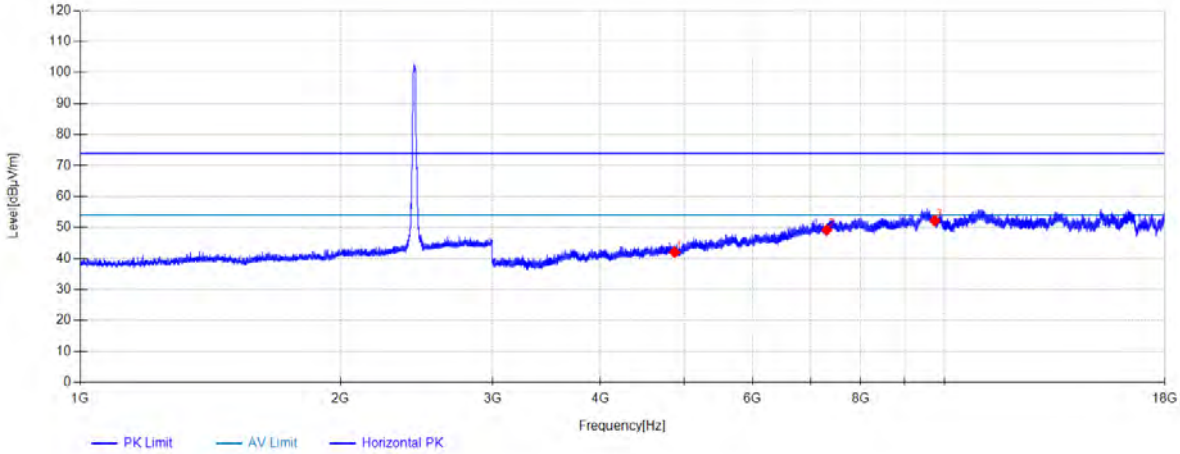




**SGS-CSTC Standards Technical Services Co., Ltd.**  
**Shenzhen Branch**

Report No.: ZEWM2303000343RG05  
 Page: 89 of 136

**802.11g\_Channel 6**



Final Data List										
NO.	Frequency [MHz]	Reading [dBµV]	AF[dB/m]	Factor [dB]	Level [dBµV/m]	Limit [dBµV/m]	Margin [dB]	Height [cm]	Angle [°]	Polarity
1	4874	54.20	30.74	-42.90	42.04	74.00	31.96	154	200	Horizontal
2	7311	51.63	36.42	-38.81	49.24	74.00	24.76	176	275	Horizontal
3	9748	49.97	38.30	-36.04	52.23	74.00	21.77	198	52	Horizontal



Unless otherwise agreed in writing, this document is issued by the Company subject to its General Conditions of Service printed overleaf, available on request or accessible at <https://www.sgs.com/en/Terms-and-Conditions>. Attention is drawn to the limitation of liability, indemnification and jurisdiction issues defined therein. Any holder of this document is advised that information contained hereon reflects the Company's findings at the time of its intervention only and within the limits of Client's instructions, if any. The Company's sole responsibility is to its Client and this document does not exonerate parties to a transaction from exercising all their rights and obligations under the transaction documents. This document cannot be reproduced except in full, without prior written approval of the Company. Any unauthorized alteration, forgery or falsification of the content or appearance of this document is unlawful and offenders may be prosecuted to the fullest extent of the law. Unless otherwise stated the results shown in this test report refer only to the sample(s) tested and such sample(s) are retained for 30 days only.

Attention: To check the authenticity of testing / inspection report & certificate, please contact us at telephone: (86-755) 8307 1443, or email: [CN.Doccheck@sgs.com](mailto:CN.Doccheck@sgs.com)

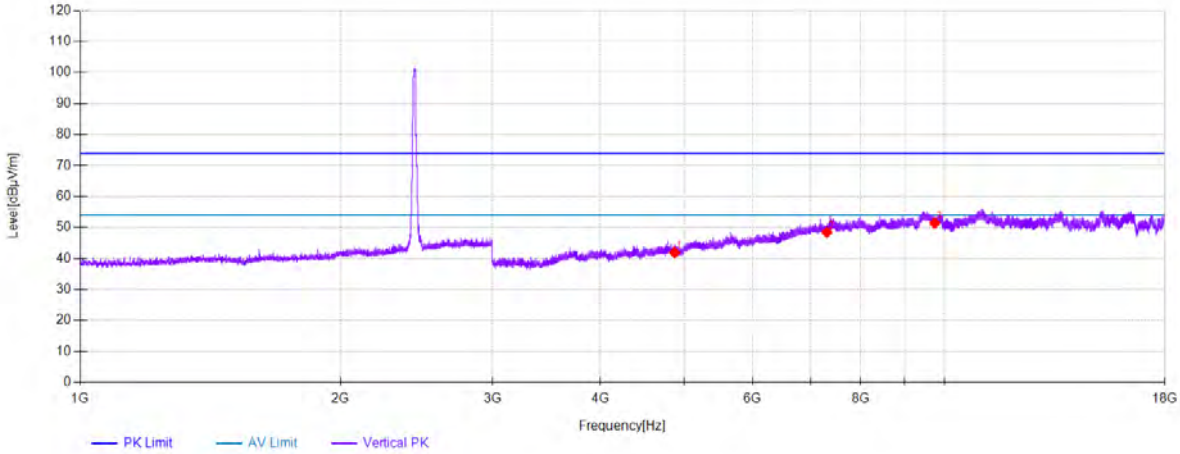
No. 1 Workshop, M-10, Middle Section, Science & Technology Park, Nanshan District, Shenzhen, Guangdong, China 518057 t (86-755) 26012053 www.sgs.com.cn  
 中国·广东·深圳市南山区科技园中区M-10栋1号厂房 邮编: 518057 t (86-755) 26012053 sgs.china@sgs.com



**SGS-CSTC Standards Technical Services Co., Ltd.**  
**Shenzhen Branch**

Report No.: ZEWM2303000343RG05  
 Page: 90 of 136

**802.11g\_Channel 6**



Final Data List										
NO.	Frequency [MHz]	Reading [dBµV]	AF[dB/m]	Factor [dB]	Level [dBµV/m]	Limit [dBµV/m]	Margin [dB]	Height [cm]	Angle [°]	Polarity
1	4874	54.07	30.74	-42.90	41.91	74.00	32.09	245	239	Vertical
2	7311	50.85	36.42	-38.81	48.46	74.00	25.54	321	250	Vertical
3	9748	49.18	38.30	-36.04	51.44	74.00	22.56	290	0	Vertical

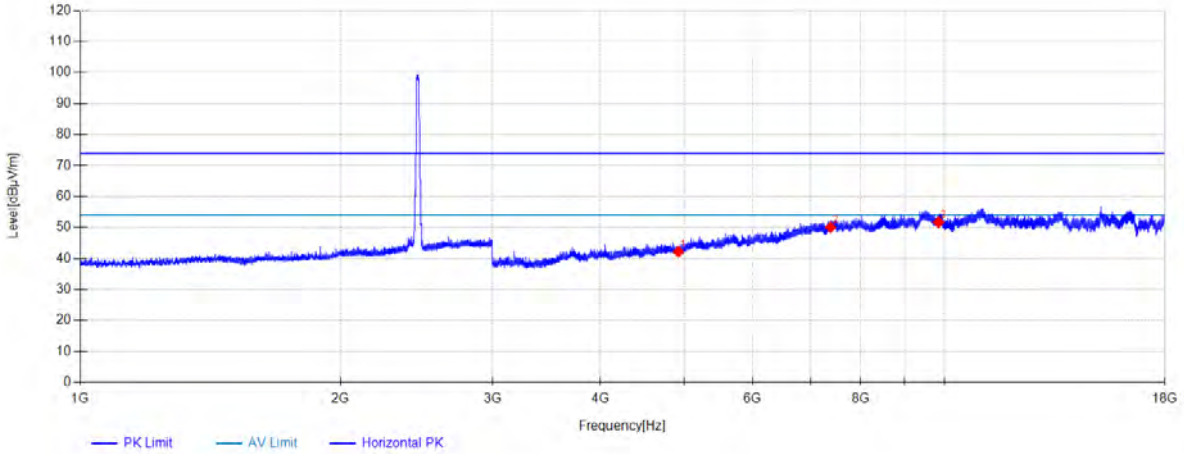


Unless otherwise agreed in writing, this document is issued by the Company subject to its General Conditions of Service printed overleaf, available on request or accessible at <https://www.sgs.com/en/Terms-and-Conditions>. Attention is drawn to the limitation of liability, indemnification and jurisdiction issues defined therein. Any holder of this document is advised that information contained hereon reflects the Company's findings at the time of its intervention only and within the limits of Client's instructions, if any. The Company's sole responsibility is to its Client and this document does not exonerate parties to a transaction from exercising all their rights and obligations under the transaction documents. This document cannot be reproduced except in full, without prior written approval of the Company. Any unauthorized alteration, forgery or falsification of the content or appearance of this document is unlawful and offenders may be prosecuted to the fullest extent of the law. Unless otherwise stated the results shown in this test report refer only to the sample(s) tested and such sample(s) are retained for 30 days only.

Attention: To check the authenticity of testing / inspection report & certificate, please contact us at telephone: (86-755) 8307 1443, or email: [CN\\_Doccheck@sgs.com](mailto:CN_Doccheck@sgs.com)  
 No. 1 Workshop, M-10, Middle Section, Science & Technology Park, Nanshan District, Shenzhen, Guangdong, China 518057 t (86-755) 26012053 www.sgs.com.cn  
 中国·广东·深圳市南山区科技园中区M-10栋1号厂房 邮编: 518057 t (86-755) 26012053 sgs.china@sgs.com



**802.11g\_Channel 11**



Final Data List										
NO.	Frequency [MHz]	Reading [dBµV]	AF[dB/m]	Factor [dB]	Level [dBµV/m]	Limit [dBµV/m]	Margin [dB]	Height [cm]	Angle [°]	Polarity
1	4924	54.11	30.95	-42.84	42.22	74.00	31.78	154	200	Horizontal
2	7386	51.79	36.65	-38.36	50.08	74.00	23.92	245	348	Horizontal
3	9848	48.89	38.21	-35.36	51.74	74.00	22.26	222	222	Horizontal



Unless otherwise agreed in writing, this document is issued by the Company subject to its General Conditions of Service printed overleaf, available on request or accessible at <https://www.sgs.com/en/Terms-and-Conditions>. Attention is drawn to the limitation of liability, indemnification and jurisdiction issues defined therein. Any holder of this document is advised that information contained hereon reflects the Company's findings at the time of its intervention only and within the limits of Client's instructions, if any. The Company's sole responsibility is to its Client and this document does not exonerate parties to a transaction from exercising all their rights and obligations under the transaction documents. This document cannot be reproduced except in full, without prior written approval of the Company. Any unauthorized alteration, forgery or falsification of the content or appearance of this document is unlawful and offenders may be prosecuted to the fullest extent of the law. Unless otherwise stated the results shown in this test report refer only to the sample(s) tested and such sample(s) are retained for 30 days only.

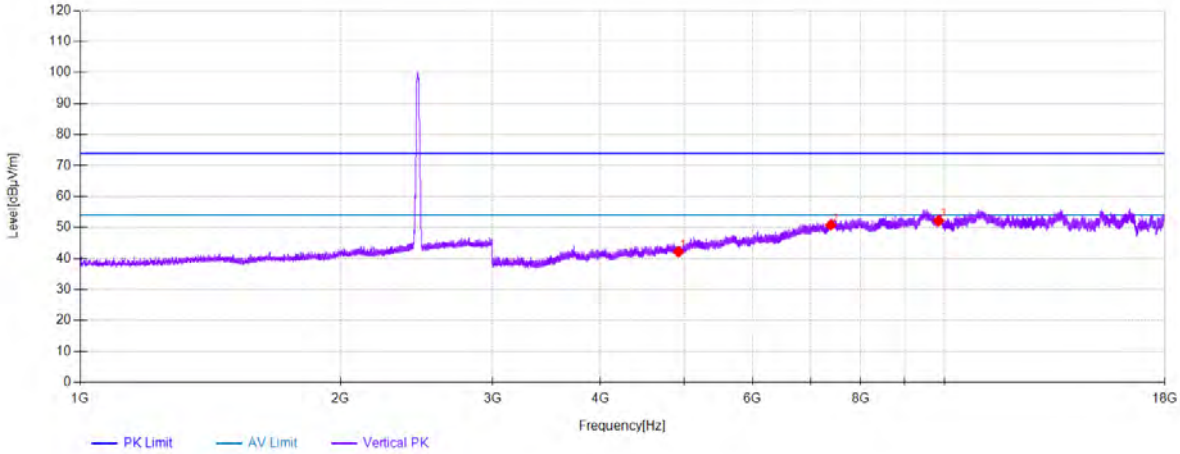
Attention: To check the authenticity of testing / inspection report & certificate, please contact us at telephone: (86-755) 8307 1443, or email: [CN.Doccheck@sgs.com](mailto:CN.Doccheck@sgs.com)  
 No. 1 Workshop, M-10, Middle Section, Science & Technology Park, Nanshan District, Shenzhen, Guangdong, China 518057 t (86-755) 26012053 www.sgs.com.cn  
 中国·广东·深圳市南山区科技园中区M-10栋1号厂房 邮编: 518057 t (86-755) 26012053 sgs.china@sgs.com



**SGS-CSTC Standards Technical Services Co., Ltd.**  
**Shenzhen Branch**

Report No.: ZEWM2303000343RG05  
 Page: 92 of 136

**802.11g\_Channel 11**



Final Data List										
NO.	Frequency [MHz]	Reading [dBµV]	AF[dB/m]	Factor [dB]	Level [dBµV/m]	Limit [dBµV/m]	Margin [dB]	Height [cm]	Angle [°]	Polarity
1	4924	54.09	30.95	-42.84	42.20	74.00	31.80	390	253	Vertical
2	7386	52.50	36.65	-38.36	50.79	74.00	23.21	278	136	Vertical
3	9848	49.37	38.21	-35.36	52.22	74.00	21.78	345	243	Vertical



Unless otherwise agreed in writing, this document is issued by the Company subject to its General Conditions of Service printed overleaf, available on request or accessible at <https://www.sgs.com/en/Terms-and-Conditions>. Attention is drawn to the limitation of liability, indemnification and jurisdiction issues defined therein. Any holder of this document is advised that information contained hereon reflects the Company's findings at the time of its intervention only and within the limits of Client's instructions, if any. The Company's sole responsibility is to its Client and this document does not exonerate parties to a transaction from exercising all their rights and obligations under the transaction documents. This document cannot be reproduced except in full, without prior written approval of the Company. Any unauthorized alteration, forgery or falsification of the content or appearance of this document is unlawful and offenders may be prosecuted to the fullest extent of the law. Unless otherwise stated the results shown in this test report refer only to the sample(s) tested and such sample(s) are retained for 30 days only.

Attention: To check the authenticity of testing / inspection report & certificate, please contact us at telephone: (86-755) 8307 1443, or email: [CN.Doccheck@sgs.com](mailto:CN.Doccheck@sgs.com)  
 No. 1 Workshop, M-10, Middle Section, Science & Technology Park, Nanshan District, Shenzhen, Guangdong, China 518057 t (86-755) 26012053 www.sgs.com.cn  
 中国·广东·深圳市南山区科技园中区M-10栋1号厂房 邮编: 518057 t (86-755) 26012053 sgs.china@sgs.com

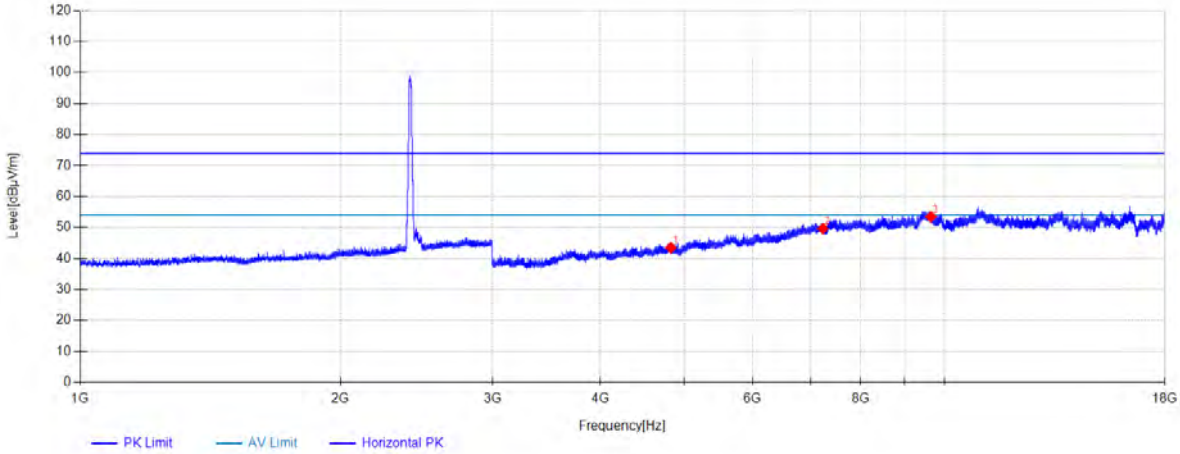




**SGS-CSTC Standards Technical Services Co., Ltd.**  
**Shenzhen Branch**

Report No.: ZEWM2303000343RG05  
 Page: 93 of 136

**802.11n20\_Channel 1**



Final Data List										
NO.	Frequency [MHz]	Reading [dBµV]	AF[dB/m]	Factor [dB]	Level [dBµV/m]	Limit [dBµV/m]	Margin [dB]	Height [cm]	Angle [°]	Polarity
1	4824	55.75	30.70	-42.93	43.52	74.00	30.48	153	324	Horizontal
2	7236	52.05	36.38	-38.77	49.66	74.00	24.34	245	90	Horizontal
3	9648	51.38	38.09	-35.97	53.50	74.00	20.50	125	346	Horizontal



Unless otherwise agreed in writing, this document is issued by the Company subject to its General Conditions of Service printed overleaf, available on request or accessible at <https://www.sgs.com/en/Terms-and-Conditions>. Attention is drawn to the limitation of liability, indemnification and jurisdiction issues defined therein. Any holder of this document is advised that information contained hereon reflects the Company's findings at the time of its intervention only and within the limits of Client's instructions, if any. The Company's sole responsibility is to its Client and this document does not exonerate parties to a transaction from exercising all their rights and obligations under the transaction documents. This document cannot be reproduced except in full, without prior written approval of the Company. Any unauthorized alteration, forgery or falsification of the content or appearance of this document is unlawful and offenders may be prosecuted to the fullest extent of the law. Unless otherwise stated the results shown in this test report refer only to the sample(s) tested and such sample(s) are retained for 30 days only.

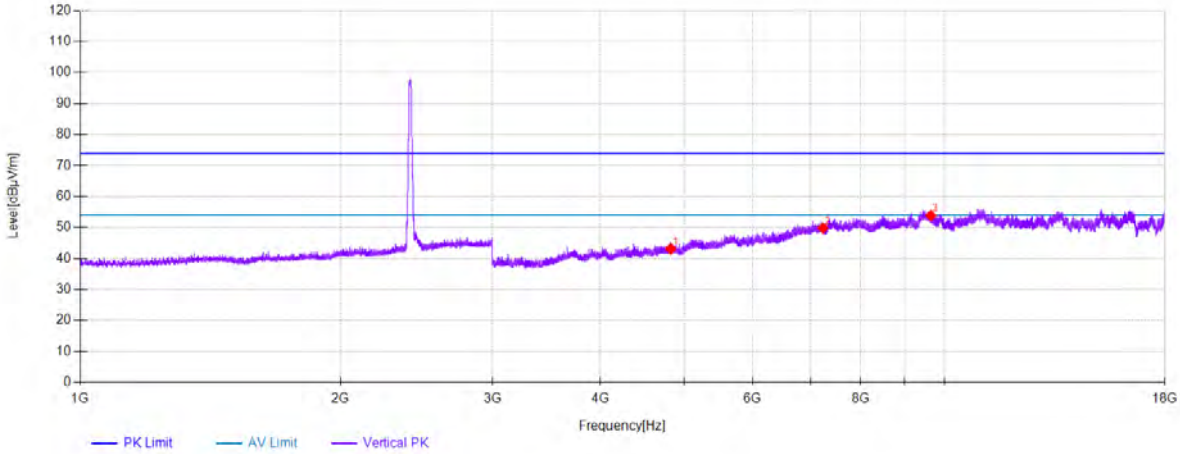
Attention: To check the authenticity of testing / inspection report & certificate, please contact us at telephone: (86-755) 8307 1443, or email: [CN.Doccheck@sgs.com](mailto:CN.Doccheck@sgs.com)  
 No.1 Workshop, M-10, Middle Section, Science & Technology Park, Nanshan District, Shenzhen, Guangdong, China 518057 t (86-755) 26012053 www.sgs.com.cn  
 中国·广东·深圳市南山区科技园中区M-10栋1号厂房 邮编: 518057 t (86-755) 26012053 sgs.china@sgs.com



**SGS-CSTC Standards Technical Services Co., Ltd.**  
**Shenzhen Branch**

Report No.: ZEWM2303000343RG05  
 Page: 94 of 136

**802.11n20\_Channel 1**



Final Data List										
NO.	Frequency [MHz]	Reading [dBµV]	AF[dB/m]	Factor [dB]	Level [dBµV/m]	Limit [dBµV/m]	Margin [dB]	Height [cm]	Angle [°]	Polarity
1	4824	55.34	30.70	-42.93	43.11	74.00	30.89	345	61	Vertical
2	7236	52.18	36.38	-38.77	49.79	74.00	24.21	254	114	Vertical
3	9648	51.75	38.09	-35.97	53.87	74.00	20.13	211	231	Vertical

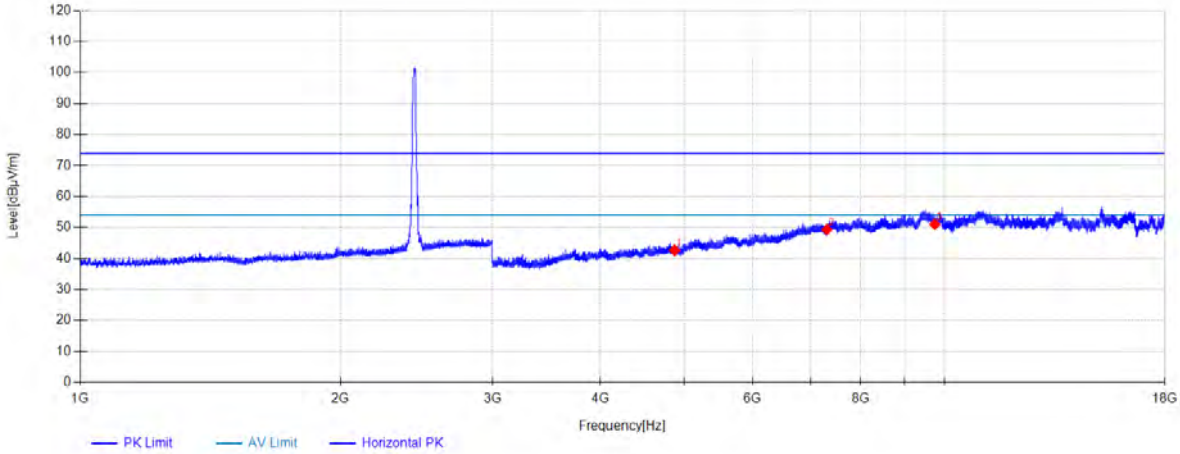


Unless otherwise agreed in writing, this document is issued by the Company subject to its General Conditions of Service printed overleaf, available on request or accessible at <https://www.sgs.com/en/Terms-and-Conditions>. Attention is drawn to the limitation of liability, indemnification and jurisdiction issues defined therein. Any holder of this document is advised that information contained hereon reflects the Company's findings at the time of its intervention only and within the limits of Client's instructions, if any. The Company's sole responsibility is to its Client and this document does not exonerate parties to a transaction from exercising all their rights and obligations under the transaction documents. This document cannot be reproduced except in full, without prior written approval of the Company. Any unauthorized alteration, forgery or falsification of the content or appearance of this document is unlawful and offenders may be prosecuted to the fullest extent of the law. Unless otherwise stated the results shown in this test report refer only to the sample(s) tested and such sample(s) are retained for 30 days only.

Attention: To check the authenticity of testing / inspection report & certificate, please contact us at telephone: (86-755) 8307 1443, or email: [CN.Doccheck@sgs.com](mailto:CN.Doccheck@sgs.com)  
 No. 1 Workshop, M-10, Middle Section, Science & Technology Park, Nanshan District, Shenzhen, Guangdong, China 518057 t (86-755) 26012053 www.sgs.com.cn  
 中国·广东·深圳市南山区科技园中区M-10栋1号厂房 邮编: 518057 t (86-755) 26012053 sgs.china@sgs.com



**802.11n20\_Channel 6**



Final Data List										
NO.	Frequency [MHz]	Reading [dBµV]	AF[dB/m]	Factor [dB]	Level [dBµV/m]	Limit [dBµV/m]	Margin [dB]	Height [cm]	Angle [°]	Polarity
1	4874	54.83	30.74	-42.90	42.67	74.00	31.33	236	316	Horizontal
2	7311	51.76	36.42	-38.81	49.37	74.00	24.63	150	348	Horizontal
3	9748	48.82	38.30	-36.04	51.08	74.00	22.92	145	178	Horizontal



Unless otherwise agreed in writing, this document is issued by the Company subject to its General Conditions of Service printed overleaf, available on request or accessible at <https://www.sgs.com/en/Terms-and-Conditions>. Attention is drawn to the limitation of liability, indemnification and jurisdiction issues defined therein. Any holder of this document is advised that information contained hereon reflects the Company's findings at the time of its intervention only and within the limits of Client's instructions, if any. The Company's sole responsibility is to its Client and this document does not exonerate parties to a transaction from exercising all their rights and obligations under the transaction documents. This document cannot be reproduced except in full, without prior written approval of the Company. Any unauthorized alteration, forgery or falsification of the content or appearance of this document is unlawful and offenders may be prosecuted to the fullest extent of the law. Unless otherwise stated the results shown in this test report refer only to the sample(s) tested and such sample(s) are retained for 30 days only.

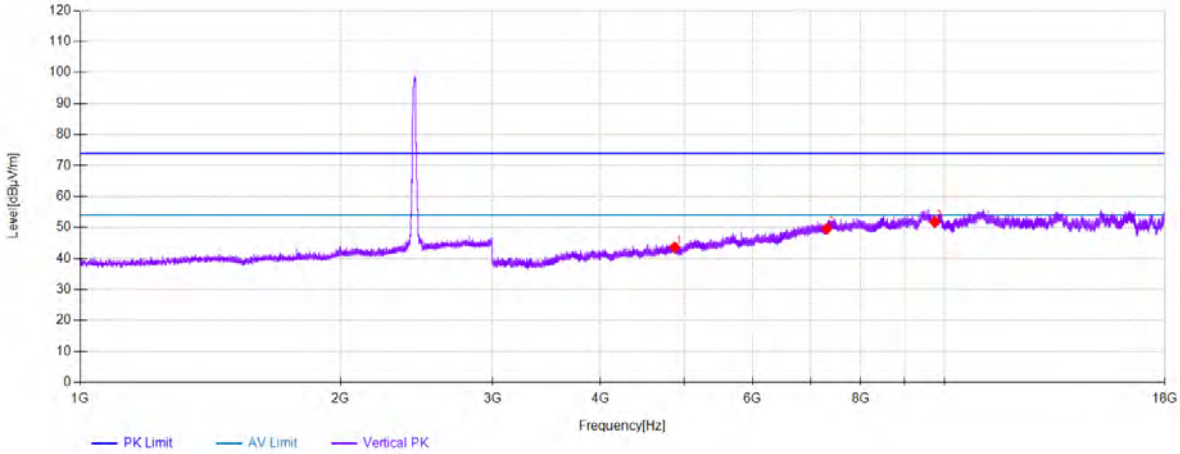
Attention: To check the authenticity of testing / inspection report & certificate, please contact us at telephone: (86-755) 8307 1443, or email: [CN.Doccheck@sgs.com](mailto:CN.Doccheck@sgs.com)  
 No. 1 Workshop, M-10, Middle Section, Science & Technology Park, Nanshan District, Shenzhen, Guangdong, China 518057 t (86-755) 26012053 www.sgs.com.cn  
 中国·广东·深圳市南山区科技园中区M-10栋1号厂房 邮编: 518057 t (86-755) 26012053 sgs.china@sgs.com



**SGS-CSTC Standards Technical Services Co., Ltd.**  
**Shenzhen Branch**

Report No.: ZEWM2303000343RG05  
 Page: 96 of 136

**802.11n20\_Channel 6**



Final Data List										
NO.	Frequency [MHz]	Reading [dBµV]	AF[dB/m]	Factor [dB]	Level [dBµV/m]	Limit [dBµV/m]	Margin [dB]	Height [cm]	Angle [°]	Polarity
1	4874	55.81	30.74	-42.90	43.65	74.00	30.35	263	209	Vertical
2	7311	51.98	36.42	-38.81	49.59	74.00	24.41	380	273	Vertical
3	9748	49.54	38.30	-36.04	51.80	74.00	22.20	247	305	Vertical



Unless otherwise agreed in writing, this document is issued by the Company subject to its General Conditions of Service printed overleaf, available on request or accessible at <https://www.sgs.com/en/Terms-and-Conditions>. Attention is drawn to the limitation of liability, indemnification and jurisdiction issues defined therein. Any holder of this document is advised that information contained hereon reflects the Company's findings at the time of its intervention only and within the limits of Client's instructions, if any. The Company's sole responsibility is to its Client and this document does not exonerate parties to a transaction from exercising all their rights and obligations under the transaction documents. This document cannot be reproduced except in full, without prior written approval of the Company. Any unauthorized alteration, forgery or falsification of the content or appearance of this document is unlawful and offenders may be prosecuted to the fullest extent of the law. Unless otherwise stated the results shown in this test report refer only to the sample(s) tested and such sample(s) are retained for 30 days only.

Attention: To check the authenticity of testing / inspection report & certificate, please contact us at telephone: (86-755) 8307 1443, or email: [CN\\_Doccheck@sgs.com](mailto:CN_Doccheck@sgs.com)

No. 1 Workshop, M-10, Middle Section, Science & Technology Park, Nanshan District, Shenzhen, Guangdong, China 518057 t (86-755) 26012053 www.sgs.com.cn  
 中国·广东·深圳市南山区科技园中区M-10栋1号厂房 邮编: 518057 t (86-755) 26012053 sgs.china@sgs.com

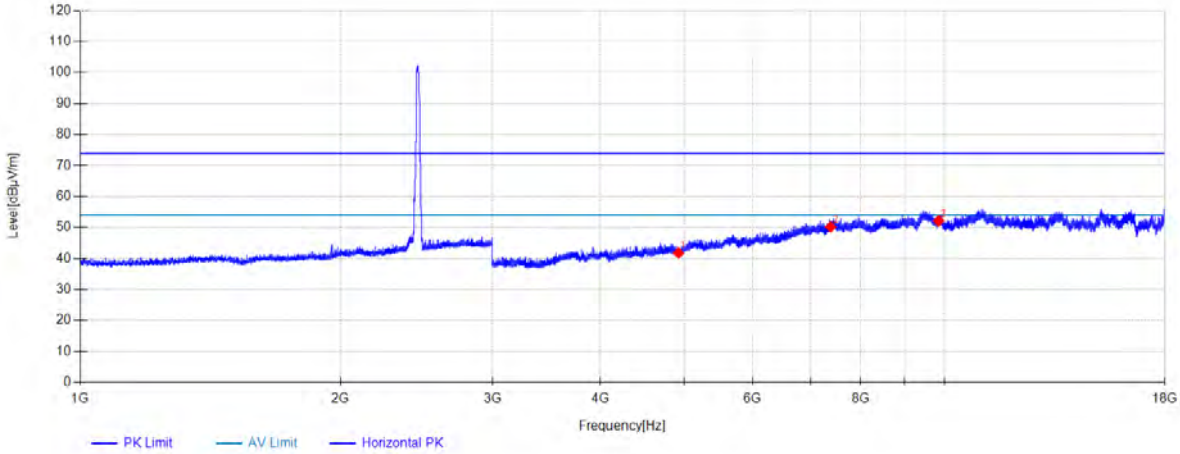




**SGS-CSTC Standards Technical Services Co., Ltd.**  
**Shenzhen Branch**

Report No.: ZEWM2303000343RG05  
 Page: 97 of 136

**802.11n20\_Channel 11**



Final Data List										
NO.	Frequency [MHz]	Reading [dBµV]	AF[dB/m]	Factor [dB]	Level [dBµV/m]	Limit [dBµV/m]	Margin [dB]	Height [cm]	Angle [°]	Polarity
1	4924	53.68	30.95	-42.84	41.79	74.00	32.21	145	39	Horizontal
2	7386	51.89	36.65	-38.36	50.18	74.00	23.82	231	264	Horizontal
3	9848	49.33	38.21	-35.36	52.18	74.00	21.82	189	7	Horizontal



Unless otherwise agreed in writing, this document is issued by the Company subject to its General Conditions of Service printed overleaf, available on request or accessible at <https://www.sgs.com/en/Terms-and-Conditions>. Attention is drawn to the limitation of liability, indemnification and jurisdiction issues defined therein. Any holder of this document is advised that information contained hereon reflects the Company's findings at the time of its intervention only and within the limits of Client's instructions, if any. The Company's sole responsibility is to its Client and this document does not exonerate parties to a transaction from exercising all their rights and obligations under the transaction documents. This document cannot be reproduced except in full, without prior written approval of the Company. Any unauthorized alteration, forgery or falsification of the content or appearance of this document is unlawful and offenders may be prosecuted to the fullest extent of the law. Unless otherwise stated the results shown in this test report refer only to the sample(s) tested and such sample(s) are retained for 30 days only.

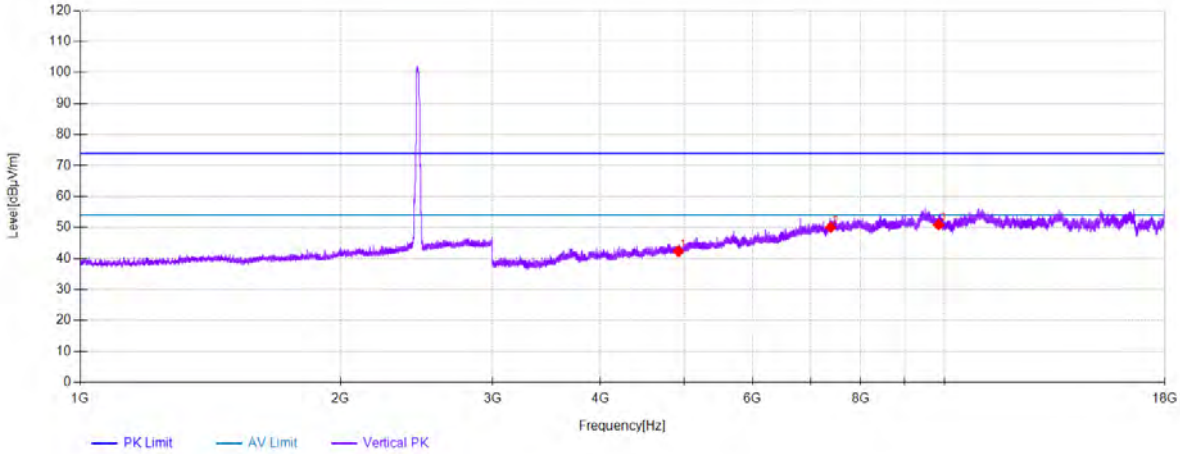
Attention: To check the authenticity of testing / inspection report & certificate, please contact us at telephone: (86-755) 8307 1443, or email: [CN.Doccheck@sgs.com](mailto:CN.Doccheck@sgs.com)  
 No. 1 Workshop, M-10, Middle Section, Science & Technology Park, Nanshan District, Shenzhen, Guangdong, China 518057 t (86-755) 26012053 www.sgs.com.cn  
 中国·广东·深圳市南山区科技园中区M-10栋1号厂房 邮编: 518057 t (86-755) 26012053 sgs.china@sgs.com



**SGS-CSTC Standards Technical Services Co., Ltd.**  
**Shenzhen Branch**

Report No.: ZEWM2303000343RG05  
 Page: 98 of 136

**802.11n20\_Channel 11**



Final Data List										
NO.	Frequency [MHz]	Reading [dBµV]	AF[dB/m]	Factor [dB]	Level [dBµV/m]	Limit [dBµV/m]	Margin [dB]	Height [cm]	Angle [°]	Polarity
1	4924	54.26	30.95	-42.84	42.37	74.00	31.63	345	94	Vertical
2	7386	51.76	36.65	-38.36	50.05	74.00	23.95	288	178	Vertical
3	9848	48.04	38.21	-35.36	50.89	74.00	23.11	314	84	Vertical



Unless otherwise agreed in writing, this document is issued by the Company subject to its General Conditions of Service printed overleaf, available on request or accessible at <https://www.sgs.com/en/Terms-and-Conditions>. Attention is drawn to the limitation of liability, indemnification and jurisdiction issues defined therein. Any holder of this document is advised that information contained hereon reflects the Company's findings at the time of its intervention only and within the limits of Client's instructions, if any. The Company's sole responsibility is to its Client and this document does not exonerate parties to a transaction from exercising all their rights and obligations under the transaction documents. This document cannot be reproduced except in full, without prior written approval of the Company. Any unauthorized alteration, forgery or falsification of the content or appearance of this document is unlawful and offenders may be prosecuted to the fullest extent of the law. Unless otherwise stated the results shown in this test report refer only to the sample(s) tested and such sample(s) are retained for 30 days only.

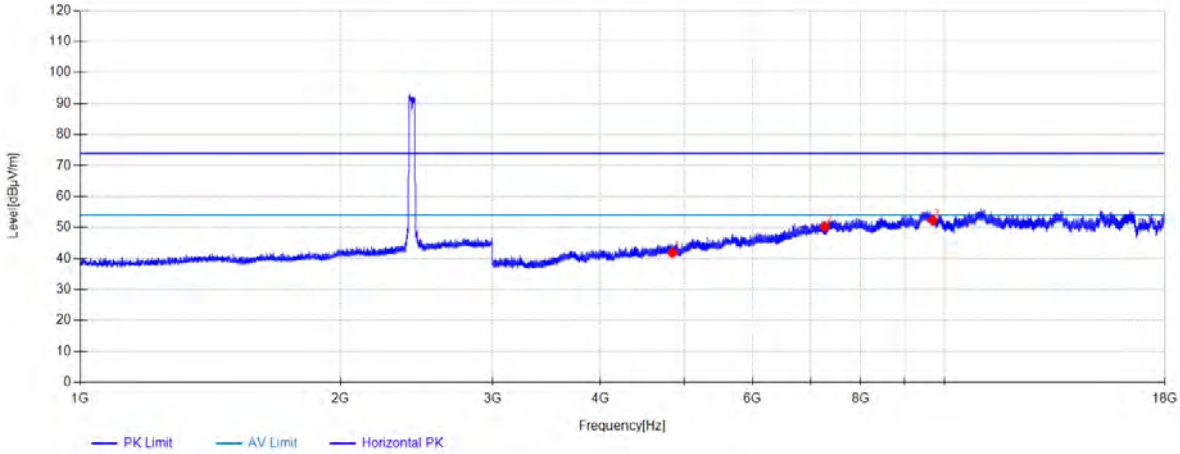
Attention: To check the authenticity of testing / inspection report & certificate, please contact us at telephone: (86-755) 8307 1443, or email: [CN\\_Doccheck@sgs.com](mailto:CN_Doccheck@sgs.com)  
 No. 1 Workshop, M-10, Middle Section, Science & Technology Park, Nanshan District, Shenzhen, Guangdong, China 518057 t (86-755) 26012053 www.sgs.com.cn  
 中国·广东·深圳市南山区科技园中区M-10栋1号厂房 邮编: 518057 t (86-755) 26012053 sgs.china@sgs.com



**SGS-CSTC Standards Technical Services Co., Ltd.**  
**Shenzhen Branch**

Report No.: ZEWM2303000343RG05  
 Page: 99 of 136

**802.11n40\_Channel 3**



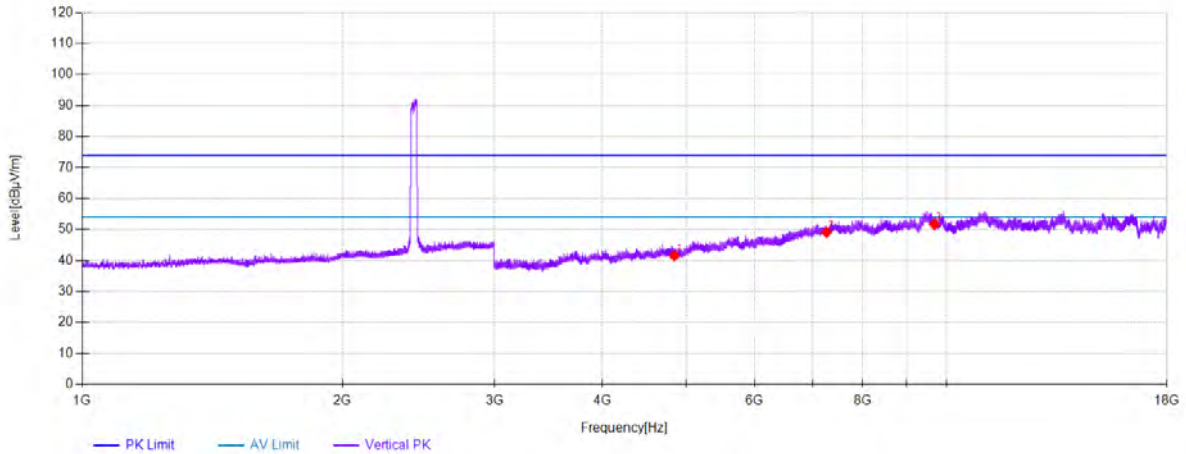
Final Data List										
NO.	Frequency [MHz]	Reading [dBµV]	AF[dB/m]	Factor [dB]	Level [dBµV/m]	Limit [dBµV/m]	Margin [dB]	Height [cm]	Angle [°]	Polarity
1	4844	54.25	30.62	-42.92	41.95	74.00	32.05	150	222	Horizontal
2	7266	52.78	36.33	-38.82	50.29	74.00	23.71	263	274	Horizontal
3	9688	50.51	38.18	-36.25	52.44	74.00	21.56	256	254	Horizontal



Unless otherwise agreed in writing, this document is issued by the Company subject to its General Conditions of Service printed overleaf, available on request or accessible at <https://www.sgs.com/en/Terms-and-Conditions>. Attention is drawn to the limitation of liability, indemnification and jurisdiction issues defined therein. Any holder of this document is advised that information contained hereon reflects the Company's findings at the time of its intervention only and within the limits of Client's instructions, if any. The Company's sole responsibility is to its Client and this document does not exonerate parties to a transaction from exercising all their rights and obligations under the transaction documents. This document cannot be reproduced except in full, without prior written approval of the Company. Any unauthorized alteration, forgery or falsification of the content or appearance of this document is unlawful and offenders may be prosecuted to the fullest extent of the law. Unless otherwise stated the results shown in this test report refer only to the sample(s) tested and such sample(s) are retained for 30 days only.

Attention: To check the authenticity of testing / inspection report & certificate, please contact us at telephone: (86-755) 8307 1443, or email: [CN.Doccheck@sgs.com](mailto:CN.Doccheck@sgs.com)

No. 1 Workshop, M-10, Middle Section, Science & Technology Park, Nanshan District, Shenzhen, Guangdong, China 518057 t (86-755) 26012053 www.sgs.com.cn  
 中国·广东·深圳市南山区科技园中区M-10栋1号厂房 邮编: 518057 t (86-755) 26012053 sgs.china@sgs.com


**802.11n40\_Channel 3**


Final Data List										
NO.	Frequency [MHz]	Reading [dBµV]	AF[dB/m]	Factor [dB]	Level [dBµV/m]	Limit [dBµV/m]	Margin [dB]	Height [cm]	Angle [°]	Polarity
1	4844	53.84	30.62	-42.92	41.54	74.00	32.46	263	338	Vertical
2	7266	51.61	36.33	-38.82	49.12	74.00	24.88	350	148	Vertical
3	9688	49.79	38.18	-36.25	51.72	74.00	22.28	288	295	Vertical



Unless otherwise agreed in writing, this document is issued by the Company subject to its General Conditions of Service printed overleaf, available on request or accessible at <https://www.sgs.com/en/Terms-and-Conditions>. Attention is drawn to the limitation of liability, indemnification and jurisdiction issues defined therein. Any holder of this document is advised that information contained hereon reflects the Company's findings at the time of its intervention only and within the limits of Client's instructions, if any. The Company's sole responsibility is to its Client and this document does not exonerate parties to a transaction from exercising all their rights and obligations under the transaction documents. This document cannot be reproduced except in full, without prior written approval of the Company. Any unauthorized alteration, forgery or falsification of the content or appearance of this document is unlawful and offenders may be prosecuted to the fullest extent of the law. Unless otherwise stated the results shown in this test report refer only to the sample(s) tested and such sample(s) are retained for 30 days only.

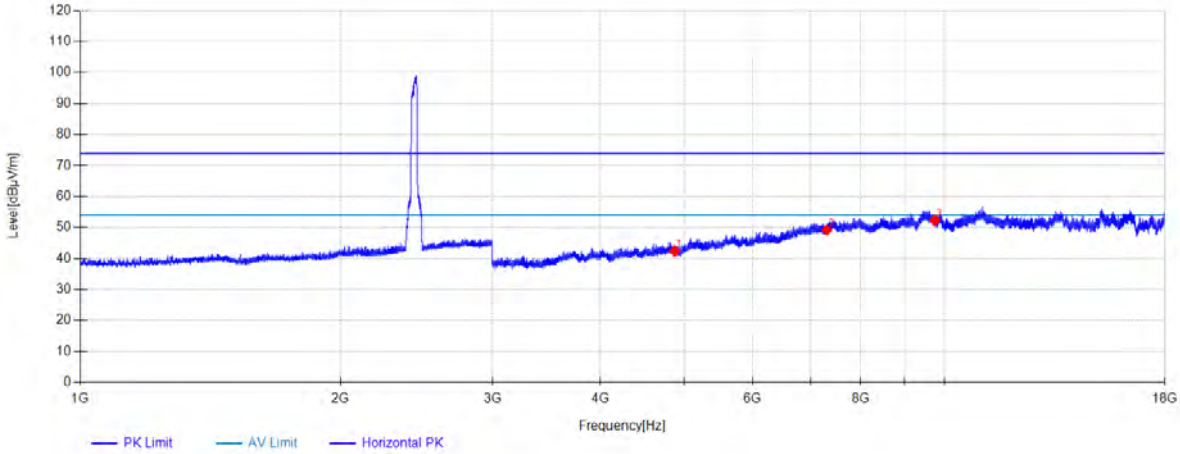
Attention: To check the authenticity of testing / inspection report & certificate, please contact us at telephone: (86-755) 8307 1443, or email: [CN.Doccheck@sgs.com](mailto:CN.Doccheck@sgs.com)

No. 1 Workshop, M-10, Middle Section, Science & Technology Park, Nanshan District, Shenzhen, Guangdong, China 518057 t (86-755) 26012053 www.sgs.com.cn  
 中国·广东·深圳市南山区科技园中区M-10栋1号厂房 邮编: 518057 t (86-755) 26012053 sgs.china@sgs.com





**802.11n40\_Channel 6**



Final Data List										
NO.	Frequency [MHz]	Reading [dBµV]	AF[dB/m]	Factor [dB]	Level [dBµV/m]	Limit [dBµV/m]	Margin [dB]	Height [cm]	Angle [°]	Polarity
1	4874	54.61	30.74	-42.90	42.45	74.00	31.55	263	53	Horizontal
2	7311	51.62	36.42	-38.81	49.23	74.00	24.77	189	42	Horizontal
3	9748	50.09	38.30	-36.04	52.35	74.00	21.65	155	264	Horizontal

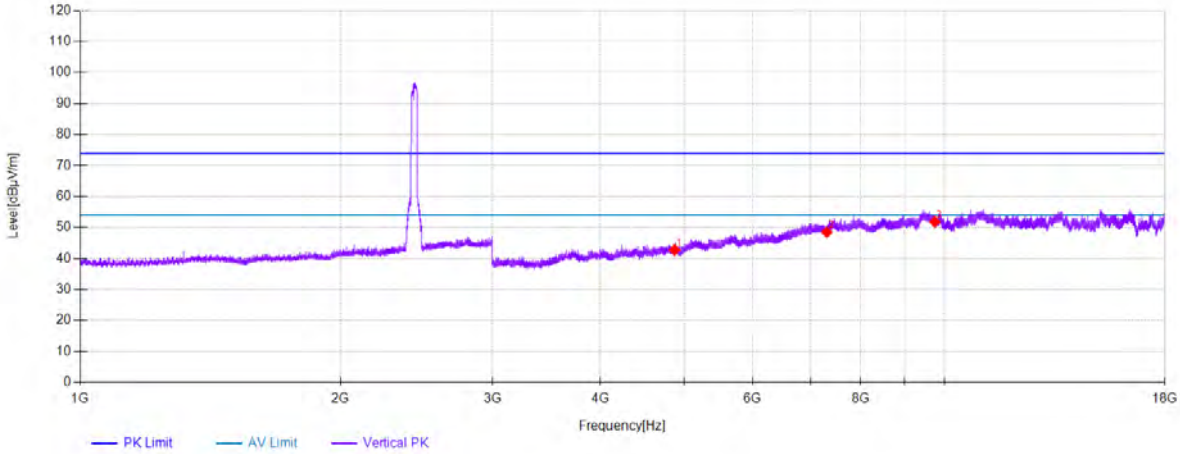


Unless otherwise agreed in writing, this document is issued by the Company subject to its General Conditions of Service printed overleaf, available on request or accessible at <https://www.sgs.com/en/Terms-and-Conditions>. Attention is drawn to the limitation of liability, indemnification and jurisdiction issues defined therein. Any holder of this document is advised that information contained hereon reflects the Company's findings at the time of its intervention only and within the limits of Client's instructions, if any. The Company's sole responsibility is to its Client and this document does not exonerate parties to a transaction from exercising all their rights and obligations under the transaction documents. This document cannot be reproduced except in full, without prior written approval of the Company. Any unauthorized alteration, forgery or falsification of the content or appearance of this document is unlawful and offenders may be prosecuted to the fullest extent of the law. Unless otherwise stated the results shown in this test report refer only to the sample(s) tested and such sample(s) are retained for 30 days only.

Attention: To check the authenticity of testing / inspection report & certificate, please contact us at telephone: (86-755) 8307 1443, or email: [CN.Doccheck@sgs.com](mailto:CN.Doccheck@sgs.com)  
 No. 1 Workshop, M-10, Middle Section, Science & Technology Park, Nanshan District, Shenzhen, Guangdong, China 518057 t (86-755) 26012053 www.sgs.com.cn  
 中国·广东·深圳市南山区科技园中区M-10栋1号厂房 邮编: 518057 t (86-755) 26012053 sgs.china@sgs.com



**802.11n40\_Channel 6**



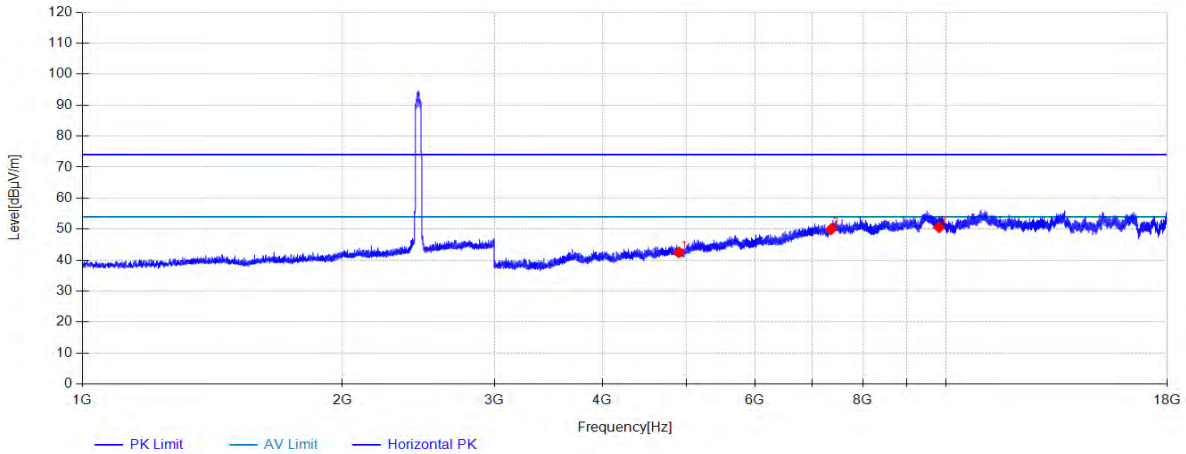
Final Data List										
NO.	Frequency [MHz]	Reading [dBµV]	AF[dB/m]	Factor [dB]	Level [dBµV/m]	Limit [dBµV/m]	Margin [dB]	Height [cm]	Angle [°]	Polarity
1	4874	54.95	30.74	-42.90	42.79	74.00	31.21	296	253	Vertical
2	7311	50.89	36.42	-38.81	48.50	74.00	25.50	360	126	Vertical
3	9748	49.62	38.30	-36.04	51.88	74.00	22.12	285	337	Vertical



Unless otherwise agreed in writing, this document is issued by the Company subject to its General Conditions of Service printed overleaf, available on request or accessible at <https://www.sgs.com/en/Terms-and-Conditions>. Attention is drawn to the limitation of liability, indemnification and jurisdiction issues defined therein. Any holder of this document is advised that information contained hereon reflects the Company's findings at the time of its intervention only and within the limits of Client's instructions, if any. The Company's sole responsibility is to its Client and this document does not exonerate parties to a transaction from exercising all their rights and obligations under the transaction documents. This document cannot be reproduced except in full, without prior written approval of the Company. Any unauthorized alteration, forgery or falsification of the content or appearance of this document is unlawful and offenders may be prosecuted to the fullest extent of the law. Unless otherwise stated the results shown in this test report refer only to the sample(s) tested and such sample(s) are retained for 30 days only.

Attention: To check the authenticity of testing / inspection report & certificate, please contact us at telephone: (86-755) 8307 1443, or email: [CN\\_Doccheck@sgs.com](mailto:CN_Doccheck@sgs.com)

No. 1 Workshop, M-10, Middle Section, Science & Technology Park, Nanshan District, Shenzhen, Guangdong, China 518057 t (86-755) 26012053 www.sgs.com.cn  
 中国·广东·深圳市南山区科技园中区M-10栋1号厂房 邮编: 518057 t (86-755) 26012053 sgs.china@sgs.com


**802.11n40\_Channel 9**


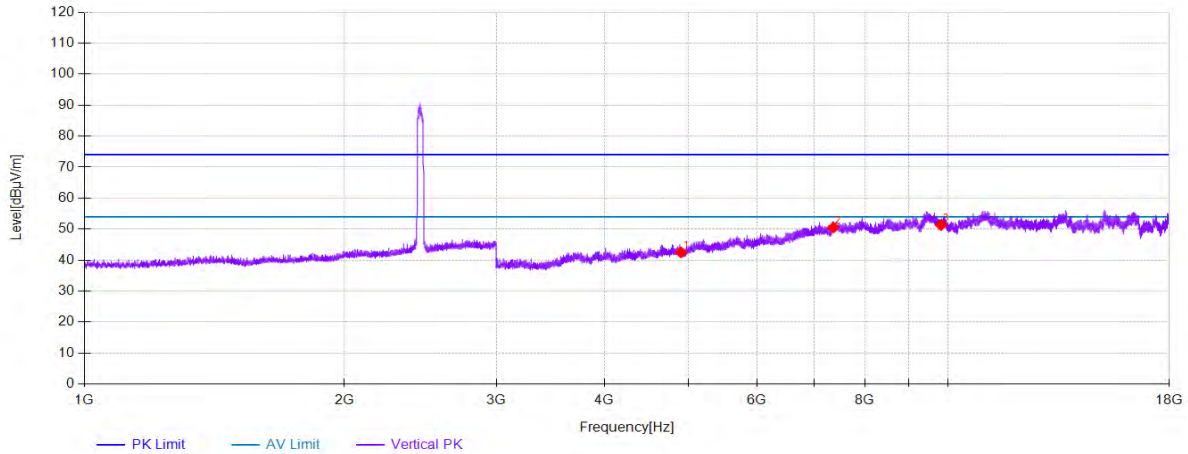
Final Data List										
NO.	Frequency [MHz]	Reading [dBμV]	AF[dB/m]	Factor [dB]	Level [dBμV/m]	Limit [dBμV/m]	Margin [dB]	Height [cm]	Angle [°]	Polarity
1	4904	54.47	30.91	-42.87	42.51	74.00	31.49	245	358	Horizontal
2	7356	51.97	36.53	-38.54	49.96	74.00	24.04	189	148	Horizontal
3	9808	47.81	38.45	-35.67	50.59	74.00	23.41	263	348	Horizontal



Unless otherwise agreed in writing, this document is issued by the Company subject to its General Conditions of Service printed overleaf, available on request or accessible at <https://www.sgs.com/en/Terms-and-Conditions>. Attention is drawn to the limitation of liability, indemnification and jurisdiction issues defined therein. Any holder of this document is advised that information contained hereon reflects the Company's findings at the time of its intervention only and within the limits of Client's instructions, if any. The Company's sole responsibility is to its Client and this document does not exonerate parties to a transaction from exercising all their rights and obligations under the transaction documents. This document cannot be reproduced except in full, without prior written approval of the Company. Any unauthorized alteration, forgery or falsification of the content or appearance of this document is unlawful and offenders may be prosecuted to the fullest extent of the law. Unless otherwise stated the results shown in this test report refer only to the sample(s) tested and such sample(s) are retained for 30 days only.

Attention: To check the authenticity of testing / inspection report & certificate, please contact us at telephone: (86-755) 8307 1443, or email: [CN.Doccheck@sgs.com](mailto:CN.Doccheck@sgs.com)

No. 1 Workshop, M-10, Middle Section, Science & Technology Park, Nanshan District, Shenzhen, Guangdong, China 518057 t (86-755) 26012053 www.sgs.com.cn  
 中国·广东·深圳市南山区科技园中区M-10栋1号厂房 邮编: 518057 t (86-755) 26012053 sgs.china@sgs.com


**802.11n40\_Channel 9**


Final Data List										
NO.	Frequency [MHz]	Reading [dBμV]	AF[dB/m]	Factor [dB]	Level [dBμV/m]	Limit [dBμV/m]	Margin [dB]	Height [cm]	Angle [°]	Polarity
1	4904	54.48	30.91	-42.87	42.52	74.00	31.48	287	274	Vertical
2	7356	52.51	36.53	-38.54	50.50	74.00	23.50	266	179	Vertical
3	9808	48.52	38.45	-35.67	51.30	74.00	22.70	363	242	Vertical

**Remark:**

- The field strength is calculated by adding the Antenna Factor, Cable Factor & Preamplifier gain. The basic equation with a sample calculation is as follows:  
 $Level = Reading(dB\mu V) + AF(dB/m) + Factor(dB)$   
 $AF = Antenna\ Factor(dB/m)$   
 $Factor = Cable\ Factor(dB) - Preamplifier\ gain(dB)$   
 $Margin = Limit(dB\mu V/m) - Level(dB\mu V/m)$
- All channels have been tested, but only the worst case data displayed in this report.
- Both peak and average measured complies with the limit line, so test result is "PASS".



Unless otherwise agreed in writing, this document is issued by the Company subject to its General Conditions of Service printed overleaf, available on request or accessible at <https://www.sgs.com/en/Terms-and-Conditions>. Attention is drawn to the limitation of liability, indemnification and jurisdiction issues defined therein. Any holder of this document is advised that information contained hereon reflects the Company's findings at the time of its intervention only and within the limits of Client's instructions, if any. The Company's sole responsibility is to its Client and this document does not exonerate parties to a transaction from exercising all their rights and obligations under the transaction documents. This document cannot be reproduced except in full, without prior written approval of the Company. Any unauthorized alteration, forgery or falsification of the content or appearance of this document is unlawful and offenders may be prosecuted to the fullest extent of the law. Unless otherwise stated the results shown in this test report refer only to the sample(s) tested and such sample(s) are retained for 30 days only.

Attention: To check the authenticity of testing / inspection report & certificate, please contact us at telephone: (86-755) 8307 1443, or email: [CN\\_Doccheck@sgs.com](mailto:CN_Doccheck@sgs.com)

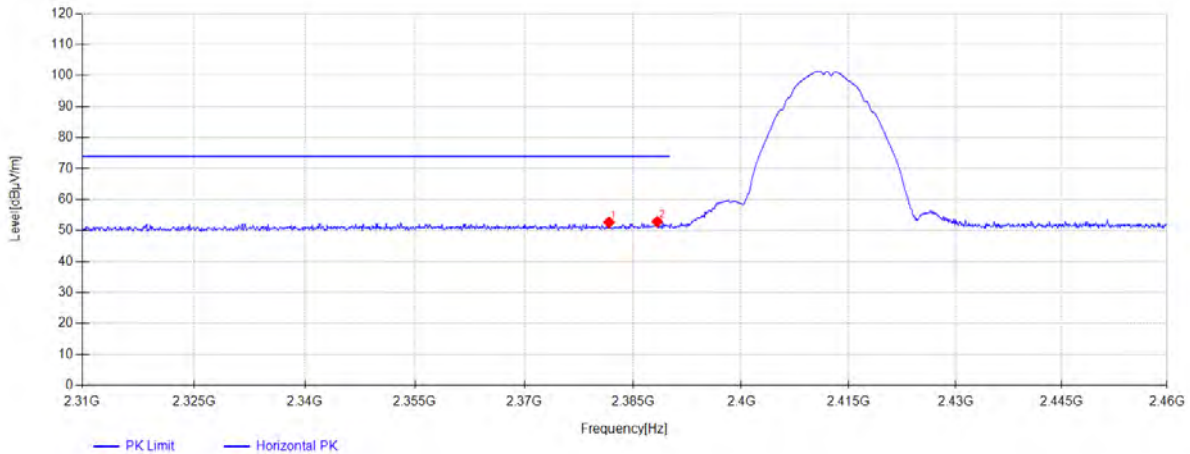
No. 1 Workshop, M-10, Middle Section, Science & Technology Park, Nanshan District, Shenzhen, Guangdong, China 518057 t (86-755) 26012053 www.sgsgroup.com.cn  
 中国·广东·深圳市南山区科技园中区M-10栋1号厂房 邮编: 518057 t (86-755) 26012053 sgs.china@sgs.com





## Restricted bands around fundamental frequency

### 802.11b\_Channel 1



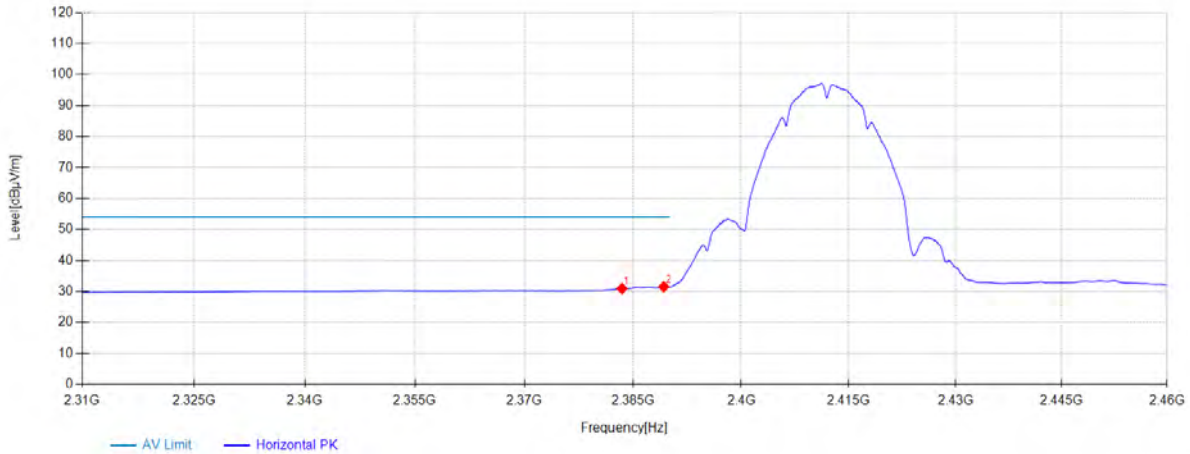
Final Data List										
NO.	Frequency [MHz]	Reading [dBμV]	AF[dB/m]	Factor [dB]	Level [dBμV/m]	Limit [dBμV/m]	Margin [dB]	Height [cm]	Angle [°]	Polarity
1	2381.6608	48.22	27.47	-23.03	52.66	74.00	21.34	100	46	Horizontal
2	2388.3392	48.44	27.45	-23.02	52.87	74.00	21.13	100	46	Horizontal



Unless otherwise agreed in writing, this document is issued by the Company subject to its General Conditions of Service printed overleaf, available on request or accessible at <https://www.sgs.com/en/Terms-and-Conditions>. Attention is drawn to the limitation of liability, indemnification and jurisdiction issues defined therein. Any holder of this document is advised that information contained hereon reflects the Company's findings at the time of its intervention only and within the limits of Client's instructions, if any. The Company's sole responsibility is to its Client and this document does not exonerate parties to a transaction from exercising all their rights and obligations under the transaction documents. This document cannot be reproduced except in full, without prior written approval of the Company. Any unauthorized alteration, forgery or falsification of the content or appearance of this document is unlawful and offenders may be prosecuted to the fullest extent of the law. Unless otherwise stated the results shown in this test report refer only to the sample(s) tested and such sample(s) are retained for 30 days only.

Attention: To check the authenticity of testing / inspection report & certificate, please contact us at telephone: (86-755) 8307 1443, or email: [CN.Doccheck@sgs.com](mailto:CN.Doccheck@sgs.com)

No. 1 Workshop, M-10, Middle Section, Science & Technology Park, Nanshan District, Shenzhen, Guangdong, China 518057 t (86-755) 26012053 www.sgs.com.cn  
 中国·广东·深圳市南山区科技园中区M-10栋1号厂房 邮编: 518057 t (86-755) 26012053 sgs.china@sgs.com


**802.11b\_Channel 1**


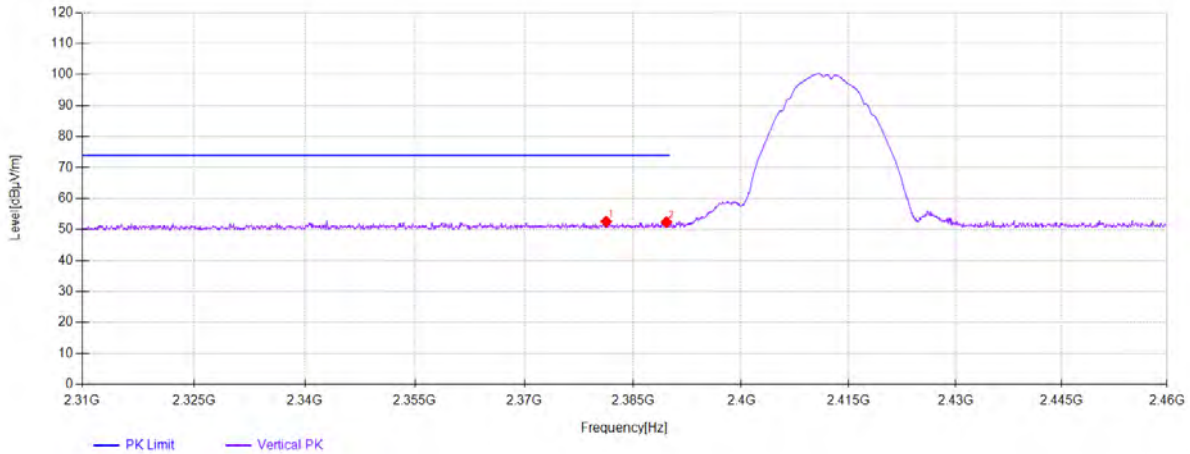
Final Data List										
NO.	Frequency [MHz]	Reading [dBμV]	AF[dB/m]	Factor [dB]	Level [dBμV/m]	Limit [dBμV/m]	Margin [dB]	Height [cm]	Angle [°]	Polarity
1	2383.4617	26.50	27.47	-23.03	30.94	54.00	23.06	100	46	Horizontal
2	2389.2396	27.11	27.44	-23.02	31.53	54.00	22.47	100	46	Horizontal



Unless otherwise agreed in writing, this document is issued by the Company subject to its General Conditions of Service printed overleaf, available on request or accessible at <https://www.sgs.com/en/Terms-and-Conditions>. Attention is drawn to the limitation of liability, indemnification and jurisdiction issues defined therein. Any holder of this document is advised that information contained hereon reflects the Company's findings at the time of its intervention only and within the limits of Client's instructions, if any. The Company's sole responsibility is to its Client and this document does not exonerate parties to a transaction from exercising all their rights and obligations under the transaction documents. This document cannot be reproduced except in full, without prior written approval of the Company. Any unauthorized alteration, forgery or falsification of the content or appearance of this document is unlawful and offenders may be prosecuted to the fullest extent of the law. Unless otherwise stated the results shown in this test report refer only to the sample(s) tested and such sample(s) are retained for 30 days only.

Attention: To check the authenticity of testing / inspection report & certificate, please contact us at telephone: (86-755) 8307 1443, or email: [CN.Doccheck@sgs.com](mailto:CN.Doccheck@sgs.com)

No. 1 Workshop, M-10, Middle Section, Science & Technology Park, Nanshan District, Shenzhen, Guangdong, China 518057 t (86-755) 26012053 www.sgs.com.cn  
 中国·广东·深圳市南山区科技园中区M-10栋1号厂房 邮编: 518057 t (86-755) 26012053 sgs.china@sgs.com


**802.11b\_Channel 1**


Final Data List										
NO.	Frequency [MHz]	Reading [dBµV]	AF[dB/m]	Factor [dB]	Level [dBµV/m]	Limit [dBµV/m]	Margin [dB]	Height [cm]	Angle [°]	Polarity
1	2381.2856	48.15	27.47	-23.03	52.59	74.00	21.41	360	160	Vertical
2	2389.6148	47.99	27.44	-23.02	52.41	74.00	21.59	360	160	Vertical



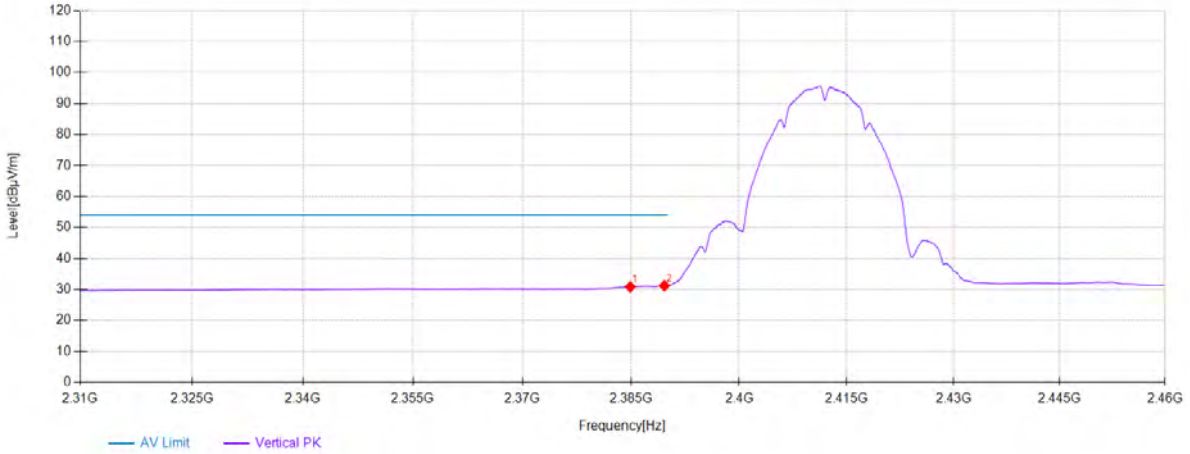
Unless otherwise agreed in writing, this document is issued by the Company subject to its General Conditions of Service printed overleaf, available on request or accessible at <https://www.sgs.com/en/Terms-and-Conditions>. Attention is drawn to the limitation of liability, indemnification and jurisdiction issues defined therein. Any holder of this document is advised that information contained hereon reflects the Company's findings at the time of its intervention only and within the limits of Client's instructions, if any. The Company's sole responsibility is to its Client and this document does not exonerate parties to a transaction from exercising all their rights and obligations under the transaction documents. This document cannot be reproduced except in full, without prior written approval of the Company. Any unauthorized alteration, forgery or falsification of the content or appearance of this document is unlawful and offenders may be prosecuted to the fullest extent of the law. Unless otherwise stated the results shown in this test report refer only to the sample(s) tested and such sample(s) are retained for 30 days only.

Attention: To check the authenticity of testing / inspection report & certificate, please contact us at telephone: (86-755) 8307 1443, or email: [CN\\_Doccheck@sgs.com](mailto:CN_Doccheck@sgs.com)

No. 1 Workshop, M-10, Middle Section, Science & Technology Park, Nanshan District, Shenzhen, Guangdong, China 518057 t (86-755) 26012053 www.sgs.com.cn  
 中国·广东·深圳市南山区科技园中区M-10栋1号厂房 邮编: 518057 t (86-755) 26012053 sgs.china@sgs.com



**802.11b\_Channel 1**



Final Data List										
NO.	Frequency [MHz]	Reading [dBµV]	AF[dB/m]	Factor [dB]	Level [dBµV/m]	Limit [dBµV/m]	Margin [dB]	Height [cm]	Angle [°]	Polarity
1	2384.8874	26.43	27.46	-23.02	30.87	54.00	23.13	360	160	Vertical
2	2389.6148	26.80	27.44	-23.02	31.22	54.00	22.78	360	160	Vertical



Unless otherwise agreed in writing, this document is issued by the Company subject to its General Conditions of Service printed overleaf, available on request or accessible at <https://www.sgs.com/en/Terms-and-Conditions>. Attention is drawn to the limitation of liability, indemnification and jurisdiction issues defined therein. Any holder of this document is advised that information contained hereon reflects the Company's findings at the time of its intervention only and within the limits of Client's instructions, if any. The Company's sole responsibility is to its Client and this document does not exonerate parties to a transaction from exercising all their rights and obligations under the transaction documents. This document cannot be reproduced except in full, without prior written approval of the Company. Any unauthorized alteration, forgery or falsification of the content or appearance of this document is unlawful and offenders may be prosecuted to the fullest extent of the law. Unless otherwise stated the results shown in this test report refer only to the sample(s) tested and such sample(s) are retained for 30 days only.

Attention: To check the authenticity of testing / inspection report & certificate, please contact us at telephone: (86-755) 8307 1443, or email: [CN\\_Doccheck@sgs.com](mailto:CN_Doccheck@sgs.com)  
 No. 1 Workshop, M-10, Middle Section, Science & Technology Park, Nanshan District, Shenzhen, Guangdong, China 518057 t (86-755) 26012053 www.sgs.com.cn  
 中国·广东·深圳市南山区科技园中区M-10栋1号厂房 邮编: 518057 t (86-755) 26012053 sgs.china@sgs.com

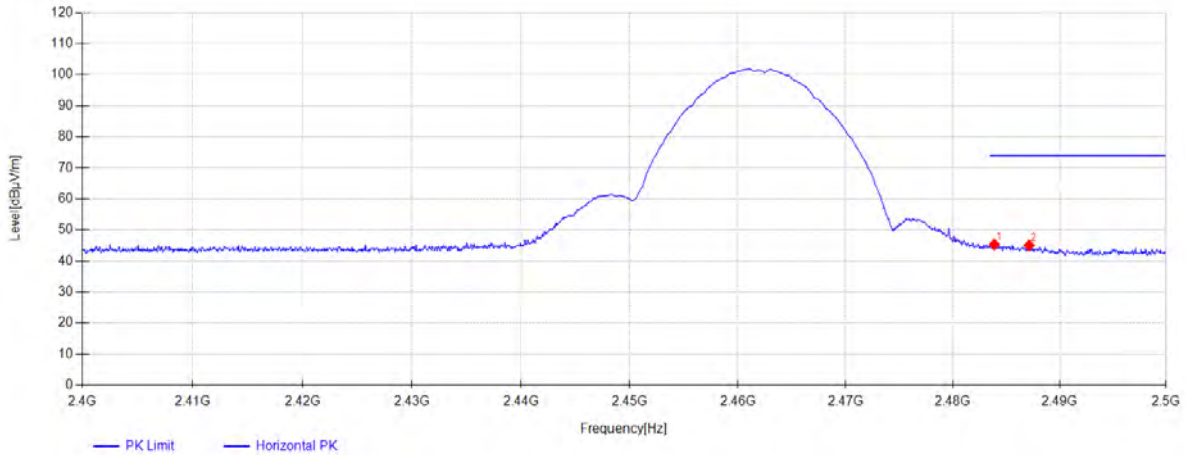




**SGS-CSTC Standards Technical Services Co., Ltd.**  
**Shenzhen Branch**

Report No.: ZEWM2303000343RG05  
 Page: 109 of 136

**802.11b\_Channel 11**



Final Data List										
NO.	Frequency [MHz]	Reading [dBµV]	AF[dB/m]	Factor [dB]	Level [dBµV/m]	Limit [dBµV/m]	Margin [dB]	Height [cm]	Angle [°]	Polarity
1	2483.8919	40.72	27.74	-23.12	45.34	74.00	28.66	185	51	Horizontal
2	2487.1436	40.41	27.75	-23.12	45.04	74.00	28.96	185	51	Horizontal



Unless otherwise agreed in writing, this document is issued by the Company subject to its General Conditions of Service printed overleaf, available on request or accessible at <https://www.sgs.com/en/Terms-and-Conditions>. Attention is drawn to the limitation of liability, indemnification and jurisdiction issues defined therein. Any holder of this document is advised that information contained hereon reflects the Company's findings at the time of its intervention only and within the limits of Client's instructions, if any. The Company's sole responsibility is to its Client and this document does not exonerate parties to a transaction from exercising all their rights and obligations under the transaction documents. This document cannot be reproduced except in full, without prior written approval of the Company. Any unauthorized alteration, forgery or falsification of the content or appearance of this document is unlawful and offenders may be prosecuted to the fullest extent of the law. Unless otherwise stated the results shown in this test report refer only to the sample(s) tested and such sample(s) are retained for 30 days only.

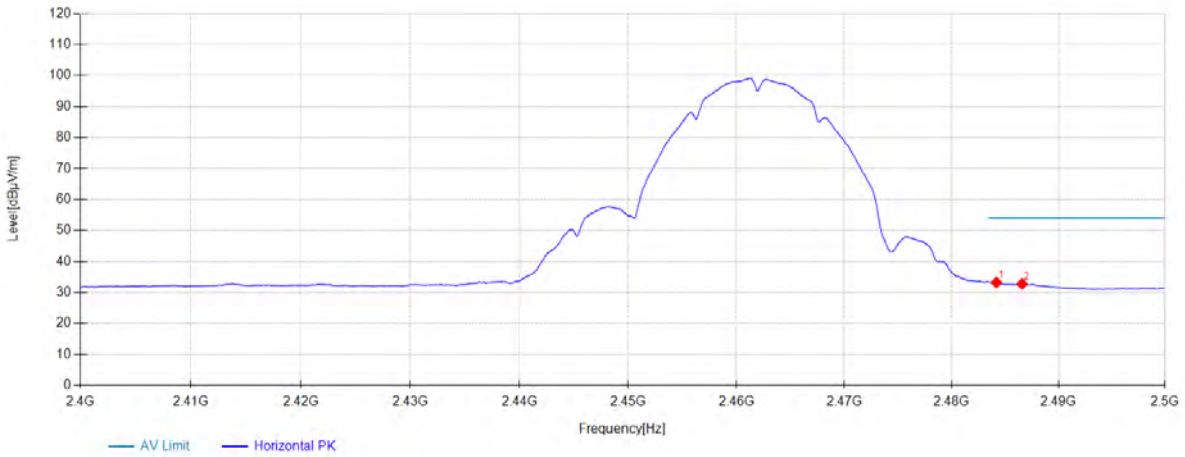
Attention: To check the authenticity of testing / inspection report & certificate, please contact us at telephone: (86-755) 8307 1443, or email: [CN\\_Doccheck@sgs.com](mailto:CN_Doccheck@sgs.com)  
 No.1 Workshop, M-10, Middle Section, Science & Technology Park, Nanshan District, Shenzhen, Guangdong, China 518057 t (86-755) 26012053 www.sgs.com.cn  
 中国·广东·深圳市南山区科技园中区M-10栋1号厂房 邮编: 518057 t (86-755) 26012053 sgs.china@sgs.com



**SGS-CSTC Standards Technical Services Co., Ltd.**  
**Shenzhen Branch**

Report No.: ZEWM2303000343RG05  
 Page: 110 of 136

**802.11b\_Channel 11**

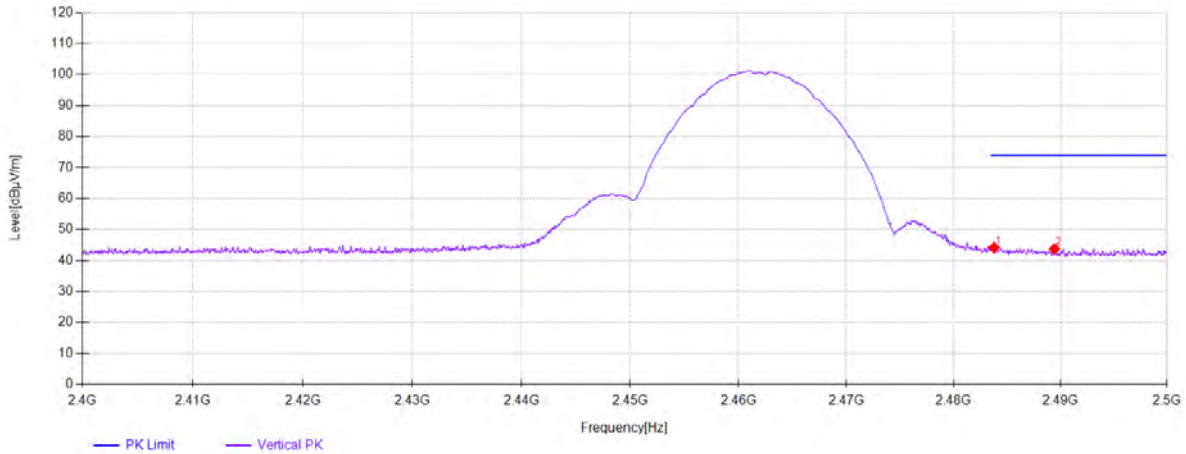


Final Data List										
NO.	Frequency [MHz]	Reading [dBµV]	AF[dB/m]	Factor [dB]	Level [dBµV/m]	Limit [dBµV/m]	Margin [dB]	Height [cm]	Angle [°]	Polarity
1	2484.1921	28.62	27.74	-23.12	33.24	54.00	20.76	185	51	Horizontal
2	2486.5933	28.16	27.75	-23.12	32.79	54.00	21.21	185	51	Horizontal



Unless otherwise agreed in writing, this document is issued by the Company subject to its General Conditions of Service printed overleaf, available on request or accessible at <https://www.sgs.com/en/Terms-and-Conditions>. Attention is drawn to the limitation of liability, indemnification and jurisdiction issues defined therein. Any holder of this document is advised that information contained hereon reflects the Company's findings at the time of its intervention only and within the limits of Client's instructions, if any. The Company's sole responsibility is to its Client and this document does not exonerate parties to a transaction from exercising all their rights and obligations under the transaction documents. This document cannot be reproduced except in full, without prior written approval of the Company. Any unauthorized alteration, forgery or falsification of the content or appearance of this document is unlawful and offenders may be prosecuted to the fullest extent of the law. Unless otherwise stated the results shown in this test report refer only to the sample(s) tested and such sample(s) are retained for 30 days only.

Attention: To check the authenticity of testing / inspection report & certificate, please contact us at telephone: (86-755) 8307 1443, or email: [CN.Doccheck@sgs.com](mailto:CN.Doccheck@sgs.com)  
 No.1 Workshop, M-10, Middle Section, Science & Technology Park, Nanshan District, Shenzhen, Guangdong, China 518057 t (86-755) 26012053 www.sgs.com.cn  
 中国·广东·深圳市南山区科技园中区M-10栋1号厂房 邮编: 518057 t (86-755) 26012053 sgs.china@sgs.com


**802.11b\_Channel 11**


Final Data List										
NO.	Frequency [MHz]	Reading [dBμV]	AF[dB/m]	Factor [dB]	Level [dBμV/m]	Limit [dBμV/m]	Margin [dB]	Height [cm]	Angle [°]	Polarity
1	2483.7919	39.54	27.74	-23.12	44.16	74.00	29.84	400	160	Vertical
2	2489.4447	39.09	27.76	-23.13	43.72	74.00	30.28	400	160	Vertical



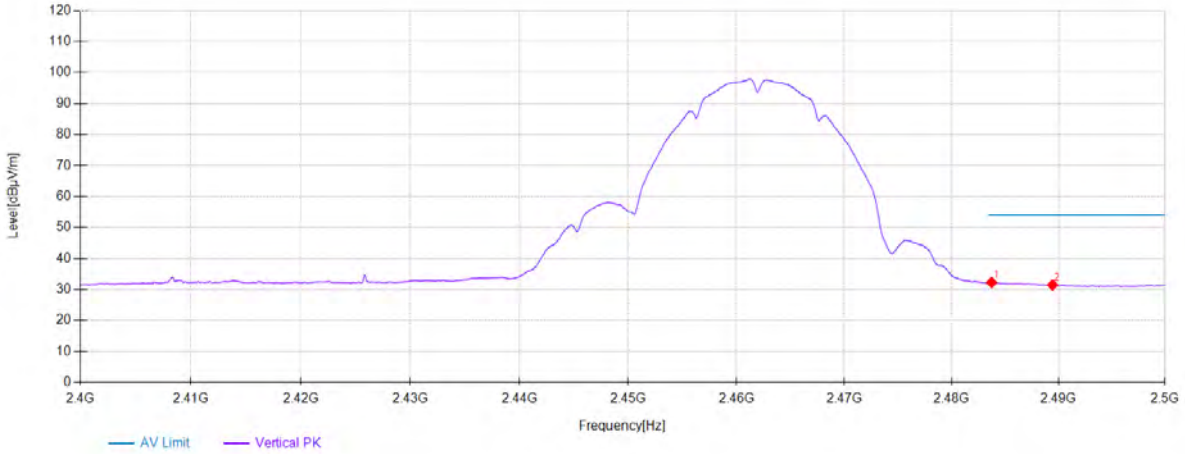
Unless otherwise agreed in writing, this document is issued by the Company subject to its General Conditions of Service printed overleaf, available on request or accessible at <https://www.sgs.com/en/Terms-and-Conditions>. Attention is drawn to the limitation of liability, indemnification and jurisdiction issues defined therein. Any holder of this document is advised that information contained hereon reflects the Company's findings at the time of its intervention only and within the limits of Client's instructions, if any. The Company's sole responsibility is to its Client and this document does not exonerate parties to a transaction from exercising all their rights and obligations under the transaction documents. This document cannot be reproduced except in full, without prior written approval of the Company. Any unauthorized alteration, forgery or falsification of the content or appearance of this document is unlawful and offenders may be prosecuted to the fullest extent of the law. Unless otherwise stated the results shown in this test report refer only to the sample(s) tested and such sample(s) are retained for 30 days only.

Attention: To check the authenticity of testing / inspection report & certificate, please contact us at telephone: (86-755) 8307 1443, or email: [CN\\_Doccheck@sgs.com](mailto:CN_Doccheck@sgs.com)

No. 1 Workshop, M-10, Middle Section, Science & Technology Park, Nanshan District, Shenzhen, Guangdong, China 518057 t (86-755) 26012053 www.sgsgroup.com.cn  
 中国·广东·深圳市南山区科技园中区M-10栋1号厂房 邮编: 518057 t (86-755) 26012053 sgs.china@sgs.com



**802.11b\_Channel 11**



Final Data List										
NO.	Frequency [MHz]	Reading [dBµV]	AF[dB/m]	Factor [dB]	Level [dBµV/m]	Limit [dBµV/m]	Margin [dB]	Height [cm]	Angle [°]	Polarity
1	2483.7419	27.66	27.73	-23.12	32.27	54.00	21.73	400	160	Vertical
2	2489.4447	26.83	27.76	-23.13	31.46	54.00	22.54	400	160	Vertical



Unless otherwise agreed in writing, this document is issued by the Company subject to its General Conditions of Service printed overleaf, available on request or accessible at <https://www.sgs.com/en/Terms-and-Conditions>. Attention is drawn to the limitation of liability, indemnification and jurisdiction issues defined therein. Any holder of this document is advised that information contained hereon reflects the Company's findings at the time of its intervention only and within the limits of Client's instructions, if any. The Company's sole responsibility is to its Client and this document does not exonerate parties to a transaction from exercising all their rights and obligations under the transaction documents. This document cannot be reproduced except in full, without prior written approval of the Company. Any unauthorized alteration, forgery or falsification of the content or appearance of this document is unlawful and offenders may be prosecuted to the fullest extent of the law. Unless otherwise stated the results shown in this test report refer only to the sample(s) tested and such sample(s) are retained for 30 days only.

Attention: To check the authenticity of testing / inspection report & certificate, please contact us at telephone: (86-755) 8307 1443, or email: [CN\\_Doccheck@sgs.com](mailto:CN_Doccheck@sgs.com)

No. 1 Workshop, M-10, Middle Section, Science & Technology Park, Nanshan District, Shenzhen, Guangdong, China 518057 t (86-755) 26012053 www.sgs.com.cn  
 中国·广东·深圳市南山区科技园中区M-10栋1号厂房 邮编: 518057 t (86-755) 26012053 sgs.china@sgs.com

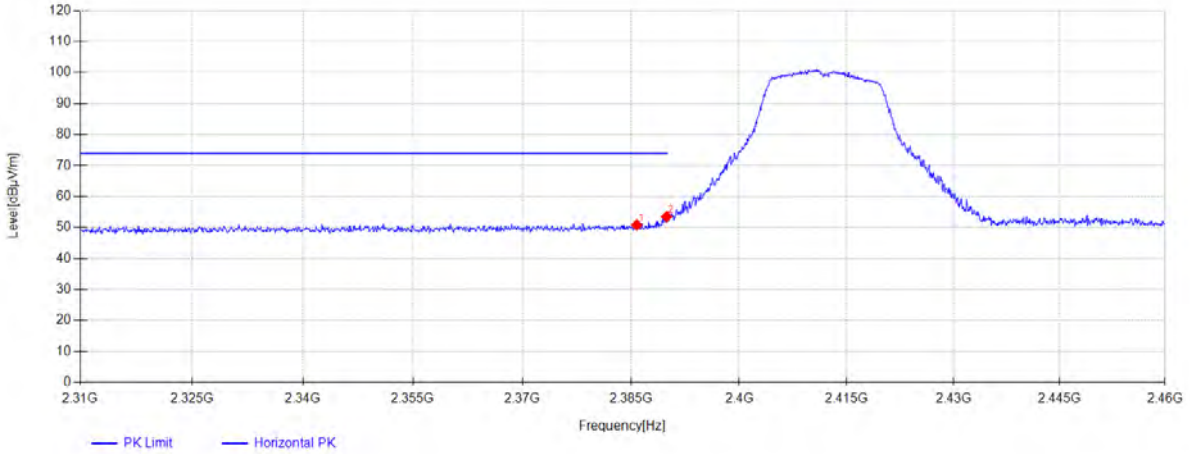




**SGS-CSTC Standards Technical Services Co., Ltd.**  
**Shenzhen Branch**

Report No.: ZEWM2303000343RG05  
 Page: 113 of 136

**802.11g\_Channel 1**



Final Data List										
NO.	Frequency [MHz]	Reading [dBµV]	AF[dB/m]	Factor [dB]	Level [dBµV/m]	Limit [dBµV/m]	Margin [dB]	Height [cm]	Angle [°]	Polarity
1	2385.7879	46.39	27.46	-23.02	50.83	74.00	23.17	105	50	Horizontal
2	2389.915	49.11	27.44	-23.02	53.53	74.00	20.47	105	50	Horizontal



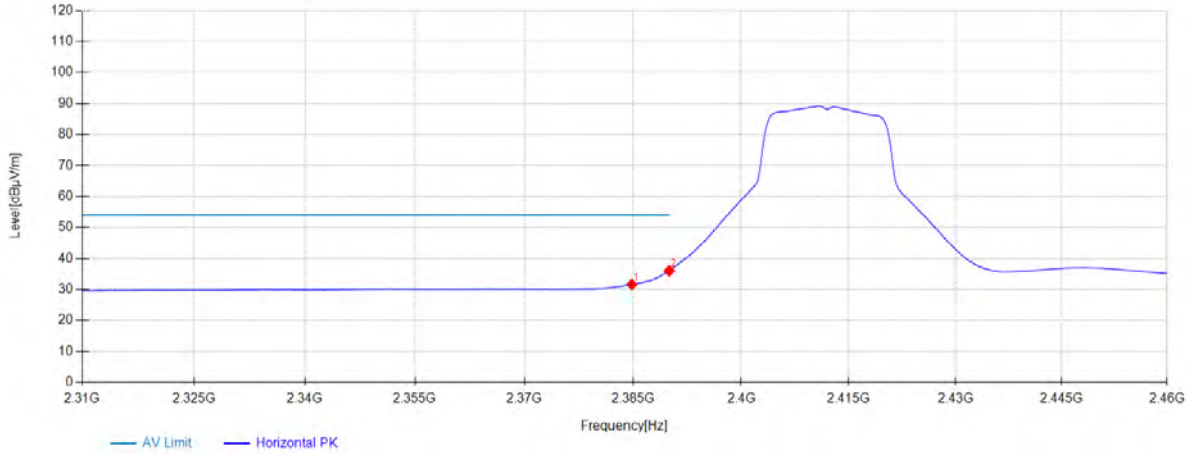
Unless otherwise agreed in writing, this document is issued by the Company subject to its General Conditions of Service printed overleaf, available on request or accessible at <https://www.sgs.com/en/Terms-and-Conditions>. Attention is drawn to the limitation of liability, indemnification and jurisdiction issues defined therein. Any holder of this document is advised that information contained hereon reflects the Company's findings at the time of its intervention only and within the limits of Client's instructions, if any. The Company's sole responsibility is to its Client and this document does not exonerate parties to a transaction from exercising all their rights and obligations under the transaction documents. This document cannot be reproduced except in full, without prior written approval of the Company. Any unauthorized alteration, forgery or falsification of the content or appearance of this document is unlawful and offenders may be prosecuted to the fullest extent of the law. Unless otherwise stated the results shown in this test report refer only to the sample(s) tested and such sample(s) are retained for 30 days only.

Attention: To check the authenticity of testing / inspection report & certificate, please contact us at telephone: (86-755) 8307 1443, or email: [CN.Doccheck@sgs.com](mailto:CN.Doccheck@sgs.com)

No. 1 Workshop, M-10, Middle Section, Science & Technology Park, Nanshan District, Shenzhen, Guangdong, China 518057 t (86-755) 26012053 www.sgs.com.cn  
 中国·广东·深圳市南山区科技园中区M-10栋1号厂房 邮编: 518057 t (86-755) 26012053 sgs.china@sgs.com



**802.11g\_Channel 1**



Final Data List										
NO.	Frequency [MHz]	Reading [dBµV]	AF[dB/m]	Factor [dB]	Level [dBµV/m]	Limit [dBµV/m]	Margin [dB]	Height [cm]	Angle [°]	Polarity
1	2384.8124	27.17	27.46	-23.02	31.61	54.00	22.39	105	50	Horizontal
2	2389.99	31.63	27.44	-23.02	36.05	54.00	17.95	105	50	Horizontal



Unless otherwise agreed in writing, this document is issued by the Company subject to its General Conditions of Service printed overleaf, available on request or accessible at <https://www.sgs.com/en/Terms-and-Conditions>. Attention is drawn to the limitation of liability, indemnification and jurisdiction issues defined therein. Any holder of this document is advised that information contained hereon reflects the Company's findings at the time of its intervention only and within the limits of Client's instructions, if any. The Company's sole responsibility is to its Client and this document does not exonerate parties to a transaction from exercising all their rights and obligations under the transaction documents. This document cannot be reproduced except in full, without prior written approval of the Company. Any unauthorized alteration, forgery or falsification of the content or appearance of this document is unlawful and offenders may be prosecuted to the fullest extent of the law. Unless otherwise stated the results shown in this test report refer only to the sample(s) tested and such sample(s) are retained for 30 days only.

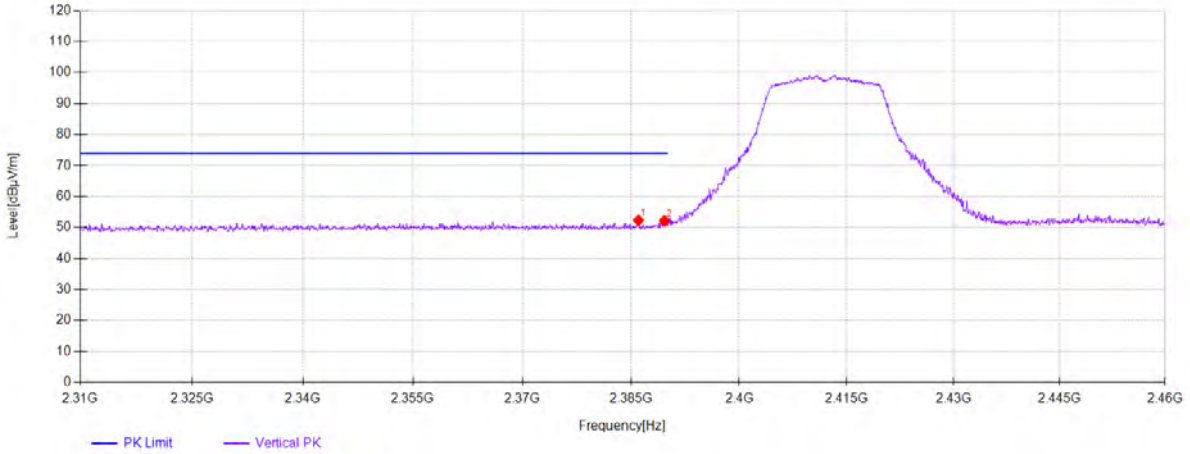
Attention: To check the authenticity of testing / inspection report & certificate, please contact us at telephone: (86-755) 8307 1443, or email: [CN.Doccheck@sgs.com](mailto:CN.Doccheck@sgs.com)  
 No. 1 Workshop, M-10, Middle Section, Science & Technology Park, Nanshan District, Shenzhen, Guangdong, China 518057 t (86-755) 26012053 www.sgs.com.cn  
 中国·广东·深圳市南山区科技园中区M-10栋1号厂房 邮编: 518057 t (86-755) 26012053 sgs.china@sgs.com



**SGS-CSTC Standards Technical Services Co., Ltd.**  
**Shenzhen Branch**

Report No.: ZEWM2303000343RG05  
 Page: 115 of 136

**802.11g\_Channel 1**



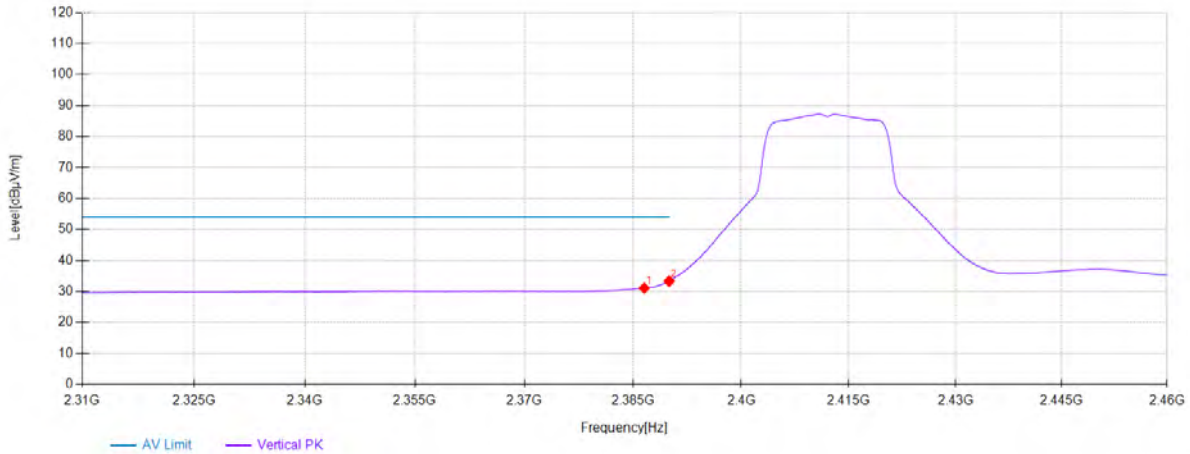
Final Data List										
NO.	Frequency [MHz]	Reading [dBµV]	AF[dB/m]	Factor [dB]	Level [dBµV/m]	Limit [dBµV/m]	Margin [dB]	Height [cm]	Angle [°]	Polarity
1	2386.013	47.88	27.46	-23.02	52.32	74.00	21.68	398	158	Vertical
2	2389.6148	47.71	27.44	-23.02	52.13	74.00	21.87	398	158	Vertical



Unless otherwise agreed in writing, this document is issued by the Company subject to its General Conditions of Service printed overleaf, available on request or accessible at <https://www.sgs.com/en/Terms-and-Conditions>. Attention is drawn to the limitation of liability, indemnification and jurisdiction issues defined therein. Any holder of this document is advised that information contained hereon reflects the Company's findings at the time of its intervention only and within the limits of Client's instructions, if any. The Company's sole responsibility is to its Client and this document does not exonerate parties to a transaction from exercising all their rights and obligations under the transaction documents. This document cannot be reproduced except in full, without prior written approval of the Company. Any unauthorized alteration, forgery or falsification of the content or appearance of this document is unlawful and offenders may be prosecuted to the fullest extent of the law. Unless otherwise stated the results shown in this test report refer only to the sample(s) tested and such sample(s) are retained for 30 days only.

Attention: To check the authenticity of testing / inspection report & certificate, please contact us at telephone: (86-755) 8307 1443, or email: [CN.Doccheck@sgs.com](mailto:CN.Doccheck@sgs.com)

No. 1 Workshop, M-10, Middle Section, Science & Technology Park, Nanshan District, Shenzhen, Guangdong, China 518057 t (86-755) 26012053 www.sgs.com.cn  
 中国·广东·深圳市南山区科技园中区M-10栋1号厂房 邮编: 518057 t (86-755) 26012053 sgs.china@sgs.com


**802.11g\_Channel 1**


Final Data List										
NO.	Frequency [MHz]	Reading [dBµV]	AF[dB/m]	Factor [dB]	Level [dBµV/m]	Limit [dBµV/m]	Margin [dB]	Height [cm]	Angle [°]	Polarity
1	2386.5383	26.66	27.45	-23.02	31.09	54.00	22.91	398	158	Vertical
2	2389.99	28.93	27.44	-23.02	33.35	54.00	20.65	398	158	Vertical



Unless otherwise agreed in writing, this document is issued by the Company subject to its General Conditions of Service printed overleaf, available on request or accessible at <https://www.sgs.com/en/Terms-and-Conditions>. Attention is drawn to the limitation of liability, indemnification and jurisdiction issues defined therein. Any holder of this document is advised that information contained hereon reflects the Company's findings at the time of its intervention only and within the limits of Client's instructions, if any. The Company's sole responsibility is to its Client and this document does not exonerate parties to a transaction from exercising all their rights and obligations under the transaction documents. This document cannot be reproduced except in full, without prior written approval of the Company. Any unauthorized alteration, forgery or falsification of the content or appearance of this document is unlawful and offenders may be prosecuted to the fullest extent of the law. Unless otherwise stated the results shown in this test report refer only to the sample(s) tested and such sample(s) are retained for 30 days only.

Attention: To check the authenticity of testing / inspection report & certificate, please contact us at telephone: (86-755) 8307 1443, or email: [CN.Doccheck@sgs.com](mailto:CN.Doccheck@sgs.com)

No. 1 Workshop, M-10, Middle Section, Science & Technology Park, Nanshan District, Shenzhen, Guangdong, China 518057 t (86-755) 26012053 www.sgs.com.cn  
 中国·广东·深圳市南山区科技园中区M-10栋1号厂房 邮编: 518057 t (86-755) 26012053 sgs.china@sgs.com

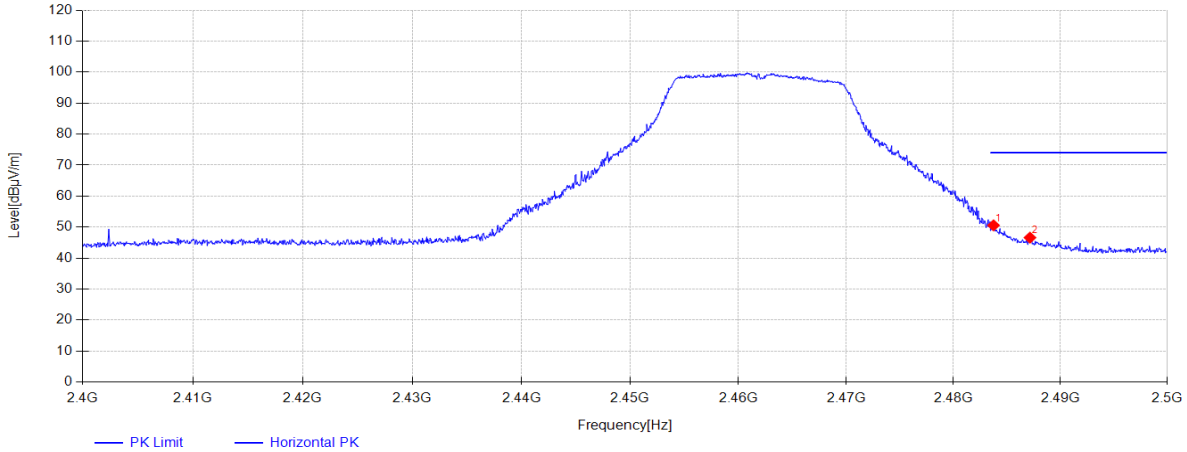




**SGS-CSTC Standards Technical Services Co., Ltd.**  
**Shenzhen Branch**

Report No.: ZEWM2303000343RG05  
 Page: 117 of 136

**802.11g\_Channel 11**



Final Data List										
NO.	Frequency [MHz]	Reading [dBμV]	AF[dB/m]	Factor [dB]	Level [dBμV/m]	Limit [dBμV/m]	Margin [dB]	Height [cm]	Angle [°]	Polarity
1	2483.7419	45.96	27.73	-23.12	50.57	74.00	23.43	110	55	Horizontal
2	2487.1436	41.98	27.75	-23.12	46.61	74.00	27.39	110	55	Horizontal



Unless otherwise agreed in writing, this document is issued by the Company subject to its General Conditions of Service printed overleaf, available on request or accessible at <https://www.sgs.com/en/Terms-and-Conditions>. Attention is drawn to the limitation of liability, indemnification and jurisdiction issues defined therein. Any holder of this document is advised that information contained hereon reflects the Company's findings at the time of its intervention only and within the limits of Client's instructions, if any. The Company's sole responsibility is to its Client and this document does not exonerate parties to a transaction from exercising all their rights and obligations under the transaction documents. This document cannot be reproduced except in full, without prior written approval of the Company. Any unauthorized alteration, forgery or falsification of the content or appearance of this document is unlawful and offenders may be prosecuted to the fullest extent of the law. Unless otherwise stated the results shown in this test report refer only to the sample(s) tested and such sample(s) are retained for 30 days only.

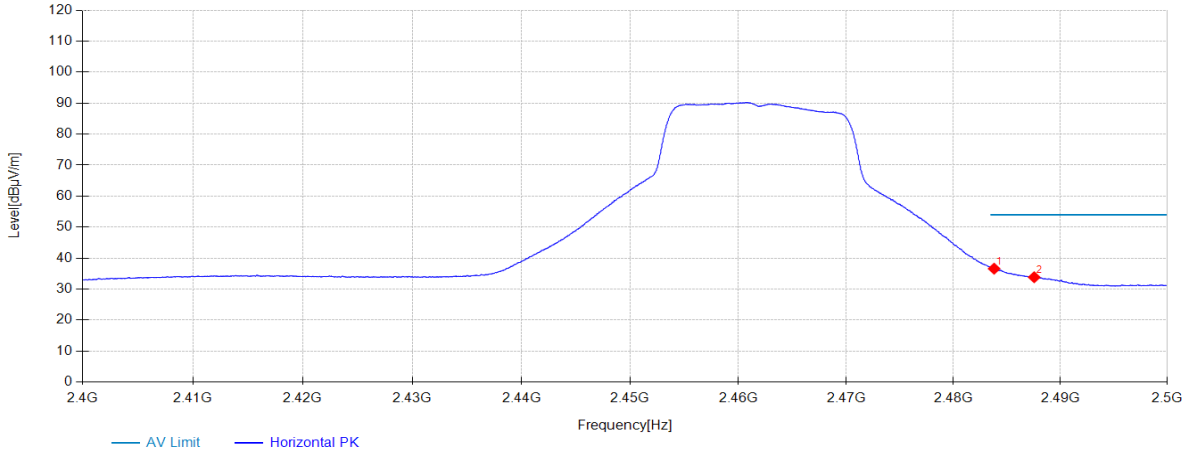
Attention: To check the authenticity of testing / inspection report & certificate, please contact us at telephone: (86-755) 8307 1443, or email: [CN\\_Doccheck@sgs.com](mailto:CN_Doccheck@sgs.com)  
 No. 1 Workshop, M-10, Middle Section, Science & Technology Park, Nanshan District, Shenzhen, Guangdong, China 518057 t (86-755) 26012053 www.sgs.com.cn  
 中国·广东·深圳市南山区科技园中区M-10栋1号厂房 邮编: 518057 t (86-755) 26012053 sgs.china@sgs.com



**SGS-CSTC Standards Technical Services Co., Ltd.**  
**Shenzhen Branch**

Report No.: ZEWM2303000343RG05  
 Page: 118 of 136

**802.11g\_Channel 11**



Final Data List										
NO.	Frequency [MHz]	Reading [dBμV]	AF[dB/m]	Factor [dB]	Level [dBμV/m]	Limit [dBμV/m]	Margin [dB]	Height [cm]	Angle [°]	Polarity
1	2483.7919	31.98	27.74	-23.12	36.60	54.00	17.40	110	55	Horizontal
2	2487.5438	29.21	27.75	-23.12	33.84	54.00	20.16	110	55	Horizontal



Unless otherwise agreed in writing, this document is issued by the Company subject to its General Conditions of Service printed overleaf, available on request or accessible at <https://www.sgs.com/en/Terms-and-Conditions>. Attention is drawn to the limitation of liability, indemnification and jurisdiction issues defined therein. Any holder of this document is advised that information contained hereon reflects the Company's findings at the time of its intervention only and within the limits of Client's instructions, if any. The Company's sole responsibility is to its Client and this document does not exonerate parties to a transaction from exercising all their rights and obligations under the transaction documents. This document cannot be reproduced except in full, without prior written approval of the Company. Any unauthorized alteration, forgery or falsification of the content or appearance of this document is unlawful and offenders may be prosecuted to the fullest extent of the law. Unless otherwise stated the results shown in this test report refer only to the sample(s) tested and such sample(s) are retained for 30 days only.

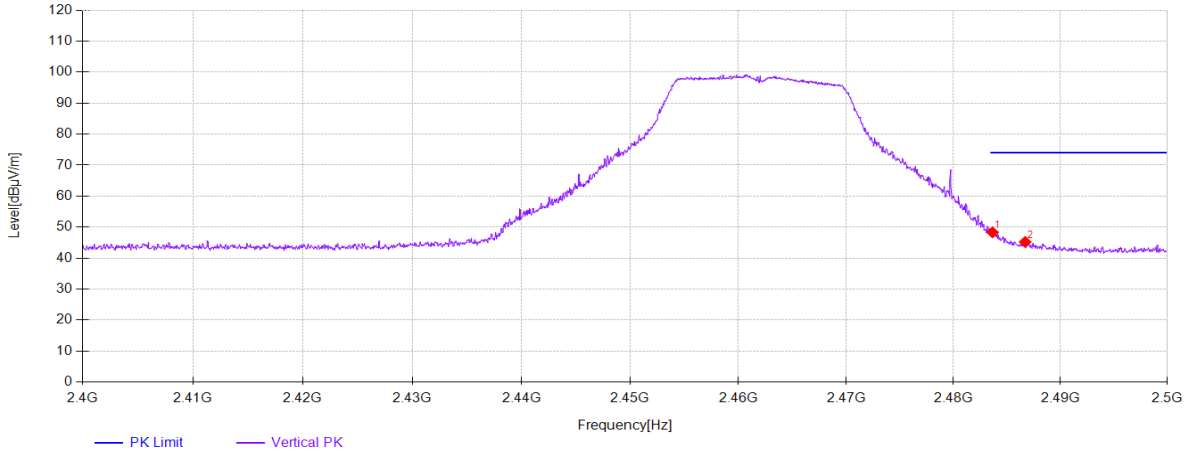
Attention: To check the authenticity of testing / inspection report & certificate, please contact us at telephone: (86-755) 8307 1443, or email: [CN\\_Doccheck@sgs.com](mailto:CN_Doccheck@sgs.com)  
 No. 1 Workshop, M-10, Middle Section, Science & Technology Park, Nanshan District, Shenzhen, Guangdong, China 518057 t (86-755) 26012053 www.sgs.com.cn  
 中国·广东·深圳市南山区科技园中区M-10栋1号厂房 邮编: 518057 t (86-755) 26012053 sgs.china@sgs.com



**SGS-CSTC Standards Technical Services Co., Ltd.**  
**Shenzhen Branch**

Report No.: ZEWM2303000343RG05  
 Page: 119 of 136

**802.11g\_Channel 11**



Final Data List										
NO.	Frequency [MHz]	Reading [dBµV]	AF[dB/m]	Factor [dB]	Level [dBµV/m]	Limit [dBµV/m]	Margin [dB]	Height [cm]	Angle [°]	Polarity
1	2483.6418	43.71	27.73	-23.12	48.32	74.00	25.68	390	168	Vertical
2	2486.6933	40.58	27.75	-23.12	45.21	74.00	28.79	390	168	Vertical



Unless otherwise agreed in writing, this document is issued by the Company subject to its General Conditions of Service printed overleaf, available on request or accessible at <https://www.sgs.com/en/Terms-and-Conditions>. Attention is drawn to the limitation of liability, indemnification and jurisdiction issues defined therein. Any holder of this document is advised that information contained hereon reflects the Company's findings at the time of its intervention only and within the limits of Client's instructions, if any. The Company's sole responsibility is to its Client and this document does not exonerate parties to a transaction from exercising all their rights and obligations under the transaction documents. This document cannot be reproduced except in full, without prior written approval of the Company. Any unauthorized alteration, forgery or falsification of the content or appearance of this document is unlawful and offenders may be prosecuted to the fullest extent of the law. Unless otherwise stated the results shown in this test report refer only to the sample(s) tested and such sample(s) are retained for 30 days only.

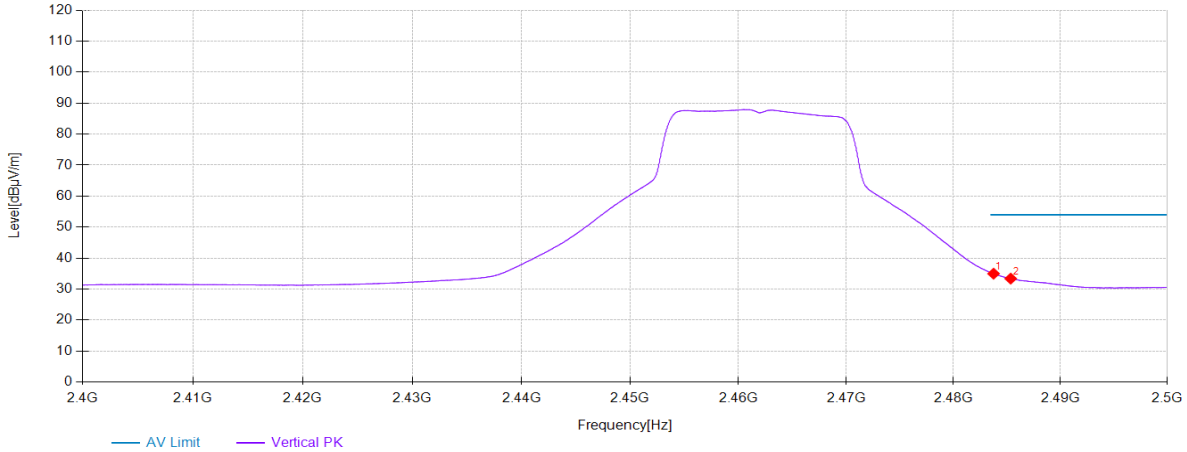
Attention: To check the authenticity of testing / inspection report & certificate, please contact us at telephone: (86-755) 8307 1443, or email: [CN.Doccheck@sgs.com](mailto:CN.Doccheck@sgs.com)  
 No. 1 Workshop, M-10, Middle Section, Science & Technology Park, Nanshan District, Shenzhen, Guangdong, China 518057 t (86-755) 26012053 www.sgs.com.cn  
 中国·广东·深圳市南山区科技园中区M-10栋1号厂房 邮编: 518057 t (86-755) 26012053 sgs.china@sgs.com



**SGS-CSTC Standards Technical Services Co., Ltd.**  
**Shenzhen Branch**

Report No.: ZEWM2303000343RG05  
 Page: 120 of 136

**802.11g\_Channel 11**



Final Data List										
NO.	Frequency [MHz]	Reading [dBµV]	AF[dB/m]	Factor [dB]	Level [dBµV/m]	Limit [dBµV/m]	Margin [dB]	Height [cm]	Angle [°]	Polarity
1	2483.7419	30.38	27.73	-23.12	34.99	54.00	19.01	390	168	Vertical
2	2485.3427	28.78	27.74	-23.12	33.40	54.00	20.60	390	168	Vertical



Unless otherwise agreed in writing, this document is issued by the Company subject to its General Conditions of Service printed overleaf, available on request or accessible at <https://www.sgs.com/en/Terms-and-Conditions>. Attention is drawn to the limitation of liability, indemnification and jurisdiction issues defined therein. Any holder of this document is advised that information contained hereon reflects the Company's findings at the time of its intervention only and within the limits of Client's instructions, if any. The Company's sole responsibility is to its Client and this document does not exonerate parties to a transaction from exercising all their rights and obligations under the transaction documents. This document cannot be reproduced except in full, without prior written approval of the Company. Any unauthorized alteration, forgery or falsification of the content or appearance of this document is unlawful and offenders may be prosecuted to the fullest extent of the law. Unless otherwise stated the results shown in this test report refer only to the sample(s) tested and such sample(s) are retained for 30 days only.

Attention: To check the authenticity of testing / inspection report & certificate, please contact us at telephone: (86-755) 8307 1443, or email: [CN\\_Doccheck@sgs.com](mailto:CN_Doccheck@sgs.com)  
 No. 1 Workshop, M-10, Middle Section, Science & Technology Park, Nanshan District, Shenzhen, Guangdong, China 518057 t (86-755) 26012053 www.sgs.com.cn  
 中国·广东·深圳市南山区科技园中区M-10栋1号厂房 邮编: 518057 t (86-755) 26012053 sgs.china@sgs.com

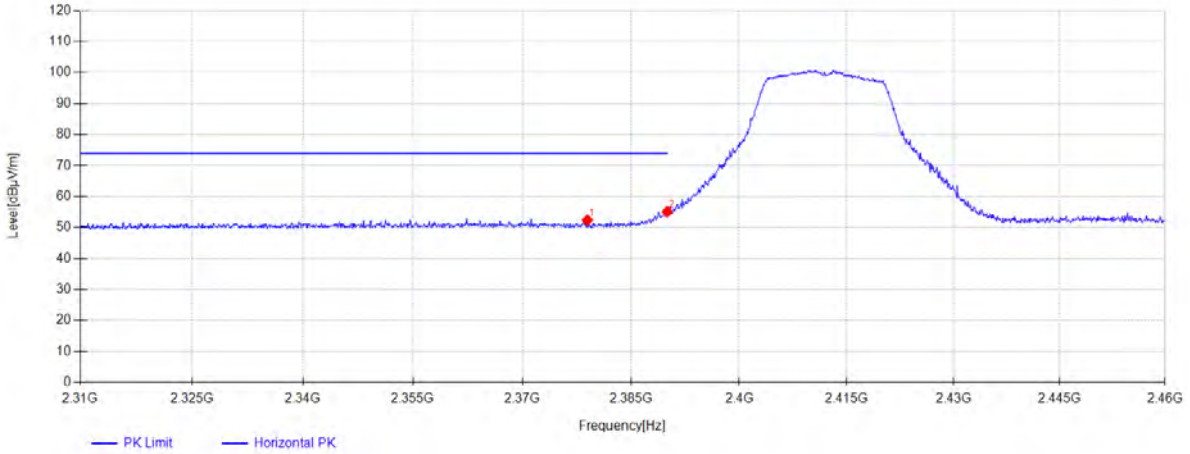




**SGS-CSTC Standards Technical Services Co., Ltd.**  
**Shenzhen Branch**

Report No.: ZEWM2303000343RG05  
 Page: 121 of 136

**802.11n20\_Channel 1**



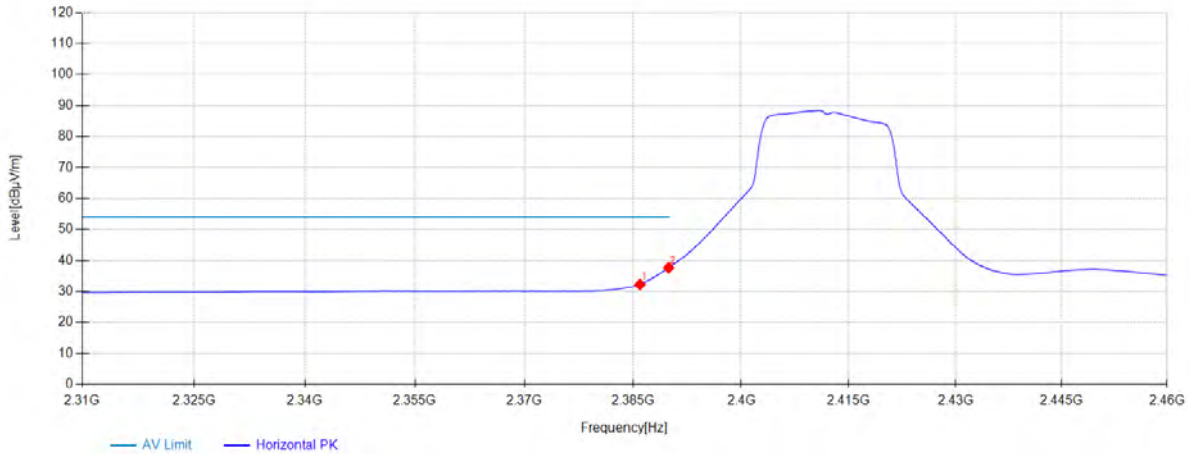
Final Data List										
NO.	Frequency [MHz]	Reading [dBµV]	AF[dB/m]	Factor [dB]	Level [dBµV/m]	Limit [dBµV/m]	Margin [dB]	Height [cm]	Angle [°]	Polarity
1	2378.9595	47.92	27.48	-23.03	52.37	74.00	21.63	150	48	Horizontal
2	2389.99	50.68	27.44	-23.02	55.10	74.00	18.90	150	48	Horizontal



Unless otherwise agreed in writing, this document is issued by the Company subject to its General Conditions of Service printed overleaf, available on request or accessible at <https://www.sgs.com/en/Terms-and-Conditions>. Attention is drawn to the limitation of liability, indemnification and jurisdiction issues defined therein. Any holder of this document is advised that information contained hereon reflects the Company's findings at the time of its intervention only and within the limits of Client's instructions, if any. The Company's sole responsibility is to its Client and this document does not exonerate parties to a transaction from exercising all their rights and obligations under the transaction documents. This document cannot be reproduced except in full, without prior written approval of the Company. Any unauthorized alteration, forgery or falsification of the content or appearance of this document is unlawful and offenders may be prosecuted to the fullest extent of the law. Unless otherwise stated the results shown in this test report refer only to the sample(s) tested and such sample(s) are retained for 30 days only.

Attention: To check the authenticity of testing / inspection report & certificate, please contact us at telephone: (86-755) 8307 1443, or email: [CN.Doccheck@sgs.com](mailto:CN.Doccheck@sgs.com)

No. 1 Workshop, M-10, Middle Section, Science & Technology Park, Nanshan District, Shenzhen, Guangdong, China 518057 t (86-755) 26012053 www.sgs.com.cn  
 中国·广东·深圳市南山区科技园中区M-10栋1号厂房 邮编: 518057 t (86-755) 26012053 sgs.china@sgs.com


**802.11n20\_Channel 1**


Final Data List										
NO.	Frequency [MHz]	Reading [dBμV]	AF[dB/m]	Factor [dB]	Level [dBμV/m]	Limit [dBμV/m]	Margin [dB]	Height [cm]	Angle [°]	Polarity
1	2385.938	27.80	27.46	-23.02	32.24	54.00	21.76	150	48	Horizontal
2	2389.915	33.26	27.44	-23.02	37.68	54.00	16.32	150	48	Horizontal



Unless otherwise agreed in writing, this document is issued by the Company subject to its General Conditions of Service printed overleaf, available on request or accessible at <https://www.sgs.com/en/Terms-and-Conditions>. Attention is drawn to the limitation of liability, indemnification and jurisdiction issues defined therein. Any holder of this document is advised that information contained hereon reflects the Company's findings at the time of its intervention only and within the limits of Client's instructions, if any. The Company's sole responsibility is to its Client and this document does not exonerate parties to a transaction from exercising all their rights and obligations under the transaction documents. This document cannot be reproduced except in full, without prior written approval of the Company. Any unauthorized alteration, forgery or falsification of the content or appearance of this document is unlawful and offenders may be prosecuted to the fullest extent of the law. Unless otherwise stated the results shown in this test report refer only to the sample(s) tested and such sample(s) are retained for 30 days only.

Attention: To check the authenticity of testing / inspection report & certificate, please contact us at telephone: (86-755) 8307 1443, or email: [CN.Doccheck@sgs.com](mailto:CN.Doccheck@sgs.com)

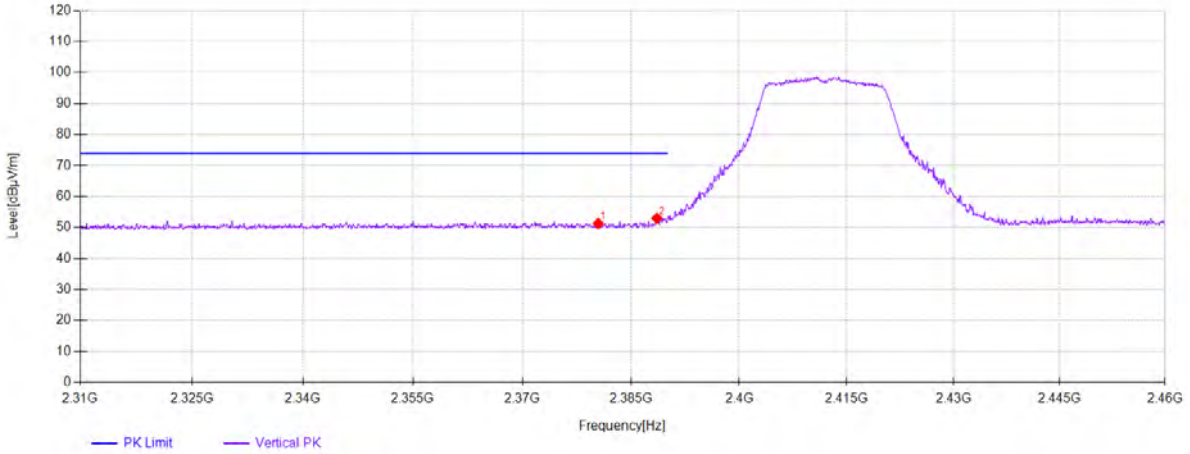
No. 1 Workshop, M-10, Middle Section, Science & Technology Park, Nanshan District, Shenzhen, Guangdong, China 518057 t (86-755) 26012053 www.sgs.com.cn  
 中国·广东·深圳市南山区科技园中区M-10栋1号厂房 邮编: 518057 t (86-755) 26012053 sgs.china@sgs.com



**SGS-CSTC Standards Technical Services Co., Ltd.**  
**Shenzhen Branch**

Report No.: ZEWM2303000343RG05  
 Page: 123 of 136

**802.11n20\_Channel 1**



Final Data List										
NO.	Frequency [MHz]	Reading [dBµV]	AF[dB/m]	Factor [dB]	Level [dBµV/m]	Limit [dBµV/m]	Margin [dB]	Height [cm]	Angle [°]	Polarity
1	2380.4602	46.84	27.48	-23.03	51.29	74.00	22.71	388	152	Vertical
2	2388.5643	48.55	27.45	-23.02	52.98	74.00	21.02	388	152	Vertical

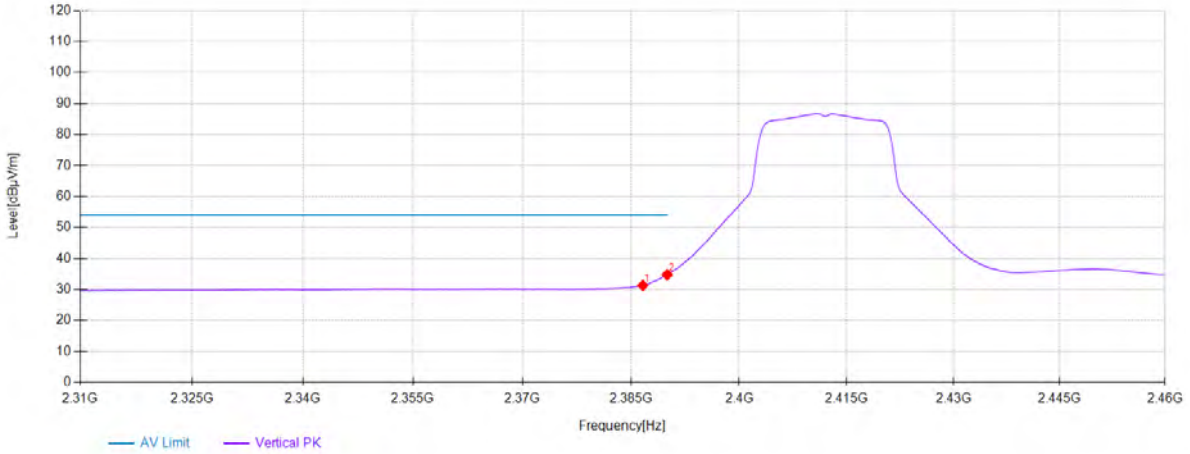


Unless otherwise agreed in writing, this document is issued by the Company subject to its General Conditions of Service printed overleaf, available on request or accessible at <https://www.sgs.com/en/Terms-and-Conditions>. Attention is drawn to the limitation of liability, indemnification and jurisdiction issues defined therein. Any holder of this document is advised that information contained hereon reflects the Company's findings at the time of its intervention only and within the limits of Client's instructions, if any. The Company's sole responsibility is to its Client and this document does not exonerate parties to a transaction from exercising all their rights and obligations under the transaction documents. This document cannot be reproduced except in full, without prior written approval of the Company. Any unauthorized alteration, forgery or falsification of the content or appearance of this document is unlawful and offenders may be prosecuted to the fullest extent of the law. Unless otherwise stated the results shown in this test report refer only to the sample(s) tested and such sample(s) are retained for 30 days only.

Attention: To check the authenticity of testing / inspection report & certificate, please contact us at telephone: (86-755) 8307 1443, or email: [CN.Doccheck@sgs.com](mailto:CN.Doccheck@sgs.com)  
 No. 1 Workshop, M-10, Middle Section, Science & Technology Park, Nanshan District, Shenzhen, Guangdong, China 518057 t (86-755) 26012053 www.sgs.com.cn  
 中国·广东·深圳市南山区科技园中区M-10栋1号厂房 邮编: 518057 t (86-755) 26012053 sgs.china@sgs.com



**802.11n20\_Channel 1**



Final Data List										
NO.	Frequency [MHz]	Reading [dBµV]	AF[dB/m]	Factor [dB]	Level [dBµV/m]	Limit [dBµV/m]	Margin [dB]	Height [cm]	Angle [°]	Polarity
1	2386.6133	26.89	27.45	-23.02	31.32	54.00	22.68	388	152	Vertical
2	2389.99	30.36	27.44	-23.02	34.78	54.00	19.22	388	152	Vertical



Unless otherwise agreed in writing, this document is issued by the Company subject to its General Conditions of Service printed overleaf, available on request or accessible at <https://www.sgs.com/en/Terms-and-Conditions>. Attention is drawn to the limitation of liability, indemnification and jurisdiction issues defined therein. Any holder of this document is advised that information contained hereon reflects the Company's findings at the time of its intervention only and within the limits of Client's instructions, if any. The Company's sole responsibility is to its Client and this document does not exonerate parties to a transaction from exercising all their rights and obligations under the transaction documents. This document cannot be reproduced except in full, without prior written approval of the Company. Any unauthorized alteration, forgery or falsification of the content or appearance of this document is unlawful and offenders may be prosecuted to the fullest extent of the law. Unless otherwise stated the results shown in this test report refer only to the sample(s) tested and such sample(s) are retained for 30 days only.

Attention: To check the authenticity of testing / inspection report & certificate, please contact us at telephone: (86-755) 8307 1443, or email: [CN.Doccheck@sgs.com](mailto:CN.Doccheck@sgs.com)  
 No. 1 Workshop, M-10, Middle Section, Science & Technology Park, Nanshan District, Shenzhen, Guangdong, China 518057 t (86-755) 26012053 www.sgsgroup.com.cn  
 中国·广东·深圳市南山区科技园中区M-10栋1号厂房 邮编: 518057 t (86-755) 26012053 sgs.china@sgs.com

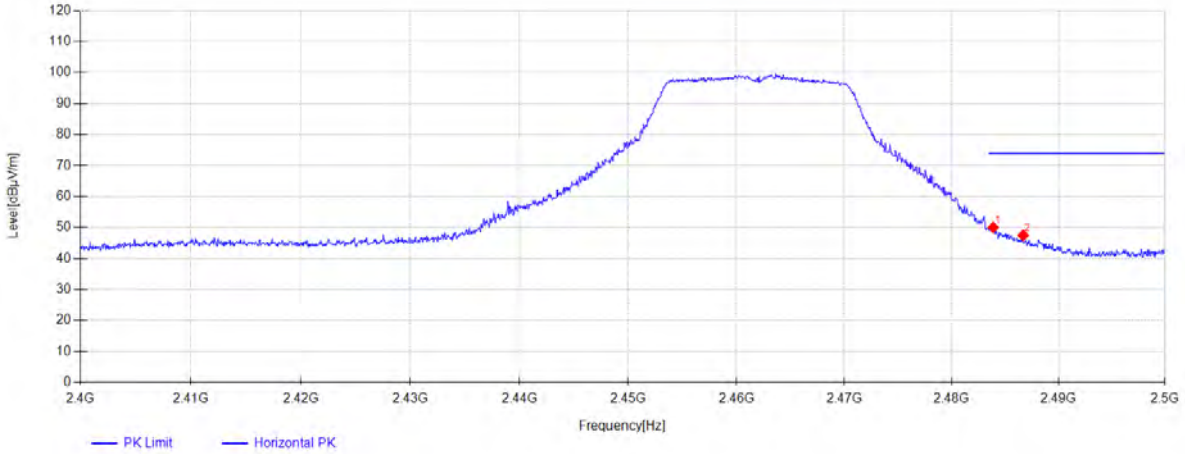




**SGS-CSTC Standards Technical Services Co., Ltd.**  
**Shenzhen Branch**

Report No.: ZEWM2303000343RG05  
 Page: 125 of 136

**802.11n20\_Channel 11**

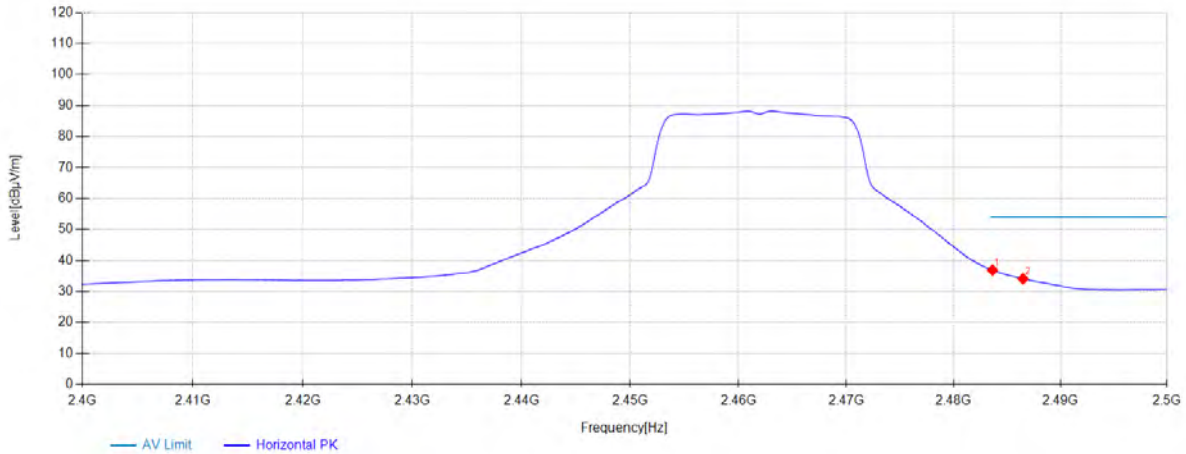


Final Data List										
NO.	Frequency [MHz]	Reading [dBμV]	AF[dB/m]	Factor [dB]	Level [dBμV/m]	Limit [dBμV/m]	Margin [dB]	Height [cm]	Angle [°]	Polarity
1	2483.8919	45.41	27.74	-23.12	50.03	74.00	23.97	120	60	Horizontal
2	2486.6933	42.85	27.75	-23.12	47.48	74.00	26.52	120	60	Horizontal



Unless otherwise agreed in writing, this document is issued by the Company subject to its General Conditions of Service printed overleaf, available on request or accessible at <https://www.sgs.com/en/Terms-and-Conditions>. Attention is drawn to the limitation of liability, indemnification and jurisdiction issues defined therein. Any holder of this document is advised that information contained hereon reflects the Company's findings at the time of its intervention only and within the limits of Client's instructions, if any. The Company's sole responsibility is to its Client and this document does not exonerate parties to a transaction from exercising all their rights and obligations under the transaction documents. This document cannot be reproduced except in full, without prior written approval of the Company. Any unauthorized alteration, forgery or falsification of the content or appearance of this document is unlawful and offenders may be prosecuted to the fullest extent of the law. Unless otherwise stated the results shown in this test report refer only to the sample(s) tested and such sample(s) are retained for 30 days only.

Attention: To check the authenticity of testing / inspection report & certificate, please contact us at telephone: (86-755) 8307 1443, or email: [CN\\_Doccheck@sgs.com](mailto:CN_Doccheck@sgs.com)  
 No. 1 Workshop, M-10, Middle Section, Science & Technology Park, Nanshan District, Shenzhen, Guangdong, China 518057 t (86-755) 26012053 www.sgs.com.cn  
 中国·广东·深圳市南山区科技园中区M-10栋1号厂房 邮编: 518057 t (86-755) 26012053 sgs.china@sgs.com


**802.11n20\_Channel 11**


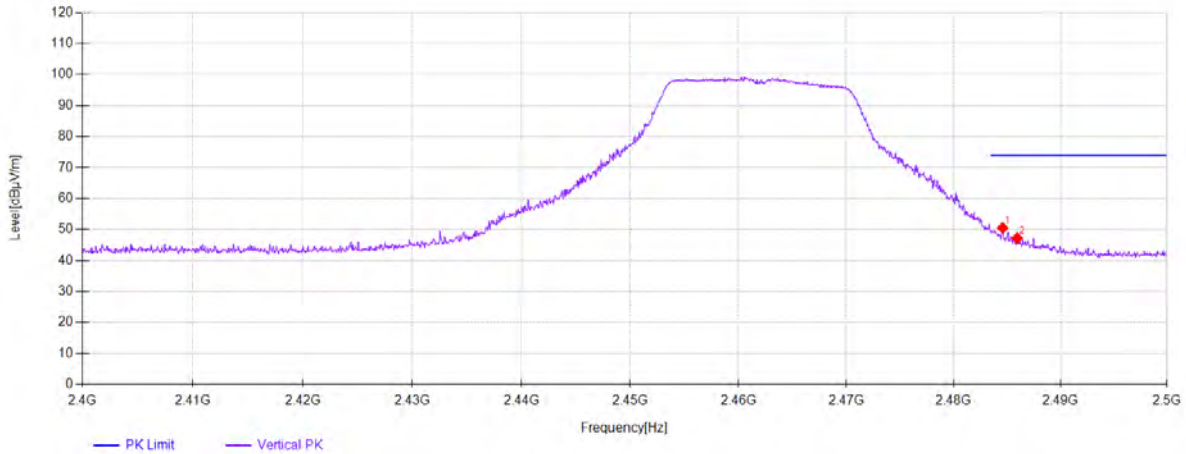
Final Data List										
NO.	Frequency [MHz]	Reading [dBμV]	AF[dB/m]	Factor [dB]	Level [dBμV/m]	Limit [dBμV/m]	Margin [dB]	Height [cm]	Angle [°]	Polarity
1	2483.6418	32.28	27.73	-23.12	36.89	54.00	17.11	120	60	Horizontal
2	2486.4932	29.46	27.75	-23.12	34.09	54.00	19.91	120	60	Horizontal



Unless otherwise agreed in writing, this document is issued by the Company subject to its General Conditions of Service printed overleaf, available on request or accessible at <https://www.sgs.com/en/Terms-and-Conditions>. Attention is drawn to the limitation of liability, indemnification and jurisdiction issues defined therein. Any holder of this document is advised that information contained hereon reflects the Company's findings at the time of its intervention only and within the limits of Client's instructions, if any. The Company's sole responsibility is to its Client and this document does not exonerate parties to a transaction from exercising all their rights and obligations under the transaction documents. This document cannot be reproduced except in full, without prior written approval of the Company. Any unauthorized alteration, forgery or falsification of the content or appearance of this document is unlawful and offenders may be prosecuted to the fullest extent of the law. Unless otherwise stated the results shown in this test report refer only to the sample(s) tested and such sample(s) are retained for 30 days only.

Attention: To check the authenticity of testing / inspection report & certificate, please contact us at telephone: (86-755) 8307 1443, or email: [CN\\_Doccheck@sgs.com](mailto:CN_Doccheck@sgs.com)

No. 1 Workshop, M-10, Middle Section, Science & Technology Park, Nanshan District, Shenzhen, Guangdong, China 518057 t (86-755) 26012053 www.sgs.com.cn  
 中国·广东·深圳市南山区科技园中区M-10栋1号厂房 邮编: 518057 t (86-755) 26012053 sgs.china@sgs.com


**802.11n20\_Channel 11**


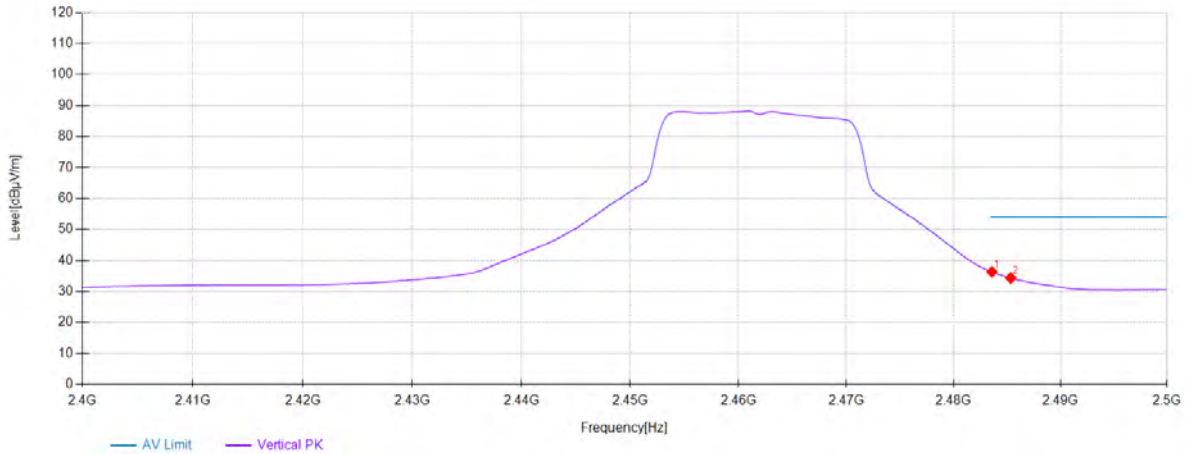
Final Data List										
NO.	Frequency [MHz]	Reading [dBμV]	AF[dB/m]	Factor [dB]	Level [dBμV/m]	Limit [dBμV/m]	Margin [dB]	Height [cm]	Angle [°]	Polarity
1	2484.5923	45.93	27.74	-23.12	50.55	74.00	23.45	395	162	Vertical
2	2485.943	42.58	27.74	-23.12	47.20	74.00	26.80	395	162	Vertical



Unless otherwise agreed in writing, this document is issued by the Company subject to its General Conditions of Service printed overleaf, available on request or accessible at <https://www.sgs.com/en/Terms-and-Conditions>. Attention is drawn to the limitation of liability, indemnification and jurisdiction issues defined therein. Any holder of this document is advised that information contained hereon reflects the Company's findings at the time of its intervention only and within the limits of Client's instructions, if any. The Company's sole responsibility is to its Client and this document does not exonerate parties to a transaction from exercising all their rights and obligations under the transaction documents. This document cannot be reproduced except in full, without prior written approval of the Company. Any unauthorized alteration, forgery or falsification of the content or appearance of this document is unlawful and offenders may be prosecuted to the fullest extent of the law. Unless otherwise stated the results shown in this test report refer only to the sample(s) tested and such sample(s) are retained for 30 days only.

Attention: To check the authenticity of testing / inspection report & certificate, please contact us at telephone: (86-755) 8307 1443, or email: [CN\\_Doccheck@sgs.com](mailto:CN_Doccheck@sgs.com)

No. 1 Workshop, M-10, Middle Section, Science & Technology Park, Nanshan District, Shenzhen, Guangdong, China 518057 t (86-755) 26012053 www.sgs.com.cn  
 中国·广东·深圳市南山区科技园中区M-10栋1号厂房 邮编: 518057 t (86-755) 26012053 sgs.china@sgs.com


**802.11n20\_Channel 11**


Final Data List										
NO.	Frequency [MHz]	Reading [dBμV]	AF[dB/m]	Factor [dB]	Level [dBμV/m]	Limit [dBμV/m]	Margin [dB]	Height [cm]	Angle [°]	Polarity
1	2483.5918	31.72	27.73	-23.12	36.33	54.00	17.67	395	162	Vertical
2	2485.3427	29.73	27.74	-23.12	34.35	54.00	19.65	395	162	Vertical



Unless otherwise agreed in writing, this document is issued by the Company subject to its General Conditions of Service printed overleaf, available on request or accessible at <https://www.sgs.com/en/Terms-and-Conditions>. Attention is drawn to the limitation of liability, indemnification and jurisdiction issues defined therein. Any holder of this document is advised that information contained hereon reflects the Company's findings at the time of its intervention only and within the limits of Client's instructions, if any. The Company's sole responsibility is to its Client and this document does not exonerate parties to a transaction from exercising all their rights and obligations under the transaction documents. This document cannot be reproduced except in full, without prior written approval of the Company. Any unauthorized alteration, forgery or falsification of the content or appearance of this document is unlawful and offenders may be prosecuted to the fullest extent of the law. Unless otherwise stated the results shown in this test report refer only to the sample(s) tested and such sample(s) are retained for 30 days only.

Attention: To check the authenticity of testing / inspection report & certificate, please contact us at telephone: (86-755) 8307 1443, or email: [CN\\_Doccheck@sgs.com](mailto:CN_Doccheck@sgs.com)

No. 1 Workshop, M-10, Middle Section, Science & Technology Park, Nanshan District, Shenzhen, Guangdong, China 518057 t (86-755) 26012053 www.sgs.com.cn  
 中国·广东·深圳市南山区科技园中区M-10栋1号厂房 邮编: 518057 t (86-755) 26012053 sgs.china@sgs.com

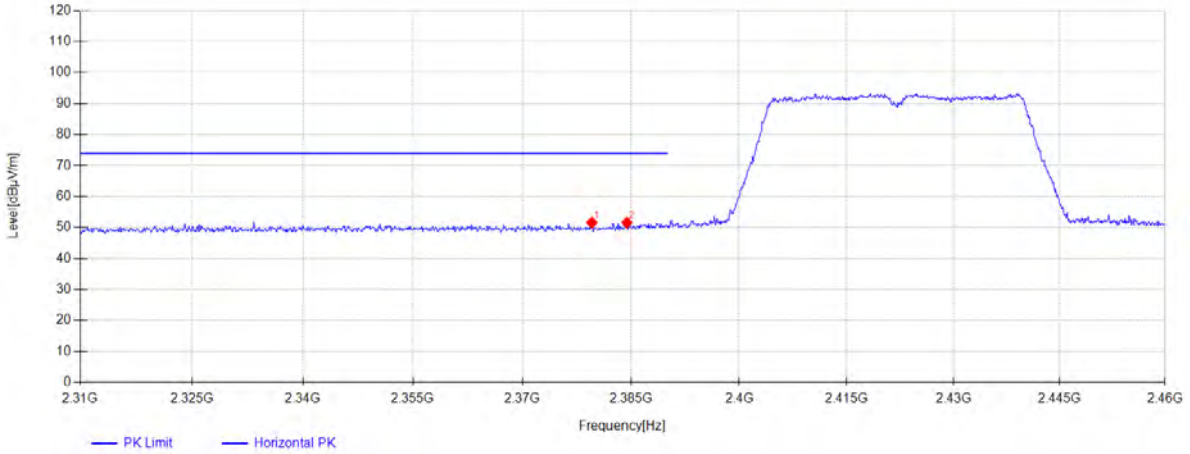




**SGS-CSTC Standards Technical Services Co., Ltd.**  
**Shenzhen Branch**

Report No.: ZEWM2303000343RG05  
 Page: 129 of 136

**802.11n40\_Channel 3**



Final Data List										
NO.	Frequency [MHz]	Reading [dBµV]	AF[dB/m]	Factor [dB]	Level [dBµV/m]	Limit [dBµV/m]	Margin [dB]	Height [cm]	Angle [°]	Polarity
1	2379.5748	47.15	27.48	-23.03	51.60	74.00	22.40	134	56	Horizontal
2	2384.4222	47.15	27.46	-23.02	51.59	74.00	22.41	134	56	Horizontal



Unless otherwise agreed in writing, this document is issued by the Company subject to its General Conditions of Service printed overleaf, available on request or accessible at <https://www.sgs.com/en/Terms-and-Conditions>. Attention is drawn to the limitation of liability, indemnification and jurisdiction issues defined therein. Any holder of this document is advised that information contained hereon reflects the Company's findings at the time of its intervention only and within the limits of Client's instructions, if any. The Company's sole responsibility is to its Client and this document does not exonerate parties to a transaction from exercising all their rights and obligations under the transaction documents. This document cannot be reproduced except in full, without prior written approval of the Company. Any unauthorized alteration, forgery or falsification of the content or appearance of this document is unlawful and offenders may be prosecuted to the fullest extent of the law. Unless otherwise stated the results shown in this test report refer only to the sample(s) tested and such sample(s) are retained for 30 days only.

Attention: To check the authenticity of testing / inspection report & certificate, please contact us at telephone: (86-755) 8307 1443, or email: [CN.Doccheck@sgs.com](mailto:CN.Doccheck@sgs.com)

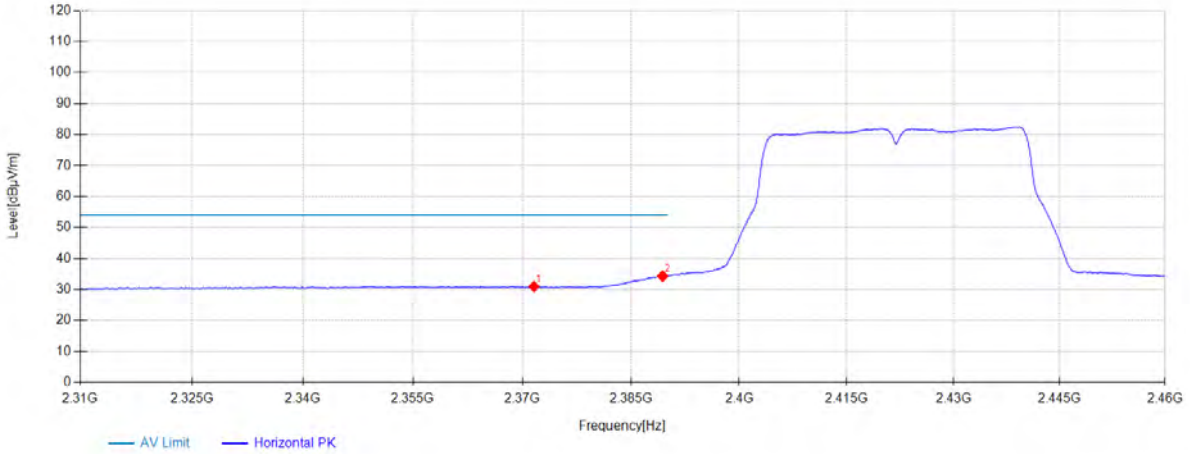
No. 1 Workshop, M-10, Middle Section, Science & Technology Park, Nanshan District, Shenzhen, Guangdong, China 518057 t (86-755) 26012053 www.sgs.com.cn  
 中国·广东·深圳市南山区科技园中区M-10栋1号厂房 邮编: 518057 t (86-755) 26012053 sgs.china@sgs.com



**SGS-CSTC Standards Technical Services Co., Ltd.**  
**Shenzhen Branch**

Report No.: ZEWM2303000343RG05  
 Page: 130 of 136

**802.11n40\_Channel 3**



Final Data List										
NO.	Frequency [MHz]	Reading [dBµV]	AF[dB/m]	Factor [dB]	Level [dBµV/m]	Limit [dBµV/m]	Margin [dB]	Height [cm]	Angle [°]	Polarity
1	2371.5908	26.51	27.51	-23.05	30.97	54.00	23.03	134	56	Horizontal
2	2389.3647	29.91	27.44	-23.02	34.33	54.00	19.67	134	56	Horizontal



Unless otherwise agreed in writing, this document is issued by the Company subject to its General Conditions of Service printed overleaf, available on request or accessible at <https://www.sgs.com/en/Terms-and-Conditions>. Attention is drawn to the limitation of liability, indemnification and jurisdiction issues defined therein. Any holder of this document is advised that information contained hereon reflects the Company's findings at the time of its intervention only and within the limits of Client's instructions, if any. The Company's sole responsibility is to its Client and this document does not exonerate parties to a transaction from exercising all their rights and obligations under the transaction documents. This document cannot be reproduced except in full, without prior written approval of the Company. Any unauthorized alteration, forgery or falsification of the content or appearance of this document is unlawful and offenders may be prosecuted to the fullest extent of the law. Unless otherwise stated the results shown in this test report refer only to the sample(s) tested and such sample(s) are retained for 30 days only.

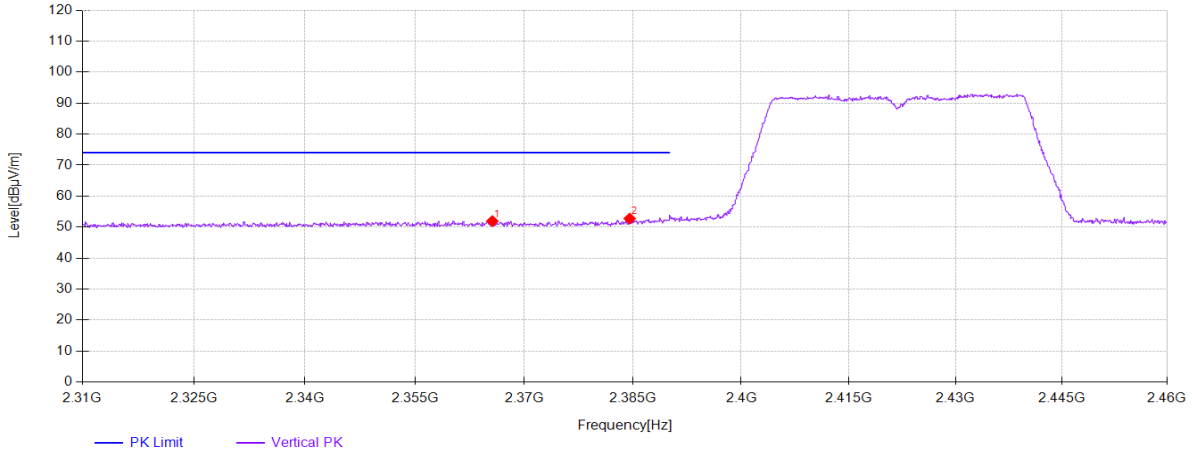
Attention: To check the authenticity of testing / inspection report & certificate, please contact us at telephone: (86-755) 8307 1443, or email: [CN.Doccheck@sgs.com](mailto:CN.Doccheck@sgs.com)  
 No. 1 Workshop, M-10, Middle Section, Science & Technology Park, Nanshan District, Shenzhen, Guangdong, China 518057 t (86-755) 26012053 www.sgs.com.cn  
 中国·广东·深圳市南山区科技园中区M-10栋1号厂房 邮编: 518057 t (86-755) 26012053 sgs.china@sgs.com



**SGS-CSTC Standards Technical Services Co., Ltd.**  
**Shenzhen Branch**

Report No.: ZEWM2303000343RG05  
 Page: 131 of 136

**802.11n40\_Channel 3**



Final Data List										
NO.	Frequency [MHz]	Reading [dBµV]	AF[dB/m]	Factor [dB]	Level [dBµV/m]	Limit [dBµV/m]	Margin [dB]	Height [cm]	Angle [°]	Polarity
1	2365.6028	47.45	27.54	-23.06	51.93	74.00	22.07	399	160	Vertical
2	2384.5173	48.31	27.46	-23.02	52.75	74.00	21.25	399	160	Vertical



Unless otherwise agreed in writing, this document is issued by the Company subject to its General Conditions of Service printed overleaf, available on request or accessible at <https://www.sgs.com/en/Terms-and-Conditions>. Attention is drawn to the limitation of liability, indemnification and jurisdiction issues defined therein. Any holder of this document is advised that information contained hereon reflects the Company's findings at the time of its intervention only and within the limits of Client's instructions, if any. The Company's sole responsibility is to its Client and this document does not exonerate parties to a transaction from exercising all their rights and obligations under the transaction documents. This document cannot be reproduced except in full, without prior written approval of the Company. Any unauthorized alteration, forgery or falsification of the content or appearance of this document is unlawful and offenders may be prosecuted to the fullest extent of the law. Unless otherwise stated the results shown in this test report refer only to the sample(s) tested and such sample(s) are retained for 30 days only.

Attention: To check the authenticity of testing / inspection report & certificate, please contact us at telephone: (86-755) 8307 1443, or email: [CN\\_Doccheck@sgs.com](mailto:CN_Doccheck@sgs.com)

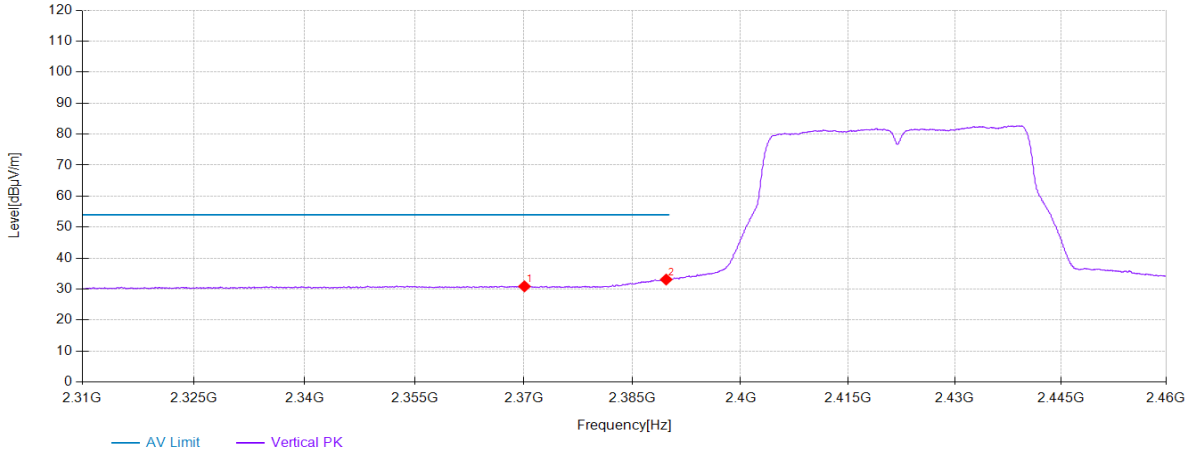
No. 1 Workshop, M-10, Middle Section, Science & Technology Park, Nanshan District, Shenzhen, Guangdong, China 518057 t (86-755) 26012053 www.sgs.com.cn  
 中国·广东·深圳市南山区科技园中区M-10栋1号厂房 邮编: 518057 t (86-755) 26012053 sgs.china@sgs.com



**SGS-CSTC Standards Technical Services Co., Ltd.**  
**Shenzhen Branch**

Report No.: ZEWM2303000343RG05  
 Page: 132 of 136

**802.11n40\_Channel 3**



Final Data List										
NO.	Frequency [MHz]	Reading [dBµV]	AF[dB/m]	Factor [dB]	Level [dBµV/m]	Limit [dBµV/m]	Margin [dB]	Height [cm]	Angle [°]	Polarity
1	2370.07	26.42	27.52	-23.05	30.89	54.00	23.11	399	160	Vertical
2	2389.6498	28.68	27.44	-23.02	33.10	54.00	20.90	399	160	Vertical



Unless otherwise agreed in writing, this document is issued by the Company subject to its General Conditions of Service printed overleaf, available on request or accessible at <https://www.sgs.com/en/Terms-and-Conditions>. Attention is drawn to the limitation of liability, indemnification and jurisdiction issues defined therein. Any holder of this document is advised that information contained hereon reflects the Company's findings at the time of its intervention only and within the limits of Client's instructions, if any. The Company's sole responsibility is to its Client and this document does not exonerate parties to a transaction from exercising all their rights and obligations under the transaction documents. This document cannot be reproduced except in full, without prior written approval of the Company. Any unauthorized alteration, forgery or falsification of the content or appearance of this document is unlawful and offenders may be prosecuted to the fullest extent of the law. Unless otherwise stated the results shown in this test report refer only to the sample(s) tested and such sample(s) are retained for 30 days only.

Attention: To check the authenticity of testing / inspection report & certificate, please contact us at telephone: (86-755) 8307 1443, or email: [CN\\_Doccheck@sgs.com](mailto:CN_Doccheck@sgs.com)  
 No. 1 Workshop, M-10, Middle Section, Science & Technology Park, Nanshan District, Shenzhen, Guangdong, China 518057 t (86-755) 26012053 www.sgs.com.cn  
 中国·广东·深圳市南山区科技园中区M-10栋1号厂房 邮编: 518057 t (86-755) 26012053 sgs.china@sgs.com

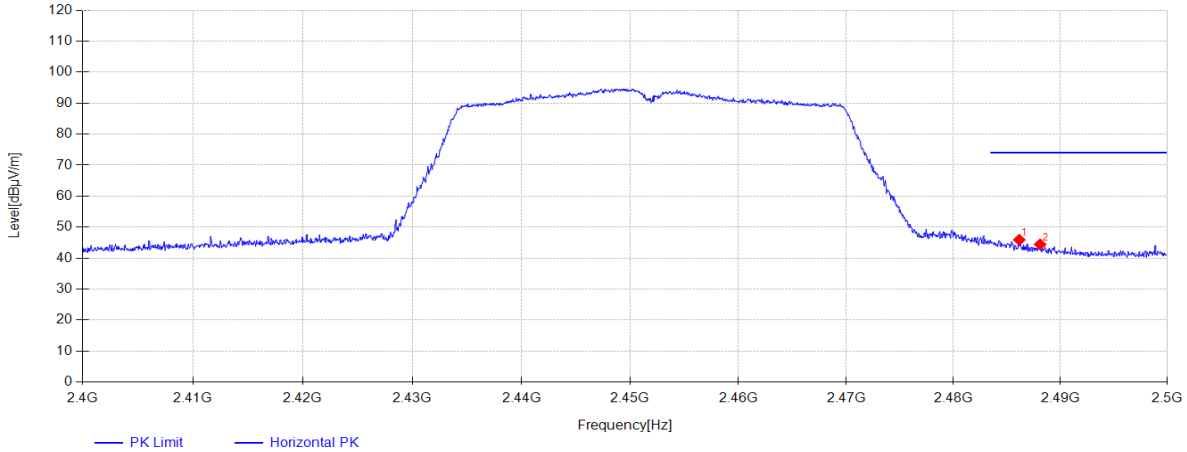




**SGS-CSTC Standards Technical Services Co., Ltd.**  
**Shenzhen Branch**

Report No.: ZEWM2303000343RG05  
 Page: 133 of 136

**802.11n40\_Channel 9**



Final Data List										
NO.	Frequency [MHz]	Reading [dBμV]	AF[dB/m]	Factor [dB]	Level [dBμV/m]	Limit [dBμV/m]	Margin [dB]	Height [cm]	Angle [°]	Polarity
1	2486.1431	41.28	27.74	-23.12	45.90	74.00	28.10	163	53	Horizontal
2	2488.094	39.80	27.75	-23.12	44.43	74.00	29.57	163	53	Horizontal



Unless otherwise agreed in writing, this document is issued by the Company subject to its General Conditions of Service printed overleaf, available on request or accessible at <https://www.sgs.com/en/Terms-and-Conditions>. Attention is drawn to the limitation of liability, indemnification and jurisdiction issues defined therein. Any holder of this document is advised that information contained hereon reflects the Company's findings at the time of its intervention only and within the limits of Client's instructions, if any. The Company's sole responsibility is to its Client and this document does not exonerate parties to a transaction from exercising all their rights and obligations under the transaction documents. This document cannot be reproduced except in full, without prior written approval of the Company. Any unauthorized alteration, forgery or falsification of the content or appearance of this document is unlawful and offenders may be prosecuted to the fullest extent of the law. Unless otherwise stated the results shown in this test report refer only to the sample(s) tested and such sample(s) are retained for 30 days only.

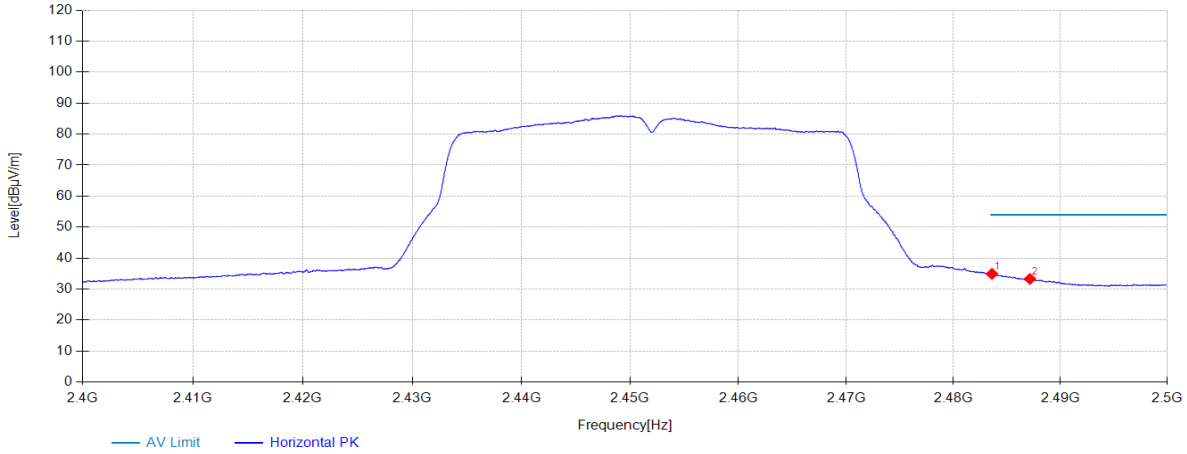
Attention: To check the authenticity of testing / inspection report & certificate, please contact us at telephone: (86-755) 8307 1443, or email: [CN.Doccheck@sgs.com](mailto:CN.Doccheck@sgs.com)  
 No. 1 Workshop, M-10, Middle Section, Science & Technology Park, Nanshan District, Shenzhen, Guangdong, China 518057 t (86-755) 26012053 www.sgs.com.cn  
 中国·广东·深圳市南山区科技园中区M-10栋1号厂房 邮编: 518057 t (86-755) 26012053 sgs.china@sgs.com



**SGS-CSTC Standards Technical Services Co., Ltd.**  
**Shenzhen Branch**

Report No.: ZEWM2303000343RG05  
 Page: 134 of 136

**802.11n40\_Channel 9**



Final Data List										
NO.	Frequency [MHz]	Reading [dBμV]	AF[dB/m]	Factor [dB]	Level [dBμV/m]	Limit [dBμV/m]	Margin [dB]	Height [cm]	Angle [°]	Polarity
1	2483.5918	30.32	27.73	-23.12	34.93	54.00	19.07	163	53	Horizontal
2	2487.1436	28.65	27.75	-23.12	33.28	54.00	20.72	163	53	Horizontal



Unless otherwise agreed in writing, this document is issued by the Company subject to its General Conditions of Service printed overleaf, available on request or accessible at <https://www.sgs.com/en/Terms-and-Conditions>. Attention is drawn to the limitation of liability, indemnification and jurisdiction issues defined therein. Any holder of this document is advised that information contained hereon reflects the Company's findings at the time of its intervention only and within the limits of Client's instructions, if any. The Company's sole responsibility is to its Client and this document does not exonerate parties to a transaction from exercising all their rights and obligations under the transaction documents. This document cannot be reproduced except in full, without prior written approval of the Company. Any unauthorized alteration, forgery or falsification of the content or appearance of this document is unlawful and offenders may be prosecuted to the fullest extent of the law. Unless otherwise stated the results shown in this test report refer only to the sample(s) tested and such sample(s) are retained for 30 days only.

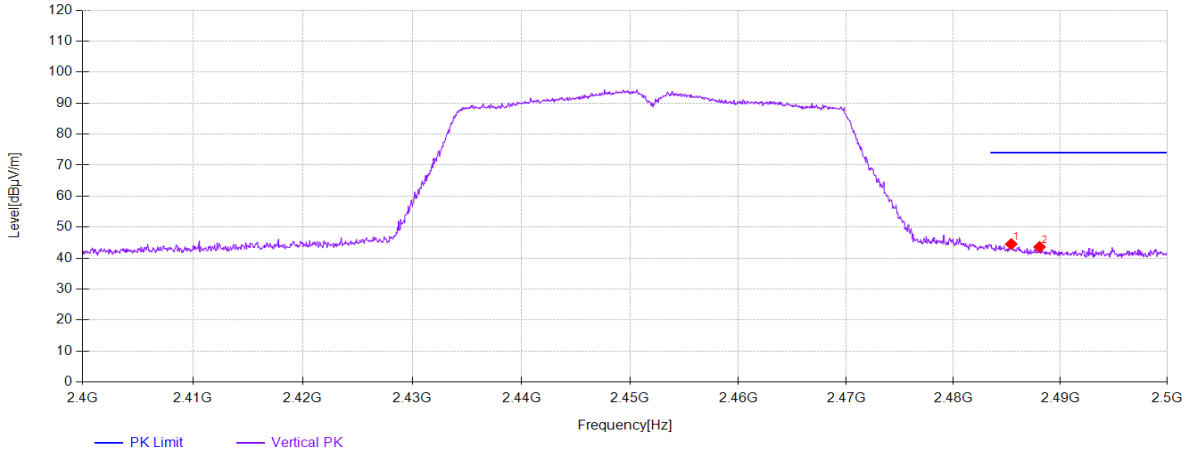
Attention: To check the authenticity of testing / inspection report & certificate, please contact us at telephone: (86-755) 8307 1443, or email: [CN\\_Doccheck@sgs.com](mailto:CN_Doccheck@sgs.com)  
 No. 1 Workshop, M-10, Middle Section, Science & Technology Park, Nanshan District, Shenzhen, Guangdong, China 518057 t (86-755) 26012053 www.sgs.com.cn  
 中国·广东·深圳市南山区科技园中区M-10栋1号厂房 邮编: 518057 t (86-755) 26012053 sgs.china@sgs.com



**SGS-CSTC Standards Technical Services Co., Ltd.**  
**Shenzhen Branch**

Report No.: ZEWM2303000343RG05  
 Page: 135 of 136

**802.11n40\_Channel 9**



Final Data List										
NO.	Frequency [MHz]	Reading [dBµV]	AF[dB/m]	Factor [dB]	Level [dBµV/m]	Limit [dBµV/m]	Margin [dB]	Height [cm]	Angle [°]	Polarity
1	2485.3927	39.91	27.74	-23.12	44.53	74.00	29.47	397	150	Vertical
2	2488.044	38.98	27.75	-23.12	43.61	74.00	30.39	397	150	Vertical

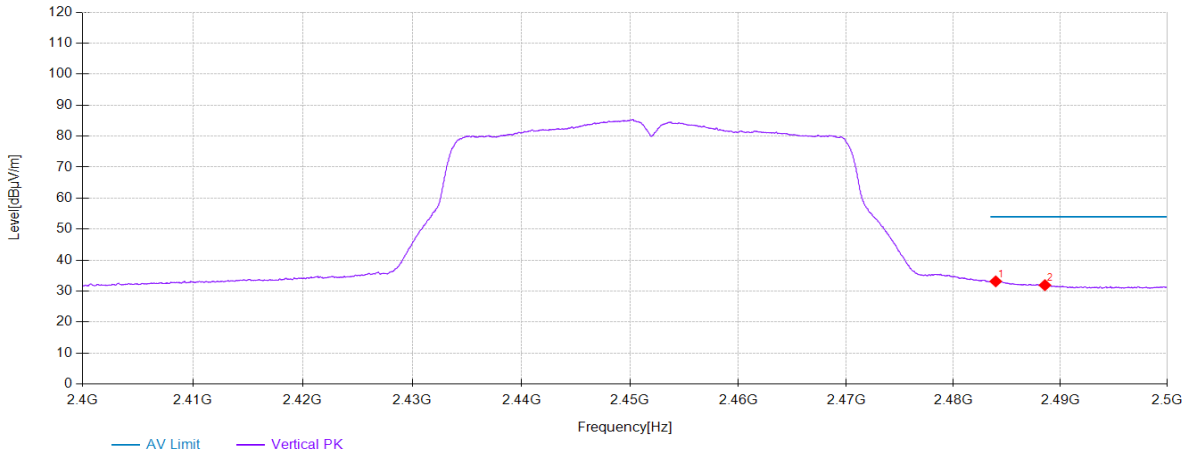


Unless otherwise agreed in writing, this document is issued by the Company subject to its General Conditions of Service printed overleaf, available on request or accessible at <https://www.sgs.com/en/Terms-and-Conditions>. Attention is drawn to the limitation of liability, indemnification and jurisdiction issues defined therein. Any holder of this document is advised that information contained hereon reflects the Company's findings at the time of its intervention only and within the limits of Client's instructions, if any. The Company's sole responsibility is to its Client and this document does not exonerate parties to a transaction from exercising all their rights and obligations under the transaction documents. This document cannot be reproduced except in full, without prior written approval of the Company. Any unauthorized alteration, forgery or falsification of the content or appearance of this document is unlawful and offenders may be prosecuted to the fullest extent of the law. Unless otherwise stated the results shown in this test report refer only to the sample(s) tested and such sample(s) are retained for 30 days only.

Attention: To check the authenticity of testing / inspection report & certificate, please contact us at telephone: (86-755) 8307 1443, or email: [CN\\_Doccheck@sgs.com](mailto:CN_Doccheck@sgs.com)  
 No. 1 Workshop, M-10, Middle Section, Science & Technology Park, Nanshan District, Shenzhen, Guangdong, China 518057 t (86-755) 26012053 www.sgs.com.cn  
 中国·广东·深圳市南山区科技园中区M-10栋1号厂房 邮编: 518057 t (86-755) 26012053 sgs.china@sgs.com



**802.11n40\_Channel 9**



Final Data List										
NO.	Frequency [MHz]	Reading [dBµV]	AF[dB/m]	Factor [dB]	Level [dBµV/m]	Limit [dBµV/m]	Margin [dB]	Height [cm]	Angle [°]	Polarity
1	2483.942	28.53	27.74	-23.12	33.15	54.00	20.85	397	150	Vertical
2	2488.5443	27.29	27.75	-23.12	31.92	54.00	22.08	397	150	Vertical

**Remark:**

- The field strength is calculated by adding the Antenna Factor, Cable Factor & Pre-amplifier gain. The basic equation with a sample calculation is as follows:  
 Level = Reading(dBµV) + AF(dB/m) + Factor(dB)  
 AF = Antenna Factor(dB/m)  
 Factor = Cable Factor(dB) - Pre-amplifier gain(dB)  
 Margin = Limit(dBµV/m) – Level(dBµV/m)
- Both peak and average measured complies with the limit line, so test result is “PASS”.

---End of Report---



Unless otherwise agreed in writing, this document is issued by the Company subject to its General Conditions of Service printed overleaf, available on request or accessible at <https://www.sgs.com/en/Terms-and-Conditions>. Attention is drawn to the limitation of liability, indemnification and jurisdiction issues defined therein. Any holder of this document is advised that information contained hereon reflects the Company's findings at the time of its intervention only and within the limits of Client's instructions, if any. The Company's sole responsibility is to its Client and this document does not exonerate parties to a transaction from exercising all their rights and obligations under the transaction documents. This document cannot be reproduced except in full, without prior written approval of the Company. Any unauthorized alteration, forgery or falsification of the content or appearance of this document is unlawful and offenders may be prosecuted to the fullest extent of the law. Unless otherwise stated the results shown in this test report refer only to the sample(s) tested and such sample(s) are retained for 30 days only.

Attention: To check the authenticity of testing / inspection report & certificate, please contact us at telephone: (86-755) 8307 1443, or email: [CN.Doccheck@sgs.com](mailto:CN.Doccheck@sgs.com)  
 No.1 Workshop, M-10, Middle Section, Science & Technology Park, Nanshan District, Shenzhen, Guangdong, China 518057 t (86-755) 26012053 www.sgs.com.cn  
 中国·广东·深圳市南山区科技园中区M-10栋1号厂房 邮编: 518057 t (86-755) 26012053 sgs.china@sgs.com