



FCC RF Test Report

APPLICANT : vivo Mobile Communication Co., Ltd.
EQUIPMENT : Mobile Phone
BRAND NAME : vivo
MODEL NAME : V2242
FCC ID : 2AUCY-V2242
STANDARD : 47 CFR Part 2, 27(M)
CLASSIFICATION : PCS Licensed Transmitter Held to Ear (PCE)
TEST DATE(S) : Jan. 15, 2023 ~ Jan. 31, 2023

We, Sporton International Inc. (ShenZhen), would like to declare that the tested sample has been evaluated in accordance with the procedures given in ANSI C63.26-2015 and shown compliance with the applicable technical standards.

The test results in this report apply exclusively to the tested model / sample. Without written approval of Sporton International Inc. (ShenZhen), the test report shall not be reproduced except in full.

Jason Jia

Approved by: Jason Jia



Sporton International Inc. (ShenZhen)

1/F, 2/F, Bldg 5, Shiling Industrial Zone, Xinwei Village, Xili, Nanshan, Shenzhen, 518055

People's Republic of China



TABLE OF CONTENTS

REVISION HISTORY...3
SUMMARY OF TEST RESULT...4
1 GENERAL DESCRIPTION...5
1.1 Applicant...5
1.2 Manufacturer...5
1.3 Product Feature of Equipment Under Test...5
1.4 Product Specification of Equipment Under Test...6
1.5 Modification of EUT...6
1.6 Maximum EIRP and Emission Designator...7
1.7 Testing Location...8
1.8 Test Software...9
1.9 Applicable Standards...9
2 TEST CONFIGURATION OF EQUIPMENT UNDER TEST...10
2.1 Test Mode...10
2.2 Connection Diagram of Test System...11
2.3 Support Unit used in test configuration and system...12
2.4 Measurement Results Explanation Example...12
2.5 Frequency List of Low/Middle/High Channels...13
3 CONDUCTED TEST ITEMS...17
3.1 Measuring Instruments...17
3.2 Test Setup...17
3.3 Test Result of Conducted Test...17
3.4 Conducted Output Power and EIRP...18
3.5 Peak-to-Average Ratio...19
3.6 Occupied Bandwidth...20
3.7 Conducted Band Edge...21
3.8 Conducted Spurious Emission...22
3.9 Frequency Stability...23
4 RADIATED TEST ITEMS...24
4.1 Measuring Instruments...24
4.2 Test Setup...24
4.3 Test Result of Radiated Test...25
4.4 Radiated Spurious Emission...26
5 LIST OF MEASURING EQUIPMENT...27
6 UNCERTAINTY OF EVALUATION...28
APPENDIX A. TEST RESULTS OF CONDUCTED TEST
APPENDIX B. TEST RESULTS OF RADIATED TEST
APPENDIX C. TEST SETUP PHOTOGRAPHS



SUMMARY OF TEST RESULT

Report Section	FCC Rule	Description	Limit	Result	Remark
3.4	§2.1046	Conducted Output Power	-	Report Only	-
	§27.50(h)(2)	Equivalent Isotropic Radiated Power (Band 7) (Band 38) (Band 41)	EIRP < 2Watt	PASS	-
3.5	N/A	Peak-to-Average Ratio	<13 dB	PASS	-
3.6	§2.1049	Occupied Bandwidth	-	Report Only	-
3.7	§2.1051 §27.53(m)(4)	Conducted Band Edge Measurement (Band 7) (Band 38) (Band 41)	§27.53(m)(4)	PASS	-
3.8	§2.1051 §27.53(m)(4)	Conducted Spurious Emission (Band 7) (Band 38) (Band 41)	< 55+10log ₁₀ (P[Watts])	PASS	-
3.9	§2.1055 §27.54	Frequency Stability Temperature & Voltage	Within Authorized Band	PASS	-
4.4	§2.1053 §27.53(m)(4)	Radiated Spurious Emission (Band 7) (Band 38) (Band 41)	< 55+10log ₁₀ (P[Watts])	PASS	Under limit 23.68 dB at 10336.360 MHz

Declaration of Conformity:

The test results with all measurement uncertainty excluded are presented in accordance with the regulation limits or requirements declared by manufacturers.

Comments and Explanations:

The declared of product specification for EUT presented in the report are provided by the manufacturer, and the manufacturer takes all the responsibilities for the accuracy of product specification.



1 General Description

1.1 Applicant

vivo Mobile Communication Co., Ltd.
No.1, vivo Road, Chang'an, Dongguan, Guangdong, China

1.2 Manufacturer

vivo Mobile Communication Co., Ltd.
No.1, vivo Road, Chang'an, Dongguan, Guangdong, China

1.3 Product Feature of Equipment Under Test

Product Feature	
Equipment	Mobile Phone
Brand Name	vivo
Model Name	V2242
FCC ID	2AUCY-V2242
IMEI Code	Conducted: 868848060190652 Radiation: 868848060193672
HW Version	MP_0.1
SW Version	PD2268EF_EX_A_13.0.4.5.W30
EUT Stage	Production Unit

1.4 Product Specification of Equipment Under Test

Standards-related Product Specification	
Tx Frequency	LTE Band 7 : 2500 MHz ~ 2570 MHz LTE Band 38 : 2570 MHz ~ 2620 MHz LTE Band 41 : 2496 MHz ~ 2690 MHz
Rx Frequency	LTE Band 7 : 2620 MHz ~ 2690 MHz LTE Band 38 : 2570 MHz ~ 2620 MHz LTE Band 41 : 2496 MHz ~ 2690 MHz
Bandwidth	LTE Band 7 : 5MHz/ 10MHz / 15MHz / 20MHz LTE Band 38 : 5MHz / 10MHz / 15MHz / 20MHz LTE Band 41 : 5MHz / 10MHz / 15MHz / 20MHz
Maximum Output Power to Antenna	<Ant. 13> LTE Band 7 : 23.42 dBm LTE Band 7C : 23.40 dBm LTE Band 38 : 24.33 dBm LTE Band 41 : 24.36 dBm LTE Band 41C : 24.35 dBm <Ant. 31> LTE Band 7 : 23.15 dBm LTE Band 7C : 23.10 dBm LTE Band 38 : 24.03 dBm LTE Band 41 : 24.05 dBm LTE Band 41C : 24.01 dBm
Antenna Gain	<Ant. 13> LTE Band 7 : -0.05 dBi LTE Band 38 : -0.05 dBi LTE Band 41 : -0.05 dBi <Ant. 31> LTE Band 7 : -0.29 dBi LTE Band 38 : -0.29 dBi LTE Band 41 : -0.29 dBi
Type of Modulation	QPSK / 16QAM / 64QAM / 256QAM (Downlink only)

Note: The maximum EIRP is calculated from max output power and antenna gain, only the maximum EIRP of Ant. 13 is shown in the report.

1.5 Modification of EUT

No modifications are made to the EUT during all test items.



1.6 Maximum EIRP and Emission Designator

LTE Band 7		QPSK		16QAM/64QAM	
BW (MHz)	Frequency Range (MHz)	Maximum EIRP(W)	Emission Designator (99%OBW)	Maximum EIRP(W)	Emission Designator (99%OBW)
5	2502.5 ~ 2567.5	0.2128	4M51G7D	0.1758	4M51W7D
10	2505.0 ~ 2565.0	0.2158	9M05G7D	0.1791	9M07W7D
15	2507.5 ~ 2562.5	0.2123	13M4G7D	0.1762	13M5W7D
20	2510.0 ~ 2560.0	0.2173	17M9G7D	0.1820	17M9W7D
LTE Band 38		QPSK		16QAM/64QAM	
BW (MHz)	Frequency Range (MHz)	Maximum EIRP(W)	Emission Designator (99%OBW)	Maximum EIRP(W)	Emission Designator (99%OBW)
5	2572.5 ~ 2617.5	0.2612	4M51G7D	0.2109	4M51W7D
10	2575.0 ~ 2615.0	0.2667	9M09G7D	0.2158	9M05W7D
15	2577.5 ~ 2612.5	0.2661	13M5G7D	0.2158	13M5W7D
20	2580.0 ~ 2610.0	0.2698	17M9G7D	0.2193	18M0W7D
LTE Band 41		QPSK		16QAM/64QAM	
BW (MHz)	Frequency Range (MHz)	Maximum EIRP(W)	Emission Designator (99%OBW)	Maximum EIRP(W)	Emission Designator (99%OBW)
5	2498.5 ~ 2687.5	0.2612	4M51G7D	0.2109	4M51W7D
10	2501.0 ~ 2685.0	0.2667	9M09G7D	0.2158	9M05W7D
15	2503.5 ~ 2682.5	0.2661	13M5G7D	0.2158	13M5W7D
20	2506.0 ~ 2680.0	0.2698	17M9G7D	0.2193	18M0W7D
LTE Band 7 CA		QPSK		16QAM/64QAM	
BW (MHz)		Maximum EIRP(W)	Emission Designator (99%OBW)	Maximum EIRP(W)	Emission Designator (99%OBW)
10MHz+20MHz		0.2128	28M1G7D	0.1820	28M1W7D
15MHz+15MHz		0.2123	28M7G7D	0.1832	28M6W7D
15MHz+20MHz		0.2113	32M9G7D	0.1811	33M0W7D
15MHz+10MHz		0.2128	23M5G7D	0.1828	23M5W7D
20MHz+10MHz		0.2148	28M1G7D	0.1824	28M2W7D
20MHz+15MHz		0.2158	32M9G7D	0.1820	33M1W7D
20MHz+20MHz		0.2163	37M8G7D	0.1858	37M9W7D



LTE Band 41 CA	QPSK		16QAM/64QAM	
BW (MHz)	Maximum EIRP(W)	Emission Designator (99%OBW)	Maximum EIRP(W)	Emission Designator (99%OBW)
5MHz+20MHz	0.2655	23M2G7D	0.2234	23M5W7D
10MHz+20MHz	0.2636	28M2G7D	0.2275	28M2W7D
10MHz+15MHz	0.2642	23M6G7D	0.2223	23M6W7D
15MHz+15MHz	0.2661	28M7G7D	0.2228	28M8W7D
15MHz+20MHz	0.2673	32M8G7D	0.2259	32M8W7D
15MHz+10MHz	0.2661	23M7G7D	0.2254	23M5W7D
20MHz+5MHz	0.2655	23M4G7D	0.2259	23M3W7D
20MHz+10MHz	0.2667	28M1G7D	0.2275	28M1W7D
20MHz+15MHz	0.2679	33M0G7D	0.2270	32M9W7D
20MHz+20MHz	0.2692	37M9G7D	0.2286	37M8W7D

Note:

1. LTE Band 41 overlaps the entire frequency range of LTE Band 38. Therefore, the test results provided in this report covers Band 41 as well as Band 38.
2. All modulations have been tested, and only the worst test results of PSK & QAM are shown in the report.

1.7 Testing Location

Sporton International Inc. (Shenzhen) is accredited to ISO/IEC 17025:2017 by American Association for Laboratory Accreditation with Certificate Number 5145.01.

Test Firm	Sporton International Inc. (Shenzhen)		
Test Site Location	1/F, 2/F, Bldg 5, Shiling Industrial Zone, Xinwei Village, Xili, Nanshan, Shenzhen, 518055 People's Republic of China TEL: +86-755-86379589 FAX: +86-755-86379595		
Test Site No.	Sporton Site No.	FCC Designation No.	FCC Test Firm Registration No.
	TH01-SZ	CN1256	421272

Test Firm	Sporton International Inc. (Shenzhen)		
Test Site Location	101, 1st Floor, Block B, Building 1, No. 2, Tengfeng 4th Road, Fenghuang Community, Fuyong Street, Baoan District, Shenzhen City Guangdong Province China 518103 TEL: +86-755-33202398		
Test Site No.	Sporton Site No.	FCC Designation No.	FCC Test Firm Registration No.
	03CH04-SZ	CN1256	421272



1.8 Test Software

Item	Site	Manufacture	Name	Version
1.	03CH04-SZ	AUDIX	E3	6.2009-8-24

1.9 Applicable Standards

According to the specifications of the manufacturer, the EUT must comply with the requirements of the following standards:

- ♦ 47 CFR Part 2, 27(M)
- ♦ ANSI C63.26-2015
- ♦ FCC KDB 971168 D01 Power Meas License Digital Systems v03r01
- ♦ FCC KDB 412172 D01 Determining ERP and EIRP v01r01

Remark:

1. All test items were verified and recorded according to the standards and without any deviation during the test.
2. This EUT has also been tested and complied with the requirements of FCC Part 15, Subpart B, recorded in a separate test report.



2 Test Configuration of Equipment Under Test

2.1 Test Mode

Antenna port conducted and radiated test items listed below are performed according to KDB 971168 D01 Power Meas License Digital Systems v03r01 with maximum output power.

Radiated measurements are performed by rotating the EUT in three different orthogonal test planes to find the maximum emission. (Y-Plane)

Test Items	Band	Bandwidth (MHz)						Modulation				RB #			Test Channel		
		1.4	3	5	10	15	20	QPSK	16QAM	64QAM	256QAM	1	Half	Full	L	M	H
Max. Output Power	7	-	-	v	v	v	v	v	v	v	-	v	v	v	v	v	v
	38	-	-	v	v	v	v	v	v	v	-	v	v	v	v	v	v
	41	-	-	v	v	v	v	v	v	v	-	v	v	v	v	v	v
Peak-to-Average Ratio	7	-	-				v	v	v	v	-	v		v	v	v	v
	41	-	-				v	v	v	v	-	v		v	v	v	v
26dB and 99% Bandwidth	7	-	-	v	v	v	v	v	v	v	-			v	v	v	v
	41	-	-	v	v	v	v	v	v	v	-			v	v	v	v
Conducted Band Edge	7	-	-	v	v	v	v	v	v	v	-	v		v	v		v
	41	-	-	v	v	v	v	v	v	v	-	v		v	v		v
Conducted Spurious Emission	7	-	-	v	v	v	v	v	v	v	-	v			v	v	v
	41	-	-	v	v	v	v	v	v	v	-	v			v	v	v
Frequency Stability	7	-	-		v			v			-			v		v	
	41	-	-		v			v			-			v		v	
E.I.R.P	7	-	-	v	v	v	v	v	v	v	-	v			v	v	v
	41	-	-	v	v	v	v	v	v	v	-	v			v	v	v
Radiated Spurious Emission	7	Worst Case														v	
	41	Worst Case														v	
Note	<ol style="list-style-type: none"> The mark "v" means that this configuration is chosen for testing The mark "- " means that this bandwidth is not supported. The device is investigated from 30MHz to 10 times of fundamental signal for radiated spurious emission test under different RB size/offset and modulations in exploratory test. Subsequently, only the worst case emissions are reported. 																

Test Items	Band	Bandwidth (MHz)										Modulation			RB #			Test Channel			
		20+20	20+15	15+20	20+10	10+20	20+5	5+20	15+15	15+10	10+15	QPSK	16Q AM	64 QAM	256 QAM	1	Half	Full	L	M	H
Max. Output Power	7C_CA	v	v	v	v	v	-	-	v	v	-	v	v	v	-	v	v	v	v	v	v
	41C_CA	v	v	v	v	v	v	v	v	v	v	v	v	v	-	v	v	v	v	v	v
26dB and 99% Bandwidth	7C_CA	v	v	v	v	v	-	-	v	v	-	v	v	v	-			v	v	v	v
	41C_CA	v	v	v	v	v	v	v	v	v	v	v	v	v	-			v	v	v	v
Conducted Band Edge	7C_CA	v	v	v	v	v	-	-	v	v	-	v	v	v	-	v		v	v		v
	41C_CA	v	v	v	v	v	v	v	v	v	v	v	v	v	-	v		v	v		v
Conducted Spurious Emission	7C_CA	v	v	v	v	v	-	-	v	v	-	v	v	v	-	v		v	v	v	v
	41C_CA	v	v	v	v	v	v	v	v	v	v	v	v	v	-	v		v	v	v	v
E.I.R.P.	7C_CA	v	v	v	v	v	-	-	v	v	-	v	v	v	-	v			v	v	v
	41C_CA	v	v	v	v	v	v	v	v	v	v	v	v	v	-	v			v	v	v
Radiated Spurious Emission	7C_CA	Worst Case																		v	
	41C_CA	Worst Case																		v	
Note	<ol style="list-style-type: none"> The mark "v" means that this configuration is chosen for testing The mark "-" means that this bandwidth is not supported. The device is investigated from 30MHz to 10 times of fundamental signal for radiated spurious emission test under different RB size/offset and modulations in exploratory test. Subsequently, only the worst case emissions are reported. 																				

2.2 Connection Diagram of Test System

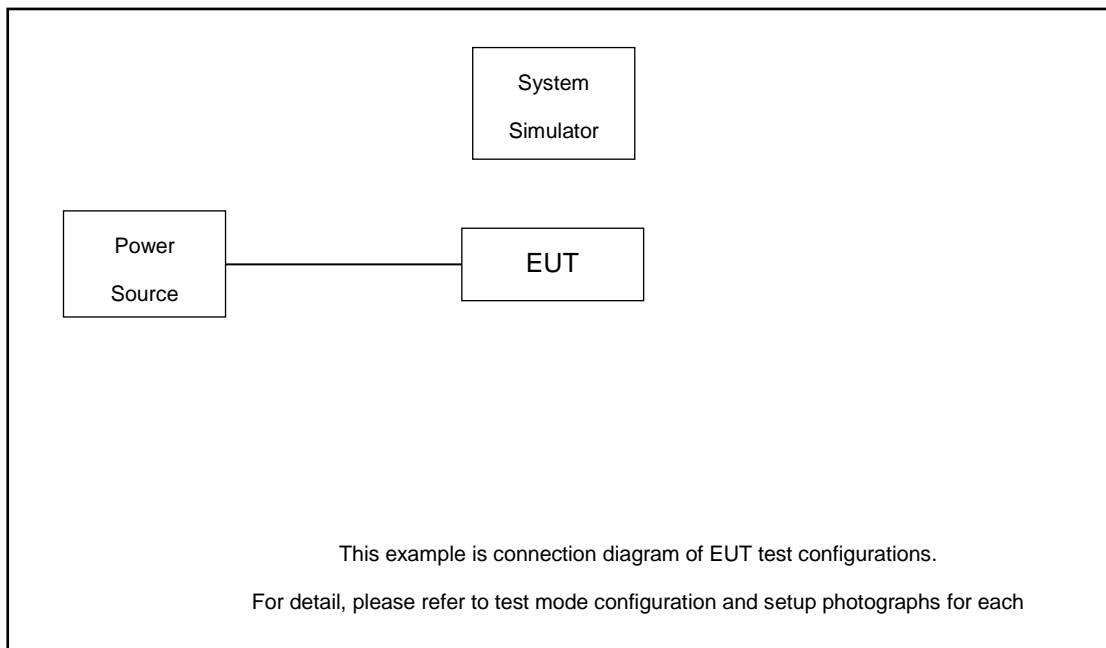



2.3 Support Unit used in test configuration and system

Item	Equipment	Trade Name	Model No.	FCC ID	Data Cable	Power Cord
1.	Base Station	Anritsu	MT8820C	N/A	N/A	Unshielded, 1.8 m
2.	DC Power Supply	TTI	PL330P	N/A	N/A	Unshielded, 1.8 m

2.4 Measurement Results Explanation Example

For all conducted test items:

The offset level is set in the spectrum analyzer to compensate the RF cable loss and attenuator factor between EUT conducted output port and spectrum analyzer. With the offset compensation, the spectrum analyzer reading level is exactly the EUT RF output level.

The spectrum analyzer offset is derived from RF cable loss and attenuator factor.

$$\text{Offset} = \text{RF cable loss} + \text{attenuator factor}.$$

Following shows an offset computation example with cable loss 5.0 dB and 10dB attenuator.

Example :

$$\begin{aligned} \text{Offset(dB)} &= \text{RF cable loss(dB)} + \text{attenuator factor(dB)}. \\ &= 5.0 + 10 = 15.0 \text{ (dB)} \end{aligned}$$



2.5 Frequency List of Low/Middle/High Channels

LTE Band 7 Channel and Frequency List				
BW [MHz]	Channel/Frequency(MHz)	Lowest	Middle	Highest
20	Channel	20850	21100	21350
	Frequency	2510	2535	2560
15	Channel	20825	21100	21375
	Frequency	2507.5	2535	2562.5
10	Channel	20800	21100	21400
	Frequency	2505	2535	2565
5	Channel	20775	21100	21425
	Frequency	2502.5	2535	2567.5

LTE Band 38 Channel and Frequency List				
BW [MHz]	Channel/Frequency(MHz)	Lowest	Middle	Highest
20	Channel	37850	38000	38150
	Frequency	2580	2595	2610
15	Channel	37825	38000	38175
	Frequency	2577.5	2595	2612.5
10	Channel	37800	38000	38200
	Frequency	2575	2595	2615
5	Channel	37775	38000	38225
	Frequency	2572.5	2595	2617.5

LTE Band 41 Channel and Frequency List				
BW [MHz]	Channel/Frequency(MHz)	Lowest	Middle	Highest
20	Channel	39750	40620	41490
	Frequency	2506	2593	2680
15	Channel	39725	40620	41515
	Frequency	2503.5	2593	2682.5
10	Channel	39700	40620	41540
	Frequency	2501	2593	2685
5	Channel	39675	40620	41565
	Frequency	2498.5	2593	2687.5



LTE Band 7C_CA Channel and Frequency List					
BW [MHz]	Channel/Frequency(MHz)		Lowest	Middle	Highest
20 + 20	PCC	Channel	20850	21001	21152
		Frequency	2510.0	2525.1	2540.2
	SCC	Channel	21048	21199	21350
		Frequency	2529.8	2544.9	2560.0
20 + 15	PCC	Channel	20850	21026	21201
		Frequency	2510.0	2527.6	2545.1
	SCC	Channel	21021	21197	21372
		Frequency	2527.1	2544.7	2562.2
15 + 20	PCC	Channel	20828	21003	21179
		Frequency	2507.8	2525.3	2542.9
	SCC	Channel	20999	21174	21350
		Frequency	2524.9	2542.4	2560.0
20 + 10	PCC	Channel	20850	21051	21251
		Frequency	2510.0	2530.1	2550.1
	SCC	Channel	20994	21195	21395
		Frequency	2524.4	2544.5	2564.5
10 + 20	PCC	Channel	20805	21006	21206
		Frequency	2505.5	2525.6	2545.6
	SCC	Channel	20949	21150	21350
		Frequency	2519.9	2540.0	2560.0
15 + 15	PCC	Channel	20825	21025	21225
		Frequency	2507.5	2527.5	2547.5
	SCC	Channel	20975	21175	21375
		Frequency	2522.5	2542.5	2562.5
15 + 10	PCC	Channel	20825	21051	21277
		Frequency	2507.5	2530.1	2552.7
	SCC	Channel	20945	21171	21397
		Frequency	2519.5	2542.1	2564.7



LTE Band 41C_CA Channel and Frequency List					
BW [MHz]	Channel/Frequency(MHz)		Lowest	Middle	Highest
20 + 20	PCC	Channel	39750	40521	41292
		Frequency	2506.0	2583.1	2660.2
	SCC	Channel	39948	40719	41490
		Frequency	2525.8	2602.9	2680.0
20 + 15	PCC	Channel	39750	40546	41341
		Frequency	2506.0	2585.6	2665.1
	SCC	Channel	39921	40717	41512
		Frequency	2523.1	2602.7	2682.2
15 + 20	PCC	Channel	39728	40523	41319
		Frequency	2503.8	2593.3	2662.9
	SCC	Channel	39899	40694	41490
		Frequency	2520.9	2600.4	2680.0
20 + 10	PCC	Channel	39750	40571	41391
		Frequency	2506.0	2588.1	2670.1
	SCC	Channel	39894	40715	41535
		Frequency	2520.4	2602.5	2684.5
10 + 20	PCC	Channel	39705	40526	41346
		Frequency	2501.5	2583.6	2665.6
	SCC	Channel	39849	40670	41490
		Frequency	2515.9	2598.0	2680.0



LTE Band 41C_CA Channel and Frequency List					
20 + 5	PCC	Channel	39750	40595	41440
		Frequency	2506.0	2590.5	2675.0
	SCC	Channel	39867	40712	41557
		Frequency	2517.7	2602.2	2686.7
5 + 20	PCC	Channel	39683	40528	41373
		Frequency	2499.3	2583.8	2668.3
	SCC	Channel	39800	40645	41490
		Frequency	2511.0	2595.5	2680.0
15 + 15	PCC	Channel	39725	40545	41365
		Frequency	2503.5	2585.5	2667.5
	SCC	Channel	39875	40695	41515
		Frequency	2518.5	2600.5	2682.5
10 + 15	PCC	Channel	39703	40549	41395
		Frequency	2501.3	2585.9	2670.5
	SCC	Channel	39823	40669	41515
		Frequency	2513.3	2597.9	2682.5
15 + 10	PCC	Channel	39725	40571	41417
		Frequency	2503.5	2588.1	2672.7
	SCC	Channel	39845	40691	41537
		Frequency	2515.5	2600.1	2684.7

3 Conducted Test Items

3.1 Measuring Instruments

See list of measuring instruments of this test report.

3.2 Test Setup

3.2.1 Conducted Output Power



3.2.2 Peak-to-Average Ratio, Occupied Bandwidth, Conducted Band-Edge and Conducted Spurious Emission

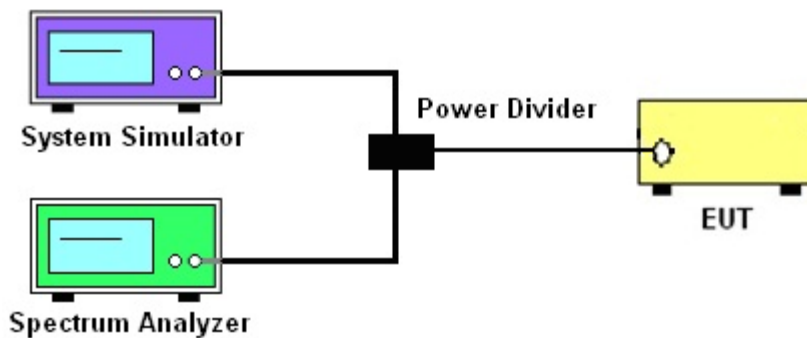

3.2.3 Frequency Stability

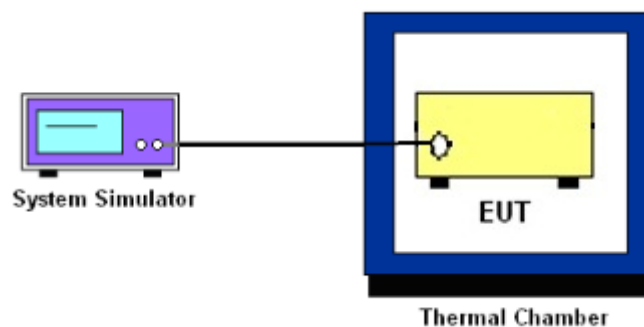

3.3 Test Result of Conducted Test

Please refer to Appendix A.



3.4 Conducted Output Power and EIRP

3.4.1 Description of the Conducted Output Power Measurement and EIRP Measurement

A system simulator was used to establish communication with the EUT. Its parameters were set to force the EUT transmitting at maximum output power. The measured power in the radio frequency on the transmitter output terminals shall be reported.

The EIRP of mobile transmitters must not exceed 2 Watts for LTE Band 7 and Band 38 and Band 41.

According to KDB 412172 D01 Power Approach,

$EIRP = P_T + G_T - L_C$, $ERP = EIRP - 2.15$, where

P_T = transmitter output power in dBm

G_T = gain of the transmitting antenna in dBi

L_C = signal attenuation in the connecting cable between the transmitter and antenna in dB

3.4.2 Test Procedures

1. The testing follows ANSI C63.26 Section 5.2
2. The transmitter output port was connected to the system simulator.
3. Set EUT at maximum power through the system simulator.
4. Select lowest, middle, and highest channels for each band and different modulation.
5. Measure and record the power level from the system simulator.



3.5 Peak-to-Average Ratio

3.5.1 Description of the PAR Measurement

Power Complementary Cumulative Distribution Function (CCDF) curves provide a means for characterizing the power peaks of a digitally modulated signal on a statistical basis. A CCDF curve depicts the probability of the peak signal amplitude exceeding the average power level. Most contemporary measurement instrumentation include the capability to produce CCDF curves for an input signal provided that the instrument's resolution bandwidth can be set wide enough to accommodate the entire input signal bandwidth. In measuring transmissions in this band using an average power technique, the peak-to-average ratio (PAR) of the transmission may not exceed 13 dB.

3.5.2 Test Procedures

1. The testing follows ANSI C63.26 Section 5.2.3.4 (CCDF).
2. The EUT was connected to spectrum and system simulator via a power divider.
3. Set the CCDF (Complementary Cumulative Distribution Function) option in spectrum analyzer.
4. The highest RF powers were measured and recorded the maximum PAPR level associated with a probability of 0.1 %.
5. Record the deviation as Peak to Average Ratio.



3.6 Occupied Bandwidth

3.6.1 Description of Occupied Bandwidth Measurement

The occupied bandwidth is the width of a frequency band such that, below the lower and above the upper frequency limits, the mean powers emitted are each equal to a specified percentage 0.5% of the total mean transmitted power.

The 26 dB emission bandwidth is defined as the frequency range between two points, one above and one below the carrier frequency, at which the spectral density of the emission is attenuated 26 dB below the maximum in-band spectral density of the modulated signal. Spectral density (power per unit bandwidth) is to be measured with a detector of resolution bandwidth equal to approximately 1.0% of the emission bandwidth.

3.6.2 Test Procedures

1. The testing follows ANSI C63.26 Section 5.4
2. The EUT was connected to spectrum analyzer and system simulator via a power divider.
3. The spectrum analyzer center frequency is set to the nominal EUT channel center frequency. The span range for the spectrum analyzer shall be between two and five times the anticipated OBW.
4. The nominal resolution bandwidth (RBW) shall be in the range of 1 to 5 % of the anticipated OBW, and the VBW shall be at least 3 times the RBW.
5. Set the detection mode to peak, and the trace mode to max hold.
6. Determine the reference value: Set the EUT to transmit a modulated signal. Allow the trace to stabilize. Set the spectrum analyzer marker to the highest level of the displayed trace.
(this is the reference value)
7. Determine the “-26 dB down amplitude” as equal to (Reference Value – X).
8. Place two markers, one at the lowest and the other at the highest frequency of the envelope of the spectral display such that each marker is at or slightly below the “-X dB down amplitude” determined in step 6. If a marker is below this “-X dB down amplitude” value it shall be placed as close as possible to this value. The OBW is the positive frequency difference between the two markers.
9. Use the 99 % power bandwidth function of the spectrum analyzer and report the measured bandwidth.



3.7 Conducted Band Edge

3.7.1 Description of Conducted Band Edge Measurement

27.53(m)(4)

For mobile digital stations, the attenuation factor shall be not less than $40 + 10 \log (P)$ dB on all frequencies between the channel edge and 5 megahertz from the channel edge, $43 + 10 \log (P)$ dB on all frequencies between 5 megahertz and X megahertz from the channel edge, and $55 + 10 \log (P)$ dB on all frequencies more than X megahertz from the channel edge, where X is the greater of 6 megahertz or the actual emission bandwidth as defined in paragraph (m)(6) of this section. In addition, the attenuation factor shall not be less that $43 + 10 \log (P)$ dB on all frequencies between 2490.5 MHz and 2496 MHz and $55 + 10 \log (P)$ dB at or below 2490.5 MHz. Mobile Satellite Service licensees operating on frequencies below 2495 MHz may also submit a documented interference complaint against BRS licensees operating on channel BRS Channel 1 on the same terms and conditions as adjacent channel BRS or EBS licensees.

3.7.2 Test Procedures

1. The testing follows ANSI C63.26 section 5.7
2. The EUT was connected to spectrum analyzer and system simulator via a power divider.
3. The band edges of low and high channels for the highest RF powers were measured.
4. Set RBW \geq 1% EBW in the 1MHz band immediately outside and adjacent to the band edge.
5. Beyond the 1 MHz band from the band edge, RBW=1MHz was used.
6. Set spectrum analyzer with RMS detector.
7. Offset has included the duty factor for LTE Band 41. Duty factor = $10 \log (1/x)$, where x is the measured duty cycle
8. The RF fundamental frequency should be excluded against the limit line in the operating frequency band.
9. Checked that all the results comply with the emission limit line.

Example:

The limit line is derived from $43 + 10 \log(P)$ dB below the transmitter power P(Watts)
= $P(W) - [43 + 10 \log(P)]$ (dB)
= $[30 + 10 \log(P)]$ (dBm) - $[43 + 10 \log(P)]$ (dB) = -13dBm.

10. For LTE Band 7, 38, 41, the other 40 dB, and 55 dB have additionally applied same calculation above.
11. When using the integration method, the starting frequency of the integration shall be centered at one-half of the RBW away from the band edge.



3.8 Conducted Spurious Emission

3.8.1 Description of Conducted Spurious Emission Measurement

For Band 7,38,41:

The power of any emission outside of the authorized operating frequency ranges must be lower than the transmitter power (P) by a factor of at least $55 + 10 \log (P)$ dB.

It is measured by means of a calibrated spectrum analyzer and scanned from 30 MHz up to a frequency including its 10th harmonic.

3.8.2 Test Procedures

1. The testing follows ANSI C63.26 section 5.7
2. The EUT was connected to spectrum analyzer and system simulator via a power divider.
3. The RF output of EUT was connected to the spectrum analyzer by RF cable and attenuator. The path loss was compensated to the results for each measurement.
4. The middle channel for the highest RF power within the transmitting frequency was measured.
5. The conducted spurious emission for the whole frequency range was taken.
6. Make the measurement with the spectrum analyzer's RBW = 1MHz, VBW = 3MHz.
7. Set spectrum analyzer with RMS detector.
8. Offset has included the duty factor for LTE Band 41. Duty factor = $10 \log (1/x)$, where x is the measured duty cycle
9. Taking the record of maximum spurious emission.
10. The RF fundamental frequency should be excluded against the limit line in the operating frequency band.
11. For Band 7, 38, 41

$$\begin{aligned} & \text{The limit line is derived from } 55 + 10\log(P)\text{dB below the transmitter power P(Watts)} \\ & = P(W) - [55 + 10\log(P)] \text{ (dB)} \\ & = [30 + 10\log(P)] \text{ (dBm)} - [55 + 10\log(P)] \text{ (dB)} \\ & = -25\text{dBm.} \end{aligned}$$



3.9 Frequency Stability

3.9.1 Description of Frequency Stability Measurement

The frequency stability shall be measured by variation of ambient temperature and variation of primary supply voltage to ensure that the fundamental emission stays within the authorized frequency block.

3.9.2 Test Procedures for Temperature Variation

1. The testing follows ANSI C63.26 section 5.6.4
2. The EUT was set up in the thermal chamber and connected with the system simulator.
3. With power OFF, the temperature was decreased to -30°C and the EUT was stabilized before testing. Power was applied and the maximum change in frequency was recorded within one minute.
4. With power OFF, the temperature was raised in 10°C step up to 50°C. The EUT was stabilized at each step for at least half an hour. Power was applied and the maximum frequency change was recorded within one minute.

3.9.3 Test Procedures for Voltage Variation

1. The testing follows ANSI C63.26 section 5.6.5
2. The EUT was placed in a temperature chamber at 20±5°C and connected with the system simulator.
3. The power supply voltage to the EUT was varied from 85% to 115% of the nominal value for other than hand carried battery equipment.
4. For hand carried, battery powered equipment, reduce the primary ac or dc supply voltage to the battery operating end point, which shall be specified by the manufacturer.
5. The variation in frequency was measured for the worst case.

4 Radiated Test Items

4.1 Measuring Instruments

See list of measuring instruments of this test report.

4.2 Test Setup

4.2.1 For radiated test below 30MHz

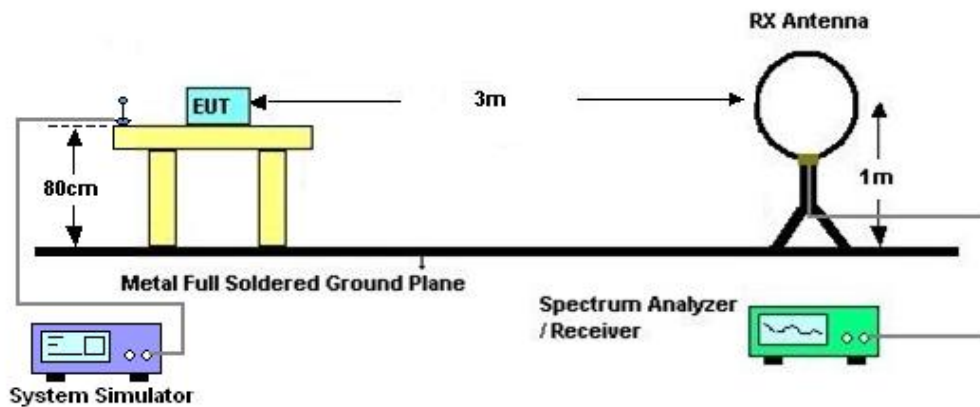

4.2.2 For radiated test from 30MHz to 1GHz

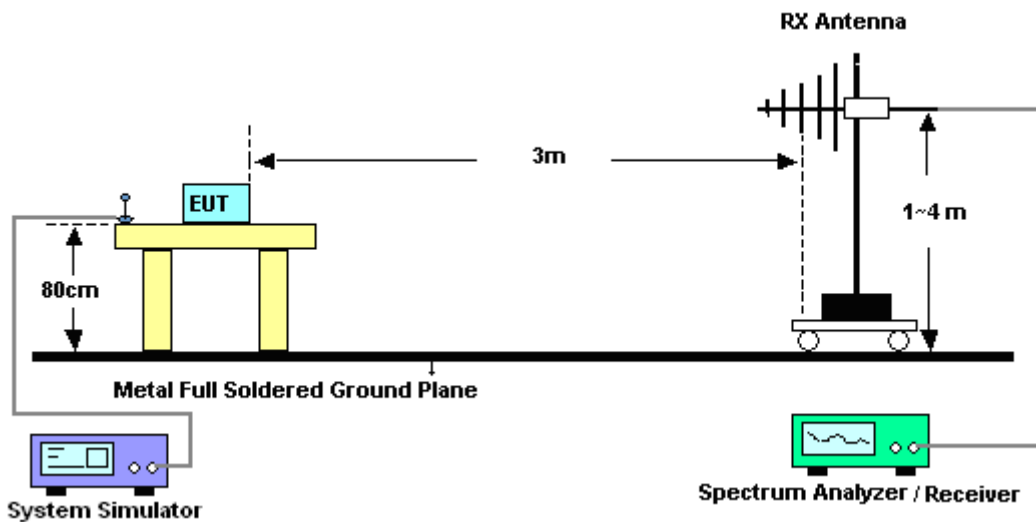

4.2.3 For radiated test above 1GHz

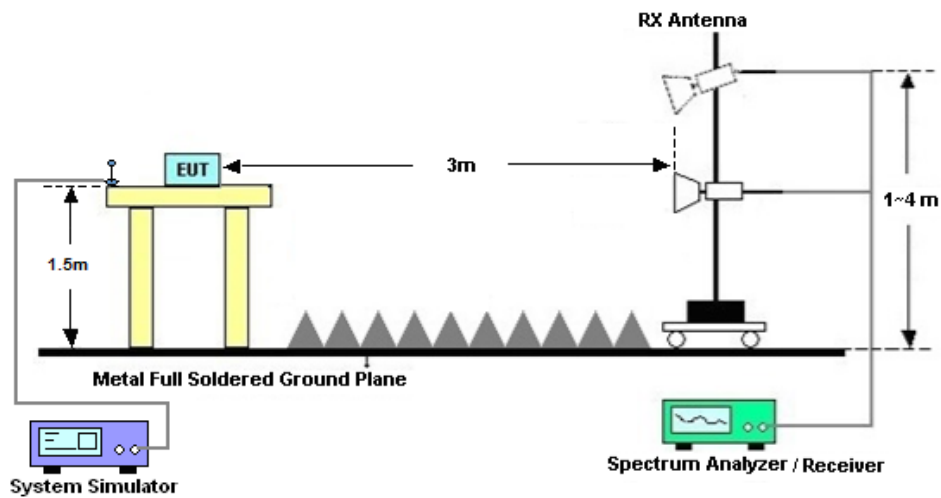

4.3 Test Result of Radiated Test

The low frequency, which started from 9 kHz to 30MHz, was pre-scanned and the result which was 20dB lower than the limit line was not reported.

Please refer to Appendix B.



4.4 Radiated Spurious Emission

4.4.1 Description of Radiated Spurious Emission

The radiated spurious emission was measured by substitution method according to ANSI C63.26.

For Band 7, 38, 41

The power of any emission outside of the authorized operating frequency ranges must be attenuated below the transmitter power (P) by a factor of at least $55 + 10 \log (P)$ dB.

The spectrum is scanned from 30 MHz up to a frequency including its 10th harmonic.

4.4.2 Test Procedures

1. The testing follows ANSI C63.26 Section 5.5
2. The EUT was placed on a turntable with 0.8 meter height for frequency below 1GHz and 1.5 meter height for frequency above 1GHz respectively above ground.
3. The EUT was set 3 meters from the receiving antenna mounted on the antenna tower.
4. The table was rotated 360 degrees to determine the position of the highest spurious emission.
5. The height of the receiving antenna is varied between 1m to 4m to search the maximum spurious emission for both horizontal and vertical polarizations.
6. During the measurement, the system simulator parameters were set to force the EUT transmitting at maximum output power.
7. Make the measurement with the spectrum analyzer's RBW = 1MHz, VBW = 3MHz, taking the record of maximum spurious emission.
8. A horn antenna was substituted in place of the EUT and was driven by a signal generator.
9. Tune the output power of signal generator to the same emission level with EUT maximum spurious emission.
10. $EIRP \text{ (dBm)} = S.G. \text{ Power} - Tx \text{ Cable Loss} + Tx \text{ Antenna Gain}$
11. $ERP \text{ (dBm)} = EIRP - 2.15$
12. For Band 7, 38, 41

The limit line is derived from $55 + 10\log(P)$ dB below the transmitter power P(Watts)
= $P(W) - [55 + 10\log(P)]$ (dB)
= $[30 + 10\log(P)]$ (dBm) - $[55 + 10\log(P)]$ (dB)
= -25dBm.



5 List of Measuring Equipment

Instrument	Manufacturer	Model No.	Serial No.	Characteristics	Calibration Date	Test Date	Due Date	Remark
Spectrum Analyzer	R&S	FSV40	101078	10Hz~40GHz	Apr. 07, 2022	Jan. 15, 2023~ Jan. 31, 2023	Apr. 06, 2023	Conducted (TH01-SZ)
Power Divider	TOJOIN	PS-2SM-04 265	60.06.020.007 7	0.4GHz~26.5GHz	Dec. 25, 2022	Jan. 15, 2023~ Jan. 31, 2023	Dec. 24, 2023	Conducted (TH01-SZ)
Thermal Chamber	Ten Billion Hongzhangroup	LP-150U	H2014081803	-40~+150°C	Jul. 07, 2022	Jan. 15, 2023~ Jan. 31, 2023	Jul. 06, 2023	Conducted (TH01-SZ)
EXA Spectrum Analyzer	KEYSIGHT	N9010A	MY55150213	10Hz~44GHz	Jul. 07, 2022	Jan. 16, 2023	Jul. 06, 2023	Radiation (03CH04-SZ)
Loop Antenna	R&S	HFH2-Z2	100354	9kHz~30MHz	Jun. 28, 2022	Jan. 16, 2023	Jun. 27, 2024	Radiation (03CH04-SZ)
Bilog Antenna	TeseQ	CBL6111D	41909	30MHz~1GHz	Apr. 27, 2022	Jan. 16, 2023	Apr. 26, 2023	Radiation (03CH04-SZ)
Double Ridge Horn Antenna	SCHWARZBECK	BBHA9120D	9120D-1474	1GHz~18GHz	Jul. 07, 2022	Jan. 16, 2023	Jul. 06, 2023	Radiation (03CH04-SZ)
Horn Antenna	SCHWARZBECK	BBHA9170	9170#679	15GHz~40GHz	Jul. 07, 2022	Jan. 16, 2023	Jul. 06, 2023	Radiation (03CH04-SZ)
Amplifier	Burgeon	BPA-530	102211	0.01Hz ~3000MHz	Oct. 19, 2022	Jan. 16, 2023	Oct. 18, 2023	Radiation (03CH04-SZ)
HF Amplifier	MITEQ	AMF-7D-00 101800-30-1 0P-R	1943528	1GHz~18GHz	Oct. 19, 2022	Jan. 16, 2023	Oct. 18, 2023	Radiation (03CH04-SZ)
HF Amplifier	MITEQ	TTA1840-35 -HG	1871923	18GHz~40GHz	Jul. 06, 2022	Jan. 16, 2023	Jul. 05, 2023	Radiation (03CH04-SZ)
Amplifier	Agilent Technologies	83017A	MY57280136	500MHz~26.5GHz	Sep. 30, 2022	Jan. 16, 2023	Sep. 29, 2023	Radiation (03CH04-SZ)
AC Power Source	APC	AFV-S-600B	F119050019	N/A	Nov. 10, 2022	Jan. 16, 2023	Nov. 09, 2023	Radiation (03CH04-SZ)
Turn Table	EM	EM1000	N/A	0~360 degree	NCR	Jan. 16, 2023	NCR	Radiation (03CH04-SZ)
Antenna Mast	EM	EM1000	N/A	1 m~4 m	NCR	Jan. 16, 2023	NCR	Radiation (03CH04-SZ)

NCR: No Calibration Required



6 Uncertainty of Evaluation

The measurement uncertainties shown below were calculated in accordance with the requirements of ANSI 63.26-2015. All the measurement uncertainty value were shown with a coverage K=2 to indicate 95% level of confidence. The measurement data show herein meets or exceeds the CISPR measurement uncertainty values specified in CISPR 16-4-2 and can be compared directly to specified limit to determine compliance.

Uncertainty of Conducted Measurement

Test Item	Uncertainty
Conducted Power	±1.34 dB
Conducted Emissions	±1.34 dB
Occupied Channel Bandwidth	±0.13 %

Uncertainty of Radiated Emission Measurement (30 MHz ~ 1000 MHz)

Measuring Uncertainty for a Level of Confidence of 95% (U = 2Uc(y))	2.8dB
---	-------

Uncertainty of Radiated Emission Measurement (1000 MHz ~ 18000 MHz)

Measuring Uncertainty for a Level of Confidence of 95% (U = 2Uc(y))	3.1dB
---	-------

Uncertainty of Radiated Emission Measurement (18000 MHz ~ 40000 MHz)

Measuring Uncertainty for a Level of Confidence of 95% (U = 2Uc(y))	3.9dB
---	-------



Appendix A. Test Results of Conducted Test

Test Engineer :	ZhenHua Zou	Temperature :	24~26°C
		Relative Humidity :	50~53%

Conducted Output Power(Average power)

LTE Band 7:

BW [MHz]	Modulation	RB Size	RB Offset	Power Low Ch. / Freq.	Power Middle Ch. / Freq.	Power High Ch. / Freq.
Channel				20850	21100	21350
Frequency (MHz)				2510	2535	2560
20	QPSK	1	0	23.17	23.17	22.98
20	QPSK	1	49	23.40	23.42	23.33
20	QPSK	1	99	23.24	23.25	23.19
20	QPSK	50	0	22.33	22.37	22.17
20	QPSK	50	24	22.46	22.50	22.35
20	QPSK	50	50	22.41	22.33	22.25
20	QPSK	100	0	22.35	22.37	22.23
20	16QAM	1	0	22.65	22.40	22.34
20	16QAM	1	49	22.43	22.54	22.56
20	16QAM	1	99	22.27	22.09	22.24
20	16QAM	50	0	21.36	21.38	21.12
20	16QAM	50	24	21.52	21.40	21.31
20	16QAM	50	50	21.38	21.20	21.33
20	16QAM	100	0	21.35	21.27	21.26
20	64QAM	1	0	21.58	21.23	21.34
20	64QAM	1	49	21.37	21.50	21.36
20	64QAM	1	99	21.60	21.50	21.46
20	64QAM	50	0	20.39	20.36	20.21
20	64QAM	50	24	20.55	20.37	20.41
20	64QAM	50	50	20.45	20.26	20.40
20	64QAM	100	0	20.42	20.40	20.29
Channel				20825	21100	21375
Frequency (MHz)				2507.5	2535	2562.5
15	QPSK	1	0	23.14	23.16	22.83
15	QPSK	1	37	23.26	23.27	23.32
15	QPSK	1	74	23.13	23.24	23.05
15	QPSK	36	0	22.23	22.25	22.08
15	QPSK	36	20	22.38	22.37	22.33
15	QPSK	36	39	22.38	22.20	22.20
15	QPSK	75	0	22.30	22.36	22.14
15	16QAM	1	0	22.51	22.31	22.19
15	16QAM	1	37	22.42	22.51	22.42
15	16QAM	1	74	22.19	21.99	22.21
15	16QAM	36	0	21.22	21.26	20.99
15	16QAM	36	20	21.46	21.27	21.17
15	16QAM	36	39	21.24	21.08	21.27
15	16QAM	75	0	21.22	21.19	21.17
15	64QAM	1	0	21.55	21.23	21.25



15	64QAM	1	37	21.27	21.38	21.32
15	64QAM	1	74	21.49	21.50	21.42
15	64QAM	36	0	20.36	20.30	20.21
15	64QAM	36	20	20.52	20.27	20.28
15	64QAM	36	39	20.41	20.24	20.30
15	64QAM	75	0	20.30	20.27	20.20
Channel				20800	21100	21400
Frequency (MHz)				2505	2535	2565
10	QPSK	1	0	23.11	23.11	22.90
10	QPSK	1	25	23.30	23.39	23.33
10	QPSK	1	49	23.23	23.14	23.04
10	QPSK	25	0	22.27	22.30	22.09
10	QPSK	25	12	22.33	22.40	22.20
10	QPSK	25	25	22.31	22.18	22.22
10	QPSK	50	0	22.32	22.35	22.22
10	16QAM	1	0	22.58	22.31	22.31
10	16QAM	1	25	22.43	22.41	22.48
10	16QAM	1	49	22.12	21.95	22.18
10	16QAM	25	0	21.27	21.34	20.97
10	16QAM	25	12	21.41	21.40	21.31
10	16QAM	25	25	21.28	21.13	21.26
10	16QAM	50	0	21.33	21.15	21.11
10	64QAM	1	0	21.55	21.09	21.22
10	64QAM	1	25	21.35	21.50	21.33
10	64QAM	1	49	21.54	21.45	21.37
10	64QAM	25	0	20.24	20.23	20.21
10	64QAM	25	12	20.53	20.35	20.38
10	64QAM	25	25	20.40	20.23	20.29
10	64QAM	50	0	20.37	20.32	20.26
Channel				20775	21100	21425
Frequency (MHz)				2502.5	2535	2567.5
5	QPSK	1	0	23.14	23.16	22.83
5	QPSK	1	12	23.28	23.30	23.33
5	QPSK	1	24	23.12	23.21	23.06
5	QPSK	12	0	22.32	22.28	22.05
5	QPSK	12	7	22.39	22.48	22.34
5	QPSK	12	13	22.32	22.29	22.10
5	QPSK	25	0	22.23	22.26	22.22
5	16QAM	1	0	22.50	22.27	22.28
5	16QAM	1	12	22.29	22.41	22.50
5	16QAM	1	24	22.20	22.00	22.11
5	16QAM	12	0	21.28	21.35	20.99
5	16QAM	12	7	21.40	21.26	21.21
5	16QAM	12	13	21.30	21.13	21.25
5	16QAM	25	0	21.30	21.27	21.13
5	64QAM	1	0	21.43	21.12	21.26
5	64QAM	1	12	21.37	21.44	21.34
5	64QAM	1	24	21.47	21.36	21.35
5	64QAM	12	0	20.30	20.31	20.08
5	64QAM	12	7	20.44	20.33	20.34
5	64QAM	12	13	20.38	20.19	20.40
5	64QAM	25	0	20.28	20.27	20.27



LTE Band 38:

BW [MHz]	Modulation	RB Size	RB Offset	Power Low Ch. / Freq.	Power Middle Ch. / Freq.	Power High Ch. / Freq.
Channel				37850	38000	38150
Frequency (MHz)				2580	2595	2610
20	QPSK	1	0	24.01	24.10	24.09
20	QPSK	1	49	24.24	24.33	24.28
20	QPSK	1	99	24.11	24.06	24.14
20	QPSK	50	0	23.24	23.16	23.31
20	QPSK	50	24	23.31	23.40	23.38
20	QPSK	50	50	23.26	23.30	23.33
20	QPSK	100	0	23.15	23.35	23.34
20	16QAM	1	0	23.27	23.24	23.32
20	16QAM	1	49	23.51	23.56	23.45
20	16QAM	1	99	23.33	23.48	23.50
20	16QAM	50	0	22.19	22.19	22.40
20	16QAM	50	24	22.32	22.36	22.49
20	16QAM	50	50	22.29	22.31	22.43
20	16QAM	100	0	22.25	22.30	22.36
20	64QAM	1	0	22.06	22.11	22.31
20	64QAM	1	49	22.44	22.48	22.54
20	64QAM	1	99	22.35	22.35	22.36
20	64QAM	50	0	21.19	21.28	21.27
20	64QAM	50	24	21.36	21.42	21.48
20	64QAM	50	50	21.27	21.33	21.46
20	64QAM	100	0	21.20	21.27	21.39
Channel				37825	38000	38175
Frequency (MHz)				2577.5	2595	2612.5
15	QPSK	1	0	23.95	24.01	24.06
15	QPSK	1	37	24.12	24.19	24.27
15	QPSK	1	74	24.04	24.06	24.01
15	QPSK	36	0	23.16	23.02	23.16
15	QPSK	36	20	23.17	23.32	23.26
15	QPSK	36	39	23.12	23.22	23.27
15	QPSK	75	0	23.01	23.29	23.25
15	16QAM	1	0	23.23	23.21	23.32
15	16QAM	1	37	23.42	23.50	23.35
15	16QAM	1	74	23.18	23.34	23.47
15	16QAM	36	0	22.15	22.10	22.28
15	16QAM	36	20	22.29	22.23	22.42
15	16QAM	36	39	22.25	22.26	22.31
15	16QAM	75	0	22.13	22.22	22.36
15	64QAM	1	0	21.91	22.09	22.29
15	64QAM	1	37	22.32	22.37	22.42
15	64QAM	1	74	22.25	22.30	22.23
15	64QAM	36	0	21.07	21.14	21.22
15	64QAM	36	20	21.33	21.28	21.47
15	64QAM	36	39	21.26	21.27	21.31
15	64QAM	75	0	21.13	21.19	21.31



Channel				37800	38000	38200
Frequency (MHz)				2575	2595	2615
10	QPSK	1	0	23.90	24.02	24.08
10	QPSK	1	25	24.23	24.31	24.21
10	QPSK	1	49	24.08	24.02	24.10
10	QPSK	25	0	23.18	23.09	23.24
10	QPSK	25	12	23.23	23.31	23.35
10	QPSK	25	25	23.11	23.24	23.26
10	QPSK	50	0	23.06	23.29	23.22
10	16QAM	1	0	23.24	23.09	23.25
10	16QAM	1	25	23.38	23.46	23.43
10	16QAM	1	49	23.30	23.48	23.42
10	16QAM	25	0	22.16	22.19	22.38
10	16QAM	25	12	22.18	22.23	22.39
10	16QAM	25	25	22.23	22.26	22.43
10	16QAM	50	0	22.13	22.16	22.26
10	64QAM	1	0	22.00	22.08	22.20
10	64QAM	1	25	22.33	22.47	22.47
10	64QAM	1	49	22.34	22.33	22.23
10	64QAM	25	0	21.09	21.17	21.25
10	64QAM	25	12	21.35	21.29	21.40
10	64QAM	25	25	21.14	21.33	21.46
10	64QAM	50	0	21.19	21.22	21.31
Channel				37775	38000	38225
Frequency (MHz)				2572.5	2595	2617.5
5	QPSK	1	0	24.00	24.05	24.03
5	QPSK	1	12	24.17	24.23	24.17
5	QPSK	1	24	24.03	23.94	24.13
5	QPSK	12	0	23.21	23.04	23.17
5	QPSK	12	7	23.22	23.34	23.33
5	QPSK	12	13	23.12	23.17	23.24
5	QPSK	25	0	23.12	23.21	23.27
5	16QAM	1	0	23.27	23.11	23.21
5	16QAM	1	12	23.48	23.47	23.37
5	16QAM	1	24	23.33	23.44	23.38
5	16QAM	12	0	22.06	22.10	22.39
5	16QAM	12	7	22.23	22.22	22.41
5	16QAM	12	13	22.21	22.29	22.35
5	16QAM	25	0	22.20	22.20	22.31
5	64QAM	1	0	22.02	22.10	22.30
5	64QAM	1	12	22.31	22.37	22.52
5	64QAM	1	24	22.33	22.25	22.24
5	64QAM	12	0	21.17	21.15	21.19
5	64QAM	12	7	21.29	21.31	21.47
5	64QAM	12	13	21.19	21.19	21.33
5	64QAM	25	0	21.17	21.26	21.30



LTE Band 41:

BW [MHz]	Modulation	RB Size	RB Offset	Power Low Ch. / Freq.	Power Middle Ch. / Freq.	Power High Ch. / Freq.
Channel				39750	40620	41490
Frequency (MHz)				2506	2593	2680
20	QPSK	1	0	24.02	24.11	24.04
20	QPSK	1	49	24.23	24.36	24.25
20	QPSK	1	99	24.04	24.08	24.08
20	QPSK	50	0	23.05	23.13	23.38
20	QPSK	50	24	23.25	23.44	23.39
20	QPSK	50	50	23.15	23.26	23.25
20	QPSK	100	0	23.31	23.38	23.37
20	16QAM	1	0	23.40	23.46	23.36
20	16QAM	1	49	23.36	23.46	23.40
20	16QAM	1	99	23.28	23.34	23.20
20	16QAM	50	0	22.14	22.20	22.14
20	16QAM	50	24	22.28	22.32	22.23
20	16QAM	50	50	22.20	22.24	22.23
20	16QAM	100	0	22.04	22.18	22.05
20	64QAM	1	0	21.94	22.05	22.04
20	64QAM	1	49	22.42	22.42	22.36
20	64QAM	1	99	22.23	22.30	22.20
20	64QAM	50	0	21.07	21.18	21.13
20	64QAM	50	24	21.20	21.34	21.24
20	64QAM	50	50	21.18	21.31	21.28
20	64QAM	100	0	21.14	21.26	21.14
Channel				39725	40620	41515
Frequency (MHz)				2503.5	2593	2682.5
15	QPSK	1	0	23.99	24.04	23.99
15	QPSK	1	37	24.24	24.30	24.20
15	QPSK	1	74	23.88	23.91	23.99
15	QPSK	36	0	22.98	23.02	23.05
15	QPSK	36	20	23.32	23.28	23.37
15	QPSK	36	39	23.12	23.16	23.19
15	QPSK	75	0	23.22	23.32	23.26
15	16QAM	1	0	23.07	23.12	23.07
15	16QAM	1	37	23.35	23.39	23.34
15	16QAM	1	74	23.22	23.19	23.19
15	16QAM	36	0	22.06	22.06	22.11
15	16QAM	36	20	22.15	22.26	22.17
15	16QAM	36	39	22.04	22.09	22.08
15	16QAM	75	0	22.10	22.03	22.12
15	64QAM	1	0	21.92	21.87	21.89
15	64QAM	1	37	22.36	22.34	22.27
15	64QAM	1	74	22.10	22.25	22.11
15	64QAM	36	0	21.00	21.02	21.12
15	64QAM	36	20	21.20	21.19	21.24
15	64QAM	36	39	21.11	21.15	21.14
15	64QAM	75	0	21.09	21.14	21.12



Channel				39700	40620	41540
Frequency (MHz)				2501	2593	2685
10	QPSK	1	0	24.06	23.94	24.03
10	QPSK	1	25	24.16	24.31	24.29
10	QPSK	1	49	23.97	23.95	23.89
10	QPSK	25	0	23.03	23.01	22.96
10	QPSK	25	12	23.39	23.36	23.36
10	QPSK	25	25	23.09	23.12	23.12
10	QPSK	50	0	23.33	23.21	23.32
10	16QAM	1	0	23.12	23.13	23.19
10	16QAM	1	25	23.37	23.39	23.38
10	16QAM	1	49	23.17	23.26	23.19
10	16QAM	25	0	22.13	22.04	22.08
10	16QAM	25	12	22.24	22.20	22.16
10	16QAM	25	25	22.09	22.16	22.18
10	16QAM	50	0	22.06	22.02	21.98
10	64QAM	1	0	21.95	21.95	21.89
10	64QAM	1	25	22.29	22.29	22.30
10	64QAM	1	49	22.23	22.13	22.11
10	64QAM	25	0	21.07	20.99	21.12
10	64QAM	25	12	21.27	21.21	21.28
10	64QAM	25	25	21.22	21.14	21.16
10	64QAM	50	0	21.10	21.07	21.12
Channel				39675	40620	41565
Frequency (MHz)				2498.5	2593	2687.5
5	QPSK	1	0	24.02	24.06	24.03
5	QPSK	1	12	24.22	24.21	24.17
5	QPSK	1	24	24.03	23.97	23.92
5	QPSK	12	0	22.97	23.07	23.01
5	QPSK	12	7	23.26	23.37	23.35
5	QPSK	12	13	23.20	23.20	23.13
5	QPSK	25	0	23.18	23.18	23.22
5	16QAM	1	0	23.07	23.10	23.10
5	16QAM	1	12	23.26	23.28	23.29
5	16QAM	1	24	23.28	23.14	23.21
5	16QAM	12	0	22.00	22.07	22.06
5	16QAM	12	7	22.18	22.15	22.15
5	16QAM	12	13	22.19	22.13	22.13
5	16QAM	25	0	22.08	21.99	22.11
5	64QAM	1	0	21.94	21.86	21.99
5	64QAM	1	12	22.32	22.30	22.28
5	64QAM	1	24	22.14	22.18	22.18
5	64QAM	12	0	21.06	21.01	21.06
5	64QAM	12	7	21.27	21.28	21.28
5	64QAM	12	13	21.18	21.14	21.15
5	64QAM	25	0	21.19	21.15	21.15



CA Power

LTE Band 7C_CA:

Combination 20MHz+20MHz (100RB+100RB)								
PCC Channel	SCC Channel	Modulation	PCC		SCC		Total RB Size	Measured Power (dBm)
			RB Size	RB offset	RB Size	RB offset		
20850	21048	QPSK	100	0	100	0	200	21.18
			1	0	1	99	2	14.51
			1	99	1	0	2	23.35
		16QAM	100	0	100	0	200	20.18
			1	0	1	99	2	14.53
			1	99	1	0	2	22.68
		64QAM	100	0	100	0	200	20.23
			1	0	1	99	2	14.52
			1	99	1	0	2	20.58
21001	21199	QPSK	100	0	100	0	200	21.46
			1	0	1	99	2	14.42
			1	99	1	0	2	23.4
		16QAM	100	0	100	0	200	20.41
			1	0	1	99	2	14.45
			1	99	1	0	2	22.74
		64QAM	100	0	100	0	200	20.42
			1	0	1	99	2	14.47
			1	99	1	0	2	20.65
21152	21350	QPSK	100	0	100	0	200	21.48
			1	0	1	99	2	14.43
			1	99	1	0	2	23.37
		16QAM	100	0	100	0	200	20.43
			1	0	1	99	2	14.45
			1	99	1	0	2	22.73
		64QAM	100	0	100	0	200	20.41
			1	0	1	99	2	14.47
			1	99	1	0	2	20.61
Combination 20MHz+15MHz (100RB+75RB)								
PCC Channel	SCC Channel	Modulation	PCC		SCC		Total RB Size	Measured Power (dBm)
			RB Size	RB offset	RB Size	RB offset		
20850	21021	QPSK	100	0	75	0	175	21.13
			1	0	1	74	2	14.44
			1	99	1	0	2	23.24
		16QAM	100	0	75	0	175	20.11
			1	0	1	74	2	14.42
			1	99	1	0	2	22.63
		64QAM	100	0	75	0	175	20.16
			1	0	1	74	2	14.45



			1	99	1	0	2	20.46
21026	21197	QPSK	100	0	75	0	175	21.44
			1	0	1	74	2	14.32
			1	99	1	0	2	23.39
		16QAM	100	0	75	0	175	20.32
			1	0	1	74	2	14.33
			1	99	1	0	2	22.63
		64QAM	100	0	75	0	175	20.31
			1	0	1	74	2	14.44
			1	99	1	0	2	20.58
21201	21372	QPSK	100	0	75	0	175	21.46
			1	0	1	74	2	14.34
			1	99	1	0	2	23.32
		16QAM	100	0	75	0	175	20.37
			1	0	1	74	2	14.38
			1	99	1	0	2	22.65
		64QAM	100	0	75	0	175	20.34
			1	0	1	74	2	14.39
			1	99	1	0	2	20.53
Combination 15MHz+20MHz (75RB+100RB)								
PCC Channel	SCC Channel	Modulation	PCC		SCC		Total RB Size	Measured Power (dBm)
			RB Size	RB offset	RB Size	RB offset		
20828	20999	QPSK	75	0	100	0	175	21.12
			1	0	1	99	2	14.41
			1	74	1	0	2	23.3
		16QAM	75	0	100	0	175	20.08
			1	0	1	99	2	14.47
			1	74	1	0	2	22.62
		64QAM	75	0	100	0	175	20.16
			1	0	1	99	2	14.4
			1	74	1	0	2	20.47
21003	21174	QPSK	75	0	100	0	175	21.38
			1	0	1	99	2	14.3
			1	74	1	0	2	23.29
		16QAM	75	0	100	0	175	20.36
			1	0	1	99	2	14.36
			1	74	1	0	2	22.63
		64QAM	75	0	100	0	175	20.38
			1	0	1	99	2	14.42
			1	74	1	0	2	20.61
21179	21350	QPSK	75	0	100	0	175	21.38
			1	0	1	99	2	14.34
			1	74	1	0	2	23.29
		16QAM	75	0	100	0	175	20.31
			1	0	1	99	2	14.36



			1	74	1	0	2	22.61
		64QAM	75	0	100	0	175	20.32
			1	0	1	99	2	14.38
			1	74	1	0	2	20.58
Combination 20MHz+10MHz (100RB+50RB)								
PCC Channel	SCC Channel	Modulation	PCC		SCC		Total RB Size	Measured Power (dBm)
			RB Size	RB offset	RB Size	RB offset		
20850	20994	QPSK	100	0	50	0	150	21.14
			1	0	1	49	2	14.49
			1	99	1	0	2	23.28
		16QAM	100	0	50	0	150	20.11
			1	0	1	49	2	14.44
			1	99	1	0	2	22.61
		64QAM	100	0	50	0	150	20.2
			1	0	1	49	2	14.4
			1	99	1	0	2	20.52
21051	21195	QPSK	100	0	50	0	150	21.36
			1	0	1	49	2	14.37
			1	99	1	0	2	23.37
		16QAM	100	0	50	0	150	20.36
			1	0	1	49	2	14.42
			1	99	1	0	2	22.62
		64QAM	100	0	50	0	150	20.36
			1	0	1	49	2	14.35
			1	99	1	0	2	20.61
21251	21395	QPSK	100	0	50	0	150	21.36
			1	0	1	49	2	14.38
			1	99	1	0	2	23.34
		16QAM	100	0	50	0	150	20.34
			1	0	1	49	2	14.41
			1	99	1	0	2	22.66
		64QAM	100	0	50	0	150	20.3
			1	0	1	49	2	14.44
			1	99	1	0	2	20.58
Combination 10MHz+20MHz (50RB+100RB)								
PCC Channel	SCC Channel	Modulation	PCC		SCC		Total RB Size	Measured Power (dBm)
			RB Size	RB offset	RB Size	RB offset		
20805	20949	QPSK	50	0	100	0	150	21.13
			1	0	1	99	2	14.48
			1	49	1	0	2	23.23
		16QAM	50	0	100	0	150	20.07
			1	0	1	99	2	14.5
			1	49	1	0	2	22.64
		64QAM	50	0	100	0	150	20.19
			1	0	1	99	2	14.5



			1	49	1	0	2	20.5
21006	21150	QPSK	50	0	100	0	150	21.38
			1	0	1	99	2	14.35
			1	49	1	0	2	23.33
		16QAM	50	0	100	0	150	20.36
			1	0	1	99	2	14.34
			1	49	1	0	2	22.63
		64QAM	50	0	100	0	150	20.39
			1	0	1	99	2	14.35
			1	49	1	0	2	20.57
		21206	21350	QPSK	50	0	100	0
1	0				1	99	2	14.41
1	49				1	0	2	23.28
16QAM	50			0	100	0	150	20.37
	1			0	1	99	2	14.37
	1			49	1	0	2	22.65
64QAM	50			0	100	0	150	20.3
	1			0	1	99	2	14.41
	1			49	1	0	2	20.59
Combination 15MHz+15MHz (75RB+75RB)								
PCC Channel	SCC Channel	Modulation	PCC		SCC		Total RB Size	Measured Power (dBm)
			RB Size	RB offset	RB Size	RB offset		
20825	20975	QPSK	75	0	75	0	150	21.1
			1	0	1	74	2	14.45
			1	74	1	0	2	23.29
		16QAM	75	0	75	0	150	20.08
			1	0	1	74	2	14.47
			1	74	1	0	2	22.57
		64QAM	75	0	75	0	150	20.17
			1	0	1	74	2	14.44
			1	74	1	0	2	20.51
		21025	21175	QPSK	75	0	75	0
1	0				1	74	2	14.37
1	74				1	0	2	23.28
16QAM	75			0	75	0	150	20.37
	1			0	1	74	2	14.35
	1			74	1	0	2	22.68
64QAM	75			0	75	0	150	20.38
	1			0	1	74	2	14.39
	1			74	1	0	2	20.6
21225	21375			QPSK	75	0	75	0
		1	0		1	74	2	14.31
		1	74		1	0	2	23.32
		16QAM	75	0	75	0	150	20.4
			1	0	1	74	2	14.35



PCC Channel	SCC Channel	Modulation	PCC		SCC		Total RB Size	Measured Power (dBm)		
			RB Size	RB offset	RB Size	RB offset				
		64QAM	1	74	1	0	2	22.64		
			75	0	75	0	150	20.32		
			1	0	1	74	2	14.41		
			1	74	1	0	2	20.54		
Combination 15MHz+10MHz (75RB+50RB)										
20825	20945	QPSK	75	0	50	0	125	21.1		
			1	0	1	49	2	14.43		
			1	74	1	0	2	23.3		
		16QAM	75	0	50	0	125	20.13		
			1	0	1	49	2	14.41		
			1	74	1	0	2	22.66		
		64QAM	75	0	50	0	125	20.16		
			1	0	1	49	2	14.4		
			1	74	1	0	2	20.49		
		21051	21171	QPSK	75	0	50	0	125	21.38
					1	0	1	49	2	14.34
					1	74	1	0	2	23.31
16QAM	75			0	50	0	125	20.32		
	1			0	1	49	2	14.4		
	1			74	1	0	2	22.67		
64QAM	75			0	50	0	125	20.4		
	1			0	1	49	2	14.37		
	1			74	1	0	2	20.59		
21277	21397			QPSK	75	0	50	0	125	21.44
					1	0	1	49	2	14.39
					1	74	1	0	2	23.33
		16QAM	75	0	50	0	125	20.31		
			1	0	1	49	2	14.41		
			1	74	1	0	2	22.63		
		64QAM	75	0	50	0	125	20.36		
			1	0	1	49	2	14.43		
			1	74	1	0	2	20.58		



LTE Band 41C_CA:

Combination 20MHz+20MHz (100RB+100RB)								
PCC Channel	SCC Channel	Modulation	PCC		SCC		Total RB Size	Measured Power (dBm)
			RB Size	RB offset	RB Size	RB offset		
39750	39948	QPSK	100	0	100	0	200	22.04
			1	0	1	99	2	15.2
			1	99	1	0	2	24.32
		16QAM	100	0	100	0	200	21.03
			1	0	1	99	2	15.23
			1	99	1	0	2	23.39
		64QAM	100	0	100	0	200	20.97
			1	0	1	99	2	15.08
			1	99	1	0	2	21.05
40521	40719	QPSK	100	0	100	0	200	22.15
			1	0	1	99	2	15.28
			1	99	1	0	2	24.35
		16QAM	100	0	100	0	200	21.08
			1	0	1	99	2	15.35
			1	99	1	0	2	23.47
		64QAM	100	0	100	0	200	21.07
			1	0	1	99	2	15.18
			1	99	1	0	2	21.11
41292	41490	QPSK	100	0	100	0	200	22.27
			1	0	1	99	2	15.42
			1	99	1	0	2	24.33
		16QAM	100	0	100	0	200	21.16
			1	0	1	99	2	15.47
			1	99	1	0	2	23.64
		64QAM	100	0	100	0	200	21.13
			1	0	1	99	2	15.23
			1	99	1	0	2	21.36
CA_41C Ant 13								
Combination 20MHz+15MHz (100RB+75RB)								
PCC Channel	SCC Channel	Modulation	PCC		SCC		Total RB Size	Measured Power (dBm)
			RB Size	RB offset	RB Size	RB offset		
39750	39921	QPSK	100	0	75	0	175	21.99
			1	0	1	74	2	15.09
			1	99	1	0	2	24.21
		16QAM	100	0	75	0	175	20.94
			1	0	1	74	2	15.16
			1	99	1	0	2	23.34
		64QAM	100	0	75	0	175	20.88
			1	0	1	74	2	15.06
			1	99	1	0	2	20.95
40546	40717	QPSK	100	0	75	0	175	22.03



		16QAM	1	0	1	74	2	15.18		
			1	99	1	0	2	24.33		
			100	0	75	0	175	20.98		
			1	0	1	74	2	15.28		
		64QAM	1	99	1	0	2	23.42		
			100	0	75	0	175	20.97		
			1	0	1	74	2	15.14		
			1	99	1	0	2	21.05		
41341	41512	QPSK	100	0	75	0	175	22.25		
			1	0	1	74	2	15.34		
			1	99	1	0	2	24.30		
		16QAM	100	0	75	0	175	21.13		
			1	0	1	74	2	15.38		
			1	99	1	0	2	23.61		
		64QAM	100	0	75	0	175	21.04		
			1	0	1	74	2	15.18		
			1	99	1	0	2	21.33		
		Combination 15MHz+20MHz (75RB+100RB)								
		PCC Channel	SCC Channel	Modulation	PCC		SCC		Total RB Size	Measured Power (dBm)
					RB Size	RB offset	RB Size	RB offset		
39728	39899	QPSK	75	0	100	0	175	21.95		
			1	0	1	99	2	15.13		
			1	74	1	0	2	24.23		
		16QAM	75	0	100	0	175	20.93		
			1	0	1	99	2	15.13		
			1	74	1	0	2	23.36		
		64QAM	75	0	100	0	175	20.90		
			1	0	1	99	2	15.00		
			1	74	1	0	2	20.96		
40523	40694	QPSK	75	0	100	0	175	22.06		
			1	0	1	99	2	15.20		
			1	74	1	0	2	24.32		
		16QAM	75	0	100	0	175	20.98		
			1	0	1	99	2	15.33		
			1	74	1	0	2	23.44		
		64QAM	75	0	100	0	175	21.00		
			1	0	1	99	2	15.16		
			1	74	1	0	2	21.05		
41319	41490	QPSK	75	0	100	0	175	22.25		
			1	0	1	99	2	15.32		
			1	74	1	0	2	24.28		
		16QAM	75	0	100	0	175	21.04		
			1	0	1	99	2	15.45		
			1	74	1	0	2	23.59		
		64QAM	75	0	100	0	175	21.02		



			1	0	1	99	2	15.15
			1	74	1	0	2	21.24
Combination 20MHz+10MHz (100RB+50RB)								
PCC Channel	SCC Channel	Modulation	PCC		SCC		Total RB Size	Measured Power (dBm)
			RB Size	RB offset	RB Size	RB offset		
39750	39894	QPSK	100	0	50	0	150	21.97
			1	0	1	49	2	15.15
			1	99	1	0	2	24.22
		16QAM	100	0	50	0	150	21.01
			1	0	1	49	2	15.17
			1	99	1	0	2	23.35
		64QAM	100	0	50	0	150	20.88
			1	0	1	49	2	15.00
			1	99	1	0	2	20.97
40571	40715	QPSK	100	0	50	0	150	22.09
			1	0	1	49	2	15.22
			1	99	1	0	2	24.31
		16QAM	100	0	50	0	150	20.98
			1	0	1	49	2	15.30
			1	99	1	0	2	23.44
		64QAM	100	0	50	0	150	20.95
			1	0	1	49	2	15.13
			1	99	1	0	2	21.09
41391	41535	QPSK	100	0	50	0	150	22.15
			1	0	1	49	2	15.34
			1	99	1	0	2	24.21
		16QAM	100	0	50	0	150	21.12
			1	0	1	49	2	15.42
			1	99	1	0	2	23.62
		64QAM	100	0	50	0	150	21.01
			1	0	1	49	2	15.15
			1	99	1	0	2	21.26
Combination 10MHz+20MHz (50RB+100RB)								
PCC Channel	SCC Channel	Modulation	PCC		SCC		Total RB Size	Measured Power (dBm)
			RB Size	RB offset	RB Size	RB offset		
39705	39849	QPSK	50	0	100	0	150	21.94
			1	0	1	99	2	15.12
			1	49	1	0	2	24.22
		16QAM	50	0	100	0	150	20.99
			1	0	1	99	2	15.14
			1	49	1	0	2	23.29
		64QAM	50	0	100	0	150	20.89
			1	0	1	99	2	15.04
			1	49	1	0	2	20.96
40526	40670	QPSK	50	0	100	0	150	22.06



		16QAM	1	0	1	99	2	15.26
			1	49	1	0	2	24.26
			50	0	100	0	150	20.97
			1	0	1	99	2	15.30
		64QAM	1	49	1	0	2	23.35
			50	0	100	0	150	20.96
			1	0	1	99	2	15.11
			1	49	1	0	2	21.07
41346	41490	QPSK	50	0	100	0	150	22.16
			1	0	1	99	2	15.30
			1	49	1	0	2	24.22
		16QAM	50	0	100	0	150	21.04
			1	0	1	99	2	15.38
			1	49	1	0	2	23.62
		64QAM	50	0	100	0	150	21.07
			1	0	1	99	2	15.14
			1	49	1	0	2	21.25
			Combination 20MHz+5MHz (100RB+25RB)					
PCC Channel	SCC Channel	Modulation	PCC		SCC		Total RB Size	Measured Power (dBm)
			RB Size	RB offset	RB Size	RB offset		
39750	39867	QPSK	100	0	25	0	125	21.98
			1	0	1	24	2	15.11
			1	99	1	0	2	24.29
		16QAM	100	0	25	0	125	20.94
			1	0	1	24	2	15.17
			1	99	1	0	2	23.37
		64QAM	100	0	25	0	125	20.87
			1	0	1	24	2	14.97
			1	99	1	0	2	21.01
			40595	40712	QPSK	100	0	25
1	0	1				24	2	15.26
1	99	1				0	2	24.23
16QAM	100	0			25	0	125	21.01
	1	0			1	24	2	15.33
	1	99			1	0	2	23.40
64QAM	100	0			25	0	125	21.05
	1	0			1	24	2	15.14
	1	99			1	0	2	21.05
	41440	41557	QPSK	100	0	25	0	125
1				0	1	24	2	15.40
1				99	1	0	2	24.25
16QAM			100	0	25	0	125	21.08
			1	0	1	24	2	15.38
64QAM			1	99	1	0	2	23.59
			100	0	25	0	125	21.01



				1	0	1	24	2	15.18
				1	99	1	0	2	21.26
Combination 5MHz+20MHz (25RB+100RB)									
PCC Channel	SCC Channel	Modulation	PCC		SCC		Total RB Size	Measured Power (dBm)	
			RB Size	RB offset	RB Size	RB offset			
39683	39800	QPSK	25	0	100	0	125	21.94	
			1	0	1	99	2	15.10	
			1	24	1	0	2	24.24	
		16QAM	25	0	100	0	125	20.91	
			1	0	1	99	2	15.11	
			1	24	1	0	2	23.35	
		64QAM	25	0	100	0	125	20.93	
			1	0	1	99	2	14.96	
			1	24	1	0	2	20.99	
40528	40645	QPSK	25	0	100	0	125	22.09	
			1	0	1	99	2	15.24	
			1	24	1	0	2	24.29	
		16QAM	25	0	100	0	125	21.04	
			1	0	1	99	2	15.24	
			1	24	1	0	2	23.37	
		64QAM	25	0	100	0	125	21.05	
			1	0	1	99	2	15.12	
			1	24	1	0	2	21.05	
41373	41490	QPSK	25	0	100	0	125	22.25	
			1	0	1	99	2	15.38	
			1	24	1	0	2	24.21	
		16QAM	25	0	100	0	125	21.07	
			1	0	1	99	2	15.36	
			1	24	1	0	2	23.54	
		64QAM	25	0	100	0	125	21.04	
			1	0	1	99	2	15.21	
			1	24	1	0	2	21.27	
Combination 15MHz+10MHz (75RB+50RB)									
PCC Channel	SCC Channel	Modulation	PCC		SCC		Total RB Size	Measured Power (dBm)	
			RB Size	RB offset	RB Size	RB offset			
39725	39845	QPSK	75	0	50	0	125	21.99	
			1	0	1	49	2	15.18	
			1	74	1	0	2	24.30	
		16QAM	75	0	50	0	125	20.95	
			1	0	1	49	2	15.13	
			1	74	1	0	2	23.27	
		64QAM	75	0	50	0	125	20.93	
			1	0	1	49	2	15.01	
			1	74	1	0	2	20.96	
40571	40691	QPSK	75	0	50	0	125	22.10	



		16QAM	1	0	1	49	2	15.19
			1	74	1	0	2	24.26
			75	0	50	0	125	21.00
			1	0	1	49	2	15.32
		64QAM	1	74	1	0	2	23.41
			75	0	50	0	125	20.97
			1	0	1	49	2	15.15
			1	74	1	0	2	21.04
41417	41537	QPSK	75	0	50	0	125	22.18
			1	0	1	49	2	15.30
			1	74	1	0	2	24.29
		16QAM	75	0	50	0	125	21.08
			1	0	1	49	2	15.36
			1	74	1	0	2	23.58
		64QAM	75	0	50	0	125	21.07
			1	0	1	49	2	15.17
			1	74	1	0	2	21.29
			Combination 10MHz+15MHz (50RB+75RB)					
PCC Channel	SCC Channel	Modulation	PCC		SCC		Total RB Size	Measured Power (dBm)
			RB Size	RB offset	RB Size	RB offset		
39703	39823	QPSK	50	0	75	0	125	22.01
			1	0	1	74	2	15.14
			1	49	1	0	2	24.21
		16QAM	50	0	75	0	125	20.98
			1	0	1	74	2	15.20
			1	49	1	0	2	23.36
		64QAM	50	0	75	0	125	20.91
			1	0	1	74	2	15.03
			1	49	1	0	2	21.02
40549	40669	QPSK	50	0	75	0	125	22.11
			1	0	1	74	2	15.25
			1	49	1	0	2	24.27
		16QAM	50	0	75	0	125	21.05
			1	0	1	74	2	15.33
			1	49	1	0	2	23.41
		64QAM	50	0	75	0	125	20.99
			1	0	1	74	2	15.14
			1	49	1	0	2	21.04
41395	41515	QPSK	50	0	75	0	125	22.25
			1	0	1	74	2	15.38
			1	49	1	0	2	24.21
		16QAM	50	0	75	0	125	21.12
			1	0	1	74	2	15.35
			1	49	1	0	2	23.52
		64QAM	50	0	75	0	125	21.07



				1	0	1	74	2	15.20
				1	49	1	0	2	21.33
Combination 15MHz+15MHz (75RB+75RB)									
PCC Channel	SCC Channel	Modulation	PCC		SCC		Total RB Size	Measured Power (dBm)	
			RB Size	RB offset	RB Size	RB offset			
39725	39875	QPSK	75	0	75	0	150	22.02	
			1	0	1	74	2	15.13	
			1	74	1	0	2	24.27	
		16QAM	75	0	75	0	150	20.99	
			1	0	1	74	2	15.21	
			1	74	1	0	2	23.28	
		64QAM	75	0	75	0	150	20.91	
			1	0	1	74	2	14.99	
			1	74	1	0	2	20.94	
40545	40695	QPSK	75	0	75	0	150	22.04	
			1	0	1	74	2	15.23	
			1	74	1	0	2	24.30	
		16QAM	75	0	75	0	150	21.01	
			1	0	1	74	2	15.31	
			1	74	1	0	2	23.39	
		64QAM	75	0	75	0	150	21.01	
			1	0	1	74	2	15.06	
			1	74	1	0	2	21.01	
41365	41515	QPSK	75	0	75	0	150	22.24	
			1	0	1	74	2	15.40	
			1	74	1	0	2	24.26	
		16QAM	75	0	75	0	150	21.11	
			1	0	1	74	2	15.40	
			1	74	1	0	2	23.53	
		64QAM	75	0	75	0	150	21.10	
			1	0	1	74	2	15.13	
			1	74	1	0	2	21.24	



EIRP

LTE Band 7 (GT - LC = -0.05 dB) QPSK			
Bandwidth	5M		
Channel	20775	21100	21425
	(Low)	(Mid)	(High)
Frequency	2502.5	2535	2567.5
(MHz)			
Conducted Power (dBm)	23.28	23.30	23.33
Conducted Power (Watts)	0.2128	0.2138	0.2153
EIRP(dBm)	23.23	23.25	23.28
EIRP(Watts)	0.2104	0.2113	0.2128

LTE Band 7 (GT - LC = -0.05 dB) QPSK									
Bandwidth	10M			15M			20M		
Channel	20800	21100	21400	20825	21100	21375	20850	21100	21350
	(Low)	(Mid)	(High)	(Low)	(Mid)	(High)	(Low)	(Mid)	(High)
Frequency	2505	2535	2565	2507.5	2535	2562.5	2510	2535	2560
(MHz)									
Conducted Power (dBm)	23.30	23.39	23.33	23.26	23.27	23.32	23.40	23.42	23.33
Conducted Power (Watts)	0.2138	0.2183	0.2153	0.2118	0.2123	0.2148	0.2188	0.2198	0.2153
EIRP(dBm)	23.25	23.34	23.28	23.21	23.22	23.27	23.35	23.37	23.28
EIRP(Watts)	0.2113	0.2158	0.2128	0.2094	0.2099	0.2123	0.2163	0.2173	0.2128



LTE Band 7 (GT - LC = -0.05 dB) 16QAM			
Bandwidth	5M		
Channel	20775	21100	21425
	(Low)	(Mid)	(High)
Frequency (MHz)	2502.5	2535	2567.5
	Conducted Power (dBm)	22.29	22.41
Conducted Power (Watts)	0.1694	0.1742	0.1778
EIRP(dBm)	22.24	22.36	22.45
EIRP(Watts)	0.1675	0.1722	0.1758

LTE Band 7 (GT - LC = -0.05 dB) 16QAM									
Bandwidth	10M			15M			20M		
Channel	20800	21100	21400	20825	21100	21375	20850	21100	21350
	(Low)	(Mid)	(High)	(Low)	(Mid)	(High)	(Low)	(Mid)	(High)
Frequency (MHz)	2505	2535	2565	2507.5	2535	2562.5	2510	2535	2560
	Conducted Power (dBm)	22.58	22.31	22.31	22.42	22.51	22.42	22.65	22.40
Conducted Power (Watts)	0.1811	0.1702	0.1702	0.1746	0.1782	0.1746	0.1841	0.1738	0.1714
EIRP(dBm)	22.53	22.26	22.26	22.37	22.46	22.37	22.60	22.35	22.29
EIRP(Watts)	0.1791	0.1683	0.1683	0.1726	0.1762	0.1726	0.1820	0.1718	0.1694



LTE Band 7 (GT - LC = -0.05 dB) 64QAM			
Bandwidth	5M		
Channel	20775	21100	21425
	(Low)	(Mid)	(High)
Frequency	2502.5	2535	2567.5
(MHz)			
Conducted Power (dBm)	21.47	21.36	21.35
Conducted Power (Watts)	0.1403	0.1368	0.1365
EIRP(dBm)	21.42	21.31	21.30
EIRP(Watts)	0.1387	0.1352	0.1349

LTE Band 7 (GT - LC = -0.05 dB) 64QAM									
Bandwidth	10M			15M			20M		
Channel	20800	21100	21400	20825	21100	21375	20850	21100	21350
	(Low)	(Mid)	(High)	(Low)	(Mid)	(High)	(Low)	(Mid)	(High)
Frequency	2505	2535	2565	2507.5	2535	2562.5	2510	2535	2560
(MHz)									
Conducted Power (dBm)	21.55	21.09	21.22	21.55	21.23	21.25	21.60	21.50	21.46
Conducted Power (Watts)	0.1429	0.1285	0.1324	0.1429	0.1327	0.1334	0.1445	0.1413	0.1400
EIRP(dBm)	21.50	21.04	21.17	21.50	21.18	21.20	21.55	21.45	21.41
EIRP(Watts)	0.1413	0.1271	0.1309	0.1413	0.1312	0.1318	0.1429	0.1396	0.1384



LTE Band 41 (G _T - L _C = -0.05 dB) QPSK									
Bandwidth	5M			10M			15M		
Channel	39675	40620	41565	39700	40620	41540	39725	40620	41515
	(Low)	(Mid)	(High)	(Low)	(Mid)	(High)	(Low)	(Mid)	(High)
Frequency (MHz)	2498.5	2593	2687.5	2501	2593	2685	2503.5	2593	2682.5
Conducted Power (dBm)	24.22	24.21	24.17	24.16	24.31	24.29	24.24	24.30	24.20
Conducted Power (Watts)	0.2642	0.2636	0.2612	0.2606	0.2698	0.2685	0.2655	0.2692	0.2630
EIRP(dBm)	24.17	24.16	24.12	24.11	24.26	24.24	24.19	24.25	24.15
EIRP(Watts)	0.2612	0.2606	0.2582	0.2576	0.2667	0.2655	0.2624	0.2661	0.2600

LTE Band 41 (G _T - L _C = -0.05 dB) QPSK			
Bandwidth	20M		
Channel	39750	40620	41490
	(Low)	(Mid)	(High)
Frequency (MHz)	2506	2593	2680
Conducted Power (dBm)	24.23	24.36	24.25
Conducted Power (Watts)	0.2649	0.2729	0.2661
EIRP(dBm)	24.18	24.31	24.20
EIRP(Watts)	0.2618	0.2698	0.2630



LTE Band 41 (G _T - L _C = -0.05 dB) 16QAM									
Bandwidth	5M			10M			15M		
Channel	39675	40620	41565	39700	40620	41540	39725	40620	41515
	(Low)	(Mid)	(High)	(Low)	(Mid)	(High)	(Low)	(Mid)	(High)
Frequency	2498.5	2593	2687.5	2501	2593	2685	2503.5	2593	2682.5
(MHz)									
Conducted Power (dBm)	23.26	23.28	23.29	23.37	23.39	23.38	23.35	23.39	23.34
Conducted Power (Watts)	0.2118	0.2128	0.2133	0.2173	0.2183	0.2178	0.2163	0.2183	0.2158
EIRP(dBm)	23.21	23.23	23.24	23.32	23.34	23.33	23.30	23.34	23.29
EIRP(Watts)	0.2094	0.2104	0.2109	0.2148	0.2158	0.2153	0.2138	0.2158	0.2133

LTE Band 41 (G _T - L _C = -0.05 dB) 16QAM			
Bandwidth	20M		
Channel	39750	40620	41490
	(Low)	(Mid)	(High)
Frequency	2506	2593	2680
(MHz)			
Conducted Power (dBm)	23.36	23.46	23.40
Conducted Power (Watts)	0.2168	0.2218	0.2188
EIRP(dBm)	23.31	23.41	23.35
EIRP(Watts)	0.2143	0.2193	0.2163



LTE Band 41 (G _T - L _C = -0.05 dB) 64QAM									
Bandwidth	5M			10M			15M		
Channel	39675	40620	41565	39700	40620	41540	39725	40620	41515
	(Low)	(Mid)	(High)	(Low)	(Mid)	(High)	(Low)	(Mid)	(High)
Frequency (MHz)	2498.5	2593	2687.5	2501	2593	2685	2503.5	2593	2682.5
Conducted Power (dBm)	22.32	22.30	22.28	22.29	22.29	22.30	22.36	22.34	22.27
Conducted Power (Watts)	0.1706	0.1698	0.1690	0.1694	0.1694	0.1698	0.1722	0.1714	0.1687
EIRP(dBm)	22.27	22.25	22.23	22.24	22.24	22.25	22.31	22.29	22.22
EIRP(Watts)	0.1687	0.1679	0.1671	0.1675	0.1675	0.1679	0.1702	0.1694	0.1667

LTE Band 41 (G _T - L _C = -0.05 dB) 64QAM			
Bandwidth	20M		
Channel	39750	40620	41490
	(Low)	(Mid)	(High)
Frequency (MHz)	2506	2593	2680
Conducted Power (dBm)	22.42	22.42	22.36
Conducted Power (Watts)	0.1746	0.1746	0.1722
EIRP(dBm)	22.37	22.37	22.31
EIRP(Watts)	0.1726	0.1726	0.1702



CA EIRP

LTE Band 7 CA (GT - LC = -0.05 dB) QPSK									
Bandwidth	15M + 15M			10M + 20M			20M+10M		
Channel PCC	20825	21025	21225	20805	21006	21206	20850	21051	21251
	(Low)	(Mid)	(High)	(Low)	(Mid)	(High)	(Low)	(Mid)	(High)
Channel SCC	20975	21175	21375	20949	21150	21350	20994	21195	21395
	(Low)	(Mid)	(High)	(Low)	(Mid)	(High)	(Low)	(Mid)	(High)
Conducted Power (dBm)	23.29	23.28	23.32	23.23	23.33	23.28	23.28	23.37	23.34
Conducted Power (Watts)	0.2133	0.2128	0.2148	0.2104	0.2153	0.2128	0.2128	0.2173	0.2158
EIRP(dBm)	23.24	23.23	23.27	23.18	23.28	23.23	23.23	23.32	23.29
EIRP(Watts)	0.2109	0.2104	0.2123	0.2080	0.2128	0.2104	0.2104	0.2148	0.2133

LTE Band 7 CA (GT - LC = -0.05 dB) QPSK									
Bandwidth	15M+20M			20M+15M			20M + 20M		
Channel PCC	20828	21003	21179	20850	21026	21201	20850	21001	21152
	(Low)	(Mid)	(High)	(Low)	(Mid)	(High)	(Low)	(Mid)	(High)
Channel SCC	20999	21174	21350	21021	21197	21372	21048	21199	21350
	(Low)	(Mid)	(High)	(Low)	(Mid)	(High)	(Low)	(Mid)	(High)
Conducted Power (dBm)	23.30	23.29	23.29	23.24	23.39	23.32	23.35	23.40	23.37
Conducted Power (Watts)	0.2138	0.2133	0.2133	0.2109	0.2183	0.2148	0.2163	0.2188	0.2173
EIRP(dBm)	23.25	23.24	23.24	23.19	23.34	23.27	23.30	23.35	23.32
EIRP(Watts)	0.2113	0.2109	0.2109	0.2084	0.2158	0.2123	0.2138	0.2163	0.2148



LTE Band 7 CA (GT - LC = -0.05 dB) QPSK			
Bandwidth	15M + 10M		
Channel PCC	20825	21025	21225
	(Low)	(Mid)	(High)
Channel SCC	20975	21175	21375
	(Low)	(Mid)	(High)
Conducted Power (dBm)	23.30	23.31	23.33
Conducted Power (Watts)	0.2138	0.2143	0.2153
EIRP(dBm)	23.25	23.26	23.28
EIRP(Watts)	0.2113	0.2118	0.2128

LTE Band 7 CA (GT - LC = -0.05 dB) 16QAM									
Bandwidth	15M + 15M			10M + 20M			20M+10M		
Channel PCC	20825	21025	21225	20805	21006	21206	20850	21051	21251
	(Low)	(Mid)	(High)	(Low)	(Mid)	(High)	(Low)	(Mid)	(High)
Channel SCC	20975	21175	21375	20949	21150	21350	20994	21195	21395
	(Low)	(Mid)	(High)	(Low)	(Mid)	(High)	(Low)	(Mid)	(High)
Conducted Power (dBm)	22.57	22.68	22.64	22.64	22.63	22.65	22.61	22.62	22.66
Conducted Power (Watts)	0.1807	0.1854	0.1837	0.1837	0.1832	0.1841	0.1824	0.1828	0.1845
EIRP(dBm)	22.52	22.63	22.59	22.59	22.58	22.60	22.56	22.57	22.61
EIRP(Watts)	0.1786	0.1832	0.1816	0.1816	0.1811	0.1820	0.1803	0.1807	0.1824



LTE Band 7 CA (GT - LC = -0.05 dB) 16QAM									
Bandwidth	15M+20M			20M+15M			20M + 20M		
Channel PCC	20828	21003	21179	20850	21026	21201	20850	21001	21152
	(Low)	(Mid)	(High)	(Low)	(Mid)	(High)	(Low)	(Mid)	(High)
Channel SCC	20999	21174	21350	21021	21197	21372	21048	21199	21350
	(Low)	(Mid)	(High)	(Low)	(Mid)	(High)	(Low)	(Mid)	(High)
Conducted Power (dBm)	22.62	22.63	22.61	22.63	22.63	22.65	22.68	22.74	22.73
Conducted Power (Watts)	0.1828	0.1832	0.1824	0.1832	0.1832	0.1841	0.1854	0.1879	0.1875
EIRP(dBm)	22.57	22.58	22.56	22.58	22.58	22.60	22.63	22.69	22.68
EIRP(Watts)	0.1807	0.1811	0.1803	0.1811	0.1811	0.1820	0.1832	0.1858	0.1854

LTE Band 7 CA (GT - LC = -0.05 dB) 16QAM			
Bandwidth	15M + 10M		
Channel PCC	20825	21025	21225
	(Low)	(Mid)	(High)
Channel SCC	20975	21175	21375
	(Low)	(Mid)	(High)
Conducted Power (dBm)	22.66	22.67	22.63
Conducted Power (Watts)	0.1845	0.1849	0.1832
EIRP(dBm)	22.61	22.62	22.58
EIRP(Watts)	0.1824	0.1828	0.1811



LTE Band 7 CA (GT - LC = -0.05 dB) 64QAM									
Bandwidth	15M + 15M			10M + 20M			20M+10M		
Channel PCC	20825	21025	21225	20805	21006	21206	20850	21051	21251
	(Low)	(Mid)	(High)	(Low)	(Mid)	(High)	(Low)	(Mid)	(High)
Channel SCC	20975	21175	21375	20949	21150	21350	20994	21195	21395
	(Low)	(Mid)	(High)	(Low)	(Mid)	(High)	(Low)	(Mid)	(High)
Conducted Power (dBm)	20.51	20.60	20.54	20.50	20.57	20.59	20.52	20.61	20.58
Conducted Power (Watts)	0.1125	0.1148	0.1132	0.1122	0.1140	0.1146	0.1127	0.1151	0.1143
EIRP(dBm)	20.46	20.55	20.49	20.45	20.52	20.54	20.47	20.56	20.53
EIRP(Watts)	0.1112	0.1135	0.1119	0.1109	0.1127	0.1132	0.1114	0.1138	0.1130

LTE Band 7 CA (GT - LC = -0.05 dB) 64QAM									
Bandwidth	15M+20M			20M+15M			20M + 20M		
Channel PCC	20828	21003	21179	20850	21026	21201	20850	21001	21152
	(Low)	(Mid)	(High)	(Low)	(Mid)	(High)	(Low)	(Mid)	(High)
Channel SCC	20999	21174	21350	21021	21197	21372	21048	21199	21350
	(Low)	(Mid)	(High)	(Low)	(Mid)	(High)	(Low)	(Mid)	(High)
Conducted Power (dBm)	20.47	20.61	20.58	20.46	20.58	20.53	20.58	20.65	20.61
Conducted Power (Watts)	0.1114	0.1151	0.1143	0.1112	0.1143	0.1130	0.1143	0.1161	0.1151
EIRP(dBm)	20.42	20.56	20.53	20.41	20.53	20.48	20.53	20.60	20.56
EIRP(Watts)	0.1102	0.1138	0.1130	0.1099	0.1130	0.1117	0.1130	0.1148	0.1138



LTE Band 7 CA (GT - LC = -0.05 dB) 64QAM			
Bandwidth	15M + 10M		
Channel PCC	20825	21025	21225
	(Low)	(Mid)	(High)
Channel SCC	20975	21175	21375
	(Low)	(Mid)	(High)
Conducted Power (dBm)	20.49	20.59	20.58
Conducted Power (Watts)	0.1119	0.1146	0.1143
EIRP(dBm)	20.44	20.54	20.53
EIRP(Watts)	0.1107	0.1132	0.1130



LTE Band 41 CA (GT - LC = -0.05 dB) QPSK									
Bandwidth	15M + 15M			5M + 20M			20M + 5M		
Channel PCC	39725	40545	41365	39683	40528	41373	39750	40595	41440
	(Low)	(Mid)	(High)	(Low)	(Mid)	(High)	(Low)	(Mid)	(High)
Channel SCC	39875	40695	41515	39800	40645	41490	39867	40712	41557
	(Low)	(Mid)	(High)	(Low)	(Mid)	(High)	(Low)	(Mid)	(High)
Conducted Power (dBm)	24.27	24.30	24.26	24.24	24.29	24.21	24.29	24.23	24.25
Conducted Power (Watts)	0.2673	0.2692	0.2667	0.2655	0.2685	0.2636	0.2685	0.2649	0.2661
EIRP(dBm)	24.22	24.25	24.21	24.19	24.24	24.16	24.24	24.18	24.20
EIRP(Watts)	0.2642	0.2661	0.2636	0.2624	0.2655	0.2606	0.2655	0.2618	0.2630

LTE Band 41 CA (GT - LC = -0.05 dB) QPSK									
Bandwidth	10M + 20M			20M + 10M			15M + 20M		
Channel PCC	39705	40526	41346	39750	40571	41391	39728	40523	41319
	(Low)	(Mid)	(High)	(Low)	(Mid)	(High)	(Low)	(Mid)	(High)
Channel SCC	39849	40670	41490	39894	40715	41535	39899	40694	41490
	(Low)	(Mid)	(High)	(Low)	(Mid)	(High)	(Low)	(Mid)	(High)
Conducted Power (dBm)	24.22	24.26	24.22	24.22	24.31	24.21	24.23	24.32	24.28
Conducted Power (Watts)	0.2642	0.2667	0.2642	0.2642	0.2698	0.2636	0.2649	0.2704	0.2679
EIRP(dBm)	24.17	24.21	24.17	24.17	24.26	24.16	24.18	24.27	24.23
EIRP(Watts)	0.2612	0.2636	0.2612	0.2612	0.2667	0.2606	0.2618	0.2673	0.2649



LTE Band 41 CA (GT - LC = -0.05 dB) QPSK						
Bandwidth	20M+15M			20M+20M		
Channel PCC	39750	40546	41341	39750	40521	41292
	(Low)	(Mid)	(High)	(Low)	(Mid)	(High)
Channel SCC	39921	40717	41512	39948	40719	41490
	(Low)	(Mid)	(High)	(Low)	(Mid)	(High)
Conducted Power (dBm)	24.21	24.33	24.30	24.32	24.35	24.33
Conducted Power (Watts)	0.2636	0.2710	0.2692	0.2704	0.2723	0.2710
EIRP(dBm)	24.16	24.28	24.25	24.27	24.30	24.28
EIRP(Watts)	0.2606	0.2679	0.2661	0.2673	0.2692	0.2679

LTE Band 41 CA (GT - LC = -0.05 dB) QPSK						
Bandwidth	15M+10M			10M+15M		
Channel PCC	39725	40571	41417	39703	40549	41395
	(Low)	(Mid)	(High)	(Low)	(Mid)	(High)
Channel SCC	39845	40691	41537	39823	40669	41490
	(Low)	(Mid)	(High)	(Low)	(Mid)	(High)
Conducted Power (dBm)	24.30	24.26	24.29	24.21	24.27	24.21
Conducted Power (Watts)	0.2692	0.2667	0.2685	0.2636	0.2673	0.2636
EIRP(dBm)	24.25	24.21	24.24	24.16	24.22	24.16
EIRP(Watts)	0.2661	0.2636	0.2655	0.2606	0.2642	0.2606



LTE Band 41 CA (GT - LC = -0.05 dB) 16QAM									
Bandwidth	15M + 15M			5M + 20M			20M + 5M		
Channel PCC	39725	40545	41365	39683	40528	41373	39750	40595	41440
	(Low)	(Mid)	(High)	(Low)	(Mid)	(High)	(Low)	(Mid)	(High)
Channel SCC	39875	40695	41515	39800	40645	41490	39867	40712	41557
	(Low)	(Mid)	(High)	(Low)	(Mid)	(High)	(Low)	(Mid)	(High)
Conducted Power (dBm)	23.28	23.39	23.53	23.35	23.37	23.54	23.37	23.40	23.59
Conducted Power (Watts)	0.2128	0.2183	0.2254	0.2163	0.2173	0.2259	0.2173	0.2188	0.2286
EIRP(dBm)	23.23	23.34	23.48	23.30	23.32	23.49	23.32	23.35	23.54
EIRP(Watts)	0.2104	0.2158	0.2228	0.2138	0.2148	0.2234	0.2148	0.2163	0.2259

LTE Band 41 CA (GT - LC = -0.05 dB) 16QAM									
Bandwidth	10M + 20M			20M + 10M			15M + 20M		
Channel PCC	39705	40526	41346	39750	40571	41391	39728	40523	41319
	(Low)	(Mid)	(High)	(Low)	(Mid)	(High)	(Low)	(Mid)	(High)
Channel SCC	39849	40670	41490	39894	40715	41535	39899	40694	41490
	(Low)	(Mid)	(High)	(Low)	(Mid)	(High)	(Low)	(Mid)	(High)
Conducted Power (dBm)	23.29	23.35	23.62	23.35	23.44	23.62	23.36	23.44	23.59
Conducted Power (Watts)	0.2133	0.2163	0.2301	0.2163	0.2208	0.2301	0.2168	0.2208	0.2286
EIRP(dBm)	23.24	23.30	23.57	23.30	23.39	23.57	23.31	23.39	23.54
EIRP(Watts)	0.2109	0.2138	0.2275	0.2138	0.2183	0.2275	0.2143	0.2183	0.2259



LTE Band 41 CA (GT - LC = -0.05 dB) 16QAM						
Bandwidth	20M+15M			20M+20M		
Channel PCC	39750	40546	41341	39750	40521	41292
	(Low)	(Mid)	(High)	(Low)	(Mid)	(High)
Channel SCC	39921	40717	41512	39948	40719	41490
	(Low)	(Mid)	(High)	(Low)	(Mid)	(High)
Conducted Power (dBm)	23.34	23.42	23.61	23.39	23.47	23.64
Conducted Power (Watts)	0.2158	0.2198	0.2296	0.2183	0.2223	0.2312
EIRP(dBm)	23.29	23.37	23.56	23.34	23.42	23.59
EIRP(Watts)	0.2133	0.2173	0.2270	0.2158	0.2198	0.2286

LTE Band 41 CA (GT - LC = -0.05 dB) 16QAM						
Bandwidth	15M+10M			10M+15M		
Channel PCC	39725	40571	41417	39703	40549	41395
	(Low)	(Mid)	(High)	(Low)	(Mid)	(High)
Channel SCC	39845	40691	41537	39823	40669	41490
	(Low)	(Mid)	(High)	(Low)	(Mid)	(High)
Conducted Power (dBm)	23.27	23.41	23.58	23.36	23.41	23.52
Conducted Power (Watts)	0.2123	0.2193	0.2280	0.2168	0.2193	0.2249
EIRP(dBm)	23.22	23.36	23.53	23.31	23.36	23.47
EIRP(Watts)	0.2099	0.2168	0.2254	0.2143	0.2168	0.2223



LTE Band 41 CA (GT - LC = -0.05 dB) 64QAM									
Bandwidth	15M + 15M			5M + 20M			20M + 5M		
Channel PCC	39725	40545	41365	39683	40528	41373	39750	40595	41440
	(Low)	(Mid)	(High)	(Low)	(Mid)	(High)	(Low)	(Mid)	(High)
Channel SCC	39875	40695	41515	39800	40645	41490	39867	40712	41557
	(Low)	(Mid)	(High)	(Low)	(Mid)	(High)	(Low)	(Mid)	(High)
Conducted Power (dBm)	20.94	21.01	21.24	20.99	21.05	21.27	21.01	21.05	21.26
Conducted Power (Watts)	0.1242	0.1262	0.1330	0.1256	0.1274	0.1340	0.1262	0.1274	0.1337
EIRP(dBm)	20.89	20.96	21.19	20.94	21.00	21.22	20.96	21.00	21.21
EIRP(Watts)	0.1227	0.1247	0.1315	0.1242	0.1259	0.1324	0.1247	0.1259	0.1321

LTE Band 41 CA (GT - LC = -0.05 dB) 64QAM									
Bandwidth	10M + 20M			20M + 10M			15M + 20M		
Channel PCC	39705	40526	41346	39750	40571	41391	39728	40523	41319
	(Low)	(Mid)	(High)	(Low)	(Mid)	(High)	(Low)	(Mid)	(High)
Channel SCC	39849	40670	41490	39894	40715	41535	39899	40694	41490
	(Low)	(Mid)	(High)	(Low)	(Mid)	(High)	(Low)	(Mid)	(High)
Conducted Power (dBm)	20.96	21.07	21.25	20.97	21.09	21.26	20.96	21.05	21.24
Conducted Power (Watts)	0.1247	0.1279	0.1334	0.1250	0.1285	0.1337	0.1247	0.1274	0.1330
EIRP(dBm)	20.91	21.02	21.20	20.92	21.04	21.21	20.91	21.00	21.19
EIRP(Watts)	0.1233	0.1265	0.1318	0.1236	0.1271	0.1321	0.1233	0.1259	0.1315



LTE Band 41 CA (GT - LC = -0.05 dB) 64QAM						
Bandwidth	20M+15M			20M+20M		
Channel PCC	39750	40546	41341	39750	40521	41292
	(Low)	(Mid)	(High)	(Low)	(Mid)	(High)
Channel SCC	39921	40717	41512	39948	40719	41490
	(Low)	(Mid)	(High)	(Low)	(Mid)	(High)
Conducted Power (dBm)	20.95	21.05	21.33	21.05	21.11	21.36
Conducted Power (Watts)	0.1245	0.1274	0.1358	0.1274	0.1291	0.1368
EIRP(dBm)	20.90	21.00	21.28	21.00	21.06	21.31
EIRP(Watts)	0.1230	0.1259	0.1343	0.1259	0.1276	0.1352

LTE Band 41 CA (GT - LC = -0.05 dB) 64QAM						
Bandwidth	15M+10M			10M+15M		
Channel PCC	39725	40571	41417	39703	40549	41395
	(Low)	(Mid)	(High)	(Low)	(Mid)	(High)
Channel SCC	39845	40691	41537	39823	40669	41490
	(Low)	(Mid)	(High)	(Low)	(Mid)	(High)
Conducted Power (dBm)	20.96	21.04	21.29	21.02	21.04	21.33
Conducted Power (Watts)	0.1247	0.1271	0.1346	0.1265	0.1271	0.1358
EIRP(dBm)	20.91	20.99	21.24	20.97	20.99	21.28
EIRP(Watts)	0.1233	0.1256	0.1330	0.1250	0.1256	0.1343



LTE Band 7

Peak-to-Average Ratio

Mode	LTE Band 7 / 20MHz				
Mod.	QPSK		16QAM		Limit: 13dB
RB Size	1RB	Full RB	1RB	Full RB	Result
Lowest CH	4.78	5.13	5.83	5.97	PASS
Middle CH	4.55	5.25	5.74	6.29	
Highest CH	4.67	5.10	5.80	6.00	
Mode	LTE Band 7 / 20MHz				
Mod.	64QAM				Limit: 13dB
RB Size	1RB	Full RB			Result
Lowest CH	5.86	6.41	-	-	PASS
Middle CH	6.38	6.49	-	-	
Highest CH	6.61	6.46	-	-	



LTE Band 7 / 20MHz / QPSK

Lowest Channel / 1RB



Date: 16_JAN_2023 02:55:54

Lowest Channel / Full RB

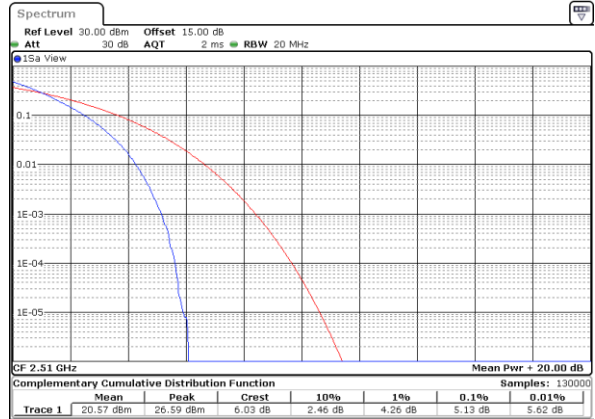

Date: 16_JAN_2023 02:56:120

Middle Channel / 1RB

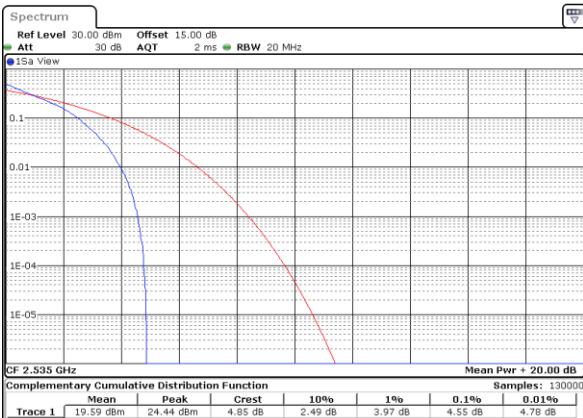

Date: 16_JAN_2023 02:56:45

Middle Channel / Full RB

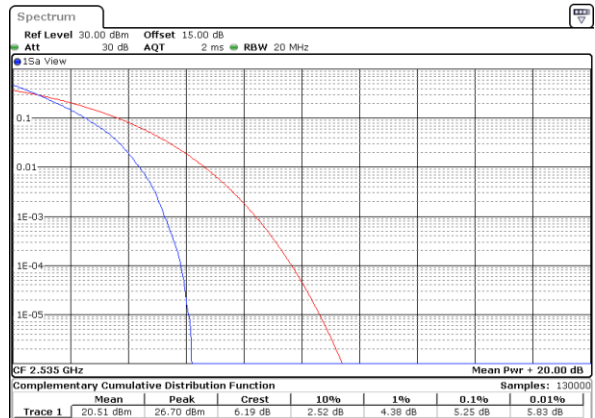

Date: 16_JAN_2023 02:57:111

Highest Channel / 1RB

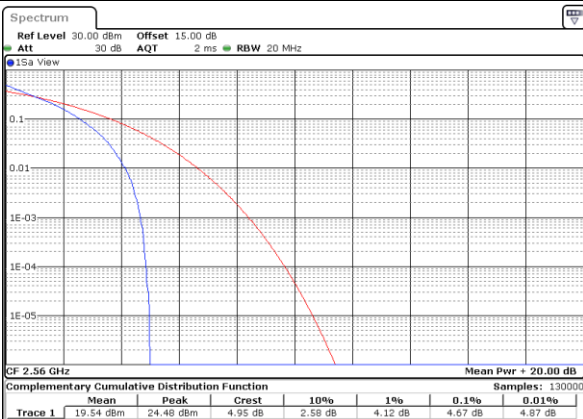

Date: 16_JAN_2023 02:57:36

Highest Channel / Full RB



Date: 16_JAN_2023 02:58:02



LTE Band 7 / 20MHz / 16QAM

Lowest Channel / 1RB

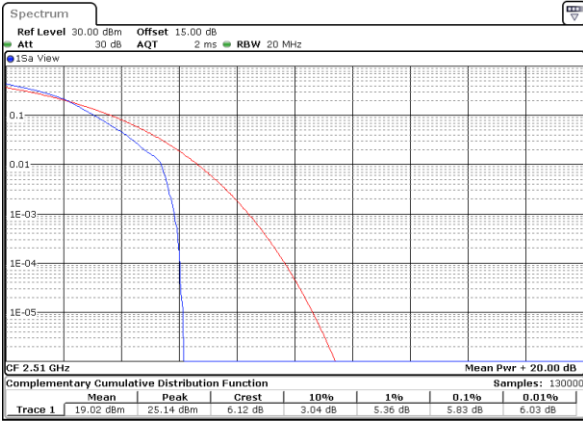

Date: 16_JAN.2023 02:53:20

Lowest Channel / Full RB

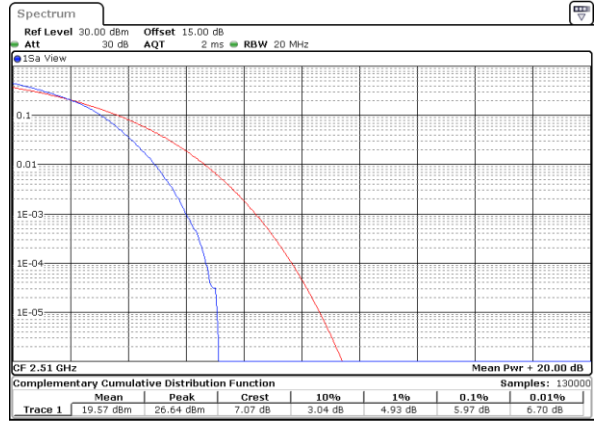

Date: 16_JAN.2023 02:53:46

Middle Channel / 1RB

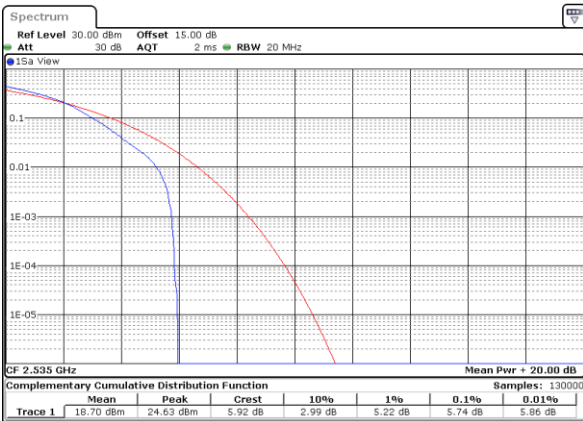

Date: 16_JAN.2023 02:54:12

Middle Channel / Full RB

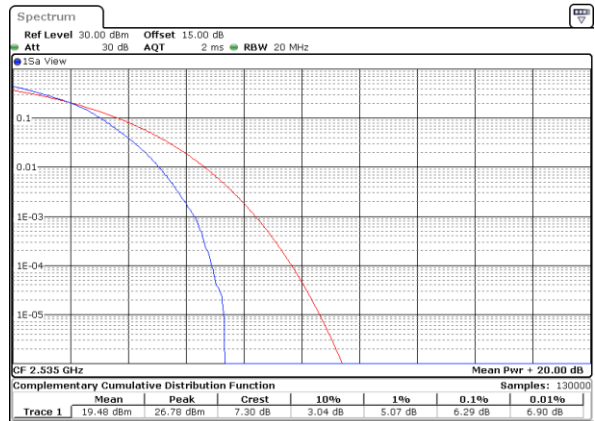

Date: 16_JAN.2023 02:54:37

Highest Channel / 1RB



Date: 16_JAN.2023 02:55:02

Highest Channel / Full RB



Date: 16_JAN.2023 02:55:28



LTE Band 7 / 20MHz / 64QAM

Lowest Channel / 1RB



Date: 18_JAN.2023 03:43:16

Lowest Channel / Full RB



Date: 18_JAN.2023 03:44:40

Middle Channel / 1RB



Date: 18_JAN.2023 03:47:16

Middle Channel / Full RB

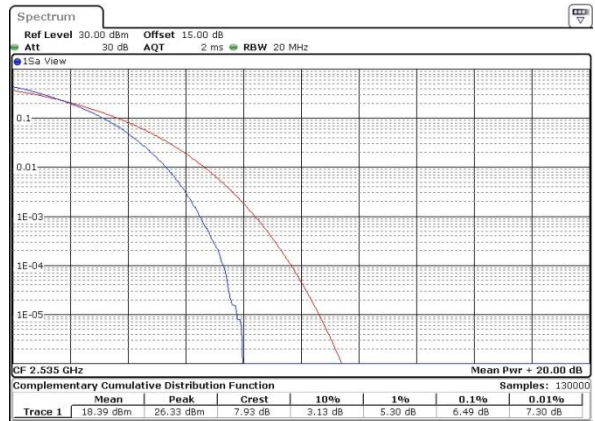

Date: 18_JAN.2023 03:45:44

Highest Channel / 1RB



Date: 18_JAN.2023 03:47:47

Highest Channel / Full RB



Date: 18_JAN.2023 03:49:03



26dB Bandwidth

Mode	LTE Band 7 : 26dB BW(MHz)											
BW	1.4MHz		3MHz		5MHz		10MHz		15MHz		20MHz	
Mod.	QPSK	16QAM	QPSK	16QAM	QPSK	16QAM	QPSK	16QAM	QPSK	16QAM	QPSK	16QAM
Lowest CH	-	-	-	-	4.89	4.91	9.79	9.73	14.24	14.15	18.94	19.02
Middle CH	-	-	-	-	4.77	4.81	9.81	9.81	14.21	14.48	19.02	19.10
Highest CH	-	-	-	-	4.85	4.85	9.65	9.83	14.30	14.45	18.90	19.18
Mode	LTE Band 7 : 26dB BW(MHz)											
BW	1.4MHz		3MHz		5MHz		10MHz		15MHz		20MHz	
Mod.	64QAM		64QAM		64QAM		64QAM		64QAM		64QAM	
Lowest CH	-	-	-	-	4.80	-	9.71	-	14.30	-	18.78	-
Middle CH	-	-	-	-	4.82	-	9.77	-	14.24	-	18.86	-
Highest CH	-	-	-	-	4.88	-	9.83	-	14.36	-	18.90	-



LTE Band 7

Lowest Channel / 5MHz / QPSK

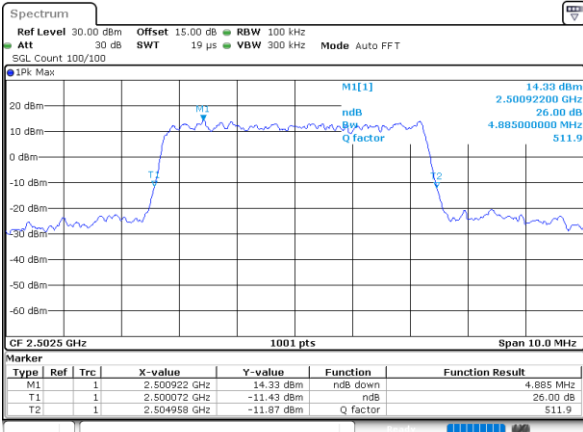

Date: 15_JAN_2023 23:49:44

Lowest Channel / 5MHz / 16QAM

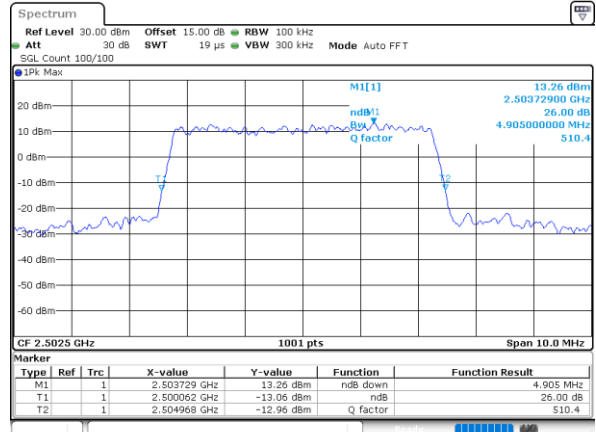

Date: 15_JAN_2023 23:50:06

Middle Channel / 5MHz / QPSK

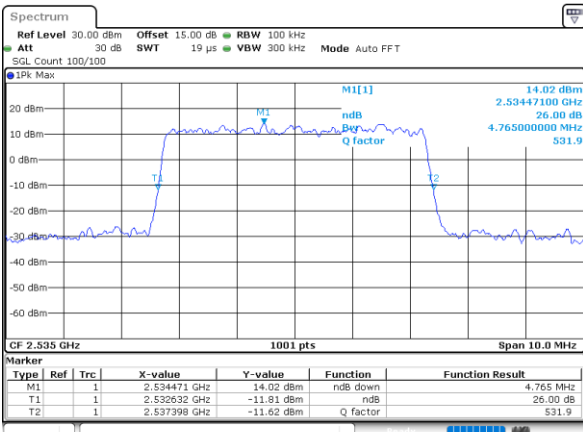

Date: 15_JAN_2023 23:57:12

Middle Channel / 5MHz / 16QAM

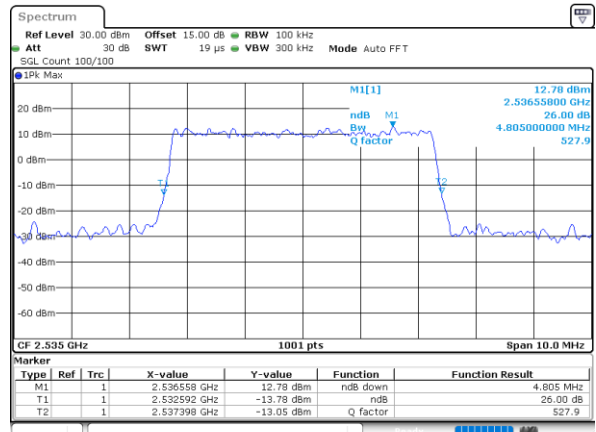

Date: 15_JAN_2023 23:57:33

Highest Channel / 5MHz / QPSK

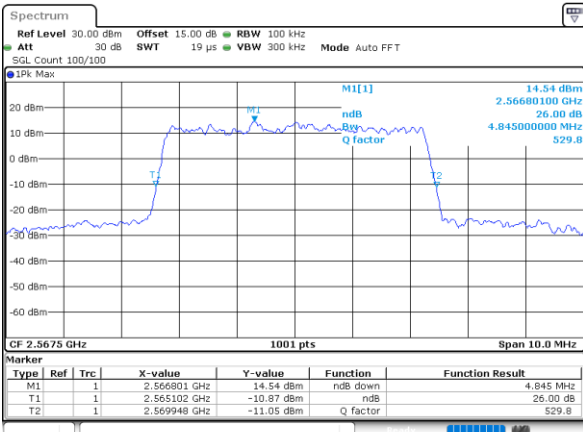

Date: 16_JAN_2023 00:01:18

Highest Channel / 5MHz / 16QAM

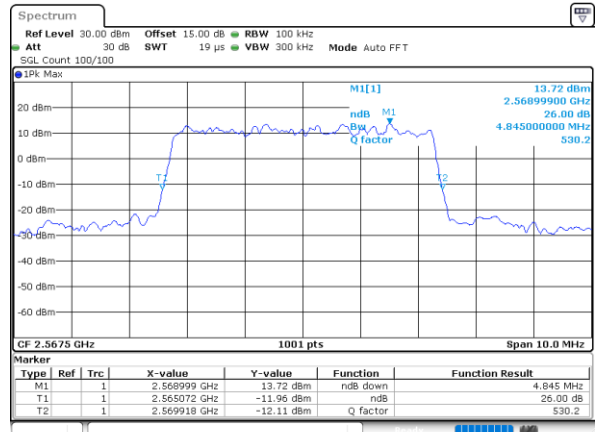

Date: 16_JAN_2023 00:01:40



LTE Band 7

Lowest Channel / 10MHz / QPSK

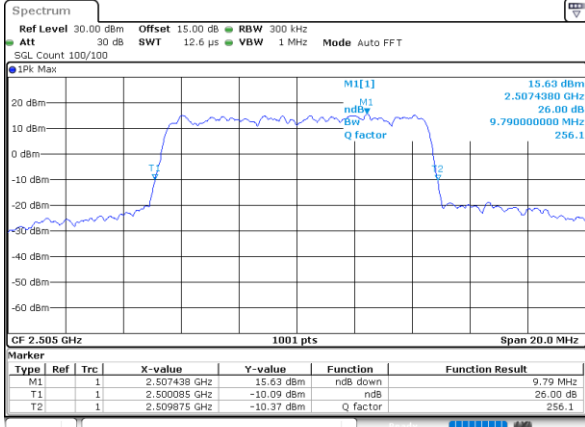

Date: 16_JAN_2023 00:08:48

Lowest Channel / 10MHz / 16QAM

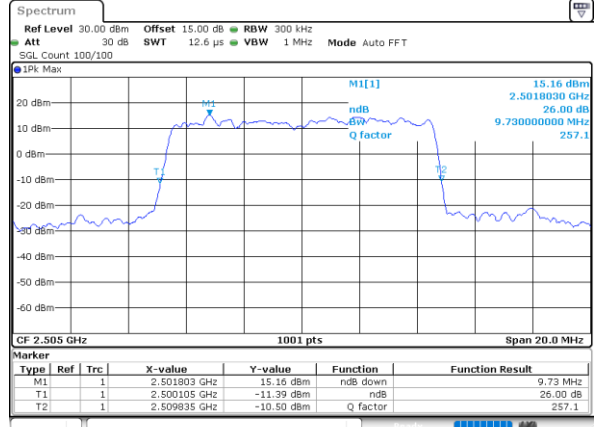

Date: 16_JAN_2023 00:10:10

Middle Channel / 10MHz / QPSK

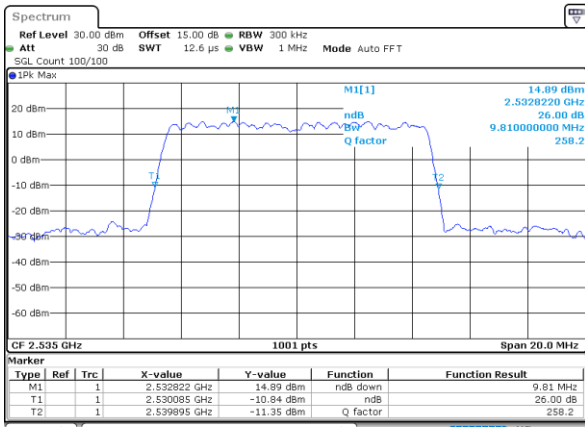

Date: 16_JAN_2023 00:16:16

Middle Channel / 10MHz / 16QAM

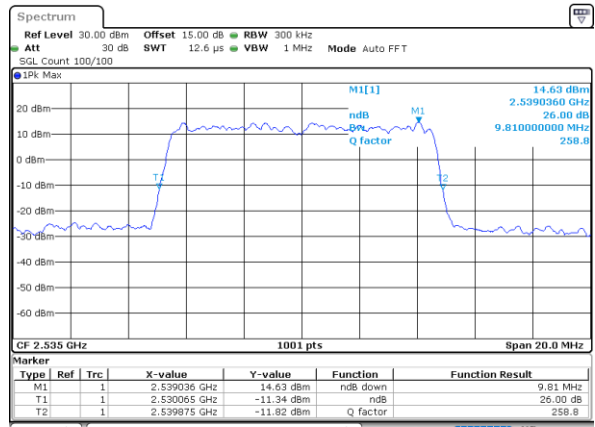

Date: 16_JAN_2023 00:16:17

Highest Channel / 10MHz / QPSK

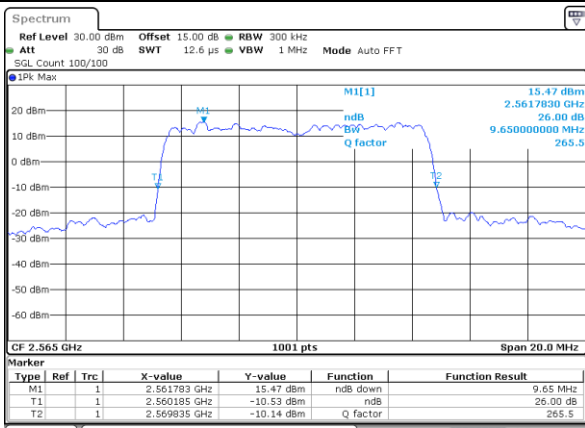

Date: 16_JAN_2023 00:20:21

Highest Channel / 10MHz / 16QAM

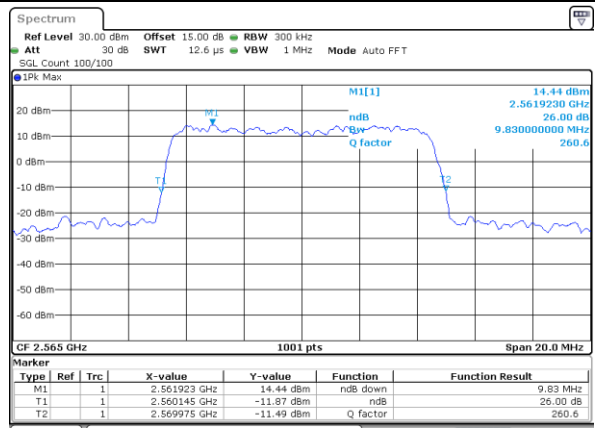

Date: 16_JAN_2023 00:20:43



LTE Band 7

Lowest Channel / 15MHz / QPSK

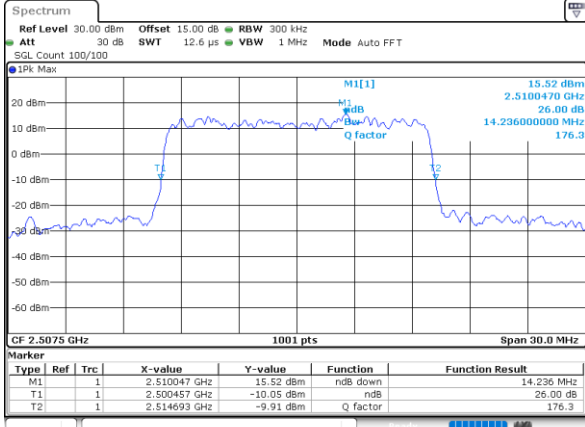

Date: 16_JAN.2023 01:03:07

Lowest Channel / 15MHz / 16QAM

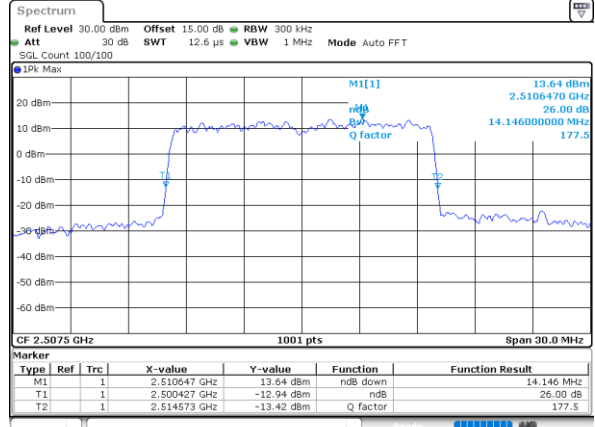

Date: 16_JAN.2023 01:03:29

Middle Channel / 15MHz / QPSK

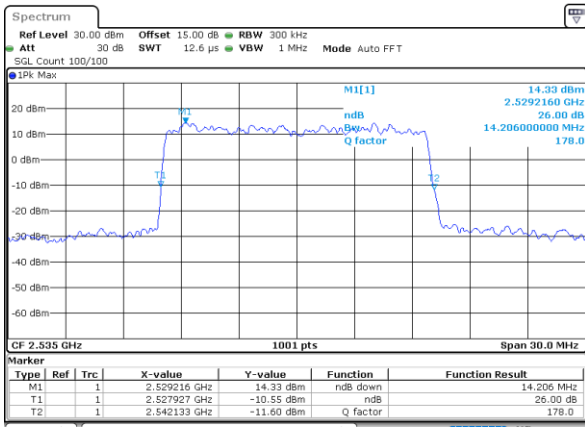

Date: 16_JAN.2023 01:10:36

Middle Channel / 15MHz / 16QAM

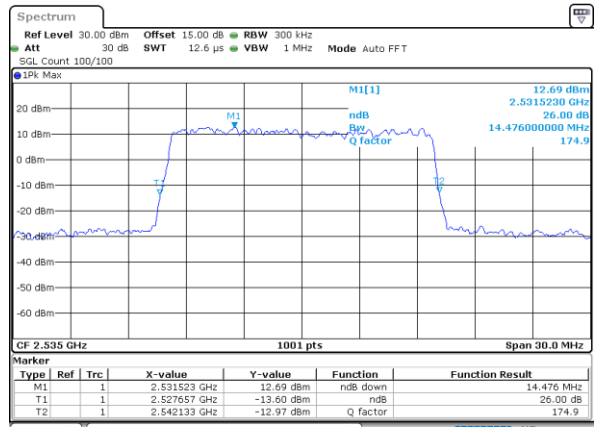

Date: 16_JAN.2023 01:10:57

Highest Channel / 15MHz / QPSK

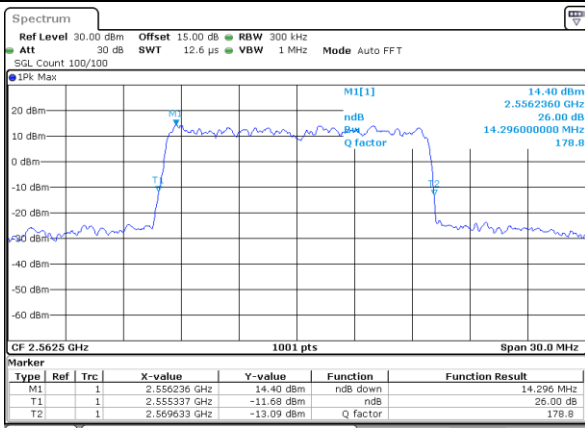

Date: 16_JAN.2023 01:14:41

Highest Channel / 15MHz / 16QAM

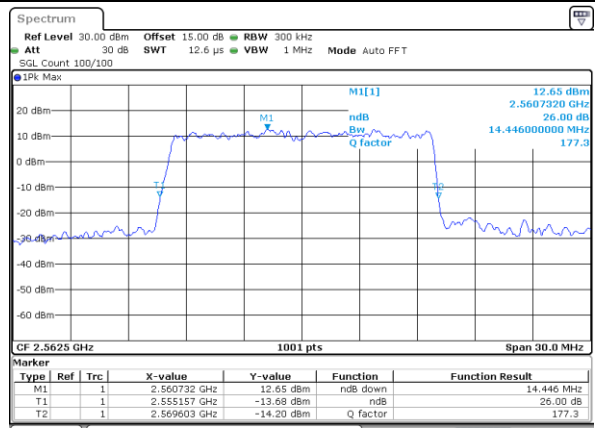

Date: 16_JAN.2023 01:15:03



LTE Band 7

Lowest Channel / 20MHz / QPSK

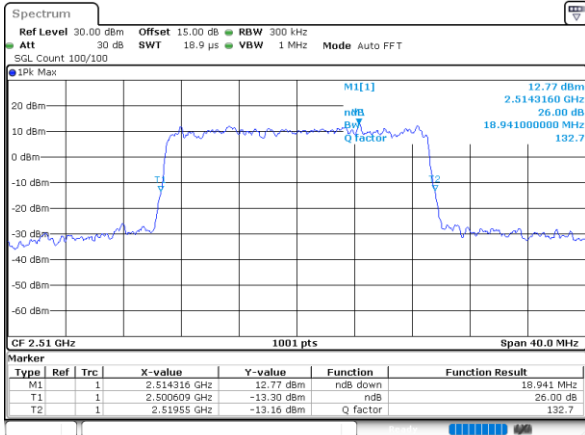

Date: 16_JAN_2023 02:13:16

Lowest Channel / 20MHz / 16QAM

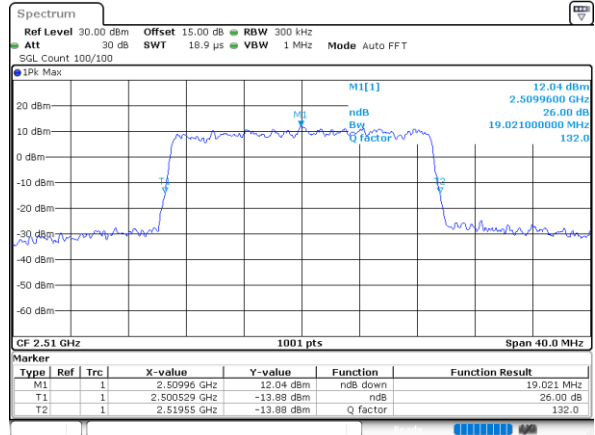

Date: 16_JAN_2023 02:13:120

Middle Channel / 20MHz / QPSK

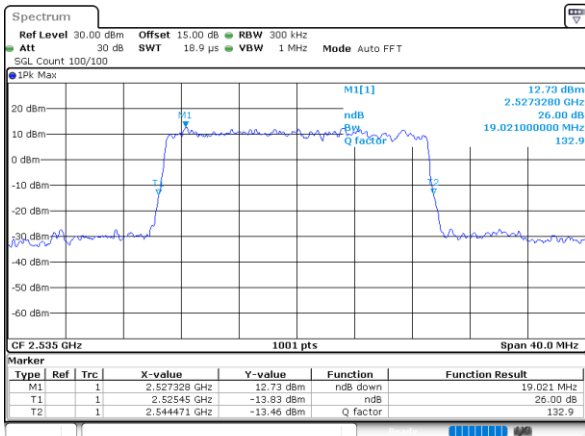

Date: 16_JAN_2023 02:14:19

Middle Channel / 20MHz / 16QAM

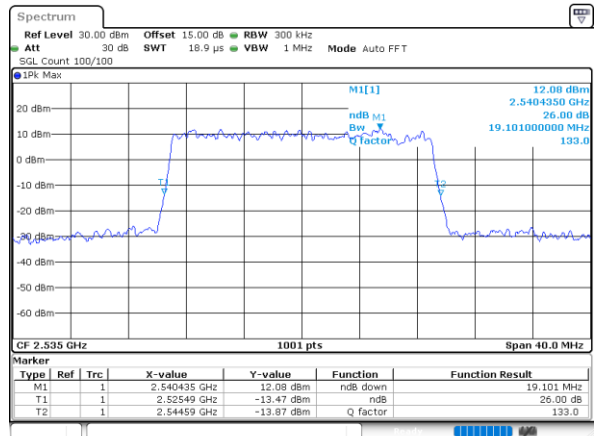

Date: 16_JAN_2023 02:14:213

Highest Channel / 20MHz / QPSK

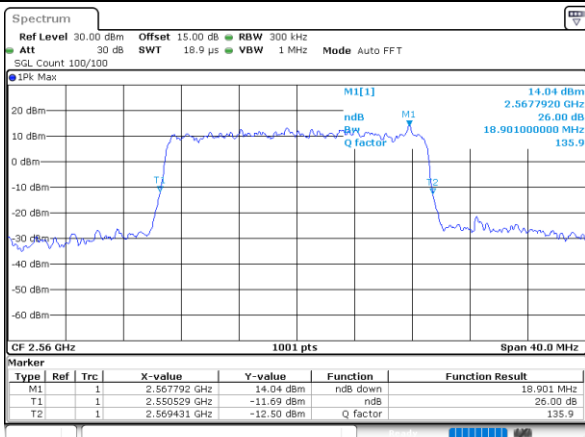

Date: 16_JAN_2023 02:14:113

Highest Channel / 20MHz / 16QAM

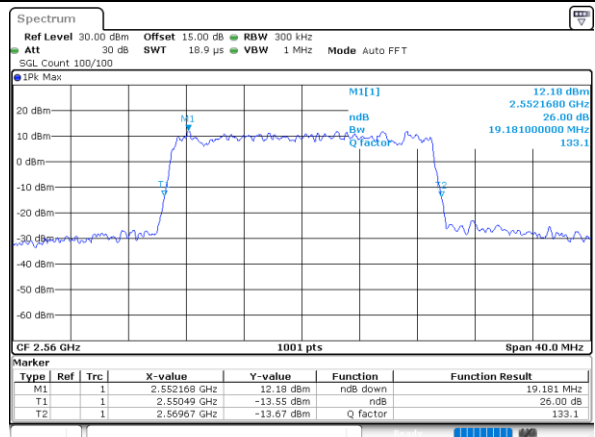

Date: 16_JAN_2023 02:14:138



LTE Band 7

Lowest Channel / 5MHz / 64QAM

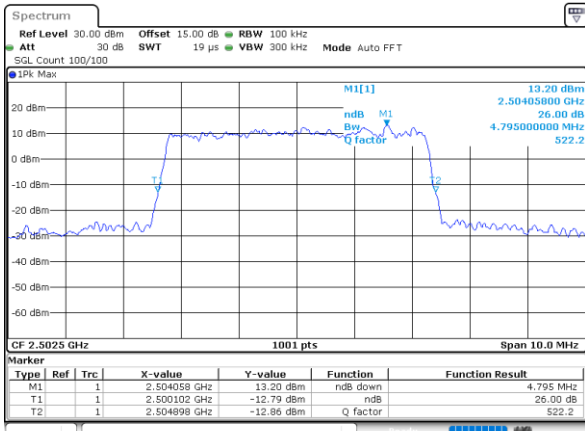

Date: 16_JAN_2023 04:14:52

Lowest Channel / 10MHz / 64QAM

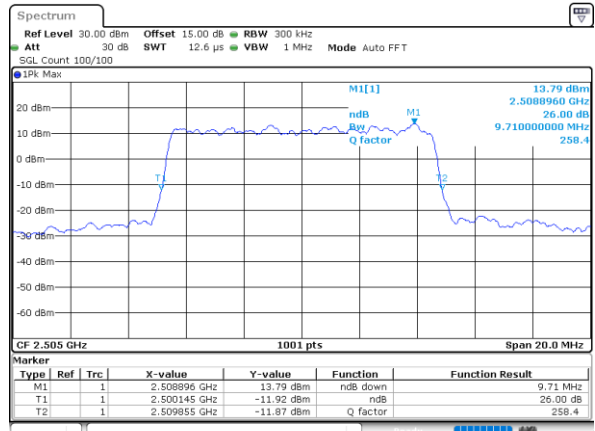

Date: 16_JAN_2023 04:16:51

Middle Channel / 5MHz / 64QAM

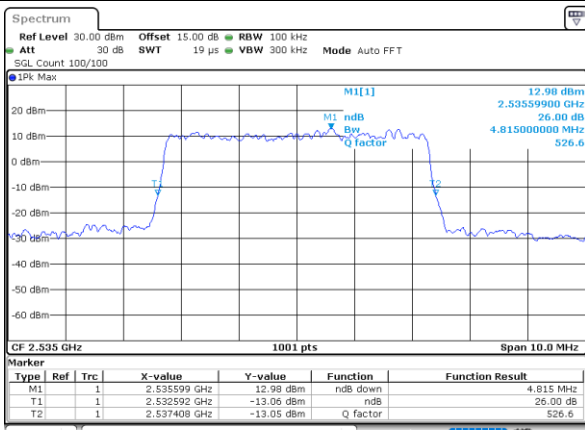

Date: 16_JAN_2023 04:15:31

Middle Channel / 10MHz / 64QAM

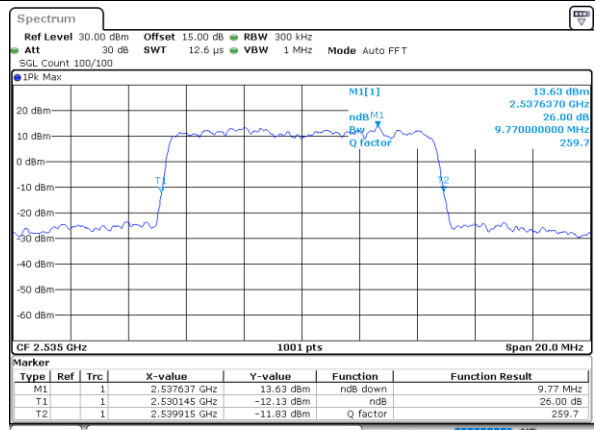

Date: 16_JAN_2023 04:17:29

Highest Channel / 5MHz / 64QAM

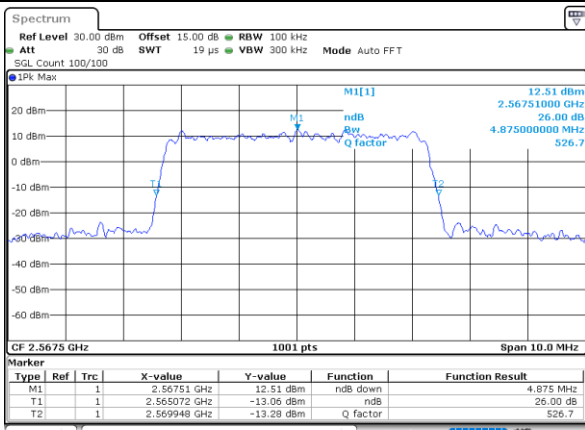

Date: 16_JAN_2023 04:16:10

Highest Channel / 10MHz / 64QAM

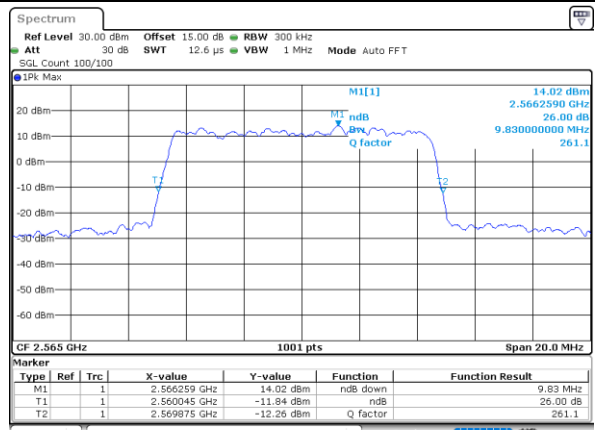

Date: 16_JAN_2023 04:18:08



LTE Band 7

Lowest Channel / 15MHz / 64QAM

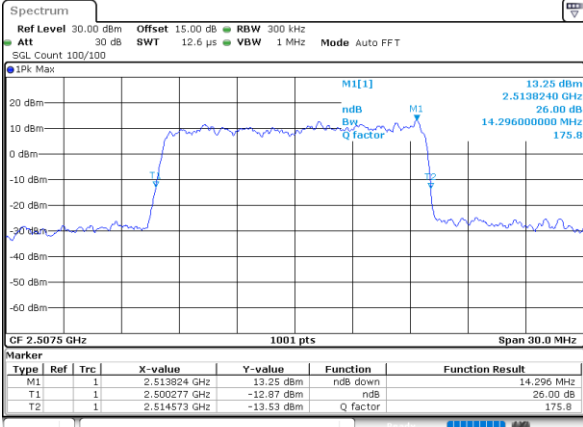

Date: 16_JAN_2023 04:18:49

Lowest Channel / 20MHz / 64QAM

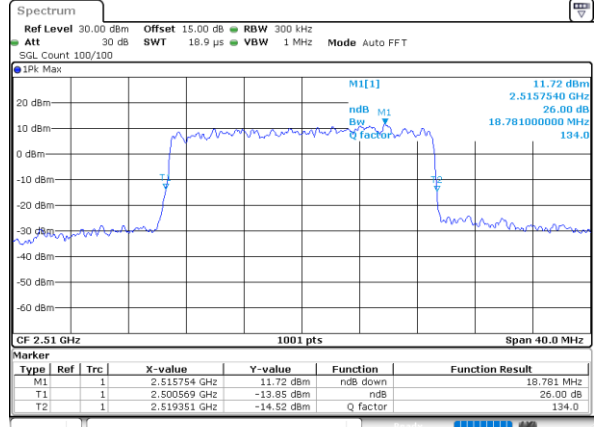

Date: 16_JAN_2023 04:20:48

Middle Channel / 15MHz / 64QAM

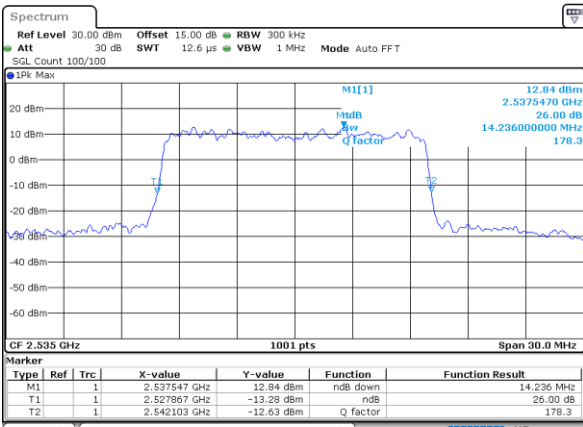

Date: 16_JAN_2023 04:19:28

Middle Channel / 20MHz / 64QAM

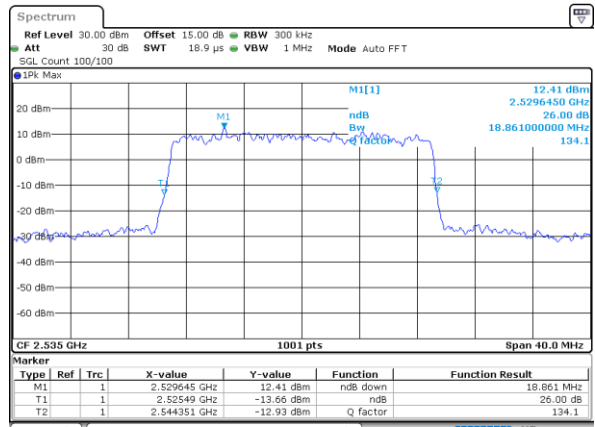

Date: 16_JAN_2023 04:21:27

Highest Channel / 15MHz / 64QAM

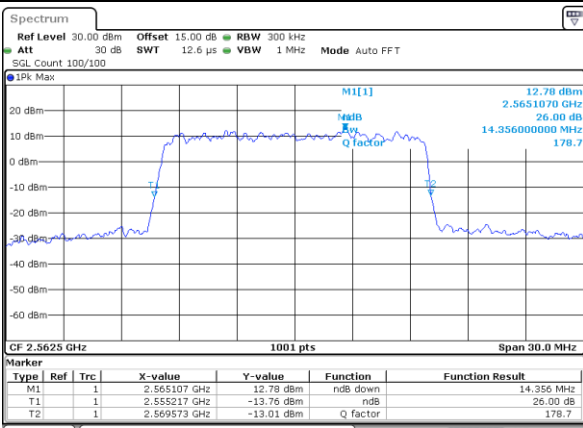

Date: 16_JAN_2023 04:20:07

Highest Channel / 20MHz / 64QAM

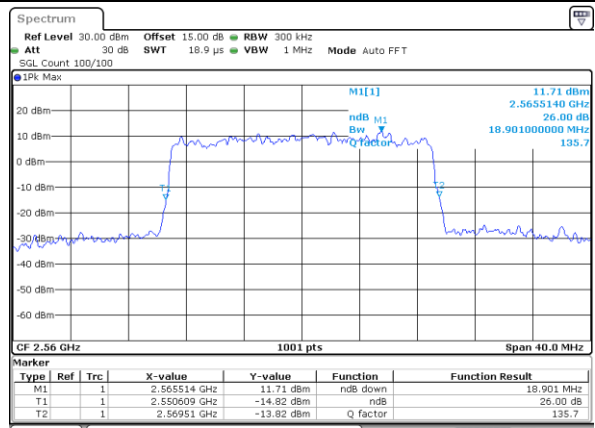

Date: 16_JAN_2023 04:22:06



Occupied Bandwidth

Mode	LTE Band 7 : 99%OBW(MHz)											
BW	1.4MHz		3MHz		5MHz		10MHz		15MHz		20MHz	
Mod.	QPSK	16QAM	QPSK	16QAM	QPSK	16QAM	QPSK	16QAM	QPSK	16QAM	QPSK	16QAM
Lowest CH	-	-	-	-	4.51	4.47	9.03	9.07	13.37	13.49	17.90	17.86
Middle CH	-	-	-	-	4.48	4.51	9.05	9.07	13.37	13.43	17.86	17.94
Highest CH	-	-	-	-	4.50	4.48	8.99	9.01	13.43	13.43	17.90	17.90
Mode	LTE Band 7 : 99%OBW(MHz)											
BW	1.4MHz		3MHz		5MHz		10MHz		15MHz		20MHz	
Mod.	64QAM		64QAM		64QAM		64QAM		64QAM		64QAM	
Lowest CH	-	-	-	-	4.50	-	9.07	-	13.49	-	17.82	-
Middle CH	-	-	-	-	4.49	-	9.01	-	13.43	-	17.90	-
Highest CH	-	-	-	-	4.50	-	9.05	-	13.43	-	17.86	-



LTE Band 7

Lowest Channel / 5MHz / QPSK

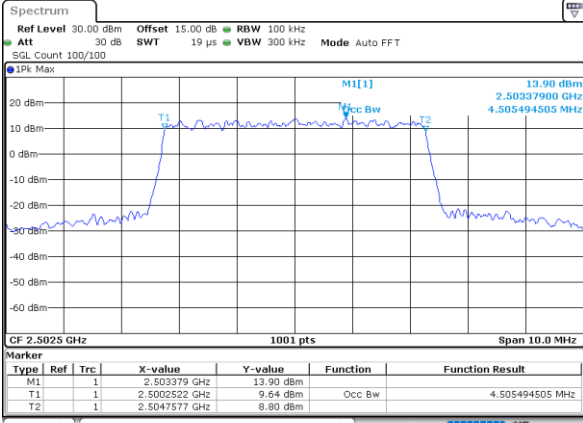

Date: 15_JAN,2023 23:49:00

Lowest Channel / 5MHz / 16QAM

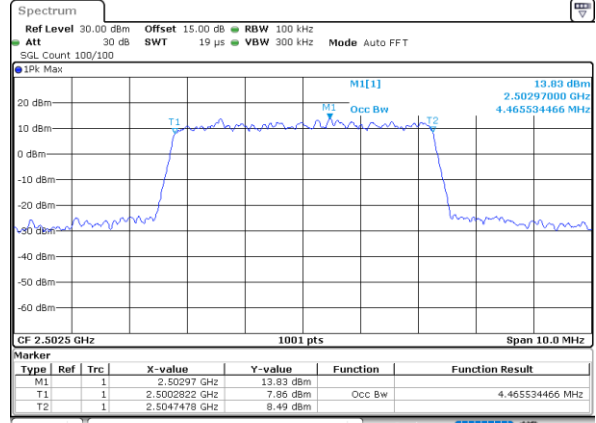

Date: 15_JAN,2023 23:49:22

Middle Channel / 5MHz / QPSK

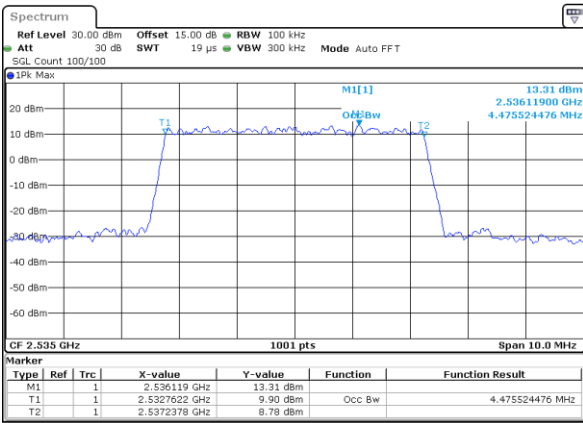

Date: 15_JAN,2023 23:56:30

Middle Channel / 5MHz / 16QAM

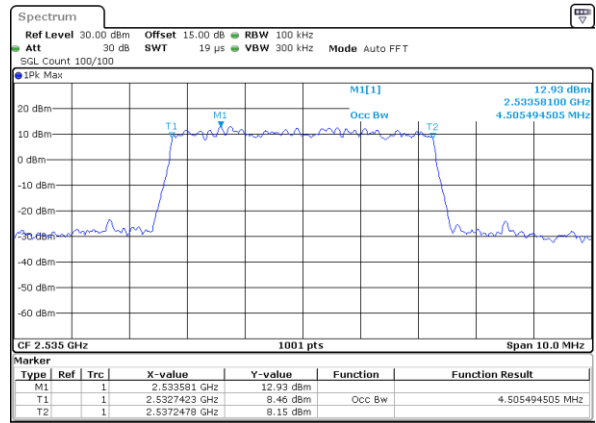

Date: 15_JAN,2023 23:56:51

Highest Channel / 5MHz / QPSK

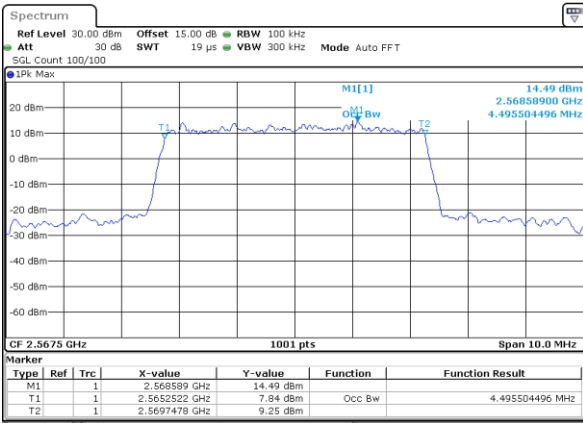

Date: 16_JAN,2023 00:01:34

Highest Channel / 5MHz / 16QAM

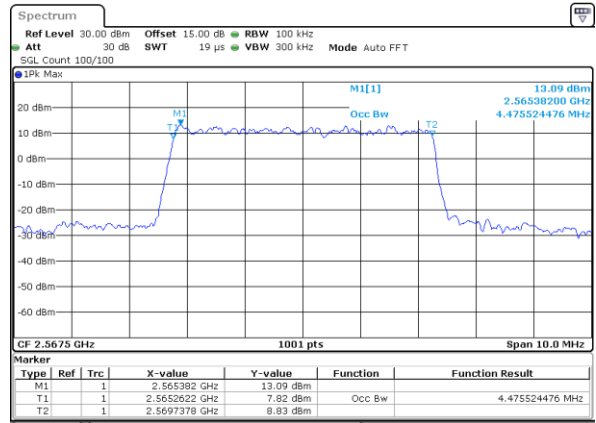

Date: 16_JAN,2023 00:01:56



LTE Band 7

Lowest Channel / 10MHz / QPSK

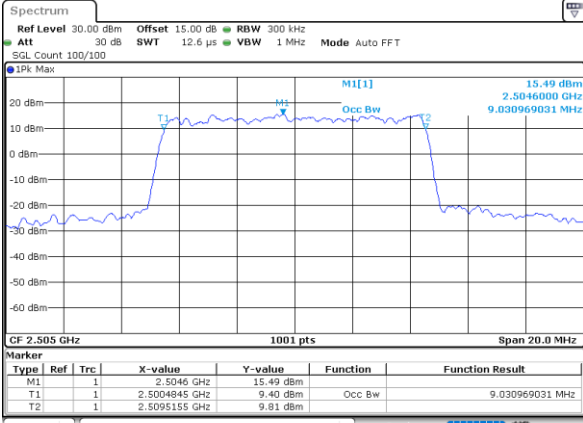

Date: 16_JAN_2023 00:08:05

Lowest Channel / 10MHz / 16QAM

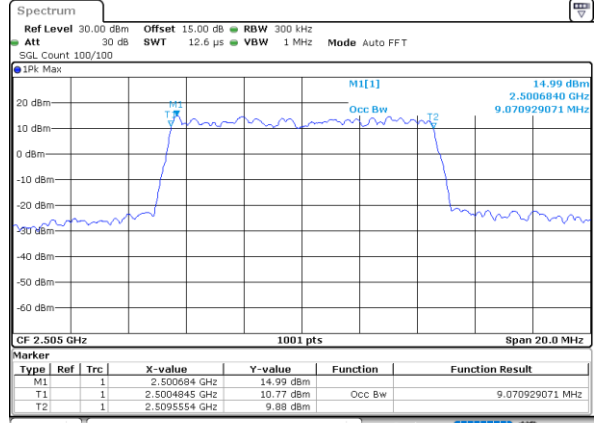

Date: 16_JAN_2023 00:08:27

Middle Channel / 10MHz / QPSK

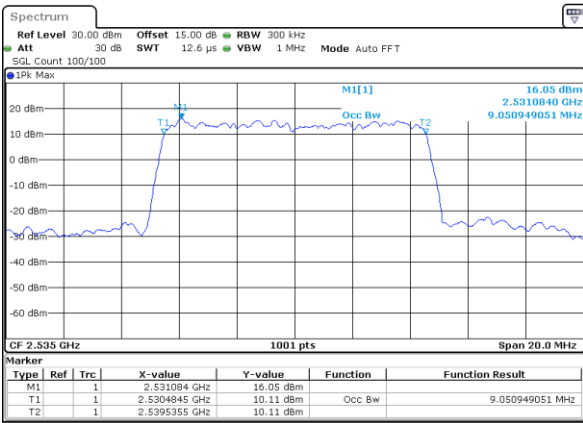

Date: 16_JAN_2023 00:15:33

Middle Channel / 10MHz / 16QAM

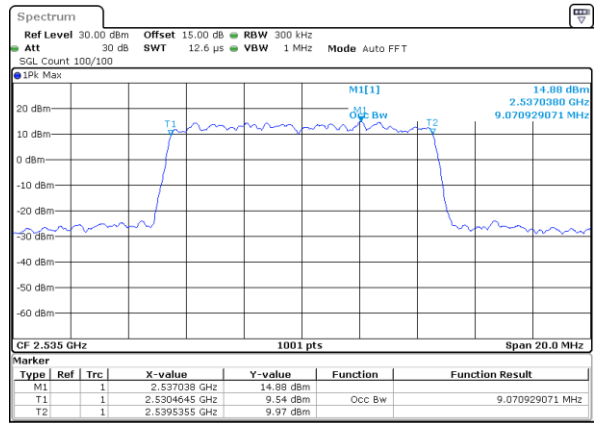

Date: 16_JAN_2023 00:15:55

Highest Channel / 10MHz / QPSK

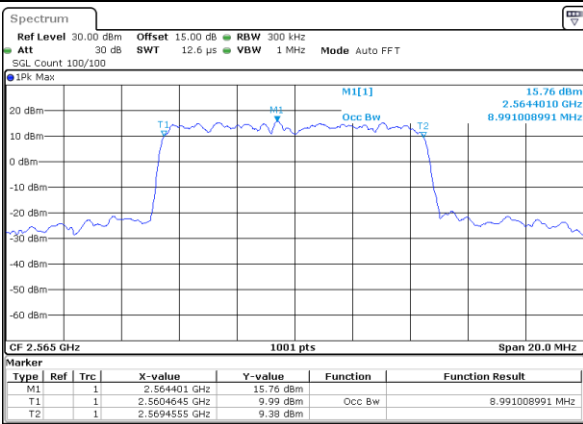

Date: 16_JAN_2023 00:19:37

Highest Channel / 10MHz / 16QAM

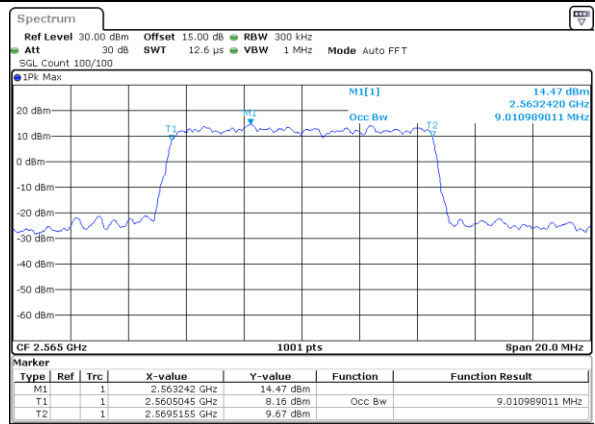

Date: 16_JAN_2023 00:19:59



LTE Band 7

Lowest Channel / 15MHz / QPSK

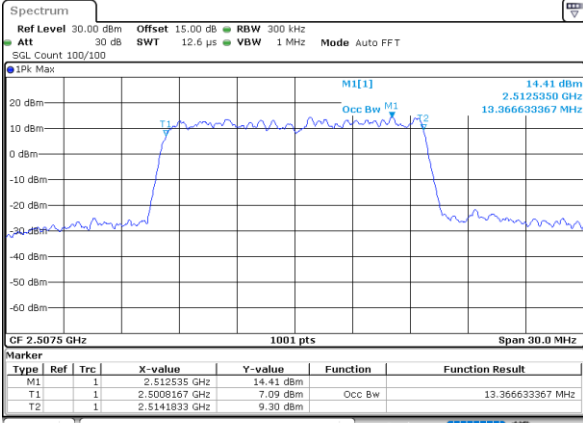

Date: 16_JAN_2023 01:02:23

Lowest Channel / 15MHz / 16QAM

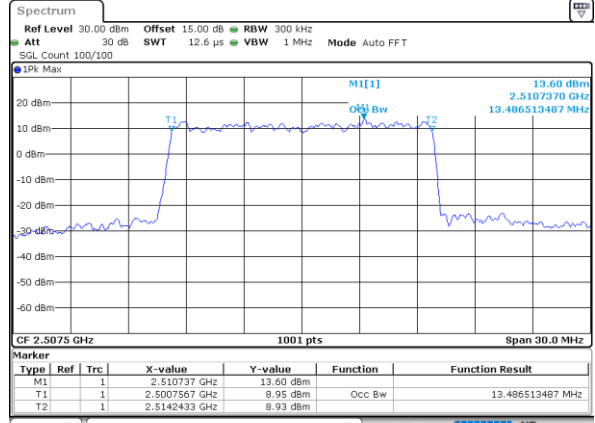

Date: 16_JAN_2023 01:02:45

Middle Channel / 15MHz / QPSK

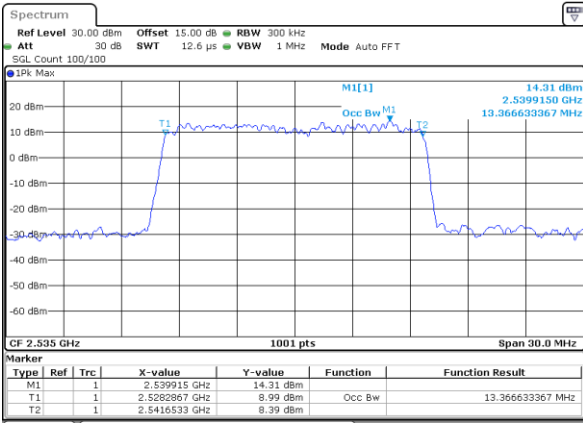

Date: 16_JAN_2023 01:09:53

Middle Channel / 15MHz / 16QAM

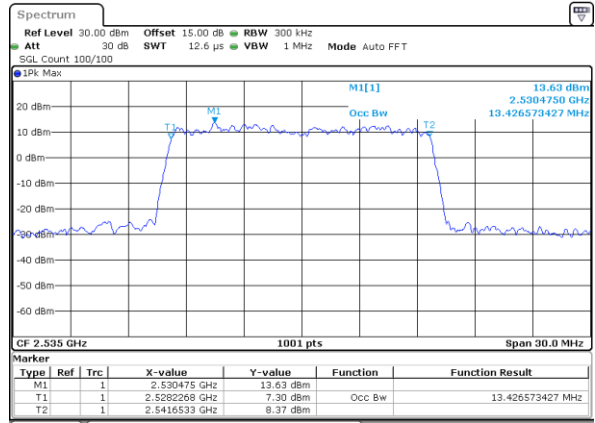

Date: 16_JAN_2023 01:10:15

Highest Channel / 15MHz / QPSK

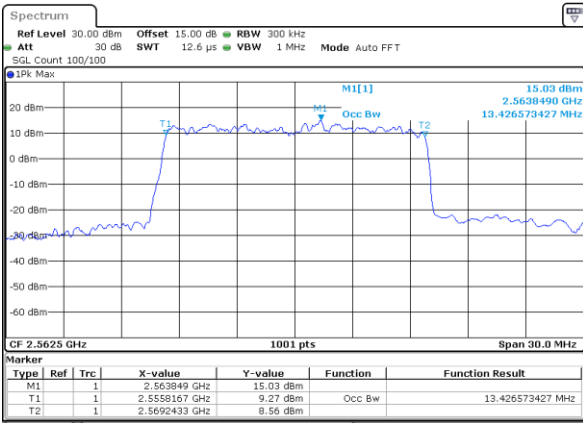

Date: 16_JAN_2023 01:13:57

Highest Channel / 15MHz / 16QAM

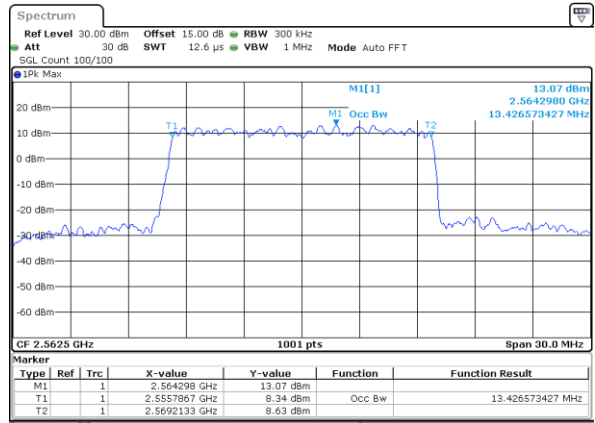

Date: 16_JAN_2023 01:14:19



LTE Band 7

Lowest Channel / 20MHz / QPSK

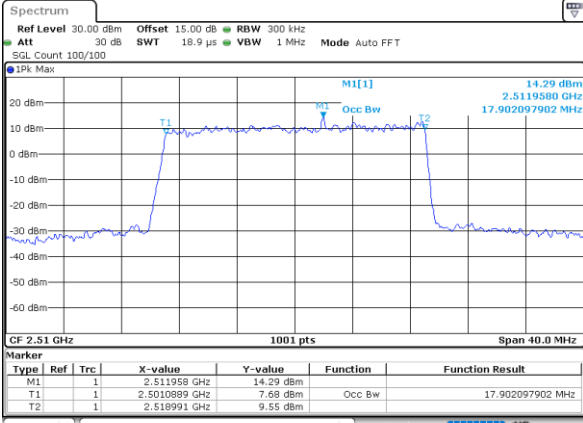

Date: 16_JAN_2023 02:13:07

Lowest Channel / 20MHz / 16QAM

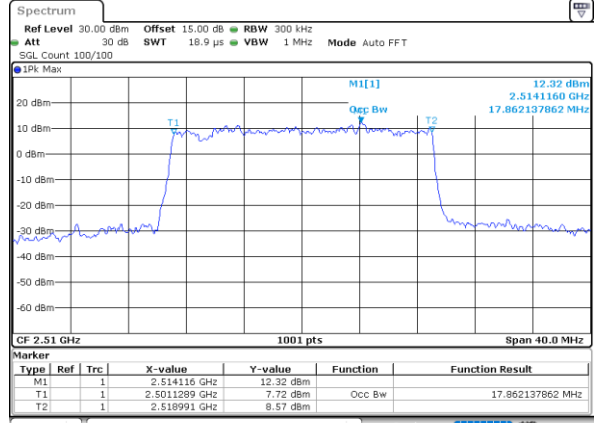

Date: 16_JAN_2023 02:13:132

Middle Channel / 20MHz / QPSK

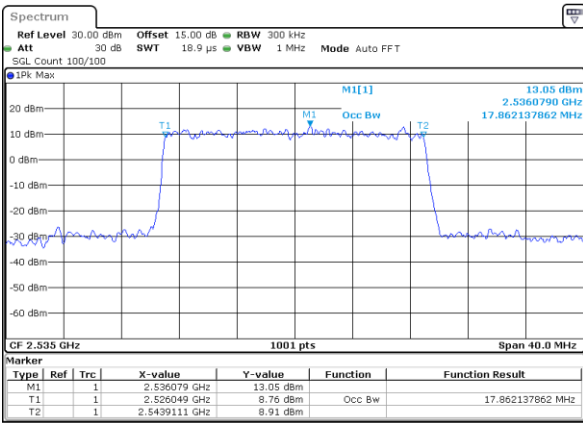

Date: 16_JAN_2023 02:14:01

Middle Channel / 20MHz / 16QAM

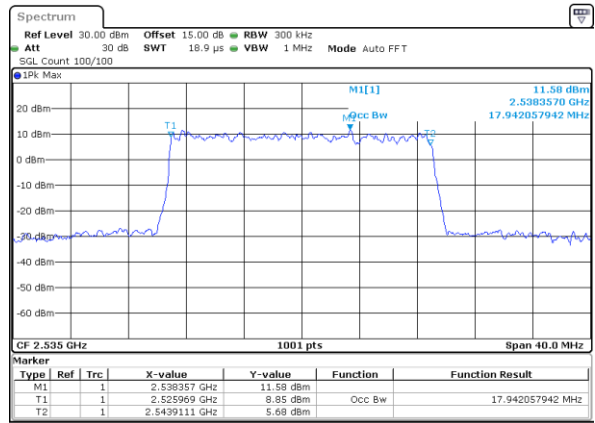

Date: 16_JAN_2023 02:14:125

Highest Channel / 20MHz / QPSK

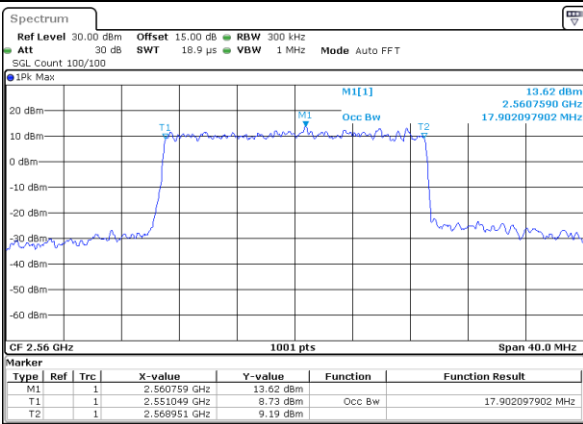

Date: 16_JAN_2023 02:14:25

Highest Channel / 20MHz / 16QAM

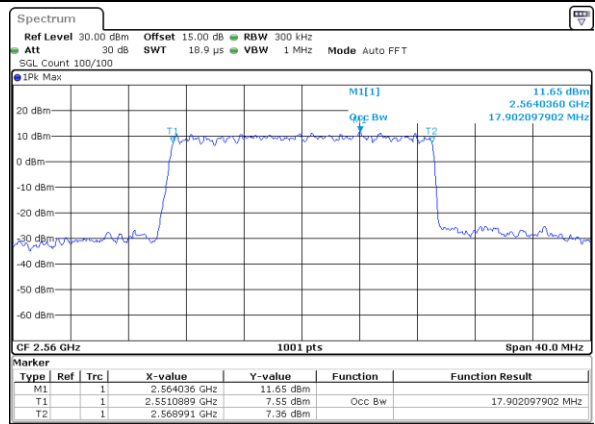

Date: 16_JAN_2023 02:14:149



LTE Band 7

Lowest Channel / 5MHz / 64QAM

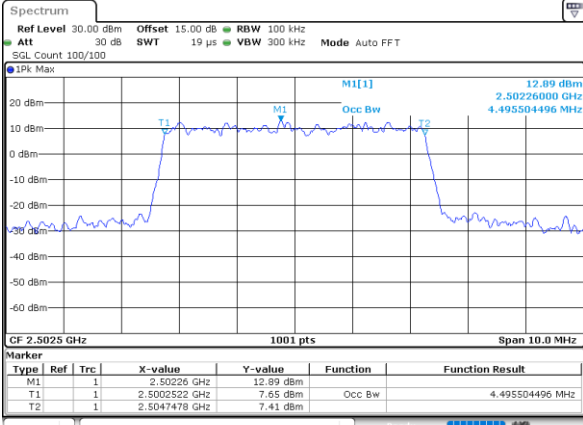

Date: 16_JAN_2023 04:14:37

Lowest Channel / 10MHz / 64QAM

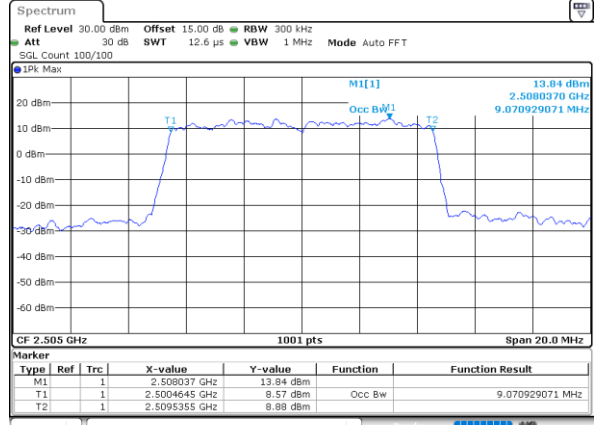

Date: 16_JAN_2023 04:16:36

Middle Channel / 5MHz / 64QAM

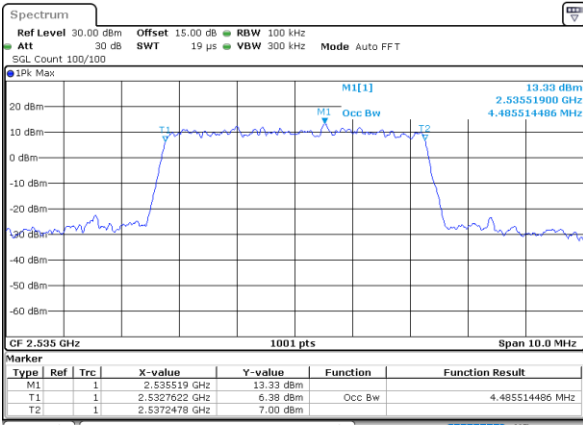

Date: 16_JAN_2023 04:15:16

Middle Channel / 10MHz / 64QAM

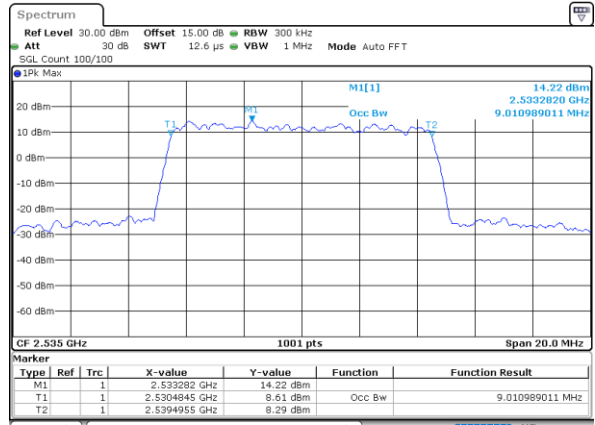

Date: 16_JAN_2023 04:17:15

Highest Channel / 5MHz / 64QAM

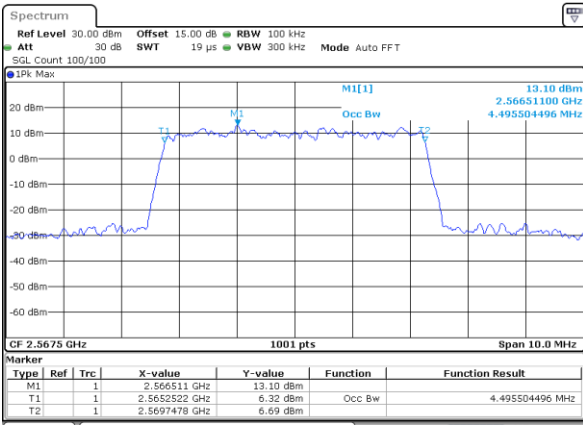

Date: 16_JAN_2023 04:15:55

Highest Channel / 10MHz / 64QAM

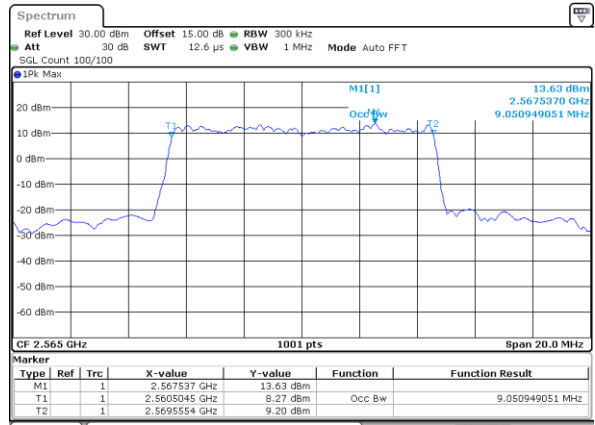

Date: 16_JAN_2023 04:17:53



LTE Band 7

Lowest Channel / 15MHz / 64QAM

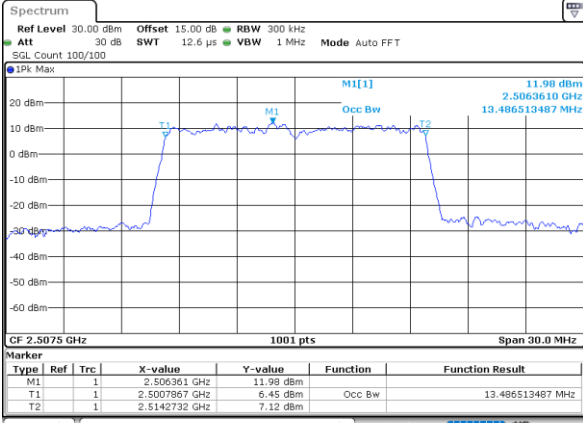

Date: 16_JAN_2023 04:18:14

Lowest Channel / 20MHz / 64QAM

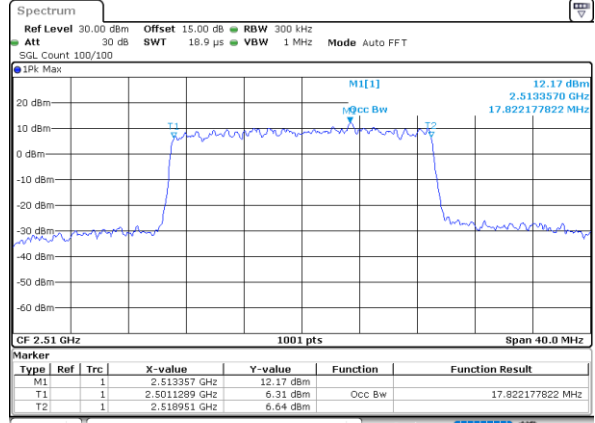

Date: 16_JAN_2023 04:20:33

Middle Channel / 15MHz / 64QAM

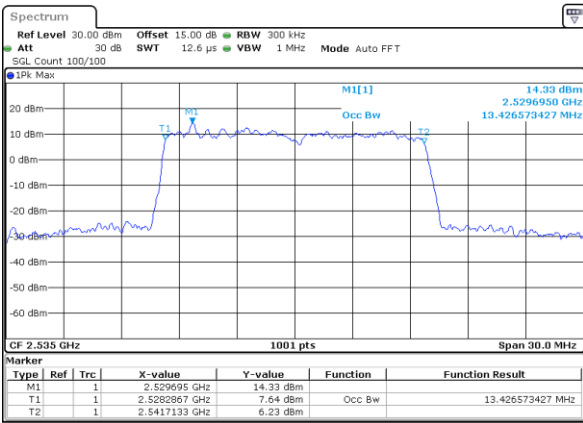

Date: 16_JAN_2023 04:19:13

Middle Channel / 20MHz / 64QAM

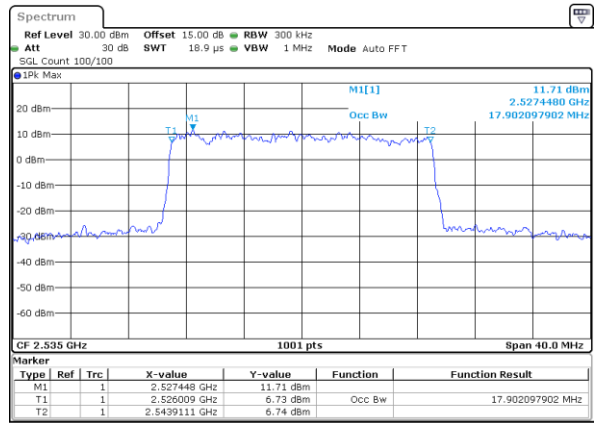

Date: 16_JAN_2023 04:21:12

Highest Channel / 15MHz / 64QAM

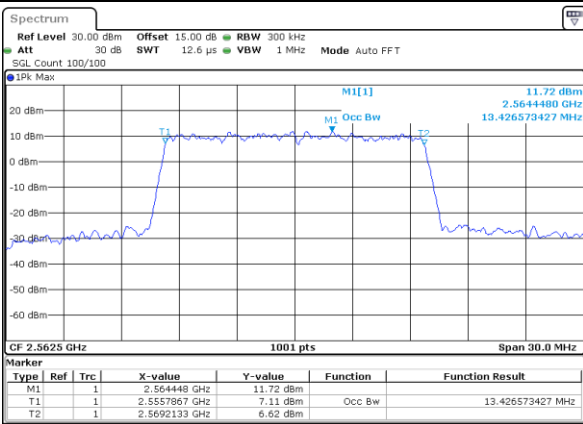

Date: 16_JAN_2023 04:19:52

Highest Channel / 20MHz / 64QAM

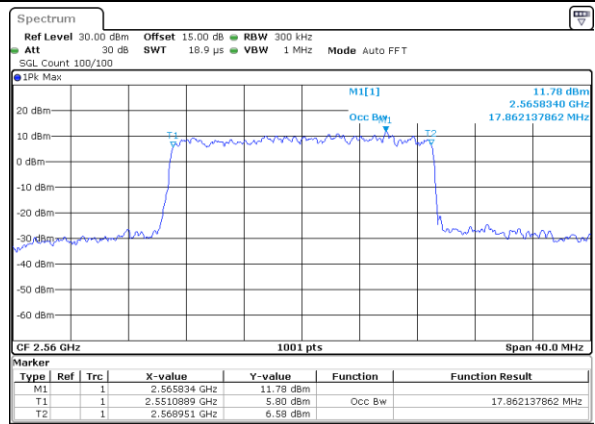

Date: 16_JAN_2023 04:21:51



Conducted Band Edge

