



# FCC RF Test Report

APPLICANT : vivo Mobile Communication Co., Ltd.  
EQUIPMENT : Mobile Phone  
BRAND NAME : vivo  
MODEL NAME : V2206  
FCC ID : 2AUCY-V2206  
STANDARD : 47 CFR Part 2, 22(H), 24(E), 27(L)  
CLASSIFICATION : PCS Licensed Transmitter Held to Ear (PCE)  
TEST DATE(S) : Jul. 22, 2022 ~ Jul. 28, 2022

We, Sporton International Inc. (Shenzhen), would like to declare that the tested sample has been evaluated in accordance with the procedures given in ANSI C63.26-2015 and shown compliance with the applicable technical standards.

The test results in this report apply exclusively to the tested model / sample. Without written approval of Sporton International Inc. (Shenzhen), the test report shall not be reproduced except in full.

Jason Jia



Approved by: Jason Jia

**Sporton International Inc. (ShenZhen)**

**1/F, 2/F, Bldg 5, Shiling Industrial Zone, Xinwei Village, Xili, Nanshan, Shenzhen, 518055**

**People's Republic of China**



# TABLE OF CONTENTS

**REVISION HISTORY..... 3**

**SUMMARY OF TEST RESULT ..... 4**

**1 GENERAL DESCRIPTION ..... 5**

    1.1 Applicant..... 5

    1.2 Manufacturer ..... 5

    1.3 Product Feature of Equipment Under Test ..... 5

    1.4 Product Specification of Equipment Under Test ..... 6

    1.5 Modification of EUT ..... 7

    1.6 Maximum ERP/EIRP Power, and Emission Designator ..... 7

    1.7 Testing Location ..... 7

    1.8 Test Software ..... 8

    1.9 Applicable Standards ..... 8

**2 TEST CONFIGURATION OF EQUIPMENT UNDER TEST ..... 9**

    2.1 Test Mode..... 9

    2.2 Connection Diagram of Test System ..... 10

    2.3 Support Unit used in test configuration ..... 10

    2.4 Measurement Results Explanation Example ..... 10

    2.5 Frequency List of Low/Middle/High Channels..... 11

**3 CONDUCTED TEST RESULT..... 12**

    3.1 Measuring Instruments..... 12

    3.2 Test Setup ..... 12

    3.3 Test Result of Conducted Test..... 12

    3.4 Conducted Output Power and ERP/EIRP ..... 13

    3.5 Peak-to-Average Ratio ..... 14

    3.6 99% Occupied Bandwidth and 26dB Bandwidth Measurement..... 15

    3.7 Conducted Band Edge ..... 16

    3.8 Conducted Spurious Emission ..... 17

    3.9 Frequency Stability..... 18

**4 RADIATED TEST ITEMS ..... 19**

    4.1 Measuring Instruments..... 19

    4.2 Test Setup ..... 19

    4.3 Test Result of Radiated Test..... 20

    4.4 Field Strength of Spurious Radiation Measurement ..... 21

**5 LIST OF MEASURING EQUIPMENT ..... 22**

**6 UNCERTAINTY OF EVALUATION ..... 23**

**APPENDIX A. TEST RESULTS OF CONDUCTED TEST**

**APPENDIX B. TEST RESULTS OF RADIATED TEST**

**APPENDIX C. TEST SETUP PHOTOGRAPHS**



### REVISION HISTORY

REPORT NO.	VERSION	DESCRIPTION	ISSUED DATE
FG270412A	Rev. 01	Initial issue of report	Aug. 09, 2022



## SUMMARY OF TEST RESULT

Report Section	FCC Rule	Description	Limit	Result	Remark
3.4	§2.1046	Conducted Output Power	-	Report Only	-
	§22.913(a)(5)	Effective Radiated Power	< 7 Watts	PASS	-
	§24.232(c)	Equivalent Isotropic Radiated Power	< 2 Watts	PASS	-
	§27.50(d)(4)	Equivalent Isotropic Radiated Power	< 1 Watts	PASS	-
3.5	§24.232(d)	Peak-to-Average Ratio	< 13 dB	PASS	-
3.6	§2.1049	Occupied Bandwidth	Reporting Only	PASS	-
3.7	§2.1051 §22.917(a) §24.238(a) §27.53(h)	Band Edge Measurement	< 43+10log10(P[Watts])	PASS	-
3.8	§2.1051 §22.917(a) §24.238(a) §27.53(h)	Conducted Emission	< 43+10log10(P[Watts])	PASS	-
3.9	§2.1055 §22.355	Frequency Stability for Temperature & Voltage	< 2.5 ppm for Part 22	PASS	-
	§2.1055 §24.235 §27.54		Within Authorized Band		
4.4	§2.1053; §22.917(a); §24.238(a); §27.53(h)	Field Strength of Spurious Radiation	< 43+10log10(P[Watts])	PASS	Under limit 31.52 dB at 2509.2 MHz

**Declaration of Conformity:**

The test results with all measurement uncertainty excluded are presented in accordance with the regulation limits or requirements declared by manufacturers.

**Comments and Explanations:**

The declared of product specification for EUT presented in the report are provided by the manufacturer, and the manufacturer takes all the responsibilities for the accuracy of product specification.



# 1 General Description

## 1.1 Applicant

vivo Mobile Communication Co., Ltd.  
No.1, vivo Road, Chang'an, Dongguan,Guangdong,China

## 1.2 Manufacturer

vivo Mobile Communication Co., Ltd.  
No.1, vivo Road, Chang'an, Dongguan,Guangdong,China

## 1.3 Product Feature of Equipment Under Test

Product Feature	
Equipment	Mobile Phone
Brand Name	vivo
Model Name	V2206
FCC ID	2AUCY-V2206
IMEI Code	Conducted: 865419069992671/865419069992663 Radiation: 865419069993034/865419069993026
HW Version	MP_0.1
SW Version	PD2228EF_EX_A_12.0.5.3.W30.V000L1

**Remark:** The above EUT's information was declared by manufacturer. Please refer to the specifications or user's manual for more detailed description.



### 1.4 Product Specification of Equipment Under Test

Standards-related Product Specification	
<b>Tx Frequency</b>	<b>GSM/GPRS/EDGE:</b> 850: 824 MHz ~ 849 MHz 1900: 1850MHz ~ 1910MHz <b>WCDMA:</b> Band V: 824 MHz ~ 849 MHz Band II: 1850 MHz ~ 1910 MHz Band IV: 1710 MHz ~ 1755 MHz
<b>Rx Frequency</b>	<b>GSM/GPRS/EDGE:</b> 850: 869 MHz ~ 894 MHz 1900: 1930 MHz ~ 1990 MHz <b>WCDMA:</b> Band V: 869 MHz ~ 894 MHz Band II: 1930 MHz ~ 1990 MHz Band IV: 2110 MHz ~ 2155 MHz
<b>Maximum Output Power to Antenna</b>	<b>Ant. 13:</b> <b>GSM/GPRS/EDGE:</b> 850: 32.43 dBm 1900: 29.40 dBm <b>WCDMA:</b> Band V: 22.95 dBm Band II: 23.05 dBm Band IV: 23.10 dBm <b>Ant. 31:</b> <b>GSM/GPRS/EDGE:</b> 850: 32.21 dBm 1900: 29.45 dBm <b>WCDMA:</b> Band V: 23.10 dBm Band II: 23.05 dBm Band IV: 23.06 dBm
<b>Antenna Gain</b>	<b>Ant. 13:</b> Cellular Band: -1.25 dBi PCS Band: -0.92 dBi AWS Band: -2.1 dBi <b>Ant. 31:</b> Cellular Band: -6.4 dBi PCS Band: -0.98 dBi AWS Band: -3.71 dBi
<b>Type of Modulation</b>	GSM/GPRS: GMSK EDGE: 8PSK WCDMA/HSPA : QPSK HSPA+ : 16QAM DC-HSDPA : 64QAM LTE: QPSK / 16QAM / 64QAM



Note: The maximum ERP/EIRP is calculated from max output power and antenna gain, only the maximum ERP/EIRP of Ant.13 is shown in the report.

### 1.5 Modification of EUT

No modifications are made to the EUT during all test items.

### 1.6 Maximum ERP/EIRP Power, and Emission Designator

FCC Rule	Frequency Band	Frequency Range (MHz)	Type of Modulation	Maximum ERP/EIRP (W)	Emission Designator
Part 22	GSM850 (GSM)	824.2 ~ 848.8	GMSK	0.7998	244KGXW
Part 22	GSM850 (EDGE)	824.2 ~ 848.8	8PSK	0.2046	246KG7W
Part 22	WCDMA Band V	826.4 ~ 846.6	BPSK	0.0902	4M14F9W
Part 24	GSM1900 (GSM)	1850.2 ~ 1909.8	GMSK	0.7047	244KGXW
Part 24	GSM1900 (EDGE)	1850.2 ~ 1909.8	8PSK	0.2951	248KG7W
Part 24	WCDMA Band II	1852.4 ~ 1907.6	BPSK	0.1633	4M12F9W
Part 27	WCDMA Band IV	1712.4 ~ 1752.6	BPSK	0.1259	4M12F9W

### 1.7 Testing Location

Sporton International Inc. (Shenzhen) is accredited to ISO/IEC 17025:2017 by American Association for Laboratory Accreditation with Certificate Number 5145.01.

<b>Test Firm</b>	Sporton International Inc. (Shenzhen)		
<b>Test Site Location</b>	1/F, 2/F, Bldg 5, Shiling Industrial Zone, Xinwei Village, Xili, Nanshan, Shenzhen, 518055 People's Republic of China TEL: +86-755-86379589 FAX: +86-755-86379595		
<b>Test Site No.</b>	<b>Sporton Site No.</b>	<b>FCC Designation No.</b>	<b>FCC Test Firm Registration No.</b>
	TH01-SZ	CN1256	421272



<b>Test Firm</b>	Sporton International Inc. (Shenzhen)		
<b>Test Site Location</b>	101, 1st Floor, Block B, Building 1, No. 2, Tengfeng 4th Road, Fenghuang Community, Fuyong Street, Baoan District, Shenzhen City Guangdong Province China 518103 TEL: +86-755-33202398		
<b>Test Site No.</b>	<b>Sporton Site No.</b>	<b>FCC Designation No.</b>	<b>FCC Test Firm Registration No.</b>
	03CH02-SZ	CN1256	421272

### 1.8 Test Software

Item	Site	Manufacturer	Name	Version
1.	03CH02-SZ	AUDIX	E3	6.2009-8-24a
2.	TH01-SZ	Sporton	Part22-24 Test Tools	V5.0

### 1.9 Applicable Standards

According to the specifications of the manufacturer, the EUT must comply with the requirements of the following standards:

- 47 CFR Part 2, 22(H), 24(E), 27(L)
- ANSI C63.26-2015
- FCC KDB 971168 D01 Power Meas. License Digital Systems v03r01
- FCC KDB 412172 D01 Determining ERP and EIRP v01r01

**Remark:**

1. All test items were verified and recorded according to the standards and without any deviation during the test.
2. This EUT has also been tested and complied with the requirements of FCC Part 15, Subpart B, recorded in a separate test report.





## 2 Test Configuration of Equipment Under Test

### 2.1 Test Mode

Antenna port conducted and radiated test items were performed according to KDB 971168 D01 Power Meas. License Digital Systems v03r01 with maximum output power.

Radiated measurements were performed with rotating EUT in different three orthogonal test planes to find the maximum emission.

Radiated emissions were investigated as following frequency range:

1. 30 MHz to 9000 MHz for GSM850 and WCDMA Band V.
2. 30 MHz to 18000 MHz for WCDMA Band IV.
3. 30 MHz to 19100 MHz for GSM1900 and WCDMA Band II.

All modes and data rates and positions were investigated.

Test modes are chosen to be reported as the worst case configuration below:

Test Modes		
Band	Radiated TCs	Conducted TCs
GSM 850	<ul style="list-style-type: none"> <li>■ GSM Link</li> <li>■ EDGE 1 Tx slots Link</li> </ul>	<ul style="list-style-type: none"> <li>■ GSM Link</li> <li>■ EDGE 1 Tx slots Link</li> </ul>
GSM 1900	<ul style="list-style-type: none"> <li>■ GSM Link</li> <li>■ EDGE 1 Tx slots Link</li> </ul>	<ul style="list-style-type: none"> <li>■ GSM Link</li> <li>■ EDGE 1 Tx slots Link</li> </ul>
WCDMA Band V	<ul style="list-style-type: none"> <li>■ RMC 12.2Kbps Link</li> </ul>	<ul style="list-style-type: none"> <li>■ RMC 12.2Kbps Link</li> </ul>
WCDMA Band II	<ul style="list-style-type: none"> <li>■ RMC 12.2Kbps Link</li> </ul>	<ul style="list-style-type: none"> <li>■ RMC 12.2Kbps Link</li> </ul>
WCDMA Band IV	<ul style="list-style-type: none"> <li>■ RMC 12.2Kbps Link</li> </ul>	<ul style="list-style-type: none"> <li>■ RMC 12.2Kbps Link</li> </ul>

## 2.2 Connection Diagram of Test System

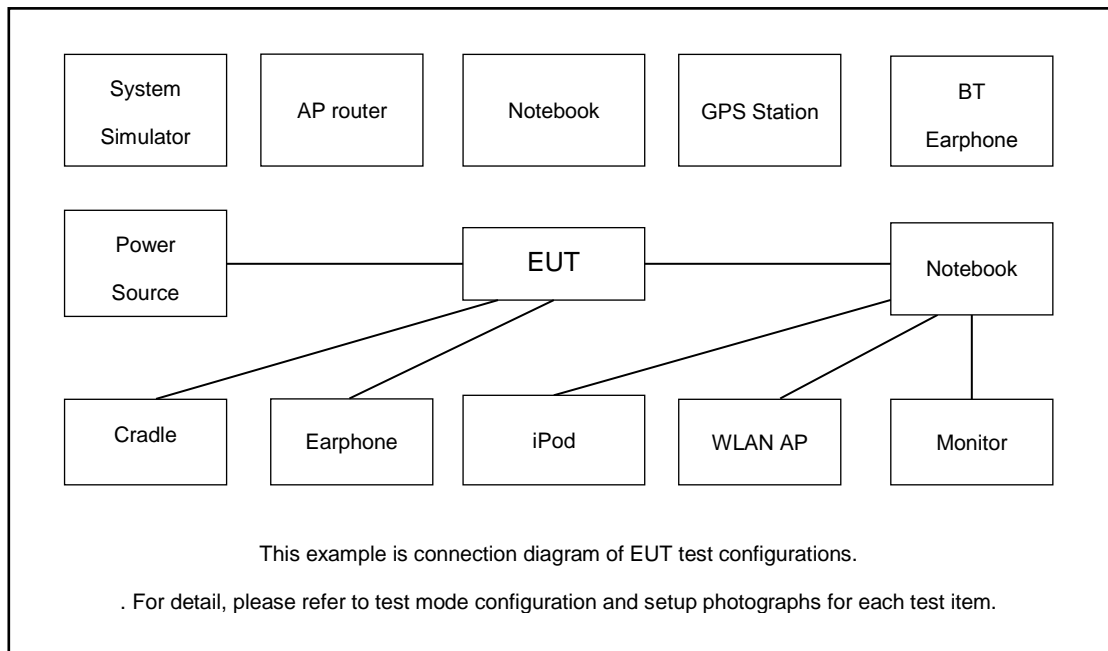

The EUT has been configuration operated in a manner tended to maximize its emission characteristics in a typical application.

## 2.3 Support Unit used in test configuration

Item	Equipment	Trade Name	Model No.	FCC ID	Data Cable	Power Cord
1.	System Simulator	R&S	CMU 200	N/A	N/A	Unshielded, 1.8 m
2.	System Simulator	Agilent	E5515C	N/A	N/A	Unshielded, 1.8 m
3.	Earphone	N/A	N/A	N/A	N/A	N/A

## 2.4 Measurement Results Explanation Example

### For all conducted test items:

The offset level is set in the spectrum analyzer to compensate the RF cable loss and attenuator factor between RF conducted output port and spectrum analyzer. With the offset compensation, the spectrum analyzer reading level will be exactly the RF output level.

The spectrum analyzer offset is derived from RF cable loss and attenuator factor.

*Offset = RF cable loss + attenuator factor.*

The following shows an offset computation example with RF cable loss 4.0 dB and a 10dB attenuator.

Example :

*Offset(dB) = RF cable loss(dB) + attenuator factor(dB).*



= 4.0 + 10 = 14.0 (dB)

## 2.5 Frequency List of Low/Middle/High Channels

Frequency List				
Band	Channel/Frequency(MHz)	Lowest	Middle	Highest
GSM850	Channel	128	189	251
	Frequency	824.2	836.4	848.8
WCDMA Band V	Channel	4132	4182	4233
	Frequency	826.4	836.4	846.6
GSM1900	Channel	512	661	810
	Frequency	1850.2	1880.0	1909.8
WCDMA Band II	Channel	9262	9400	9538
	Frequency	1852.4	1880.0	1907.6
WCDMA Band IV	Channel	1312	1413	1513
	Frequency	1712.4	1732.6	1752.6

### 3 Conducted Test Result

#### 3.1 Measuring Instruments

See list of measuring instruments of this test report.

#### 3.2 Test Setup

##### 3.2.1 Conducted Output Power



##### 3.2.2 Peak-to-Average Ratio, Occupied Bandwidth, Conducted Band-Edge and Conducted Spurious Emission

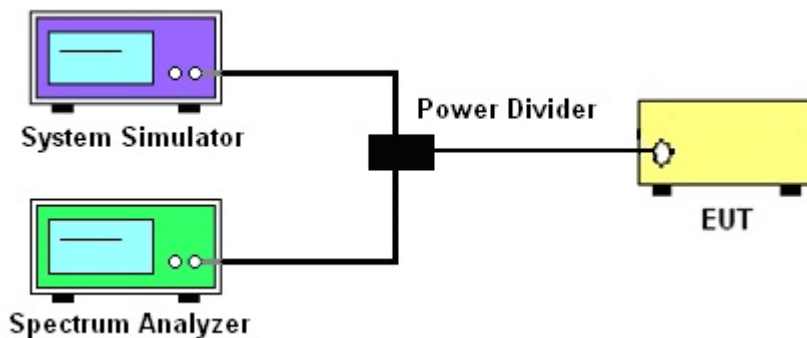

##### 3.2.3 Frequency Stability

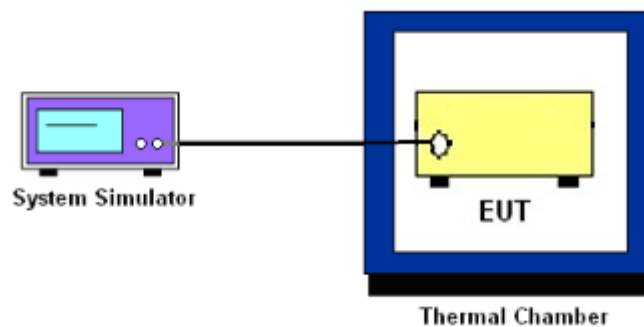

### 3.3 Test Result of Conducted Test

Please refer to Appendix A.



### 3.4 Conducted Output Power and ERP/EIRP

#### 3.4.1 Description of the Conducted Output Power and ERP/EIRP

A system simulator was used to establish communication with the EUT. Its parameters were set to enforce EUT transmitting at the maximum power. The measured power in the radio frequency on the transmitter output terminals shall be reported.

The ERP of mobile transmitters must not exceed 7 Watts for GSM850 and WCDMA Band V.

The EIRP of mobile transmitters must not exceed 2 Watts for GSM1900 and WCDMA Band II.

The EIRP of mobile transmitters must not exceed 1 Watts for WCDMA Band IV.

According to KDB 412172 D01 Power Approach,

$EIRP = P_T + G_T - L_C$ ,  $ERP = EIRP - 2.15$ , where

$P_T$  = transmitter output power in dBm

$G_T$  = gain of the transmitting antenna in dBi

$L_C$  = signal attenuation in the connecting cable between the transmitter and antenna in dB

#### 3.4.2 Test Procedures

1. The testing follows ANSI C63.26 Section 5.2
2. The transmitter output port was connected to the system simulator.
3. Set EUT at maximum power through the system simulator.
4. Select lowest, middle, and highest channels for each band and different modulation.
5. Measure and record the power level from the system simulator.



## **3.5 Peak-to-Average Ratio**

### **3.5.1 Description of the PAR Measurement**

The peak-to-average ratio (PAR) of the transmission may not exceed 13 dB.

### **3.5.2 Test Procedures**

1. The testing follows ANSI C63.26 Section 5.2.3.4 (CCDF).
2. The EUT was connected to spectrum and system simulator via a power divider.
3. Set the CCDF (Complementary Cumulative Distribution Function) option in spectrum analyzer.
4. The highest RF powers were measured and recorded the maximum PAPR level associated with a probability of 0.1 %.
5. Record the deviation as Peak to Average Ratio.



### 3.6 99% Occupied Bandwidth and 26dB Bandwidth Measurement

#### 3.6.1 Description of 99% Occupied Bandwidth and 26dB Bandwidth Measurement

The occupied bandwidth is the width of a frequency band such that, below the lower and above the upper frequency limits, the mean powers emitted are each equal to a specified percentage 0.5% of the total mean transmitted power.

The 26 dB emission bandwidth is defined as the frequency range between two points, one above and one below the carrier frequency, at which the spectral density of the emission is attenuated 26 dB below the maximum in-band spectral density of the modulated signal. Spectral density (power per unit bandwidth) is to be measured with a detector of resolution bandwidth equal to approximately 1.0% of the emission bandwidth.

#### 3.6.2 Test Procedures

1. The testing follows ANSI C63.26 Section 5.4
2. The EUT was connected to spectrum analyzer and system simulator via a power divider.
3. The spectrum analyzer center frequency is set to the nominal EUT channel center frequency. The span range for the spectrum analyzer shall be between two and five times the anticipated OBW.
4. The nominal resolution bandwidth (RBW) shall be in the range of 1 to 5 % of the anticipated OBW, and the VBW shall be at least 3 times the RBW.
5. Set the detection mode to peak, and the trace mode to max hold.
6. Determine the reference value: Set the EUT to transmit a modulated signal. Allow the trace to stabilize. Set the spectrum analyzer marker to the highest level of the displayed trace.  
(this is the reference value)
7. Determine the “-26 dB down amplitude” as equal to (Reference Value – X).
8. Place two markers, one at the lowest and the other at the highest frequency of the envelope of the spectral display such that each marker is at or slightly below the “-X dB down amplitude” determined in step 6. If a marker is below this “-X dB down amplitude” value it shall be placed as close as possible to this value. The OBW is the positive frequency difference between the two markers.
9. Use the 99 % power bandwidth function of the spectrum analyzer and report the measured bandwidth.



## **3.7 Conducted Band Edge**

### **3.7.1 Description of Conducted Band Edge Measurement**

The power of any emission outside of the authorized operating frequency ranges must be lower than the transmitter power (P) by a factor of at least  $43 + 10 \log (P)$  dB.

### **3.7.2 Test Procedures**

1. The testing follows ANSI C63.26 section 5.7
2. The EUT was connected to the spectrum analyzer and system simulator via a power divider.
3. The RF output of EUT was connected to the spectrum analyzer by an RF cable and attenuator. The path loss was compensated to the results for each measurement.
4. The band edges of low and high channels for the highest RF powers were measured.
5. The RF fundamental frequency should be excluded against the limit line in the operating frequency band.
6. The limit line is derived from  $43 + 10\log(P)$  dB below the transmitter power P(Watts)





## **3.8 Conducted Spurious Emission**

### **3.8.1 Description of Conducted Spurious Emission Measurement**

The power of any emission outside of the authorized operating frequency ranges must be lower than the transmitter power (P) by a factor of at least  $43 + 10 \log (P)$  dB.

It is measured by means of a calibrated spectrum analyzer and scanned from 30 MHz up to a frequency including its 10<sup>th</sup> harmonic.

### **3.8.2 Test Procedures**

1. The testing follows ANSI C63.26 section 5.7
2. The EUT was connected to the spectrum analyzer and system simulator via a power divider.
3. The RF output of EUT was connected to the spectrum analyzer by an RF cable and attenuator. The path loss was compensated to the results for each measurement.
4. The middle channel for the highest RF power within the transmitting frequency was measured.
5. The conducted spurious emission for the whole frequency range was taken.
6. The RF fundamental frequency should be excluded against the limit line in the operating frequency band.
7. The limit line is derived from  $43 + 10\log(P)$  dB below the transmitter power P(Watts)



## 3.9 Frequency Stability

### 3.9.1 Description of Frequency Stability Measurement

The frequency stability shall be measured by variation of ambient temperature and variation of primary supply voltage to ensure that the fundamental emission stays within the authorized frequency block. The frequency stability of the transmitter shall be maintained within  $\pm 0.00025\%$  ( $\pm 2.5\text{ppm}$ ) of the center frequency.

### 3.9.2 Test Procedures for Temperature Variation

1. The testing follows ANSI C63.26 section 5.6.4
2. The EUT was set up in the thermal chamber and connected with the system simulator.
3. With power OFF, the temperature was decreased to  $-30^{\circ}\text{C}$  and the EUT was stabilized before testing. Power was applied and the maximum change in frequency was recorded within one minute.
4. With power OFF, the temperature was raised in  $10^{\circ}\text{C}$  step up to  $50^{\circ}\text{C}$ . The EUT was stabilized at each step for at least half an hour. Power was applied and the maximum frequency change was recorded within one minute.

### 3.9.3 Test Procedures for Voltage Variation

1. The testing follows ANSI C63.26 section 5.6.5
2. The EUT was placed in a temperature chamber at  $20\pm 5^{\circ}\text{C}$  and connected with the system simulator.
3. The power supply voltage to the EUT was varied from 85% to 115% of the nominal value for other than hand carried battery equipment.
4. For hand carried, battery powered equipment, reduce the primary ac or dc supply voltage to the battery operating end point, which shall be specified by the manufacturer.
5. The variation in frequency was measured for the worst case.

## 4 Radiated Test Items

### 4.1 Measuring Instruments

See list of measuring instruments of this test report.

### 4.2 Test Setup

#### 4.2.1 For radiated test below 30MHz



#### 4.2.2 For radiated test from 30MHz to 1GHz

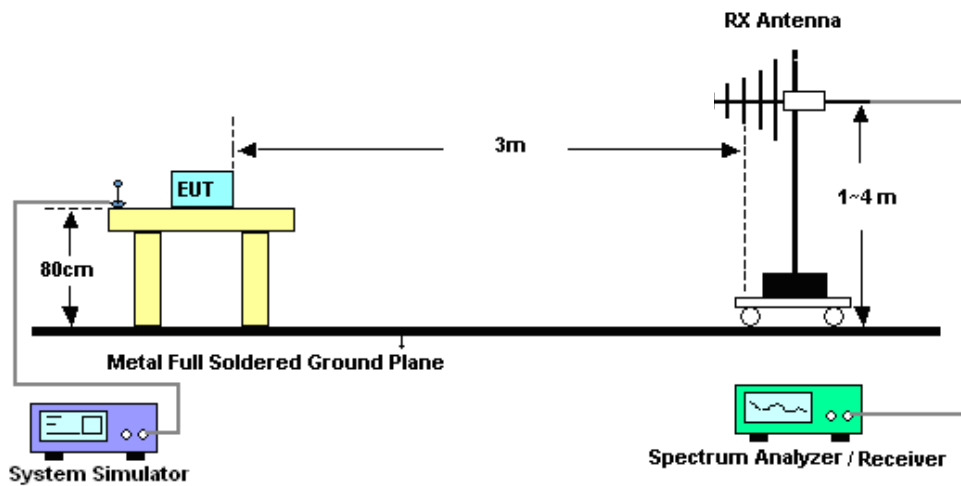

### 4.2.3 For radiated test above 1GHz

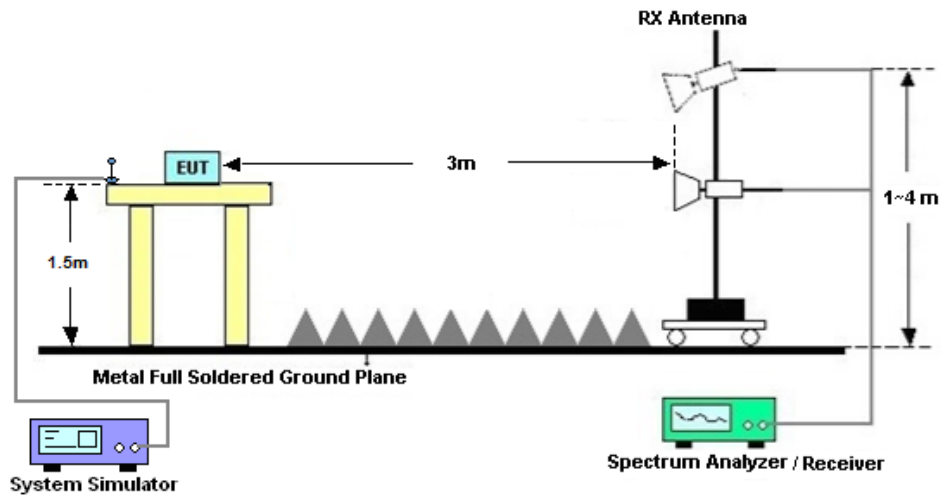

## 4.3 Test Result of Radiated Test

The low frequency, which started from 9 kHz to 30MHz, was pre-scanned and the result which was 20dB lower than the limit line was not reported.

Please refer to Appendix B.



## 4.4 Field Strength of Spurious Radiation Measurement

### 4.4.1 Description of Field Strength of Spurious Radiated Measurement

The power of any emission outside of the authorized operating frequency ranges must be attenuated below the transmitter power (P) by a factor of at least  $43 + 10 \log (P)$  dB. The spectrum is scanned from 30 MHz up to a frequency including its 10th harmonic.

### 4.4.2 Test Procedures

1. The testing follows ANSI C63.26 Section 5.5
2. The EUT was placed on a rotatable wooden table 0.8 meters for frequency below 1GHz and 1.5 meter for frequency above 1GHz above the ground.
3. The EUT was set 3 meters from the receiving antenna, which was mounted on the antenna tower.
4. The table was rotated 360 degrees to determine the position of the highest spurious emission.
5. The height of the receiving antenna is varied between one meter and four meters to search for the maximum spurious emission for both horizontal and vertical polarizations.
6. Make the measurement with the spectrum analyzer's RBW = 1MHz, VBW = 3MHz, taking record of maximum spurious emission.
7. A horn antenna was substituted in place of the EUT and was driven by a signal generator.
8. Tune the output power of signal generator to the same emission level with EUT maximum spurious emission.
9. Taking the record of output power at antenna port.
10. Repeat step 7 to step 8 for another polarization.
11.  $EIRP \text{ (dBm)} = S.G. \text{ Power} - Tx \text{ Cable Loss} + Tx \text{ Antenna Gain}$
12.  $ERP \text{ (dBm)} = EIRP - 2.15$
13. The RF fundamental frequency should be excluded against the limit line in the operating frequency band.
14. The limit line is derived from  $43 + 10\log(P)$  dB below the transmitter power P(Watts)



## 5 List of Measuring Equipment

Instrument	Manufacturer	Model No.	Serial No.	Characteristics	Calibration Date	Test Date	Due Date	Remark
Spectrum Analyzer	R&S	FSV40	101078	10Hz~40GHz	Apr. 07, 2022	Jul. 22, 2022	Apr. 08, 2023	Conducted (TH01-SZ)
Power Divider	TOJOIN	PS-2SM-04 265	60.06.020.007 7	0.4GHz~26.5GHz	Dec. 25, 2021	Jul. 22, 2022	Dec. 24, 2022	Conducted (TH01-SZ)
DC Power Supply	TTI	PL330P	290070	Max 32V , 3A	Oct. 25, 2021	Jul. 22, 2022	Oct. 24, 2022	Conducted (TH01-SZ)
Thermal Chamber	Ten Billion Hongzhangroup	LP-150U	H2014081803	-40~+150°C	Jul. 14, 2022	Jul. 22, 2022	Jul. 13, 2023	Conducted (TH01-SZ)
EMI Test Receiver	R&S	ESR7	101404	9kHz~7GHz	Oct. 22, 2021	Jul. 28, 2022	Oct. 21, 2022	Radiation (03CH02-SZ)
EXA Spectrum Analyzer	KEYSIGHT	N9010A	MY55150213	10Hz~44GHz	Jul. 07, 2022	Jul. 28, 2022	Jul. 06, 2023	Radiation (03CH02-SZ)
Loop Antenna	R&S	HFH2-Z2	100354	9kHz~30MHz	Jun. 22, 2022	Jul. 28, 2022	Jun. 21, 2023	Radiation (03CH02-SZ)
Bilog Antenna	TeseQ	CBL6112D	35407	30MHz~2GHz	Oct. 22, 2021	Jul. 28, 2022	Oct. 21, 2022	Radiation (03CH02-SZ)
Double Ridge Horn Antenna	ETS-Lindgren	3117	00119436	1GHz~18GHz	Jul. 07, 2022	Jul. 28, 2022	Jul. 06, 2023	Radiation (03CH02-SZ)
SHF-EHF Horn	com-power	AH-840	101071	18Ghz~40GHz	Apr. 11, 2022	Jul. 28, 2022	Apr. 10, 2023	Radiation (03CH02-SZ)
LF Amplifier	Burgeon	BPA-530	102211	0.01~3000Mhz	Oct. 22, 2021	Jul. 28, 2022	Oct. 21, 2022	Radiation (03CH02-SZ)
HF Amplifier	KEYSIGHT	83017A	MY53270105	0.5GHz~26.5Ghz	Oct. 22, 2021	Jul. 28, 2022	Oct. 21, 2022	Radiation (03CH02-SZ)
HF Amplifier	MITEQ	TTA1840-35 -HG	1871923	18GHz~40GHz	Jul. 06, 2022	Jul. 28, 2022	Jul. 05, 2023	Radiation (03CH02-SZ)
AC Power Source	Chroma	61601	61601000247 0	N/A	NCR	Jul. 28, 2022	NCR	Radiation (03CH02-SZ)
Turn Table	Chaintek	T-200	N/A	0~360 degree	NCR	Jul. 28, 2022	NCR	Radiation (03CH02-SZ)
Antenna Mast	Chaintek	MBS-400	N/A	1 m~4 m	NCR	Jul. 28, 2022	NCR	Radiation (03CH02-SZ)

NCR: No Calibration Required



## 6 Uncertainty of Evaluation

The measurement uncertainties shown below were calculated in accordance with the requirements of ANSI 63.26-2015. All the measurement uncertainty value were shown with a coverage K=2 to indicate 95% level of confidence. The measurement data show herein meets or exceeds the CISPR measurement uncertainty values specified in CISPR 16-4-2 and can be compared directly to specified limit to determine compliance.

### Uncertainty of Radiated Emission Measurement (30 MHz ~ 1000 MHz)

Measuring Uncertainty for a Level of Confidence of 95% (U = 2Uc(y))	2.5dB
---	-------

### Uncertainty of Radiated Emission Measurement (1 GHz ~ 18 GHz)

Measuring Uncertainty for a Level of Confidence of 95% (U = 2Uc(y))	3.3dB
---	-------

### Uncertainty of Radiated Emission Measurement (18 GHz ~ 40 GHz)

Measuring Uncertainty for a Level of Confidence of 95% (U = 2Uc(y))	3.7dB
---	-------

----- THE END -----



## Appendix A. Test Results of Conducted Test

Test Engineer :	Lorenzo Liu	Temperature :	24~26°C
		Relative Humidity :	50~53%

### Conducted Output Power(Average power)

GSM850_Ant 13	Burst Average Power (dBm)		
	TX Channel	128	189
Frequency (MHz)	824.2	836.4	848.8
GSM 1 Tx slot	32.41	32.43	32.40
GPRS 1 Tx slot	32.40	32.42	32.36
GPRS 2 Tx slots	30.55	30.58	30.57
GPRS 3 Tx slots	28.46	28.27	28.37
GPRS 4 Tx slots	26.74	26.57	26.64
EDGE 1 Tx slot	26.51	26.31	26.28
EDGE 2 Tx slots	24.85	24.74	24.76
EDGE 3 Tx slots	22.74	22.75	22.61
EDGE 4 Tx slots	21.13	21.06	21.08

GSM1900_Ant 13	Burst Average Power (dBm)		
	TX Channel	512	661
Frequency (MHz)	1850.2	1880	1909.8
GSM 1 Tx slot	29.40	29.36	29.39
GPRS 1 Tx slot	29.35	29.34	29.35
GPRS 2 Tx slots	27.83	27.85	27.80
GPRS 3 Tx slots	25.95	26.04	26.00
GPRS 4 Tx slots	24.20	24.31	24.57
EDGE 1 Tx slot	25.46	25.52	25.62
EDGE 2 Tx slots	23.81	23.88	23.98
EDGE 3 Tx slots	21.63	21.72	21.80
EDGE 4 Tx slots	20.85	20.92	21.06





Band		WCDMA II		
TX Channel		9262	9400	9538
Rx Channel		9662	9800	9938
Frequency (MHz)		1852.4	1880	1907.6
3GPP Rel 99	AMR 12.2Kbps	23.04	22.96	23.03
3GPP Rel 99	RMC 12.2Kbps	22.97	23.05	22.99
3GPP Rel 6	HSDPA Subtest-1	21.87	21.87	21.96
3GPP Rel 6	HSDPA Subtest-2	22.02	21.96	22.01
3GPP Rel 6	HSDPA Subtest-3	21.50	21.47	21.61
3GPP Rel 6	HSDPA Subtest-4	21.49	21.47	21.61
3GPP Rel 8	DC-HSDPA Subtest-1	21.85	21.72	21.81
3GPP Rel 8	DC-HSDPA Subtest-2	21.98	21.91	21.91
3GPP Rel 8	DC-HSDPA Subtest-3	21.48	21.42	21.57
3GPP Rel 8	DC-HSDPA Subtest-4	21.45	21.43	21.46
3GPP Rel 6	HSUPA Subtest-1	21.99	21.94	22.04
3GPP Rel 6	HSUPA Subtest-2	19.98	19.91	20.02
3GPP Rel 6	HSUPA Subtest-3	20.97	20.96	21.01
3GPP Rel 6	HSUPA Subtest-4	20.02	19.97	20.07
3GPP Rel 6	HSUPA Subtest-5	22.00	22.00	22.00
3GPP Rel 7	HSPA+ (16QAM) Subtest-1	20.88	21.04	20.89

Band		WCDMA IV		
TX Channel		1312	1413	1513
Rx Channel		1537	1638	1738
Frequency (MHz)		1712.4	1732.6	1752.6
3GPP Rel 99	AMR 12.2Kbps	23.01	23.07	23.02
3GPP Rel 99	RMC 12.2Kbps	22.98	23.10	22.98
3GPP Rel 6	HSDPA Subtest-1	21.87	21.81	21.90
3GPP Rel 6	HSDPA Subtest-2	21.90	21.96	21.90
3GPP Rel 6	HSDPA Subtest-3	21.38	21.46	21.40
3GPP Rel 6	HSDPA Subtest-4	21.37	21.46	21.39
3GPP Rel 8	DC-HSDPA Subtest-1	21.85	21.77	21.77
3GPP Rel 8	DC-HSDPA Subtest-2	21.88	21.87	21.81
3GPP Rel 8	DC-HSDPA Subtest-3	21.23	21.38	21.35
3GPP Rel 8	DC-HSDPA Subtest-4	21.25	21.40	21.29
3GPP Rel 6	HSUPA Subtest-1	21.88	21.98	21.85
3GPP Rel 6	HSUPA Subtest-2	20.01	20.00	19.89
3GPP Rel 6	HSUPA Subtest-3	21.03	21.00	20.95
3GPP Rel 6	HSUPA Subtest-4	20.05	20.04	19.87
3GPP Rel 6	HSUPA Subtest-5	22.00	22.00	21.90
3GPP Rel 7	HSPA+ (16QAM) Subtest-1	20.92	21.10	20.99



Band		WCDMA V		
TX Channel		4132	4182	4233
Rx Channel		4357	4407	4458
Frequency (MHz)		826.4	836.4	846.6
3GPP Rel 99	AMR 12.2Kbps	22.93	22.88	22.89
3GPP Rel 99	RMC 12.2Kbps	22.87	22.95	22.90
3GPP Rel 6	HSDPA Subtest-1	21.93	22.01	21.96
3GPP Rel 6	HSDPA Subtest-2	21.88	21.82	21.84
3GPP Rel 6	HSDPA Subtest-3	21.40	21.41	21.37
3GPP Rel 6	HSDPA Subtest-4	21.37	21.40	21.36
3GPP Rel 8	DC-HSDPA Subtest-1	21.86	22.00	21.93
3GPP Rel 8	DC-HSDPA Subtest-2	21.77	21.77	21.74
3GPP Rel 8	DC-HSDPA Subtest-3	21.32	21.27	21.36
3GPP Rel 8	DC-HSDPA Subtest-4	21.27	21.37	21.32
3GPP Rel 6	HSUPA Subtest-1	21.91	21.95	21.93
3GPP Rel 6	HSUPA Subtest-2	19.85	19.91	19.88
3GPP Rel 6	HSUPA Subtest-3	20.79	20.87	20.85
3GPP Rel 6	HSUPA Subtest-4	20.01	20.05	19.88
3GPP Rel 6	HSUPA Subtest-5	21.90	21.80	21.90
3GPP Rel 7	HSPA+ (16QAM) Subtest-1	20.85	20.95	20.88



**ERP/EIRP**

<b>GSM850 (G<sub>T</sub> - L<sub>C</sub>= -1.25 dB)</b>			
<b>Channel</b>	<b>128</b>	<b>189</b>	<b>251</b>
	<b>(Low)</b>	<b>(Mid)</b>	<b>(High)</b>
<b>Frequency</b>	<b>824.2</b>	<b>836.4</b>	<b>848.8</b>
<b>(MHz)</b>			
<b>Conducted Power (dBm)</b>	32.41	32.43	32.40
<b>Conducted Power (Watts)</b>	1.7418	1.7498	1.7378
<b>ERP(dBm)</b>	29.01	29.03	29.00
<b>ERP(Watts)</b>	0.7962	0.7998	0.7943

<b>EDGE850 (G<sub>T</sub> - L<sub>C</sub>= -1.25 dB)</b>			
<b>Channel</b>	<b>128</b>	<b>189</b>	<b>251</b>
	<b>(Low)</b>	<b>(Mid)</b>	<b>(High)</b>
<b>Frequency</b>	<b>824.2</b>	<b>836.4</b>	<b>848.8</b>
<b>(MHz)</b>			
<b>Conducted Power (dBm)</b>	26.51	26.31	26.28
<b>Conducted Power (Watts)</b>	0.4477	0.4276	0.4246
<b>ERP(dBm)</b>	23.11	22.91	22.88
<b>ERP(Watts)</b>	0.2046	0.1954	0.1941



GSM1900 (G <sub>T</sub> - L <sub>C</sub> = -0.92 dB)			
Channel	512	661	810
	(Low)	(Mid)	(High)
Frequency	1850.2	1880	1909.8
(MHz)			
Conducted Power (dBm)	29.40	29.36	29.39
Conducted Power (Watts)	0.8710	0.8630	0.8690
EIRP(dBm)	28.48	28.44	28.47
EIRP(Watts)	0.7047	0.6982	0.7031

EDGE1900 (G <sub>T</sub> - L <sub>C</sub> = -0.92 dB)			
Channel	512	661	810
	(Low)	(Mid)	(High)
Frequency	1850.2	1880	1909.8
(MHz)			
Conducted Power (dBm)	25.46	25.52	25.62
Conducted Power (Watts)	0.3516	0.3565	0.3648
EIRP(dBm)	24.54	24.60	24.70
EIRP(Watts)	0.2844	0.2884	0.2951



WCDMA Band V ( $G_T - L_C = -1.25$ dB)			
Channel	4132	4182	4233
	(Low)	(Mid)	(High)
Frequency	826.4	836.4	846.6
(MHz)			
Conducted Power (dBm)	22.87	22.95	22.90
Conducted Power (Watts)	0.1936	0.1972	0.1950
ERP(dBm)	19.47	19.55	19.50
ERP(Watts)	0.0885	0.0902	0.0891

WCDMA Band II ( $G_T - L_C = -0.92$ dB)			
Channel	9262	9400	9538
	(Low)	(Mid)	(High)
Frequency	1852.4	1880	1907.6
(MHz)			
Conducted Power (dBm)	22.97	23.05	22.99
Conducted Power (Watts)	0.1982	0.2018	0.1991
EIRP(dBm)	22.05	22.13	22.07
EIRP(Watts)	0.1603	0.1633	0.1611

WCDMA Band IV ( $G_T - L_C = -2.1$ dB)			
Channel	1312	1413	1513
	(Low)	(Mid)	(High)
Frequency	1712.4	1732.6	1752.6
(MHz)			
Conducted Power (dBm)	22.98	23.10	22.98
Conducted Power (Watts)	0.1986	0.2042	0.1986
EIRP(dBm)	20.88	21.00	20.88
EIRP(Watts)	0.1225	0.1259	0.1225



## A1. GSM

### Peak-to-Average Ratio

Mode	GSM850(dB)		Limit: 13dB
Mod.	GSM	EDGE class 8	Result
Lowest CH	0.35	3.62	PASS
Middle CH	0.29	3.51	
Highest CH	0.35	3.25	

Mode	GSM1900(dB)		Limit: 13dB
Mod.	GSM	EDGE class 8	Result
Lowest CH	0.41	2.87	PASS
Middle CH	0.43	3.25	
Highest CH	0.38	3.28	

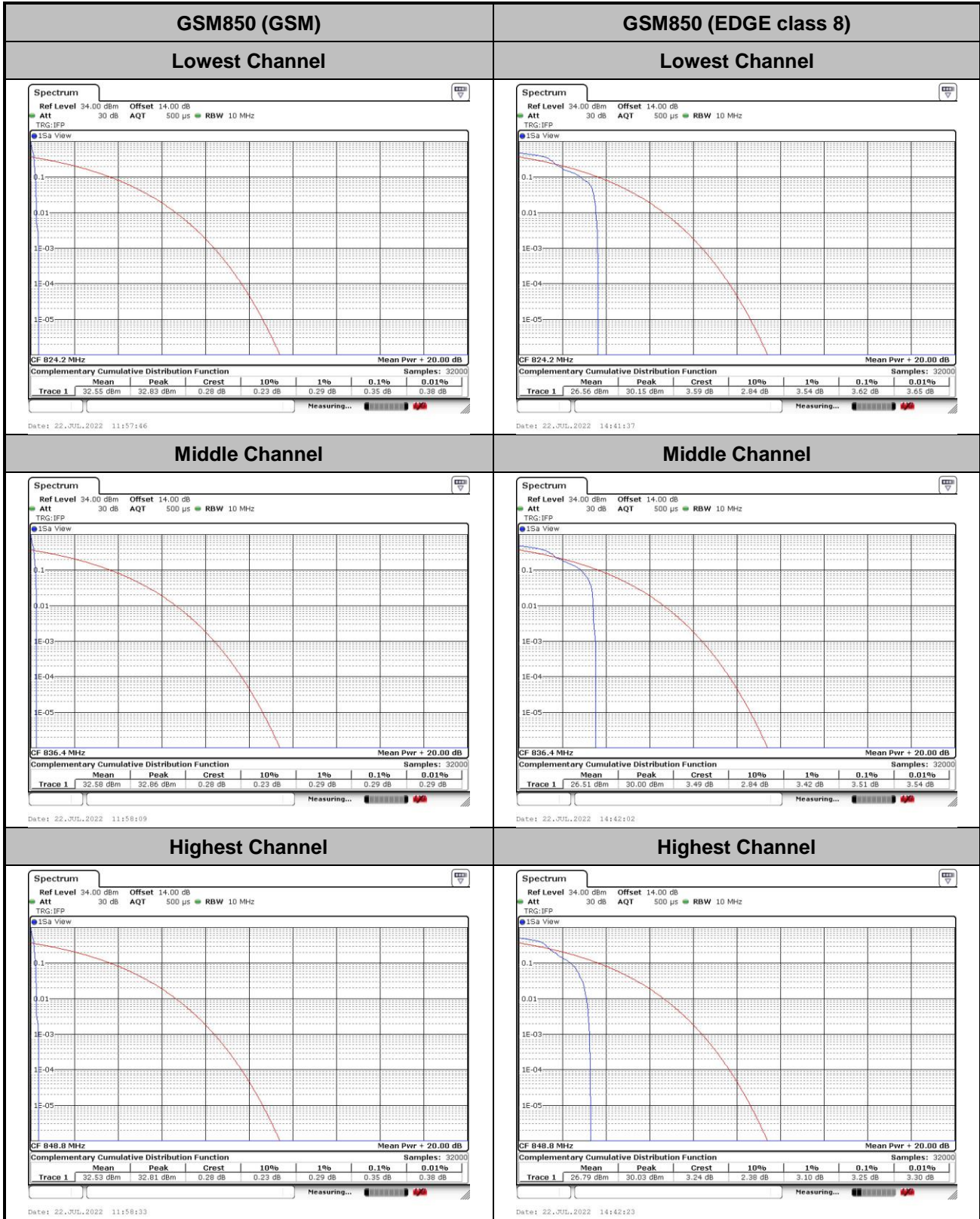

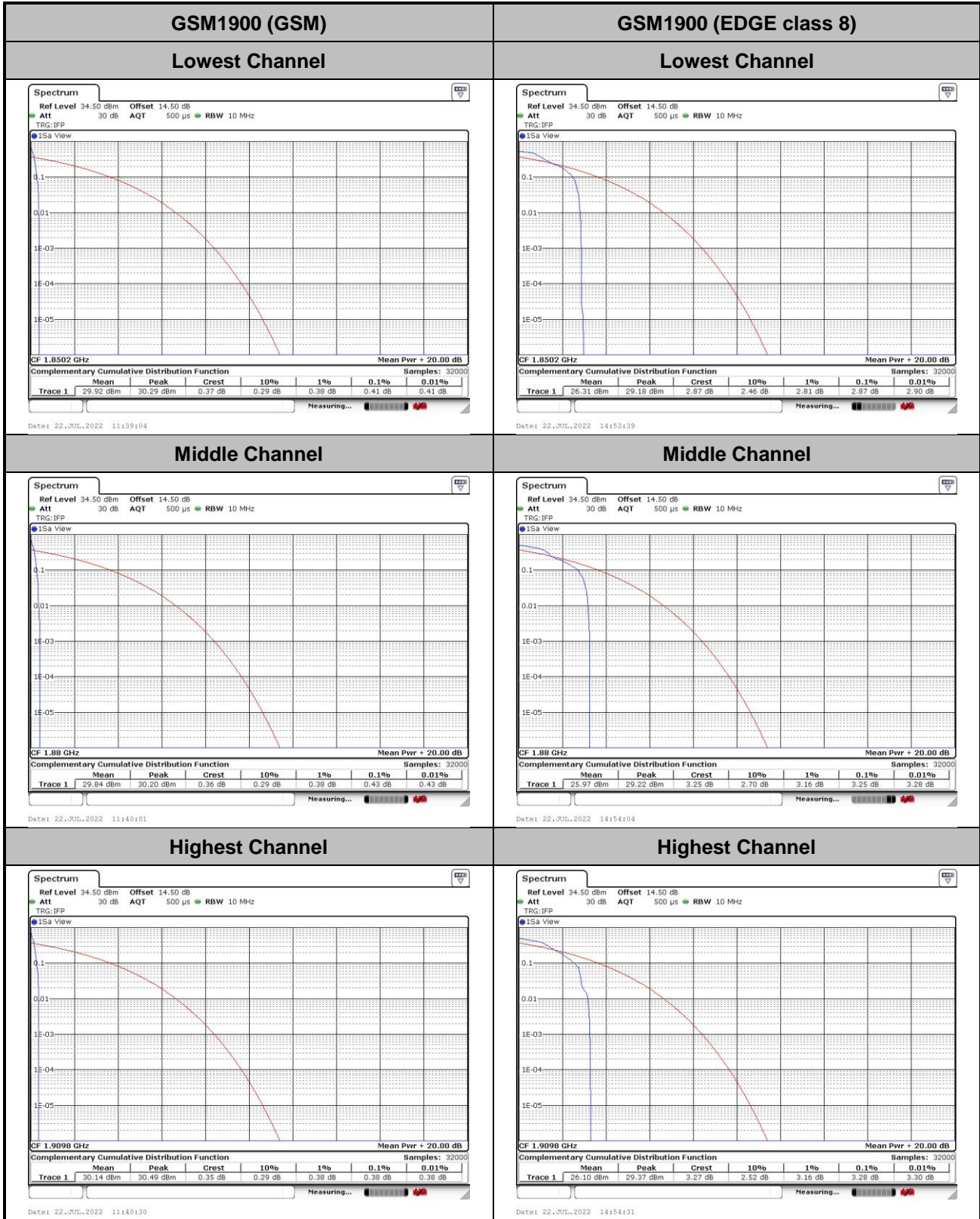





**26dB Bandwidth**

Mode	GSM850(MHz)	
Mod.	GSM	EDGE class 8
Lowest CH	0.31	0.31
Middle CH	0.31	0.31
Highest CH	0.31	0.31

Mode	GSM1900(MHz)	
Mod.	GSM	EDGE class 8
Lowest CH	0.31	0.31
Middle CH	0.31	0.31
Highest CH	0.31	0.31



GSM850 (GSM)

Lowest Channel

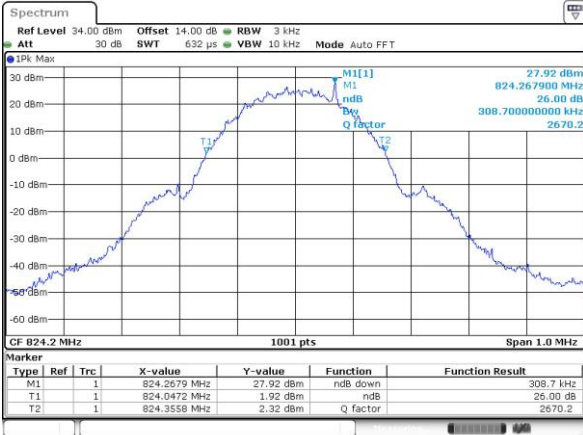

Date: 22\_JUL\_2022 11:43:58

GSM850 (EDGE class 8)

Lowest Channel

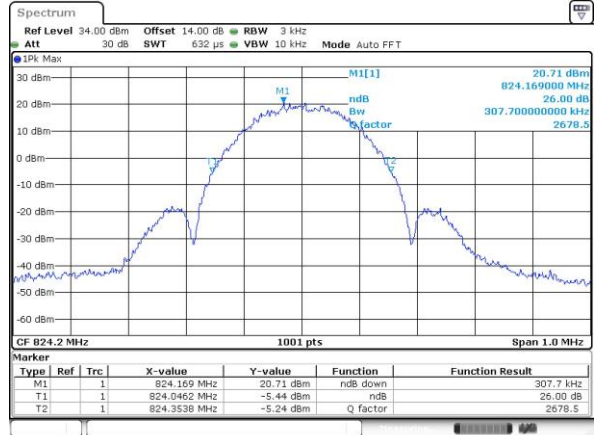

Date: 22\_JUL\_2022 14:34:00

Middle Channel

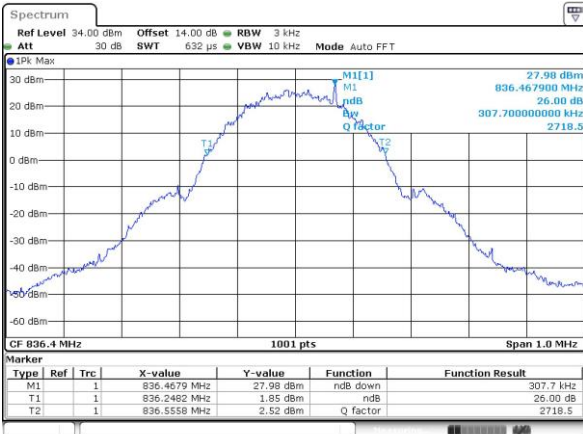

Date: 22\_JUL\_2022 11:45:34

Middle Channel

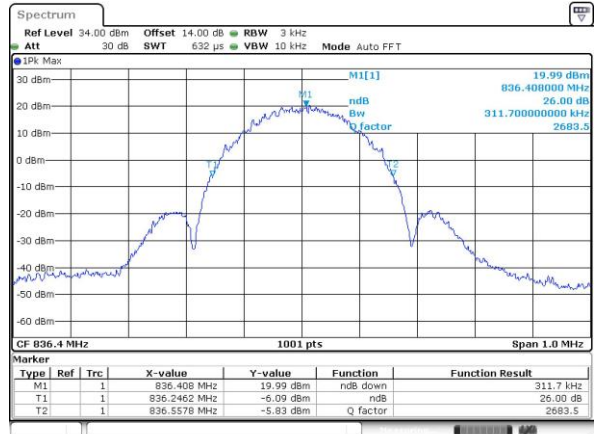

Date: 22\_JUL\_2022 14:34:27

Highest Channel

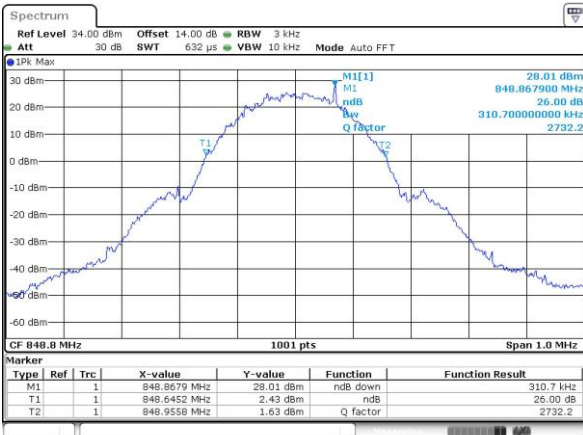

Date: 22\_JUL\_2022 11:46:05

Highest Channel

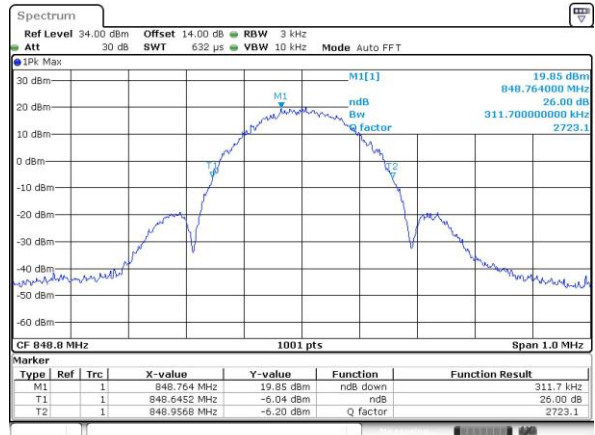

Date: 22\_JUL\_2022 14:34:57



GSM1900 (GSM)

Lowest Channel

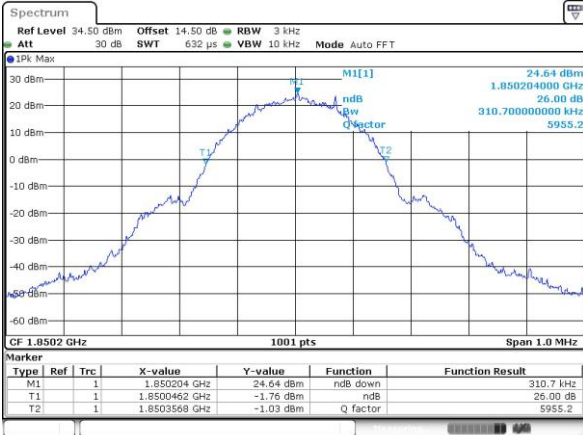

Date: 22\_JUL\_2022 11:26:14

GSM1900 (EDGE class 8)

Lowest Channel

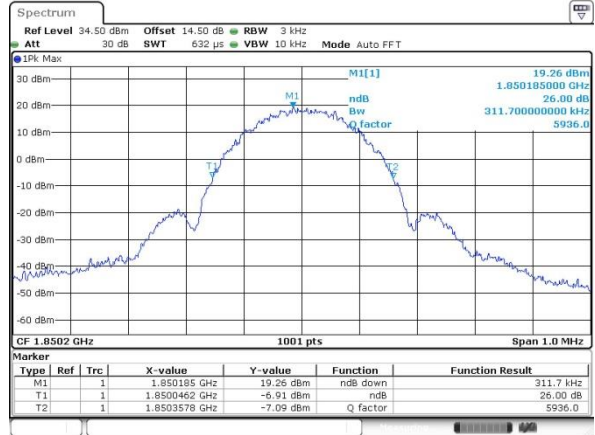

Date: 22\_JUL\_2022 15:02:07

Middle Channel

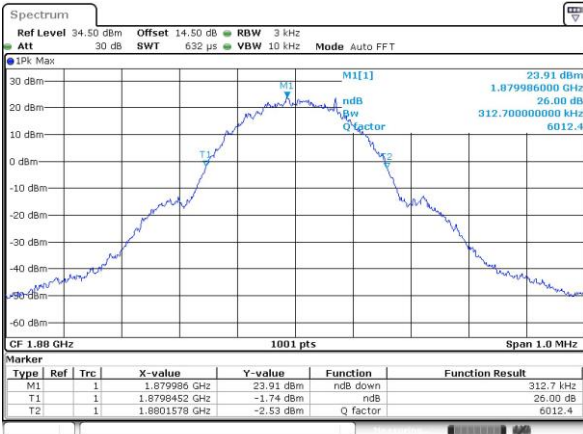

Date: 22\_JUL\_2022 11:26:37

Middle Channel

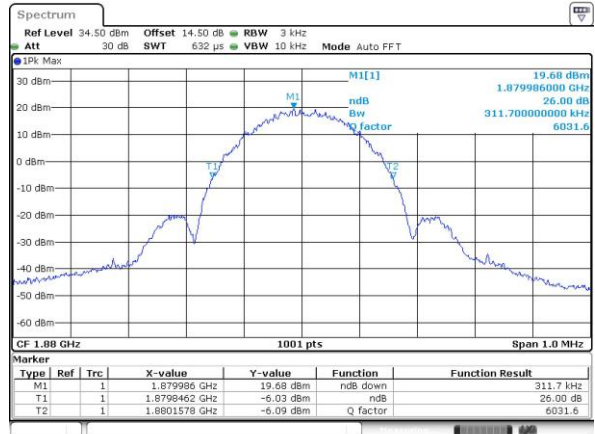

Date: 22\_JUL\_2022 15:02:27

Highest Channel

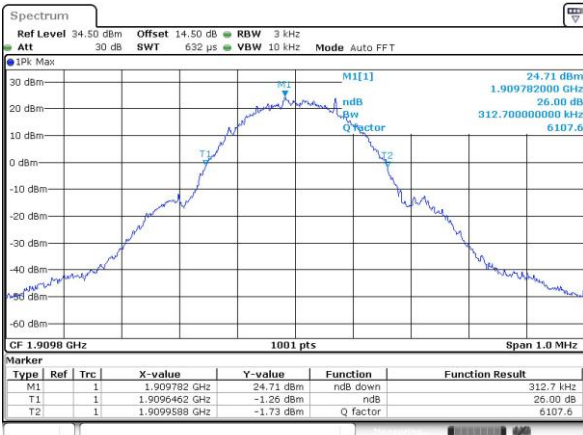

Date: 22\_JUL\_2022 11:26:59

Highest Channel

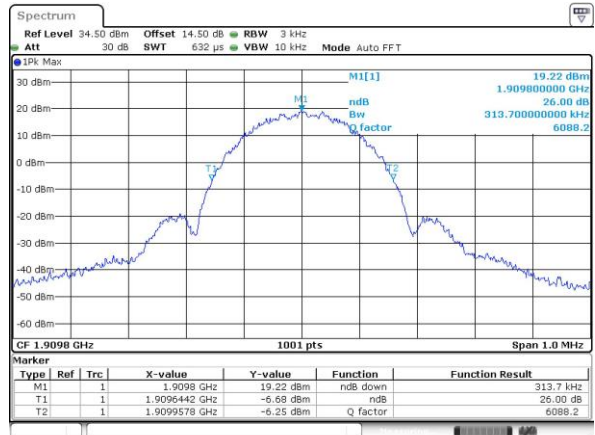

Date: 22\_JUL\_2022 15:02:53



### Occupied Bandwidth

Mode	GSM850(MHz)	
Mod.	GSM	EDGE class 8
Lowest CH	0.244	0.245
Middle CH	0.243	0.246
Highest CH	0.242	0.244

Mode	GSM1900(MHz)	
Mod.	GSM	EDGE class 8
Lowest CH	0.244	0.245
Middle CH	0.244	0.248
Highest CH	0.243	0.247



GSM850 (GSM)

Lowest Channel

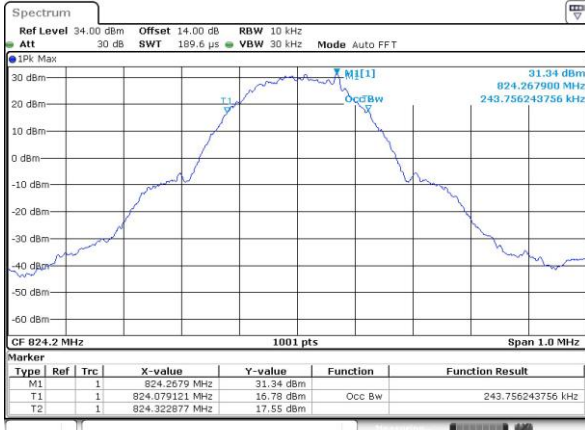

Date: 22\_JUL\_2022 11:46:35

GSM850 (EDGE class 8)

Lowest Channel

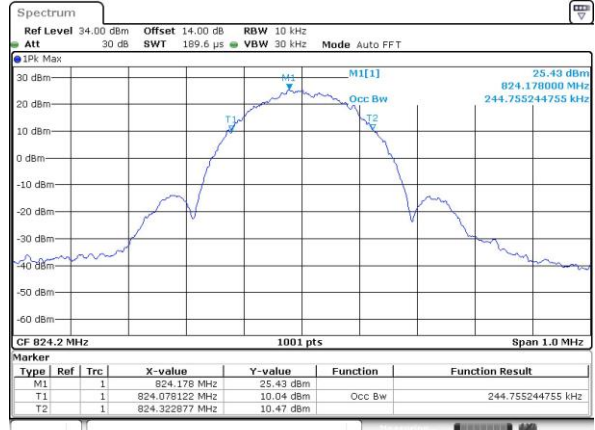

Date: 22\_JUL\_2022 14:35:49

Middle Channel

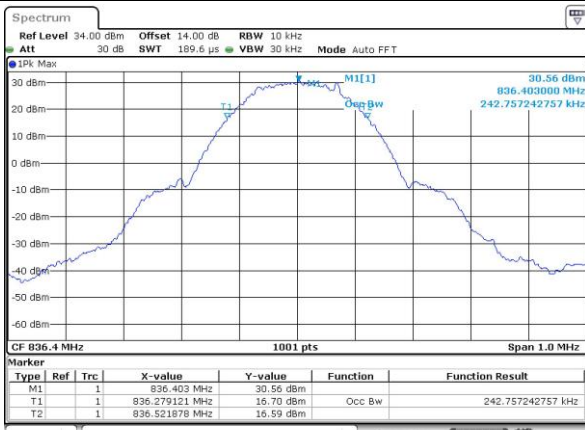

Date: 22\_JUL\_2022 11:46:57

Middle Channel

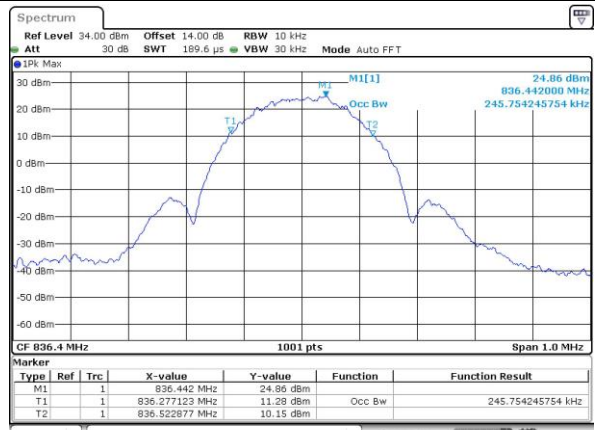

Date: 22\_JUL\_2022 14:36:17

Highest Channel

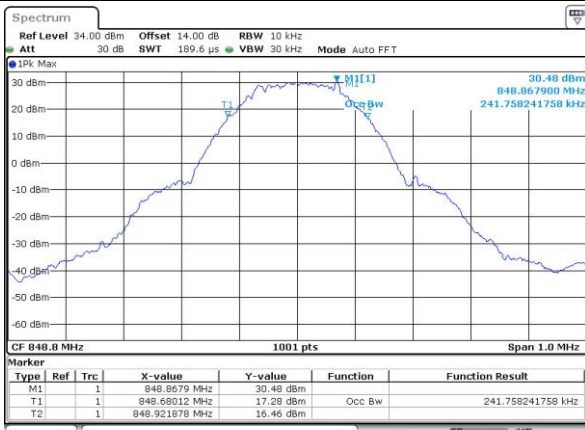

Date: 22\_JUL\_2022 11:47:18

Highest Channel

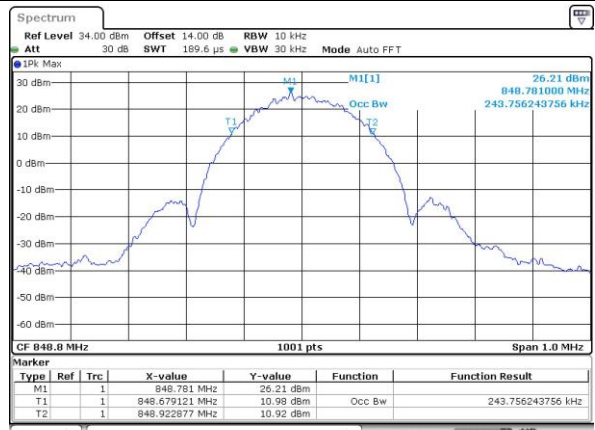

Date: 22\_JUL\_2022 14:36:47



GSM1900 (GSM)

Lowest Channel

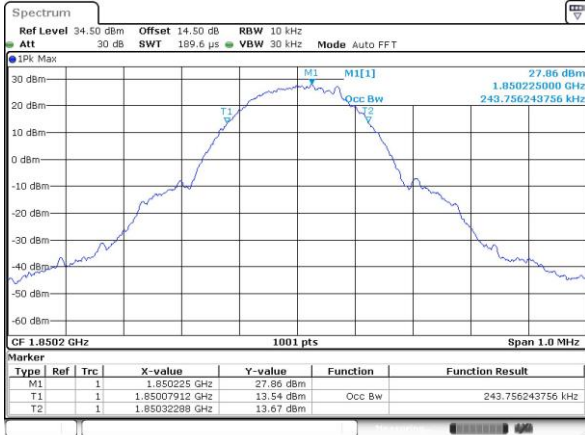

Date: 22\_JUL\_2022 11:27:25

GSM1900 (EDGE class 8)

Lowest Channel



Date: 22\_JUL\_2022 15:03:27

Middle Channel

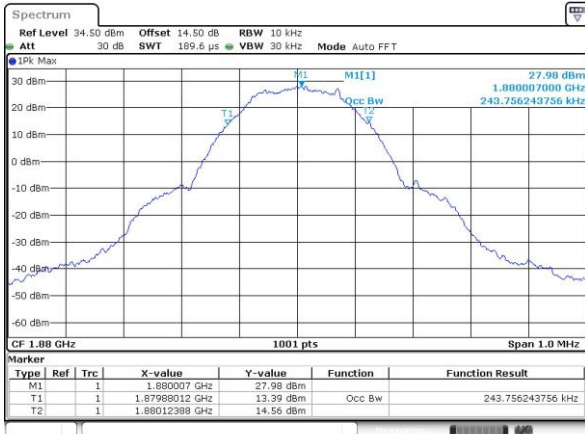

Date: 22\_JUL\_2022 11:27:47

Middle Channel

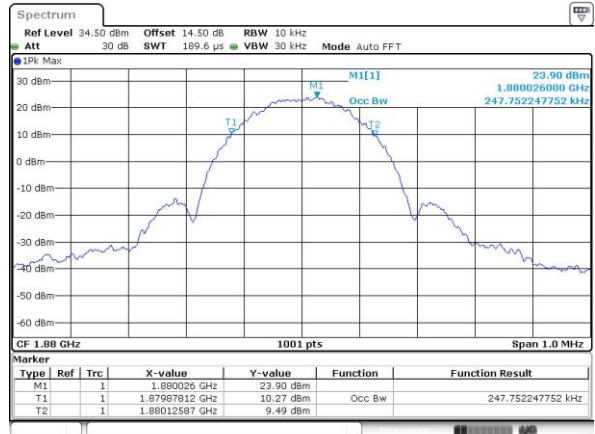

Date: 22\_JUL\_2022 15:03:49

Highest Channel

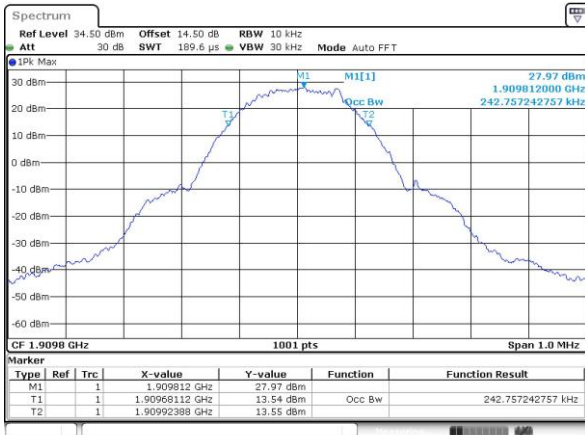

Date: 22\_JUL\_2022 11:28:11

Highest Channel

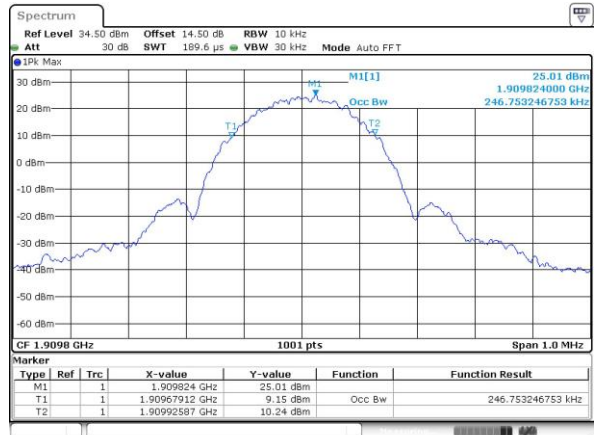

Date: 22\_JUL\_2022 15:04:11



# Conducted Band Edge

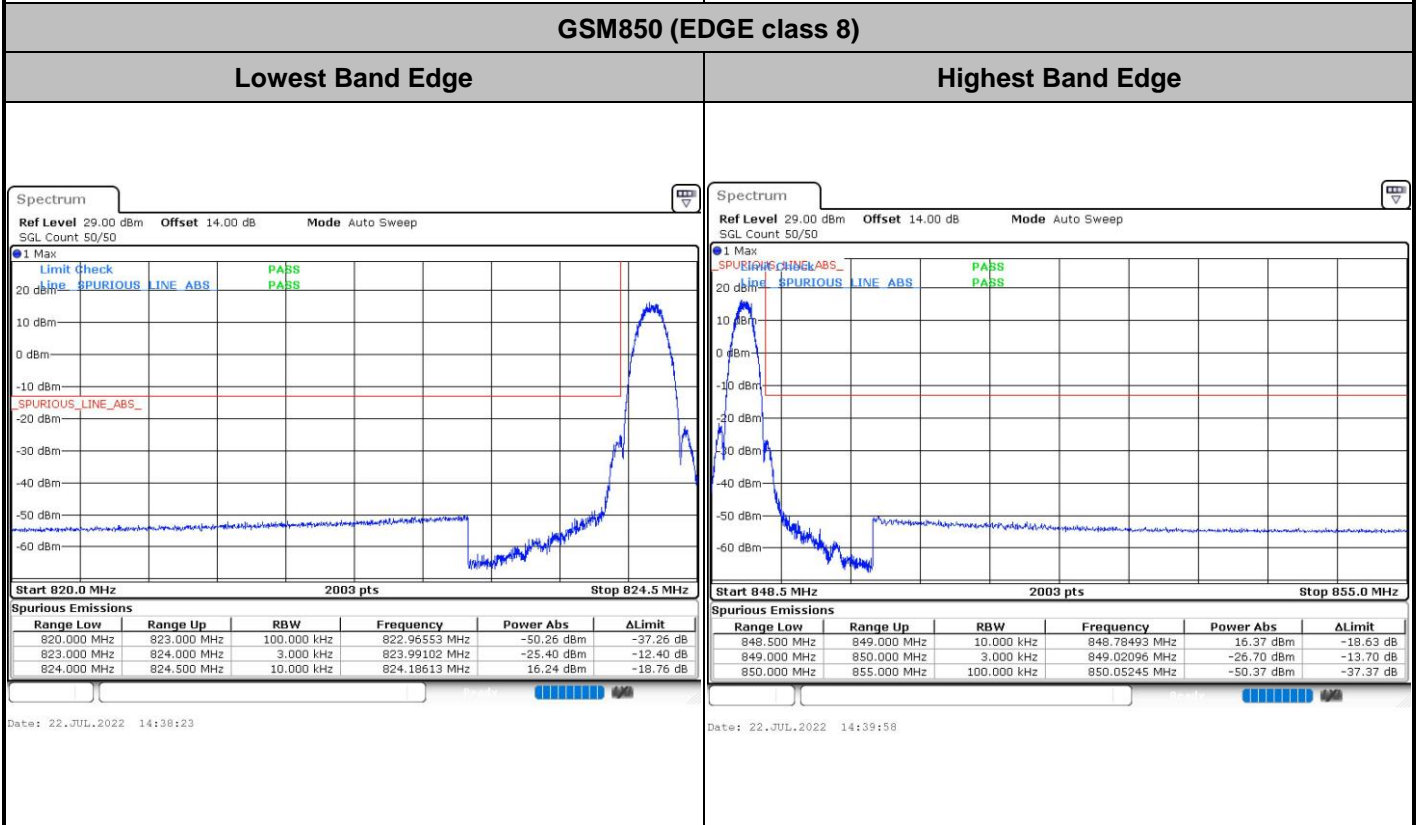
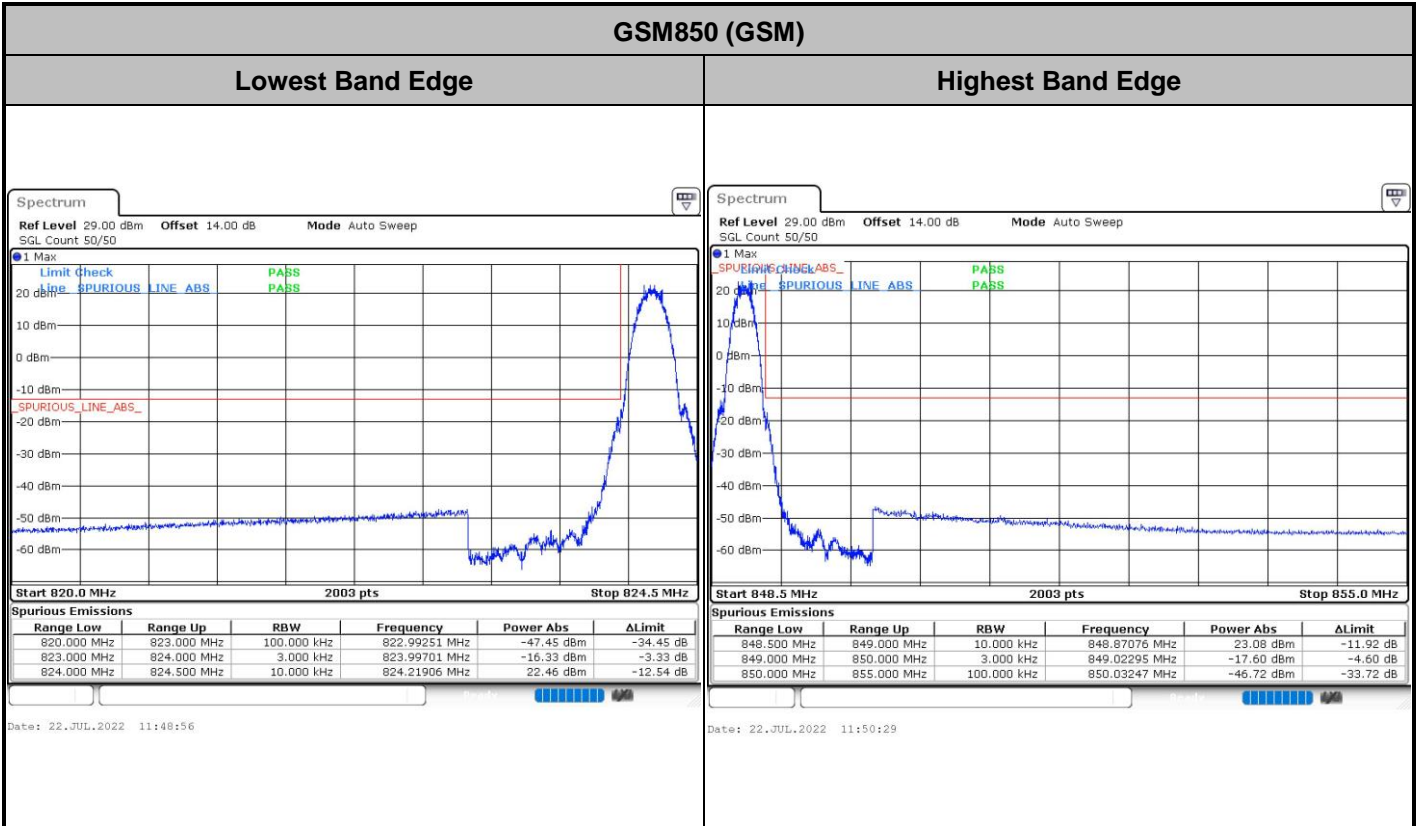



GSM1900 (GSM)

Lowest Band Edge

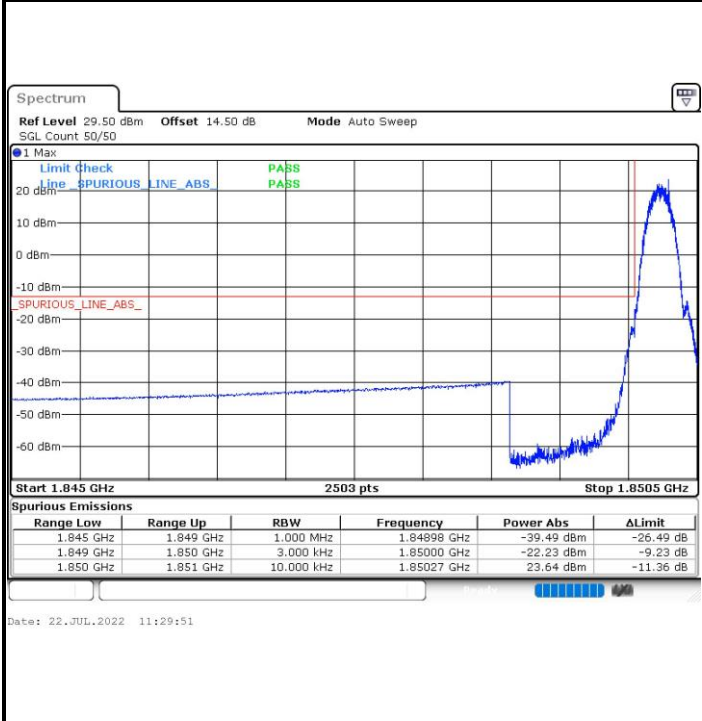

Highest Band Edge

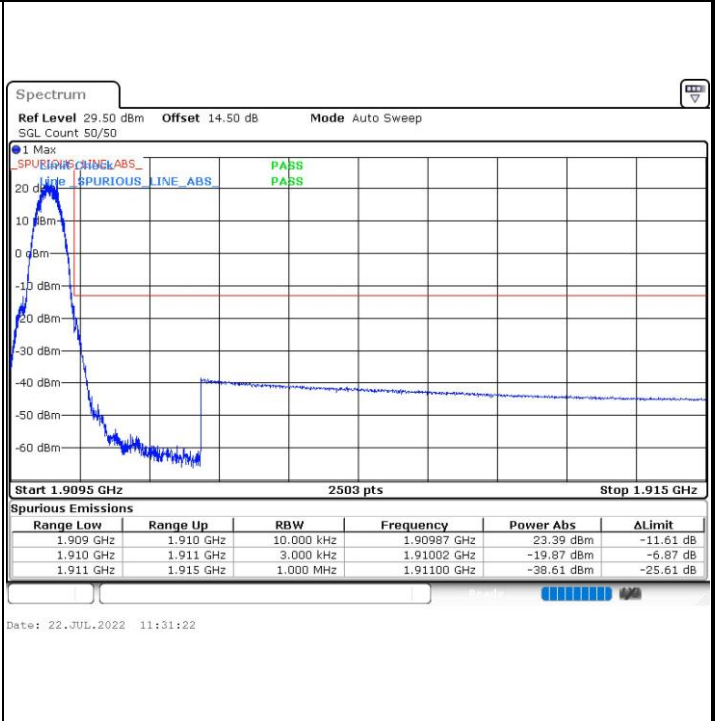

GSM1900 (EDGE class 8)

Lowest Band Edge

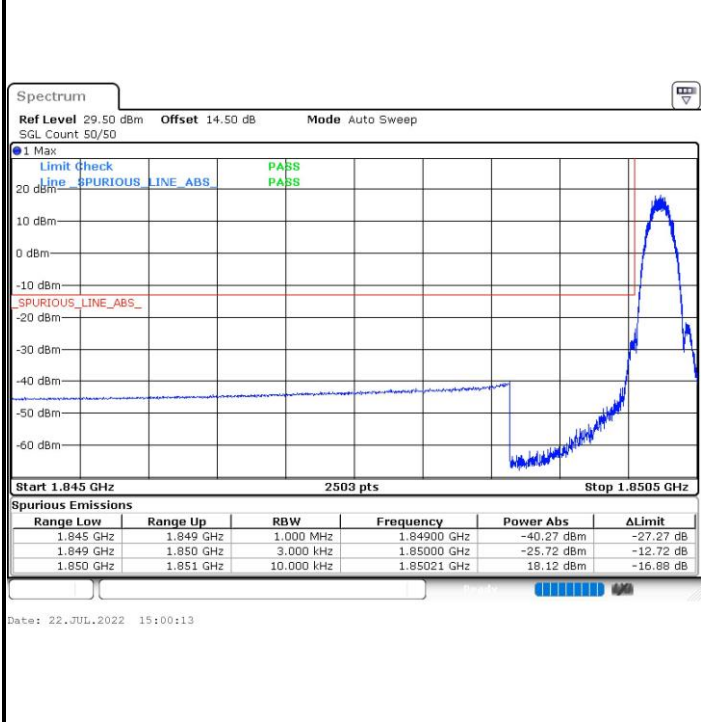

Highest Band Edge

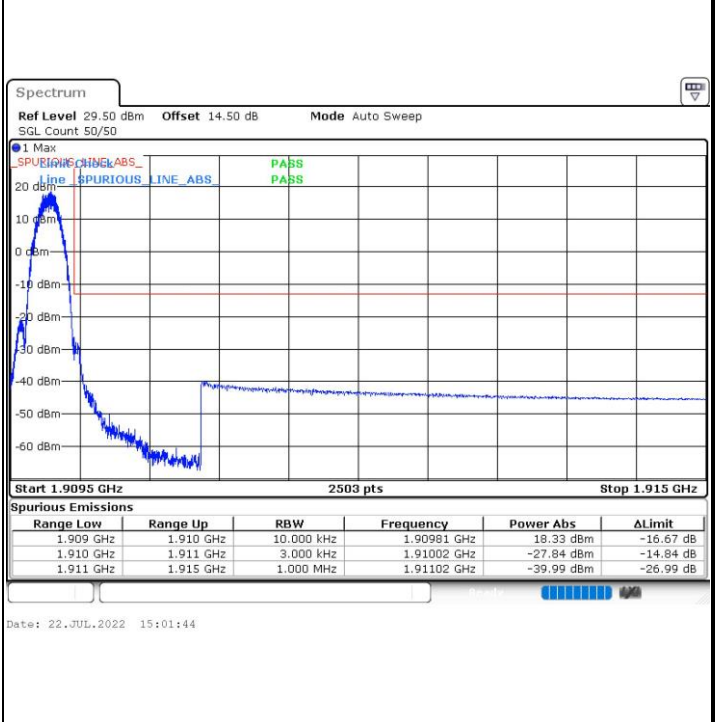





# Conducted Spurious Emission

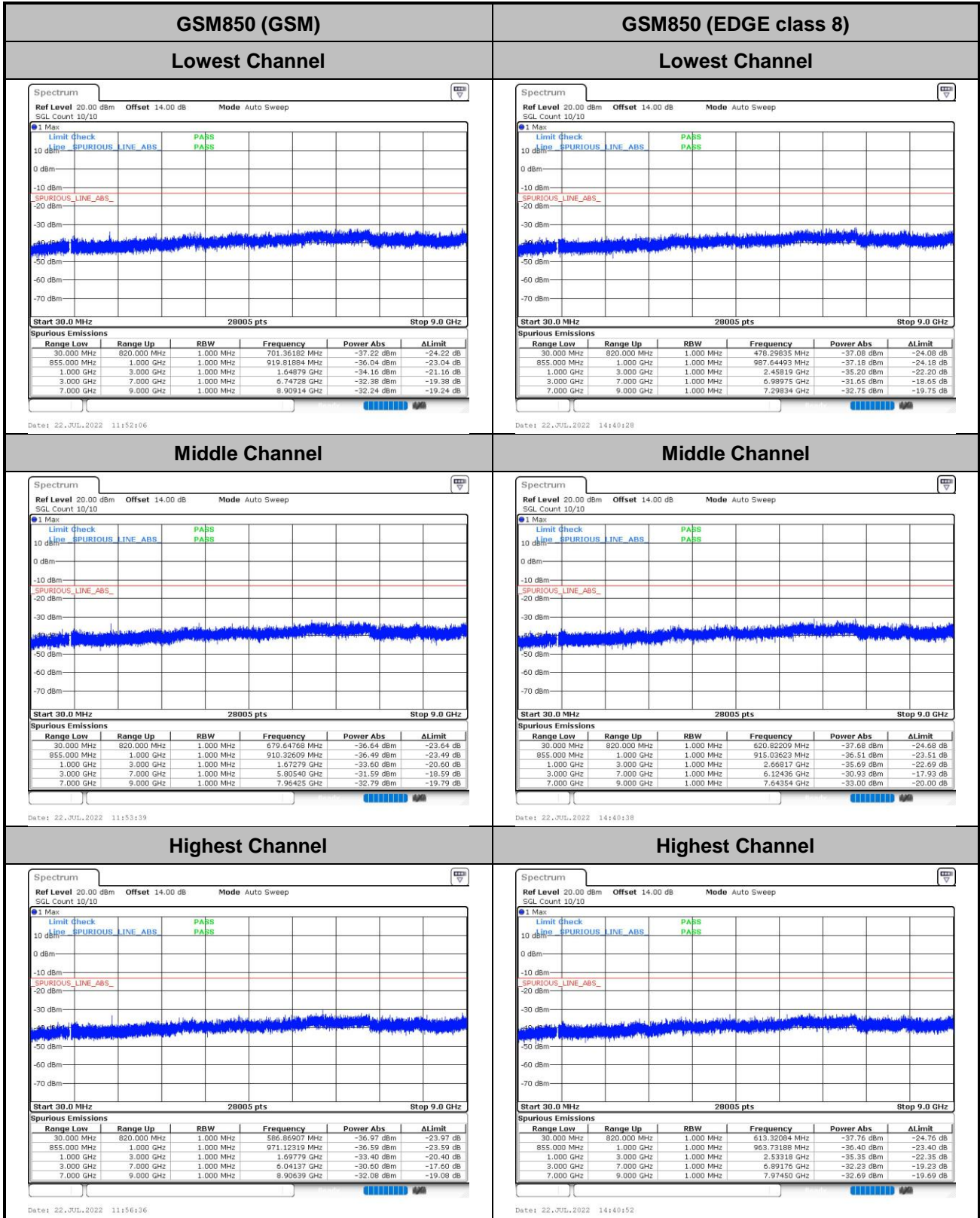



GSM1900 (GSM)

Lowest Channel

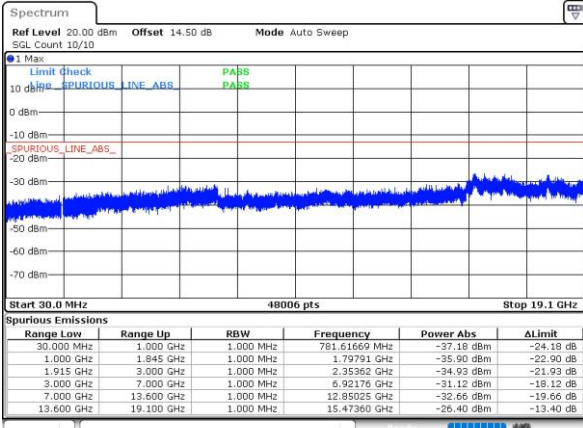

GSM1900 (EDGE class 8)

Lowest Channel

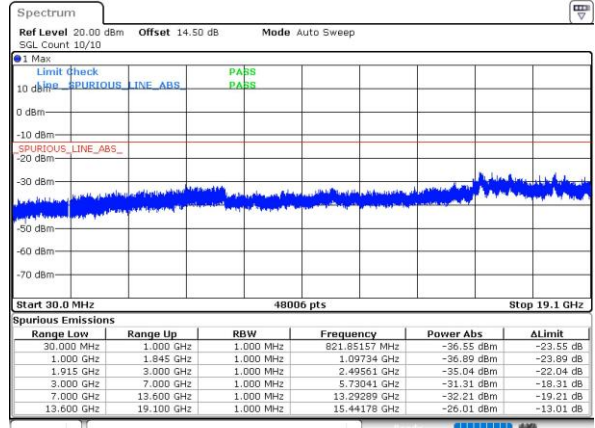

Middle Channel

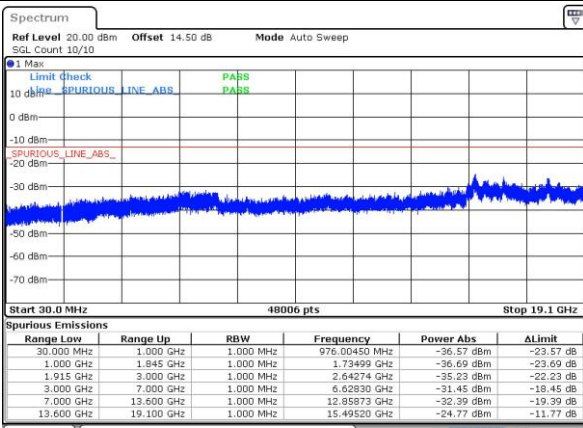

Middle Channel

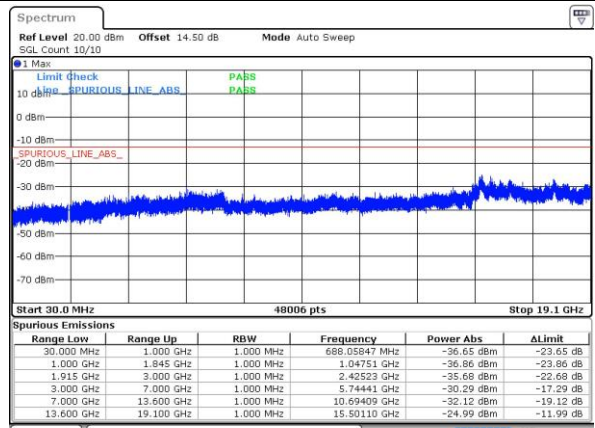

Highest Channel

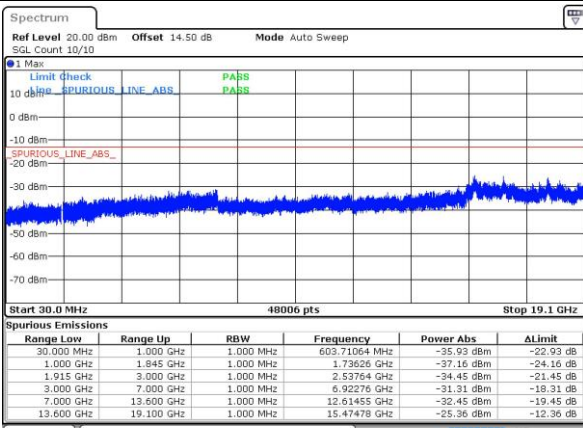

Highest Channel

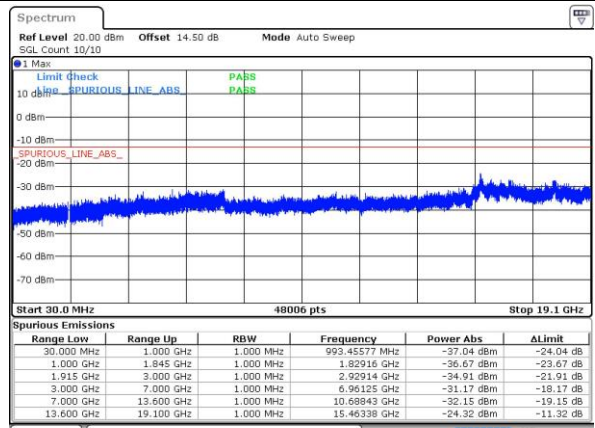



**Frequency Stability**

Test Conditions	Middle Channel	GSM850 (GSM)	GSM850 (EDGE class 8)	Limit 2.5ppm
Temperature (°C)	Voltage (Volt)	Deviation (ppm)		Result
50	Normal Voltage	0.0006	0.0012	PASS
40	Normal Voltage	0.0010	0.0001	
30	Normal Voltage	0.0013	0.0011	
20(Ref.)	Normal Voltage	0.0000	0.0000	
10	Normal Voltage	0.0001	0.0001	
0	Normal Voltage	0.0001	0.0006	
-10	Normal Voltage	0.0005	0.0007	
-20	Normal Voltage	0.0001	0.0005	
-30	Normal Voltage	0.0007	0.0004	
20	Maximum Voltage	0.0012	0.0012	
20	Normal Voltage	0.0000	0.0000	
20	Battery End Point	0.0014	0.0010	

Test Conditions	Middle Channel	GSM1900 (GSM)	GSM1900 (EDGE class 8)	Limit Note 2.
Temperature (°C)	Voltage (Volt)	Deviation (ppm)		Result
50	Normal Voltage	0.0009	0.0007	PASS
40	Normal Voltage	0.0011	0.0002	
30	Normal Voltage	0.0005	0.0004	
20(Ref.)	Normal Voltage	0.0000	0.0000	
10	Normal Voltage	0.0003	0.0001	
0	Normal Voltage	0.0002	0.0006	
-10	Normal Voltage	0.0005	0.0001	
-20	Normal Voltage	0.0010	0.0004	
-30	Normal Voltage	0.0004	0.0005	
20	Maximum Voltage	0.0010	0.0005	
20	Normal Voltage	0.0000	0.0000	
20	Battery End Point	0.0007	0.0011	

**Note:**

1. Normal Voltage = 3.87V. ; Battery End Point (BEP) = 3.6 V. ; Maximum Voltage =4.45 V
2. The frequency fundamental emissions stay within the authorized frequency block based on the frequency deviation measured is small.



## A2. WCDMA

### Peak-to-Average Ratio

Mode	WCDMA Band V(dB)	WCDMA Band II(dB)	WCDMA Band IV(dB)	Limit: 13dB
Mod.	RMC 12.2Kbps	RMC 12.2Kbps	RMC 12.2Kbps	Result
Lowest CH	2.87	3.19	2.96	<b>PASS</b>
Middle CH	2.52	3.22	3.51	
Highest CH	2.75	3.16	2.87	

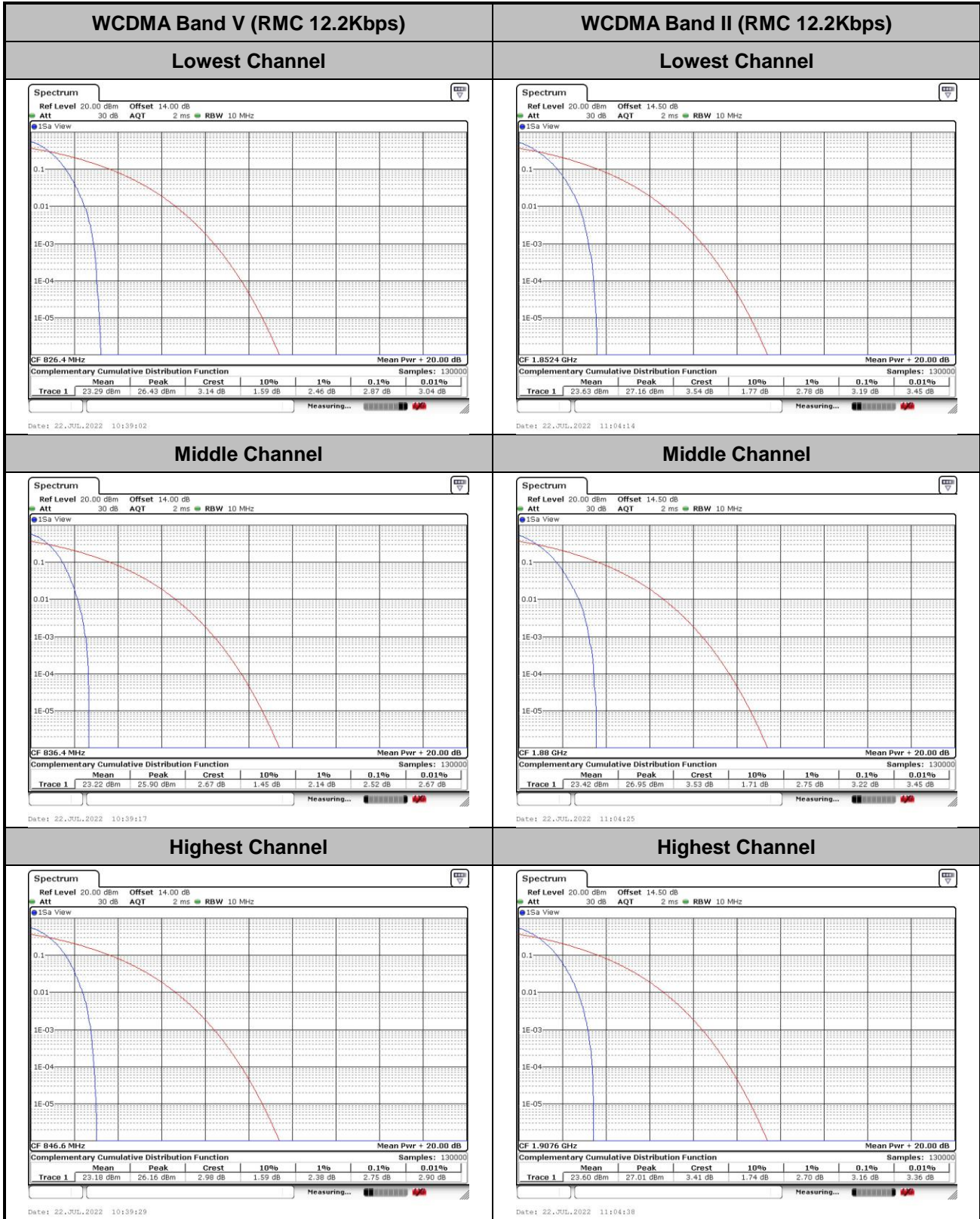



WCDMA Band IV (RMC 12.2Kbps)

Lowest Channel

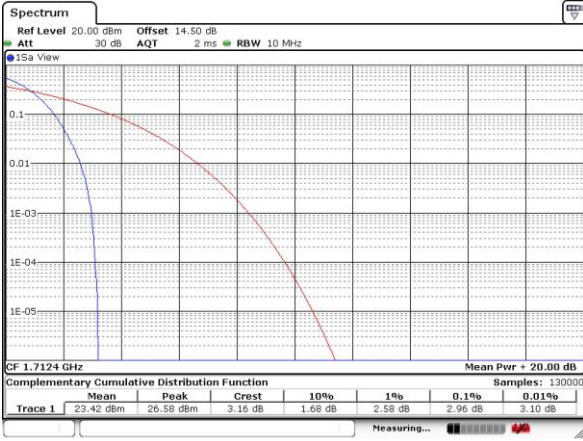

Middle Channel

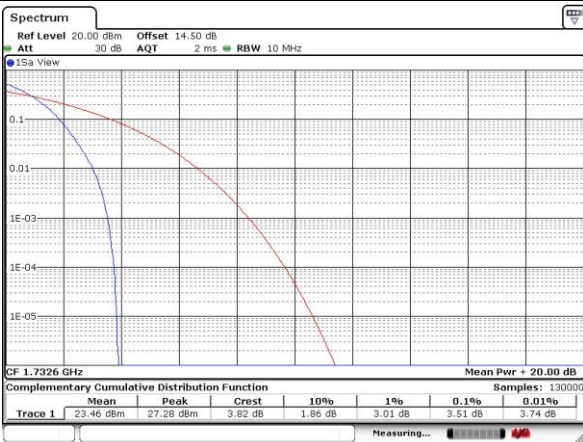

Highest Channel

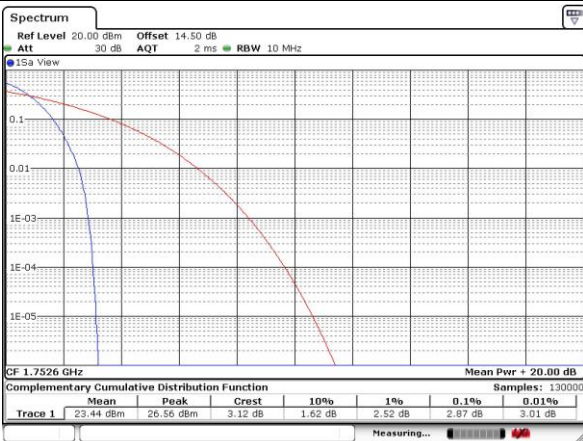



**26dB Bandwidth**

Mode	WCDMA Band V(MHz)	WCDMA Band II(MHz)	WCDMA Band IV(MHz)
Mod.	RMC 12.2Kbps	RMC 12.2Kbps	RMC 12.2Kbps
Lowest CH	4.73	4.69	4.71
Middle CH	4.76	4.71	4.68
Highest CH	4.74	4.70	4.72



WCDMA Band V (RMC 12.2Kbps)

Lowest Channel

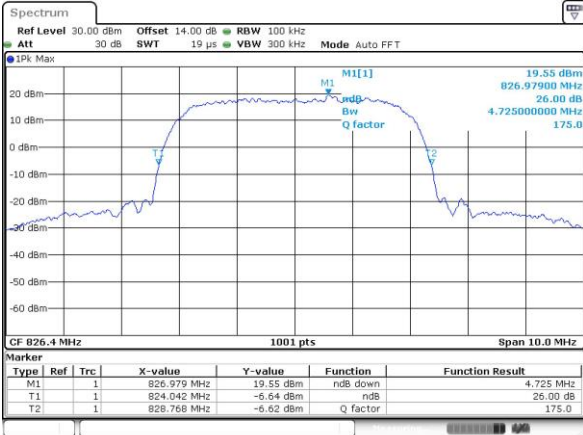

WCDMA Band II (RMC 12.2Kbps)

Lowest Channel

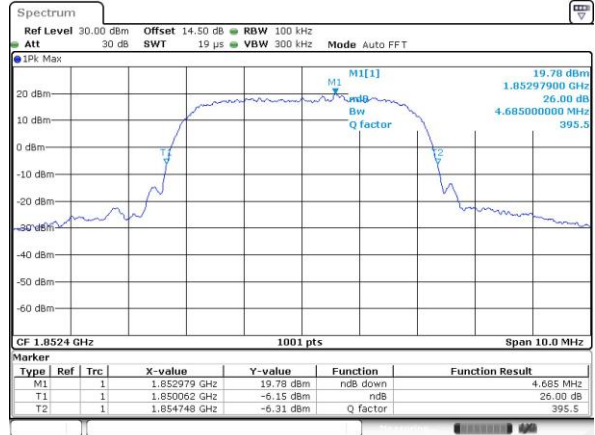

Middle Channel

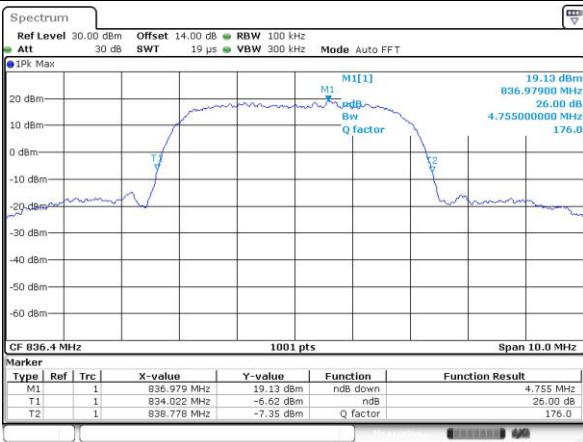

Middle Channel

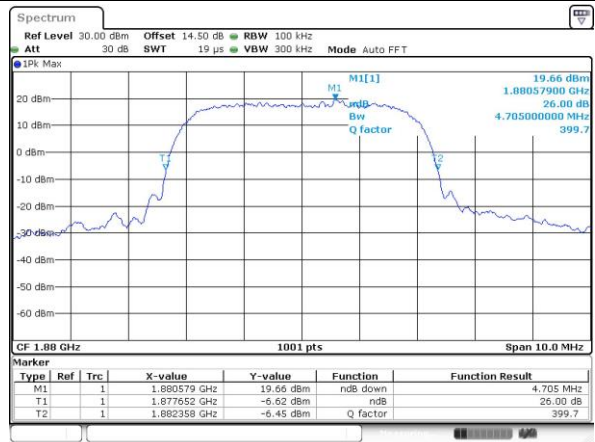

Highest Channel

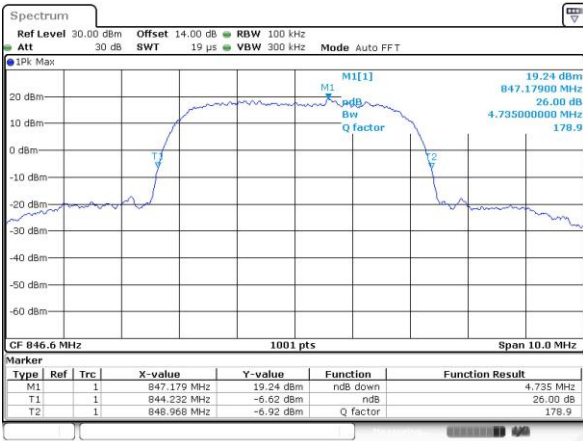

Highest Channel

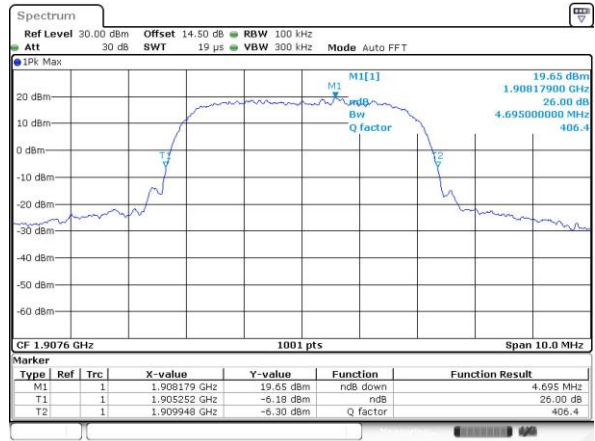





WCDMA Band IV (RMC 12.2Kbps)

Lowest Channel

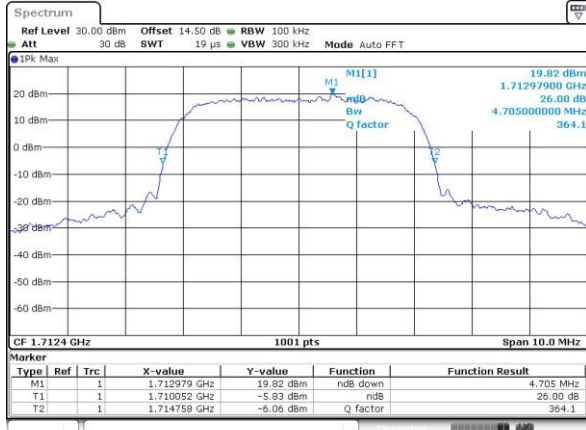

Date: 22\_JUL\_2022 11:05:27

Middle Channel

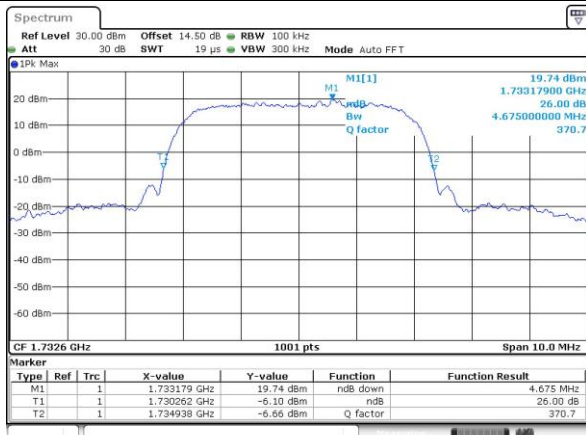

Date: 22\_JUL\_2022 11:06:08

Highest Channel

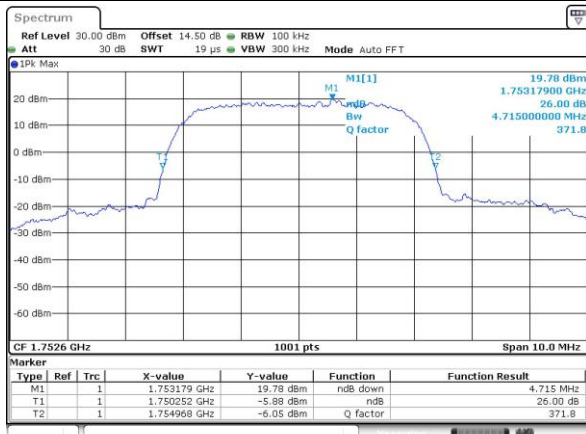

Date: 22\_JUL\_2022 11:07:00



## Occupied Bandwidth

Mode	WCDMA Band V(MHz)	WCDMA Band II(MHz)	WCDMA Band IV(MHz)
Mod.	RMC 12.2Kbps	RMC 12.2Kbps	RMC 12.2Kbps
Lowest CH	4.12	4.12	4.11
Middle CH	4.14	4.11	4.11
Highest CH	4.13	4.11	4.12