



FCC RF Test Report

APPLICANT : vivo Mobile Communication Co., Ltd.
EQUIPMENT : Mobile Phone
BRAND NAME : vivo
MODEL NAME : V2205
FCC ID : 2AUCY-V2205
STANDARD : 47 CFR Part 2, 27(M)
CLASSIFICATION : PCS Licensed Transmitter Held to Ear (PCE)
TEST DATE(S) : Jul. 16, 2022 ~ Jul. 22, 2022

We, Sporton International Inc. (Kunshan), would like to declare that the tested sample has been evaluated in accordance with the procedures given in ANSI C63.26-2015 and shown compliance with the applicable technical standards.

The test results in this report apply exclusively to the tested model / sample. Without written approval of Sporton International Inc. (Kunshan), the test report shall not be reproduced except in full.

Jason Jia



Approved by: Jason Jia

Sporton International Inc. (ShenZhen)

1/F, 2/F, Bldg 5, Shiling Industrial Zone, Xinwei Village, Xili, Nanshan, Shenzhen, 518055

People's Republic of China



TABLE OF CONTENTS

REVISION HISTORY 3
SUMMARY OF TEST RESULT 4
1 GENERAL DESCRIPTION 5
1.1 Applicant 5
1.2 Manufacturer 5
1.3 Product Feature of Equipment Under Test 5
1.4 Product Specification of Equipment Under Test 5
1.5 Modification of EUT 6
1.6 Maximum EIRP Power and Emission Designator 6
1.7 Testing Location 8
1.8 Test Software 8
1.9 Applicable Standards 9
2 TEST CONFIGURATION OF EQUIPMENT UNDER TEST 10
2.1 Test Mode 10
2.2 Connection Diagram of Test System 12
2.3 Support Unit used in test configuration and system 12
2.4 Measurement Results Explanation Example 12
2.5 Frequency List of Low/Middle/High Channels 13
3 CONDUCTED TEST ITEMS 17
3.1 Measuring Instruments 17
3.2 Test Setup 17
3.3 Test Result of Conducted Test 17
3.4 Conducted Output Power and EIRP 18
3.5 Peak-to-Average Ratio 19
3.6 Occupied Bandwidth 20
3.7 Conducted Band Edge 21
3.8 Conducted Spurious Emission 22
3.9 Frequency Stability 23
4 RADIATED TEST ITEMS 24
4.1 Measuring Instruments 24
4.2 Test Setup 24
4.3 Test Result of Radiated Test 25
4.4 Radiated Spurious Emission 26
5 LIST OF MEASURING EQUIPMENT 27
6 UNCERTAINTY OF EVALUATION 28
APPENDIX A. TEST RESULTS OF CONDUCTED TEST
APPENDIX B. TEST RESULTS OF RADIATED TEST
APPENDIX C. TEST SETUP PHOTOGRAPHS



SUMMARY OF TEST RESULT

Report Section	FCC Rule	Description	Limit	Result	Remark
3.4	§2.1046	Conducted Output Power	-	Report Only	-
	§27.50(h)(2)	Equivalent Isotropic Radiated Power (Band 7) (Band 38) (Band 41)	EIRP < 2Watt	PASS	-
3.5	N/A	Peak-to-Average Ratio	<13 dB	PASS	-
3.6	§2.1049	Occupied Bandwidth	-	Report Only	-
3.7	§27.53(m)(4)	Conducted Band Edge Measurement (Band 7) (Band 38) (Band 41)	§27.53(m)(4)	PASS	
3.8	§2.1051 §27.53(m)(4)	Conducted Spurious Emission (Band 7) (Band 38) (Band 41)	< 55+10log ₁₀ (P[Watts])	PASS	
3.9	§2.1055 §27.54	Frequency Stability Temperature & Voltage	Within Authorized Band	PASS	-
4.4	§2.1053 §27.53(m)(4)	Radiated Spurious Emission (Band 7) (Band 38) (Band 41)	< 43+10log ₁₀ (P[Watts])	PASS	Under limit 28.75 dB at 10140.000 MHz

Declaration of Conformity:

The test results with all measurement uncertainty excluded are presented in accordance with the regulation limits or requirements declared by manufacturers.

Comments and Explanations:

The declared of product specification for EUT presented in the report are provided by the manufacturer, and the manufacturer takes all the responsibilities for the accuracy of product specification.



1 General Description

1.1 Applicant

vivo Mobile Communication Co., Ltd.
No.1, vivo Road, Chang'an, Dongguan,Guangdong,China

1.2 Manufacturer

vivo Mobile Communication Co., Ltd.
No.1, vivo Road, Chang'an, Dongguan,Guangdong,China

1.3 Product Feature of Equipment Under Test

Product Feature	
Equipment	Mobile Phone
Brand Name	vivo
Model Name	V2205
FCC ID	2AUCY-V2205
IMEI Code	Conducted: 863507069988418/863507069988400 Radiation: 863507069986156/863507069986149
HW Version	MP_0.1
SW Version	PD2225IF_EX_A_12.0.3.3.W30.V000L1

1.4 Product Specification of Equipment Under Test

Standards-related Product Specification	
Tx Frequency	LTE Band 7 : 2500 MHz ~ 2570 MHz LTE Band 38 : 2570 MHz ~ 2620 MHz LTE Band 41 : 2496 MHz ~ 2690 MHz
Rx Frequency	LTE Band 7 : 2620 MHz ~ 2690 MHz LTE Band 38: 2570 MHz ~ 2620 MHz LTE Band 41 : 2496 MHz ~ 2690 MHz
Bandwidth	LTE Band 7 : 5MHz/ 10MHz / 15MHz / 20MHz LTE Band 38 : 5MHz / 10MHz / 15MHz / 20MHz LTE Band 41 : 5MHz / 10MHz / 15MHz / 20MHz
Maximum Output Power to Antenna	Ant. 13: LTE Band 7 : 23.47 dBm / LTE Band 7C : 23.29 dBm LTE Band 38 : 23.43 dBm LTE Band 41 : 23.44 dBm / LTE Band 41C: 23.14 dBm Ant. 31: LTE Band 7 : 23.19 dBm / LTE Band 7C : 23.08 dBm LTE Band 38 : 23.15 dBm LTE Band 41 : 23.13 dBm / LTE Band 41C: 22.89 dBm
Antenna Gain	Ant. 13: LTE Band 7 : 0.99 dBi LTE Band 38 : 1.12 dBi



	LTE Band 41 : 1.15 dBi Ant. 31: LTE Band 7 : 0.62 dBi LTE Band 38 : 0.62 dBi LTE Band 41 : 0.68 dBi
Type of Modulation	QPSK / 16QAM / 64QAM

Note: The maximum EIRP is calculated from max output power and antenna gain, only the maximum EIRP of antenna 13 is shown in the report.

1.5 Modification of EUT

No modifications are made to the EUT during all test items.

1.6 Maximum EIRP Power and Emission Designator

LTE Band 7		QPSK		16QAM/64QAM	
BW (MHz)	Frequency Range (MHz)	Maximum EIRP(W)	Emission Designator (99%OBW)	Maximum EIRP(W)	Emission Designator (99%OBW)
5	2502.5 ~ 2567.5	0.2716	4M51G7D	0.2339	4M54W7D
10	2505.0 ~ 2565.0	0.2698	9M09G7D	0.2286	9M07W7D
15	2507.5 ~ 2562.5	0.2698	13M4G7D	0.2286	13M5W7D
20	2510.0 ~ 2560.0	0.2793	18M0G7D	0.2360	17M9W7D
LTE Band 38		QPSK		16QAM/64QAM	
BW (MHz)	Frequency Range (MHz)	Maximum EIRP(W)	Emission Designator (99%OBW)	Maximum EIRP(W)	Emission Designator (99%OBW)
5	2572.5 ~ 2617.5	0.2838	4M51G7D	0.2291	4M54W7D
10	2575.0 ~ 2615.0	0.2844	9M09G7D	0.2307	9M07W7D
15	2577.5 ~ 2612.5	0.2844	13M4G7D	0.2312	13M5W7D
20	2580.0 ~ 2610.0	0.2851	18M0G7D	0.2323	17M9W7D
LTE Band 41		QPSK		16QAM/64QAM	
BW (MHz)	Frequency Range (MHz)	Maximum EIRP(W)	Emission Designator (99%OBW)	Maximum EIRP(W)	Emission Designator (99%OBW)
5	2498.5 ~ 2687.5	0.2761	4M51G7D	0.2163	4M49W7D
10	2501.0 ~ 2685.0	0.2729	9M05G7D	0.2173	9M09W7D
15	2503.5 ~ 2682.5	0.2812	13M4G7D	0.2213	13M6W7D
20	2506.0 ~ 2680.0	0.2877	17M9G7D	0.2213	17M9W7D



LTE Band 7 CA	QPSK		16QAM/64QAM	
BW (MHz)	Maximum EIRP(W)	Emission Designator (99%OBW)	Maximum EIRP(W)	Emission Designator (99%OBW)
10MHz+20MHz	0.2649	28M1G7D	0.2118	28M2W7D
15MHz+15MHz	0.2618	28M7G7D	0.2075	28M8W7D
15MHz+20MHz	0.2600	32M8G7D	0.2051	32M7W7D
20MHz+10MHz	0.2455	28M1G7D	0.2080	28M1W7D
20MHz+15MHz	0.2679	32M7G7D	0.2123	33M1W7D
20MHz+20MHz	0.2667	37M6G7D	0.2128	37M6W7D
LTE Band 41 CA	QPSK		16QAM/64QAM	
BW (MHz)	Maximum EIRP(W)	Emission Designator (99%OBW)	Maximum EIRP(W)	Emission Designator (99%OBW)
5MHz+20MHz	0.2594	23M3G7D	0.2286	23M4W7D
10MHz+20MHz	0.2612	28M1G7D	0.2301	28M2W7D
10MHz+15MHz	0.2649	23M6G7D	0.2307	23M4W7D
15MHz+15MHz	0.2649	28M5G7D	0.2234	28M5W7D
15MHz+20MHz	0.2679	32M9G7D	0.2270	32M9W7D
15MHz+10MHz	0.2649	23M5G7D	0.2296	23M5W7D
20MHz+5MHz	0.2642	23M4G7D	0.2301	23M2W7D
20MHz+10MHz	0.2618	28M2G7D	0.2259	28M2W7D
20MHz+15MHz	0.2685	32M7G7D	0.2301	32M8W7D
20MHz+20MHz	0.2673	37M6G7D	0.2307	37M4W7D

Note:

1. LTE Band 41 overlaps the entire frequency range of LTE Band 38. Therefore, the test results provided in this report covers Band 41 as well as Band 38.
2. All modulations have been tested, and only the worst test results of PSK & QAM are shown in the report.



1.7 Testing Location

Sporton International Inc. (Shenzhen) is accredited to ISO/IEC 17025:2017 by American Association for Laboratory Accreditation with Certificate Number 5145.01.

Test Firm	Sporton International Inc. (Shenzhen)		
Test Site Location	1/F, 2/F, Bldg 5, Shiling Industrial Zone, Xinwei Village, Xili, Nanshan, Shenzhen, 518055 People's Republic of China TEL: +86-755-86379589 FAX: +86-755-86379595		
Test Site No.	Sporton Site No.	FCC Designation No.	FCC Test Firm Registration No.
	TH01-SZ	CN1256	421272

Test Firm	Sporton International Inc. (Shenzhen)		
Test Site Location	101, 1st Floor, Block B, Building 1, No. 2, Tengfeng 4th Road, Fenghuang Community, Fuyong Street, Baoan District, Shenzhen City Guangdong Province China 518103 TEL: +86-755-33202398		
Test Site No.	Sporton Site No.	FCC Designation No.	FCC Test Firm Registration No.
	03CH03-SZ	CN1256	421272

1.8 Test Software

Item	Site	Manufacture	Name	Version
1.	03CH03-SZ	AUDIX	E3	6.2009-8-24



1.9 Applicable Standards

According to the specifications of the manufacturer, the EUT must comply with the requirements of the following standards:

- ♦ 47 CFR Part 2, 27(M)
- ♦ ANSI C63.26-2015
- ♦ FCC KDB 971168 D01 Power Meas License Digital Systems v03r01
- ♦ FCC KDB 412172 D01 Determining ERP and EIRP v01r01

Remark:

1. All test items were verified and recorded according to the standards and without any deviation during the test.
2. This EUT has also been tested and complied with the requirements of FCC Part 15, Subpart B, recorded in a separate test report.



2 Test Configuration of Equipment Under Test

2.1 Test Mode

Antenna port conducted and radiated test items listed below are performed according to KDB 971168 D01 Power Meas License Digital Systems v03r01 with maximum output power.

Radiated measurements are performed by rotating the EUT in three different orthogonal test planes to find the maximum emission. (X-Plane)

Test Items	Band	Bandwidth (MHz)						Modulation			RB #			Test Channel			
		1.4	3	5	10	15	20	QPSK	16QAM	64QAM	1	Half	Full	L	M	H	
Max. Output Power	7	-	-	v	v	v	v	v	v	v	v	v	v	v	v	v	
	38	-	-	v	v	v	v	v	v	v	v	v	v	v	v	v	
	41	-	-	v	v	v	v	v	v	v	v	v	v	v	v	v	
Peak-to-Average Ratio	7	-	-				v	v	v	v	v		v	v	v	v	
	38	-	-				v	v	v	v	v		v	v	v	v	
	41	-	-				v	v	v	v	v		v	v	v	v	
26dB and 99% Bandwidth	7	-	-	v	v	v	v	v	v	v			v	v	v	v	
	38	-	-	v	v	v	v	v	v	v			v	v	v	v	
	41	-	-	v	v	v	v	v	v	v			v	v	v	v	
Conducted Band Edge	7	-	-	v	v	v	v	v	v	v	v		v	v		v	
	38	-	-	v	v	v	v	v	v	v	v		v	v		v	
	41	-	-	v	v	v	v	v	v	v	v		v	v		v	
Conducted Spurious Emission	7	-	-	v	v	v	v	v	v	v	v			v	v	v	
	38	-	-	v	v	v	v	v	v	v	v			v	v	v	
	41	-	-	v	v	v	v	v	v	v	v			v	v	v	
Frequency Stability	7	-	-		v			v					v		v		
	38	-	-		v			v					v		v		
	41	-	-		v			v					v		v		
E.R.P / E.I.R.P	7	-	-	v	v	v	v	v	v	v	v			v	v	v	
	38	-	-	v	v	v	v	v	v	v	v			v	v	v	
	41	-	-	v	v	v	v	v	v	v	v			v	v	v	
Radiated Spurious Emission	7	Worst Case														v	
	41	Worst Case														v	
Note	<ol style="list-style-type: none"> The mark "v" means that this configuration is chosen for testing The mark "-" means that this bandwidth is not supported. The device is investigated from 30MHz to 10 times of fundamental signal for radiated spurious emission test under different RB size/offset and modulations in exploratory test. Subsequently, only the worst case emissions are reported. LTE Band 41 overlaps the entire frequency range of LTE Band 38. Therefore, the test results provided in this report 																



covers Band 41 as well as Band 38.

Test Items	Band	Bandwidth (MHz)										Modulation			RB #			Test Channel		
		20+20	20+15	15+20	20+10	10+20	20+5	5+20	15+15	15+10	10+15	QPSK	16QAM	64QAM	1	Half	Full	L	M	H
Max. Output Power	7C_CA	v	v	v	v	v	-	-	v	-	-	v	v	v	v	v	v	v	v	v
	41C_CA	v	v	v	v	v	v	v	v	v	v	v	v	v	v	v	v	v	v	v
26dB and 99% Bandwidth	7C_CA	v	v	v	v	v	-	-	v	-	-	v	v	v			v	v	v	v
	41C_CA	v	v	v	v	v	v	v	v	v	v	v	v	v			v	v	v	v
Conducted Band Edge	7C_CA	v	v	v	v	v	-	-	v	-	-	v	v	v	v		v	v		v
	41C_CA	v	v	v	v	v	v	v	v	v	v	v	v	v	v		v	v		v
Conducted Spurious Emission	7C_CA	v	v	v	v	v	-	-	v	-	-	v	v	v	v			v	v	v
	41C_CA	v	v	v	v	v	v	v	v	v	v	v	v	v	v			v	v	v
E.I.R.P.	7C_CA	v	v	v	v	v	-	-	v	-	-	v	v	v	v			v	v	v
	41C_CA	v	v	v	v	v	v	v	v	v	v	v	v	v	v			v	v	v
Radiated Spurious Emission	7C_CA	Worst Case																	v	
	41C_CA	Worst Case																	v	
Note	1. The mark "v" means that this configuration is chosen for testing 2. The mark "-" means that this bandwidth is not supported. 3. The device is investigated from 30MHz to 10 times of fundamental signal for radiated spurious emission test under different RB size/offset and modulations in exploratory test. Subsequently, only the worst case emissions are reported.																			

2.2 Connection Diagram of Test System

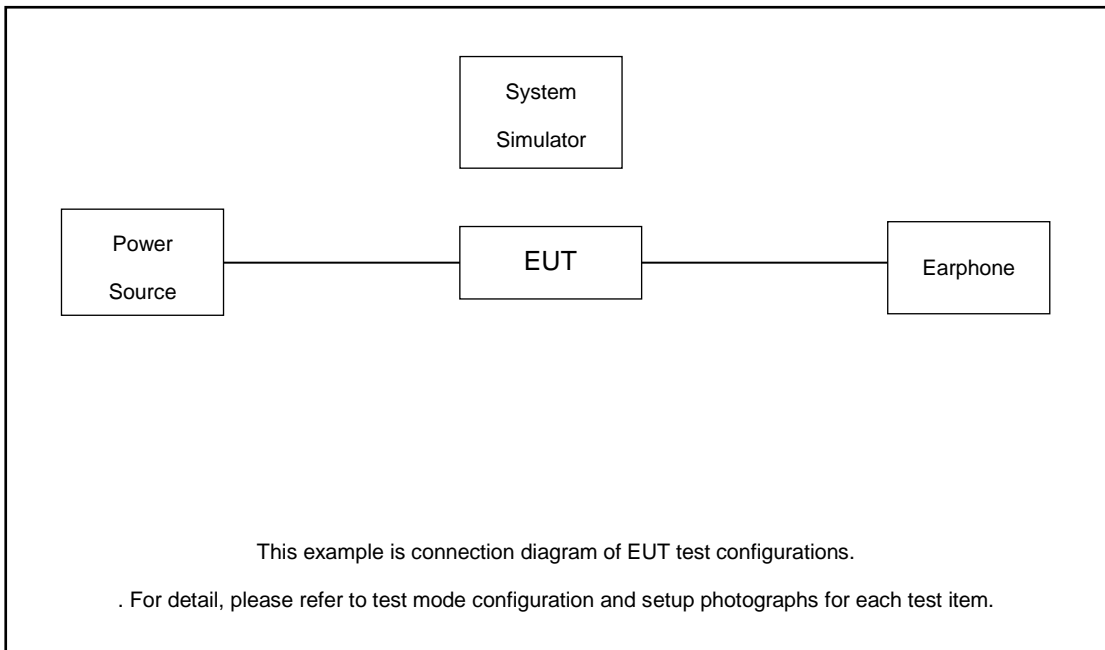

2.3 Support Unit used in test configuration and system

Item	Equipment	Trade Name	Model No.	FCC ID	Data Cable	Power Cord
1.	Power Supply	GWINSTEK	PSS-2002	N/A	N/A	Unshielded, 1.8 m
2.	LTE Base Station	Anritsu	MT8820C	N/A	N/A	Unshielded, 1.8 m

2.4 Measurement Results Explanation Example

For all conducted test items:

The offset level is set in the spectrum analyzer to compensate the RF cable loss and attenuator factor between EUT conducted output port and spectrum analyzer. With the offset compensation, the spectrum analyzer reading level is exactly the EUT RF output level.

The spectrum analyzer offset is derived from RF cable loss and attenuator factor.

$$\text{Offset} = \text{RF cable loss} + \text{attenuator factor}.$$

Following shows an offset computation example with cable loss 5.0 dB and 10dB attenuator.

Example :

$$\begin{aligned} \text{Offset(dB)} &= \text{RF cable loss(dB)} + \text{attenuator factor(dB)}. \\ &= 5.0 + 10 = 15.0 \text{ (dB)} \end{aligned}$$



2.5 Frequency List of Low/Middle/High Channels

LTE Band 7 Channel and Frequency List				
BW [MHz]	Channel/Frequency(MHz)	Lowest	Middle	Highest
20	Channel	20850	21100	21350
	Frequency	2510	2535	2560
15	Channel	20825	21100	21375
	Frequency	2507.5	2535	2562.5
10	Channel	20800	21100	21400
	Frequency	2505	2535	2565
5	Channel	20775	21100	21425
	Frequency	2502.5	2535	2567.5

LTE Band 38 Channel and Frequency List				
BW [MHz]	Channel/Frequency(MHz)	Lowest	Middle	Highest
20	Channel	37850	38000	38150
	Frequency	2580	2595	2610
15	Channel	37825	38000	38175
	Frequency	2577.5	2595	2612.5
10	Channel	37800	38000	38200
	Frequency	2575	2595	2615
5	Channel	37775	38000	38225
	Frequency	2572.5	2595	2617.5

LTE Band 41 Channel and Frequency List				
BW [MHz]	Channel/Frequency(MHz)	Lowest	Middle	Highest
20	Channel	39750	40620	41490
	Frequency	2506	2593	2680
15	Channel	39725	40620	41515
	Frequency	2503.5	2593	2682.5
10	Channel	39700	40620	41540
	Frequency	2501	2593	2685
5	Channel	39675	40620	41565
	Frequency	2498.5	2593	2687.5



LTE Band 7C_CA Channel and Frequency List					
BW [MHz]	Channel/Frequency(MHz)		Lowest	Middle	Highest
20 + 20	PCC	Channel	20850	21001	21152
		Frequency	2510.0	2525.1	2540.2
	SCC	Channel	21048	21199	21350
		Frequency	2529.8	2544.9	2560.0
20 + 15	PCC	Channel	20850	21026	21201
		Frequency	2510.0	2527.6	2545.1
	SCC	Channel	21021	21197	21372
		Frequency	2527.1	2544.7	2562.2
15 + 20	PCC	Channel	20828	21003	21179
		Frequency	2507.8	2525.3	2542.9
	SCC	Channel	20999	21174	21350
		Frequency	2524.9	2542.4	2560.0
20 + 10	PCC	Channel	20850	21051	21251
		Frequency	2510.0	2530.1	2550.1
	SCC	Channel	20994	21195	21395
		Frequency	2524.4	2544.5	2564.5
10 + 20	PCC	Channel	20805	21006	21206
		Frequency	2505.5	2525.6	2545.6
	SCC	Channel	20949	21150	21350
		Frequency	2519.9	2540.0	2560.0
15 + 15	PCC	Channel	20825	21025	21225
		Frequency	2507.5	2527.5	2547.5
	SCC	Channel	20975	21175	21375
		Frequency	2522.5	2542.5	2562.5



LTE Band 41C_CA Channel and Frequency List					
BW [MHz]	Channel/Frequency(MHz)		Lowest	Middle	Highest
20 + 20	PCC	Channel	39750	40521	41292
		Frequency	2506.0	2583.1	2660.2
	SCC	Channel	39948	40719	41490
		Frequency	2525.8	2602.9	2680.0
20 + 15	PCC	Channel	39750	40546	41341
		Frequency	2506.0	2585.6	2665.1
	SCC	Channel	39921	40717	41512
		Frequency	2523.1	2602.7	2682.2
15 + 20	PCC	Channel	39728	40523	41319
		Frequency	2503.8	2593.3	2662.9
	SCC	Channel	39899	40694	41490
		Frequency	2520.9	2600.4	2680.0
20 + 10	PCC	Channel	39750	40571	41391
		Frequency	2506.0	2588.1	2670.1
	SCC	Channel	39894	40715	41535
		Frequency	2520.4	2602.5	2684.5
10 + 20	PCC	Channel	39705	40526	41346
		Frequency	2501.5	2583.6	2665.6
	SCC	Channel	39849	40670	41490
		Frequency	2515.9	2598.0	2680.0



LTE Band 41C_CA Channel and Frequency List					
20 + 5	PCC	Channel	39750	40595	41440
		Frequency	2506.0	2590.5	2675.0
	SCC	Channel	39867	40712	41557
		Frequency	2517.7	2602.2	2686.7
5 + 20	PCC	Channel	39683	40528	41373
		Frequency	2499.3	2583.8	2668.3
	SCC	Channel	39800	40645	41490
		Frequency	2511.0	2595.5	2680.0
15 + 15	PCC	Channel	39725	40545	41365
		Frequency	2503.5	2585.5	2667.5
	SCC	Channel	39875	40695	41515
		Frequency	2518.5	2600.5	2682.5
10 + 15	PCC	Channel	39703	40549	41395
		Frequency	2501.3	2585.9	2670.5
	SCC	Channel	39823	40669	41515
		Frequency	2513.3	2597.9	2682.5
15 + 10	PCC	Channel	39725	40571	41417
		Frequency	2503.5	2588.1	2672.7
	SCC	Channel	39845	40691	41537
		Frequency	2515.5	2600.1	2684.7

3 Conducted Test Items

3.1 Measuring Instruments

See list of measuring instruments of this test report.

3.2 Test Setup

3.2.1 Conducted Output Power



3.2.2 Peak-to-Average Ratio, Occupied Bandwidth ,Conducted Band-Edge and Conducted Spurious Emission



3.2.3 Frequency Stability

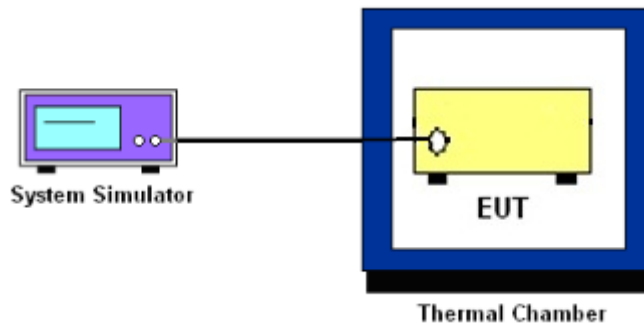

3.3 Test Result of Conducted Test

Please refer to Appendix A.



3.4 Conducted Output Power and EIRP

3.4.1 Description of the Conducted Output Power Measurement and EIRP Measurement

A system simulator was used to establish communication with the EUT. Its parameters were set to force the EUT transmitting at maximum output power. The measured power in the radio frequency on the transmitter output terminals shall be reported.

The EIRP of mobile transmitters must not exceed 2 Watts for LTE Band 38 and Band 41 and Band 7.

According to KDB 412172 D01 Power Approach,

$EIRP = P_T + G_T - L_C$, $ERP = EIRP - 2.15$, where

P_T = transmitter output power in dBm

G_T = gain of the transmitting antenna in dBi

L_C = signal attenuation in the connecting cable between the transmitter and antenna in dB

3.4.2 Test Procedures

1. The testing follows ANSI C63.26 Section 5.2
2. The transmitter output port was connected to the system simulator.
3. Set EUT at maximum power through the system simulator.
4. Select lowest, middle, and highest channels for each band and different modulation.
5. Measure and record the power level from the system simulator.



3.5 Peak-to-Average Ratio

3.5.1 Description of the PAR Measurement

Power Complementary Cumulative Distribution Function (CCDF) curves provide a means for characterizing the power peaks of a digitally modulated signal on a statistical basis. A CCDF curve depicts the probability of the peak signal amplitude exceeding the average power level. Most contemporary measurement instrumentation include the capability to produce CCDF curves for an input signal provided that the instrument's resolution bandwidth can be set wide enough to accommodate the entire input signal bandwidth. In measuring transmissions in this band using an average power technique, the peak-to-average ratio (PAR) of the transmission may not exceed 13 dB.

3.5.2 Test Procedures

1. The testing follows ANSI C63.26 Section 5.2.3.4 (CCDF).
2. The EUT was connected to spectrum and system simulator via a power divider.
3. Set the CCDF (Complementary Cumulative Distribution Function) option in spectrum analyzer.
4. The highest RF powers were measured and recorded the maximum PAPR level associated with a probability of 0.1 %.
5. Record the deviation as Peak to Average Ratio.



3.6 Occupied Bandwidth

3.6.1 Description of Occupied Bandwidth Measurement

The occupied bandwidth is the width of a frequency band such that, below the lower and above the upper frequency limits, the mean powers emitted are each equal to a specified percentage 0.5% of the total mean transmitted power.

The 26 dB emission bandwidth is defined as the frequency range between two points, one above and one below the carrier frequency, at which the spectral density of the emission is attenuated 26 dB below the maximum in-band spectral density of the modulated signal. Spectral density (power per unit bandwidth) is to be measured with a detector of resolution bandwidth equal to approximately 1.0% of the emission bandwidth.

3.6.2 Test Procedures

1. The testing follows ANSI C63.26 Section 5.4
2. The EUT was connected to spectrum analyzer and system simulator via a power divider.
3. The spectrum analyzer center frequency is set to the nominal EUT channel center frequency. The span range for the spectrum analyzer shall be between two and five times the anticipated OBW.
4. The nominal resolution bandwidth (RBW) shall be in the range of 1 to 5 % of the anticipated OBW, and the VBW shall be at least 3 times the RBW.
5. Set the detection mode to peak, and the trace mode to max hold.
6. Determine the reference value: Set the EUT to transmit a modulated signal. Allow the trace to stabilize. Set the spectrum analyzer marker to the highest level of the displayed trace.
(this is the reference value)
7. Determine the “-26 dB down amplitude” as equal to (Reference Value – X).
8. Place two markers, one at the lowest and the other at the highest frequency of the envelope of the spectral display such that each marker is at or slightly below the “-X dB down amplitude” determined in step 6. If a marker is below this “-X dB down amplitude” value it shall be placed as close as possible to this value. The OBW is the positive frequency difference between the two markers.
9. Use the 99 % power bandwidth function of the spectrum analyzer and report the measured bandwidth.



3.7 Conducted Band Edge

3.7.1 Description of Conducted Band Edge Measurement

27.53(m)(4)

For mobile digital stations, the attenuation factor shall be not less than $40 + 10 \log (P)$ dB on all frequencies between the channel edge and 5 megahertz from the channel edge, $43 + 10 \log (P)$ dB on all frequencies between 5 megahertz and X megahertz from the channel edge, and $55 + 10 \log (P)$ dB on all frequencies more than X megahertz from the channel edge, where X is the greater of 6 megahertz or the actual emission bandwidth as defined in paragraph (m)(6) of this section. In addition, the attenuation factor shall not be less than $43 + 10 \log (P)$ dB on all frequencies between 2490.5 MHz and 2496 MHz and $55 + 10 \log (P)$ dB at or below 2490.5 MHz. Mobile Satellite Service licensees operating on frequencies below 2495 MHz may also submit a documented interference complaint against BRS licensees operating on channel BRS Channel 1 on the same terms and conditions as adjacent channel BRS or EBS licensees.

3.7.2 Test Procedures

1. The testing follows ANSI C63.26 section 5.7
2. The EUT was connected to spectrum analyzer and system simulator via a power divider.
3. The band edges of low and high channels for the highest RF powers were measured.
4. Set RBW $\geq 1\%$ /2%EBW in the 1MHz band immediately outside and adjacent to the band edge.
5. Beyond the 1 MHz band from the band edge, RBW=1MHz was used or a narrower RBW was used and the measured power was integrated over the full required measurement bandwidth of 1 MHz.
6. Offset has included the duty factor for LTE Band 41. Duty factor = $10 \log (1/x)$, where x is the measured duty cycle
7. Set spectrum analyzer with RMS detector.
8. The RF fundamental frequency should be excluded against the limit line in the operating frequency band.
9. Checked that all the results comply with the emission limit line.

Example:

The limit line is derived from $43 + 10 \log (P)$ dB below the transmitter power P(Watts)
= $P(W) - [43 + 10 \log (P)]$ (dB)
= $[30 + 10 \log (P)]$ (dBm) - $[43 + 10 \log (P)]$ (dB) = -13dBm.

10. For LTE Band 7, 38, 41, the other 40 dB, and 55 dB have additionally applied same calculation above.



11. When using the integration method, the starting frequency of the integration shall be centered at one-half of the RBW away from the band edge.

3.8 Conducted Spurious Emission

3.8.1 Description of Conducted Spurious Emission Measurement

For Band 7,38,41:

The power of any emission outside of the authorized operating frequency ranges must be lower than the transmitter power (P) by a factor of at least $55 + 10 \log (P)$ dB.

It is measured by means of a calibrated spectrum analyzer and scanned from 30 MHz up to a frequency including its 10th harmonic.

3.8.2 Test Procedures

1. The testing follows ANSI C63.26 section 5.7
2. The EUT was connected to spectrum analyzer and system simulator via a power divider.
3. The RF output of EUT was connected to the spectrum analyzer by RF cable and attenuator. The path loss was compensated to the results for each measurement.
4. The middle channel for the highest RF power within the transmitting frequency was measured.
5. The conducted spurious emission for the whole frequency range was taken.
6. Make the measurement with the spectrum analyzer's RBW = 1MHz, VBW = 3MHz.
7. Set spectrum analyzer with RMS detector.
8. Offset has included the duty factor for LTE Band 41. Duty factor = $10 \log (1/x)$, where x is the measured duty cycle
9. Taking the record of maximum spurious emission.
10. The RF fundamental frequency should be excluded against the limit line in the operating frequency band.
11. The limit line is derived from $43 + 10\log(P)$ dB below the transmitter power P(Watts)
= $P(W) - [43 + 10\log(P)]$ (dB)
= $[30 + 10\log(P)]$ (dBm) - $[43 + 10\log(P)]$ (dB)
= -13dBm.
12. For Band 7, 38, 41
The limit line is derived from $55 + 10\log(P)$ dB below the transmitter power P(Watts)
= $P(W) - [55 + 10\log(P)]$ (dB)
= $[30 + 10\log(P)]$ (dBm) - $[55 + 10\log(P)]$ (dB)
= -25dBm.



3.9 Frequency Stability

3.9.1 Description of Frequency Stability Measurement

The frequency stability shall be measured by variation of ambient temperature and variation of primary supply voltage to ensure that the fundamental emission stays within the authorized frequency block.

3.9.2 Test Procedures for Temperature Variation

1. The testing follows ANSI C63.26 section 5.6.4
2. The EUT was set up in the thermal chamber and connected with the system simulator.
3. With power OFF, the temperature was decreased to -30°C and the EUT was stabilized before testing. Power was applied and the maximum change in frequency was recorded within one minute.
4. With power OFF, the temperature was raised in 10°C step up to 50°C . The EUT was stabilized at each step for at least half an hour. Power was applied and the maximum frequency change was recorded within one minute.

3.9.3 Test Procedures for Voltage Variation

1. The testing follows ANSI C63.26 section 5.6.5
2. The EUT was placed in a temperature chamber at $20\pm 5^{\circ}\text{C}$ and connected with the system simulator.
3. The power supply voltage to the EUT was varied from 85% to 115% of the nominal value for other than hand carried battery equipment.
4. For hand carried, battery powered equipment, reduce the primary ac or dc supply voltage to the battery operating end point, which shall be specified by the manufacturer.
5. The variation in frequency was measured for the worst case.

4 Radiated Test Items

4.1 Measuring Instruments

See list of measuring instruments of this test report.

4.2 Test Setup

4.2.1 For radiated test below 30MHz

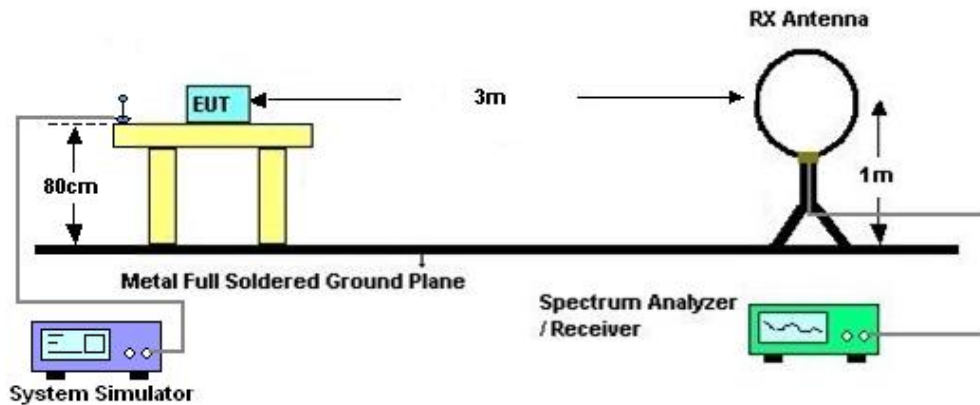

4.2.2 For radiated test from 30MHz to 1GHz

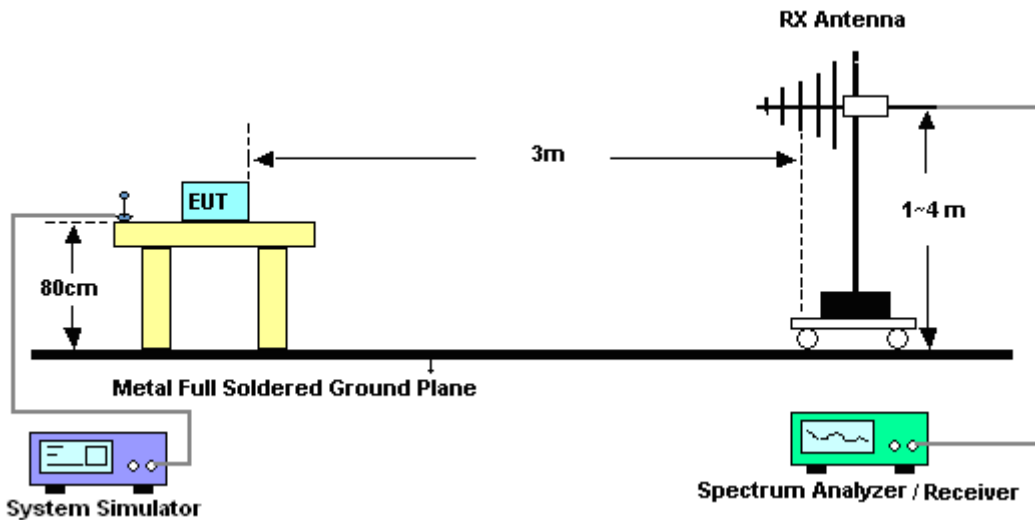

4.2.3 For radiated test above 1GHz

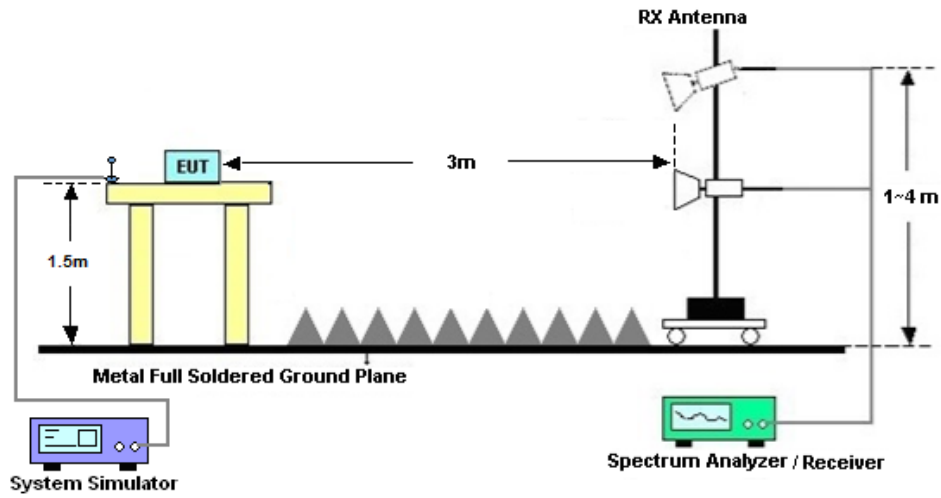

4.3 Test Result of Radiated Test

The low frequency, which started from 9 kHz to 30MHz, was pre-scanned and the result which was 20dB lower than the limit line was not reported.

Please refer to Appendix B.



4.4 Radiated Spurious Emission

4.4.1 Description of Radiated Spurious Emission

The radiated spurious emission was measured by substitution method according to ANSI C63.26.

For Band 7, 38, 41

The power of any emission outside of the authorized operating frequency ranges must be attenuated below the transmitter power (P) by a factor of at least $55 + 10 \log (P)$ dB.

The spectrum is scanned from 30 MHz up to a frequency including its 10th harmonic.

4.4.2 Test Procedures

1. The testing follows ANSI C63.26 Section 5.5
2. The EUT was placed on a turntable with 0.8 meter height for frequency below 1GHz and 1.5 meter height for frequency above 1GHz respectively above ground.
3. The EUT was set 3 meters from the receiving antenna mounted on the antenna tower.
4. The table was rotated 360 degrees to determine the position of the highest spurious emission.
5. The height of the receiving antenna is varied between 1m to 4m to search the maximum spurious emission for both horizontal and vertical polarizations.
6. During the measurement, the system simulator parameters were set to force the EUT transmitting at maximum output power.
7. Make the measurement with the spectrum analyzer's RBW = 1MHz, VBW = 3MHz, taking the record of maximum spurious emission.
8. A horn antenna was substituted in place of the EUT and was driven by a signal generator.
9. Tune the output power of signal generator to the same emission level with EUT maximum spurious emission.
10. $EIRP (dBm) = S.G. Power - Tx Cable Loss + Tx Antenna Gain$
11. $ERP (dBm) = EIRP - 2.15$
12. The RF fundamental frequency should be excluded against the limit line in the operating frequency band.

The limit line is derived from $43 + 10\log(P)$ dB below the transmitter power P(Watts)
 $= P(W) - [43 + 10\log(P)] (dB)$
 $= [30 + 10\log(P)] (dBm) - [43 + 10\log(P)] (dB)$
 $= -13dBm.$

13. For Band 7, 38, 41:

The limit line is derived from $55 + 10\log(P)$ dB below the transmitter power P(Watts)



5 List of Measuring Equipment

Instrument	Manufacturer	Model No.	Serial No.	Characteristics	Calibration Date	Test Date	Due Date	Remark
Spectrum Analyzer	R&S	FSV40	101078	10Hz~40GHz	Apr. 07, 2022	Jul. 16, 2022~ Jul. 20, 2022	Apr. 06, 2023	Conducted (TH01-SZ)
Thermal Chamber	Ten Billion Hongzhangroup	LP-150U	H2014081803	-40~+150°C	Jul. 14, 2022	Jul. 16, 2022~ Jul. 20, 2022	Jul. 13, 2023	Conducted (TH01-SZ)
EMI Test Receiver&SA	KEYSIGHT	N9038A	MY54450083	20Hz~8.4GHz	Apr. 06, 2022	Jul. 22, 2022	Apr. 05, 2023	Radiation (03CH03-SZ)
Loop Antenna	R&S	HFH2-Z2	100354	9kHz~30MHz	Jun. 22, 2022	Jul. 22, 2022	Jun. 21, 2023	Radiation (03CH03-SZ)
EXA Spectrum Analyzer	KEYSIGHT	N9010A	MY55150246	10Hz~44GHz;	Apr. 06, 2022	Jul. 22, 2022	Apr. 05, 2023	Radiation (03CH03-SZ)
Bilog Antenna	TeseQ	CBL6112D	35408	30MHz-2GHz	Jun. 22, 2022	Jul. 22, 2022	Jun. 21, 2023	Radiation (03CH03-SZ)
Double Ridge Horn Antenna	SCHWARZBECK	BBHA9120D	9120D-1355	1GHz~18GHz	Apr. 08, 2022	Jul. 22, 2022	Apr. 07, 2023	Radiation (03CH03-SZ)
Amplifier	Burgeon	BPA-530	102211	0.01Hz ~3000MHz	Oct. 22, 2021	Jul. 22, 2022	Oct. 21, 2022	Radiation (03CH03-SZ)
HF Amplifier	MITEQ	TTA1840-35-HG	1871923	18GHz~40GHz	Oct. 22, 2021	Jul. 22, 2022	Oct. 21, 2022	Radiation (03CH03-SZ)
SHF-EHF Horn	com-power	AH-840	101071	18Ghz-40GHz	Apr. 10, 2022	Jul. 22, 2022	Apr. 09, 2023	Radiation (03CH03-SZ)
Amplifier	Agilent Technologies	83017A	MY39501302	500MHz~26.5GHz	Dec. 30, 2021	Jul. 22, 2022	Dec. 29, 2022	Radiation (03CH03-SZ)
AC Power Source	Chroma	61601	616010001985	N/A	NCR	Jul. 22, 2022	NCR	Radiation (03CH03-SZ)
Turn Table	EM	EM1000	N/A	0~360 degree	NCR	Jul. 22, 2022	NCR	Radiation (03CH03-SZ)
Antenna Mast	EM	EM1000	N/A	1 m~4 m	NCR	Jul. 22, 2022	NCR	Radiation (03CH03-SZ)

NCR: No Calibration Required



6 Uncertainty of Evaluation

The measurement uncertainties shown below were calculated in accordance with the requirements of ANSI 63.26-2015. All the measurement uncertainty value were shown with a coverage K=2 to indicate 95% level of confidence. The measurement data show herein meets or exceeds the CISPR measurement uncertainty values specified in CISPR 16-4-2 and can be compared directly to specified limit to determine compliance.

Uncertainty of Conducted Measurement

Test Item	Uncertainty
Conducted Power	±1.34 dB
Conducted Emissions	±1.34 dB
Occupied Channel Bandwidth	0.012 MHz
Frequency Stability	1.3 ppm

Uncertainty of Radiated Emission Measurement (30 MHz ~ 1000 MHz)

Measuring Uncertainty for a Level of Confidence of 95% (U = 2Uc(y))	3.0dB
---	-------

Uncertainty of Radiated Emission Measurement (1 GHz ~ 18 GHz)

Measuring Uncertainty for a Level of Confidence of 95% (U = 2Uc(y))	3.6dB
---	-------

Uncertainty of Radiated Emission Measurement (18 GHz ~ 40 GHz)

Measuring Uncertainty for a Level of Confidence of 95% (U = 2Uc(y))	3.8dB
---	-------



Appendix A. Test Results of Conducted Test

Test Engineer :	Lorenzo Liu	Temperature :	24~26°C
		Relative Humidity :	50~53%

Conducted Output Power(Average power)

LTE Band 7:

BW [MHz]	Modulation	RB Size	RB Offset	Power Low Ch. / Freq.	Power Middle Ch. / Freq.	Power High Ch. / Freq.
Channel				20850	21100	21350
Frequency (MHz)				2510	2535	2560
20	QPSK	1	0	23.10	23.16	23.03
20	QPSK	1	49	23.34	23.47	23.31
20	QPSK	1	99	23.05	23.08	22.97
20	QPSK	50	0	22.30	22.35	22.14
20	QPSK	50	24	22.38	22.44	22.27
20	QPSK	50	50	22.23	22.28	22.11
20	QPSK	100	0	22.34	22.40	22.18
20	16QAM	1	0	22.38	22.36	22.28
20	16QAM	1	49	22.72	22.74	22.35
20	16QAM	1	99	22.29	22.30	22.26
20	16QAM	50	0	21.25	21.41	21.14
20	16QAM	50	24	21.39	21.49	21.26
20	16QAM	50	50	21.12	21.35	21.15
20	16QAM	100	0	21.29	21.31	21.16
20	64QAM	1	0	21.35	21.37	21.27
20	64QAM	1	49	21.71	21.54	21.46
20	64QAM	1	99	21.27	21.27	21.25
20	64QAM	50	0	20.27	20.38	20.09
20	64QAM	50	24	20.41	20.43	20.31
20	64QAM	50	50	20.20	20.25	20.13
20	64QAM	100	0	20.26	20.31	20.20
Channel				20825	21100	21375
Frequency (MHz)				2507.5	2535	2562.5
15	QPSK	1	0	23.08	23.04	22.85
15	QPSK	1	37	23.29	23.28	23.32
15	QPSK	1	74	23.05	22.95	22.98
15	QPSK	36	0	22.30	22.21	22.04
15	QPSK	36	20	22.33	22.43	22.10
15	QPSK	36	39	22.16	22.24	21.93
15	QPSK	75	0	22.25	22.30	22.15
15	16QAM	1	0	22.31	22.18	22.19
15	16QAM	1	37	22.56	22.60	22.27
15	16QAM	1	74	22.22	22.23	22.21
15	16QAM	36	0	21.27	21.25	21.03



15	16QAM	36	20	21.22	21.32	21.27
15	16QAM	36	39	21.04	21.32	21.13
15	16QAM	75	0	21.21	21.31	21.05
15	64QAM	1	0	21.30	21.26	21.17
15	64QAM	1	37	21.41	21.45	21.45
15	64QAM	1	74	21.25	21.10	21.11
15	64QAM	36	0	20.27	20.25	20.00
15	64QAM	36	20	20.30	20.34	20.21
15	64QAM	36	39	20.11	20.16	20.14
15	64QAM	75	0	20.25	20.24	20.21
Channel				20800	21100	21400
Frequency (MHz)				2505	2535	2565
10	QPSK	1	0	23.07	22.99	22.96
10	QPSK	1	25	23.17	23.32	23.17
10	QPSK	1	49	23.03	23.04	22.84
10	QPSK	25	0	22.32	22.29	22.13
10	QPSK	25	12	22.37	22.37	22.12
10	QPSK	25	25	22.22	22.20	22.06
10	QPSK	50	0	22.20	22.34	22.05
10	16QAM	1	0	22.20	22.27	22.22
10	16QAM	1	25	22.60	22.59	22.25
10	16QAM	1	49	22.21	22.23	22.26
10	16QAM	25	0	21.20	21.31	21.01
10	16QAM	25	12	21.31	21.35	21.09
10	16QAM	25	25	21.11	21.33	21.14
10	16QAM	50	0	21.26	21.13	21.08
10	64QAM	1	0	21.18	21.34	21.25
10	64QAM	1	25	21.55	21.39	21.44
10	64QAM	1	49	21.18	21.19	21.18
10	64QAM	25	0	20.28	20.27	20.04
10	64QAM	25	12	20.24	20.34	20.15
10	64QAM	25	25	20.18	20.12	19.96
10	64QAM	50	0	20.11	20.22	20.09
Channel				20775	21100	21425
Frequency (MHz)				2502.5	2535	2567.5
5	QPSK	1	0	23.02	23.15	22.91
5	QPSK	1	12	23.34	23.35	23.23
5	QPSK	1	24	22.88	22.99	22.89
5	QPSK	12	0	22.17	22.17	22.05
5	QPSK	12	7	22.35	22.32	22.11
5	QPSK	12	13	22.22	22.18	21.97
5	QPSK	25	0	22.19	22.32	22.18
5	16QAM	1	0	22.23	22.20	22.30
5	16QAM	1	12	22.60	22.70	22.31
5	16QAM	1	24	22.22	22.22	22.24
5	16QAM	12	0	21.14	21.28	21.04
5	16QAM	12	7	21.36	21.45	21.16
5	16QAM	12	13	20.96	21.17	21.11
5	16QAM	25	0	21.20	21.20	21.01
5	64QAM	1	0	21.21	21.38	21.29



5	64QAM	1	12	21.54	21.39	21.44
5	64QAM	1	24	21.18	21.20	21.16
5	64QAM	12	0	20.27	20.32	20.06
5	64QAM	12	7	20.33	20.26	20.32
5	64QAM	12	13	20.07	20.27	19.96
5	64QAM	25	0	20.26	20.22	20.19

LTE Band 38:

BW [MHz]	Modulation	RB Size	RB Offset	Power Low Ch. / Freq.	Power Middle Ch. / Freq.	Power High Ch. / Freq.
Channel				37850	38000	38150
Frequency (MHz)				2580	2595	2610
20	QPSK	1	0	23.19	23.21	23.11
20	QPSK	1	49	23.39	23.43	23.34
20	QPSK	1	99	23.29	23.39	23.24
20	QPSK	50	0	22.31	22.26	22.39
20	QPSK	50	24	22.36	22.46	22.31
20	QPSK	50	50	22.41	22.43	22.27
20	QPSK	100	0	22.37	22.43	22.31
20	16QAM	1	0	22.50	22.32	22.17
20	16QAM	1	49	22.54	22.41	22.51
20	16QAM	1	99	22.54	22.45	22.54
20	16QAM	50	0	21.40	21.20	21.38
20	16QAM	50	24	21.50	21.35	21.41
20	16QAM	50	50	21.64	21.46	21.47
20	16QAM	100	0	21.60	21.37	21.38
20	64QAM	1	0	21.08	21.21	21.06
20	64QAM	1	49	21.37	21.13	21.10
20	64QAM	1	99	21.32	21.18	21.11
20	64QAM	50	0	20.40	20.23	20.34
20	64QAM	50	24	20.46	20.35	20.42
20	64QAM	50	50	20.65	20.42	20.43
20	64QAM	100	0	20.52	20.30	20.40
Channel				37825	38000	38175
Frequency (MHz)				2577.5	2595	2612.5
15	QPSK	1	0	23.18	23.16	23.07
15	QPSK	1	37	23.35	23.32	23.20
15	QPSK	1	74	23.13	23.10	23.42
15	QPSK	36	0	22.33	22.24	22.28
15	QPSK	36	20	22.19	22.42	22.22
15	QPSK	36	39	22.40	22.39	22.13
15	QPSK	75	0	22.23	22.43	22.30
15	16QAM	1	0	22.36	22.22	22.05
15	16QAM	1	37	22.40	22.26	22.33
15	16QAM	1	74	22.52	22.30	22.50
15	16QAM	36	0	21.31	21.14	21.33
15	16QAM	36	20	21.49	21.29	21.31
15	16QAM	36	39	21.40	21.36	21.37
15	16QAM	75	0	21.61	21.28	21.22



15	64QAM	1	0	20.90	21.13	20.95
15	64QAM	1	37	21.19	20.98	21.12
15	64QAM	1	74	21.29	21.07	20.97
15	64QAM	36	0	20.31	20.15	20.26
15	64QAM	36	20	20.42	20.28	20.38
15	64QAM	36	39	20.56	20.32	20.28
15	64QAM	75	0	20.44	20.28	20.41
Channel				37800	38000	38200
Frequency (MHz)				2575	2595	2615
10	QPSK	1	0	23.04	23.09	23.04
10	QPSK	1	25	23.21	23.29	23.29
10	QPSK	1	49	23.31	23.09	23.42
10	QPSK	25	0	22.22	22.21	22.38
10	QPSK	25	12	22.25	22.48	22.30
10	QPSK	25	25	22.30	22.27	22.15
10	QPSK	50	0	22.21	22.37	22.32
10	16QAM	1	0	22.50	22.17	22.03
10	16QAM	1	25	22.50	22.34	22.37
10	16QAM	1	49	22.51	22.27	22.50
10	16QAM	25	0	21.41	21.18	21.29
10	16QAM	25	12	21.40	21.28	21.39
10	16QAM	25	25	21.52	21.38	21.44
10	16QAM	50	0	21.51	21.26	21.25
10	64QAM	1	0	20.90	21.10	21.05
10	64QAM	1	25	21.32	21.08	21.10
10	64QAM	1	49	21.23	21.08	21.03
10	64QAM	25	0	20.40	20.20	20.33
10	64QAM	25	12	20.46	20.25	20.31
10	64QAM	25	25	20.52	20.38	20.33
10	64QAM	50	0	20.53	20.20	20.42
Channel				37775	38000	38225
Frequency (MHz)				2572.5	2595	2617.5
5	QPSK	1	0	23.10	23.05	23.05
5	QPSK	1	12	23.26	23.36	23.28
5	QPSK	1	24	23.30	23.13	23.41
5	QPSK	12	0	22.21	22.18	22.30
5	QPSK	12	7	22.33	22.35	22.29
5	QPSK	12	13	22.37	22.43	22.23
5	QPSK	25	0	22.34	22.32	22.13
5	16QAM	1	0	22.41	22.31	22.15
5	16QAM	1	12	22.45	22.35	22.42
5	16QAM	1	24	22.48	22.34	22.40
5	16QAM	12	0	21.32	21.22	21.25
5	16QAM	12	7	21.35	21.27	21.25
5	16QAM	12	13	21.58	21.34	21.43
5	16QAM	25	0	21.56	21.24	21.36
5	64QAM	1	0	21.01	21.14	20.89
5	64QAM	1	12	21.21	21.14	21.06
5	64QAM	1	24	21.20	21.19	21.08
5	64QAM	12	0	20.25	20.14	20.30



5	64QAM	12	7	20.42	20.21	20.32
5	64QAM	12	13	20.51	20.28	20.37
5	64QAM	25	0	20.46	20.22	20.22

LTE Band 41:

BW [MHz]	Modulation	RB Size	RB Offset	Power Low Ch. / Freq.	Power Middle Ch. / Freq.	Power High Ch. / Freq.
Channel				39750	40620	41490
Frequency (MHz)				2506	2593	2680
20	QPSK	1	0	23.12	23.16	23.21
20	QPSK	1	49	23.19	23.44	23.32
20	QPSK	1	99	23.10	23.18	23.19
20	QPSK	50	0	22.08	22.17	22.23
20	QPSK	50	24	22.07	22.21	22.31
20	QPSK	50	50	22.08	22.15	22.19
20	QPSK	100	0	21.98	22.11	22.22
20	16QAM	1	0	21.98	22.21	22.26
20	16QAM	1	49	22.23	22.30	22.30
20	16QAM	1	99	22.02	21.94	22.06
20	16QAM	50	0	21.07	21.06	21.15
20	16QAM	50	24	21.16	21.18	21.38
20	16QAM	50	50	21.10	21.14	21.05
20	16QAM	100	0	21.09	21.11	21.24
20	64QAM	1	0	20.76	20.68	20.77
20	64QAM	1	49	21.08	20.87	21.13
20	64QAM	1	99	20.77	20.79	20.71
20	64QAM	50	0	20.14	20.03	20.10
20	64QAM	50	24	20.15	20.14	20.12
20	64QAM	50	50	20.17	20.09	20.14
20	64QAM	100	0	20.09	20.21	20.10
Channel				39725	40620	41515
Frequency (MHz)				2503.5	2593	2682.5
15	QPSK	1	0	23.04	23.14	23.07
15	QPSK	1	37	23.20	23.09	23.34
15	QPSK	1	74	22.94	23.18	23.04
15	QPSK	36	0	22.05	21.99	22.10
15	QPSK	36	20	22.05	22.03	22.24
15	QPSK	36	39	22.05	22.06	22.08
15	QPSK	75	0	21.86	22.13	22.11
15	16QAM	1	0	21.83	22.09	22.27
15	16QAM	1	37	22.25	22.12	22.30
15	16QAM	1	74	21.94	21.88	21.89
15	16QAM	36	0	20.90	21.01	21.14
15	16QAM	36	20	21.01	21.10	21.31
15	16QAM	36	39	21.04	21.09	20.91
15	16QAM	75	0	21.10	20.97	21.13
15	64QAM	1	0	20.58	20.52	20.76
15	64QAM	1	37	20.95	20.88	20.84
15	64QAM	1	74	20.66	20.69	20.60



15	64QAM	36	0	20.15	19.86	20.02
15	64QAM	36	20	20.00	20.10	20.04
15	64QAM	36	39	20.05	19.96	19.96
15	64QAM	75	0	20.10	20.20	20.00
Channel				39700	40620	41540
Frequency (MHz)				2501	2593	2685
10	QPSK	1	0	22.96	23.10	23.21
10	QPSK	1	25	23.02	23.16	23.14
10	QPSK	1	49	22.98	23.14	23.01
10	QPSK	25	0	22.01	22.19	22.07
10	QPSK	25	12	22.01	22.03	22.28
10	QPSK	25	25	21.99	22.16	22.17
10	QPSK	50	0	21.84	21.94	22.09
10	16QAM	1	0	21.82	22.21	22.20
10	16QAM	1	25	22.08	22.18	22.22
10	16QAM	1	49	21.88	21.96	21.94
10	16QAM	25	0	20.99	21.01	21.14
10	16QAM	25	12	21.16	21.13	21.25
10	16QAM	25	25	20.99	21.16	20.99
10	16QAM	50	0	21.06	20.99	21.13
10	64QAM	1	0	20.76	20.69	20.65
10	64QAM	1	25	20.91	20.70	21.08
10	64QAM	1	49	20.76	20.71	20.71
10	64QAM	25	0	19.97	19.88	19.94
10	64QAM	25	12	20.11	20.09	19.95
10	64QAM	25	25	20.17	20.05	20.01
10	64QAM	50	0	19.98	20.17	20.00
Channel				39675	40620	41565
Frequency (MHz)				2498.5	2593	2687.5
5	QPSK	1	0	23.02	23.17	23.17
5	QPSK	1	12	23.12	23.22	23.26
5	QPSK	1	24	23.10	23.02	23.06
5	QPSK	12	0	22.06	22.01	22.21
5	QPSK	12	7	21.97	22.23	22.13
5	QPSK	12	13	22.00	22.03	22.16
5	QPSK	25	0	21.93	22.12	22.23
5	16QAM	1	0	21.87	22.11	22.17
5	16QAM	1	12	22.17	22.17	22.20
5	16QAM	1	24	21.87	21.77	21.95
5	16QAM	12	0	21.03	21.03	21.15
5	16QAM	12	7	21.09	21.11	21.25
5	16QAM	12	13	21.11	21.12	20.94
5	16QAM	25	0	20.92	21.11	21.19
5	64QAM	1	0	20.72	20.66	20.63
5	64QAM	1	12	20.95	20.70	21.04
5	64QAM	1	24	20.63	20.62	20.68
5	64QAM	12	0	20.13	19.90	20.10
5	64QAM	12	7	20.17	20.08	20.04
5	64QAM	12	13	20.13	20.08	20.11
5	64QAM	25	0	20.06	20.08	19.97



LTE Band 7C:

CA_7C_Ant 13									
Combination 20MHz+20MHz (100RB+100RB)									
PCC Channel	SCC Channel	Modulation	PCC		SCC		Total RB Size	Target MPR Level (dB)	Measured Power (dBm)
			RB Size	RB offset	RB Size	RB offset			
20850	21048	QPSK	100	0	100	0	200	≤2	21.21
			1	0	1	99	2	≤8.5	14.38
			1	99	1	0	2	≤0	23.25
		16QAM	100	0	100	0	200	≤3	20.21
			1	0	1	99	2	≤8.5	14.56
			1	99	1	0	2	≤1	22.13
		64QAM	100	0	100	0	200	≤3	20.37
			1	0	1	99	2	≤8.5	14.57
			1	99	1	0	2	≤3	20.51
21001	21199	QPSK	100	0	100	0	200	≤2	21.26
			1	0	1	99	2	≤8.5	14.55
			1	99	1	0	2	≤0	23.27
		16QAM	100	0	100	0	200	≤3	20.38
			1	0	1	99	2	≤8.5	14.66
			1	99	1	0	2	≤1	22.27
		64QAM	100	0	100	0	200	≤3	20.40
			1	0	1	99	2	≤8.5	14.69
			1	99	1	0	2	≤3	20.55
21152	21350	QPSK	100	0	100	0	200	≤2	21.24
			1	0	1	99	2	≤8.5	14.57
			1	99	1	0	2	≤0	23.26
		16QAM	100	0	100	0	200	≤3	20.41
			1	0	1	99	2	≤8.5	14.67
			1	99	1	0	2	≤1	22.29
		64QAM	100	0	100	0	200	≤3	20.39
			1	0	1	99	2	≤8.5	14.72
			1	99	1	0	2	≤3	20.60

CA_7C_Ant 13									
Combination 20MHz+15MHz (100RB+75RB)									
PCC Channel	SCC Channel	Modulation	PCC		SCC		Total RB Size	Target MPR Level (dB)	Measured Power (dBm)
			RB Size	RB offset	RB Size	RB offset			
20850	21021	QPSK	100	0	75	0	175	≤2	21.10
			1	0	1	74	2	≤8.5	14.29
			1	99	1	0	2	≤0	23.12
		16QAM	100	0	75	0	175	≤3	20.07
			1	0	1	74	2	≤8.5	14.38
			1	99	1	0	2	≤1	22.18
		64QAM	100	0	75	0	175	≤3	20.16
			1	0	1	74	2	≤8.5	14.35



21026	21197	QPSK	1	99	1	0	2	≤3	20.26
			100	0	75	0	175	≤2	21.23
			1	0	1	74	2	≤8.5	14.42
			1	99	1	0	2	≤0	23.29
		16QAM	100	0	75	0	175	≤3	20.22
			1	0	1	74	2	≤8.5	14.38
			1	99	1	0	2	≤1	22.19
			100	0	75	0	175	≤3	20.16
		64QAM	1	0	1	74	2	≤8.5	14.35
			1	99	1	0	2	≤3	20.34
			100	0	75	0	175	≤2	21.19
			1	0	1	74	2	≤8.5	14.37
21201	21372	QPSK	1	99	1	0	2	≤0	23.21
			100	0	75	0	175	≤3	20.21
			1	0	1	74	2	≤8.5	14.58
			1	99	1	0	2	≤1	22.28
		16QAM	100	0	75	0	175	≤3	20.27
			1	0	1	74	2	≤8.5	14.49
			1	99	1	0	2	≤3	20.27
			100	0	75	0	175	≤3	20.16
		64QAM	1	0	1	74	2	≤8.5	14.35
			1	99	1	0	2	≤3	20.34
			100	0	75	0	175	≤2	21.19
			1	0	1	74	2	≤8.5	14.37
Combination 15MHz+20MHz (75RB+100RB)									
PCC Channel	SCC Channel	Modulation	PCC		SCC		Total RB Size	Target MPR Level (dB)	Measured Power (dBm)
			RB Size	RB offset	RB Size	RB offset			
20828	20999	QPSK	75	0	100	0	175	≤2	21.05
			1	0	1	99	2	≤8.5	14.15
			1	74	1	0	2	≤0	23.02
			75	0	100	0	175	≤3	19.89
		16QAM	1	0	1	99	2	≤8.5	14.22
			1	74	1	0	2	≤1	22.05
			75	0	100	0	175	≤3	20.01
			1	0	1	99	2	≤8.5	14.34
		64QAM	1	74	1	0	2	≤3	20.14
			75	0	100	0	175	≤2	21.07
			1	0	1	99	2	≤8.5	14.27
			1	74	1	0	2	≤0	23.16
21003	21174	QPSK	75	0	100	0	175	≤3	20.18
			1	0	1	99	2	≤8.5	14.22
			1	74	1	0	2	≤1	22.12
			75	0	100	0	175	≤3	20.05
		16QAM	1	0	1	99	2	≤8.5	14.24
			1	74	1	0	2	≤3	20.25
			75	0	100	0	175	≤2	21.11
			1	0	1	99	2	≤8.5	14.30
		64QAM	1	74	1	0	2	≤0	23.13
			75	0	100	0	175	≤3	20.03
			1	0	1	99	2	≤8.5	14.56
			1	74	1	0	2	≤1	22.13



		64QAM	75	0	100	0	175	≤3	20.25
			1	0	1	99	2	≤8.5	14.39
			1	74	1	0	2	≤3	20.11
Combination 20MHz+10MHz (100RB+50RB)									
PCC Channel	SCC Channel	Modulation	PCC		SCC		Total RB Size	Target MPR Level (dB)	Measured Power (dBm)
			RB Size	RB offset	RB Size	RB offset			
20850	20994	QPSK	100	0	50	0	150	≤2	21.02
			1	0	1	49	2	≤8.5	14.19
			1	99	1	0	2	≤0	23.09
		16QAM	100	0	50	0	150	≤3	19.96
			1	0	1	49	2	≤8.5	14.26
			1	99	1	0	2	≤1	22.19
		64QAM	100	0	50	0	150	≤3	20.08
			1	0	1	49	2	≤8.5	14.17
			1	99	1	0	2	≤3	20.25
21051	21195	QPSK	100	0	50	0	150	≤2	21.13
			1	0	1	49	2	≤8.5	14.29
			1	99	1	0	2	≤0	22.91
		16QAM	100	0	50	0	150	≤3	20.11
			1	0	1	49	2	≤8.5	14.31
			1	99	1	0	2	≤1	22.13
		64QAM	100	0	50	0	150	≤3	20.17
			1	0	1	49	2	≤8.5	14.34
			1	99	1	0	2	≤3	20.32
21251	21395	QPSK	100	0	50	0	150	≤2	21.06
			1	0	1	49	2	≤8.5	14.37
			1	99	1	0	2	≤0	23.19
		16QAM	100	0	50	0	150	≤3	20.06
			1	0	1	49	2	≤8.5	14.52
			1	99	1	0	2	≤1	22.18
		64QAM	100	0	50	0	150	≤3	20.21
			1	0	1	49	2	≤8.5	14.47
			1	99	1	0	2	≤3	20.15
Combination 10MHz+20MHz (50RB+100RB)									
PCC Channel	SCC Channel	Modulation	PCC		SCC		Total RB Size	Target MPR Level (dB)	Measured Power (dBm)
			RB Size	RB offset	RB Size	RB offset			
20805	20949	QPSK	50	0	100	0	150	≤2	21.11
			1	0	1	99	2	≤8.5	14.13
			1	49	1	0	2	≤0	23.13
		16QAM	50	0	100	0	150	≤3	19.95
			1	0	1	99	2	≤8.5	14.38
			1	49	1	0	2	≤1	22.08
		64QAM	50	0	100	0	150	≤3	20.11
			1	0	1	99	2	≤8.5	14.23
			1	49	1	0	2	≤3	20.14



21006	21150	QPSK	50	0	100	0	150	≤2	21.05
			1	0	1	99	2	≤8.5	14.32
			1	49	1	0	2	≤0	23.24
		16QAM	50	0	100	0	150	≤3	20.22
			1	0	1	99	2	≤8.5	14.26
			1	49	1	0	2	≤1	22.17
		64QAM	50	0	100	0	150	≤3	20.10
			1	0	1	99	2	≤8.5	14.21
			1	49	1	0	2	≤3	20.30
21206	21350	QPSK	50	0	100	0	150	≤2	21.08
			1	0	1	99	2	≤8.5	14.24
			1	49	1	0	2	≤0	23.03
		16QAM	50	0	100	0	150	≤3	20.20
			1	0	1	99	2	≤8.5	14.48
			1	49	1	0	2	≤1	22.27
		64QAM	50	0	100	0	150	≤3	20.27
			1	0	1	99	2	≤8.5	14.36
			1	49	1	0	2	≤3	20.11
Combination 15MHz+15MHz (75RB+75RB)									
PCC Channel	SCC Channel	Modulation	PCC		SCC		Total RB Size	Target MPR Level (dB)	Measured Power (dBm)
			RB Size	RB offset	RB Size	RB offset			
20825	20975	QPSK	75	0	75	0	150	≤2	21.05
			1	0	1	74	2	≤8.5	14.19
			1	74	1	0	2	≤0	23.13
		16QAM	75	0	75	0	150	≤3	20.03
			1	0	1	74	2	≤8.5	14.21
			1	74	1	0	2	≤1	22.15
		64QAM	75	0	75	0	150	≤3	20.14
			1	0	1	74	2	≤8.5	14.36
			1	74	1	0	2	≤3	20.09
21025	21175	QPSK	75	0	75	0	150	≤2	21.20
			1	0	1	74	2	≤8.5	14.27
			1	74	1	0	2	≤0	23.17
		16QAM	75	0	75	0	150	≤3	20.04
			1	0	1	74	2	≤8.5	14.22
			1	74	1	0	2	≤1	22.18
		64QAM	75	0	75	0	150	≤3	20.08
			1	0	1	74	2	≤8.5	14.32
			1	74	1	0	2	≤3	20.36
21225	21375	QPSK	75	0	75	0	150	≤2	21.15
			1	0	1	74	2	≤8.5	14.29
			1	74	1	0	2	≤0	23.19
		16QAM	75	0	75	0	150	≤3	20.21
			1	0	1	74	2	≤8.5	14.48
			1	74	1	0	2	≤1	22.18
		64QAM	75	0	75	0	150	≤3	20.22



			1	0	1	74	2	≤8.5	14.33
			1	74	1	0	2	≤3	20.25



LTE Band 41C:

CA_41C_ANT 13									
Combination 20MHz+20MHz (100RB+100RB)									
PCC Channel	SCC Channel	Modulation	PCC		SCC		Total RB Size	Target MPR Level (dB)	Measured Power (dBm)
			RB Size	RB offset	RB Size	RB offset			
39750	39948	QPSK	100	0	100	0	200	≤2	21.38
			1	0	1	99	2	≤8.5	14.12
			1	99	1	0	2	≤0	23.03
		16QAM	100	0	100	0	200	≤3	20.23
			1	0	1	99	2	≤8.5	14.51
			1	99	1	0	2	≤1	22.35
		64QAM	100	0	100	0	200	≤3	20.17
			1	0	1	99	2	≤8.5	14.38
			1	99	1	0	2	≤3	20.27
40521	40719	QPSK	100	0	100	0	200	≤2	21.55
			1	0	1	99	2	≤8.5	14.23
			1	99	1	0	2	≤0	23.12
		16QAM	100	0	100	0	200	≤3	20.28
			1	0	1	99	2	≤8.5	14.62
			1	99	1	0	2	≤1	22.48
		64QAM	100	0	100	0	200	≤3	20.24
			1	0	1	99	2	≤8.5	14.57
			1	99	1	0	2	≤3	20.3
41292	41490	QPSK	100	0	100	0	200	≤2	21.47
			1	0	1	99	2	≤8.5	14.23
			1	99	1	0	2	≤0	23.09
		16QAM	100	0	100	0	200	≤3	20.23
			1	0	1	99	2	≤8.5	14.7
			1	99	1	0	2	≤1	22.47
		64QAM	100	0	100	0	200	≤3	20.29
			1	0	1	99	2	≤8.5	14.47
			1	99	1	0	2	≤1	20.43

CA_41C_ANT 13									
Combination 20MHz+15MHz (100RB+75RB)									
PCC Channel	SCC Channel	Modulation	PCC		SCC		Total RB Size	Target MPR Level (dB)	Measured Power (dBm)
			RB Size	RB offset	RB Size	RB offset			
39750	39921	QPSK	100	0	75	0	175	≤2	21.31
		QPSK	1	0	1	74	2	≤8.5	14.12
		QPSK	1	99	1	0	2	≤0	22.95
		16QAM	100	0	75	0	175	≤3	20.07
		16QAM	1	0	1	74	2	≤8.5	14.42
		16QAM	1	99	1	0	2	≤1	22.2
		64QAM	100	0	75	0	175	≤3	20.15



40546	40717	64QAM	1	0	1	74	2	≤8.5	14.33
		64QAM	1	99	1	0	2	≤1	20.14
		QPSK	100	0	75	0	175	≤2	21.4
		QPSK	1	0	1	74	2	≤8.5	14.14
		QPSK	1	99	1	0	2	≤0	23.14
		16QAM	100	0	75	0	175	≤3	20.16
		16QAM	1	0	1	74	2	≤8.5	14.62
		16QAM	1	99	1	0	2	≤1	22.37
		64QAM	100	0	75	0	175	≤3	20.18
		64QAM	1	0	1	74	2	≤8.5	14.4
41341	41512	64QAM	1	99	1	0	2	≤1	20.13
		QPSK	100	0	75	0	175	≤2	21.42
		QPSK	1	0	1	74	2	≤8.5	14.24
		QPSK	1	99	1	0	2	≤0	22.91
		16QAM	100	0	75	0	175	≤3	20.22
		16QAM	1	0	1	74	2	≤8.5	14.62
		16QAM	1	99	1	0	2	≤1	22.47
		64QAM	100	0	75	0	175	≤3	20.22
		64QAM	1	0	1	74	2	≤8.5	14.49
		64QAM	1	99	1	0	2	≤1	20.44
Combination 15MHz+20MHz (75RB+100RB)									
PCC Channel	SCC Channel	Modulation	PCC		SCC		Total RB Size	Target MPR Level (dB)	Measured Power (dBm)
			RB Size	RB offset	RB Size	RB offset			
39728	39899	QPSK	75	0	100	0	175	≤2	21.2
		QPSK	1	0	1	99	2	≤8.5	13.99
		QPSK	1	74	1	0	2	≤0	22.86
		16QAM	75	0	100	0	175	≤3	20.23
		16QAM	1	0	1	99	2	≤8.5	14.49
		16QAM	1	74	1	0	2	≤1	22.29
		64QAM	75	0	100	0	175	≤3	20.11
		64QAM	1	0	1	99	2	≤8.5	14.37
		64QAM	1	74	1	0	2	≤1	20.18
40523	40694	QPSK	75	0	100	0	175	≤2	21.53
		QPSK	1	0	1	99	2	≤8.5	14.14
		QPSK	1	74	1	0	2	≤0	23.13
		16QAM	75	0	100	0	175	≤3	20.3
		16QAM	1	0	1	99	2	≤8.5	14.46
		16QAM	1	74	1	0	2	≤1	22.35
		64QAM	75	0	100	0	175	≤3	20.18
		64QAM	1	0	1	99	2	≤8.5	14.42
		64QAM	1	74	1	0	2	≤1	20.29
41319	41490	QPSK	75	0	100	0	175	≤2	21.49
		QPSK	1	0	1	99	2	≤8.5	14.12
		QPSK	1	74	1	0	2	≤0	22.92
		16QAM	75	0	100	0	175	≤3	20.22
		16QAM	1	0	1	99	2	≤8.5	14.66



		16QAM	1	74	1	0	2	≤1	22.41
		64QAM	75	0	100	0	175	≤3	20.26
		64QAM	1	0	1	99	2	≤8.5	14.43
		64QAM	1	74	1	0	2	≤1	20.45
Combination 20MHz+10MHz (100RB+50RB)									
PCC Channel	SCC Channel	Modulation	PCC		SCC		Total RB Size	Target MPR Level (dB)	Measured Power (dBm)
			RB Size	RB offset	RB Size	RB offset			
39750	39894	QPSK	100	0	50	0	150	≤2	21.33
		QPSK	1	0	1	49	2	≤8.5	14.08
		QPSK	1	99	1	0	2	≤0	23.03
		16QAM	100	0	50	0	150	≤3	20.16
		16QAM	1	0	1	49	2	≤8.5	14.48
		16QAM	1	99	1	0	2	≤1	22.37
		64QAM	100	0	50	0	150	≤3	20.02
		64QAM	1	0	1	49	2	≤8.5	14.27
40571	40715	QPSK	100	0	50	0	150	≤2	21.46
		QPSK	1	0	1	49	2	≤8.5	14.21
		QPSK	1	99	1	0	2	≤0	23.03
		16QAM	100	0	50	0	150	≤3	20.15
		16QAM	1	0	1	49	2	≤8.5	14.48
		16QAM	1	99	1	0	2	≤1	22.39
		64QAM	100	0	50	0	150	≤3	20.09
		64QAM	1	0	1	49	2	≤8.5	14.4
41391	41535	QPSK	100	0	50	0	150	≤2	21.3
		QPSK	1	0	1	49	2	≤8.5	14.24
		QPSK	1	99	1	0	2	≤0	22.98
		16QAM	100	0	50	0	150	≤3	20.05
		16QAM	1	0	1	49	2	≤8.5	14.69
		16QAM	1	99	1	0	2	≤1	22.34
		64QAM	100	0	50	0	150	≤3	20.2
		64QAM	1	0	1	49	2	≤8.5	14.48
39705	39849	QPSK	50	0	100	0	150	≤2	21.24
		QPSK	1	0	1	99	2	≤8.5	13.94
		QPSK	1	49	1	0	2	≤0	22.89
		16QAM	50	0	100	0	150	≤3	20.05
		16QAM	1	0	1	99	2	≤8.5	14.42
		16QAM	1	49	1	0	2	≤1	22.19
		64QAM	50	0	100	0	150	≤3	20.06
		64QAM	1	0	1	99	2	≤8.5	14.36
Combination 10MHz+20MHz (50RB+100RB)									
PCC Channel	SCC Channel	Modulation	PCC		SCC		Total RB Size	Target MPR Level (dB)	Measured Power (dBm)
			RB Size	RB offset	RB Size	RB offset			



40526	40670	64QAM	1	49	1	0	2	≤1	20.29		
		QPSK	50	0	100	0	150	≤2	21.57		
		QPSK	1	0	1	99	2	≤8.5	14.11		
		QPSK	1	49	1	0	2	≤0	22.98		
		16QAM	50	0	100	0	150	≤3	20.17		
		16QAM	1	0	1	99	2	≤8.5	14.54		
		16QAM	1	49	1	0	2	≤1	22.39		
		64QAM	50	0	100	0	150	≤3	20.06		
		64QAM	1	0	1	99	2	≤8.5	14.48		
41346	41490	64QAM	1	49	1	0	2	≤1	20.25		
		QPSK	50	0	100	0	150	≤2	21.43		
		QPSK	1	0	1	99	2	≤8.5	14.24		
		QPSK	1	49	1	0	2	≤0	23.02		
		16QAM	50	0	100	0	150	≤3	20.21		
		16QAM	1	0	1	99	2	≤8.5	14.56		
		16QAM	1	49	1	0	2	≤1	22.47		
		64QAM	50	0	100	0	150	≤3	20.14		
		64QAM	1	0	1	99	2	≤8.5	14.42		
39750	39867	64QAM	1	49	1	0	2	≤1	20.25		
		Combination 20MHz+5MHz (100RB+25RB)									
		PCC Channel	SCC Channel	Modulation	PCC		SCC		Total RB Size	Target MPR Level (dB)	Measured Power (dBm)
					RB Size	RB offset	RB Size	RB offset			
		40595	40712	QPSK	100	0	25	0	125	≤2	21.28
				QPSK	1	0	1	24	2	≤8.5	13.95
				QPSK	1	99	1	0	2	≤0	22.9
				16QAM	100	0	25	0	125	≤3	20.06
				16QAM	1	0	1	24	2	≤8.5	14.46
16QAM	1			99	1	0	2	≤1	22.31		
64QAM	100			0	25	0	125	≤3	20.03		
64QAM	1			0	1	24	2	≤8.5	14.35		
64QAM	1			99	1	0	2	≤1	20.2		
41440	41557	QPSK	100	0	25	0	125	≤2	21.57		
		QPSK	1	0	1	24	2	≤8.5	14.07		
		QPSK	1	99	1	0	2	≤0	23.07		
		16QAM	100	0	25	0	125	≤3	20.15		
		16QAM	1	0	1	24	2	≤8.5	14.53		
		16QAM	1	99	1	0	2	≤1	22.36		
		64QAM	100	0	25	0	125	≤3	20.1		
		64QAM	1	0	1	24	2	≤8.5	14.56		
		64QAM	1	99	1	0	2	≤1	20.14		
41440	41557	QPSK	100	0	25	0	125	≤2	21.48		
		QPSK	1	0	1	24	2	≤8.5	14.25		
		QPSK	1	99	1	0	2	≤0	23.06		
		16QAM	100	0	25	0	125	≤3	20.24		
		16QAM	1	0	1	24	2	≤8.5	14.66		
		16QAM	1	99	1	0	2	≤1	22.47		



		64QAM	100	0	25	0	125	≤3	20.27
		64QAM	1	0	1	24	2	≤8.5	14.37
		64QAM	1	99	1	0	2	≤1	20.25
Combination 5MHz+20MHz (25RB+100RB)									
PCC Channel	SCC Channel	Modulation	PCC		SCC		Total RB Size	Target MPR Level (dB)	Measured Power (dBm)
			RB Size	RB offset	RB Size	RB offset			
39683	39800	QPSK	25	0	100	0	125	≤2	21.34
		QPSK	1	0	1	99	2	≤8.5	14.06
		QPSK	1	24	1	0	2	≤0	22.98
		16QAM	25	0	100	0	125	≤3	20.25
		16QAM	1	0	1	99	2	≤8.5	14.35
		16QAM	1	24	1	0	2	≤1	22.34
		64QAM	25	0	100	0	125	≤3	20.14
		64QAM	1	0	1	99	2	≤8.5	14.4
		64QAM	1	24	1	0	2	≤1	20.25
40528	40645	QPSK	25	0	100	0	125	≤2	21.45
		QPSK	1	0	1	99	2	≤8.5	14.2
		QPSK	1	24	1	0	2	≤0	22.94
		16QAM	25	0	100	0	125	≤3	20.28
		16QAM	1	0	1	99	2	≤8.5	14.51
		16QAM	1	24	1	0	2	≤1	22.3
		64QAM	25	0	100	0	125	≤3	20.24
		64QAM	1	0	1	99	2	≤8.5	14.47
		64QAM	1	24	1	0	2	≤1	20.17
41373	41490	QPSK	25	0	100	0	125	≤2	21.34
		QPSK	1	0	1	99	2	≤8.5	14.11
		QPSK	1	24	1	0	2	≤0	22.99
		16QAM	25	0	100	0	125	≤3	20.09
		16QAM	1	0	1	99	2	≤8.5	14.59
		16QAM	1	24	1	0	2	≤1	22.44
		64QAM	25	0	100	0	125	≤3	20.23
		64QAM	1	0	1	99	2	≤8.5	14.36
		64QAM	1	24	1	0	2	≤1	20.27
Combination 15MHz+10MHz (75RB+50RB)									
PCC Channel	SCC Channel	Modulation	PCC		SCC		Total RB Size	Target MPR Level (dB)	Measured Power (dBm)
			RB Size	RB offset	RB Size	RB offset			
39725	39845	QPSK	75	0	50	0	125	≤2	21.39
		QPSK	1	0	1	49	2	≤8.5	14.02
		QPSK	1	74	1	0	2	≤0	22.95
		16QAM	75	0	50	0	125	≤3	20.22
		16QAM	1	0	1	49	2	≤8.5	14.48
		16QAM	1	74	1	0	2	≤1	22.28
		64QAM	75	0	50	0	125	≤3	20.06
		64QAM	1	0	1	49	2	≤8.5	14.33
		64QAM	1	74	1	0	2	≤1	20.18



40571	40691	QPSK	75	0	50	0	125	≤2	21.5
		QPSK	1	0	1	49	2	≤8.5	14.12
		QPSK	1	74	1	0	2	≤0	23.04
		16QAM	75	0	50	0	125	≤3	20.2
		16QAM	1	0	1	49	2	≤8.5	14.45
		16QAM	1	74	1	0	2	≤1	22.46
		64QAM	75	0	50	0	125	≤3	20.19
		64QAM	1	0	1	49	2	≤8.5	14.55
		64QAM	1	74	1	0	2	≤1	20.3
41417	41537	QPSK	75	0	50	0	125	≤2	21.31
		QPSK	1	0	1	49	2	≤8.5	14.08
		QPSK	1	74	1	0	2	≤0	23.08
		16QAM	75	0	50	0	125	≤3	20.19
		16QAM	1	0	1	49	2	≤8.5	14.64
		16QAM	1	74	1	0	2	≤1	22.45
		64QAM	75	0	50	0	125	≤3	20.26
		64QAM	1	0	1	49	2	≤8.5	14.49
		64QAM	1	74	1	0	2	≤1	20.35
Combination 10MHz+15MHz (50RB+75RB)									
PCC Channel	SCC Channel	Modulation	PCC		SCC		Total RB Size	Target MPR Level (dB)	Measured Power (dBm)
			RB Size	RB offset	RB Size	RB offset			
39703	39823	QPSK	50	0	75	0	125	≤2	21.3
		QPSK	1	49	1	0	2	≤8.5	14.1
		QPSK	1	0	1	74	2	≤0	22.92
		16QAM	50	0	75	0	125	≤3	20.21
		16QAM	1	49	1	0	2	≤8.5	14.52
		16QAM	1	0	1	74	2	≤1	22.29
		64QAM	50	0	75	0	125	≤3	20.03
		64QAM	1	49	1	0	2	≤8.5	14.3
		64QAM	1	0	1	74	2	≤1	20.28
40549	40669	QPSK	50	0	75	0	125	≤2	21.52
		QPSK	1	49	1	0	2	≤8.5	14.21
		QPSK	1	0	1	74	2	≤0	23.08
		16QAM	50	0	75	0	125	≤3	20.21
		16QAM	1	49	1	0	2	≤8.5	14.5
		16QAM	1	0	1	74	2	≤1	22.41
		64QAM	50	0	75	0	125	≤3	20.15
		64QAM	1	49	1	0	2	≤8.5	14.44
		64QAM	1	0	1	74	2	≤1	20.16
41395	41515	QPSK	50	0	75	0	125	≤2	21.35
		QPSK	1	49	1	0	2	≤8.5	14.11
		QPSK	1	0	1	74	2	≤0	22.93
		16QAM	50	0	75	0	125	≤3	20.08
		16QAM	1	49	1	0	2	≤8.5	14.62
		16QAM	1	0	1	74	2	≤1	22.48
		64QAM	50	0	75	0	125	≤3	20.31



PCC Channel	SCC Channel	Modulation	PCC		SCC		Total RB Size	Target MPR Level (dB)	Measured Power (dBm)
			RB Size	RB offset	RB Size	RB offset			
		64QAM	1	49	1	0	2	≤8.5	14.44
		64QAM	1	0	1	74	2	≤1	20.33
Combination 15MHz+15MHz (75RB+75RB)									
39725	39875	QPSK	75	0	75	0	150	≤2	21.31
		QPSK	1	0	1	74	2	≤8.5	13.95
		QPSK	1	74	1	0	2	≤0	22.99
		16QAM	75	0	75	0	150	≤3	20.2
		16QAM	1	0	1	74	2	≤8.5	14.49
		16QAM	1	74	1	0	2	≤1	22.33
		64QAM	75	0	75	0	150	≤3	20.05
		64QAM	1	0	1	74	2	≤8.5	14.29
		64QAM	1	74	1	0	2	≤1	20.14
40545	40695	QPSK	75	0	75	0	150	≤2	21.4
		QPSK	1	0	1	74	2	≤8.5	14.1
		QPSK	1	74	1	0	2	≤0	23.08
		16QAM	75	0	75	0	150	≤3	20.14
		16QAM	1	0	1	74	2	≤8.5	14.5
		16QAM	1	74	1	0	2	≤1	22.34
		64QAM	75	0	75	0	150	≤3	20.25
		64QAM	1	0	1	74	2	≤8.5	14.49
64QAM	1	74	1	0	2	≤1	20.25		
41365	41515	QPSK	75	0	75	0	150	≤2	21.43
		QPSK	1	0	1	74	2	≤8.5	14.22
		QPSK	1	74	1	0	2	≤0	22.93
		16QAM	75	0	75	0	150	≤3	20.22
		16QAM	1	0	1	74	2	≤8.5	14.68
		16QAM	1	74	1	0	2	≤1	22.29
		64QAM	75	0	75	0	150	≤3	20.3
		64QAM	1	0	1	74	2	≤8.5	14.43
64QAM	1	74	1	0	2	≤1	20.36		



ERP/EIRP

LTE Band 7 (GT - LC = 0.99 dB) QPSK			
Bandwidth	5M		
Channel	20775	21100	21425
	(Low)	(Mid)	(High)
Frequency	2502.5	2535	2567.5
(MHz)			
Conducted Power (dBm)	23.34	23.35	23.23
Conducted Power (Watts)	0.2158	0.2163	0.2104
EIRP(dBm)	24.33	24.34	24.22
EIRP(Watts)	0.2710	0.2716	0.2642

LTE Band 7 (GT - LC = 0.99 dB) QPSK									
Bandwidth	10M			15M			20M		
Channel	20800	21100	21400	20825	21100	21375	20850	21100	21350
	(Low)	(Mid)	(High)	(Low)	(Mid)	(High)	(Low)	(Mid)	(High)
Frequency	2505	2535	2565	2507.5	2535	2562.5	2510	2535	2560
(MHz)									
Conducted Power (dBm)	23.17	23.32	23.17	23.29	23.28	23.32	23.34	23.47	23.31
Conducted Power (Watts)	0.2075	0.2148	0.2075	0.2133	0.2128	0.2148	0.2158	0.2223	0.2143
EIRP(dBm)	24.16	24.31	24.16	24.28	24.27	24.31	24.33	24.46	24.30
EIRP(Watts)	0.2606	0.2698	0.2606	0.2679	0.2673	0.2698	0.2710	0.2793	0.2692



LTE Band 7 (GT - LC = 0.99 dB) 16QAM			
Bandwidth	5M		
Channel	20775	21100	21425
	(Low)	(Mid)	(High)
Frequency (MHz)	2502.5	2535	2567.5
	Conducted Power (dBm)	22.60	22.70
Conducted Power (Watts)	0.1820	0.1862	0.1702
EIRP(dBm)	23.59	23.69	23.30
EIRP(Watts)	0.2286	0.2339	0.2138

LTE Band 7 (GT - LC = 0.99 dB) 16QAM									
Bandwidth	10M			15M			20M		
Channel	20800	21100	21400	20825	21100	21375	20850	21100	21350
	(Low)	(Mid)	(High)	(Low)	(Mid)	(High)	(Low)	(Mid)	(High)
Frequency (MHz)	2505	2535	2565	2507.5	2535	2562.5	2510	2535	2560
	Conducted Power (dBm)	22.60	22.59	22.25	22.56	22.60	22.27	22.72	22.74
Conducted Power (Watts)	0.1820	0.1816	0.1679	0.1803	0.1820	0.1687	0.1871	0.1879	0.1718
EIRP(dBm)	23.59	23.58	23.24	23.55	23.59	23.26	23.71	23.73	23.34
EIRP(Watts)	0.2286	0.2280	0.2109	0.2265	0.2286	0.2118	0.2350	0.2360	0.2158



LTE Band 7 (GT - LC = 0.99 dB) 64QAM			
Bandwidth	5M		
Channel	20775	21100	21425
	(Low)	(Mid)	(High)
Frequency (MHz)	2502.5	2535	2567.5
	Conducted Power (dBm)	21.54	21.39
Conducted Power (Watts)	0.1426	0.1377	0.1393
EIRP(dBm)	22.53	22.38	22.43
EIRP(Watts)	0.1791	0.1730	0.1750

LTE Band 7 (GT - LC = 0.99 dB) 64QAM									
Bandwidth	10M			15M			20M		
Channel	20800	21100	21400	20825	21100	21375	20850	21100	21350
	(Low)	(Mid)	(High)	(Low)	(Mid)	(High)	(Low)	(Mid)	(High)
Frequency (MHz)	2505	2535	2565	2507.5	2535	2562.5	2510	2535	2560
	Conducted Power (dBm)	21.55	21.39	21.44	21.41	21.45	21.45	21.71	21.54
Conducted Power (Watts)	0.1429	0.1377	0.1393	0.1384	0.1396	0.1396	0.1483	0.1426	0.1400
EIRP(dBm)	22.54	22.38	22.43	22.40	22.44	22.44	22.70	22.53	22.45
EIRP(Watts)	0.1795	0.1730	0.1750	0.1738	0.1754	0.1754	0.1862	0.1791	0.1758



LTE Band 38 (GT - LC = 1.12 dB) QPSK			
Bandwidth	5M		
Channel	37775	38000	38225
	(Low)	(Mid)	(High)
Frequency	2572.5	2595	2617.5
(MHz)			
Conducted Power (dBm)	23.30	23.13	23.41
Conducted Power (Watts)	0.2138	0.2056	0.2193
EIRP(dBm)	24.42	24.25	24.53
EIRP(Watts)	0.2767	0.2661	0.2838

LTE Band 38 (GT - LC = 1.12 dB) QPSK									
Bandwidth	10M			15M			20M		
Channel	37800	38000	38200	37825	38000	38175	37850	38000	38150
	(Low)	(Mid)	(High)	(Low)	(Mid)	(High)	(Low)	(Mid)	(Mid)
Frequency	2575	2595	2615	2577.5	2595	2612.5	2580	2595	2610
(MHz)									
Conducted Power (dBm)	23.31	23.09	23.42	23.13	23.10	23.42	23.39	23.43	23.34
Conducted Power (Watts)	0.2143	0.2037	0.2198	0.2056	0.2042	0.2198	0.2183	0.2203	0.2158
EIRP(dBm)	24.43	24.21	24.54	24.25	24.22	24.54	24.51	24.55	24.46
EIRP(Watts)	0.2773	0.2636	0.2844	0.2661	0.2642	0.2844	0.2825	0.2851	0.2793



LTE Band 38 (GT - LC = 1.12 dB) 16QAM			
Bandwidth	5M		
Channel	37775	38000	38225
	(Low)	(Mid)	(High)
Frequency	2572.5	2595	2617.5
(MHz)			
Conducted Power (dBm)	22.48	22.34	22.40
Conducted Power (Watts)	0.1770	0.1714	0.1738
EIRP(dBm)	23.60	23.46	23.52
EIRP(Watts)	0.2291	0.2218	0.2249

LTE Band 38 (GT - LC = 1.12 dB) 16QAM									
Bandwidth	10M			15M			20M		
Channel	37800	38000	38200	37825	38000	38175	37850	38000	38150
	(Low)	(Mid)	(High)	(Low)	(Mid)	(High)	(Low)	(Mid)	(Mid)
Frequency	2575	2595	2615	2577.5	2595	2612.5	2580	2595	2610
(MHz)									
Conducted Power (dBm)	22.51	22.27	22.50	22.52	22.30	22.50	22.54	22.41	22.51
Conducted Power (Watts)	0.1782	0.1687	0.1778	0.1786	0.1698	0.1778	0.1795	0.1742	0.1782
EIRP(dBm)	23.63	23.39	23.62	23.64	23.42	23.62	23.66	23.53	23.63
EIRP(Watts)	0.2307	0.2183	0.2301	0.2312	0.2198	0.2301	0.2323	0.2254	0.2307



LTE Band 38 (GT - LC = 1.12 dB) 64QAM			
Bandwidth	5M		
Channel	37775	38000	38225
	(Low)	(Mid)	(High)
Frequency (MHz)	2572.5	2595	2617.5
	Conducted Power (dBm)	21.21	21.14
Conducted Power (Watts)	0.1321	0.1300	0.1276
EIRP(dBm)	22.33	22.26	22.18
EIRP(Watts)	0.1710	0.1683	0.1652

LTE Band 38 (GT - LC = 1.12 dB) 64QAM									
Bandwidth	10M			15M			20M		
Channel	37800	38000	38200	37825	38000	38175	37850	38000	38150
	(Low)	(Mid)	(High)	(Low)	(Mid)	(High)	(Low)	(Mid)	(Mid)
Frequency (MHz)	2575	2595	2615	2577.5	2595	2612.5	2580	2595	2610
	Conducted Power (dBm)	21.32	21.08	21.10	21.29	21.07	20.97	21.37	21.13
Conducted Power (Watts)	0.1355	0.1282	0.1288	0.1346	0.1279	0.1250	0.1371	0.1297	0.1288
EIRP(dBm)	22.44	22.20	22.22	22.41	22.19	22.09	22.49	22.25	22.22
EIRP(Watts)	0.1754	0.1660	0.1667	0.1742	0.1656	0.1618	0.1774	0.1679	0.1667



LTE Band 41 (G _T - L _C = 1.15dB) QPSK									
Bandwidth	5M			10M			15M		
Channel	39675	40620	41565	39700	40620	41540	39725	40620	41515
	(Low)	(Mid)	(High)	(Low)	(Mid)	(High)	(Low)	(Mid)	(High)
Frequency (MHz)	2498.5	2593	2687.5	2501	2593	2685	2503.5	2593	2682.5
Conducted Power (dBm)	23.12	23.22	23.26	22.96	23.10	23.21	23.20	23.09	23.34
Conducted Power (Watts)	0.2051	0.2099	0.2118	0.1977	0.2042	0.2094	0.2089	0.2037	0.2158
EIRP(dBm)	24.27	24.37	24.41	24.11	24.25	24.36	24.35	24.24	24.49
EIRP(Watts)	0.2673	0.2735	0.2761	0.2576	0.2661	0.2729	0.2723	0.2655	0.2812

LTE Band 41 (G _T - L _C = 1.15dB) QPSK			
Bandwidth	20M		
Channel	39750	40620	41490
	(Low)	(Mid)	(High)
Frequency (MHz)	2506	2593	2680
Conducted Power (dBm)	23.19	23.44	23.32
Conducted Power (Watts)	0.2084	0.2208	0.2148
EIRP(dBm)	24.34	24.59	24.47
EIRP(Watts)	0.2716	0.2877	0.2799



LTE Band 41 (G _T - L _C = 1.15dB) 16QAM									
Bandwidth	5M			10M			15M		
Channel	39675	40620	41565	39700	40620	41540	39725	40620	41515
	(Low)	(Mid)	(High)	(Low)	(Mid)	(High)	(Low)	(Mid)	(High)
Frequency	2498.5	2593	2687.5	2501	2593	2685	2503.5	2593	2682.5
(MHz)									
Conducted Power (dBm)	22.17	22.17	22.20	22.08	22.18	22.22	22.25	22.12	22.30
Conducted Power (Watts)	0.1648	0.1648	0.1660	0.1614	0.1652	0.1667	0.1679	0.1629	0.1698
EIRP(dBm)	23.32	23.32	23.35	23.23	23.33	23.37	23.40	23.27	23.45
EIRP(Watts)	0.2148	0.2148	0.2163	0.2104	0.2153	0.2173	0.2188	0.2123	0.2213

LTE Band 41 (G _T - L _C = 1.15dB) 16QAM			
Bandwidth	20M		
Channel	39750	40620	41490
	(Low)	(Mid)	(High)
Frequency	2506	2593	2680
(MHz)			
Conducted Power (dBm)	22.23	22.30	22.30
Conducted Power (Watts)	0.1671	0.1698	0.1698
EIRP(dBm)	23.38	23.45	23.45
EIRP(Watts)	0.2178	0.2213	0.2213



LTE Band 41 (G _T - L _C = 1.15dB) 64QAM									
Bandwidth	5M			10M			15M		
Channel	39675	40620	41565	39700	40620	41540	39725	40620	41515
	(Low)	(Mid)	(High)	(Low)	(Mid)	(High)	(Low)	(Mid)	(High)
Frequency (MHz)	2498.5	2593	2687.5	2501	2593	2685	2503.5	2593	2682.5
Conducted Power (dBm)	20.95	20.70	21.04	20.91	20.70	21.08	20.95	20.88	20.84
Conducted Power (Watts)	0.1245	0.1175	0.1271	0.1233	0.1175	0.1282	0.1245	0.1225	0.1213
EIRP(dBm)	22.10	21.85	22.19	22.06	21.85	22.23	22.10	22.03	21.99
EIRP(Watts)	0.1622	0.1531	0.1656	0.1607	0.1531	0.1671	0.1622	0.1596	0.1581

LTE Band 41 (G _T - L _C = 1.15dB) 64QAM			
Bandwidth	20M		
Channel	39750	40620	41490
	(Low)	(Mid)	(High)
Frequency (MHz)	2506	2593	2680
Conducted Power (dBm)	21.08	20.87	21.13
Conducted Power (Watts)	0.1282	0.1222	0.1297
EIRP(dBm)	22.23	22.02	22.28
EIRP(Watts)	0.1671	0.1592	0.1690



CA EIRP

LTE Band 7 CA (GT - LC = 0.99 dB) QPSK									
Bandwidth	15M + 15M			10M + 20M			20M+10M		
Channel PCC	20825	21025	21225	20805	21006	21206	20850	21051	21251
	(Low)	(Mid)	(High)	(Low)	(Mid)	(High)	(Low)	(Mid)	(High)
Channel SCC	20975	21175	21375	20949	21150	21350	20994	21195	21395
	(Low)	(Mid)	(High)	(Low)	(Mid)	(High)	(Low)	(Mid)	(High)
Conducted Power (dBm)	23.1300	23.1700	23.1900	23.1300	23.2400	23.0300	23.0900	22.9100	23.1900
Conducted Power (Watts)	0.2056	0.2075	0.2084	0.2056	0.2109	0.2009	0.2037	0.1954	0.2084
EIRP(dBm)	24.1200	24.1600	24.1800	24.1200	24.2300	24.0200	24.0800	23.9000	24.1800
EIRP(Watts)	0.2582	0.2606	0.2618	0.2582	0.2649	0.2523	0.2559	0.2455	0.2618

LTE Band 7 CA (GT - LC = 0.99 dB) QPSK									
Bandwidth	15M+20M			20M+15M			20M + 20M		
Channel PCC	20828	21003	21179	20850	21026	21201	20850	21001	21152
	(Low)	(Mid)	(High)	(Low)	(Mid)	(High)	(Low)	(Mid)	(High)
Channel SCC	20999	21174	21350	21021	21197	21372	21048	21199	21350
	(Low)	(Mid)	(High)	(Low)	(Mid)	(High)	(Low)	(Mid)	(High)
Conducted Power (dBm)	23.0200	23.1600	23.1300	23.1200	23.2900	23.2100	23.2500	23.2700	23.2600
Conducted Power (Watts)	0.2004	0.2070	0.2056	0.2051	0.2133	0.2094	0.2113	0.2123	0.2118
EIRP(dBm)	24.0100	24.1500	24.1200	24.1100	24.2800	24.2000	24.2400	24.2600	24.2500
EIRP(Watts)	0.2518	0.2600	0.2582	0.2576	0.2679	0.2630	0.2655	0.2667	0.2661



LTE Band 7 CA (GT - LC = 0.99 dB) 16QAM									
Bandwidth	15M + 15M			10M + 20M			20M+10M		
Channel PCC	20825	21025	21225	20805	21006	21206	20850	21051	21251
	(Low)	(Mid)	(High)	(Low)	(Mid)	(High)	(Low)	(Mid)	(High)
Channel SCC	20975	21175	21375	20949	21150	21350	20994	21195	21395
	(Low)	(Mid)	(High)	(Low)	(Mid)	(High)	(Low)	(Mid)	(High)
Conducted Power (dBm)	22.1500	22.1800	22.1800	22.0800	22.1700	22.2700	22.1900	22.1300	22.1800
Conducted Power (Watts)	0.1641	0.1652	0.1652	0.1614	0.1648	0.1687	0.1656	0.1633	0.1652
EIRP(dBm)	23.1400	23.1700	23.1700	23.0700	23.1600	23.2600	23.1800	23.1200	23.1700
EIRP(Watts)	0.2061	0.2075	0.2075	0.2028	0.2070	0.2118	0.2080	0.2051	0.2075

LTE Band 7 CA (GT - LC = 0.99 dB) 16QAM									
Bandwidth	15M+20M			20M+15M			20M + 20M		
Channel PCC	20828	21003	21179	20850	21026	21201	20850	21001	21152
	(Low)	(Mid)	(High)	(Low)	(Mid)	(High)	(Low)	(Mid)	(High)
Channel SCC	20999	21174	21350	21021	21197	21372	21048	21199	21350
	(Low)	(Mid)	(High)	(Low)	(Mid)	(High)	(Low)	(Mid)	(High)
Conducted Power (dBm)	22.0500	22.1200	22.1300	22.1800	22.1900	22.2800	22.1300	22.2700	22.2900
Conducted Power (Watts)	0.1603	0.1629	0.1633	0.1652	0.1656	0.1690	0.1633	0.1687	0.1694
EIRP(dBm)	23.0400	23.1100	23.1200	23.1700	23.1800	23.2700	23.1200	23.2600	23.2800
EIRP(Watts)	0.2014	0.2046	0.2051	0.2075	0.2080	0.2123	0.2051	0.2118	0.2128



LTE Band 7 CA (GT - LC = 0.99 dB) 64QAM									
Bandwidth	15M + 15M			10M + 20M			20M+10M		
Channel PCC	20825	21025	21225	20805	21006	21206	20850	21051	21251
	(Low)	(Mid)	(High)	(Low)	(Mid)	(High)	(Low)	(Mid)	(High)
Channel SCC	20975	21175	21375	20949	21150	21350	20994	21195	21395
	(Low)	(Mid)	(High)	(Low)	(Mid)	(High)	(Low)	(Mid)	(High)
Conducted Power (dBm)	20.1400	20.3600	20.2500	20.1400	20.3000	20.2700	20.2500	20.3200	20.2100
Conducted Power (Watts)	0.1033	0.1086	0.1059	0.1033	0.1072	0.1064	0.1059	0.1076	0.1050
EIRP(dBm)	21.1300	21.3500	21.2400	21.1300	21.2900	21.2600	21.2400	21.3100	21.2000
EIRP(Watts)	0.1297	0.1365	0.1330	0.1297	0.1346	0.1337	0.1330	0.1352	0.1318

LTE Band 7 CA (GT - LC = 0.99 dB) 64QAM									
Bandwidth	15M+20M			20M+15M			20M + 20M		
Channel PCC	20828	21003	21179	20850	21026	21201	20850	21001	21152
	(Low)	(Mid)	(High)	(Low)	(Mid)	(High)	(Low)	(Mid)	(High)
Channel SCC	20999	21174	21350	21021	21197	21372	21048	21199	21350
	(Low)	(Mid)	(High)	(Low)	(Mid)	(High)	(Low)	(Mid)	(High)
Conducted Power (dBm)	20.1400	20.2500	20.2500	20.2600	20.3400	20.2700	20.5100	20.5500	20.6000
Conducted Power (Watts)	0.1033	0.1059	0.1059	0.1062	0.1081	0.1064	0.1125	0.1135	0.1148
EIRP(dBm)	21.1300	21.2400	21.2400	21.2500	21.3300	21.2600	21.5000	21.5400	21.5900
EIRP(Watts)	0.1297	0.1330	0.1330	0.1334	0.1358	0.1337	0.1413	0.1426	0.1442



LTE Band 41 CA (GT - LC = 1.15 dB) QPSK									
Bandwidth	15M + 15M			5M + 20M			20M + 5M		
Channel PCC	39725	40545	41365	39683	40528	41373	39750	40595	41440
	(Low)	(Mid)	(High)	(Low)	(Mid)	(High)	(Low)	(Mid)	(High)
Channel SCC	39875	40695	41515	39800	40645	41490	39867	40712	41557
	(Low)	(Mid)	(High)	(Low)	(Mid)	(High)	(Low)	(Mid)	(High)
Conducted Power (dBm)	22.9900	23.0800	22.9300	22.9800	22.9400	22.9900	22.9000	23.0700	23.0600
Conducted Power (Watts)	0.1991	0.2032	0.1963	0.1986	0.1968	0.1991	0.1950	0.2028	0.2023
EIRP(dBm)	24.1400	24.2300	24.0800	24.1300	24.0900	24.1400	24.0500	24.2200	24.2100
EIRP(Watts)	0.2594	0.2649	0.2559	0.2588	0.2564	0.2594	0.2541	0.2642	0.2636

LTE Band 41 CA (GT - LC = 1.15 dB) QPSK									
Bandwidth	10M + 20M			20M + 10M			15M + 20M		
Channel PCC	39705	40526	41346	39750	40571	41391	39728	40523	41319
	(Low)	(Mid)	(High)	(Low)	(Mid)	(High)	(Low)	(Mid)	(High)
Channel SCC	39849	40670	41490	39894	40715	41535	39899	40694	41490
	(Low)	(Mid)	(High)	(Low)	(Mid)	(High)	(Low)	(Mid)	(High)
Conducted Power (dBm)	22.8900	22.9800	23.0200	23.0300	23.0300	22.9800	22.8600	23.1300	22.9200
Conducted Power (Watts)	0.1945	0.1986	0.2004	0.2009	0.2009	0.1986	0.1932	0.2056	0.1959
EIRP(dBm)	24.0400	24.1300	24.1700	24.1800	24.1800	24.1300	24.0100	24.2800	24.0700
EIRP(Watts)	0.2535	0.2588	0.2612	0.2618	0.2618	0.2588	0.2518	0.2679	0.2553



LTE Band 41 CA (GT - LC = 1.15 dB) QPSK						
Bandwidth	20M+15M			20M+20M		
Channel PCC	39750	40546	41341	39750	40521	41292
	(Low)	(Mid)	(High)	(Low)	(Mid)	(High)
Channel SCC	39921	40717	41512	39948	40719	41490
	(Low)	(Mid)	(High)	(Low)	(Mid)	(High)
Conducted Power (dBm)	22.9500	23.1400	22.9100	23.0300	23.1200	23.0900
Conducted Power (Watts)	0.1972	0.2061	0.1954	0.2009	0.2051	0.2037
EIRP(dBm)	24.1000	24.2900	24.0600	24.1800	24.2700	24.2400
EIRP(Watts)	0.2570	0.2685	0.2547	0.2618	0.2673	0.2655

LTE Band 41 CA (GT - LC = 1.15 dB) QPSK						
Bandwidth	15M+10M			10M+15M		
Channel PCC	39725	40571	41417	39703	40549	41395
	(Low)	(Mid)	(High)	(Low)	(Mid)	(High)
Channel SCC	39845	40691	41537	39823	40669	41490
	(Low)	(Mid)	(High)	(Low)	(Mid)	(High)
Conducted Power (dBm)	22.9500	23.0400	23.0800	22.9200	23.0800	22.9300
Conducted Power (Watts)	0.1972	0.2014	0.2032	0.1959	0.2032	0.1963
EIRP(dBm)	24.1000	24.1900	24.2300	24.0700	24.2300	24.0800
EIRP(Watts)	0.2570	0.2624	0.2649	0.2553	0.2649	0.2559

LTE Band 41 CA (GT - LC = 1.15 dB) 16QAM									
Bandwidth	15M + 15M			5M + 20M			20M + 5M		
Channel PCC	39725	40545	41365	39683	40528	41373	39750	40595	41440
	(Low)	(Mid)	(High)	(Low)	(Mid)	(High)	(Low)	(Mid)	(High)
Channel SCC	39875	40695	41515	39800	40645	41490	39867	40712	41557
	(Low)	(Mid)	(High)	(Low)	(Mid)	(High)	(Low)	(Mid)	(High)
Conducted Power (dBm)	22.3300	22.3400	22.2900	22.3400	22.3000	22.4400	22.3100	22.3600	22.4700
Conducted Power (Watts)	0.1710	0.1714	0.1694	0.1714	0.1698	0.1754	0.1702	0.1722	0.1766
EIRP(dBm)	23.4800	23.4900	23.4400	23.4900	23.4500	23.5900	23.4600	23.5100	23.6200
EIRP(Watts)	0.2228	0.2234	0.2208	0.2234	0.2213	0.2286	0.2218	0.2244	0.2301



LTE Band 41 CA (GT - LC = 1.15 dB) 16QAM									
Bandwidth	10M + 20M			20M + 10M			15M + 20M		
Channel PCC	39705	40526	41346	39750	40571	41391	39728	40523	41319
	(Low)	(Mid)	(High)	(Low)	(Mid)	(High)	(Low)	(Mid)	(High)
Channel SCC	39849	40670	41490	39894	40715	41535	39899	40694	41490
	(Low)	(Mid)	(High)	(Low)	(Mid)	(High)	(Low)	(Mid)	(High)
Conducted Power (dBm)	22.1900	22.3900	22.4700	22.3700	22.3900	22.3400	22.2900	22.3500	22.4100
Conducted Power (Watts)	0.1656	0.1734	0.1766	0.1726	0.1734	0.1714	0.1694	0.1718	0.1742
EIRP(dBm)	23.3400	23.5400	23.6200	23.5200	23.5400	23.4900	23.4400	23.5000	23.5600
EIRP(Watts)	0.2158	0.2259	0.2301	0.2249	0.2259	0.2234	0.2208	0.2239	0.2270

LTE Band 41 CA (GT - LC = 1.15 dB) 16QAM						
Bandwidth	20M+15M			20M+20M		
Channel PCC	39750	40546	41341	39750	40521	41292
	(Low)	(Mid)	(High)	(Low)	(Mid)	(High)
Channel SCC	39921	40717	41512	39948	40719	41490
	(Low)	(Mid)	(High)	(Low)	(Mid)	(High)
Conducted Power (dBm)	22.2000	22.3700	22.4700	22.3500	22.4800	22.4700
Conducted Power (Watts)	0.1660	0.1726	0.1766	0.1718	0.1770	0.1766
EIRP(dBm)	23.3500	23.5200	23.6200	23.5000	23.6300	23.6200
EIRP(Watts)	0.2163	0.2249	0.2301	0.2239	0.2307	0.2301

LTE Band 41 CA (GT - LC = 1.15 dB) 16QAM						
Bandwidth	15M+10M			10M+15M		
Channel PCC	39725	40571	41417	39703	40549	41395
	(Low)	(Mid)	(High)	(Low)	(Mid)	(High)
Channel SCC	39845	40691	41537	39823	40669	41490
	(Low)	(Mid)	(High)	(Low)	(Mid)	(High)
Conducted Power (dBm)	22.2800	22.4600	22.4500	22.2900	22.4100	22.4800
Conducted Power (Watts)	0.1690	0.1762	0.1758	0.1694	0.1742	0.1770
EIRP(dBm)	23.4300	23.6100	23.6000	23.4400	23.5600	23.6300
EIRP(Watts)	0.2203	0.2296	0.2291	0.2208	0.2270	0.2307



LTE Band 41 CA (GT - LC = 1.15 dB) 64QAM									
Bandwidth	15M + 15M			5M + 20M			20M + 5M		
Channel PCC	39725	40545	41365	39683	40528	41373	39750	40595	41440
	(Low)	(Mid)	(High)	(Low)	(Mid)	(High)	(Low)	(Mid)	(High)
Channel SCC	39875	40695	41515	39800	40645	41490	39867	40712	41557
	(Low)	(Mid)	(High)	(Low)	(Mid)	(High)	(Low)	(Mid)	(High)
Conducted Power (dBm)	20.1400	20.2500	20.3600	20.2500	20.2400	20.2700	20.2000	20.1400	20.2700
Conducted Power (Watts)	0.1033	0.1059	0.1086	0.1059	0.1057	0.1064	0.1047	0.1033	0.1064
EIRP(dBm)	21.2900	21.4000	21.5100	21.4000	21.3900	21.4200	21.3500	21.2900	21.4200
EIRP(Watts)	0.1346	0.1380	0.1416	0.1380	0.1377	0.1387	0.1365	0.1346	0.1387

LTE Band 41 CA (GT - LC = 1.15 dB) 64QAM									
Bandwidth	10M + 20M			20M + 10M			15M + 20M		
Channel PCC	39705	40526	41346	39750	40571	41391	39728	40523	41319
	(Low)	(Mid)	(High)	(Low)	(Mid)	(High)	(Low)	(Mid)	(High)
Channel SCC	39849	40670	41490	39894	40715	41535	39899	40694	41490
	(Low)	(Mid)	(High)	(Low)	(Mid)	(High)	(Low)	(Mid)	(High)
Conducted Power (dBm)	20.2900	20.2500	20.2500	20.2000	20.1900	20.3900	20.1800	20.2900	20.4500
Conducted Power (Watts)	0.1069	0.1059	0.1059	0.1047	0.1045	0.1094	0.1042	0.1069	0.1109
EIRP(dBm)	21.4400	21.4000	21.4000	21.3500	21.3400	21.5400	21.3300	21.4400	21.6000
EIRP(Watts)	0.1393	0.1380	0.1380	0.1365	0.1361	0.1426	0.1358	0.1393	0.1445

LTE Band 41 CA (GT - LC = 1.15 dB) 64QAM						
Bandwidth	20M+15M			20M+20M		
Channel PCC	39750	40546	41341	39750	40521	41292
	(Low)	(Mid)	(High)	(Low)	(Mid)	(High)
Channel SCC	39921	40717	41512	39948	40719	41490
	(Low)	(Mid)	(High)	(Low)	(Mid)	(High)
Conducted Power (dBm)	20.1500	20.1800	20.4400	20.2700	20.3000	20.4300
Conducted Power (Watts)	0.1035	0.1042	0.1107	0.1064	0.1072	0.1104
EIRP(dBm)	21.3000	21.3300	21.5900	21.4200	21.4500	21.5800
EIRP(Watts)	0.1349	0.1358	0.1442	0.1387	0.1396	0.1439



LTE Band 41 CA (GT - LC = 1.15 dB) 64QAM						
Bandwidth	15M+10M			10M+15M		
Channel PCC	39725	40571	41417	39703	40549	41395
	(Low)	(Mid)	(High)	(Low)	(Mid)	(High)
Channel SCC	39845	40691	41537	39823	40669	41490
	(Low)	(Mid)	(High)	(Low)	(Mid)	(High)
Conducted Power (dBm)	20.1800	20.3000	20.3500	20.2800	20.1600	20.3300
Conducted Power (Watts)	0.1042	0.1072	0.1084	0.1067	0.1038	0.1079
EIRP(dBm)	21.3300	21.4500	21.5000	21.4300	21.3100	21.4800
EIRP(Watts)	0.1358	0.1396	0.1413	0.1390	0.1352	0.1406



LTE Band 7

Peak-to-Average Ratio

Mode	LTE Band 7 / 20MHz				
Mod.	QPSK		16QAM		Limit: 13dB
RB Size	1RB	Full RB	1RB	Full RB	Result
Lowest CH	4.64	4.96	5.36	5.86	PASS
Middle CH	3.86	4.70	4.43	5.74	
Highest CH	4.72	4.72	5.68	5.68	
Mode	LTE Band 7 / 20MHz				
Mod.	64QAM				Limit: 13dB
RB Size	1RB	Full RB			Result
Lowest CH	6.20	6.14	-	-	PASS
Middle CH	5.45	6.12	-	-	
Highest CH	6.46	6.09	-	-	



LTE Band 7 / 20MHz / QPSK

Lowest Channel / 1RB

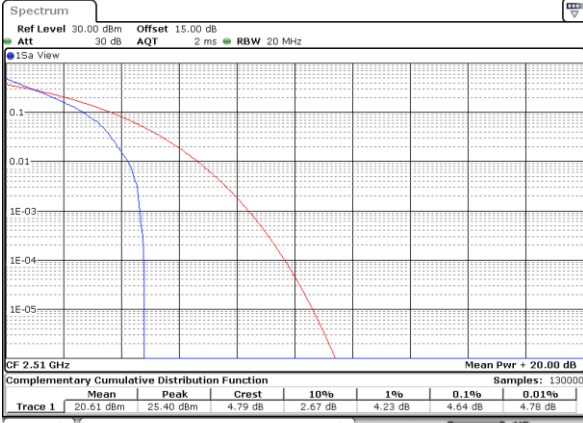

Date: 18_JUL_2022 10:29:39

Lowest Channel / Full RB

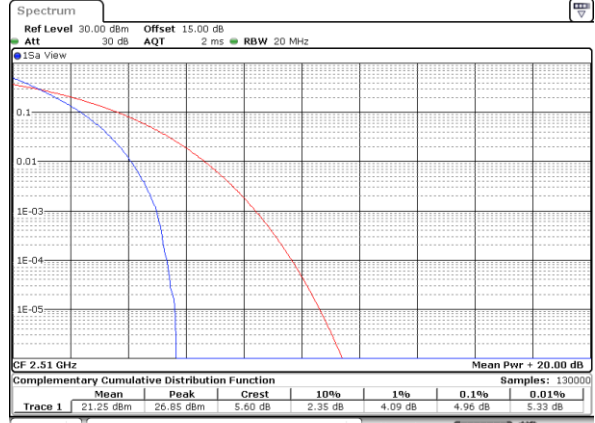

Date: 18_JUL_2022 10:30:05

Middle Channel / 1RB

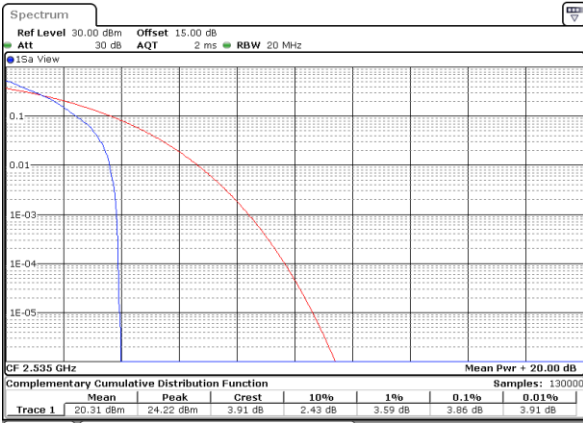

Date: 18_JUL_2022 10:30:30

Middle Channel / Full RB

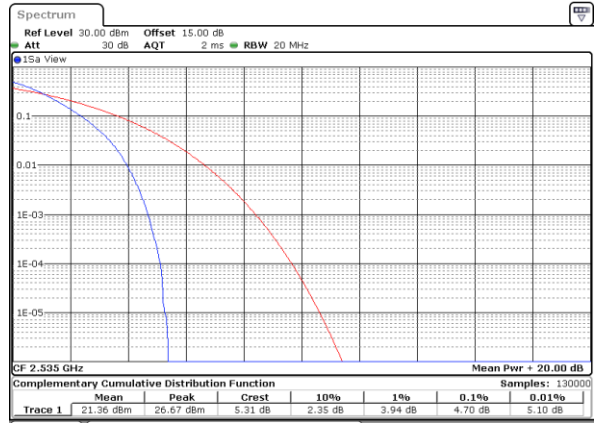

Date: 18_JUL_2022 10:30:55

Highest Channel / 1RB

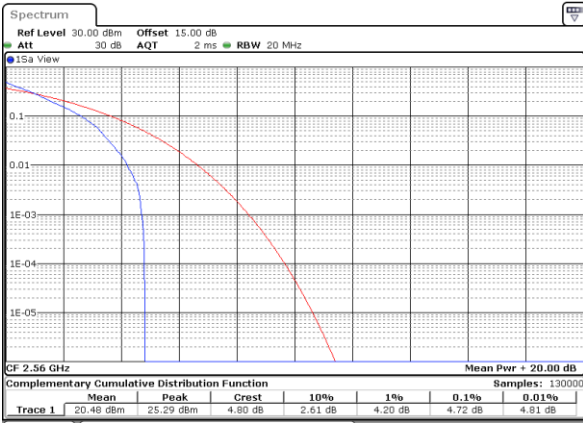

Date: 18_JUL_2022 10:31:20

Highest Channel / Full RB

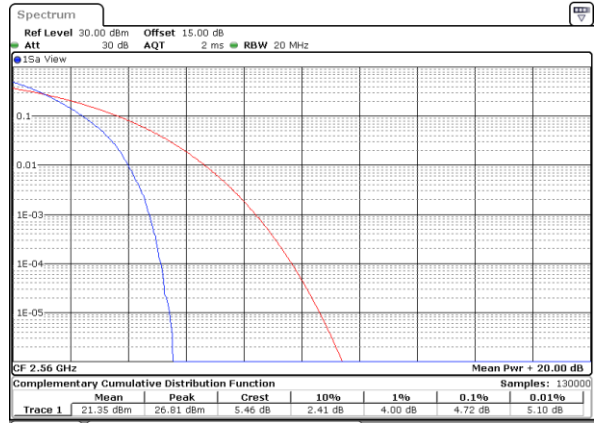

Date: 18_JUL_2022 10:31:46



LTE Band 7 / 20MHz / 16QAM

Lowest Channel / 1RB

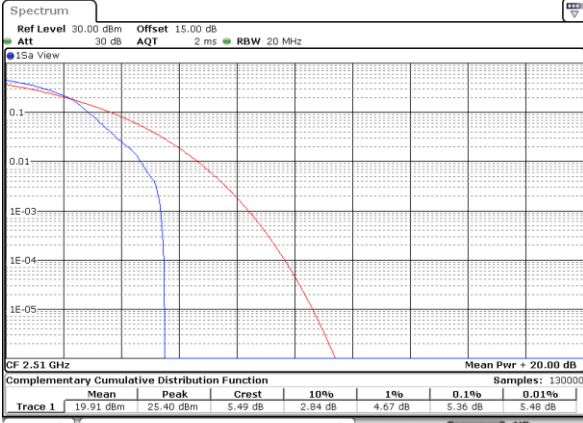

Date: 18_JUL_2022 10:27:06

Lowest Channel / Full RB

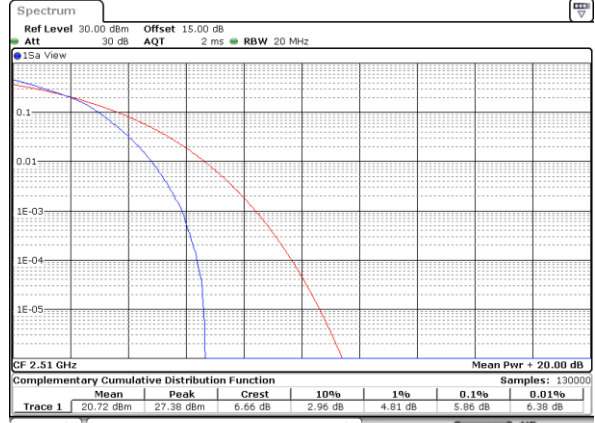

Date: 18_JUL_2022 10:27:132

Middle Channel / 1RB

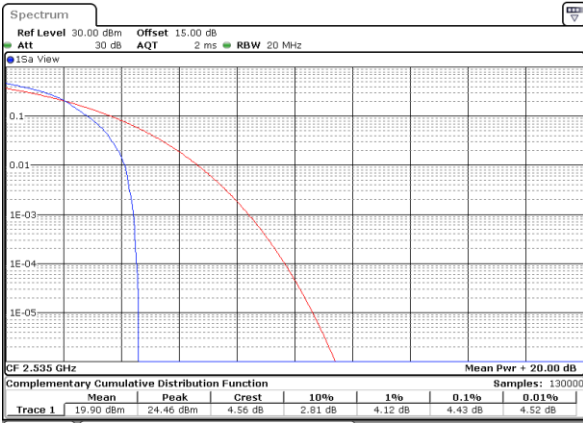

Date: 18_JUL_2022 10:27:07

Middle Channel / Full RB

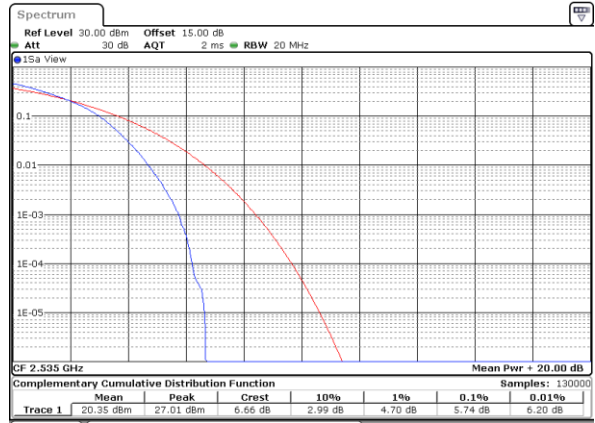

Date: 18_JUL_2022 10:28:123

Highest Channel / 1RB

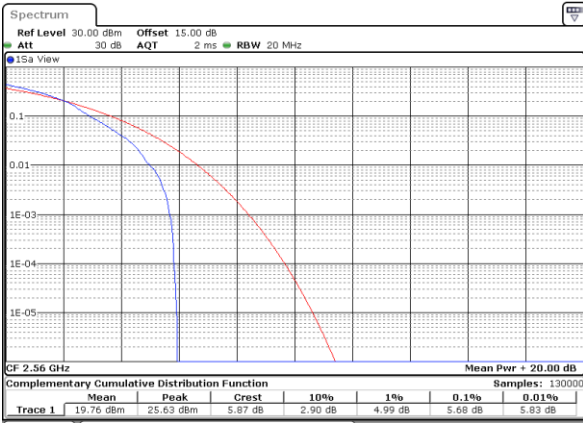

Date: 18_JUL_2022 10:28:48

Highest Channel / Full RB

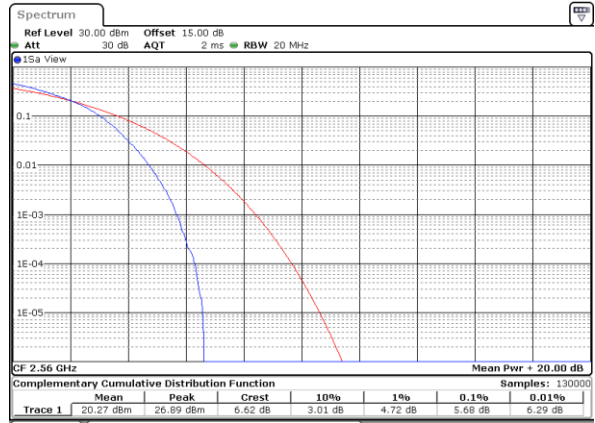

Date: 18_JUL_2022 10:29:113



LTE Band 7 / 20MHz / 64QAM

Lowest Channel / 1RB

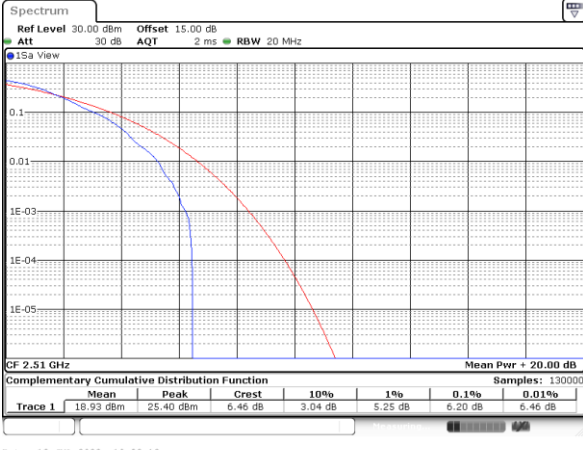

Date: 18_JUL_2022 10:32:12

Lowest Channel / Full RB

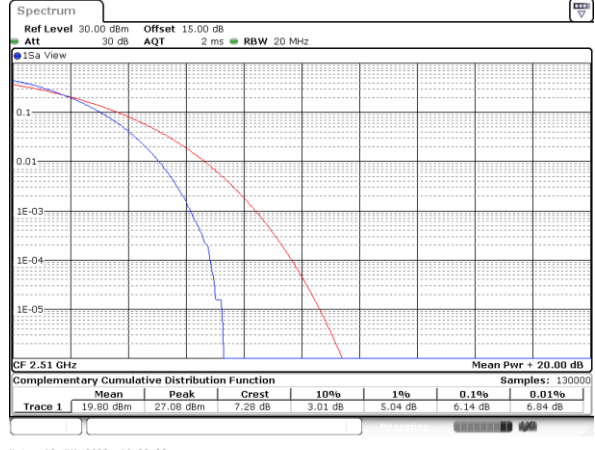

Date: 18_JUL_2022 10:32:38

Middle Channel / 1RB

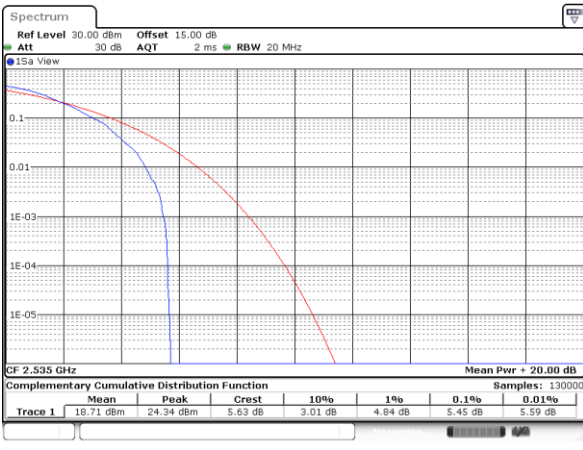

Date: 18_JUL_2022 10:33:03

Middle Channel / Full RB

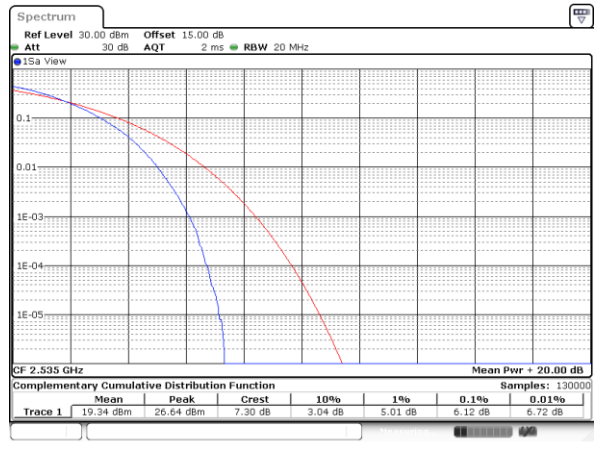

Date: 18_JUL_2022 10:33:28

Highest Channel / 1RB

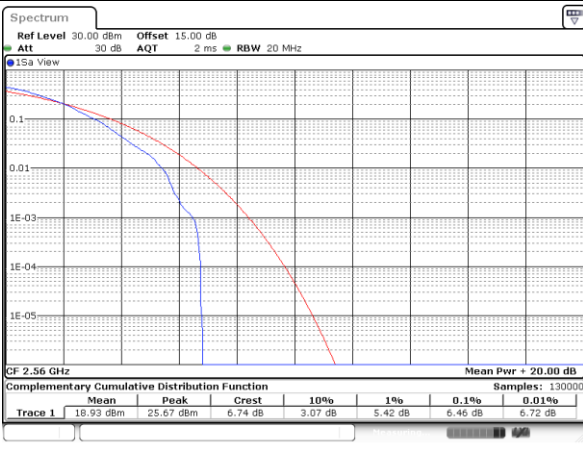

Date: 18_JUL_2022 10:33:53

Highest Channel / Full RB



Date: 18_JUL_2022 10:34:19



26dB Bandwidth

Mode	LTE Band 7 : 26dB BW(MHz)											
BW	1.4MHz		3MHz		5MHz		10MHz		15MHz		20MHz	
Mod.	QPSK	16QAM	QPSK	16QAM	QPSK	16QAM	QPSK	16QAM	QPSK	16QAM	QPSK	16QAM
Lowest CH	-	-	-	-	4.95	4.89	9.85	9.71	14.63	14.54	18.98	18.98
Middle CH	-	-	-	-	4.96	4.90	9.71	9.65	14.33	14.54	18.90	18.86
Highest CH	-	-	-	-	4.97	4.90	9.69	9.79	14.54	14.27	18.82	19.06
Mode	LTE Band 7 : 26dB BW(MHz)											
BW	1.4MHz		3MHz		5MHz		10MHz		15MHz		20MHz	
Mod.	64QAM		64QAM		64QAM		64QAM		64QAM		64QAM	
Lowest CH	-	-	-	-	4.99	-	9.65	-	14.51	-	19.02	-
Middle CH	-	-	-	-	4.93	-	9.91	-	14.24	-	18.70	-
Highest CH	-	-	-	-	4.93	-	9.85	-	14.18	-	18.94	-



LTE Band 7

Lowest Channel / 5MHz / QPSK

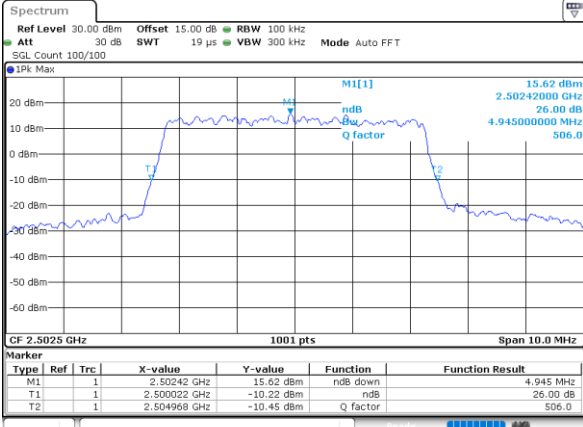

Date: 16_JUL_2022 00:44:24

Lowest Channel / 5MHz / 16QAM

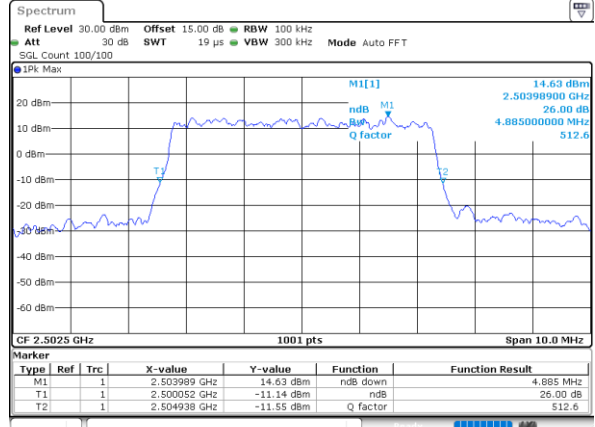

Date: 16_JUL_2022 00:44:48

Middle Channel / 5MHz / QPSK

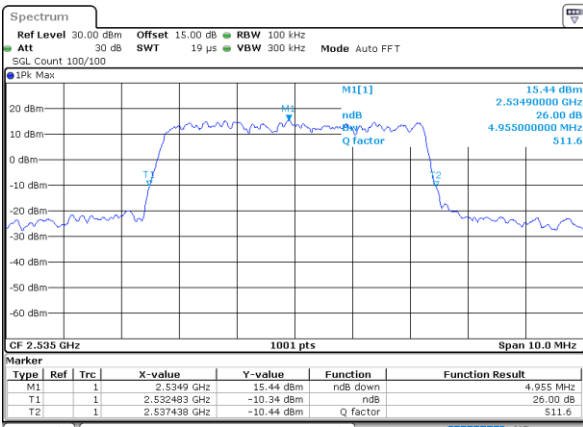

Date: 16_JUL_2022 00:54:17

Middle Channel / 5MHz / 16QAM

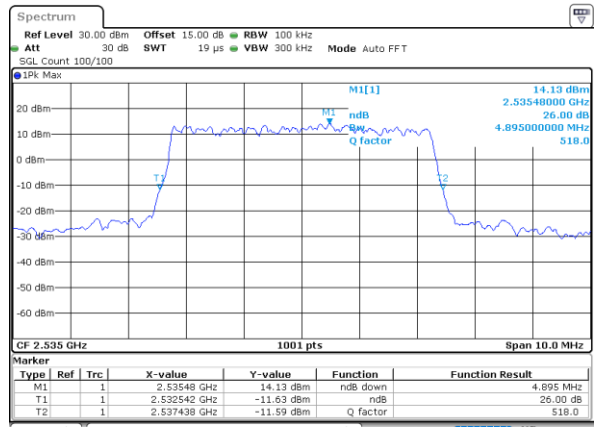

Date: 16_JUL_2022 00:54:41

Highest Channel / 5MHz / QPSK

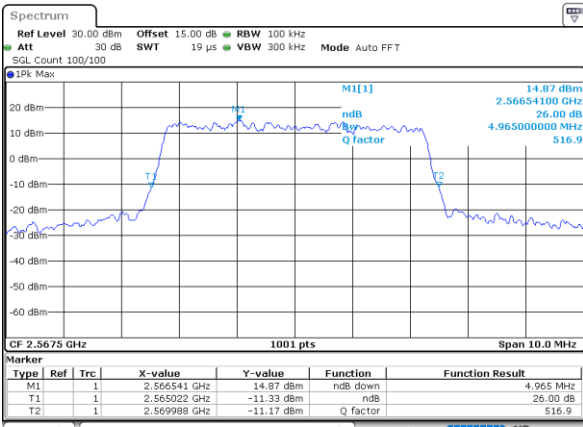

Date: 16_JUL_2022 00:57:55

Highest Channel / 5MHz / 16QAM

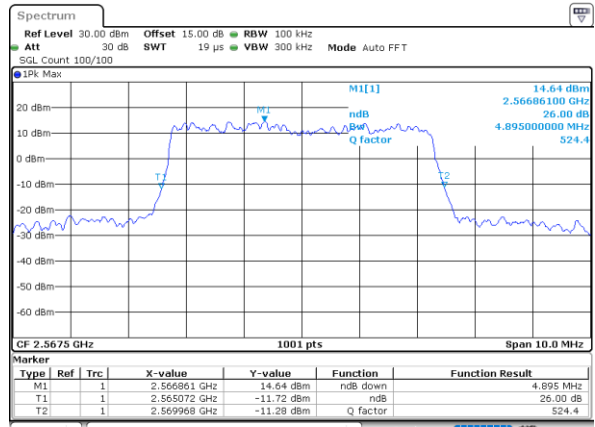

Date: 16_JUL_2022 00:58:19



LTE Band 7

Lowest Channel / 10MHz / QPSK

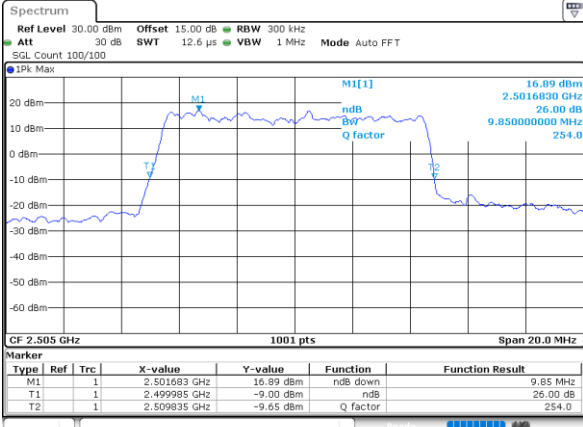

Date: 16_JUL_2022 01:32:49

Lowest Channel / 10MHz / 16QAM

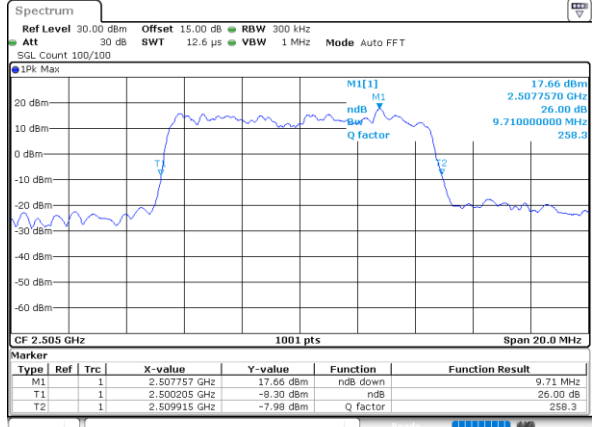

Date: 16_JUL_2022 01:33:13

Middle Channel / 10MHz / QPSK

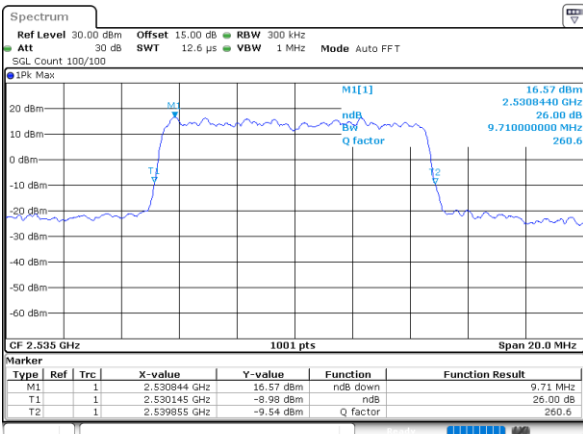

Date: 16_JUL_2022 01:42:41

Middle Channel / 10MHz / 16QAM

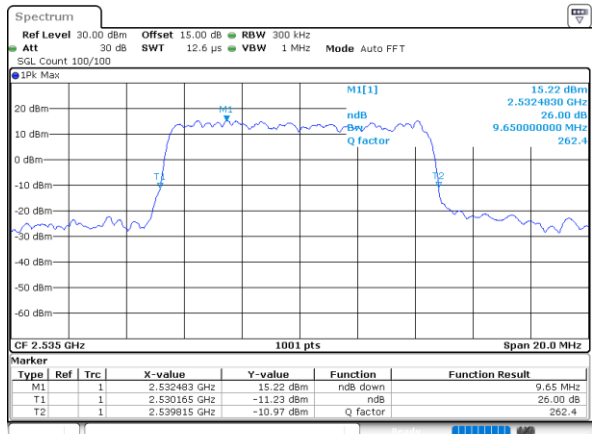

Date: 16_JUL_2022 01:43:04

Highest Channel / 10MHz / QPSK

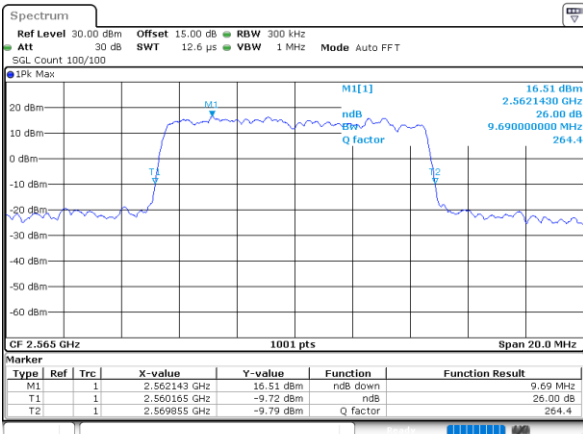

Date: 16_JUL_2022 01:46:18

Highest Channel / 10MHz / 16QAM

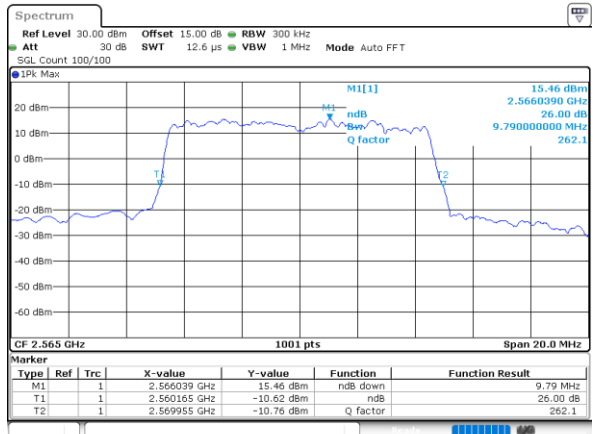

Date: 16_JUL_2022 01:46:43



LTE Band 7

Lowest Channel / 15MHz / QPSK

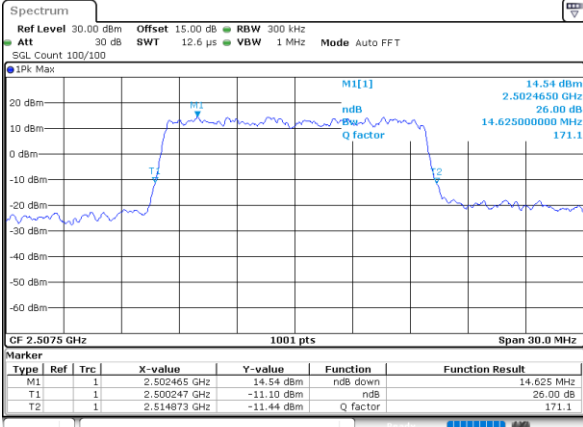

Date: 18_JUL_2022 09:10:43

Lowest Channel / 15MHz / 16QAM

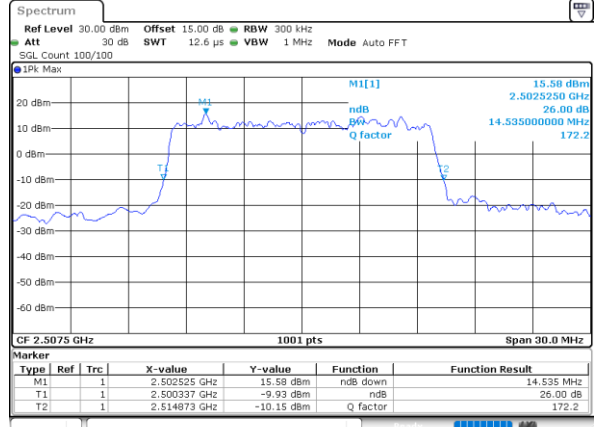

Date: 18_JUL_2022 09:11:07

Middle Channel / 15MHz / QPSK

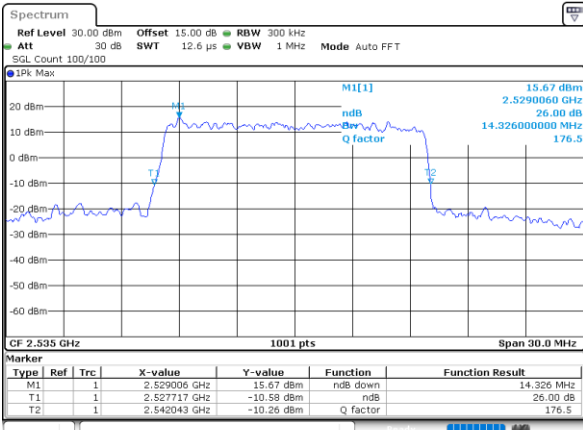

Date: 18_JUL_2022 09:16:34

Middle Channel / 15MHz / 16QAM

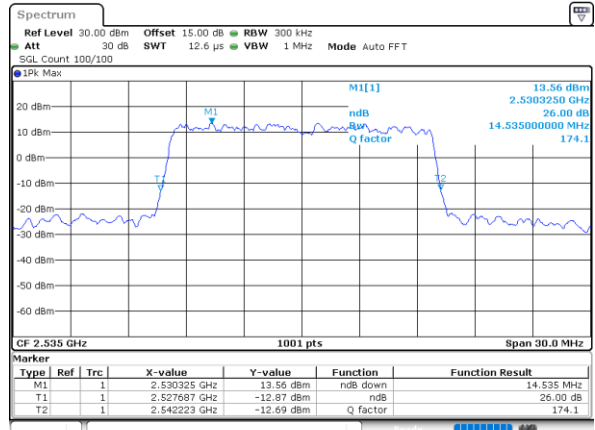

Date: 18_JUL_2022 09:16:57

Highest Channel / 15MHz / QPSK

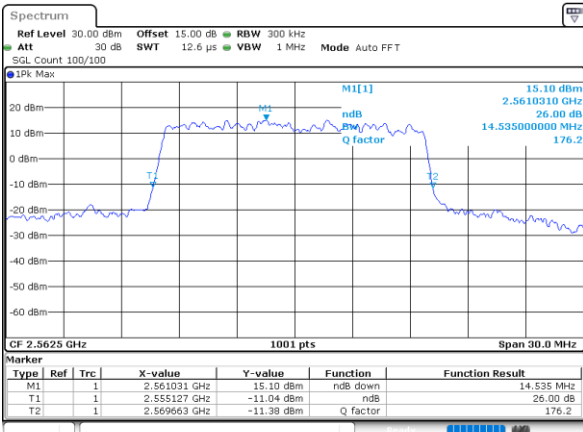

Date: 18_JUL_2022 09:20:11

Highest Channel / 15MHz / 16QAM

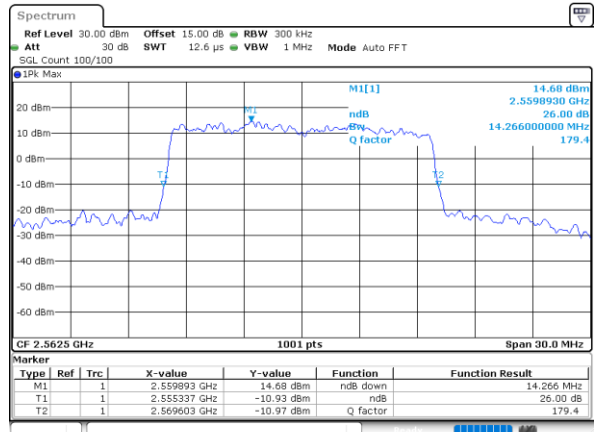

Date: 18_JUL_2022 09:20:35



LTE Band 7

Lowest Channel / 20MHz / QPSK

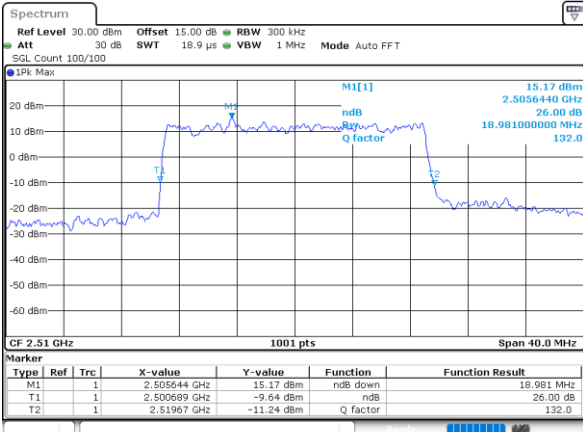

Date: 18_JUL_2022 09:33:20

Lowest Channel / 20MHz / 16QAM

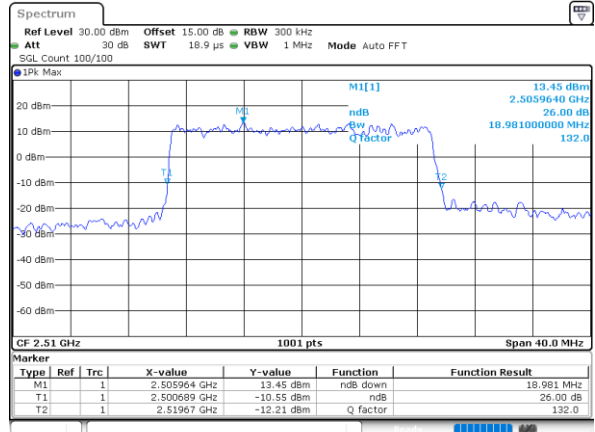

Date: 18_JUL_2022 09:33:44

Middle Channel / 20MHz / QPSK

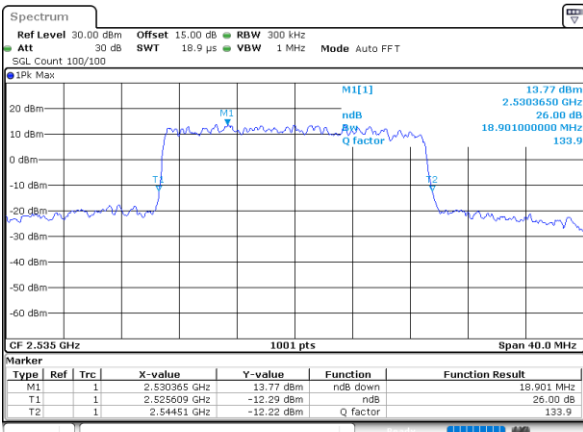

Date: 18_JUL_2022 09:39:46

Middle Channel / 20MHz / 16QAM

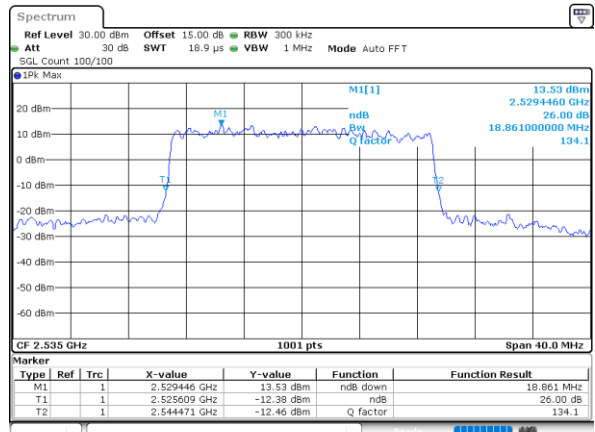

Date: 18_JUL_2022 09:40:09

Highest Channel / 20MHz / QPSK

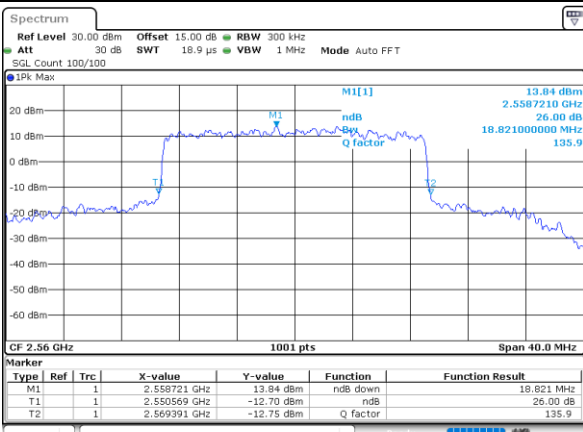

Date: 18_JUL_2022 09:43:24

Highest Channel / 20MHz / 16QAM

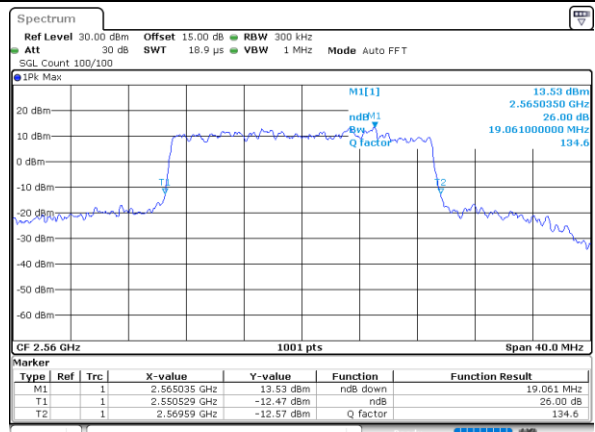

Date: 18_JUL_2022 09:43:48



LTE Band 7

Lowest Channel / 5MHz / 64QAM

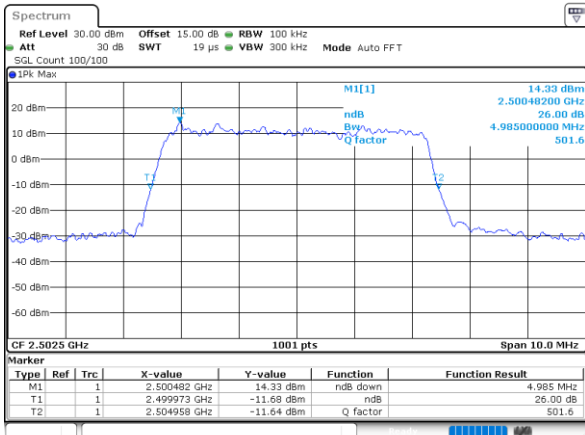

Date: 16_JUL_2022 01:07:18

Lowest Channel / 10MHz / 64QAM

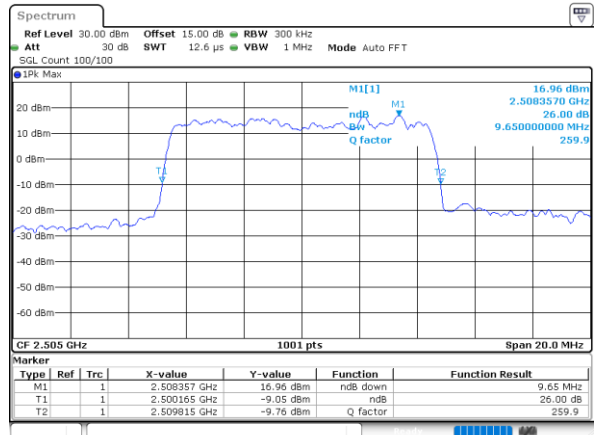

Date: 16_JUL_2022 01:55:37

Middle Channel / 5MHz / 64QAM

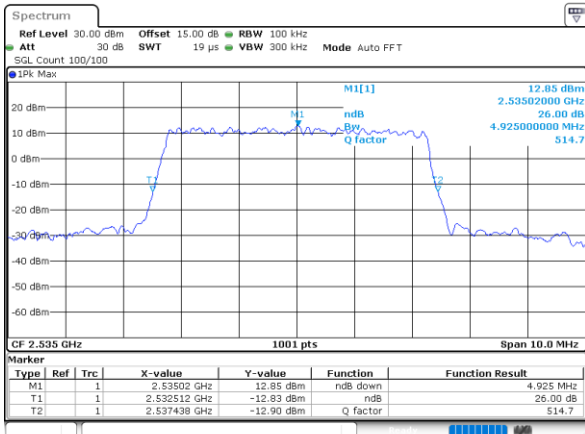

Date: 16_JUL_2022 01:12:05

Middle Channel / 10MHz / 64QAM

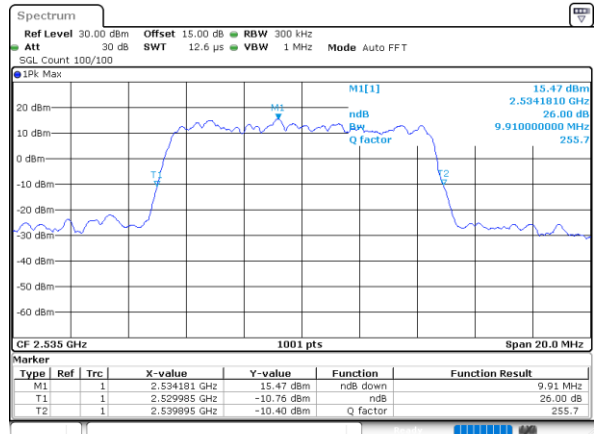

Date: 18_JUL_2022 09:01:11

Highest Channel / 5MHz / 64QAM

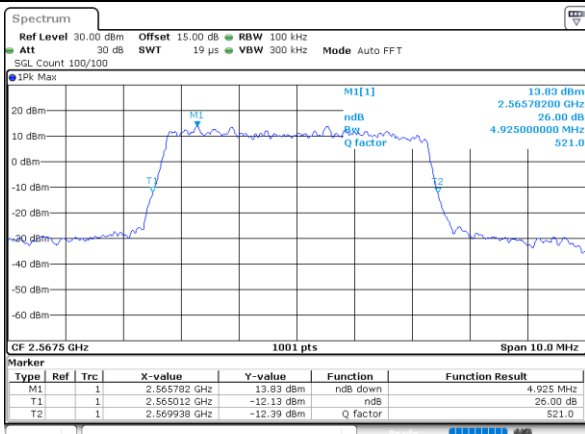

Date: 16_JUL_2022 01:14:28

Highest Channel / 10MHz / 64QAM

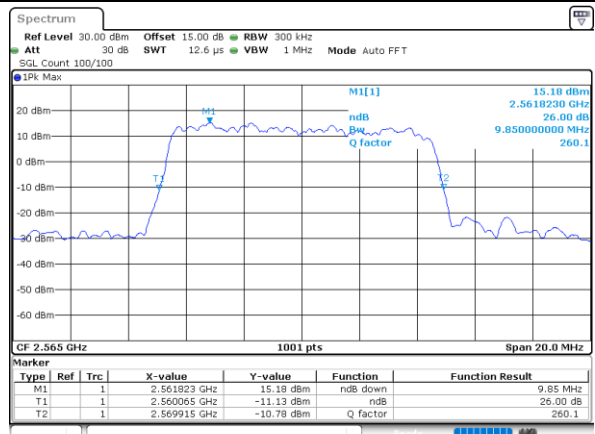

Date: 18_JUL_2022 09:04:11



LTE Band 7

Lowest Channel / 15MHz / 64QAM

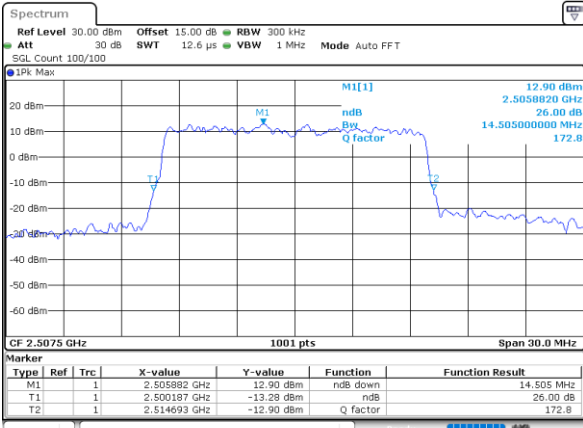

Date: 18_JUL_2022 09:25:29

Lowest Channel / 20MHz / 64QAM

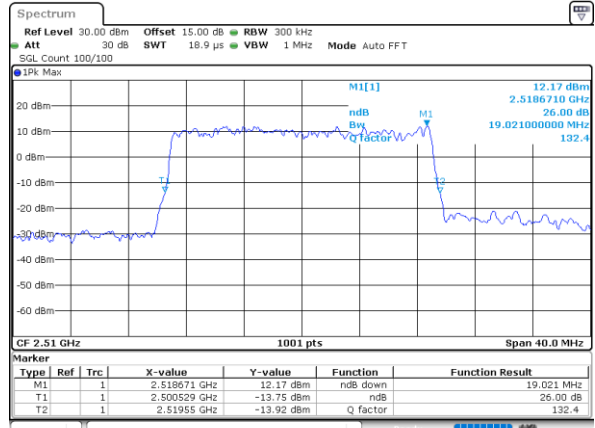

Date: 18_JUL_2022 10:20:07

Middle Channel / 15MHz / 64QAM

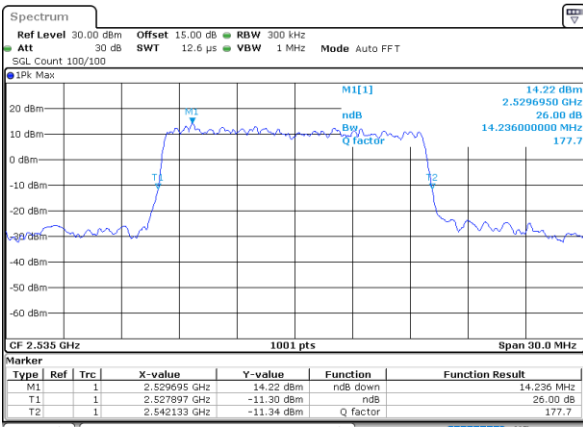

Date: 18_JUL_2022 09:28:15

Middle Channel / 20MHz / 64QAM

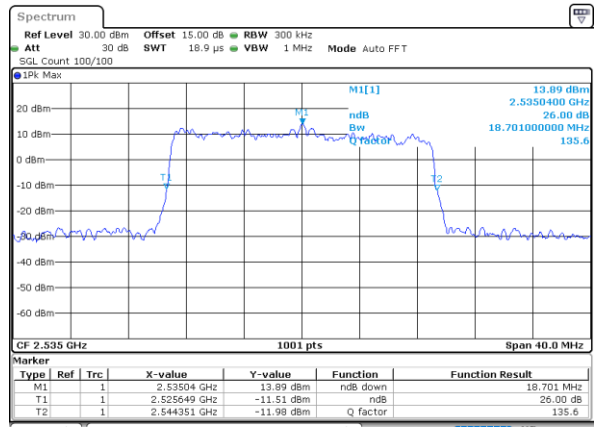

Date: 18_JUL_2022 10:22:53

Highest Channel / 15MHz / 64QAM

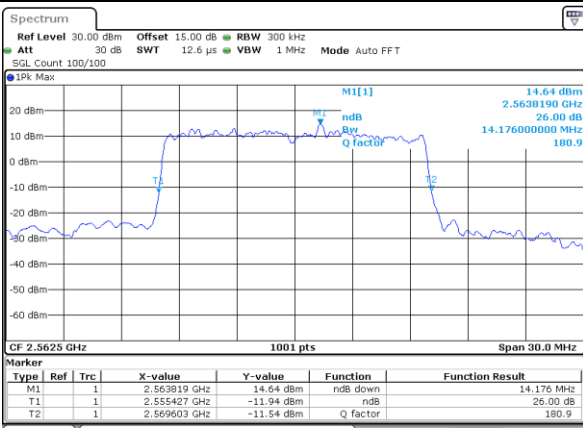

Date: 18_JUL_2022 09:29:54

Highest Channel / 20MHz / 64QAM

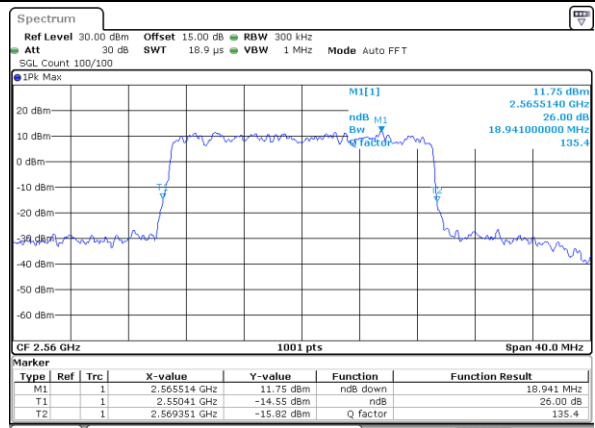

Date: 18_JUL_2022 10:24:33



Occupied Bandwidth

Mode	LTE Band 7 : 99%OBW(MHz)											
BW	1.4MHz		3MHz		5MHz		10MHz		15MHz		20MHz	
Mod.	QPSK	16QAM	QPSK	16QAM	QPSK	16QAM	QPSK	16QAM	QPSK	16QAM	QPSK	16QAM
Lowest CH	-	-	-	-	4.50	4.49	9.01	8.99	13.43	13.46	17.98	17.94
Middle CH	-	-	-	-	4.51	4.51	9.09	8.99	13.43	13.40	17.90	17.82
Highest CH	-	-	-	-	4.49	4.47	9.01	8.97	13.37	13.46	17.86	17.82
Mode	LTE Band 7 : 99%OBW(MHz)											
BW	1.4MHz		3MHz		5MHz		10MHz		15MHz		20MHz	
Mod.	64QAM		64QAM		64QAM		64QAM		64QAM		64QAM	
Lowest CH	-	-	-	-	4.54	-	9.01	-	13.46	-	17.94	-
Middle CH	-	-	-	-	4.49	-	9.07	-	13.49	-	17.86	-
Highest CH	-	-	-	-	4.51	-	8.95	-	13.37	-	17.78	-



LTE Band 7

Lowest Channel / 5MHz / QPSK

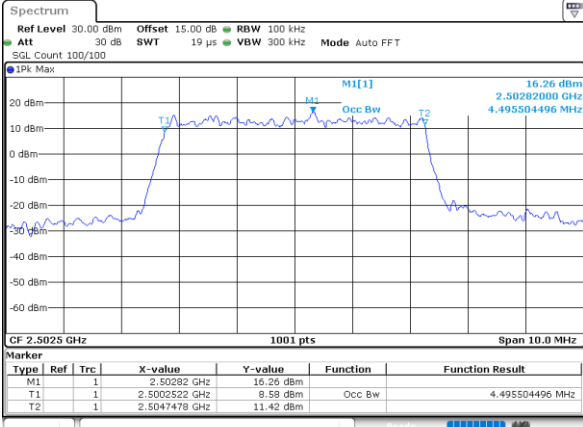

Date: 16_JUL_2022 00:43:16

Lowest Channel / 5MHz / 16QAM

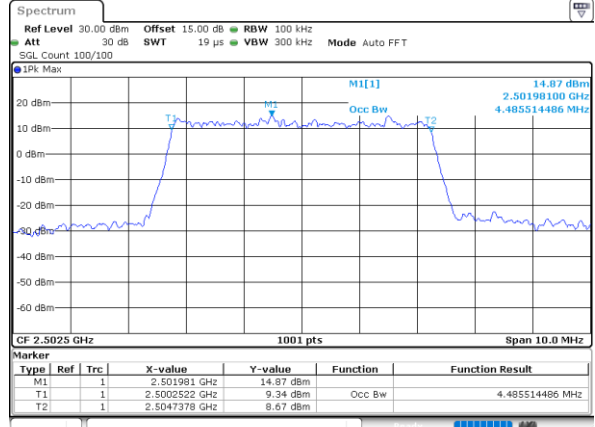

Date: 16_JUL_2022 00:44:10

Middle Channel / 5MHz / QPSK

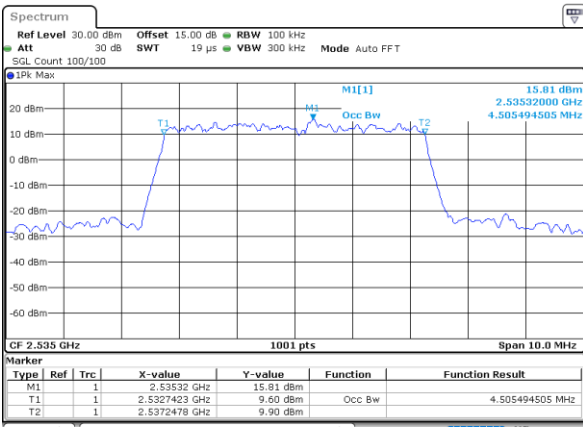

Date: 16_JUL_2022 00:53:30

Middle Channel / 5MHz / 16QAM

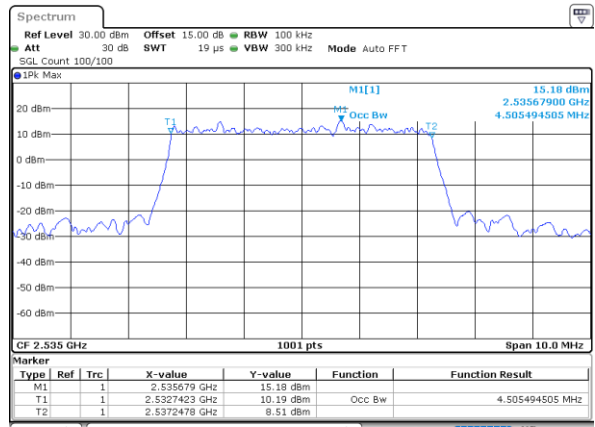

Date: 16_JUL_2022 00:53:54

Highest Channel / 5MHz / QPSK

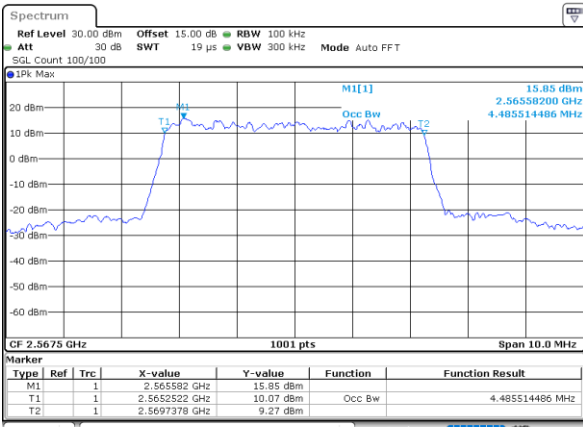

Date: 16_JUL_2022 00:57:07

Highest Channel / 5MHz / 16QAM

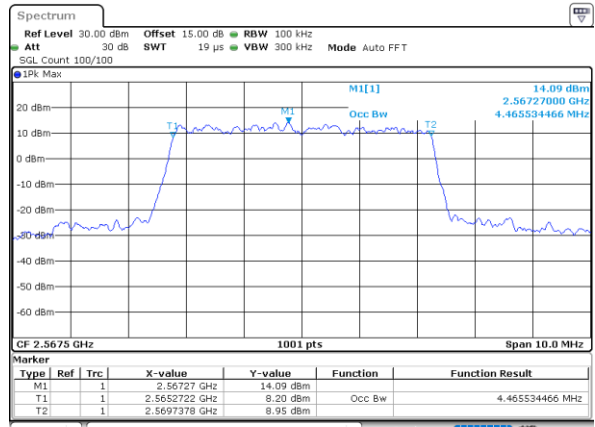

Date: 16_JUL_2022 00:57:31



LTE Band 7

Lowest Channel / 10MHz / QPSK

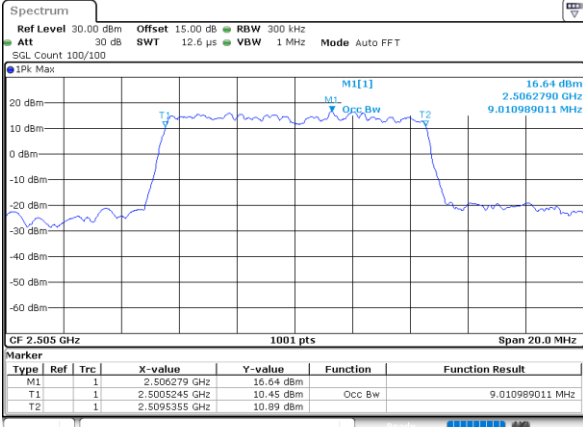

Date: 16_JUL_2022 01:32:00

Lowest Channel / 10MHz / 16QAM

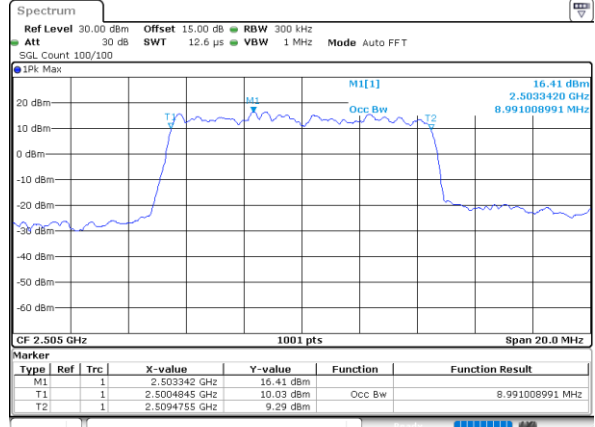

Date: 16_JUL_2022 01:32:25

Middle Channel / 10MHz / QPSK

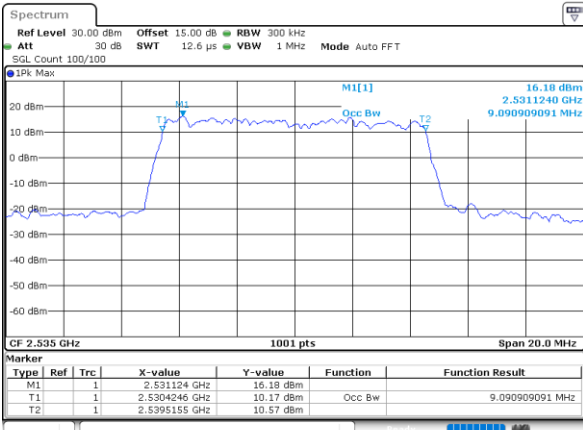

Date: 16_JUL_2022 01:41:54

Middle Channel / 10MHz / 16QAM

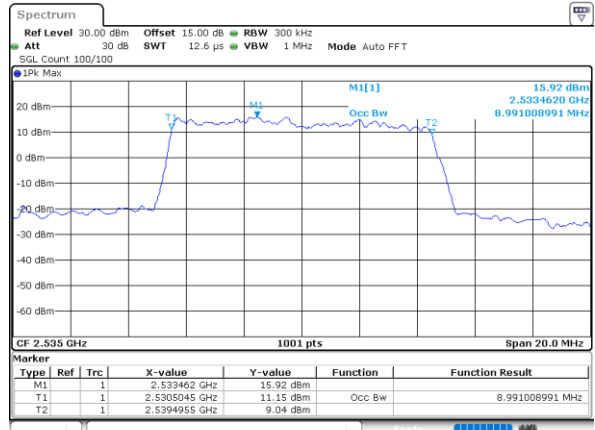

Date: 16_JUL_2022 01:42:17

Highest Channel / 10MHz / QPSK

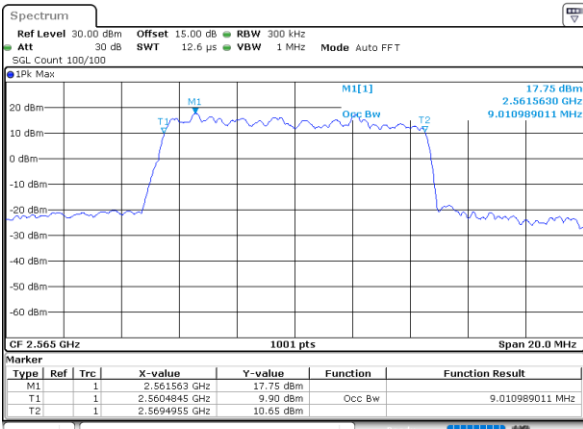

Date: 16_JUL_2022 01:45:30

Highest Channel / 10MHz / 16QAM

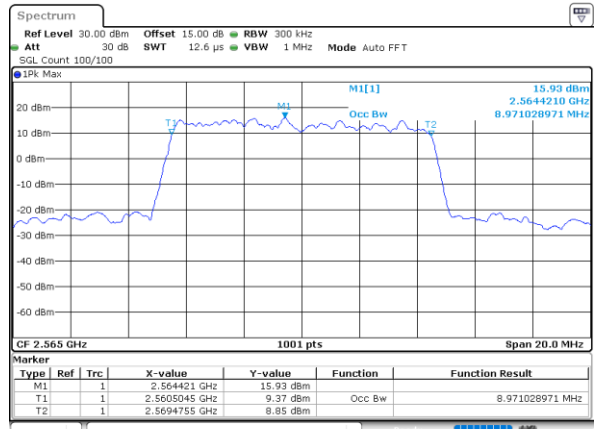

Date: 16_JUL_2022 01:45:54



LTE Band 7

Lowest Channel / 15MHz / QPSK

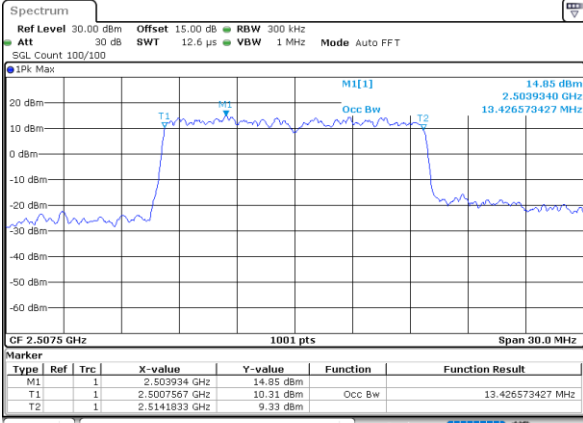

Date: 18_JUL_2022 09:09:55

Lowest Channel / 15MHz / 16QAM

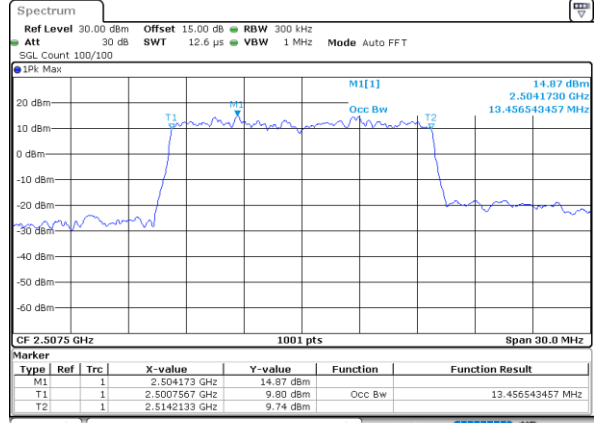

Date: 18_JUL_2022 09:10:19

Middle Channel / 15MHz / QPSK

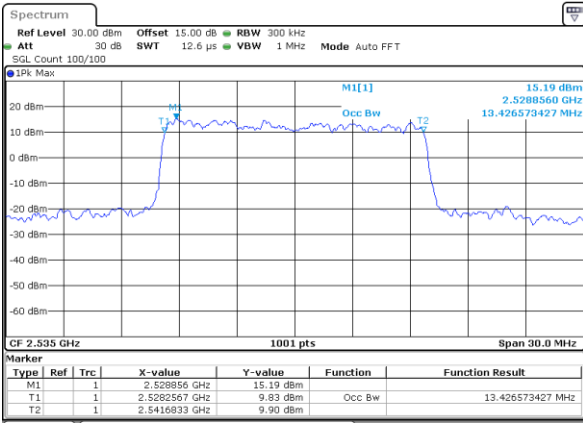

Date: 18_JUL_2022 09:15:47

Middle Channel / 15MHz / 16QAM

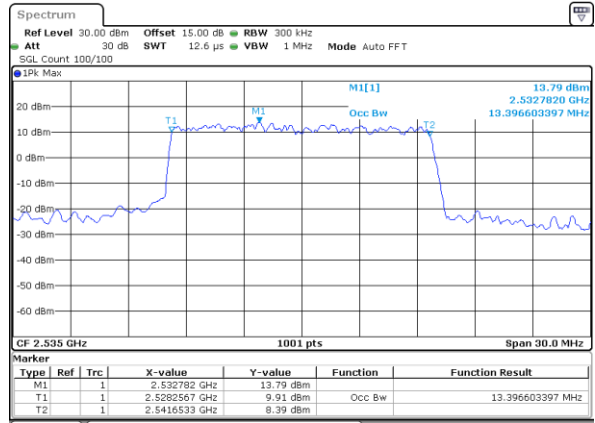

Date: 18_JUL_2022 09:16:10

Highest Channel / 15MHz / QPSK

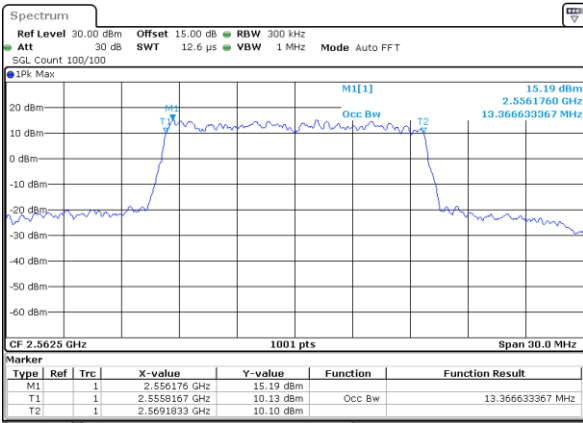

Date: 18_JUL_2022 09:19:23

Highest Channel / 15MHz / 16QAM

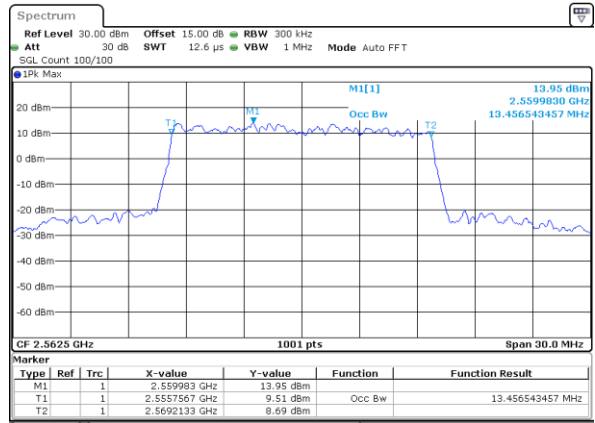

Date: 18_JUL_2022 09:19:47



LTE Band 7

Lowest Channel / 20MHz / QPSK

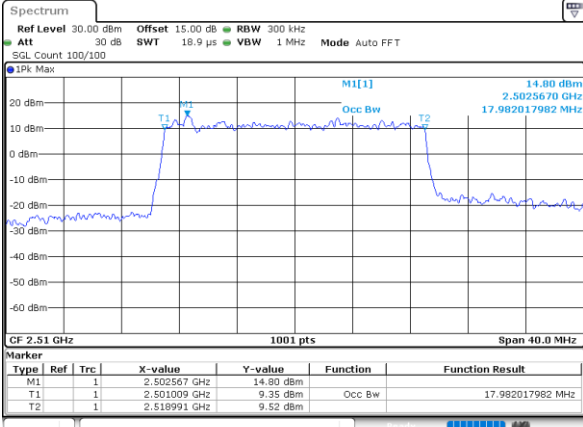

Date: 18_JUL_2022 09:32:29

Lowest Channel / 20MHz / 16QAM

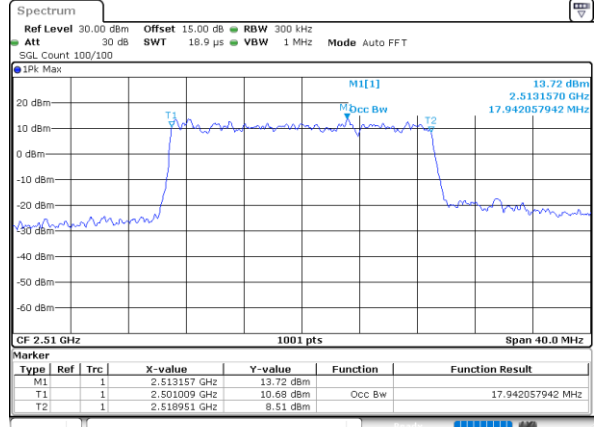

Date: 18_JUL_2022 09:32:55

Middle Channel / 20MHz / QPSK

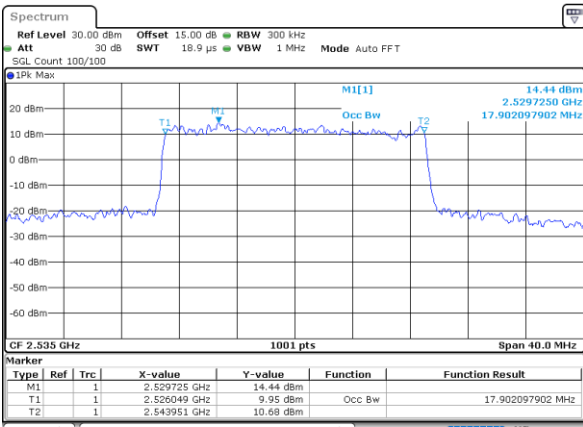

Date: 18_JUL_2022 09:38:59

Middle Channel / 20MHz / 16QAM

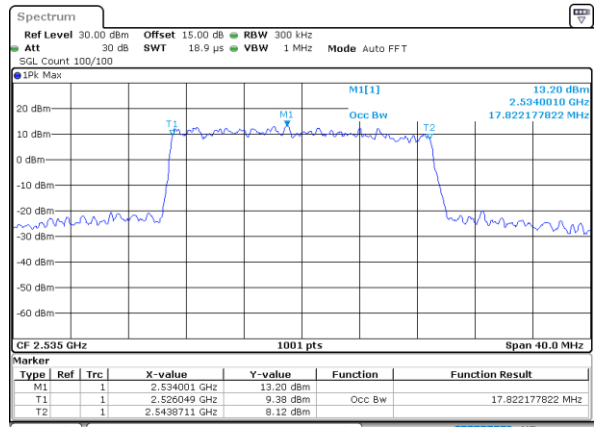

Date: 18_JUL_2022 09:39:23

Highest Channel / 20MHz / QPSK

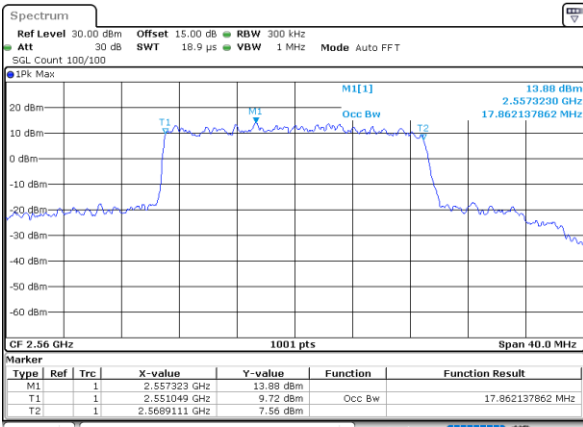

Date: 18_JUL_2022 09:42:36

Highest Channel / 20MHz / 16QAM

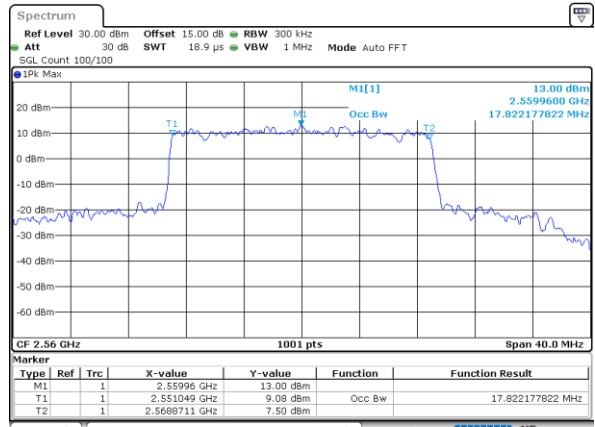

Date: 18_JUL_2022 09:43:00



LTE Band 7

Lowest Channel / 5MHz / 64QAM

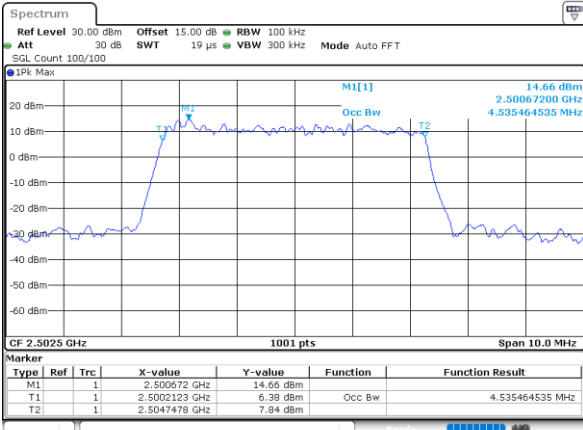

Date: 16_JUL_2022 01:07:03

Lowest Channel / 10MHz / 64QAM

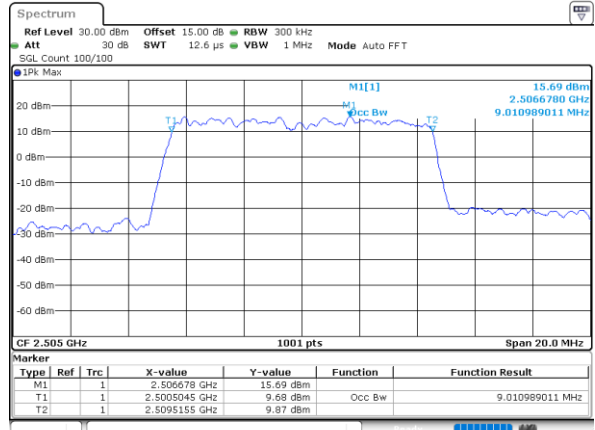

Date: 16_JUL_2022 01:55:22

Middle Channel / 5MHz / 64QAM

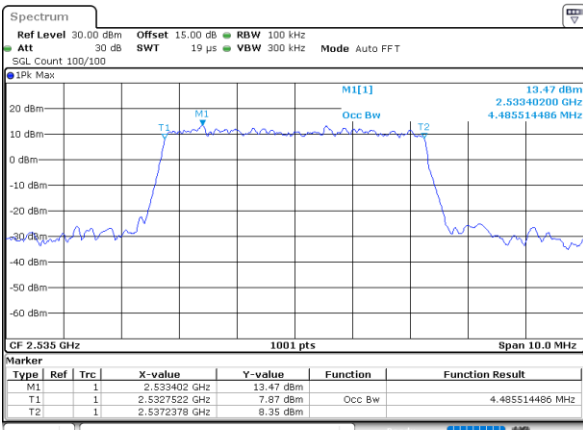

Date: 16_JUL_2022 01:11:50

Middle Channel / 10MHz / 64QAM

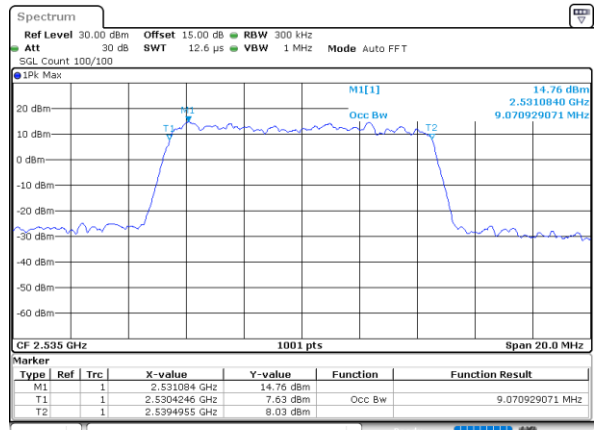

Date: 18_JUL_2022 09:00:56

Highest Channel / 5MHz / 64QAM

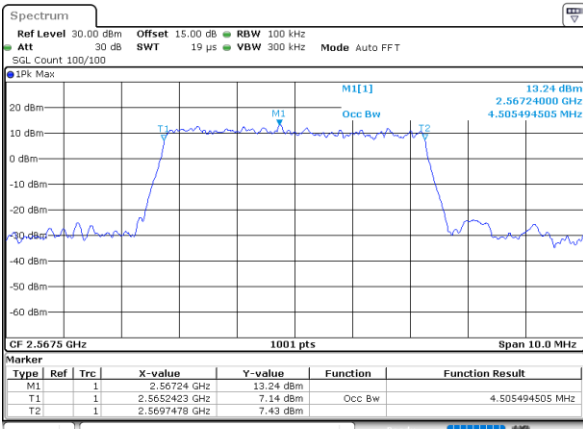

Date: 16_JUL_2022 01:14:14

Highest Channel / 10MHz / 64QAM

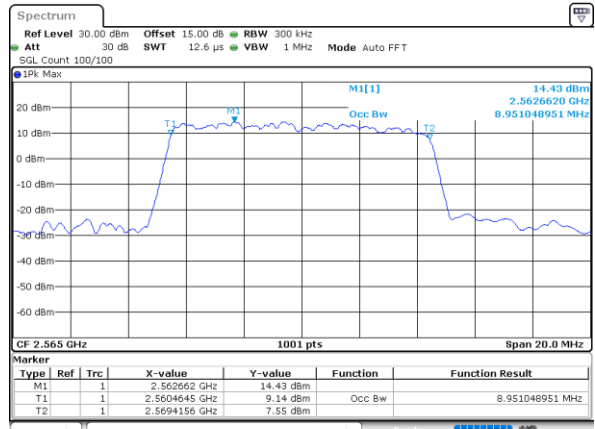

Date: 18_JUL_2022 09:03:57



LTE Band 7

Lowest Channel / 15MHz / 64QAM

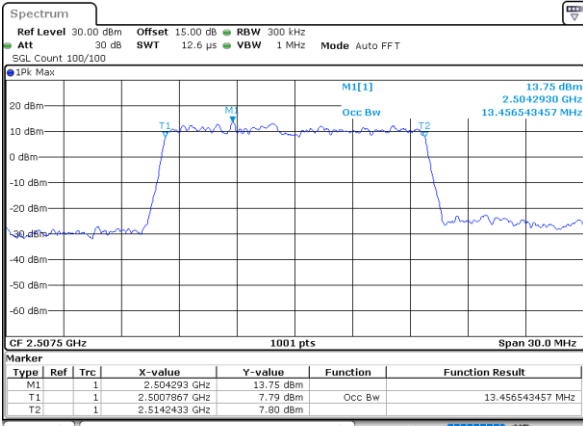

Date: 18_JUL_2022 09:25:14

Lowest Channel / 20MHz / 64QAM

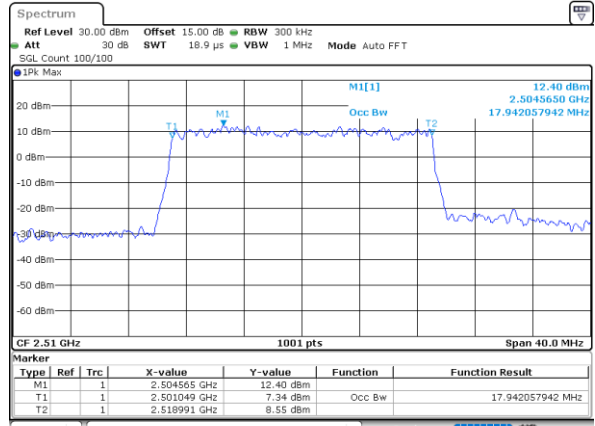

Date: 18_JUL_2022 10:11:52

Middle Channel / 15MHz / 64QAM

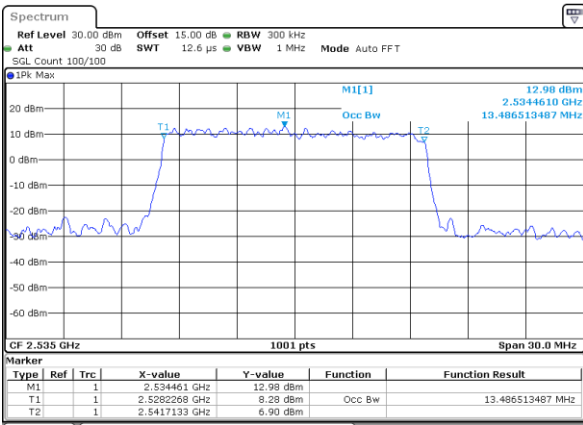

Date: 18_JUL_2022 09:28:01

Middle Channel / 20MHz / 64QAM

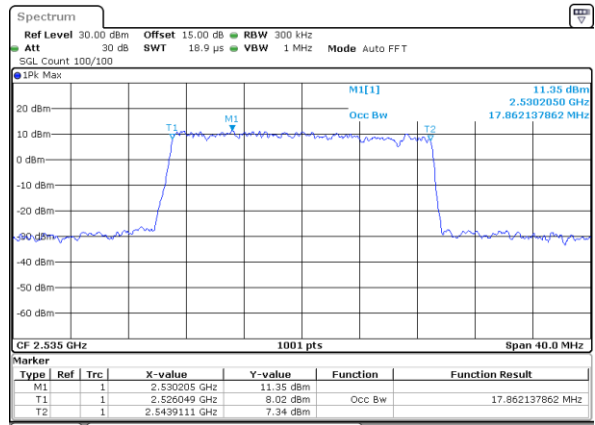

Date: 18_JUL_2022 10:22:39

Highest Channel / 15MHz / 64QAM

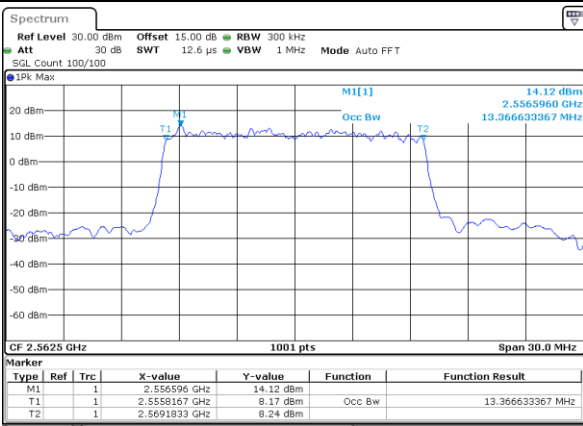

Date: 18_JUL_2022 09:29:40

Highest Channel / 20MHz / 64QAM

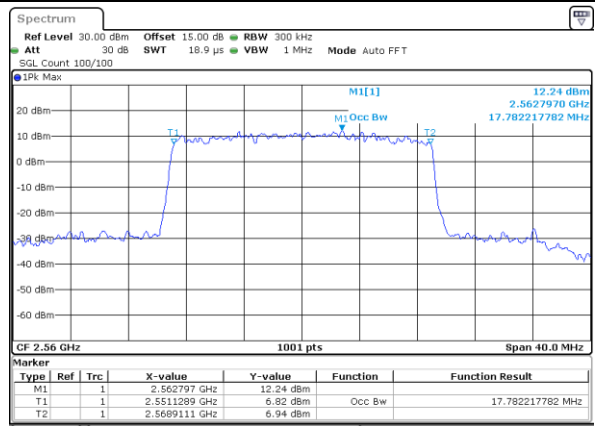

Date: 18_JUL_2022 10:22:18



Conducted Band Edge

