



FCC RF Test Report

APPLICANT : vivo Mobile Communication Co., Ltd.
EQUIPMENT : Mobile Phone
BRAND NAME : vivo
MODEL NAME : V2202
FCC ID : 2AUCY-V2202
STANDARD : 47 CFR Part 2, 270
CLASSIFICATION : PCS Licensed Transmitter Held to Ear (PCE)
TEST DATE(S) : Jul. 05, 2022 ~ Jul. 22, 2022

We, Sporton International Inc. (ShenZhen), would like to declare that the tested sample has been evaluated in accordance with the procedures given in ANSI C63.26-2015 and shown compliance with the applicable technical standards.

The test results in this report apply exclusively to the tested model / sample. Without written approval of Sporton International Inc. (ShenZhen), the test report shall not be reproduced except in full.

Jason Jia



Approved by: Jason Jia

Sporton International Inc. (ShenZhen)

1/F, 2/F, Bldg 5, Shiling Industrial Zone, Xinwei Village, Xili, Nanshan, Shenzhen, 518055

People's Republic of China



TABLE OF CONTENTS

REVISION HISTORY... 3
SUMMARY OF TEST RESULT ... 4
1 GENERAL DESCRIPTION ... 5
1.1 Applicant ... 5
1.2 Manufacturer ... 5
1.3 Product Feature of Equipment Under Test ... 5
1.4 Product Specification of Equipment Under Test ... 6
1.5 Modification of EUT ... 6
1.6 Maximum EIRP Power and Emission Designator ... 7
1.7 Testing Location ... 8
1.8 Test Software ... 8
1.9 Applicable Standards ... 8
2 TEST CONFIGURATION OF EQUIPMENT UNDER TEST ... 9
2.1 Test Mode ... 9
2.2 Connection Diagram of Test System ... 10
2.3 Support Unit used in test configuration and system ... 10
2.4 Measurement Results Explanation Example ... 10
2.5 Frequency List of Low/Middle/High Channels ... 11
3 CONDUCTED TEST ITEMS ... 13
3.1 Measuring Instruments ... 13
3.2 Test Setup ... 13
3.3 Test Result of Conducted Test ... 13
3.4 Conducted Output Power and EIRP ... 14
3.5 Peak-to-Average Ratio ... 15
3.6 Occupied Bandwidth ... 16
3.7 Conducted Band Edge ... 17
3.8 Conducted Spurious Emission ... 18
3.9 Frequency Stability ... 19
4 RADIATED TEST ITEMS ... 20
4.1 Measuring Instruments ... 20
4.2 Test Setup ... 20
4.3 Test Result of Radiated Test ... 21
4.4 Radiated Spurious Emission ... 22
5 LIST OF MEASURING EQUIPMENT ... 23
6 UNCERTAINTY OF EVALUATION ... 24
APPENDIX A. TEST RESULTS OF CONDUCTED TEST
APPENDIX B. TEST RESULTS OF RADIATED TEST
APPENDIX C. TEST SETUP PHOTOGRAPHS



REVISION HISTORY

REPORT NO.	VERSION	DESCRIPTION	ISSUED DATE
FG260813E	Rev. 01	Initial issue of report	Aug. 05, 2022



SUMMARY OF TEST RESULT

Report Section	FCC Rule	Description	Limit	Result	Remark
3.4	§2.1046	Conducted Output Power	Reporting Only	PASS	-
	§27.50(j)(3)	Equivalent Isotropic Radiated Power	EIRP < 1Watt		
3.5	§27.50(j)(4)	Peak-to-Average Ratio	<13 dB	PASS	-
3.6	§2.1049	Occupied Bandwidth	Reporting Only	PASS	-
3.7	§2.1051 §27.53(l)(2)	Conducted Band Edge Measurement	< 43+10log10(P[Watts])	PASS	-
3.8	§2.1051 §27.53(l)(2)	Conducted Spurious Emission	< 43+10log10(P[Watts])	PASS	-
3.9	§2.1055 §27.54	Frequency Stability Temperature & Voltage	Within Authorized Band	PASS	-
4.4	§2.1053 §27.53(l)(2)	Radiated Spurious Emission	< 43+10log ₁₀ (P[Watts])	PASS	Under limit 29.71 dB at 10336.000 MHz

Declaration of Conformity:
The test results with all measurement uncertainty excluded are presented in accordance with the regulation limits or requirements declared by manufacturers.

Comments and Explanations:
The declared of product specification for EUT presented in the report are provided by the manufacturer, and the manufacturer takes all the responsibilities for the accuracy of product specification.



1 General Description

1.1 Applicant

vivo Mobile Communication Co., Ltd.
No.1, vivo Road, Chang'an, Dongguan,Guangdong,China

1.2 Manufacturer

vivo Mobile Communication Co., Ltd.
No.1, vivo Road, Chang'an, Dongguan,Guangdong,China

1.3 Product Feature of Equipment Under Test

Product Feature	
Equipment	Mobile Phone
Brand Name	vivo
Model Name	V2202
FCC ID	2AUCY-V2202
IMEI Code	Radiation: 866295060093993 / 866295060093910 Conducted: 866295060094256
HW Version	MP_0.1
SW Version	PD2215CF_EX_A_12.0.3.8.W30.V000L1
EUT Stage	Production Unit



1.4 Product Specification of Equipment Under Test

Standards-related Product Specification	
Tx Frequency	5G NR n77: 3700 MHz ~ 3980 MHz 5G NR n78: 3700 MHz ~ 3800 MHz
Rx Frequency	5G NR n77: 3700 MHz ~ 3980 MHz 5G NR n78: 3700 MHz ~ 3800 MHz
SCS	15kHz / 30kHz
Bandwidth	n77: 10MHz / 15MHz / 20MHz / 40MHz / 50MHz / 60MHz / 80MHz / 90MHz / 100MHz n78: 10MHz / 15MHz / 20MHz / 30MHz / 40MHz / 50MHz / 60MHz / 80MHz / 90MHz / 100MHz
Antenna Gain	Ant. 11: 5G NR n77: -0.9 dBi 5G NR n78: -0.9 dBi Ant. 12: 5G NR n77: -0.8 dBi 5G NR n78: -0.8 dBi Ant. 21: 5G NR n77: -3.5 dBi 5G NR n78: -3.5 dBi Ant. 23: 5G NR n77: -1.1 dBi 5G NR n78: -1.1 dBi
Type of Modulation	CP-OFDM: QPSK / 16QAM / 64QAM / 256QAM DFT-s-OFDM: PI/2 BPSK / QPSK / 16QAM / 64QAM / 256QAM

Remark:

1. The maximum EIRP is calculated from max Output power and antenna gain, only the maximum EIRP are shown in the report, 5G NR n77/n78 for Antenna 11.
2. The device supports n77 / n78(1T4R) SRS resources on Ant.11/12/21/23, only the test data of worst Ant.11/12 is showed in the report according to the maximum power
3. 5G NR n77 support SA, n78 support SA & NSA, SA covers NSA by referring to the maximum power.
4. The EN-DC mode combination: DC_2A_n78A, DC_4A_n78A, DC_5A_n78A, DC_7A_n78A, DC_38A_n78A, DC_41A_n78A, DC_66A_n78A.

1.5 Modification of EUT

No modifications are made to the EUT during all test items.



1.6 Maximum EIRP Power and Emission Designator

5G NR n77 SA		PI/2 BPSK / QPSK		16QAM / 64QAM / 256QAM	
BW (MHz)	Frequency Range (MHz)	Maximum EIRP(W)	Emission Designator (99%OBW)	Maximum EIRP(W)	Emission Designator (99%OBW)
10	3705.00 ~ 3975.00	0.1786	9M28G7D	0.1432	9M28W7D
15	3707.52 ~ 3972.48	0.1770	14M1G7D	0.1419	14M1W7D
20	3710.01 ~ 3969.99	0.1738	18M9G7D	0.1413	18M9W7D
40	3720.00 ~ 3960.00	0.1592	38M5G7D	0.1300	38M6W7D
50	3725.01 ~ 3954.99	0.1820	48M2G7D	0.1419	48M2W7D
60	3730.02 ~ 3949.98	0.1633	57M8G7D	0.1321	57M8W7D
80	3740.01 ~ 3939.99	0.1545	77M5G7D	0.1239	77M6W7D
90	3745.02 ~ 3934.98	0.1493	87M3G7D	0.1211	87M5W7D
100	3750.00 ~ 3930.00	0.1824	97M4G7D	0.1409	97M5W7D

5G NR n78 SA		PI/2 BPSK / QPSK		16QAM / 64QAM / 256QAM	
BW (MHz)	Frequency Range (MHz)	Maximum EIRP(W)	Emission Designator (99%OBW)	Maximum EIRP(W)	Emission Designator (99%OBW)
10	3705.00 ~ 3975.00	0.1795	9M28G7D	0.1432	9M28W7D
15	3707.52 ~ 3972.48	0.1762	14M1G7D	0.1472	14M1W7D
20	3710.01 ~ 3789.99	0.1758	18M9G7D	0.1459	18M9W7D
30	3715.02 ~ 3984.98	0.1679	28M6G7D	0.1409	28M5W7D
40	3720.00 ~ 3780.00	0.1592	38M5G7D	0.1303	38M6W7D
50	3725.01 ~ 3774.99	0.1811	48M2G7D	0.1476	48M2W7D
60	3730.02 ~ 3769.98	0.1603	57M8G7D	0.1285	57M8W7D
80	3740.01 ~ 3759.99	0.1574	77M5G7D	0.1253	77M6W7D
90	3745.02 ~ 3754.98	0.1524	87M3G7D	0.1225	87M5W7D
100	3750.00	0.1799	97M4G7D	0.1393	97M5W7D

Note:

1. All modulations have been tested, only the worst test results of PSK & QAM are shown in the report.
2. 5G NR Band n77 overlaps the entire frequency range of Band n78. Therefore, excepte BW30MHz for 5G NR Band n78 is carrying out, the conducted test results provided in this report covers Band n77 as well as Band n78.



1.7 Testing Location

Sporton International Inc. (Shenzhen) is accredited to ISO/IEC 17025:2017 by American Association for Laboratory Accreditation with Certificate Number 5145.01.

Test Firm	Sporton International Inc. (Shenzhen)		
Test Site Location	1/F, 2/F, Bldg 5, Shiling Industrial Zone, Xinwei Village, Xili, Nanshan, Shenzhen, 518055 People's Republic of China TEL: +86-755-86379589 FAX: +86-755-86379595		
Test Site No.	Sporton Site No.	FCC Designation No.	FCC Test Firm Registration No.
	TH01-SZ	CN1256	421272

Test Firm	Sporton International Inc. (Shenzhen)		
Test Location Site	101, 1st Floor, Block B, Building 1, No. 2, Tengfeng 4th Road, Fenghuang Community, Fuyong Street, Baoan District, Shenzhen City Guangdong Province China 518103 TEL: +86-755-33202398		
Test Site No.	Sporton Site No.	FCC Designation No.	FCC Test Firm Registration No.
	03CH01-SZ	CN1256	421272

1.8 Test Software

Item	Site	Manufacturer	Name	Version
1.	03CH01-SZ	AUDIX	E3	6.2009-8-24

1.9 Applicable Standards

According to the specifications of the manufacturer, the EUT must comply with the requirements of the following standards:

- ♦ 47 CFR Part 2, 270
- ♦ ANSI C63.26-2015
- ♦ FCC KDB 971168 D01 Power Meas License Digital Systems v03r01
- ♦ FCC KDB 412172 D01 Determining ERP and EIRP v01r01

Remark:

1. All test items were verified and recorded according to the standards and without any deviation during the test.
2. This EUT has also been tested and complied with the requirements of FCC Part 15, Subpart B, recorded in a separate test report.



2 Test Configuration of Equipment Under Test

2.1 Test Mode

Antenna port conducted and radiated test items are performed according to KDB 971168 D01 Power Meas License Digital Systems v03r01 with maximum output power.

For radiated measurement, pre-scanned in three orthogonal panels, X, Y, Z. The worst cases (X Plane for EN-DC 41A_n78; Y Plane for 5G NR n78; Z Plane for 5G NR n77) were recorded in this report.

The device is investigated from 30MHz to 10 times of fundamental signal for radiated spurious emission test under different RB size/offset and modulations in exploratory test. Subsequently, only the worst case emissions are reported.

Orthogonal Planes of EUT	X Plane	Y Plane	Z Plane
			

Test Items	5G NR	Bandwidth (MHz)											Modulation					RB #		Test Channel				
		10	15	20	30	40	50	60	70	80	90	100	PI/2 BPSK	QPSK	16QAM	64QAM	256 QAM	1	Full	L	M	H		
Max. Output Power	n77	v	v	v	-	v	v	v	-	v	v	v	v	v	v	v	v	v	v	v	v	v	v	
	n78	v	v	v	v	v	v	v	-	v	v	v	v	v	v	v	v	v	v	v	v	v	v	
Peak-to-Average Ratio	n77			v	-		-			-		v	v					v	v	v	v	v		
	n78	Covered by 5G NR n77																						
26dB and 99% Bandwidth	n77	v	v	v	-	v	v	v	-	v	v	v	v	v	v	v	v		v			v		
	n78				v				-				v	v	v	v	v		v			v		
Conducted Band Edge	n77	v		v	-		v		-			v	v	v				v	v	v	v	v		
	n78				v				-				v	v				v	v	v	v	v		
Conducted Spurious Emission	n77	v		v	-		v		-			v	v	v				v			v	v		
	n78				v				-				v	v				v			v	v		
Frequency Stability	n77			v	-		-			-				v					v			v		
	n78	Covered by 5G NR n77																						
E.R.P / E.I.R.P	n77	v	v	v	-	v	v	v	-	v	v	v	v	v	v	v	v	v	v	v	v	v		
	n78	v	v	v	v	v	v	v	-	v	v	v	v	v	v	v	v	v	v	v	v	v		
Radiated Spurious Emission	n77	Worst Case																						v
	n78	Worst Case																						v
Note	<ol style="list-style-type: none"> The mark "v" means that this configuration is chosen for testing The mark "-" means that this bandwidth is not supported. The device is investigated from 30MHz to 10 times of fundamental signal for radiated spurious emission test under different RB size/offset and modulations in exploratory test. Subsequently, only the worst case emissions are reported. Based on engineering evaluation, only the worst modulations test results are shown in the report. 5G NR Band n77 overlaps the entire frequency range of Band n78. Therefore, excepte BW30MHz for 5G NR Band n78 is carrying out, the conducted test results provided in this report covers Band n77 as well as Band n78. Frequency Stability : Normal Voltage: 3.89Vdc, Extreme Voltage: 3.60Vdc ~4.48Vdc 																							

2.2 Connection Diagram of Test System

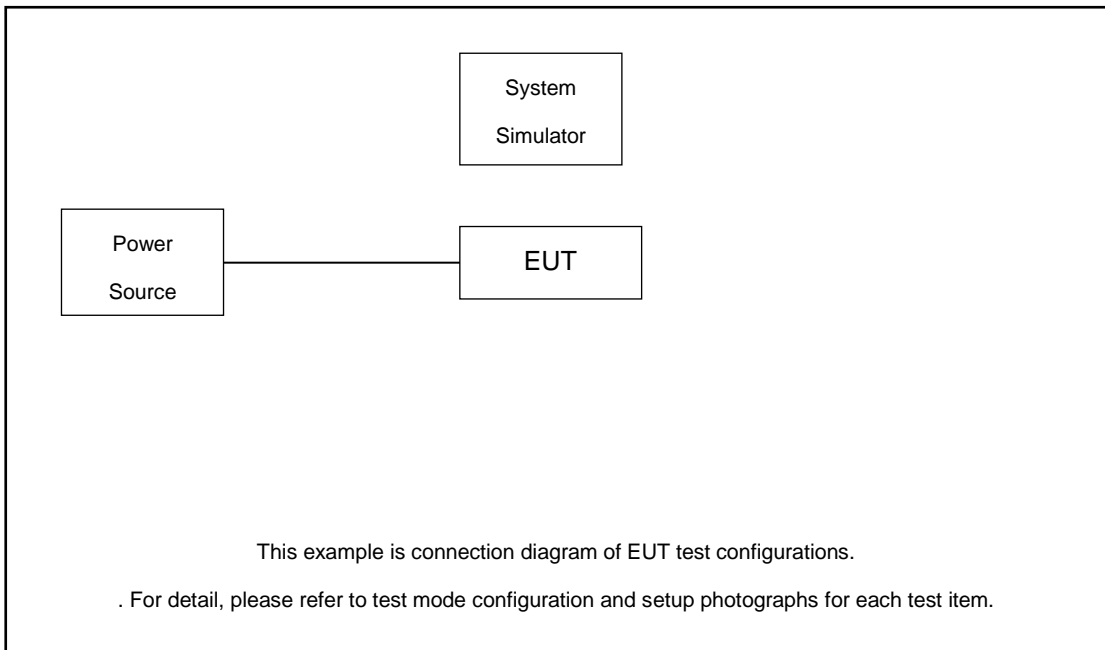

2.3 Support Unit used in test configuration and system

Item	Equipment	Trade Name	Model No.	FCC ID	Data Cable	Power Cord
1.	LTE Base Station	Anritsu	MT8821C	N/A	N/A	Unshielded, 1.8 m
2.	NR Base Station	Anritsu	MT8000A	N/A	N/A	Unshielded, 1.8 m

2.4 Measurement Results Explanation Example

For all conducted test items:

The offset level is set in the spectrum analyzer to compensate the RF cable loss between EUT conducted output port and spectrum analyzer. With the offset compensation, the spectrum analyzer reading level is exactly the EUT RF output level.

The spectrum analyzer offset is derived from RF cable loss.

Offset = RF cable loss.

Following shows an offset computation example with cable loss 8.60 dB.

Example :

$$\begin{aligned} \text{Offset(dB)} &= \text{RF cable loss(dB)}. \\ &= 8.60 \text{ (dB)} \end{aligned}$$



2.5 Frequency List of Low/Middle/High Channels

5G n77 Channel and Frequency List				
BW [MHz]	Channel/Frequency(MHz)	Lowest	Middle	Highest
100	Channel	650000	656000	662000
	Frequency	3750	3840	3930
90	Channel	649668	656000	662332
	Frequency	3745.02	3840	3934.98
80	Channel	649334	656000	662666
	Frequency	3740.01	3840	3939.99
60	Channel	648668	656000	663332
	Frequency	3730.02	3840	3949.98
50	Channel	648334	656000	663666
	Frequency	3725.01	3840	3954.99
40	Channel	648000	656000	664000
	Frequency	3720	3840	3960
20	Channel	647334	656000	664666
	Frequency	3710.01	3840	3969.99
15	Channel	647168	656000	664832
	Frequency	3707.52	3840	3972.48
10	Channel	647000	656000	665000
	Frequency	3705	3840	3975



5G n78 Channel and Frequency List				
BW [MHz]	Channel/Frequency(MHz)	Lowest	Middle	Highest
100	Channel	650000		
	Frequency	3750		
90	Channel	649668	650000	650332
	Frequency	3745.02	3750	3754.98
80	Channel	649334	650000	650666
	Frequency	3740.01	3750	3759.99
60	Channel	648668	650000	651332
	Frequency	3730.02	3750	3769.98
50	Channel	648334	650000	651666
	Frequency	3725.01	3750	3774.99
40	Channel	648000	650000	652000
	Frequency	3720	3750	3780
30	Channel	647668	650000	652332
	Frequency	3715.02	3750	3784.98
20	Channel	647334	650000	652666
	Frequency	3710.01	3750	3789.99
15	Channel	647168	650000	652832
	Frequency	3707.52	3750	3792.48
10	Channel	647000	650000	653000
	Frequency	3705	3750	3795

3 Conducted Test Items

3.1 Measuring Instruments

See list of measuring instruments of this test report.

3.2 Test Setup

3.2.1 Conducted Output Power



3.2.2 Peak-to-Average Ratio, Occupied Bandwidth, Conducted Band-Edge and Conducted Spurious Emission



3.2.3 Frequency Stability

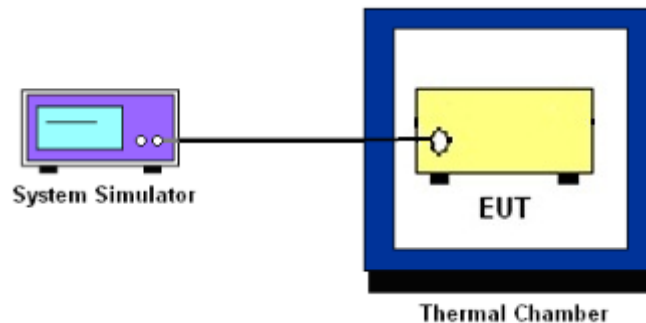

3.3 Test Result of Conducted Test

Please refer to Appendix A.



3.4 Conducted Output Power and EIRP

3.4.1 Description of the Conducted Output Power Measurement and EIRP Measurement

A system simulator was used to establish communication with the EUT. Its parameters were set to force the EUT transmitting at maximum output power. The measured power in the radio frequency on the transmitter output terminals shall be reported.

The EIRP of mobile transmitters must not exceed 1 Watts for 5G NR n77, n78.

According to KDB 412172 D01 Power Approach,

$EIRP = P_T + G_T - L_C$, $ERP = EIRP - 2.15$, where

P_T = transmitter output power in dBm

G_T = gain of the transmitting antenna in dBi

L_C = signal attenuation in the connecting cable between the transmitter and antenna in dB

3.4.2 Test Procedures

1. The testing follows ANSI C63.26 Section 5.2
2. The transmitter output port was connected to the system simulator.
3. Set EUT at maximum power through the system simulator.
4. Select lowest, middle, and highest channels for each band and different modulation.
5. Measure and record the power level from the system simulator.



3.5 Peak-to-Average Ratio

3.5.1 Description of the PAR Measurement

Power Complementary Cumulative Distribution Function (CCDF) curves provide a means for characterizing the power peaks of a digitally modulated signal on a statistical basis. A CCDF curve depicts the probability of the peak signal amplitude exceeding the average power level. Most contemporary measurement instrumentation include the capability to produce CCDF curves for an input signal provided that the instrument's resolution bandwidth can be set wide enough to accommodate the entire input signal bandwidth. In measuring transmissions in this band using an average power technique, the peak-to-average ratio (PAR) of the transmission may not exceed 13 dB.

3.5.2 Test Procedures

1. The testing follows ANSI C63.26 Section 5.2.3.4 (CCDF).
2. The EUT was connected to spectrum and system simulator via a power divider.
3. Set the CCDF (Complementary Cumulative Distribution Function) option in spectrum analyzer.
4. The highest RF powers were measured and recorded the maximum PAPR level associated with a probability of 0.1 %.
5. Record the deviation as Peak to Average Ratio.



3.6 Occupied Bandwidth

3.6.1 Description of Occupied Bandwidth Measurement

The occupied bandwidth is the width of a frequency band such that, below the lower and above the upper frequency limits, the mean powers emitted are each equal to a specified percentage 0.5% of the total mean transmitted power.

The 26 dB emission bandwidth is defined as the frequency range between two points, one above and one below the carrier frequency, at which the spectral density of the emission is attenuated 26 dB below the maximum in-band spectral density of the modulated signal. Spectral density (power per unit bandwidth) is to be measured with a detector of resolution bandwidth equal to approximately 1.0% of the emission bandwidth.

3.6.2 Test Procedures

1. The testing follows ANSI C63.26 Section 5.4
2. The EUT was connected to spectrum analyzer and system simulator via a power divider.
3. The spectrum analyzer center frequency is set to the nominal EUT channel center frequency. The span range for the spectrum analyzer shall be between two and five times the anticipated OBW.
4. The nominal resolution bandwidth (RBW) shall be in the range of 1 to 5 % of the anticipated OBW, and the VBW shall be at least 3 times the RBW.
5. Set the detection mode to peak, and the trace mode to max hold.
6. Determine the reference value: Set the EUT to transmit a modulated signal. Allow the trace to stabilize. Set the spectrum analyzer marker to the highest level of the displayed trace.
(this is the reference value)
7. Determine the “-26 dB down amplitude” as equal to (Reference Value – X).
8. Place two markers, one at the lowest and the other at the highest frequency of the envelope of the spectral display such that each marker is at or slightly below the “-X dB down amplitude” determined in step 6. If a marker is below this “-X dB down amplitude” value it shall be placed as close as possible to this value. The OBW is the positive frequency difference between the two markers.
9. Use the 99 % power bandwidth function of the spectrum analyzer and report the measured bandwidth.



3.7 Conducted Band Edge

3.7.1 Description of Conducted Band Edge Measurement

27.53(l)(2)

For mobile operations in the 3700-3980 MHz band, the conducted power of any emission outside the licensee's authorized bandwidth shall not exceed -13 dBm/MHz. Compliance with this paragraph is based on the use of measurement instrumentation employing a resolution bandwidth of 1 megahertz or greater. However, in the 1 megahertz bands immediately outside and adjacent to the licensee's frequency block, the minimum resolution bandwidth for the measurement shall be either one percent of the emission bandwidth of the fundamental emission of the transmitter or 350 kHz. In the bands between 1 and 5 MHz removed from the licensee's frequency block, the minimum resolution bandwidth for the measurement shall be 500 kHz.

3.7.2 Test Procedures

1. The testing follows ANSI C63.26 section 5.7
2. The EUT was connected to spectrum analyzer and system simulator via a power divider.
3. The band edges of low and high channels for the highest RF powers were measured.
4. Set RBW \geq 1% EBW in the 1MHz band immediately outside and adjacent to the band edge.
5. Beyond the 1 MHz band from the band edge, RBW=1MHz was used.
6. Set spectrum analyzer with RMS detector.
7. The RF fundamental frequency should be excluded against the limit line in the operating frequency band.
8. Checked that all the results comply with the emission limit line.

Example:

$$\begin{aligned} &\text{The limit line is derived from } 43 + 10\log(P)\text{dB below the transmitter power } P(\text{Watts}) \\ &= P(\text{W}) - [43 + 10\log(P)] \text{ (dB)} \\ &= [30 + 10\log(P)] \text{ (dBm)} - [43 + 10\log(P)] \text{ (dB)} = -13\text{dBm}. \end{aligned}$$

9. When using the integration method, the starting frequency of the integration shall be centered at one-half of the RBW away from the band edge.



3.8 Conducted Spurious Emission

3.8.1 Description of Conducted Spurious Emission Measurement

The power of any emission outside of the authorized operating frequency ranges must be lower than the transmitter power (P) by a factor of at least $43 + 10 \log (P)$ dB.

It is measured by means of a calibrated spectrum analyzer and scanned from 30 MHz up to a frequency including its 10th harmonic.

3.8.2 Test Procedures

1. The testing follows ANSI C63.26 section 5.7
2. The EUT was connected to spectrum analyzer and system simulator via a power divider.
3. The RF output of EUT was connected to the spectrum analyzer by RF cable and attenuator. The path loss was compensated to the results for each measurement.
4. The middle channel for the highest RF power within the transmitting frequency was measured.
5. The conducted spurious emission for the whole frequency range was taken.
6. Make the measurement with the spectrum analyzer's RBW = 1MHz, VBW = 3MHz.
7. Set spectrum analyzer with RMS detector.
8. Taking the record of maximum spurious emission.
9. The RF fundamental frequency should be excluded against the limit line in the operating frequency band.
10. The limit line is derived from $43 + 10\log(P)$ dB below the transmitter power P(Watts)
= P(W)- [43 + 10log(P)] (dB)
= [30 + 10log(P)] (dBm) - [43 + 10log(P)] (dB)
= -13dBm.



3.9 Frequency Stability

3.9.1 Description of Frequency Stability Measurement

The frequency stability shall be measured by variation of ambient temperature and variation of primary supply voltage to ensure that the fundamental emission stays within the authorized frequency block. The frequency stability of the transmitter shall be maintained within $\pm 0.00025\%$ ($\pm 2.5\text{ppm}$) of the center frequency.

3.9.2 Test Procedures for Temperature Variation

1. The testing follows ANSI C63.26 section 5.6.4
2. The EUT was set up in the thermal chamber and connected with the system simulator.
3. With power OFF, the temperature was decreased to -30°C and the EUT was stabilized before testing. Power was applied and the maximum change in frequency was recorded within one minute.
4. With power OFF, the temperature was raised in 10°C step up to 50°C . The EUT was stabilized at each step for at least half an hour. Power was applied and the maximum frequency change was recorded within one minute.

3.9.3 Test Procedures for Voltage Variation

1. The testing follows ANSI C63.26 section 5.6.5
2. The EUT was placed in a temperature chamber at $20\pm 5^{\circ}\text{C}$ and connected with the system simulator.
3. The power supply voltage to the EUT was varied from 85% to 115% of the nominal value for other than hand carried battery equipment.
4. For hand carried, battery powered equipment, reduce the primary ac or dc supply voltage to the battery operating end point, which shall be specified by the manufacturer.
5. The variation in frequency was measured for the worst case.

4 Radiated Test Items

4.1 Measuring Instruments

See list of measuring instruments of this test report.

4.2 Test Setup

4.2.1 For radiated test below 30MHz

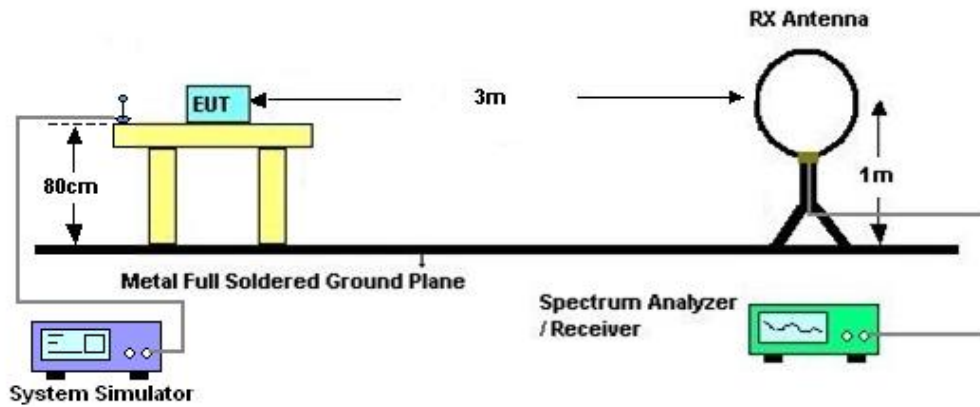

4.2.2 For radiated test from 30MHz to 1GHz

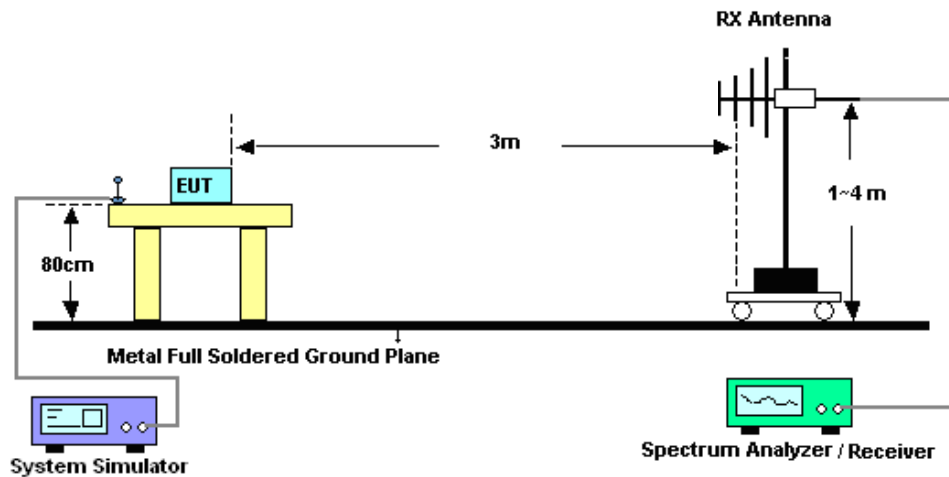

4.2.3 For radiated test above 1GHz

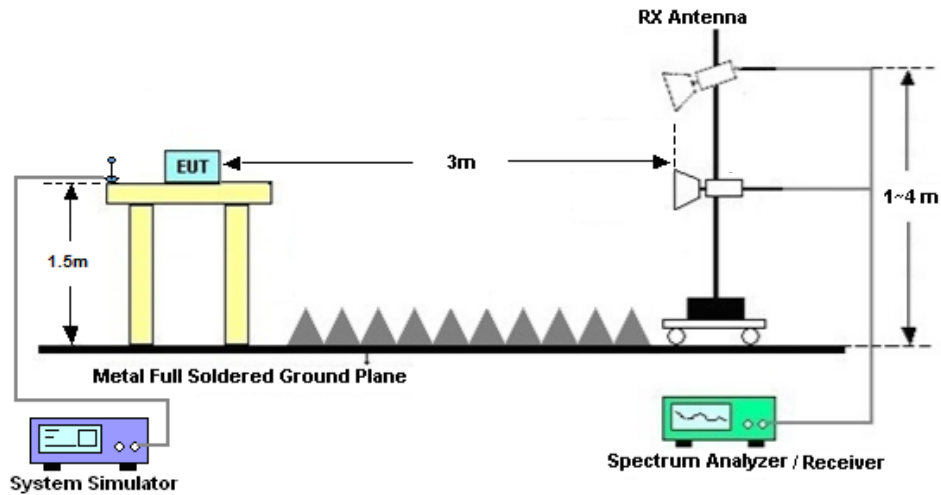

4.3 Test Result of Radiated Test

The low frequency, which started from 9 kHz to 30MHz, was pre-scanned and the result which was 20dB lower than the limit line was not reported.

Please refer to Appendix B.



4.4 Radiated Spurious Emission

4.4.1 Description of Radiated Spurious Emission

The radiated spurious emission was measured by substitution method according to ANSI C63.26. The power of any emission outside of the authorized operating frequency ranges must be attenuated below the transmitter power (P) by a factor of at least $43 + 10 \log (P)$ dB.

The spectrum is scanned from 30 MHz up to a frequency including its 10th harmonic.

4.4.2 Test Procedures

1. The testing follows ANSI C63.26 Section 5.5
2. The EUT was placed on a turntable with 0.8 meter height for frequency below 1GHz and 1.5 meter height for frequency above 1GHz respectively above ground.
3. The EUT was set 3 meters from the receiving antenna mounted on the antenna tower.
4. The table was rotated 360 degrees to determine the position of the highest spurious emission.
5. The height of the receiving antenna is varied between 1m to 4m to search the maximum spurious emission for both horizontal and vertical polarizations.
6. During the measurement, the system simulator parameters were set to force the EUT transmitting at maximum output power.
7. Make the measurement with the spectrum analyzer's RBW = 1MHz, VBW = 3MHz, taking the record of maximum spurious emission.
8. A horn antenna was substituted in place of the EUT and was driven by a signal generator.
9. Tune the output power of signal generator to the same emission level with EUT maximum spurious emission.
10. $EIRP (dBm) = S.G. Power - Tx Cable Loss + Tx Antenna Gain$
11. $ERP (dBm) = EIRP - 2.15$
12. The RF fundamental frequency should be excluded against the limit line in the operating frequency band.

The limit line is derived from $43 + 10\log(P)$ dB below the transmitter power P(Watts)
= $P(W) - [43 + 10\log(P)] (dB)$
= $[30 + 10\log(P)] (dBm) - [43 + 10\log(P)] (dB)$
= -13dBm.



5 List of Measuring Equipment

Instrument	Manufacturer	Model No.	Serial No.	Characteristics	Calibration Date	Test Date	Due Date	Remark
Spectrum Analyzer	R&S	FSV40	101078	10Hz~40GHz	Apr. 07, 2022	Jul. 05, 2022~ Jul. 22, 2022	Apr. 06, 2023	Conducted (TH01-SZ)
DC Power Supply	TTI	PL330P	290070	Max 32V , 3A	Oct. 25, 2021	Jul. 05, 2022~ Jul. 22, 2022	Oct. 24, 2022	Conducted (TH01-SZ)
Power Divider	TOJOIN	PS-2SM-04 265	60.06.020.007 7	0.4GHz~26.5GHz	Dec. 25, 2021	Jul. 05, 2022~ Jul. 22, 2022	Dec. 24, 2022	Conducted (TH01-SZ)
Thermal Chamber	Ten Billion Hongzhangroup	LP-150U	H2014081803	-40~+150°C	Jul. 14, 2021	Jul. 05, 2022~ Jul. 06, 2022	Jul. 13, 2022	Conducted (TH01-SZ)
Thermal Chamber	Ten Billion Hongzhangroup	LP-150U	H2014081803	-40~+150°C	Jul. 07, 2022	Jul. 07, 2022~ Jul. 22, 2022	Jul. 06, 2023	Conducted (TH01-SZ)
EMI Test Receiver&SA	Agilent	N9038A	MY52260185	20Hz~26.5GHz	Dec. 27, 2021	Jul. 19, 2022	Dec. 26, 2022	Radiation (03CH01-SZ)
HF Amplifier	KEYSIGHT	83017A	MY53270105	0.5GHz~26.5Ghz	Oct. 22, 2021	Jul. 19, 2022	Oct. 21, 2022	Radiation (03CH01-SZ)
Bilog Antenna	TeseQ	CBL6112D	35407	30MHz-2GHz	Sep. 28, 2021	Jul. 19, 2022	Sep. 27, 2022	Radiation (03CH01-SZ)
Double Ridge Horn Antenna	ETS-Lindgren	3117	00119436	1GHz~18GHz	Jul. 04, 2022	Jul. 19, 2022	Jul. 03, 2023	Radiation (03CH01-SZ)
SHF-EHF Horn	com-power	AH-840	101071	18Ghz-40GHz	Apr. 10, 2022	Jul. 19, 2022	Apr. 09, 2023	Radiation (03CH01-SZ)
LF Amplifier	Burgeon	BPA-530	102209	0.01~3000Mhz	Apr. 06, 2022	Jul. 19, 2022	Apr. 05, 2023	Radiation (03CH01-SZ)
HF Amplifier	MITEQ	AMF-7D-00 101800-30-1 0P-R	1943528	1GHz~18GHz	Oct. 22, 2021	Jul. 19, 2022	Oct. 21, 2022	Radiation (03CH01-SZ)
HF Amplifier	MITEQ	TTA1840-35 -HG	1871923	18GHz~40GHz	Jul. 04, 2022	Jul. 19, 2022	Jul. 03, 2023	Radiation (03CH01-SZ)
AC Power Source	Chroma	61601	616010001985	N/A	NCR	Jul. 19, 2022	NCR	Radiation (03CH01-SZ)
Turn Table	EM	EM1000	N/A	0~360 degree	NCR	Jul. 19, 2022	NCR	Radiation (03CH01-SZ)
Antenna Mast	EM	EM1000	N/A	1 m~4 m	NCR	Jul. 19, 2022	NCR	Radiation (03CH01-SZ)
Loop Antenna	R&S	HFH2-Z2	100354	9kHz~30MHz	Jul. 17, 2022	Jul. 19, 2022	Jul. 16, 2024	Radiation (03CH01-SZ)

NCR: No Calibration Required



6 Uncertainty of Evaluation

The measurement uncertainties shown below were calculated in accordance with the requirements of ANSI 63.26-2015. All the measurement uncertainty value were shown with a coverage K=2 to indicate 95% level of confidence. The measurement data show herein meets or exceeds the CISPR measurement uncertainty values specified in CISPR 16-4-2 and can be compared directly to specified limit to determine compliance.

Uncertainty of Radiated Emission Measurement (30 MHz ~ 1000 MHz)

Measuring Uncertainty for a Level of Confidence of 95% (U = 2Uc(y))	2.48dB
---	--------

Uncertainty of Radiated Emission Measurement (1 GHz ~ 18 GHz)

Measuring Uncertainty for a Level of Confidence of 95% (U = 2Uc(y))	3.53dB
---	--------

Uncertainty of Radiated Emission Measurement (18 GHz ~ 40 GHz)

Measuring Uncertainty for a Level of Confidence of 95% (U = 2Uc(y))	4.02dB
---	--------

----- THE END -----



Appendix A. Test Results of Conducted Test

Test Engineer :	Zheng Jianhan	Temperature :	24~26°C
		Relative Humidity :	40~45%

FR1 N77**Transmitter Conducted Output Power And EIRP (Ant. 11), (GT-LC)=-0.9dB**

NR Band	SCS (kHz)	Bandwidth (MHz)	Arfcn	Freq (MHz)	Modulation	RB	Conducted Power(dBm)	EIRP (dBm)	EIRP (W)
77	15	10	647000	3705	DFT-s-OFDM QPSK	1@1	22.97	22.07	0.1611
77	15	10	647000	3705	DFT-s-OFDM 16 QAM	1@1	22.05	21.15	0.1303
77	15	10	656000	3840	DFT-s-OFDM QPSK	1@1	23.17	22.27	0.1687
77	15	10	656000	3840	DFT-s-OFDM 16 QAM	1@1	22.26	21.36	0.1368
77	15	10	665000	3975	DFT-s-OFDM QPSK	1@1	23.27	22.37	0.1726
77	15	10	665000	3975	DFT-s-OFDM 16 QAM	1@1	22.37	21.47	0.1403
77	15	15	647167	3707.505	DFT-s-OFDM QPSK	1@1	23.06	22.16	0.1644
77	15	15	647167	3707.505	DFT-s-OFDM 16 QAM	1@1	22.17	21.27	0.1340
77	15	15	656000	3840	DFT-s-OFDM QPSK	1@1	23.31	22.41	0.1742
77	15	15	656000	3840	DFT-s-OFDM 16 QAM	1@1	22.3	21.4	0.1380
77	15	15	664833	3972.495	DFT-s-OFDM QPSK	1@1	23.35	22.45	0.1758
77	15	15	664833	3972.495	DFT-s-OFDM 16 QAM	1@1	22.34	21.44	0.1393
77	15	20	647334	3710.01	DFT-s-OFDM QPSK	1@1	23.03	22.13	0.1633
77	15	20	647334	3710.01	DFT-s-OFDM 16 QAM	1@1	22.11	21.21	0.1321
77	15	20	656000	3840	DFT-s-OFDM QPSK	1@1	23.29	22.39	0.1734
77	15	20	656000	3840	DFT-s-OFDM 16 QAM	1@1	22.38	21.48	0.1406
77	15	20	664666	3969.99	DFT-s-OFDM QPSK	1@1	23.3	22.4	0.1738
77	15	20	664666	3969.99	DFT-s-OFDM 16 QAM	1@1	22.4	21.5	0.1413
77	15	40	648000	3720	DFT-s-OFDM QPSK	1@1	22.67	21.77	0.1503
77	15	40	648000	3720	DFT-s-OFDM 16 QAM	1@1	21.79	20.89	0.1227

NR Band	SCS (kHz)	Bandwidth (MHz)	Arfcn	Freq (MHz)	Modulation	RB	Conducted Power(dBm)	EIRP (dBm)	EIRP (W)
77	15	40	656000	3840	DFT-s-OFDM QPSK	1@1	22.89	21.99	0.1581
77	15	40	656000	3840	DFT-s-OFDM 16 QAM	1@1	21.94	21.04	0.1271
77	15	40	664000	3960	DFT-s-OFDM QPSK	1@1	22.9	22	0.1585
77	15	40	664000	3960	DFT-s-OFDM 16 QAM	1@1	21.83	20.93	0.1239
77	15	50	648334	3725.01	DFT-s-OFDM PI/2 BPSK	135@67	23.32	22.42	0.1746
77	15	50	648334	3725.01	DFT-s-OFDM PI/2 BPSK	1@1	22.92	22.02	0.1592
77	15	50	648334	3725.01	DFT-s-OFDM PI/2 BPSK	1@268	23.09	22.19	0.1656
77	15	50	648334	3725.01	DFT-s-OFDM QPSK	135@67	23.36	22.46	0.1762
77	15	50	648334	3725.01	DFT-s-OFDM QPSK	1@1	22.94	22.04	0.1600
77	15	50	648334	3725.01	DFT-s-OFDM QPSK	1@268	23.12	22.22	0.1667
77	15	50	648334	3725.01	DFT-s-OFDM 16 QAM	135@67	22.3	21.4	0.1380
77	15	50	648334	3725.01	DFT-s-OFDM 16 QAM	1@1	21.93	21.03	0.1268
77	15	50	648334	3725.01	DFT-s-OFDM 16 QAM	1@268	22.12	21.22	0.1324
77	15	50	648334	3725.01	DFT-s-OFDM 64 QAM	135@67	20.94	20.04	0.1009
77	15	50	648334	3725.01	DFT-s-OFDM 64 QAM	1@1	20.99	20.09	0.1021
77	15	50	648334	3725.01	DFT-s-OFDM 64 QAM	1@268	21.15	20.25	0.1059
77	15	50	648334	3725.01	DFT-s-OFDM 256 QAM	135@67	18.93	18.03	0.0635
77	15	50	648334	3725.01	DFT-s-OFDM 256 QAM	1@1	18.76	17.86	0.0611
77	15	50	648334	3725.01	DFT-s-OFDM 256 QAM	1@268	18.92	18.02	0.0634
77	15	50	648334	3725.01	CP-OFDM QPSK	135@67	21.8	20.9	0.1230
77	15	50	648334	3725.01	CP-OFDM QPSK	1@1	21.66	20.76	0.1191
77	15	50	648334	3725.01	CP-OFDM QPSK	1@268	21.67	20.77	0.1194
77	15	50	656000	3840	DFT-s-OFDM PI/2 BPSK	135@67	23.38	22.48	0.1770

NR Band	SCS (kHz)	Bandwidth (MHz)	Arfcn	Freq (MHz)	Modulation	RB	Conducted Power(dBm)	EIRP (dBm)	EIRP (W)
77	15	50	656000	3840	DFT-s-OFDM PI/2 BPSK	1@1	23.18	22.28	0.1690
77	15	50	656000	3840	DFT-s-OFDM PI/2 BPSK	1@268	22.98	22.08	0.1614
77	15	50	656000	3840	DFT-s-OFDM QPSK	135@67	23.44	22.54	0.1795
77	15	50	656000	3840	DFT-s-OFDM QPSK	1@1	23.19	22.29	0.1694
77	15	50	656000	3840	DFT-s-OFDM QPSK	1@268	22.97	22.07	0.1611
77	15	50	656000	3840	DFT-s-OFDM 16 QAM	135@67	22.38	21.48	0.1406
77	15	50	656000	3840	DFT-s-OFDM 16 QAM	1@1	22.2	21.3	0.1349
77	15	50	656000	3840	DFT-s-OFDM 16 QAM	1@268	21.97	21.07	0.1279
77	15	50	656000	3840	DFT-s-OFDM 64 QAM	135@67	20.99	20.09	0.1021
77	15	50	656000	3840	DFT-s-OFDM 64 QAM	1@1	21.16	20.26	0.1062
77	15	50	656000	3840	DFT-s-OFDM 64 QAM	1@268	20.96	20.06	0.1014
77	15	50	656000	3840	DFT-s-OFDM 256 QAM	135@67	19.02	18.12	0.0649
77	15	50	656000	3840	DFT-s-OFDM 256 QAM	1@1	18.91	18.01	0.0632
77	15	50	656000	3840	DFT-s-OFDM 256 QAM	1@268	18.77	17.87	0.0612
77	15	50	656000	3840	CP-OFDM QPSK	135@67	21.85	20.95	0.1245
77	15	50	656000	3840	CP-OFDM QPSK	1@1	21.64	20.74	0.1186
77	15	50	656000	3840	CP-OFDM QPSK	1@268	21.52	20.62	0.1153
77	15	50	663666	3954.99	DFT-s-OFDM PI/2 BPSK	135@67	23.5	22.6	0.1820
77	15	50	663666	3954.99	DFT-s-OFDM PI/2 BPSK	1@1	23.19	22.29	0.1694
77	15	50	663666	3954.99	DFT-s-OFDM PI/2 BPSK	1@268	23.16	22.26	0.1683
77	15	50	663666	3954.99	DFT-s-OFDM QPSK	135@67	23.46	22.56	0.1803
77	15	50	663666	3954.99	DFT-s-OFDM QPSK	1@1	23.19	22.29	0.1694
77	15	50	663666	3954.99	DFT-s-OFDM QPSK	1@268	23.16	22.26	0.1683

NR Band	SCS (kHz)	Bandwidth (MHz)	Arfcn	Freq (MHz)	Modulation	RB	Conducted Power(dBm)	EIRP (dBm)	EIRP (W)
77	15	50	663666	3954.99	DFT-s-OFDM 16 QAM	135@67	22.42	21.52	0.1419
77	15	50	663666	3954.99	DFT-s-OFDM 16 QAM	1@1	22.16	21.26	0.1337
77	15	50	663666	3954.99	DFT-s-OFDM 16 QAM	1@268	22.15	21.25	0.1334
77	15	50	663666	3954.99	DFT-s-OFDM 64 QAM	135@67	21.06	20.16	0.1038
77	15	50	663666	3954.99	DFT-s-OFDM 64 QAM	1@1	21.2	20.3	0.1072
77	15	50	663666	3954.99	DFT-s-OFDM 64 QAM	1@268	21.22	20.32	0.1076
77	15	50	663666	3954.99	DFT-s-OFDM 256 QAM	135@67	19.03	18.13	0.0650
77	15	50	663666	3954.99	DFT-s-OFDM 256 QAM	1@1	19	18.1	0.0646
77	15	50	663666	3954.99	DFT-s-OFDM 256 QAM	1@268	18.97	18.07	0.0641
77	15	50	663666	3954.99	CP-OFDM QPSK	135@67	21.95	21.05	0.1274
77	15	50	663666	3954.99	CP-OFDM QPSK	1@1	21.65	20.75	0.1189
77	15	50	663666	3954.99	CP-OFDM QPSK	1@268	21.69	20.79	0.1199

Frequency Stability

NR Band	SCS (kHz)	Bandwidth (MHz)	Arfcn	Freq (MHz)	Modulation	RB	Deviation (ppm)	Verdict	Environment
77	15	20	656000	3840.0	DFT-s-OFDM QPSK	100@0	0.0029	PASS	NV
77	15	20	656000	3840.0	DFT-s-OFDM QPSK	100@0	0.0023	PASS	LV
77	15	20	656000	3840.0	DFT-s-OFDM QPSK	100@0	0.0057	PASS	HV
77	15	20	656000	3840.0	DFT-s-OFDM QPSK	100@0	0.0064	PASS	-30°C
77	15	20	656000	3840.0	DFT-s-OFDM QPSK	100@0	0.0027	PASS	-20°C
77	15	20	656000	3840.0	DFT-s-OFDM QPSK	100@0	0.0056	PASS	-10°C
77	15	20	656000	3840.0	DFT-s-OFDM QPSK	100@0	0.0056	PASS	0°C
77	15	20	656000	3840.0	DFT-s-OFDM QPSK	100@0	0.0053	PASS	10°C
77	15	20	656000	3840.0	DFT-s-OFDM QPSK	100@0	0.0029	PASS	20°C
77	15	20	656000	3840.0	DFT-s-OFDM QPSK	100@0	0.0058	PASS	30°C
77	15	20	656000	3840.0	DFT-s-OFDM QPSK	100@0	0.0063	PASS	40°C
77	15	20	656000	3840.0	DFT-s-OFDM QPSK	100@0	0.0033	PASS	50°C

Peak to Average Ratio

NR Band	SCS (kHz)	Bandwidth (MHz)	Arfcn	Freq (MHz)	Modulation	RB	Result (dB)	Limit (dB)	Verdict
77	15	20	647334	3710.01	DFT-s-OFDM PI/2 BPSK	100@0	4.08	13	PASS
77	15	20	647334	3710.01	DFT-s-OFDM PI/2 BPSK	1@0	4.98	13	PASS
77	15	20	647334	3710.01	DFT-s-OFDM QPSK	100@0	5.5	13	PASS
77	15	20	647334	3710.01	DFT-s-OFDM QPSK	1@0	5.97	13	PASS
77	15	20	656000	3840.0	DFT-s-OFDM PI/2 BPSK	100@0	4.02	13	PASS
77	15	20	656000	3840.0	DFT-s-OFDM PI/2 BPSK	1@0	5.04	13	PASS
77	15	20	656000	3840.0	DFT-s-OFDM QPSK	100@0	5.42	13	PASS
77	15	20	656000	3840.0	DFT-s-OFDM QPSK	1@0	5.47	13	PASS
77	15	20	664666	3969.99	DFT-s-OFDM PI/2 BPSK	100@0	4.13	13	PASS
77	15	20	664666	3969.99	DFT-s-OFDM PI/2 BPSK	1@0	5.51	13	PASS
77	15	20	664666	3969.99	DFT-s-OFDM QPSK	100@0	5.42	13	PASS
77	15	20	664666	3969.99	DFT-s-OFDM QPSK	1@0	5.76	13	PASS

N77(20M)_DFT-s-OFDM_PI_2-BPSK_Outer_Full_Low_CH

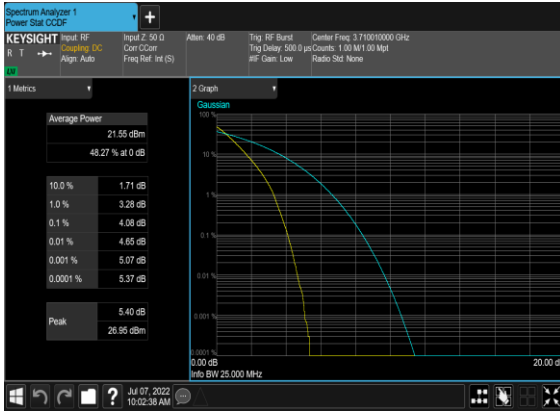

N77(20M)_DFT-s-OFDM_PI_2-BPSK_Edge_1RB_Left_Low_CH

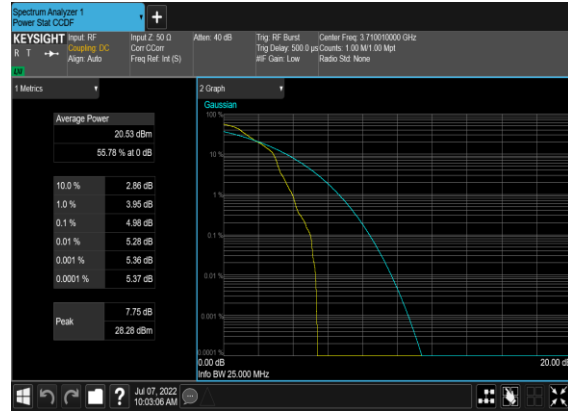

N77(20M)_DFT-s-OFDM_QPSK_Outer_Full_Low_CH

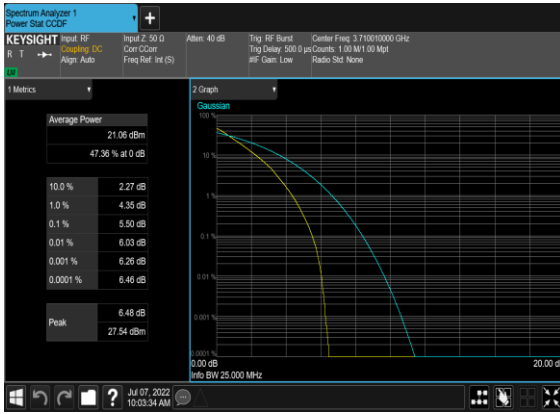

N77(20M)_DFT-s-OFDM_QPSK_Edge_1RB_Left_Low_CH

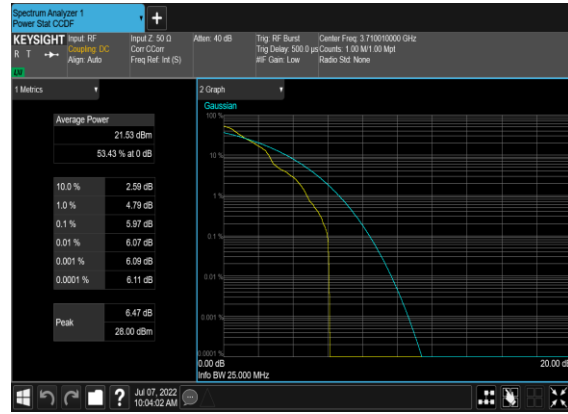

N77(20M)_DFT-s-OFDM_PI_2-BPSK_Outer_Full_Mid_CH

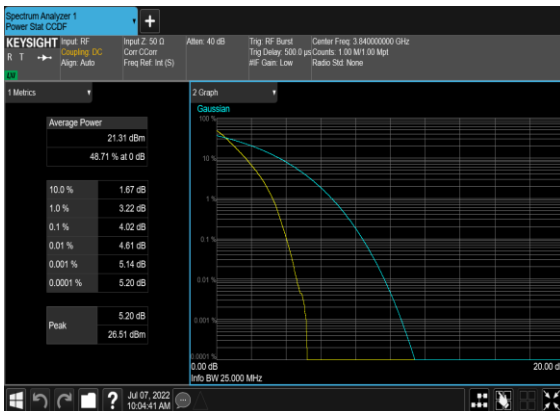

N77(20M)_DFT-s-OFDM_PI_2-BPSK_Edge_1RB_Left_Mid_CH

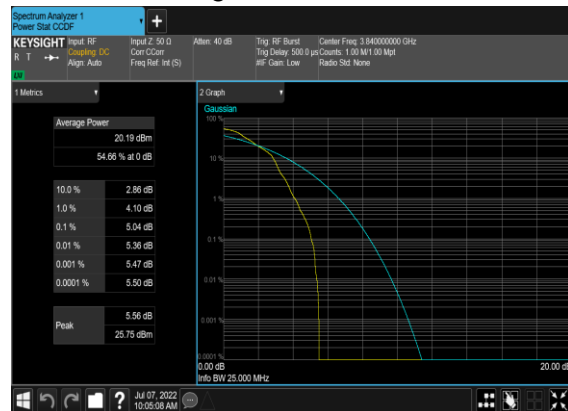

N77(20M)_DFT-s-OFDM_QPSK_Outer_Full_Mid_CH

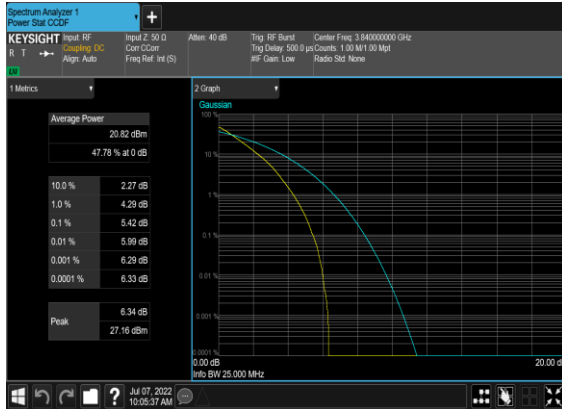

N77(20M)_DFT-s-OFDM_QPSK_Edge_1RB_Left_Mid_CH

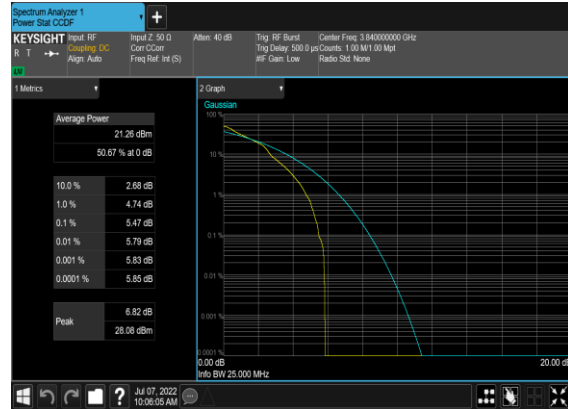

N77(20M)_DFT-s-OFDM_PI_2-BPSK_Outer_Full_High_CH

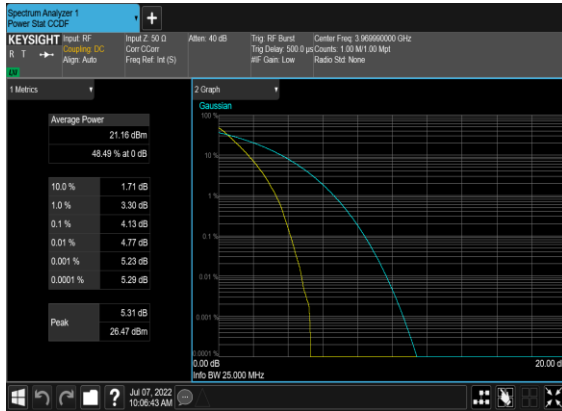

N77(20M)_DFT-s-OFDM_PI_2-BPSK_Edge_1RB_Left_High_CH

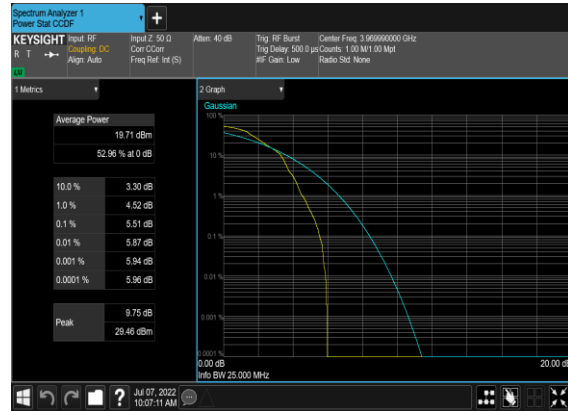

N77(20M)_DFT-s-OFDM_QPSK_Outer_Full_High_CH

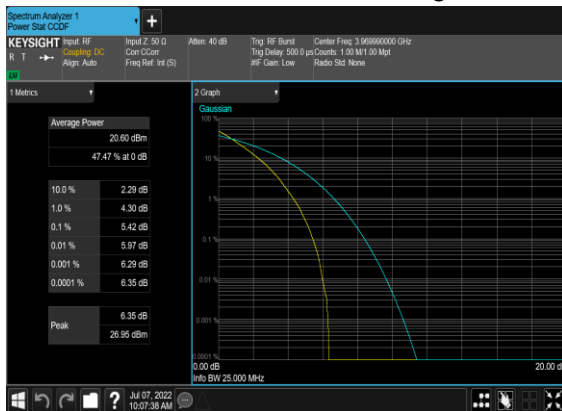

N77(20M)_DFT-s-OFDM_QPSK_Edge_1RB_Left_High_CH

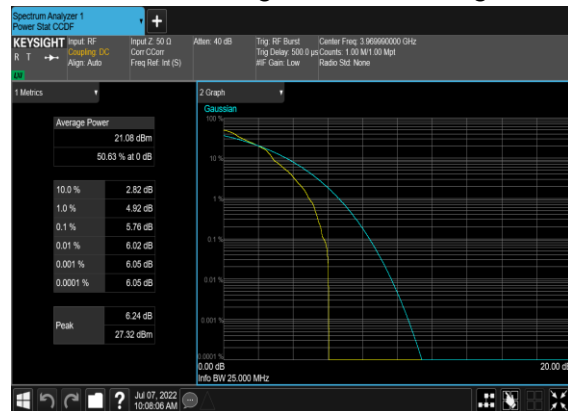

Occupied Bandwidth

NR Band	SCS (kHz)	Bandwidth (MHz)	Arfcn	Freq (MHz)	Modulation	RB	OBW (MHz)	26dB OBW (MHz)
77	15	10	656000	3840.0	DFT-s-OFDM PI/2 BPSK	50@0	8.9086	9.475
77	15	10	656000	3840.0	DFT-s-OFDM QPSK	50@0	8.9056	9.577
77	15	10	656000	3840.0	CP-OFDM QPSK	52@0	9.2791	9.796
77	15	10	656000	3840.0	CP-OFDM 16 QAM	52@0	9.2825	10.03
77	15	10	656000	3840.0	CP-OFDM 64 QAM	52@0	9.2778	9.806
77	15	10	656000	3840.0	CP-OFDM 256 QAM	52@0	9.2753	9.858
77	15	15	656000	3840.0	DFT-s-OFDM PI/2 BPSK	75@0	13.385	14.08
77	15	15	656000	3840.0	DFT-s-OFDM QPSK	75@0	13.388	13.99
77	15	15	656000	3840.0	CP-OFDM QPSK	79@0	14.09	14.85
77	15	15	656000	3840.0	CP-OFDM 16 QAM	79@0	14.123	14.69
77	15	15	656000	3840.0	CP-OFDM 64 QAM	79@0	14.094	14.69
77	15	15	656000	3840.0	CP-OFDM 256 QAM	79@0	14.098	14.73
77	15	20	656000	3840.0	DFT-s-OFDM PI/2 BPSK	100@0	17.865	18.81
77	15	20	656000	3840.0	DFT-s-OFDM QPSK	100@0	17.842	18.67
77	15	20	656000	3840.0	CP-OFDM QPSK	106@0	18.884	19.96
77	15	20	656000	3840.0	CP-OFDM 16 QAM	106@0	18.91	19.9
77	15	20	656000	3840.0	CP-OFDM 64 QAM	106@0	18.875	19.82
77	15	20	656000	3840.0	CP-OFDM 256 QAM	106@0	18.89	19.87
77	15	40	656000	3840.0	DFT-s-OFDM PI/2 BPSK	216@0	38.547	39.8
77	15	40	656000	3840.0	DFT-s-OFDM QPSK	216@0	38.543	40.25
77	15	40	656000	3840.0	CP-OFDM QPSK	216@0	38.458	39.98
77	15	40	656000	3840.0	CP-OFDM 16 QAM	216@0	38.58	40.07
77	15	40	656000	3840.0	CP-OFDM 64 QAM	216@0	38.578	39.89

NR Band	SCS (kHz)	Bandwidth (MHz)	Arfcn	Freq (MHz)	Modulation	RB	OBW (MHz)	26dB OBW (MHz)
77	15	40	656000	3840.0	CP-OFDM 256 QAM	216@0	38.568	39.97
77	15	50	656000	3840.0	DFT-s- OFDM PI/2 BPSK	270@0	48.191	49.79
77	15	50	656000	3840.0	DFT-s- OFDM QPSK	270@0	48.21	50.14
77	15	50	656000	3840.0	CP-OFDM QPSK	270@0	48.08	49.76
77	15	50	656000	3840.0	CP-OFDM 16 QAM	270@0	48.243	49.86
77	15	50	656000	3840.0	CP-OFDM 64 QAM	270@0	48.158	49.77
77	15	50	656000	3840.0	CP-OFDM 256 QAM	270@0	48.14	49.89

N77(10M)_DFT-s-OFDM_PI_2-BPSK_Outer_Full_Mid_CH

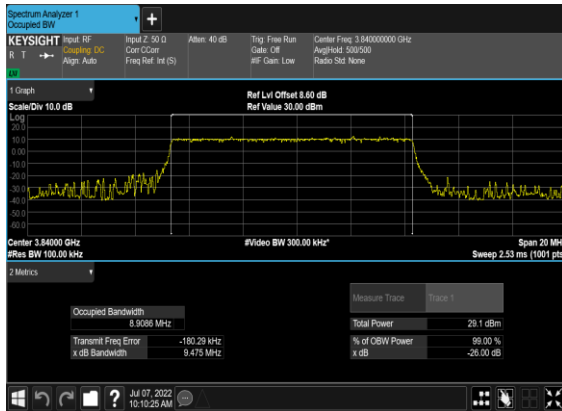

N77(10M)_DFT-s-OFDM_QPSK_Outer_Full_Mid_CH

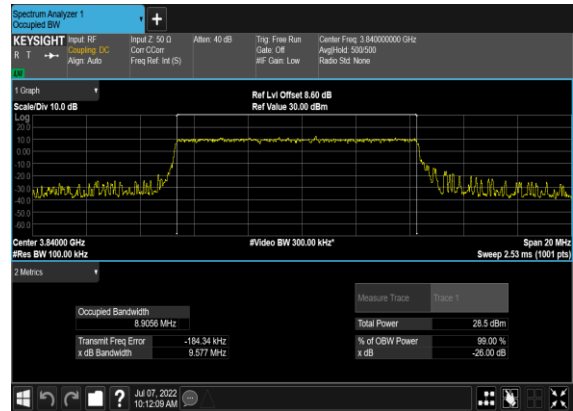

N77(10M)_CP-OFDM_QPSK_Outer_Full_Mid_CH

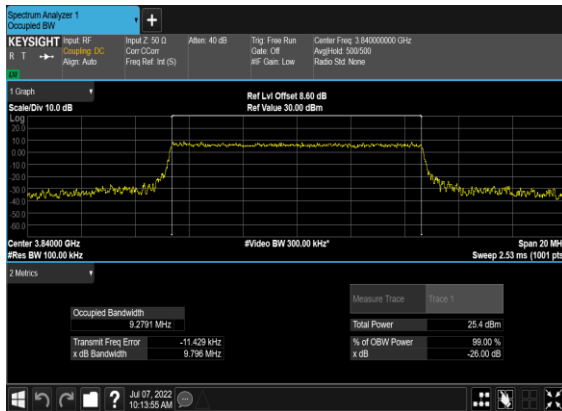

N77(10M)_CP-OFDM_16QAM_Outer_Full_Mid_CH

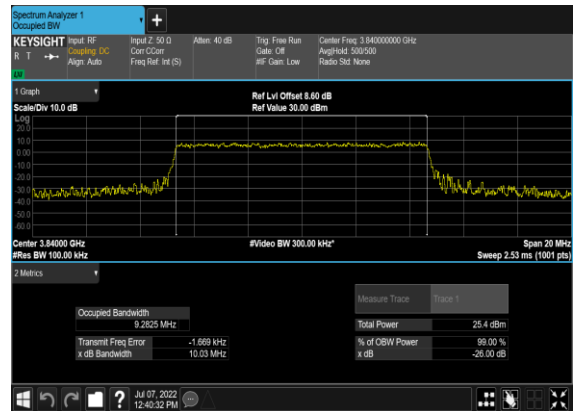

N77(10M)_CP-OFDM_64QAM_Outer_Full_Mid_CH

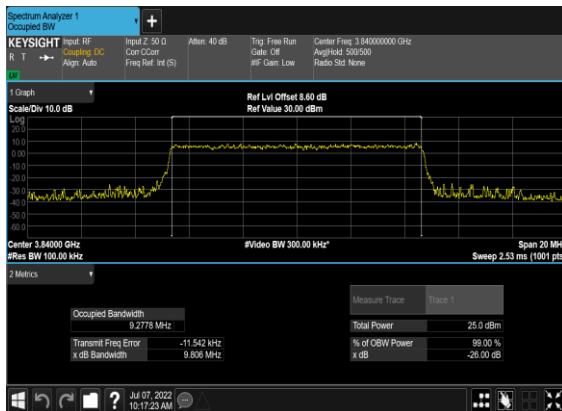

N77(10M)_CP-OFDM_256QAM_Outer_Full_Mid_CH

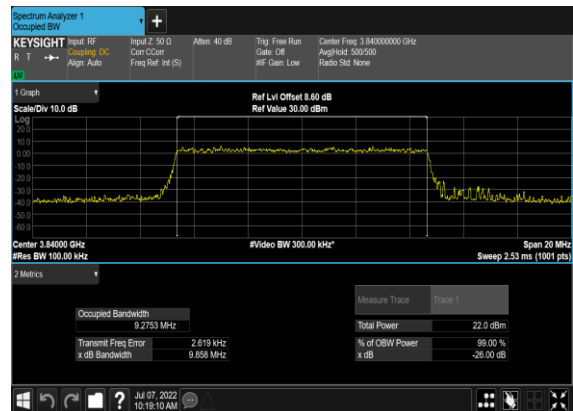

N77(15M)_DFT-s-OFDM_PI_2- BPSK_Outer_Full_Mid_CH

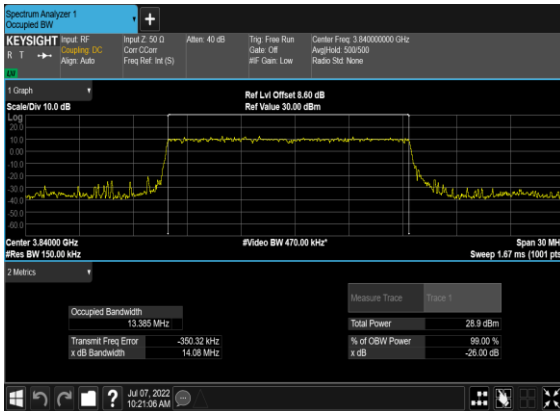

N77(15M)_DFT-s- OFDM_QPSK_Outer_Full_Mid_CH

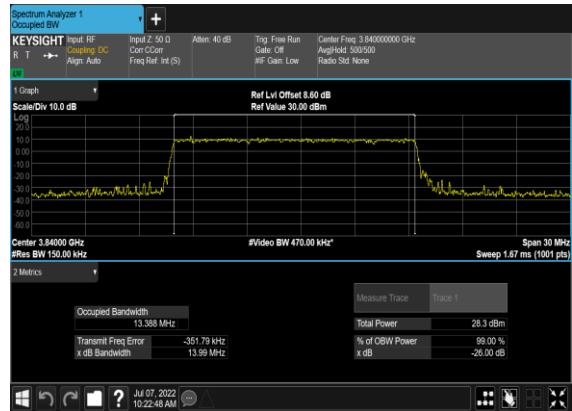

N77(15M)_CP- OFDM_QPSK_Outer_Full_Mid_CH



N77(15M)_CP-OFDM_16 QAM_Outer_Full_Mid_CH

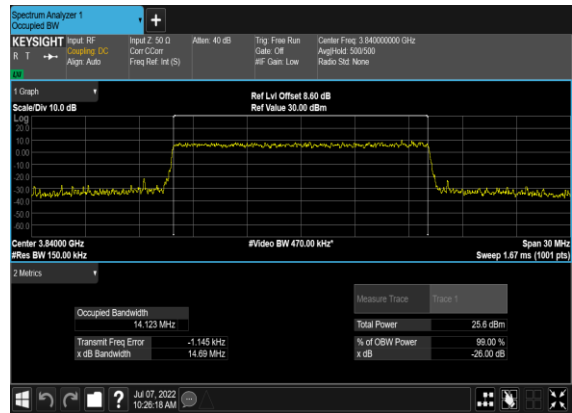

N77(15M)_CP-OFDM_64 QAM_Outer_Full_Mid_CH

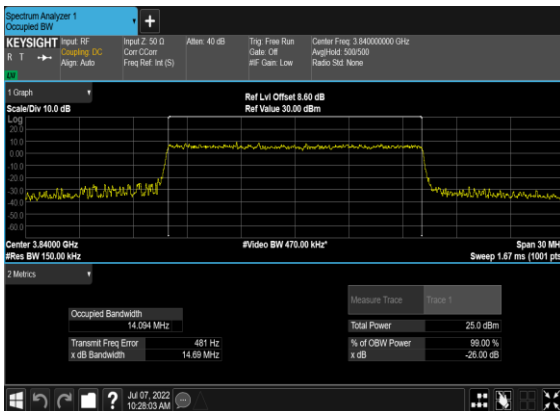

N77(15M)_CP-OFDM_256 QAM_Outer_Full_Mid_CH

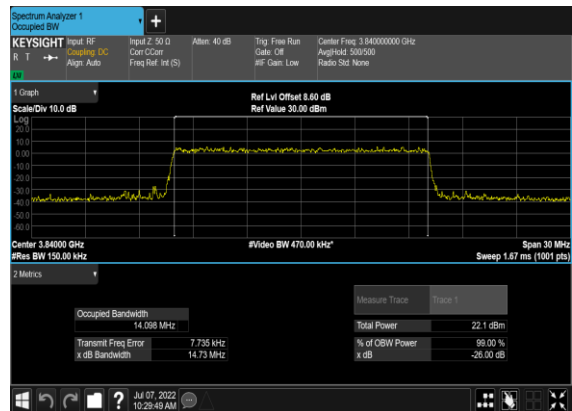

N77(20M)_DFT-s-OFDM_PI_2-BPSK_Outer_Full_Mid_CH

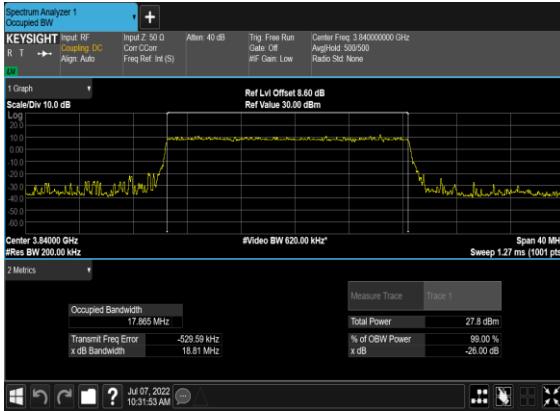

N77(20M)_DFT-s-OFDM_QPSK_Outer_Full_Mid_CH

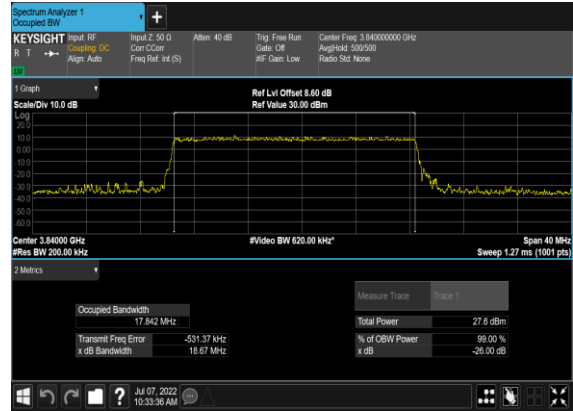

N77(20M)_CP-OFDM_QPSK_Outer_Full_Mid_CH

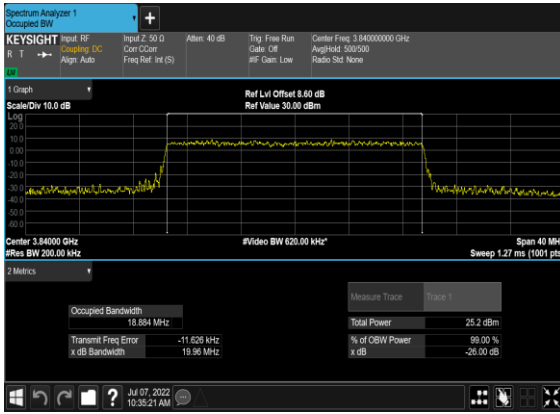

N77(20M)_CP-OFDM_16QAM_Outer_Full_Mid_CH

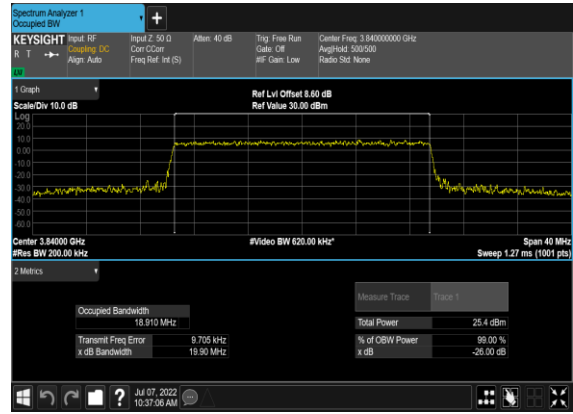

N77(20M)_CP-OFDM_64QAM_Outer_Full_Mid_CH

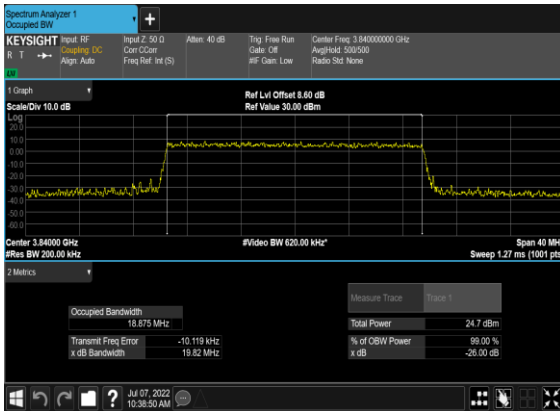

N77(20M)_CP-OFDM_256QAM_Outer_Full_Mid_CH

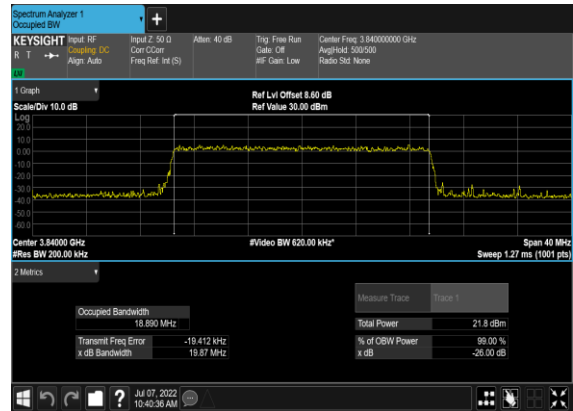

N77(40M)_DFT-s-OFDM_PI-2-BPSK_Outer_Full_Mid_CH

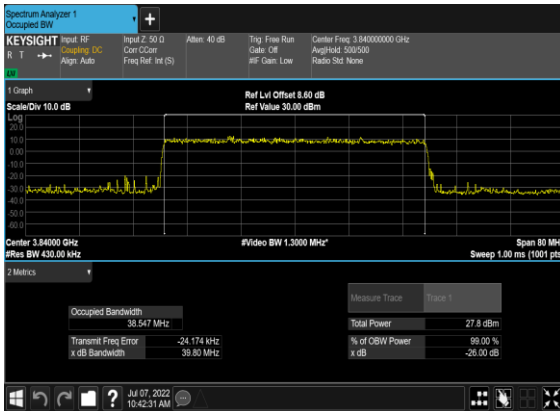

N77(40M)_DFT-s-OFDM_QPSK_Outer_Full_Mid_CH

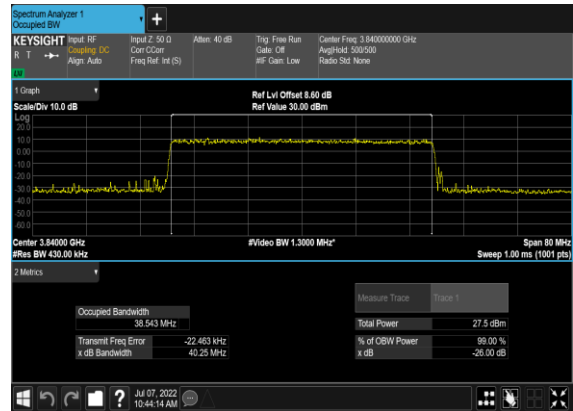

N77(40M)_CP-OFDM_QPSK_Outer_Full_Mid_CH

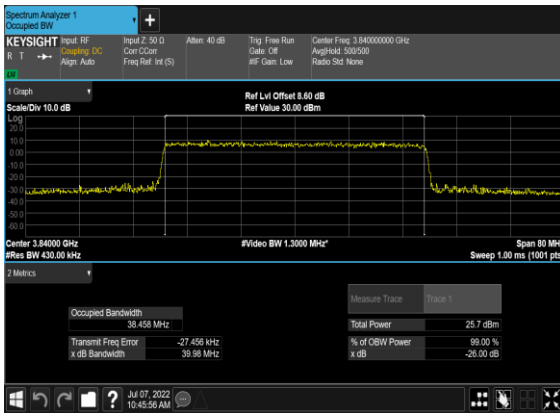

N77(40M)_CP-OFDM_16QAM_Outer_Full_Mid_CH

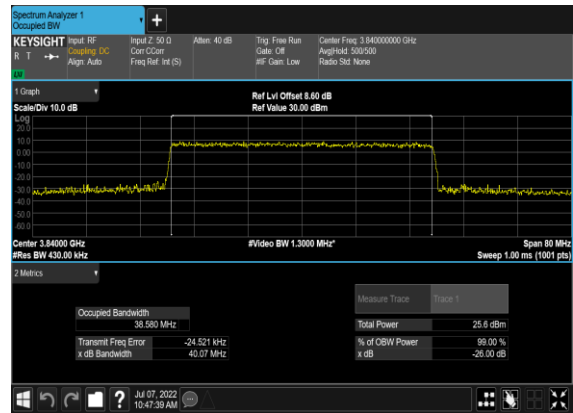

N77(40M)_CP-OFDM_64QAM_Outer_Full_Mid_CH

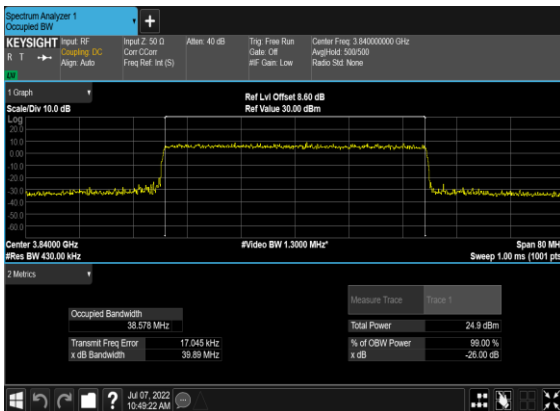

N77(40M)_CP-OFDM_256QAM_Outer_Full_Mid_CH

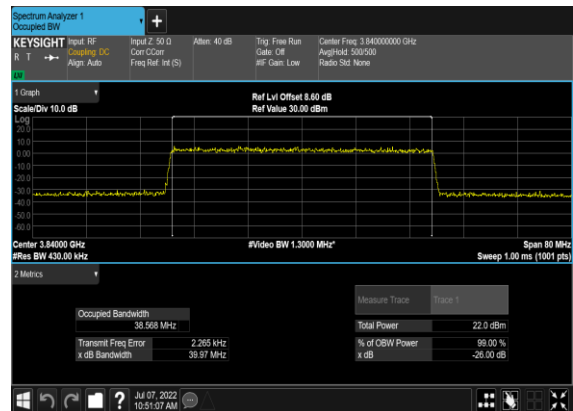

N77(50M)_DFT-s-OFDM_PI_2-BPSK_Outer_Full_Mid_CH

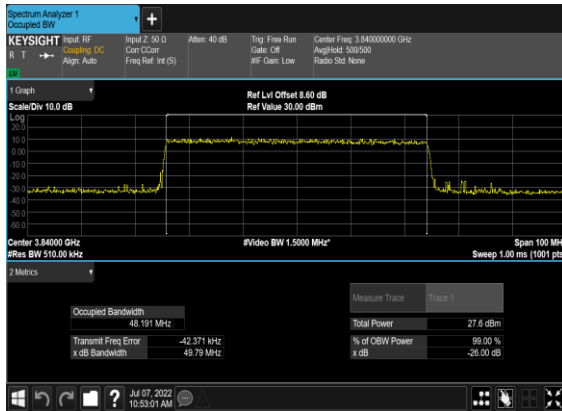

N77(50M)_DFT-s-OFDM_QPSK_Outer_Full_Mid_CH

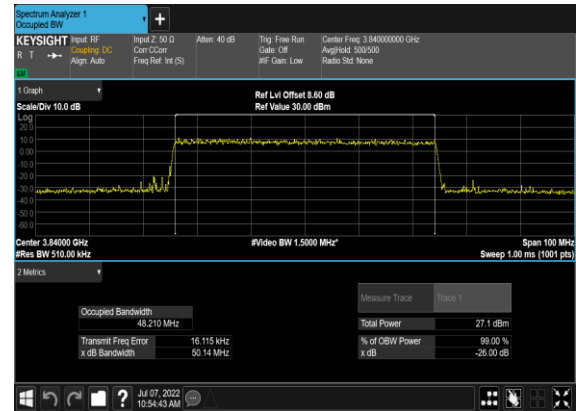

N77(50M)_CP-OFDM_QPSK_Outer_Full_Mid_CH

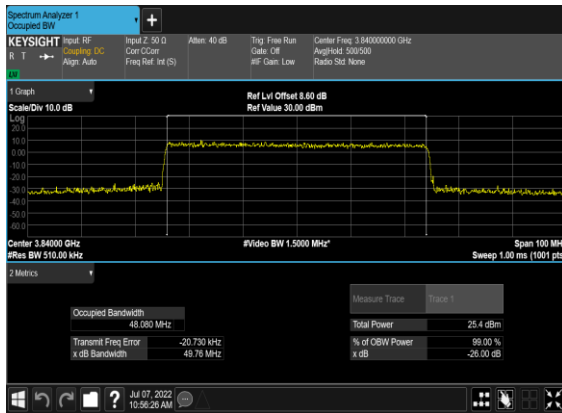

N77(50M)_CP-OFDM_16QAM_Outer_Full_Mid_CH

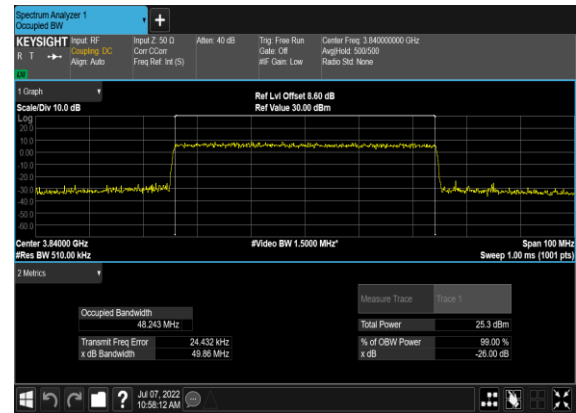

N77(50M)_CP-OFDM_64QAM_Outer_Full_Mid_CH

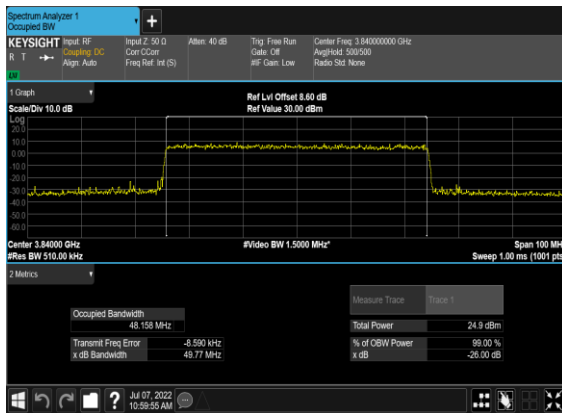

N77(50M)_CP-OFDM_256QAM_Outer_Full_Mid_CH

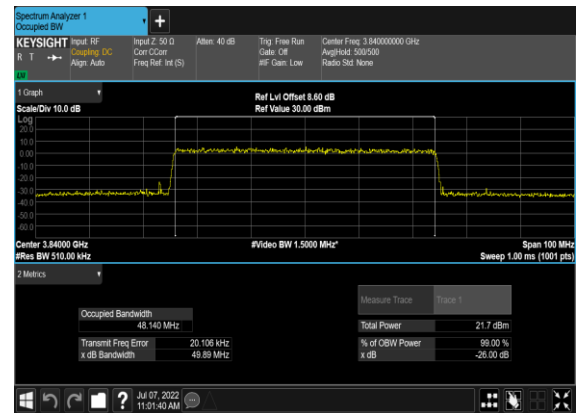

Conducted Spurious Emissions

NR Band	SCS (kHz)	Bandwidth (MHz)	Arfcn	Freq (MHz)	Modulation	RB	Result	Verdict
77	15	10	647000	3705.0	DFT-s-OFDM BPSK	1@0	see graph	---
77	15	10	647000	3705.0	DFT-s-OFDM BPSK	1@0	see graph	PASS
77	15	10	647000	3705.0	DFT-s-OFDM BPSK	1@0	see graph	PASS
77	15	10	647000	3705.0	DFT-s-OFDM QPSK	1@0	see graph	---
77	15	10	647000	3705.0	DFT-s-OFDM QPSK	1@0	see graph	PASS
77	15	10	647000	3705.0	DFT-s-OFDM QPSK	1@0	see graph	PASS
77	15	10	656000	3840.0	DFT-s-OFDM BPSK	1@0	see graph	---
77	15	10	656000	3840.0	DFT-s-OFDM BPSK	1@0	see graph	PASS
77	15	10	656000	3840.0	DFT-s-OFDM BPSK	1@0	see graph	PASS
77	15	10	656000	3840.0	DFT-s-OFDM QPSK	1@0	see graph	---
77	15	10	656000	3840.0	DFT-s-OFDM QPSK	1@0	see graph	PASS
77	15	10	656000	3840.0	DFT-s-OFDM QPSK	1@0	see graph	PASS
77	15	10	665000	3975.0	DFT-s-OFDM BPSK	1@0	see graph	---
77	15	10	665000	3975.0	DFT-s-OFDM BPSK	1@0	see graph	PASS
77	15	10	665000	3975.0	DFT-s-OFDM BPSK	1@0	see graph	PASS
77	15	10	665000	3975.0	DFT-s-OFDM QPSK	1@0	see graph	---
77	15	10	665000	3975.0	DFT-s-OFDM QPSK	1@0	see graph	PASS
77	15	10	665000	3975.0	DFT-s-OFDM QPSK	1@0	see graph	PASS
77	15	20	647334	3710.01	DFT-s-OFDM BPSK	1@0	see graph	---
77	15	20	647334	3710.01	DFT-s-OFDM BPSK	1@0	see graph	PASS
77	15	20	647334	3710.01	DFT-s-OFDM BPSK	1@0	see graph	PASS

NR Band	SCS (kHz)	Bandwidth (MHz)	Arfcn	Freq (MHz)	Modulation	RB	Result	Verdict
77	15	20	647334	3710.01	DFT-s-OFDM QPSK	1@0	see graph	---
77	15	20	647334	3710.01	DFT-s-OFDM QPSK	1@0	see graph	PASS
77	15	20	647334	3710.01	DFT-s-OFDM QPSK	1@0	see graph	PASS
77	15	20	656000	3840.0	DFT-s-OFDM BPSK	1@0	see graph	---
77	15	20	656000	3840.0	DFT-s-OFDM BPSK	1@0	see graph	PASS
77	15	20	656000	3840.0	DFT-s-OFDM BPSK	1@0	see graph	PASS
77	15	20	656000	3840.0	DFT-s-OFDM QPSK	1@0	see graph	---
77	15	20	656000	3840.0	DFT-s-OFDM QPSK	1@0	see graph	PASS
77	15	20	656000	3840.0	DFT-s-OFDM QPSK	1@0	see graph	PASS
77	15	20	664666	3969.99	DFT-s-OFDM BPSK	1@0	see graph	---
77	15	20	664666	3969.99	DFT-s-OFDM BPSK	1@0	see graph	PASS
77	15	20	664666	3969.99	DFT-s-OFDM BPSK	1@0	see graph	PASS
77	15	20	664666	3969.99	DFT-s-OFDM QPSK	1@0	see graph	---
77	15	20	664666	3969.99	DFT-s-OFDM QPSK	1@0	see graph	PASS
77	15	20	664666	3969.99	DFT-s-OFDM QPSK	1@0	see graph	PASS
77	15	20	664666	3969.99	DFT-s-OFDM QPSK	1@0	see graph	PASS
77	15	50	648334	3725.01	DFT-s-OFDM BPSK	1@0	see graph	---
77	15	50	648334	3725.01	DFT-s-OFDM BPSK	1@0	see graph	PASS
77	15	50	648334	3725.01	DFT-s-OFDM BPSK	1@0	see graph	PASS
77	15	50	648334	3725.01	DFT-s-OFDM QPSK	1@0	see graph	---
77	15	50	648334	3725.01	DFT-s-OFDM QPSK	1@0	see graph	PASS
77	15	50	648334	3725.01	DFT-s-OFDM QPSK	1@0	see graph	PASS
77	15	50	656000	3840.0	DFT-s-OFDM BPSK	1@0	see graph	---

NR Band	SCS (kHz)	Bandwidth (MHz)	Arfcn	Freq (MHz)	Modulation	RB	Result	Verdict
77	15	50	656000	3840.0	DFT-s-OFDM BPSK	1@0	see graph	PASS
77	15	50	656000	3840.0	DFT-s-OFDM BPSK	1@0	see graph	PASS
77	15	50	656000	3840.0	DFT-s-OFDM QPSK	1@0	see graph	---
77	15	50	656000	3840.0	DFT-s-OFDM QPSK	1@0	see graph	PASS
77	15	50	656000	3840.0	DFT-s-OFDM QPSK	1@0	see graph	PASS
77	15	50	663666	3954.99	DFT-s-OFDM BPSK	1@0	see graph	---
77	15	50	663666	3954.99	DFT-s-OFDM BPSK	1@0	see graph	PASS
77	15	50	663666	3954.99	DFT-s-OFDM BPSK	1@0	see graph	PASS
77	15	50	663666	3954.99	DFT-s-OFDM QPSK	1@0	see graph	---
77	15	50	663666	3954.99	DFT-s-OFDM QPSK	1@0	see graph	PASS
77	15	50	663666	3954.99	DFT-s-OFDM QPSK	1@0	see graph	PASS

N77(10M)_DFT-s-OFDM_BPSK_Edge_1RB_Left_Low_CH



N77(10M)_DFT-s-OFDM_BPSK_Edge_1RB_Left_Low_CH

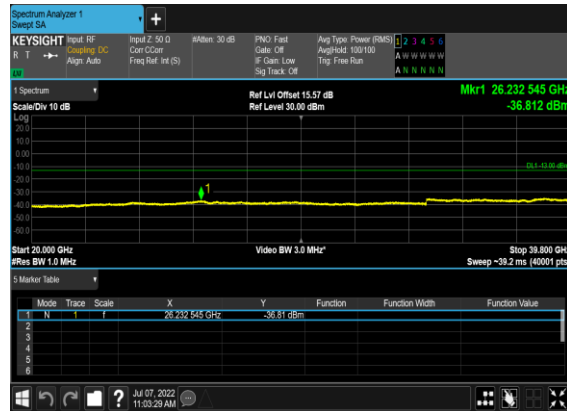

N77(10M)_DFT-s-OFDM_QPSK_Edge_1RB_Left_Low_CH



N77(10M)_DFT-s-OFDM_QPSK_Edge_1RB_Left_Low_CH



N77(10M)_DFT-s-OFDM_BPSK_Edge_1RB_Left_Mid_CH

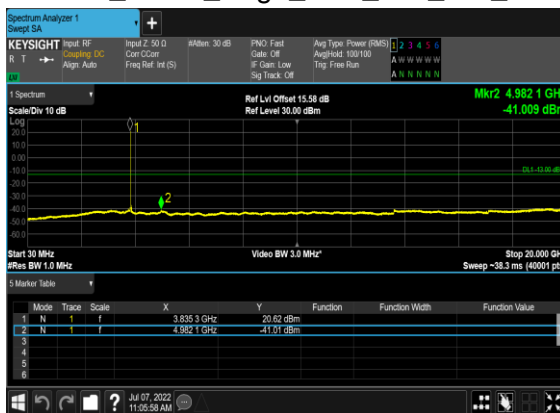

N77(10M)_DFT-s-OFDM_BPSK_Edge_1RB_Left_Mid_CH

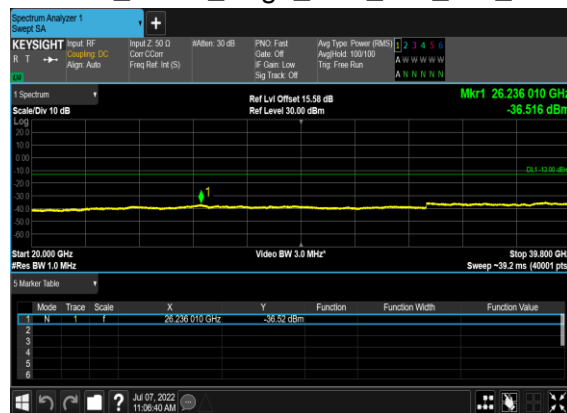

N77(10M)_DFT-s-OFDM_QPSK_Edge_1RB_Left_Mid_CH

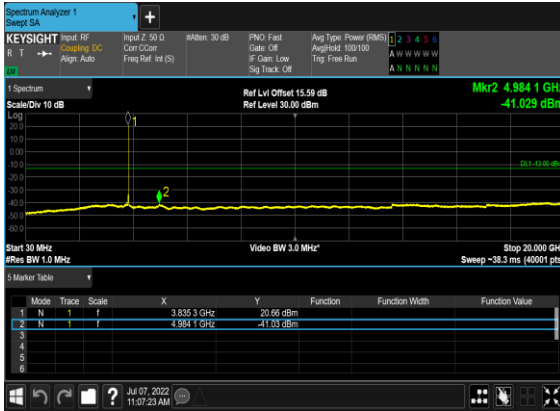

N77(10M)_DFT-s-OFDM_QPSK_Edge_1RB_Left_Mid_CH

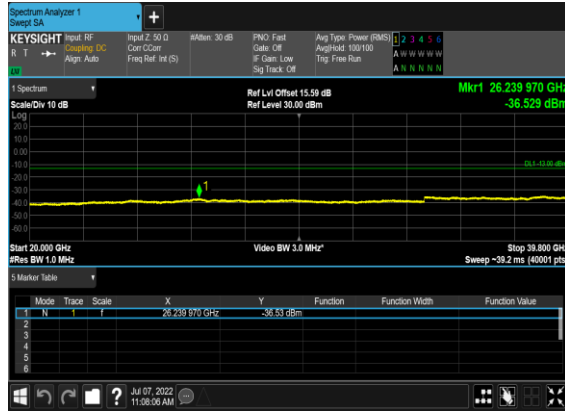

N77(10M)_DFT-s-OFDM_BPSK_Edge_1RB_Left_High_CH

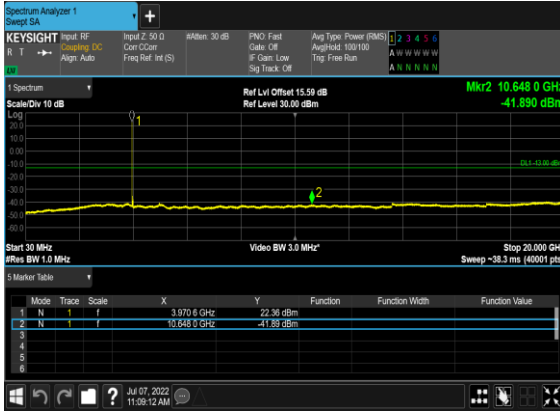

N77(10M)_DFT-s-OFDM_BPSK_Edge_1RB_Left_High_CH

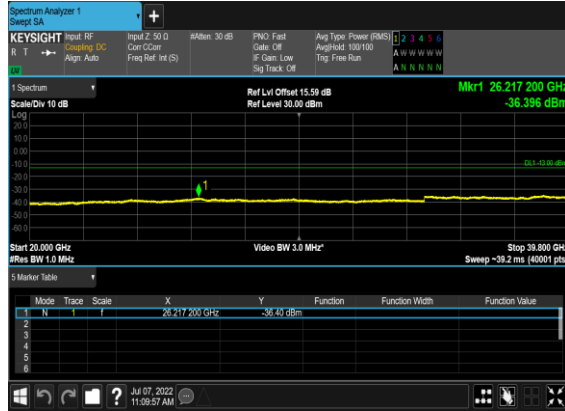

N77(10M)_DFT-s-OFDM_QPSK_Edge_1RB_Left_High_CH

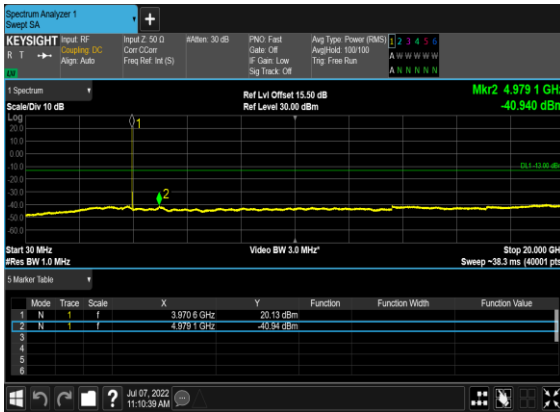

N77(10M)_DFT-s-OFDM_QPSK_Edge_1RB_Left_High_CH

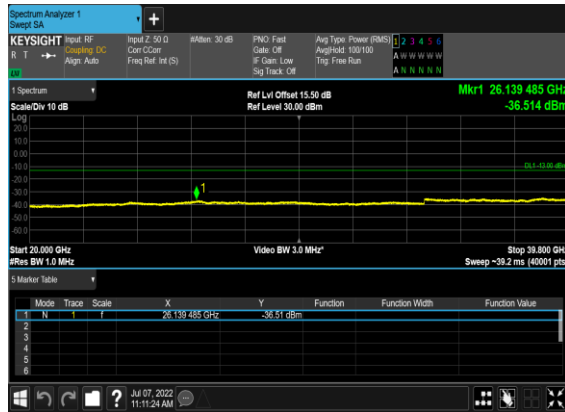

N77(20M)_DFT-s-OFDM_BPSK_Edge_1RB_Left_Low_CH



N77(20M)_DFT-s-OFDM_BPSK_Edge_1RB_Left_Low_CH

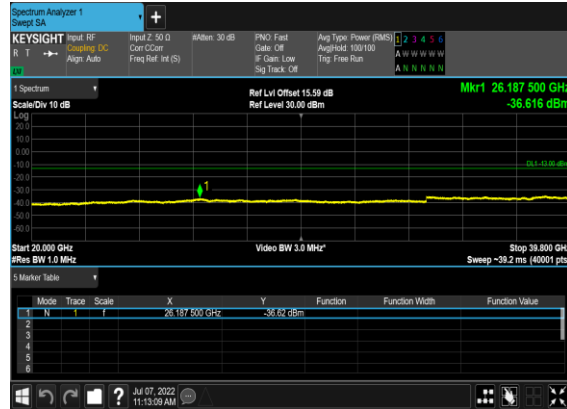

N77(20M)_DFT-s-OFDM_QPSK_Edge_1RB_Left_Low_CH



N77(20M)_DFT-s-OFDM_QPSK_Edge_1RB_Left_Low_CH

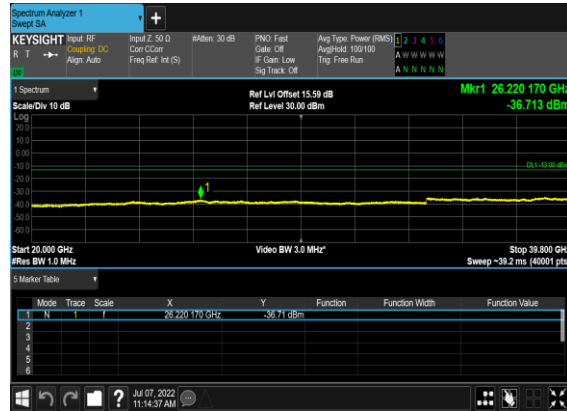

N77(20M)_DFT-s-OFDM_BPSK_Edge_1RB_Left_Mid_CH

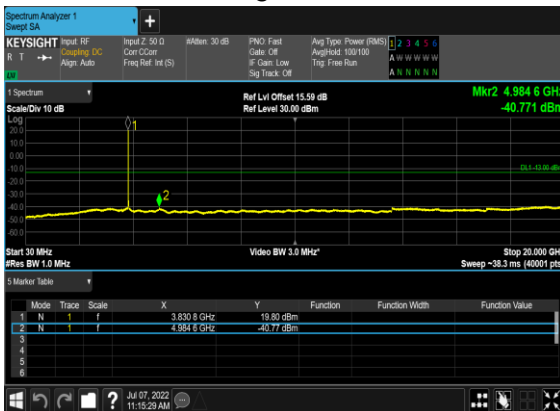

N77(20M)_DFT-s-OFDM_BPSK_Edge_1RB_Left_Mid_CH

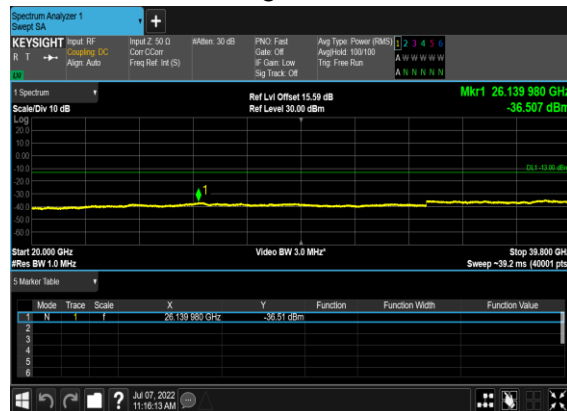

N77(20M)_DFT-s-OFDM_QPSK_Edge_1RB_Left_Mid_CH

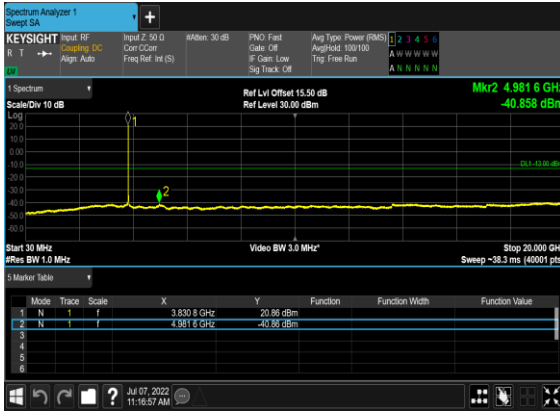

N77(20M)_DFT-s-OFDM_QPSK_Edge_1RB_Left_Mid_CH

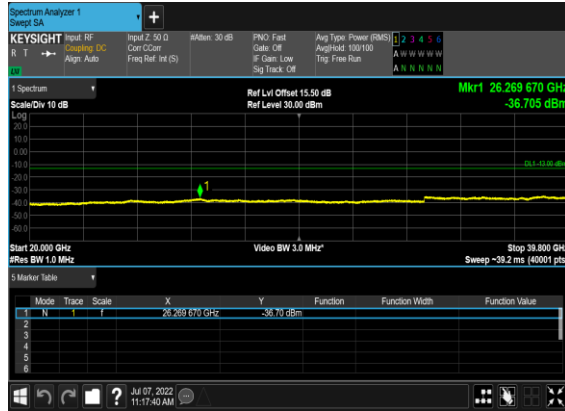

N77(20M)_DFT-s-OFDM_BPSK_Edge_1RB_Left_High_CH



N77(20M)_DFT-s-OFDM_BPSK_Edge_1RB_Left_High_CH

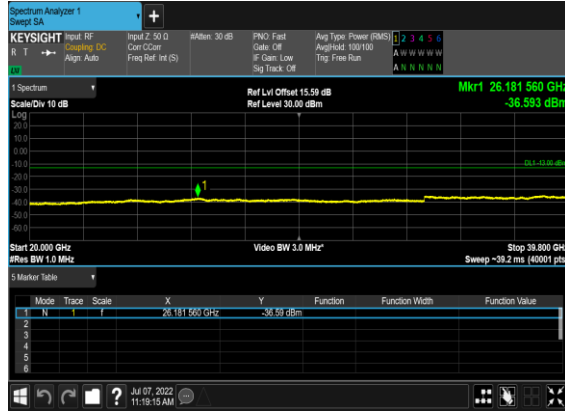

N77(20M)_DFT-s-OFDM_QPSK_Edge_1RB_Left_High_CH



N77(20M)_DFT-s-OFDM_QPSK_Edge_1RB_Left_High_CH

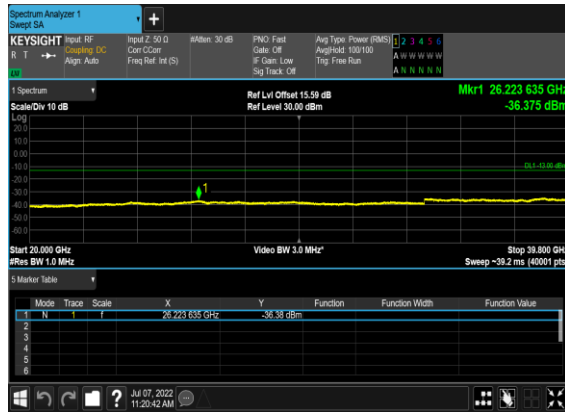

N77(50M)_DFT-s-OFDM_BPSK_Edge_1RB_Left_Low_CH



N77(50M)_DFT-s-OFDM_BPSK_Edge_1RB_Left_Low_CH

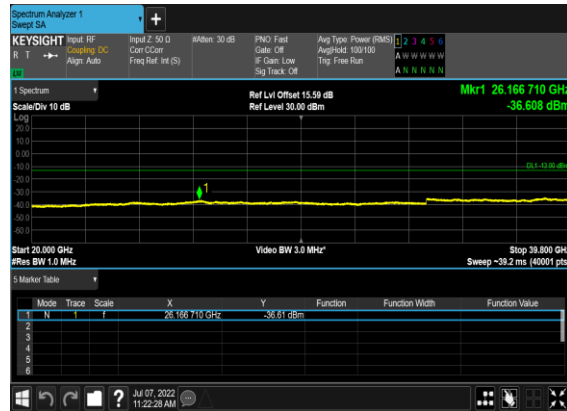

N77(50M)_DFT-s-OFDM_QPSK_Edge_1RB_Left_Low_CH

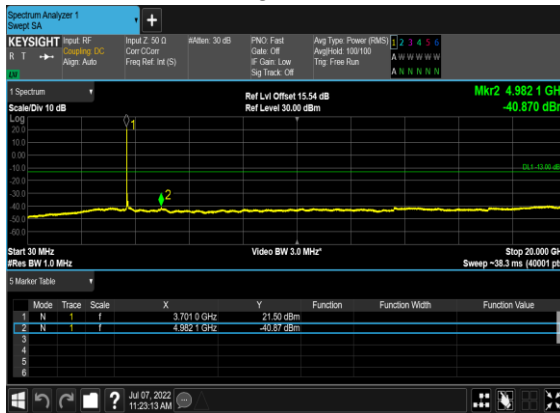

N77(50M)_DFT-s-OFDM_QPSK_Edge_1RB_Left_Low_CH

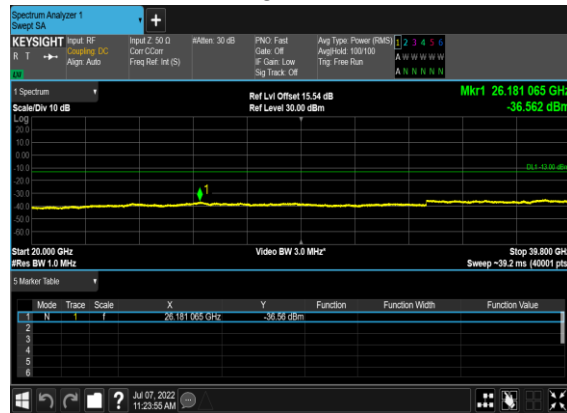

N77(50M)_DFT-s-OFDM_BPSK_Edge_1RB_Left_Mid_CH

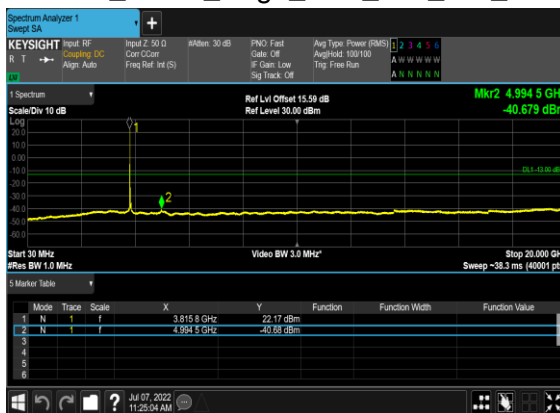

N77(50M)_DFT-s-OFDM_BPSK_Edge_1RB_Left_Mid_CH

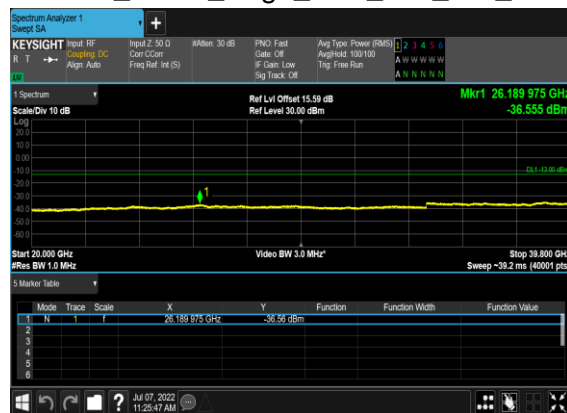

N77(50M)_DFT-s-OFDM_QPSK_Edge_1RB_Left_Mid_CH

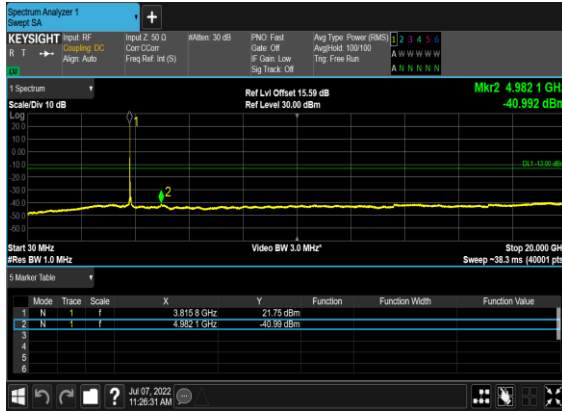

N77(50M)_DFT-s-OFDM_QPSK_Edge_1RB_Left_Mid_CH

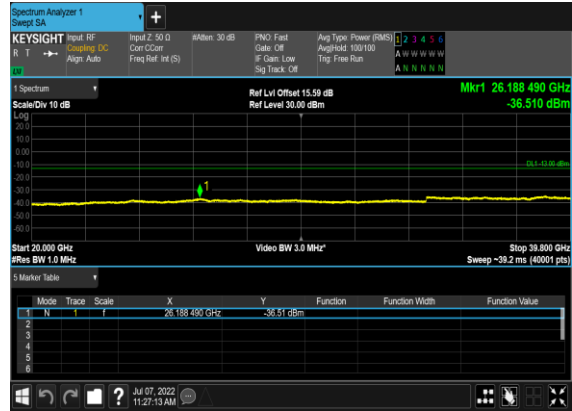

N77(50M)_DFT-s-OFDM_BPSK_Edge_1RB_Left_High_CH

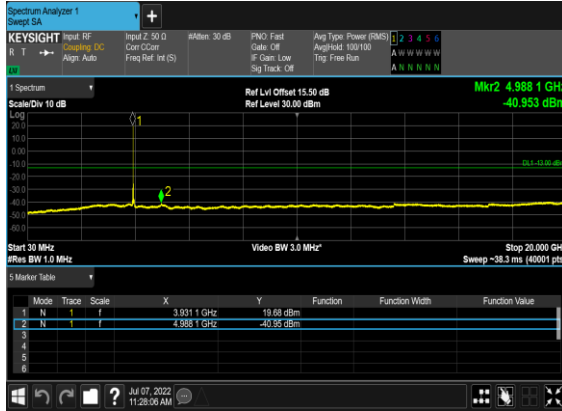

N77(50M)_DFT-s-OFDM_BPSK_Edge_1RB_Left_High_CH

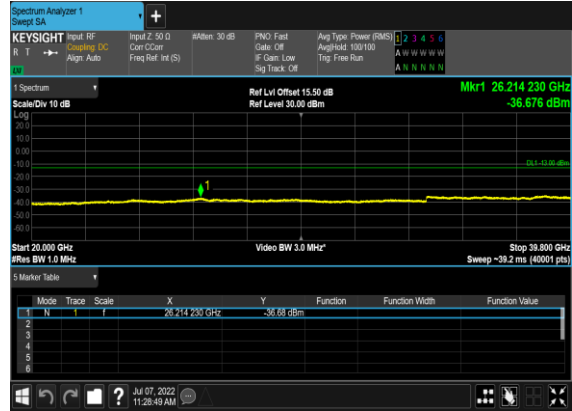

N77(50M)_DFT-s-OFDM_QPSK_Edge_1RB_Left_High_CH

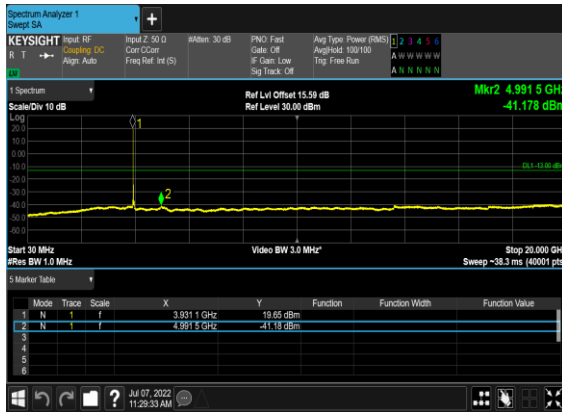

N77(50M)_DFT-s-OFDM_QPSK_Edge_1RB_Left_High_CH

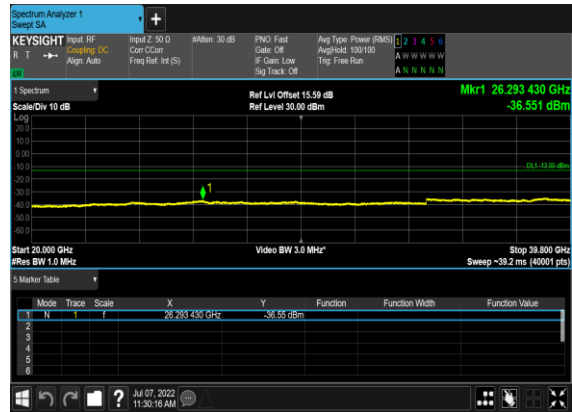

Conducted Band Edge

NR Band	SCS (kHz)	Bandwidth (MHz)	Arfcn	Freq (MHz)	Modulation	RB	Result	Verdict
77	15	10	647000	3705.0	DFT-s-OFDM BPSK	1@0	see graph	PASS
77	15	10	647000	3705.0	DFT-s-OFDM QPSK	1@0	see graph	PASS
77	15	10	647000	3705.0	DFT-s-OFDM BPSK	50@0	see graph	PASS
77	15	10	647000	3705.0	DFT-s-OFDM QPSK	50@0	see graph	PASS
77	15	10	665000	3975.0	DFT-s-OFDM BPSK	1@51	see graph	PASS
77	15	10	665000	3975.0	DFT-s-OFDM QPSK	1@51	see graph	PASS
77	15	10	665000	3975.0	DFT-s-OFDM BPSK	50@0	see graph	PASS
77	15	10	665000	3975.0	DFT-s-OFDM QPSK	50@0	see graph	PASS
77	15	20	647334	3710.01	DFT-s-OFDM BPSK	1@0	see graph	PASS
77	15	20	647334	3710.01	DFT-s-OFDM QPSK	1@0	see graph	PASS
77	15	20	647334	3710.01	DFT-s-OFDM BPSK	100@0	see graph	PASS
77	15	20	647334	3710.01	DFT-s-OFDM QPSK	100@0	see graph	PASS
77	15	20	664666	3969.99	DFT-s-OFDM BPSK	1@105	see graph	PASS
77	15	20	664666	3969.99	DFT-s-OFDM QPSK	1@105	see graph	PASS
77	15	20	664666	3969.99	DFT-s-OFDM BPSK	100@0	see graph	PASS
77	15	20	664666	3969.99	DFT-s-OFDM QPSK	100@0	see graph	PASS
77	15	50	648334	3725.01	DFT-s-OFDM BPSK	1@0	see graph	PASS
77	15	50	648334	3725.01	DFT-s-OFDM QPSK	1@0	see graph	PASS
77	15	50	648334	3725.01	DFT-s-OFDM BPSK	270@0	see graph	PASS
77	15	50	648334	3725.01	DFT-s-OFDM QPSK	270@0	see graph	PASS
77	15	50	663666	3954.99	DFT-s-OFDM BPSK	1@269	see graph	PASS
77	15	50	663666	3954.99	DFT-s-OFDM QPSK	1@269	see graph	PASS
77	15	50	663666	3954.99	DFT-s-OFDM BPSK	270@0	see graph	PASS
77	15	50	663666	3954.99	DFT-s-OFDM QPSK	270@0	see graph	PASS

N77(10M)_DFT-s-OFDM_BPSK_Edge_1RB_Left_Low_CH

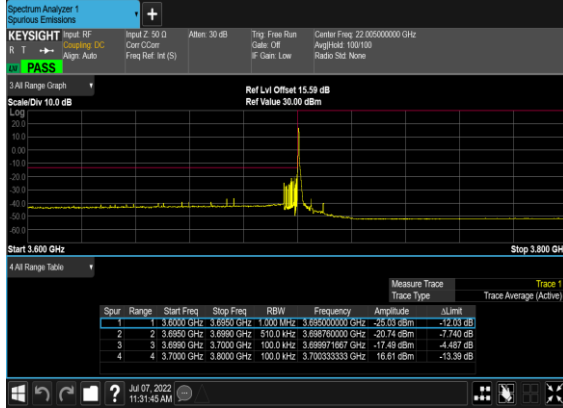

N77(10M)_DFT-s-OFDM_QPSK_Edge_1RB_Left_Low_CH

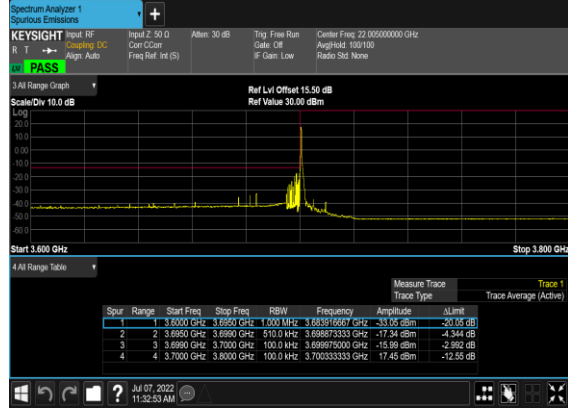

N77(10M)_DFT-s-OFDM_BPSK_Outer_Full_Low_CH

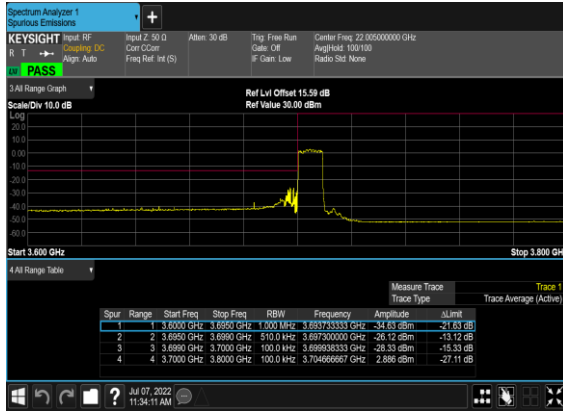

N77(10M)_DFT-s-OFDM_QPSK_Outer_Full_Low_CH

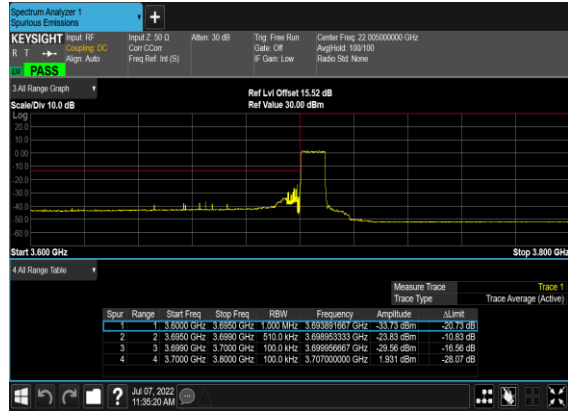

N77(10M)_DFT-s-OFDM_BPSK_Edge_1RB_Right_High_CH

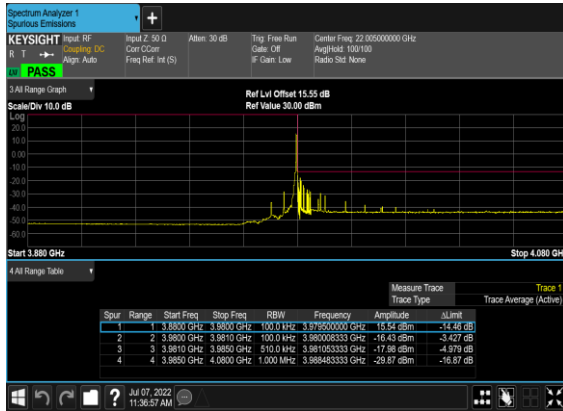

N77(10M)_DFT-s-OFDM_QPSK_Edge_1RB_Right_High_CH

