



FCC RF Test Report

APPLICANT : vivo Mobile Communication Co., Ltd.
EQUIPMENT : Mobile Phone
BRAND NAME : vivo
MODEL NAME : V2145
FCC ID : 2AUCY-V2145
STANDARD : 47 CFR Part 2, Part 27 Subpart Q
CLASSIFICATION : PCS Licensed Transmitter Held to Ear (PCE)
TEST DATE(S) : Mar. 27, 2022 ~ Apr. 02, 2022

We, Sporton International Inc. (ShenZhen), would like to declare that the tested sample has been evaluated in accordance with the procedures given in ANSI C63.26-2015 and shown compliance with the applicable technical standards.

The test results in this report apply exclusively to the tested model / sample. Without written approval of Sporton International Inc. (ShenZhen), the test report shall not be reproduced except in full.

Jason Jia



Approved by: Jason Jia

Sporton International Inc. (ShenZhen)

1/F, 2/F, Bldg 5, Shiling Industrial Zone, Xinwei Village, Xili, Nanshan, Shenzhen, 518055

People's Republic of China



TABLE OF CONTENTS

REVISION HISTORY..... 3
SUMMARY OF TEST RESULT 4
1 GENERAL DESCRIPTION 5
1.1 Applicant 5
1.2 Manufacturer 5
1.3 Product Feature of Equipment Under Test 5
1.4 Product Specification of Equipment Under Test 5
1.5 Modification of EUT 5
1.6 Maximum EIRP and Emission Designator 6
1.7 Testing Site 6
1.8 Test Software 6
1.9 Applied Standards 7
2 TEST CONFIGURATION OF EQUIPMENT UNDER TEST 8
2.1 Test Mode 8
2.2 Connection Diagram of Test System 9
2.3 Support Unit used in test configuration and system 9
2.4 Measurement Results Explanation Example 9
2.5 Frequency List of Low/Middle/High Channels 10
3 CONDUCTED TEST ITEMS 11
3.1 Measuring Instruments 11
3.2 Test Setup 11
3.3 Test Result of Conducted Test 11
3.4 Conducted Output Power Measurement 12
3.5 Peak-to-Average Ratio 13
3.6 EIRP 14
3.7 Occupied Bandwidth 15
3.8 Conducted Band Edge Measurement 16
3.9 Conducted Spurious Emission Measurement 17
3.10 Frequency Stability Measurement 18
4 RADIATED TEST ITEMS 19
4.1 Measuring Instruments 19
4.2 Test Setup 19
4.3 Test Result of Radiated Test 20
4.4 Radiated Spurious Emission Measurement 21
5 LIST OF MEASURING EQUIPMENT 22
6 UNCERTAINTY OF EVALUATION 23
APPENDIX A. TEST RESULTS OF CONDUCTED TEST
APPENDIX B. TEST RESULTS OF RADIATED TEST
APPENDIX C. TEST SETUP PHOTOGRAPHS

SUMMARY OF TEST RESULT

Report Section	FCC Rule	Description	Limit	Result	Remark
3.4	§2.1046	Conducted Output Power	—	Report Only	-
3.5	§27.50 (k)(4)	Peak-to-Average Ratio	<13dB	PASS	
3.6	§27.50 (k)(3)	EIRP	EIRP < 1W (30dBm)	PASS	-
3.7	§2.1049	Occupied Bandwidth	—	Report Only	-
3.8	§2.1051 §27.53 (n)(2)	Conducted Band Edge Measurement	-13dBm/MHz	PASS	-
3.9	§2.1051 §27.53 (n)(2)	Conducted Spurious Emission	-13dBm/MHz	PASS	-
3.10	§2.1055 §27.54	Frequency Stability Temperature & Voltage	Within the band	PASS	-
4.4	§2.1053 §27.53 (n)(2)	Radiated Spurious Emission	-13dBm/MHz	PASS	Under limit 13.80 dB at 10479.75 MHz

Declaration of Conformity:
The test results with all measurement uncertainty excluded are presented in accordance with the regulation limits or requirements declared by manufacturers.
Comments and Explanations:
The declared of product specification for EUT presented in the report are provided by the manufacturer, and the manufacturer takes all the responsibilities for the accuracy of product specification.

1 General Description

1.1 Applicant

vivo Mobile Communication Co., Ltd.
 No.1, vivo Road, Chang'an, Dongguan, Guangdong, China

1.2 Manufacturer

vivo Mobile Communication Co., Ltd.
 No.1, vivo Road, Chang'an, Dongguan, Guangdong, China

1.3 Product Feature of Equipment Under Test

Product Feature	
Equipment	Mobile Phone
Brand Name	vivo
Model Name	V2145
FCC ID	2AUCY-V2145
IMEI Code	Conducted: 868488069971263 Radiation: 868488069970513/868488069970505
HW Version	MP_0.1
SW Version	PD2185BF_EX_A_12.0.9.2.W30.V000L1
EUT Stage	Production Unit

1.4 Product Specification of Equipment Under Test

Product Feature	
Tx/Rx Frequency	LTE Band 42: 3450 MHz ~ 3550 MHz
Bandwidth	5MHz / 10MHz / 15MHz / 20MHz
Maximum Output Power to Antenna	LTE Band 42 : <Ant. 12>: 24.30 dBm <Ant. 24>: 23.99 dBm
Antenna Gain	LTE Band 42 : <Ant. 12>: -6.0 dBi <Ant. 24>: 0 dBi
Type of Modulation	QPSK / 16QAM / 64QAM / 256QAM(Downlink only)

Note: The maximum EIRP is calculated from max output power and antenna gain, only the maximum EIRP of Ant.24 is shown in the report.

1.5 Modification of EUT

No modifications are made to the EUT during all test items.

1.6 Maximum EIRP and Emission Designator

LTE Band 42		QPSK		16QAM/64QAM	
BW (MHz)	Frequency Range (MHz)	Maximum EIRP(W)	Emission Designator (99%OBW)	Maximum EIRP(W)	Emission Designator (99%OBW)
5	3452.5 ~ 3547.5	0.2500	4M50G7D	0.2032	4M54W7D
10	3455 ~ 3545	0.2489	9M09G7D	0.2104	9M17W7D
15	3457.5 ~ 3542.5	0.2377	13M5G7D	0.1884	13M5W7D
20	3460 ~ 3540	0.2506	17M9G7D	0.1884	18M0W7D

1.7 Testing Site

Sporton International Inc. (Shenzhen) is accredited to ISO/IEC 17025:2017 by American Association for Laboratory Accreditation with Certificate Number 5145.01.

Test Firm	Sporton International Inc. (Shenzhen)		
Test Site Location	1/F, 2/F, Bldg 5, Shiling Industrial Zone, Xinwei Village, Xili, Nanshan, Shenzhen, 518055 People's Republic of China TEL: +86-755-86379589 FAX: +86-755-86379595		
Test Site No.	Sporton Site No.	FCC Designation No.	FCC Test Firm Registration No.
	TH01-SZ	CN1256	421272

Test Firm	Sporton International Inc. (Shenzhen)		
Test Site Location	101, 1st Floor, Block B, Building 1, No. 2, Tengfeng 4th Road, Fenghuang Community, Fuyong Street, Baoan District, Shenzhen City Guangdong Province China 518103 TEL: +86-755-33202398		
Test Site No.	Sporton Site No.	FCC Designation No.	FCC Test Firm Registration No.
	03CH01-SZ	CN1256	421272

1.8 Test Software

Item	Site	Manufacturer	Name	Version
1.	03CH01-SZ	AUDIX	E3	6.2009-8-24



1.9 Applied Standards

According to the specifications of the manufacturer, the EUT must comply with the requirements of the following standards:

- ♦ 47 CFR Part 2, Part 27 Subpart Q
- ♦ ANSI C63.26-2015
- ♦ FCC KDB 971168 Power Meas License Digital Systems D01 v03r01
- ♦ FCC KDB 412172 D01 Determining ERP and EIRP v01r01
- ♦

Remark:

1. All test items were verified and recorded according to the standards and without any deviation during the test.
2. This EUT has also been tested and complied with the requirements of FCC Part 15, Subpart B, recorded in a separate test report.

2 Test Configuration of Equipment Under Test

2.1 Test Mode

Antenna port conducted and radiated test items listed below are performed according to KDB 971168 D01 Power Meas. License Digital Systems v03r01 with maximum output power.

Radiated measurements are performed by rotating the EUT in three different orthogonal test planes to find the maximum emission(Y plane).

Test Cases	Band	Bandwidth (MHz)	Modulation	RB #	Test Channel
		eg. 5M, 10M, 15M, 20M	eg. QPSK, 16QAM, 64QAM	1RB, Partial RB, Full RB	L/M/H
Max. Output Power	LTE Band 42	5M, 10M, 15M, 20M	QPSK, 16QAM, 64QAM	1RB, Partial RB, Full RB	L, M, H
Peak-to-Average Ratio	LTE Band 42	20M	QPSK, 16QAM, 64QAM	Full RB	M
E.I.R.P	LTE Band 42	5M, 10M, 15M, 20M	QPSK, 16QAM, 64QAM	1RB, Partial RB, Full RB	L, M, H
26dB and 99% Bandwidth	LTE Band 42	20M	QPSK, 16QAM	Full RB	M
Conducted Band Edge	LTE Band 42	5M, 10M, 15M, 20M	QPSK, 16QAM, 64QAM	1RB, Full RB	L, H
Conducted Spurious Emission	LTE Band 42	5M, 10M, 15M, 20M	QPSK	1RB	L, M, H
Frequency Stability	LTE Band 42	20M	QPSK	1RB	L, H
Radiated Spurious Emission	LTE Band 42	Worst case from maximum power			M

Note:

The device is investigated from 30MHz to 10 times of fundamental signal for radiated spurious emission test under different RB size/offset and modulations in exploratory test. Subsequently, only the worst case emissions are reported.

2.2 Connection Diagram of Test System

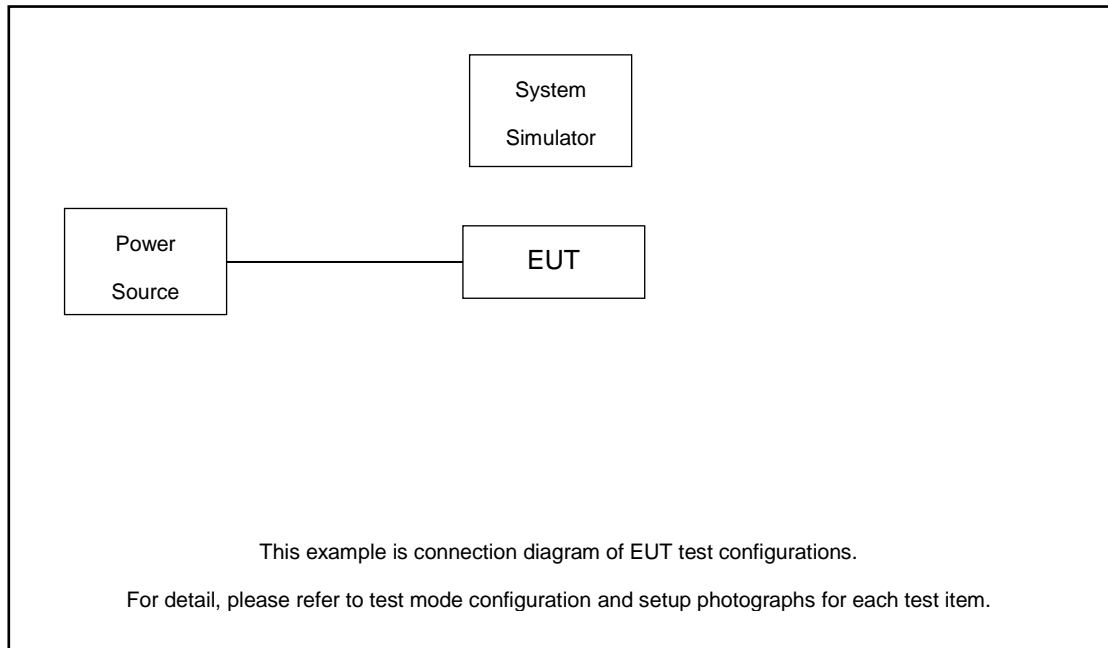

2.3 Support Unit used in test configuration and system

Item	Equipment	Trade Name	Model No.	FCC ID	Data Cable	Power Cord
1.	LTE Base Station	Anritsu	MT8820C	N/A	N/A	Unshielded, 1.8 m

2.4 Measurement Results Explanation Example

For all conducted test items:

The offset level is set in the spectrum analyzer to compensate the RF cable loss and attenuator factor between EUT conducted output port and spectrum analyzer. With the offset compensation, the spectrum analyzer reading level is exactly the EUT RF output level.

The spectrum analyzer offset is derived from RF cable loss and attenuator factor.

Offset = RF cable loss + attenuator factor.

Following shows an offset computation example with cable loss 5.0 dB and 10dB attenuator.

Example :

$$\begin{aligned} \text{Offset(dB)} &= \text{RF cable loss(dB)} + \text{attenuator factor(dB)}. \\ &= 5.0 + 10 = 15.0 \text{ (dB)} \end{aligned}$$



2.5 Frequency List of Low/Middle/High Channels

LTE Band 42 Channel and Frequency List				
BW [MHz]	Channel/Frequency(MHz)	Lowest	Middle	Highest
20	Channel	42190	42590	42990
	Frequency	3460	3500	3540
15	Channel	42165	42590	43015
	Frequency	3457.5	3500	3542.5
10	Channel	42140	42590	43040
	Frequency	3455	3500	3545
5	Channel	42115	42590	43065
	Frequency	3452.5	3500	3547.5

3 Conducted Test Items

3.1 Measuring Instruments

See list of measuring instruments of this test report.

3.2 Test Setup

3.2.1 Conducted Output Power

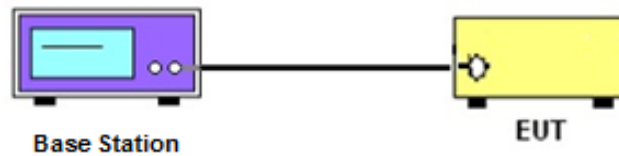

3.2.2 Peak-to-Average Ratio, Occupied / 26dB Bandwidth, Band-Edge and Conducted Spurious Emission

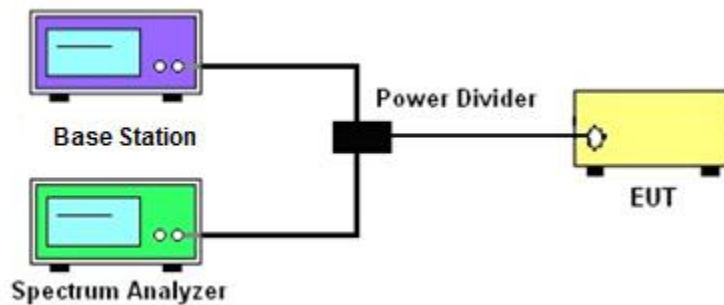

3.2.3 Frequency Stability

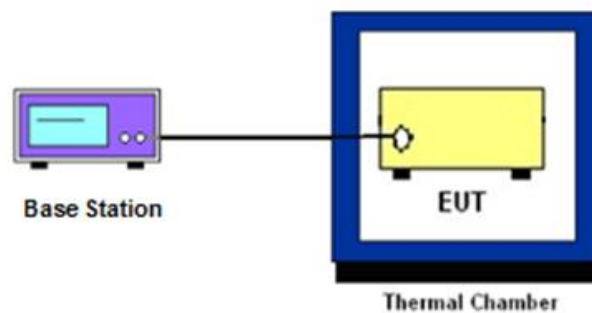

3.3 Test Result of Conducted Test

Please refer to Appendix A.



3.4 Conducted Output Power Measurement

3.4.1 Description of the Conducted Output Power Measurement

A base station simulator was used to establish communication with the EUT. Its parameters were set to transmit the maximum power on the EUT. The measured power in the radio frequency on the transmitter output terminals shall be reported.

3.4.2 Test Procedures

1. The testing follows ANSI C63.26 Section 5.2
2. The transmitter output port was connected to the system simulator.
3. Set EUT at maximum power through the system simulator.
4. Select lowest, middle, and highest channels for each band and different modulation.
5. Measure and record the power level from the system simulator.

3.5 Peak-to-Average Ratio

3.5.1 Description of the PAR Measurement

Power Complementary Cumulative Distribution Function (CCDF) curves provide a means for characterizing the power peaks of a digitally modulated signal on a statistical basis. A CCDF curve depicts the probability of the peak signal amplitude exceeding the average power level. Most contemporary measurement instrumentation include the capability to produce CCDF curves for an input signal provided that the instrument's resolution bandwidth can be set wide enough to accommodate the entire input signal bandwidth. In measuring transmissions in this band using an average power technique, the peak-to-average ratio (PAR) of the transmission may not exceed 13 dB.

3.5.2 Test Procedures

1. The testing follows ANSI C63.26 Section 5.2.3.4 (CCDF).
2. The EUT was connected to spectrum and system simulator via a power divider.
3. Set the CCDF (Complementary Cumulative Distribution Function) option in spectrum analyzer.
4. The highest RF powers were measured and recorded the maximum PAPR level associated with a probability of 0.1 %.
5. Record the deviation as Peak to Average Ratio.

3.6 EIRP

3.6.1 Description of EIRP Limit

§ 27.50 (k)(3)

Mobile devices are limited to 1Watt (30 dBm) EIRP. Mobile devices operating in these bands must employ a means for limiting power to the minimum necessary for successful communications

3.6.2 Test Procedures

1. According to KDB 412172 D01 Power Approach,
2. $EIRP = P_T + G_T - L_C$, $ERP = EIRP - 2.15$, where
 P_T = transmitter output power in dBm
 G_T = gain of the transmitting antenna in dBi
 L_C = signal attenuation in the connecting cable between the transmitter and antenna in dB

3.7 Occupied Bandwidth

3.7.1 Description of Occupied Bandwidth Measurement

The occupied bandwidth is the width of a frequency band such that, below the lower and above the upper frequency limits, the mean powers emitted are each equal to a specified percentage 0.5% of the total mean transmitted power.

The 26 dB emission bandwidth is defined as the frequency range between two points, one above and one below the carrier frequency, at which the spectral density of the emission is attenuated 26 dB below the maximum in-band spectral density of the modulated signal. Spectral density (power per unit bandwidth) is to be measured with a detector of resolution bandwidth equal to approximately 1.0% of the emission bandwidth.

3.7.2 Test Procedures

1. The testing follows ANSI C63.26 Section 5.4
2. The EUT was connected to spectrum analyzer and system simulator via a power divider.
3. The spectrum analyzer center frequency is set to the nominal EUT channel center frequency. The span range for the spectrum analyzer shall be between two and five times the anticipated OBW.
4. The nominal resolution bandwidth (RBW) shall be in the range of 1 to 5 % of the anticipated OBW, and the VBW shall be at least 3 times the RBW.
5. Set the detection mode to peak, and the trace mode to max hold.
6. Determine the reference value: Set the EUT to transmit a modulated signal. Allow the trace to stabilize. Set the spectrum analyzer marker to the highest level of the displayed trace.
(this is the reference value)
7. Determine the “-26 dB down amplitude” as equal to (Reference Value – X).
8. Place two markers, one at the lowest and the other at the highest frequency of the envelope of the spectral display such that each marker is at or slightly below the “-X dB down amplitude” determined in step 6. If a marker is below this “-X dB down amplitude” value it shall be placed as close as possible to this value. The OBW is the positive frequency difference between the two markers.
9. Use the 99 % power bandwidth function of the spectrum analyzer and report the measured bandwidth.

3.8 Conducted Band Edge Measurement

3.8.1 Description of Conducted Band Edge Measurement

§ 27.53 (n)(2)

For mobile operations in the 3450-3550 MHz band, the conducted power of any emission outside the licensee's authorized bandwidth shall not exceed -13 dBm/MHz.

Compliance with this paragraph is based on the use of measurement instrumentation employing a resolution bandwidth of 1 megahertz or greater. However, in the 1 megahertz bands immediately outside and adjacent to the licensee's frequency block, a resolution bandwidth of at least one percent of the emission bandwidth of the fundamental emission of the transmitter may be employed, but limited to a maximum of 200 kHz. In the bands between 1 and 5 MHz removed from the licensee's frequency block, the minimum resolution bandwidth for the measurement shall be 500 kHz.

3.8.2 Test Procedures

1. The testing follows ANSI C63.26 section 5.7
2. The EUT was connected to spectrum analyzer and system simulator via a power divider.
3. The band edges of low and high channels for the highest RF powers were measured.
4. Set RBW \geq 1% EBW but limited to a maximum of 200 kHz in the 1MHz band immediately outside and adjacent to the band edge.
5. Beyond the 1 MHz and 5 MHz removed from the band edge, set RBW \geq 500KHz.
6. Beyond the 5 MHz removed from the band edge, set RBW = 1MHz.
7. Set spectrum analyzer with RMS detector.
8. The RF fundamental frequency should be excluded against the limit line in the operating frequency band.
9. Checked that all the results comply with the emission limit line.

3.9 Conducted Spurious Emission Measurement

3.9.1 Description of Conducted Spurious Emission Measurement

The power of any emission outside of the authorized operating frequency ranges shall not exceed -13 dBm/MHz.

It is measured by means of a calibrated spectrum analyzer and scanned from 9 kHz up to a frequency including its 10th harmonic.

3.9.2 Test Procedures

1. The testing follows ANSI C63.26 section 5.7
2. The EUT was connected to spectrum analyzer and system simulator via a power divider.
3. The RF output of EUT was connected to the spectrum analyzer by RF cable and attenuator. The path loss was compensated to the results for each measurement.
4. The middle channel for the highest RF power within the transmitting frequency was measured.
5. The conducted spurious emission for the whole frequency range was taken.
6. Make the measurement with the spectrum analyzer's RBW = 1MHz, VBW = 3MHz.
7. Set spectrum analyzer with RMS detector.
8. Taking the record of maximum spurious emission.
9. The RF fundamental frequency should be excluded against the limit line in the operating frequency band.
10. Checked that all the results comply with the emission limit line.

3.10 Frequency Stability Measurement

3.10.1 Description of Frequency Stability Measurement

The frequency stability shall be measured by variation of ambient temperature and variation of primary supply voltage to ensure that the fundamental emission stays within the authorized frequency block.

3.10.2 Test Procedures for Temperature Variation

1. The testing follows ANSI C63.26 section 5.6.4
2. The EUT was set up in the thermal chamber and connected with the system simulator.
3. With power OFF, the temperature was decreased to -30°C and the EUT was stabilized before testing. Power was applied and the maximum change in frequency was recorded within one minute.
4. With power OFF, the temperature was raised in 10°C step up to 50°C . The EUT was stabilized at each step for at least half an hour. Power was applied and the maximum frequency change was recorded within one minute.

3.10.3 Test Procedures for Voltage Variation

1. The testing follows ANSI C63.26 section 5.6.5.
2. The EUT was placed in a temperature chamber at $20\pm 5^{\circ}\text{C}$ and connected with the system simulator.
3. The power supply voltage to the EUT was varied from 85% to 115% of the nominal value for other than hand carried battery equipment.
4. For hand carried, battery powered equipment, reduce the primary ac or dc supply voltage to the battery operating end point, which shall be specified by the manufacturer.
5. The variation in frequency was measured for the worst case.

4 Radiated Test Items

4.1 Measuring Instruments

See list of measuring instruments of this test report.

4.2 Test Setup

4.2.1 For radiated test below 30MHz



4.2.2 For radiated test from 30MHz to 1GHz

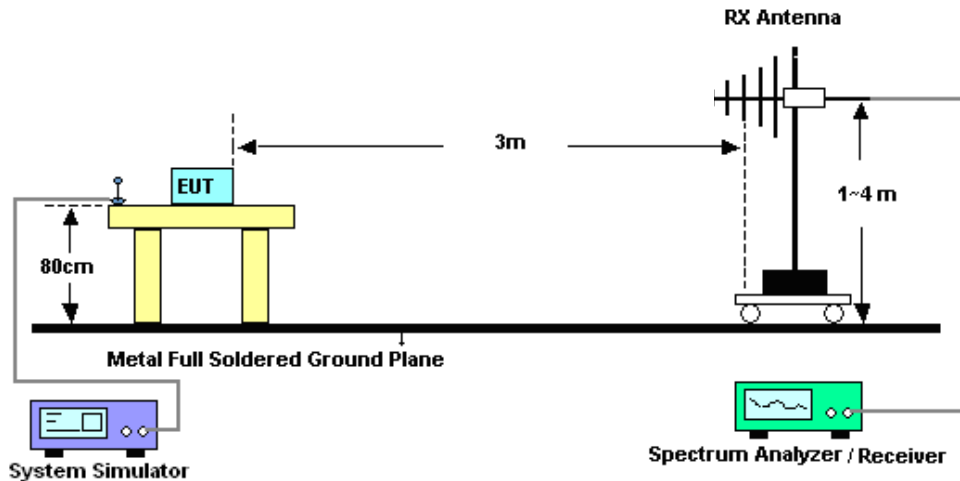

4.2.3 For radiated test above 1GHz



4.3 Test Result of Radiated Test

The low frequency, which started from 9 kHz to 30MHz, was pre-scanned and the result which was 20dB lower than the limit line was not reported.

Please refer to Appendix B.

4.4 Radiated Spurious Emission Measurement

4.4.1 Description of Radiated Spurious Emission

The radiated spurious emission was measured by substitution method according to ANSI/TIA-603-E. The power of any emission outside of the authorized operating frequency ranges shall not exceed -13 dBm/MHz.

The spectrum is scanned from 30 MHz up to a frequency including its 10th harmonic.

4.4.2 Test Procedures

1. The testing follows ANSI C63.26 Section 5.5
2. The EUT was placed on a turntable with 0.8 meter height for frequency below 1GHz and 1.5 meter height for frequency above 1GHz respectively above ground.
3. The EUT was set 3 meters from the receiving antenna mounted on the antenna tower.
4. The table was rotated 360 degrees to determine the position of the highest spurious emission.
5. The height of the receiving antenna is varied between 1m to 4m to search the maximum spurious emission for both horizontal and vertical polarizations.
6. During the measurement, the system simulator parameters were set to force the EUT transmitting at maximum output power.
7. Make the measurement with the spectrum analyzer's RBW = 1MHz, VBW = 3MHz, taking the record of maximum spurious emission.
8. A horn antenna was substituted in place of the EUT and was driven by a signal generator.
9. Tune the output power of signal generator to the same emission level with EUT maximum spurious emission.
$$\text{EIRP (dBm)} = \text{S.G. Power} - \text{Tx Cable Loss} + \text{Tx Antenna Gain}$$
$$\text{ERP (dBm)} = \text{EIRP} - 2.15$$
10. The RF fundamental frequency should be excluded against the limit line in the operating frequency band.



5 List of Measuring Equipment

Instrument	Manufacturer	Model No.	Serial No.	Characteristics	Calibration Date	Test Date	Due Date	Remark
Spectrum Analyzer	R&S	FSV40	101078	10Hz~40GHz	Apr. 08, 2021	Mar. 27, 2022	Apr. 07, 2022	Conducted (TH01-SZ)
Power Divider	TOJOIN	PS-2SM-04 265	60.06.020.007 7	0.4GHz~26.5GHz	Dec. 25, 2021	Mar. 27, 2022	Dec. 24, 2022	Conducted (TH01-SZ)
Thermal Chamber	Ten Billion Hongzhangroup	LP-150U	H2014081803	-40~+150°C	Jul. 14, 2021	Mar. 27, 2022	Jul. 13, 2022	Conducted (TH01-SZ)
EMI Test Receiver&SA	Agilent	N9038A	MY52260185	20Hz~26.5GHz	Dec. 02, 2021	Apr. 02, 2022	Dec. 01, 2022	Radiation (03CH01-SZ)
Loop Antenna	R&S	HFH2-Z2	100354	9kHz~30MHz	Jun. 22, 2020	Apr. 02, 2022	Jun. 21, 2022	Radiation (03CH01-SZ)
HF Amplifier	KEYSIGHT	83017A	MY53270105	0.5GHz~26.5Ghz	Oct. 16, 2021	Apr. 02, 2022	Oct. 15, 2022	Radiation (03CH01-SZ)
Bilog Antenna	TeseQ	CBL6112D	35407	30MHz-2GHz	Jul. 15, 2021	Apr. 02, 2022	Jul. 14, 2022	Radiation (03CH01-SZ)
Double Ridge Horn Antenna	ETS-Lindgren	3117	00119436	1GHz~18GHz	Jul. 25, 2021	Apr. 02, 2022	Jul. 24, 2022	Radiation (03CH01-SZ)
SHF-EHF Horn	com-power	AH-840	101071	18Ghz-40GHz	Apr. 11, 2021	Apr. 02, 2022	Apr. 10, 2022	Radiation (03CH01-SZ)
LF Amplifier	Burgeon	BPA-530	102209	0.01~3000Mhz	Apr. 07, 2021	Apr. 02, 2022	Apr. 06, 2022	Radiation (03CH01-SZ)
HF Amplifier	MITEQ	AMF-7D-00 101800-30-1 0P-R	1943528	1GHz~18GHz	Oct. 15, 2021	Apr. 02, 2022	Oct. 14, 2022	Radiation (03CH01-SZ)
HF Amplifier	MITEQ	TTA1840-35 -HG	1871923	18GHz~40GHz	Jul. 21, 2021	Apr. 02, 2022	Jul. 20, 2022	Radiation (03CH01-SZ)
AC Power Source	Chroma	61601	616010001985	N/A	NCR	Apr. 02, 2022	NCR	Radiation (03CH01-SZ)
Turn Table	EM	EM1000	N/A	0~360 degree	NCR	Apr. 02, 2022	NCR	Radiation (03CH01-SZ)
Antenna Mast	EM	EM1000	N/A	1 m~4 m	NCR	Apr. 02, 2022	NCR	Radiation (03CH01-SZ)

NCR: No Calibration Required

6 Uncertainty of Evaluation

The measurement uncertainties shown below were calculated in accordance with the requirements of ANSI 63.26-2015. All the measurement uncertainty value were shown with a coverage $K=2$ to indicate 95% level of confidence. The measurement data show herein meets or exceeds the CISPR measurement uncertainty values specified in CISPR 16-4-2 and can be compared directly to specified limit to determine compliance.

Uncertainty of Radiated Emission Measurement (30 MHz ~ 1000 MHz)

Measuring Uncertainty for a Level of Confidence of 95% ($U = 2Uc(y)$)	2.48dB
-------------------------------------------------------------------------	--------

Uncertainty of Radiated Emission Measurement (1 GHz ~ 18 GHz)

Measuring Uncertainty for a Level of Confidence of 95% ($U = 2Uc(y)$)	3.53dB
-------------------------------------------------------------------------	--------

Uncertainty of Radiated Emission Measurement (18 GHz ~ 40 GHz)

Measuring Uncertainty for a Level of Confidence of 95% ($U = 2Uc(y)$)	4.02dB
-------------------------------------------------------------------------	--------

----- THE END -----



Appendix A. Test Results of Conducted Test

Test Engineer :	Chen Hong	Temperature :	22~23°C
		Relative Humidity :	40~42%

Conducted Output Power(Average power)

LTE Band 42:

BW [MHz]	Modulation	RB Size	RB Offset	Power Low Ch. / Freq.	Power Middle Ch. / Freq.	Power High Ch. / Freq.
Channel				42190	42590	42990
Frequency (MHz)				3460	3500	3540
20	QPSK	1	0	23.73	23.99	23.85
20	QPSK	1	49	23.60	23.72	23.70
20	QPSK	1	99	23.52	23.55	23.62
20	QPSK	50	0	22.81	22.89	22.83
20	QPSK	50	24	22.77	22.76	22.76
20	QPSK	50	50	22.66	22.78	22.60
20	QPSK	100	0	22.61	22.76	22.64
20	16QAM	1	0	22.71	22.49	22.65
20	16QAM	1	49	22.55	22.72	22.68
20	16QAM	1	99	22.75	22.44	22.62
20	16QAM	50	0	21.68	21.81	21.76
20	16QAM	50	24	21.80	21.70	21.75
20	16QAM	50	50	21.81	21.69	21.71
20	16QAM	100	0	21.68	21.70	21.73
20	64QAM	1	0	21.44	21.68	21.83
20	64QAM	1	49	21.27	21.32	21.48
20	64QAM	1	99	21.54	21.59	21.53
20	64QAM	50	0	20.72	20.75	20.79
20	64QAM	50	24	20.85	20.74	20.77
20	64QAM	50	50	20.75	20.70	20.67
20	64QAM	100	0	20.71	20.68	20.73
Channel				42165	42590	43015
Frequency (MHz)				3457.5	3500	3542.5
15	QPSK	1	0	23.60	23.62	23.49
15	QPSK	1	37	23.76	23.66	23.47
15	QPSK	1	74	23.59	23.58	23.51
15	QPSK	36	0	22.81	22.70	22.75
15	QPSK	36	20	22.78	22.72	22.60
15	QPSK	36	39	22.75	22.69	22.68
15	QPSK	75	0	22.72	22.70	22.73
15	16QAM	1	0	22.59	22.37	22.41
15	16QAM	1	37	22.70	22.75	22.67
15	16QAM	1	74	22.09	22.62	22.48
15	16QAM	36	0	21.83	21.75	21.60



15	16QAM	36	20	21.72	21.75	21.75
15	16QAM	36	39	21.71	21.74	21.70
15	16QAM	75	0	21.72	21.63	21.66
15	64QAM	1	0	21.51	21.39	21.57
15	64QAM	1	37	21.75	21.89	21.64
15	64QAM	1	74	21.53	21.62	21.24
15	64QAM	36	0	20.73	20.74	20.71
15	64QAM	36	20	20.73	20.82	20.72
15	64QAM	36	39	20.72	20.71	20.63
15	64QAM	75	0	20.82	20.67	20.73
Channel				42140	42590	43040
Frequency (MHz)				3455	3500	3545
10	QPSK	1	0	23.71	23.96	23.89
10	QPSK	1	25	23.90	23.84	23.94
10	QPSK	1	49	23.90	23.70	23.71
10	QPSK	25	0	22.92	22.75	22.84
10	QPSK	25	12	22.91	22.90	22.86
10	QPSK	25	25	22.88	22.97	22.71
10	QPSK	50	0	22.93	22.86	22.85
10	16QAM	1	0	23.23	23.16	23.12
10	16QAM	1	25	23.14	22.94	23.23
10	16QAM	1	49	23.14	22.89	22.69
10	16QAM	25	0	21.89	21.88	21.84
10	16QAM	25	12	21.95	21.89	21.82
10	16QAM	25	25	21.92	22.00	21.74
10	16QAM	50	0	21.97	21.83	21.81
10	64QAM	1	0	21.69	21.73	21.80
10	64QAM	1	25	22.05	21.79	21.41
10	64QAM	1	49	21.49	21.83	21.71
10	64QAM	25	0	20.86	20.82	20.77
10	64QAM	25	12	20.92	20.84	20.78
10	64QAM	25	25	20.91	20.87	20.86
10	64QAM	50	0	20.98	20.84	20.80
Channel				42115	42590	43065
Frequency (MHz)				3452.5	3500	3547.5
5	QPSK	1	0	23.83	23.91	23.75
5	QPSK	1	12	23.96	23.98	23.82
5	QPSK	1	24	23.80	23.86	23.58
5	QPSK	12	0	22.86	22.89	22.83
5	QPSK	12	7	22.93	22.84	22.83
5	QPSK	12	13	22.85	22.81	22.80
5	QPSK	25	0	22.90	22.95	22.84
5	16QAM	1	0	22.94	22.85	22.62
5	16QAM	1	12	22.67	22.87	22.84
5	16QAM	1	24	23.08	23.07	22.87
5	16QAM	12	0	21.87	21.94	21.85
5	16QAM	12	7	22.03	21.88	21.87
5	16QAM	12	13	21.85	21.86	21.73
5	16QAM	25	0	21.90	21.85	21.76



5	64QAM	1	0	21.90	21.73	21.89
5	64QAM	1	12	21.88	21.70	21.84
5	64QAM	1	24	22.08	21.89	21.44
5	64QAM	12	0	20.92	21.01	20.90
5	64QAM	12	7	20.86	20.92	20.83
5	64QAM	12	13	20.79	20.84	20.82
5	64QAM	25	0	20.84	20.82	20.82

EIRP

LTE Band 42 (G _T - L _C = 0dB) QPSK									
Bandwidth	5M			10M			15M		
Channel	42115	42590	43065	42140	42590	43040	42165	42590	43015
	(Low)	(Mid)	(High)	(Low)	(Mid)	(High)	(Low)	(Mid)	(High)
Frequency	3452.5	3500	3547.5	3455	3500	3545	3457.5	3500	3542.5
(MHz)									
Conducted Power (dBm)	23.96	23.98	23.82	23.71	23.96	23.89	23.76	23.66	23.47
Conducted Power (Watts)	0.2489	0.2500	0.2410	0.2350	0.2489	0.2449	0.2377	0.2323	0.2223
EIRP(dBm)	23.96	23.98	23.82	23.71	23.96	23.89	23.76	23.66	23.47
EIRP(Watts)	0.2489	0.2500	0.2410	0.2350	0.2489	0.2449	0.2377	0.2323	0.2223

LTE Band 42 (G _T - L _C = 0dB) QPSK			
Bandwidth	20M		
Channel	42190	42590	42990
	(Low)	(Mid)	(High)
Frequency	3460	3500	3540
(MHz)			
Conducted Power (dBm)	23.73	23.99	23.85
Conducted Power (Watts)	0.2360	0.2506	0.2427
EIRP(dBm)	23.73	23.99	23.85
EIRP(Watts)	0.2360	0.2506	0.2427



LTE Band 42 (G _T - L _C = 0dB) 16QAM									
Bandwidth	5M			10M			15M		
Channel	42115	42590	43065	42140	42590	43040	42165	42590	43015
	(Low)	(Mid)	(High)	(Low)	(Mid)	(High)	(Low)	(Mid)	(High)
Frequency	3452.5	3500	3547.5	3455	3500	3545	3457.5	3500	3542.5
(MHz)									
Conducted Power (dBm)	23.08	23.07	22.87	23.23	23.16	23.12	22.70	22.75	22.67
Conducted Power (Watts)	0.2032	0.2028	0.1936	0.2104	0.2070	0.2051	0.1862	0.1884	0.1849
EIRP(dBm)	23.08	23.07	22.87	23.23	23.16	23.12	22.70	22.75	22.67
EIRP(Watts)	0.2032	0.2028	0.1936	0.2104	0.2070	0.2051	0.1862	0.1884	0.1849

LTE Band 42 (G _T - L _C = 0dB) 16QAM			
Bandwidth	20M		
Channel	42190	42590	42990
	(Low)	(Mid)	(High)
Frequency	3460	3500	3540
(MHz)			
Conducted Power (dBm)	22.75	22.44	22.62
Conducted Power (Watts)	0.1884	0.1754	0.1828
EIRP(dBm)	22.75	22.44	22.62
EIRP(Watts)	0.1884	0.1754	0.1828



LTE Band 42 (G _T - L _C = 0dB) 64QAM									
Bandwidth	5M			10M			15M		
Channel	42115	42590	43065	42140	42590	43040	42165	42590	43015
	(Low)	(Mid)	(High)	(Low)	(Mid)	(High)	(Low)	(Mid)	(High)
Frequency	3452.5	3500	3547.5	3455	3500	3545	3457.5	3500	3542.5
(MHz)									
Conducted Power (dBm)	22.08	21.89	21.44	22.05	21.79	21.41	21.75	21.89	21.64
Conducted Power (Watts)	0.1614	0.1545	0.1393	0.1603	0.1510	0.1384	0.1496	0.1545	0.1459
EIRP(dBm)	22.08	21.89	21.44	22.05	21.79	21.41	21.75	21.89	21.64
EIRP(Watts)	0.1614	0.1545	0.1393	0.1603	0.1510	0.1384	0.1496	0.1545	0.1459

LTE Band 42 (G _T - L _C = 0dB) 64QAM			
Bandwidth	20M		
Channel	42190	42590	42990
	(Low)	(Mid)	(High)
Frequency	3460	3500	3540
(MHz)			
Conducted Power (dBm)	21.44	21.68	21.83
Conducted Power (Watts)	0.1393	0.1472	0.1524
EIRP(dBm)	21.44	21.68	21.83
EIRP(Watts)	0.1393	0.1472	0.1524

LTE Band 42

Peak-to-Average Ratio

Mode	LTE Band 42 / 20MHz				
Mod.	QPSK		16QAM		Limit: 13dB
RB Size	1RB	Full RB	1RB	Full RB	Result
Lowest CH	3.59	4.61	4.38	5.71	PASS
Middle CH	3.57	4.61	4.03	5.74	
Highest CH	3.57	4.61	4.38	5.71	
Mode	LTE Band 42 / 20MHz				
Mod.	64QAM				Limit: 13dB
RB Size	1RB	Full RB			Result
Lowest CH	5.28	6.38	-	-	PASS
Middle CH	5.39	6.35	-	-	
Highest CH	5.30	6.29	-	-	



LTE Band 42 / 20MHz / QPSK

Lowest Channel / 1RB

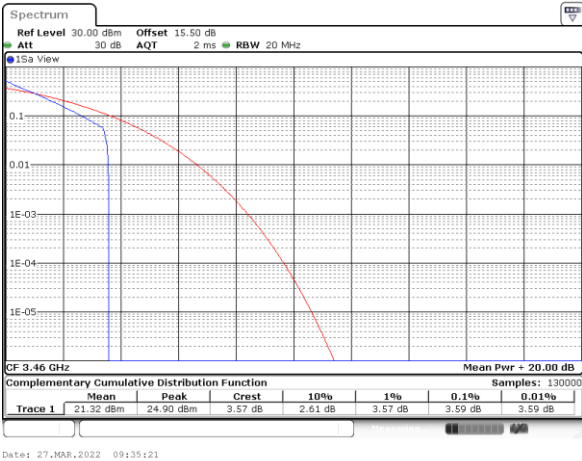

Date: 27.MAR.2022 09:35:23

Lowest Channel / Full RB

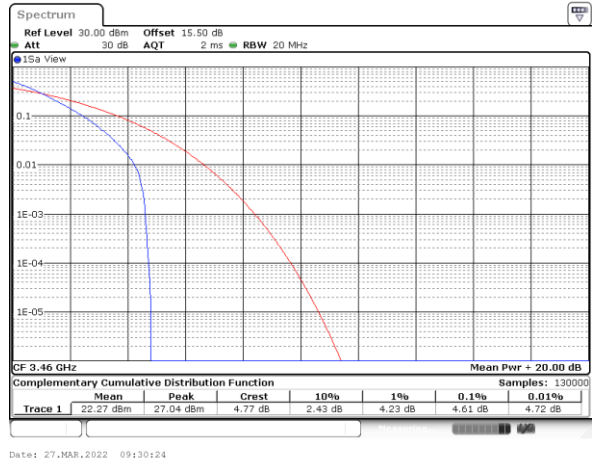

Date: 27.MAR.2022 09:30:24

Middle Channel / 1RB

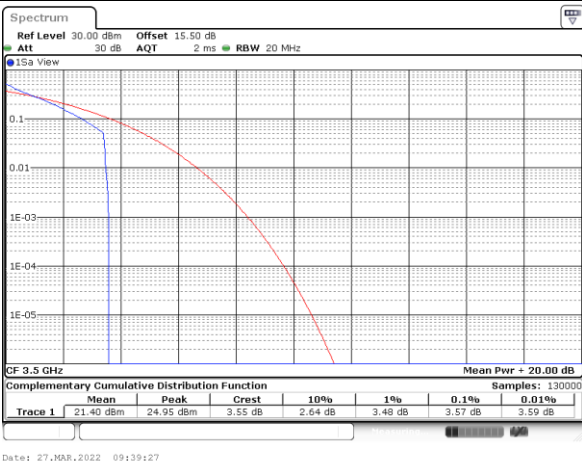

Date: 27.MAR.2022 09:39:27

Middle Channel / Full RB

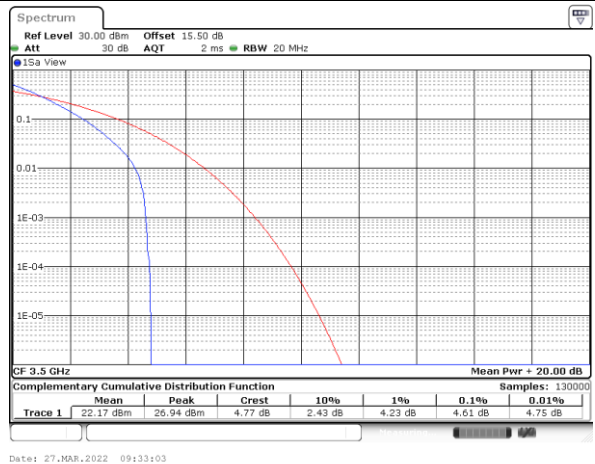

Date: 27.MAR.2022 09:33:03

Highest Channel / 1RB

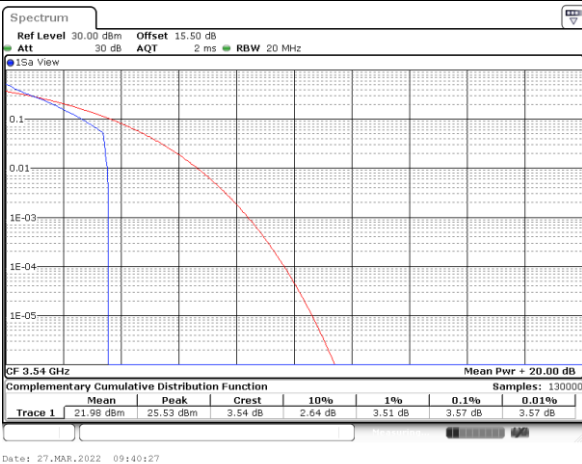

Date: 27.MAR.2022 09:40:27

Highest Channel / Full RB

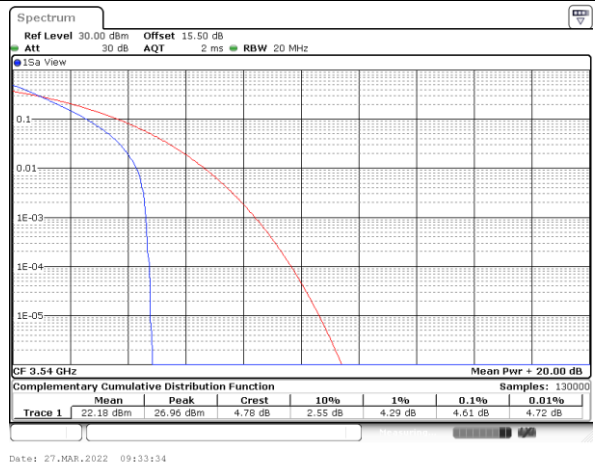

Date: 27.MAR.2022 09:33:34



LTE Band 42 / 20MHz / 16QAM

Lowest Channel / 1RB



Date: 27.MAR.2022 09:36:44

Lowest Channel / Full RB

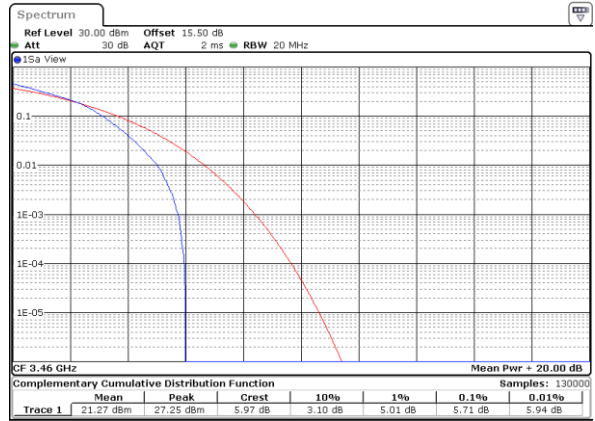

Date: 27.MAR.2022 09:33:00

Middle Channel / 1RB

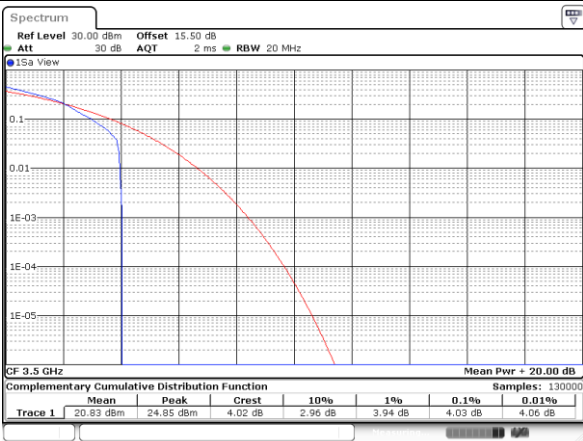

Date: 27.MAR.2022 09:38:52

Middle Channel / Full RB



Date: 27.MAR.2022 09:32:35

Highest Channel / 1RB

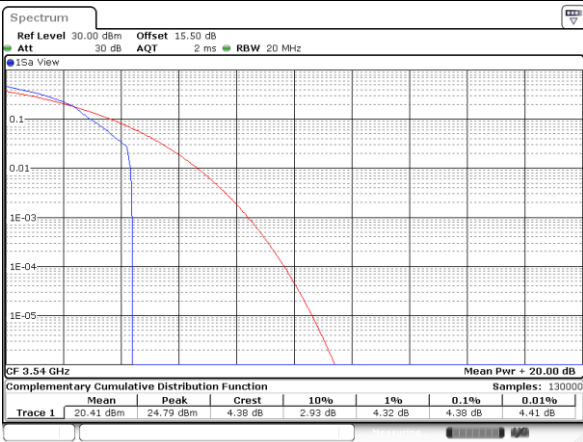

Date: 27.MAR.2022 09:41:37

Highest Channel / Full RB

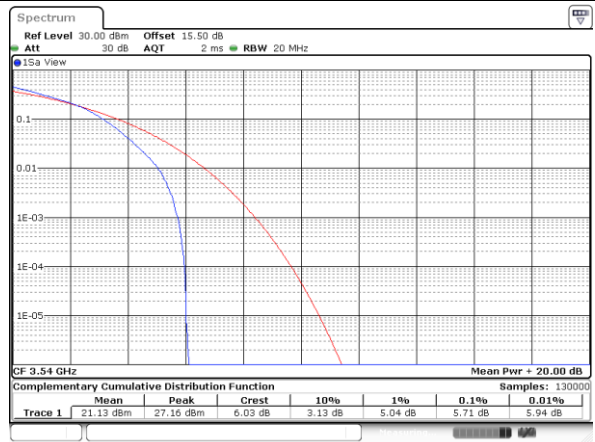

Date: 27.MAR.2022 09:34:05



LTE Band 42 / 20MHz / 64QAM

Lowest Channel / 1RB



Date: 27_MAR.2022 09:37:26

Lowest Channel / Full RB

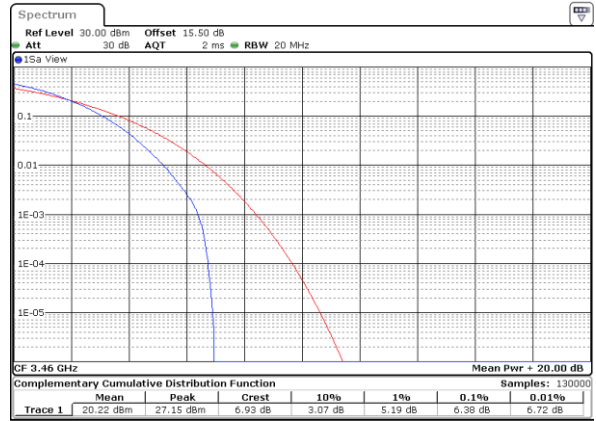

Date: 27_MAR.2022 09:33:34

Middle Channel / 1RB



Date: 27_MAR.2022 09:38:20

Middle Channel / Full RB

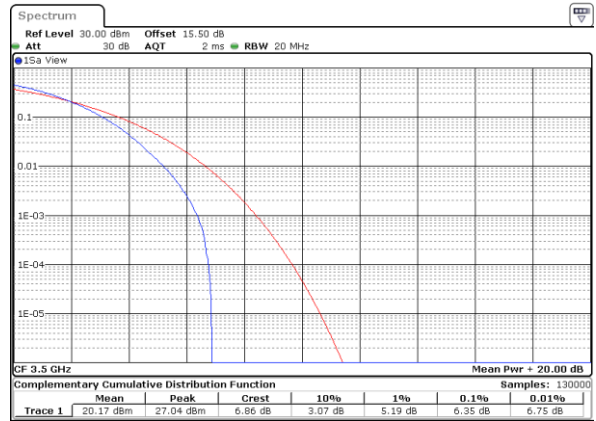

Date: 27_MAR.2022 09:32:07

Highest Channel / 1RB



Date: 27_MAR.2022 09:42:26

Highest Channel / Full RB



Date: 27_MAR.2022 09:34:39



26dB Bandwidth

Mode	LTE Band 42 : 26dB BW(MHz)											
BW	1.4MHz		3MHz		5MHz		10MHz		15MHz		20MHz	
Mod.	QPSK	16QAM	QPSK	16QAM	QPSK	16QAM	QPSK	16QAM	QPSK	16QAM	QPSK	16QAM
Lowest CH	-	-	-	-	5.07	5.05	9.75	9.97	14.36	14.24	18.74	18.82
Middle CH	-	-	-	-	4.97	4.97	9.79	9.79	14.36	14.27	18.70	19.18
Highest CH	-	-	-	-	5.04	5.03	9.83	9.65	14.27	14.24	18.86	18.62
Mode	LTE Band 42 : 26dB BW(MHz)											
BW	1.4MHz		3MHz		5MHz		10MHz		15MHz		20MHz	
Mod.	64QAM		64QAM		64QAM		64QAM		64QAM		64QAM	
Lowest CH	-	-	-	-	4.94	-	9.93	-	14.36	-	18.62	-
Middle CH	-	-	-	-	5.06	-	9.89	-	14.36	-	18.82	-
Highest CH	-	-	-	-	4.94	-	10.07	-	14.18	-	18.90	-



LTE Band 42

Lowest Channel / 5MHz / QPSK

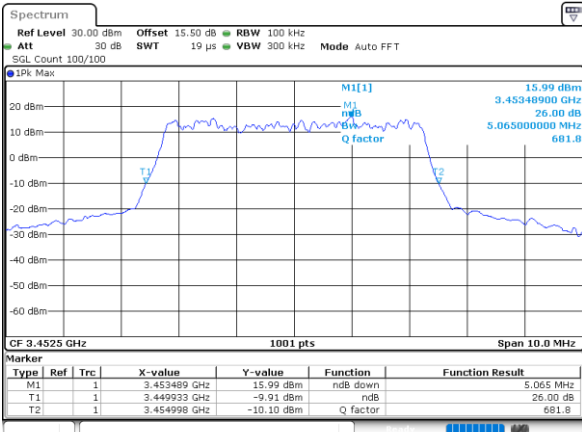

Date: 27_MAR.2022 09:07:11

Lowest Channel / 5MHz / 16QAM

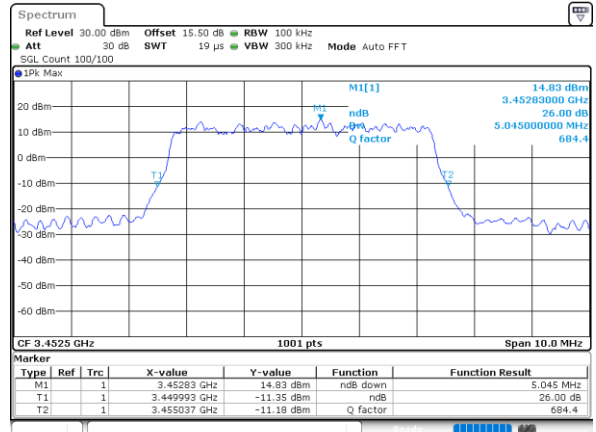

Date: 27_MAR.2022 09:07:46

Middle Channel / 5MHz / QPSK

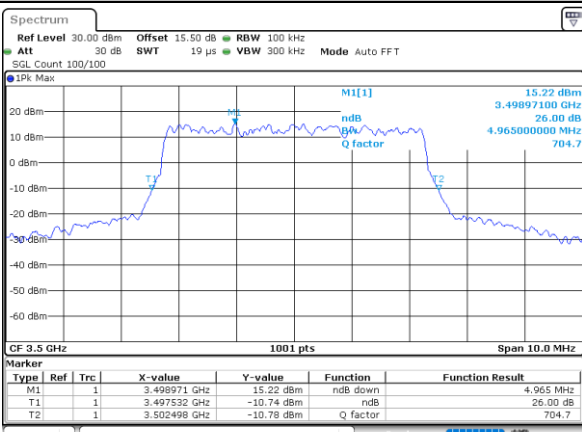

Date: 27_MAR.2022 09:09:59

Middle Channel / 5MHz / 16QAM

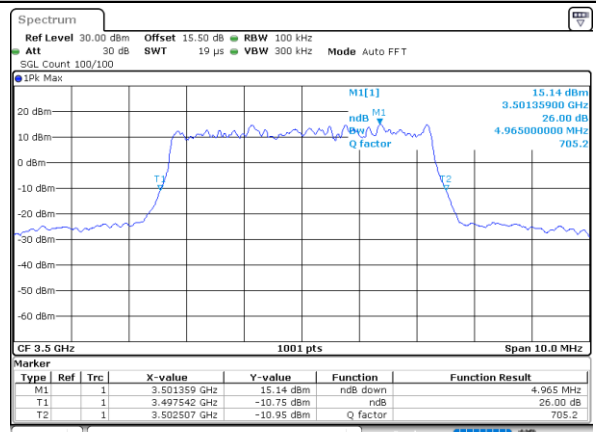

Date: 27_MAR.2022 09:10:26

Highest Channel / 5MHz / QPSK

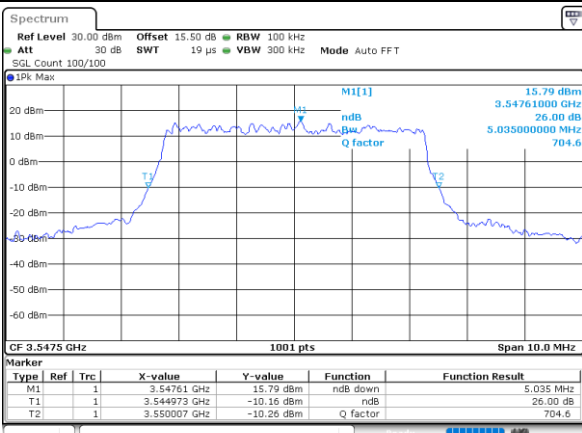

Date: 27_MAR.2022 09:10:29

Highest Channel / 5MHz / 16QAM

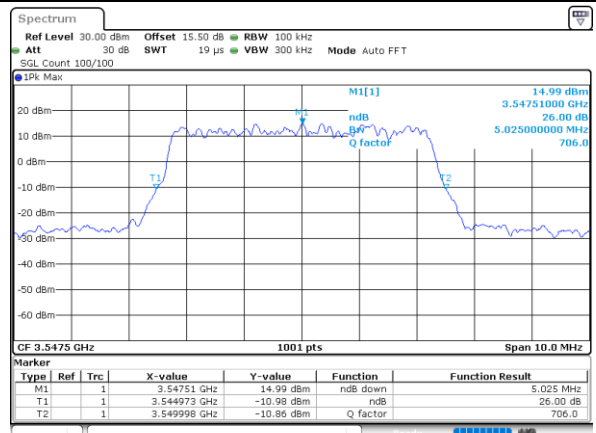

Date: 27_MAR.2022 09:10:56



LTE Band 42

Lowest Channel / 10MHz / QPSK

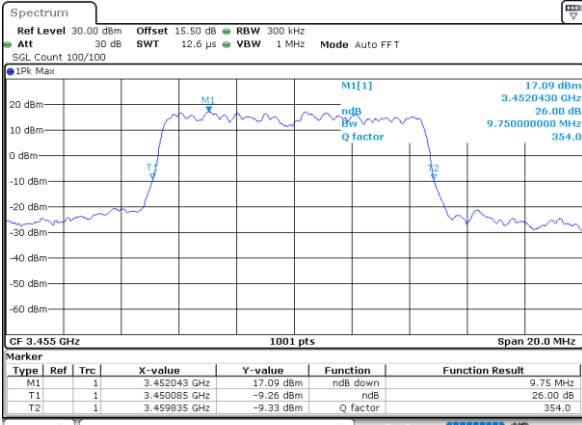

Date: 27_MAR_2022 09:13:21

Lowest Channel / 10MHz / 16QAM

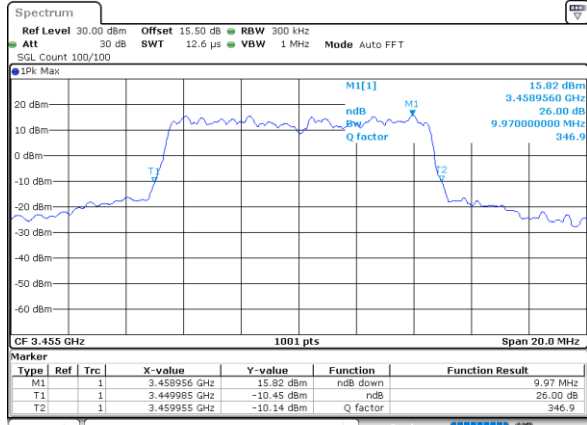

Date: 27_MAR_2022 09:13:57

Middle Channel / 10MHz / QPSK

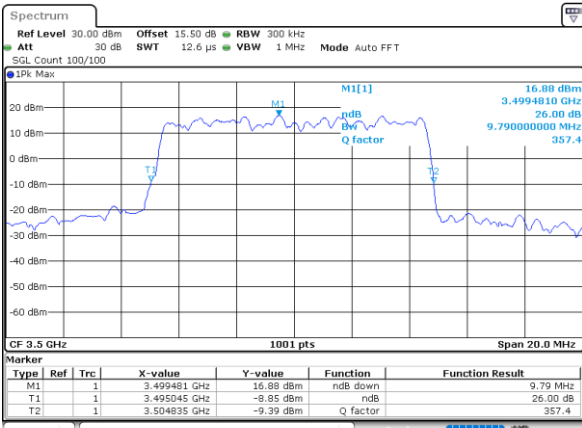

Date: 27_MAR_2022 09:16:09

Middle Channel / 10MHz / 16QAM

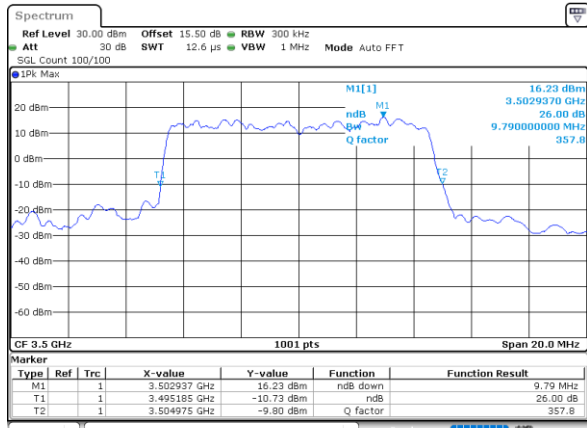

Date: 27_MAR_2022 09:15:45

Highest Channel / 10MHz / QPSK

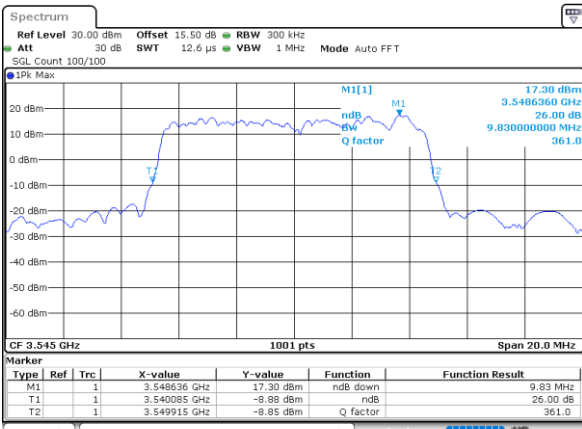

Date: 27_MAR_2022 09:16:35

Highest Channel / 10MHz / 16QAM

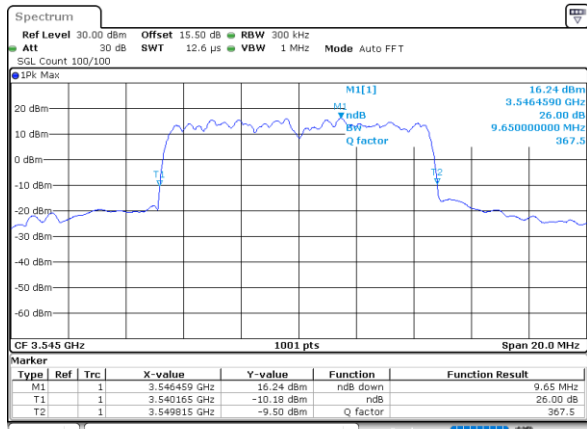

Date: 27_MAR_2022 09:17:05



LTE Band 42

Lowest Channel / 15MHz / QPSK

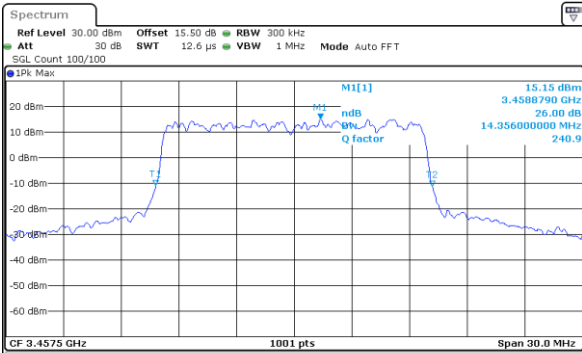

Date: 27_MAR.2022 09:12013

Lowest Channel / 15MHz / 16QAM

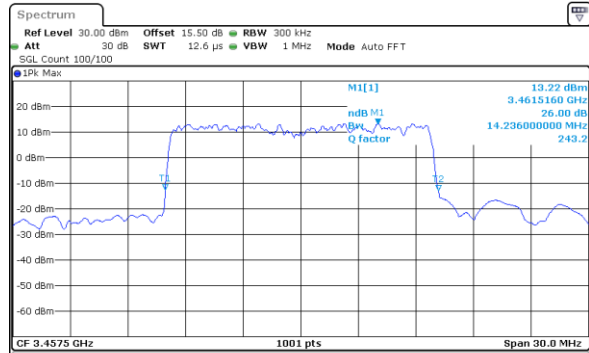

Date: 27_MAR.2022 09:119154

Middle Channel / 15MHz / QPSK

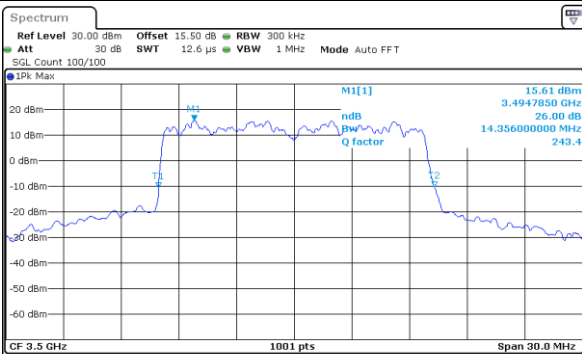

Date: 27_MAR.2022 09:2111

Middle Channel / 15MHz / 16QAM

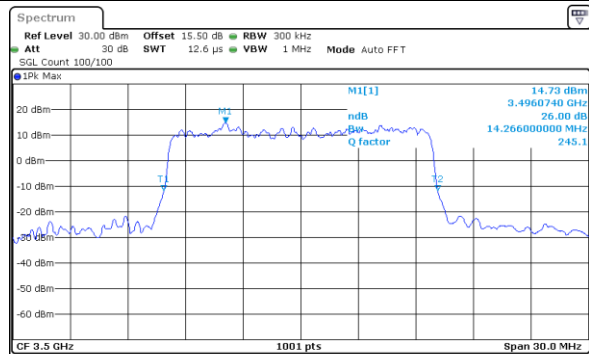

Date: 27_MAR.2022 09:21145

Highest Channel / 15MHz / QPSK

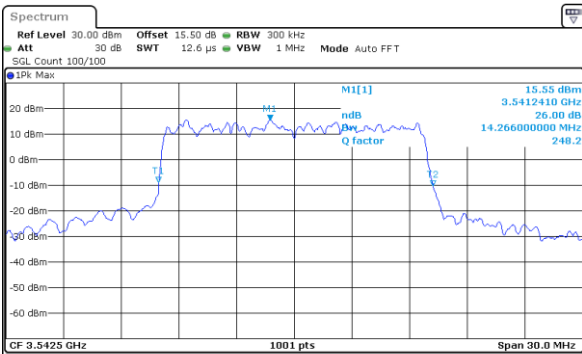

Date: 27_MAR.2022 09:2402

Highest Channel / 15MHz / 16QAM

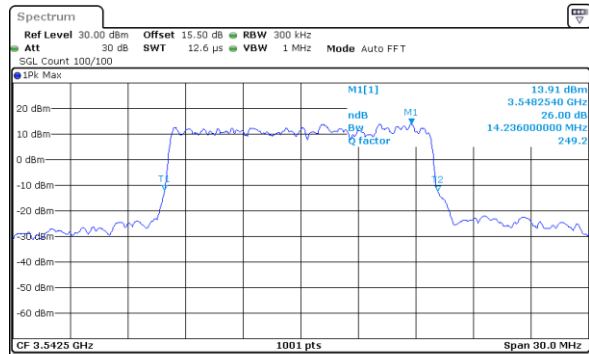

Date: 27_MAR.2022 09:23138



LTE Band 42

Lowest Channel / 20MHz / QPSK

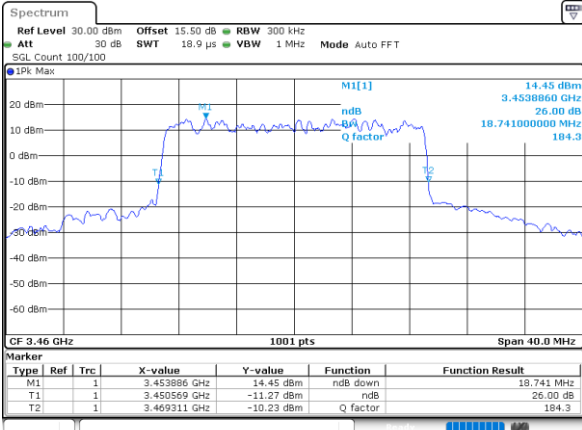

Date: 27_MAR_2022 09:24:46

Lowest Channel / 20MHz / 16QAM

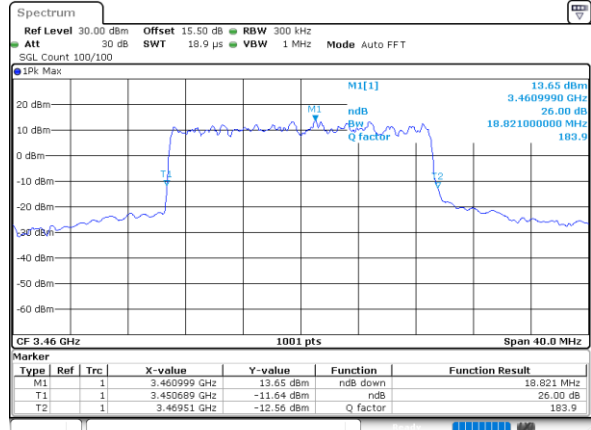

Date: 27_MAR_2022 09:25:15

Middle Channel / 20MHz / QPSK

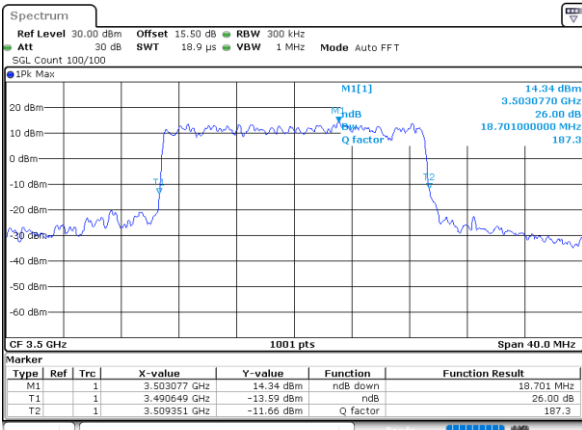

Date: 27_MAR_2022 09:27:46

Middle Channel / 20MHz / 16QAM

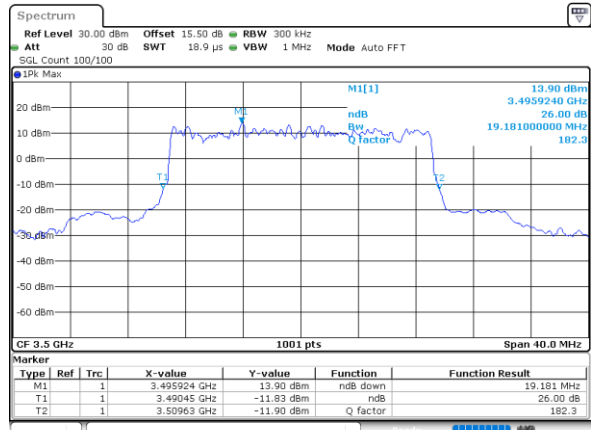

Date: 27_MAR_2022 09:27:12

Highest Channel / 20MHz / QPSK

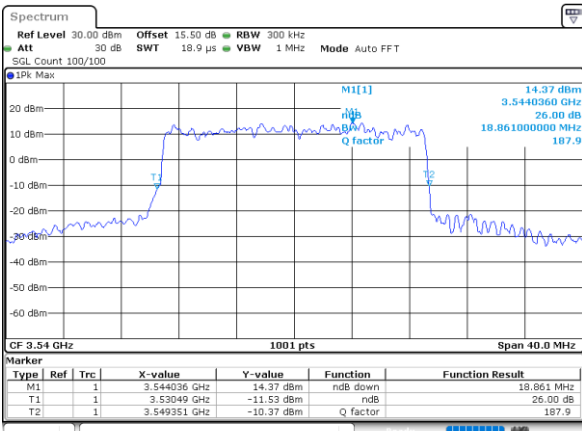

Date: 27_MAR_2022 09:28:24

Highest Channel / 20MHz / 16QAM

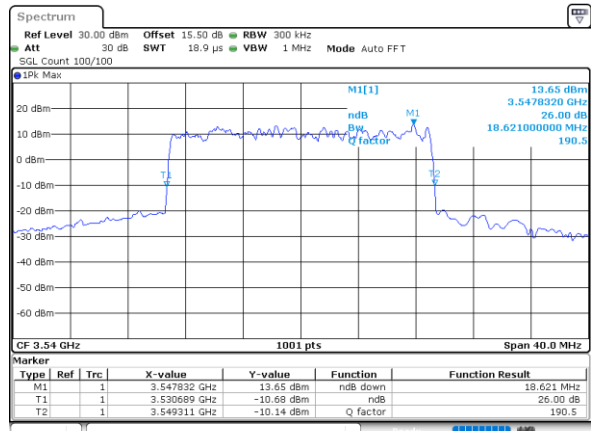

Date: 27_MAR_2022 09:28:52



LTE Band 42

Lowest Channel / 5MHz / 64QAM

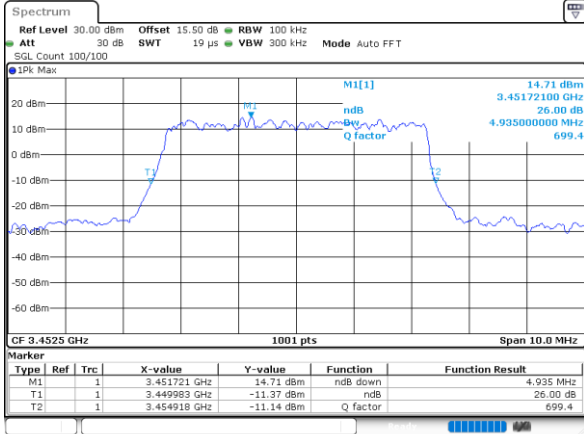

Date: 27_MAR_2022 09:08:19

Lowest Channel / 10MHz / 64QAM

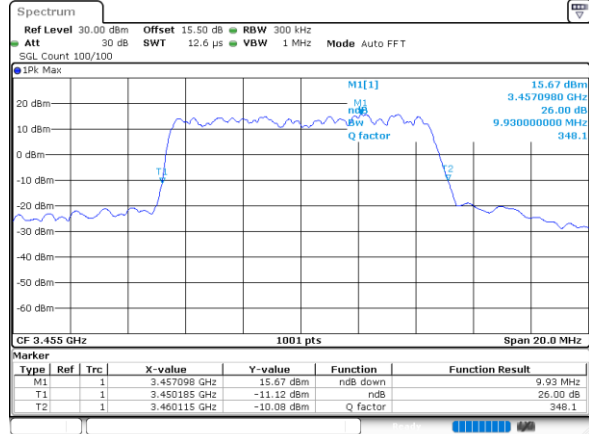

Date: 27_MAR_2022 09:11:23

Middle Channel / 5MHz / 64QAM

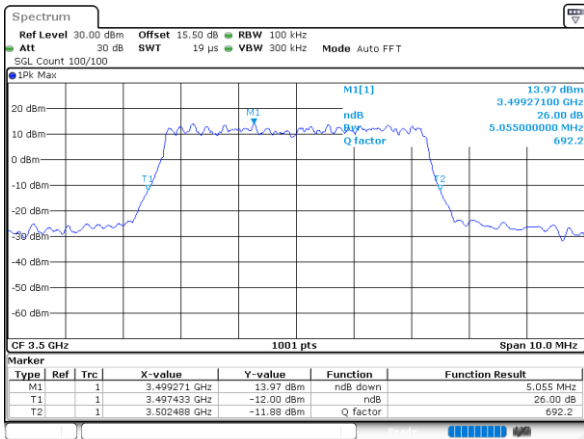

Date: 27_MAR_2022 09:08:57

Middle Channel / 10MHz / 64QAM

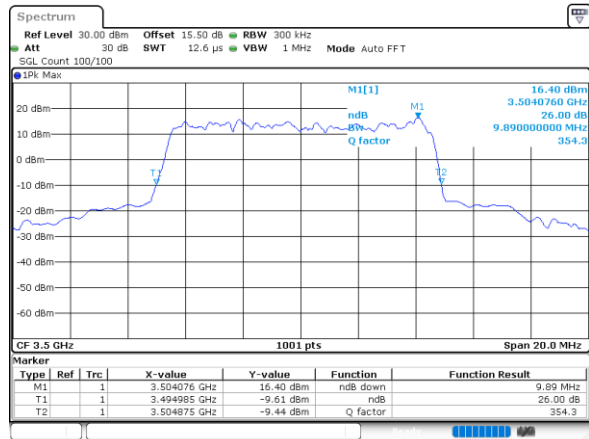

Date: 27_MAR_2022 09:15:11

Highest Channel / 5MHz / 64QAM

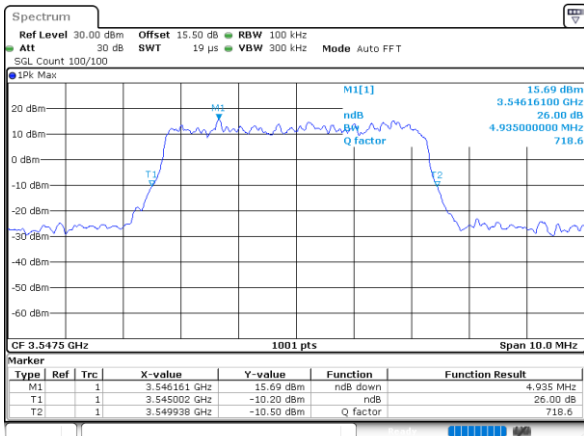

Date: 27_MAR_2022 09:11:25

Highest Channel / 10MHz / 64QAM

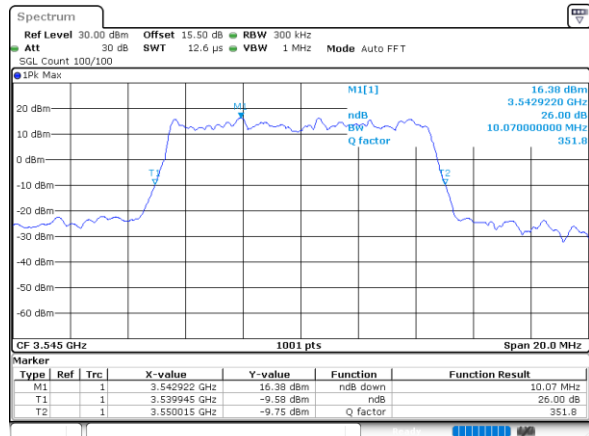

Date: 27_MAR_2022 09:17:33



LTE Band 42

Lowest Channel / 15MHz / 64QAM

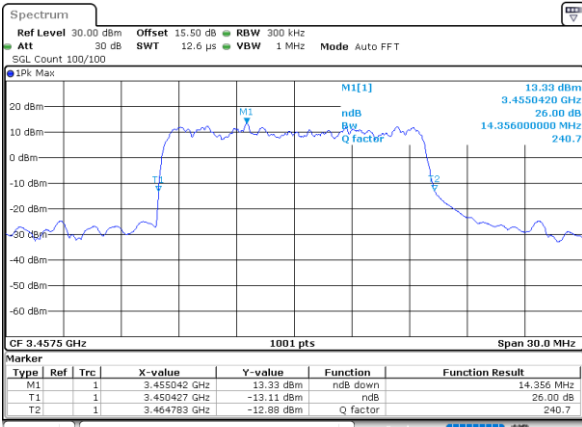

Date: 27_MAR_2022 09:19:03

Lowest Channel / 20MHz / 64QAM

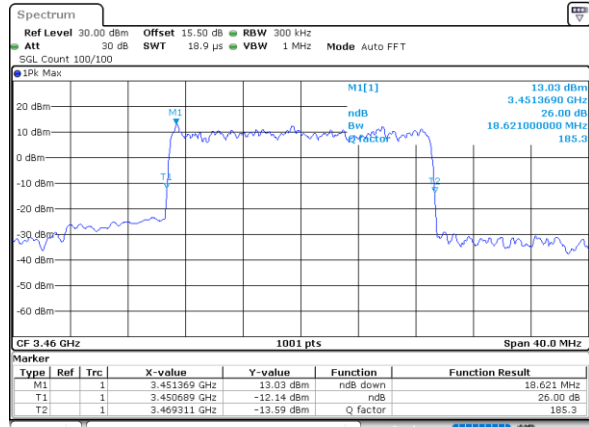

Date: 27_MAR_2022 09:26:10

Middle Channel / 15MHz / 64QAM

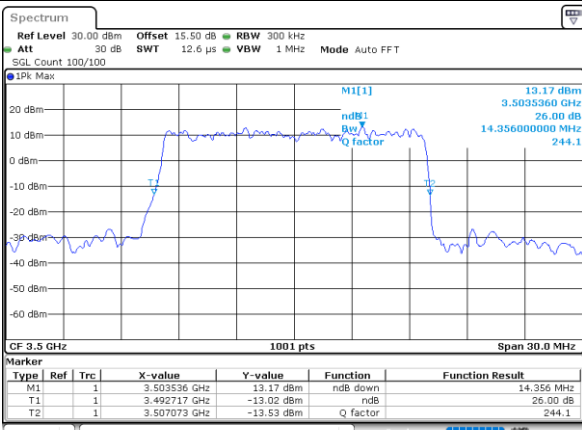

Date: 27_MAR_2022 09:22:20

Middle Channel / 20MHz / 64QAM

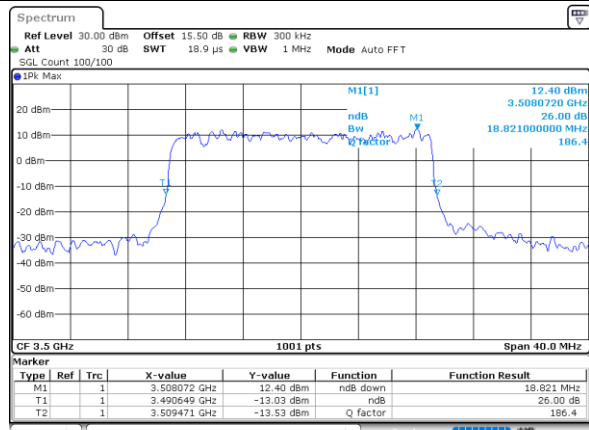

Date: 27_MAR_2022 09:26:46

Highest Channel / 15MHz / 64QAM

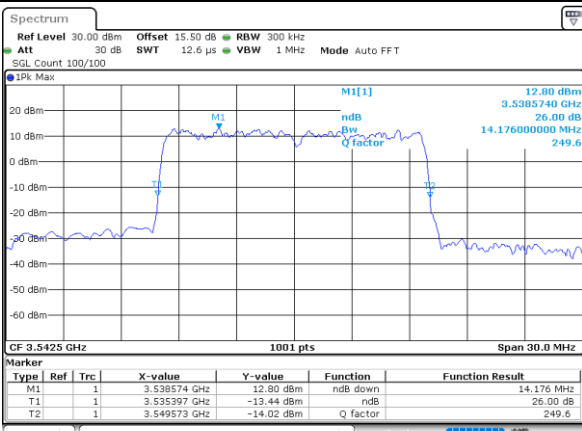

Date: 27_MAR_2022 09:23:11

Highest Channel / 20MHz / 64QAM

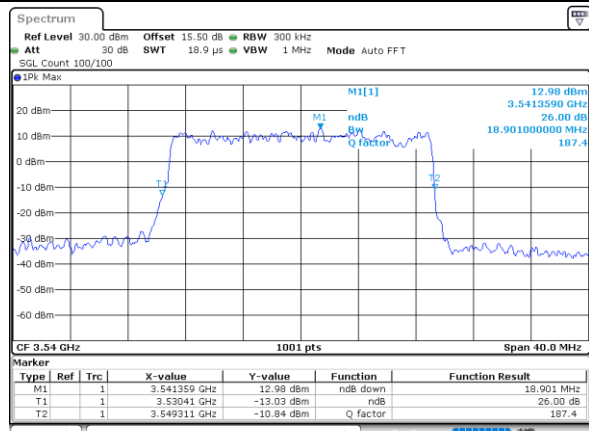

Date: 27_MAR_2022 09:29:21



Occupied Bandwidth

Mode	LTE Band 42 : 99%OBW(MHz)											
BW	1.4MHz		3MHz		5MHz		10MHz		15MHz		20MHz	
Mod.	QPSK	16QAM	QPSK	16QAM	QPSK	16QAM	QPSK	16QAM	QPSK	16QAM	QPSK	16QAM
Lowest CH	-	-	-	-	4.50	4.50	9.03	8.99	13.40	13.43	17.90	17.90
Middle CH	-	-	-	-	4.49	4.51	9.03	8.99	13.49	13.46	17.86	17.98
Highest CH	-	-	-	-	4.50	4.50	9.09	9.17	13.46	13.46	17.86	17.94
Mode	LTE Band 42 : 99%OBW(MHz)											
BW	1.4MHz		3MHz		5MHz		10MHz		15MHz		20MHz	
Mod.	64QAM		64QAM		64QAM		64QAM		64QAM		64QAM	
Lowest CH	-	-	-	-	4.50	-	9.01	-	13.49	-	17.82	-
Middle CH	-	-	-	-	4.54	-	9.05	-	13.40	-	17.86	-
Highest CH	-	-	-	-	4.48	-	9.09	-	13.46	-	17.86	-



LTE Band 42

Lowest Channel / 5MHz / QPSK

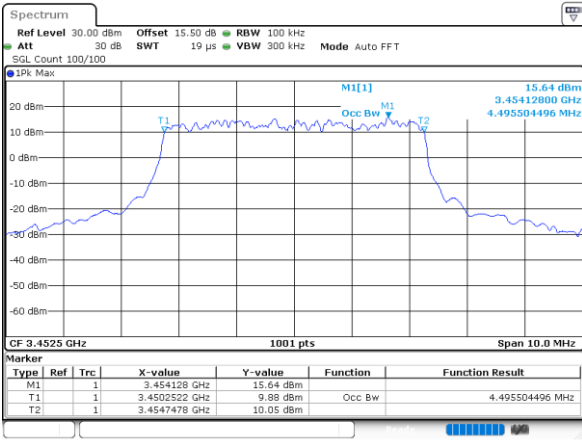

Date: 27.MAR.2022 09:06:44

Lowest Channel / 5MHz / 16QAM

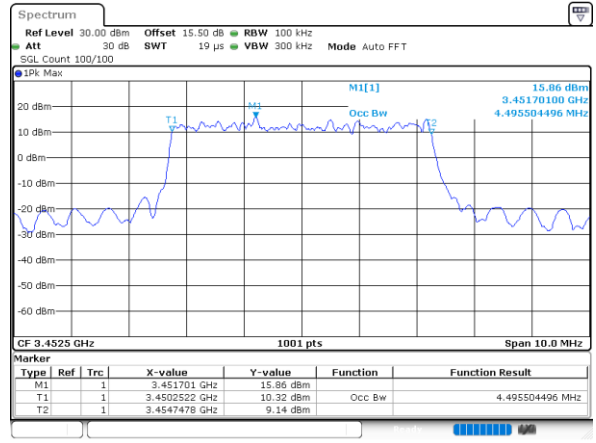

Date: 27.MAR.2022 09:07:33

Middle Channel / 5MHz / QPSK

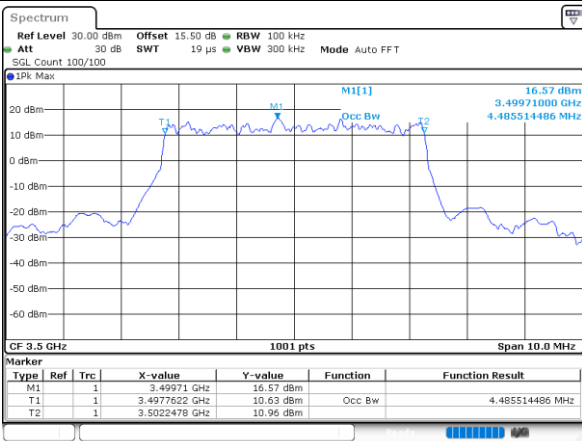

Date: 27.MAR.2022 09:09:39

Middle Channel / 5MHz / 16QAM

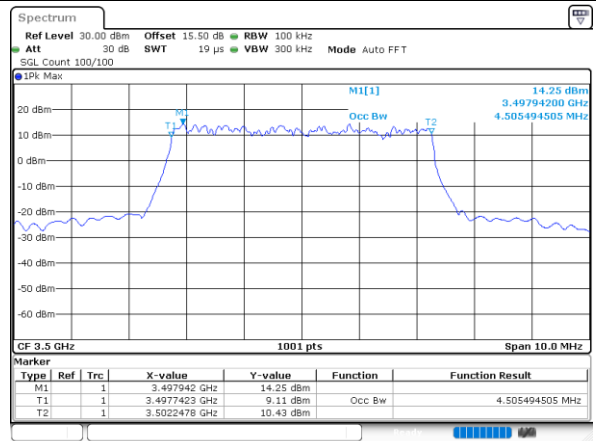

Date: 27.MAR.2022 09:09:11

Highest Channel / 5MHz / QPSK

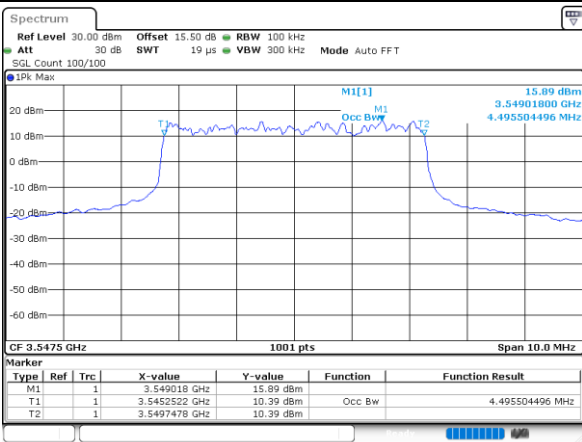

Date: 27.MAR.2022 09:10:14

Highest Channel / 5MHz / 16QAM

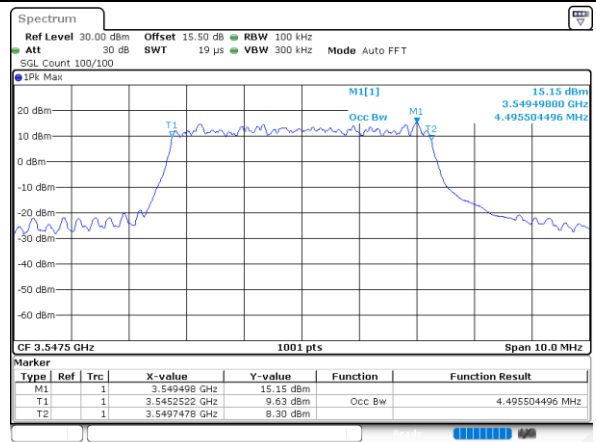

Date: 27.MAR.2022 09:10:44



LTE Band 42

Lowest Channel / 10MHz / QPSK

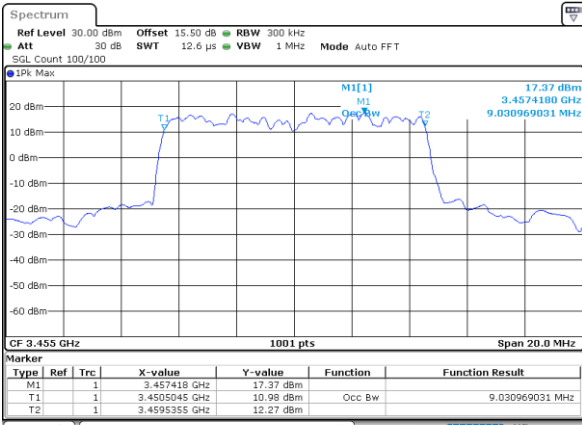

Date: 27_MAR_2022 09:12:50

Lowest Channel / 10MHz / 16QAM

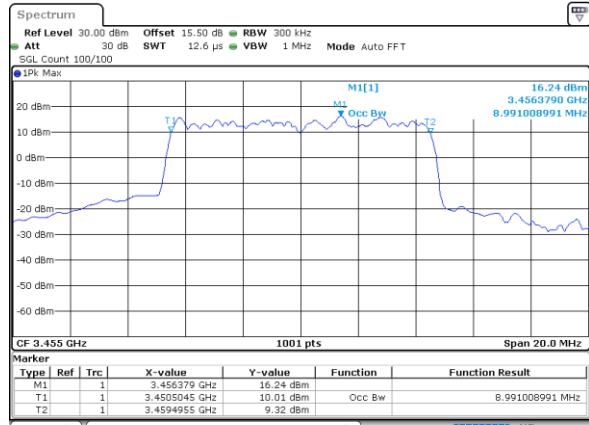

Date: 27_MAR_2022 09:13:37

Middle Channel / 10MHz / QPSK

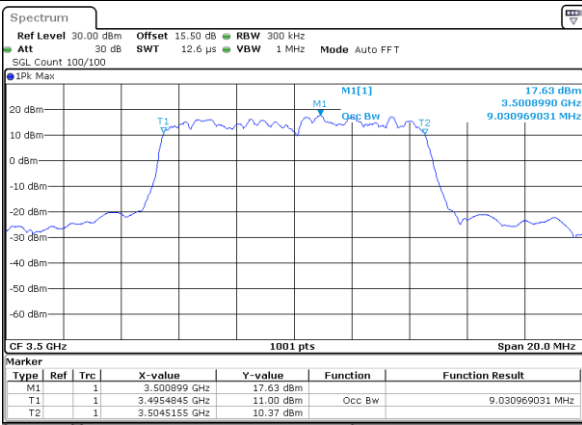

Date: 27_MAR_2022 09:15:59

Middle Channel / 10MHz / 16QAM

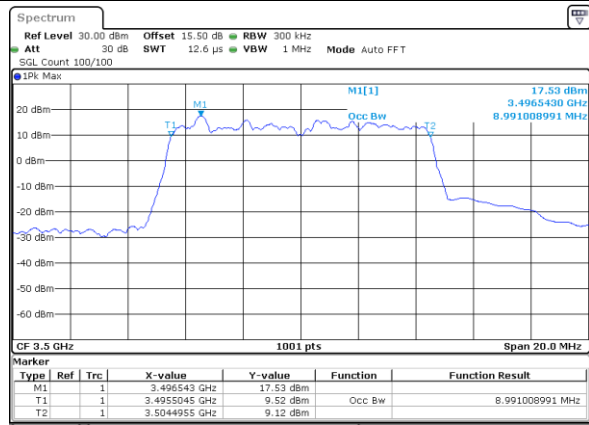

Date: 27_MAR_2022 09:15:34

Highest Channel / 10MHz / QPSK

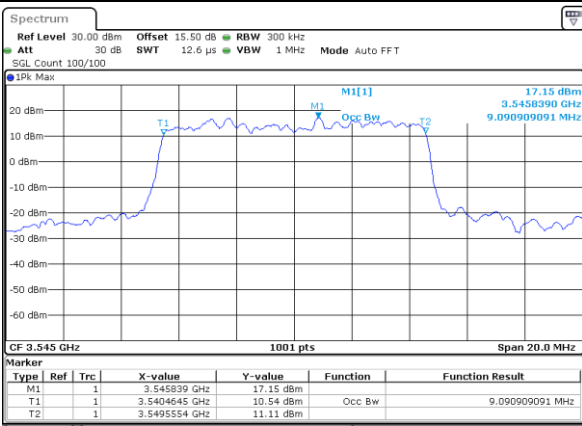

Date: 27_MAR_2022 09:16:24

Highest Channel / 10MHz / 16QAM

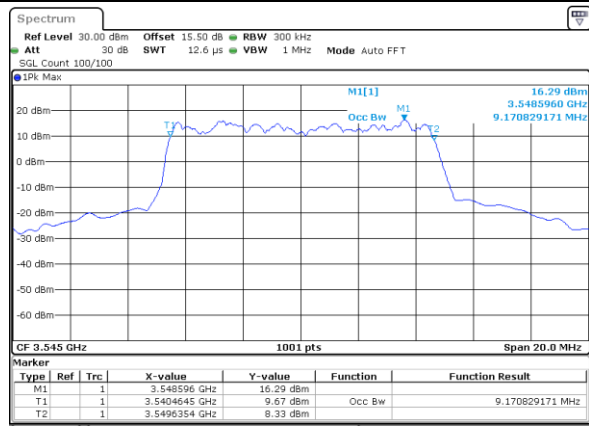

Date: 27_MAR_2022 09:16:49



LTE Band 42

Lowest Channel / 15MHz / QPSK

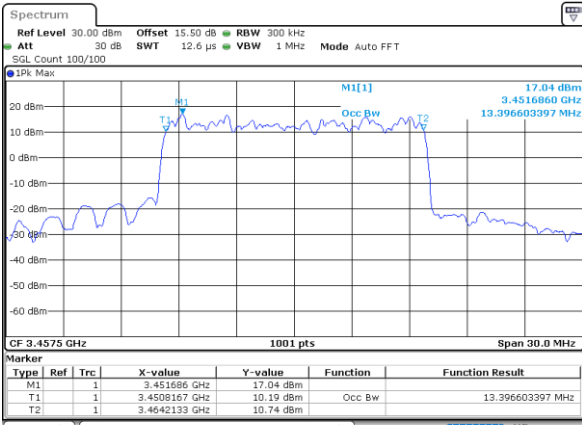

Date: 27_MAR.2022 09:12:17

Lowest Channel / 15MHz / 16QAM

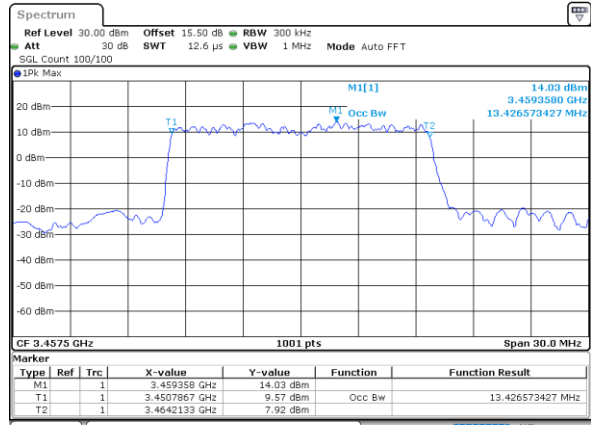

Date: 27_MAR.2022 09:11:18

Middle Channel / 15MHz / QPSK

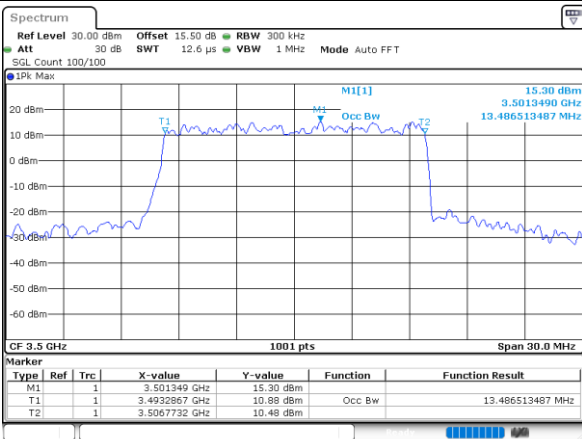

Date: 27_MAR.2022 09:21:00

Middle Channel / 15MHz / 16QAM

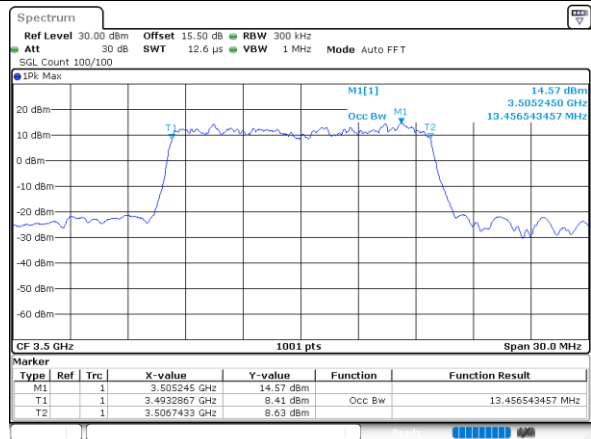

Date: 27_MAR.2022 09:21:33

Highest Channel / 15MHz / QPSK

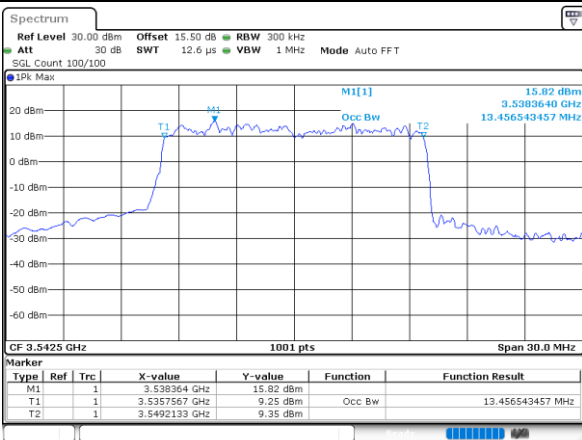

Date: 27_MAR.2022 09:23:50

Highest Channel / 15MHz / 16QAM

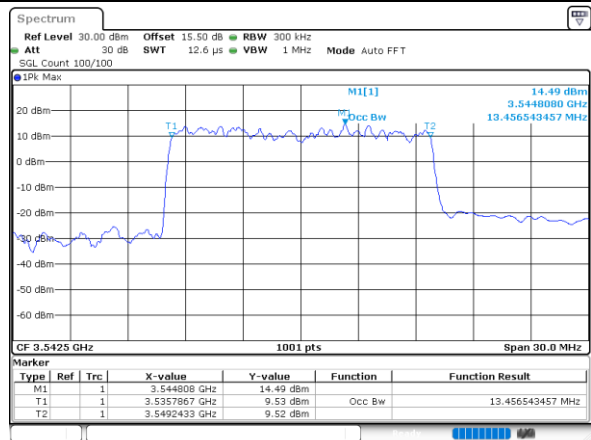

Date: 27_MAR.2022 09:23:27



LTE Band 42

Lowest Channel / 20MHz / QPSK

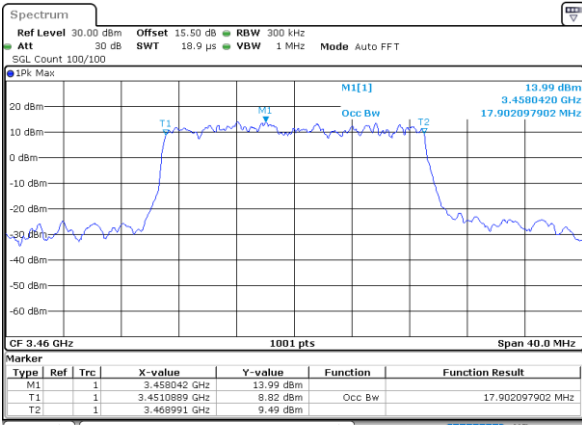

Date: 27_MAR.2022 09:24:18

Lowest Channel / 20MHz / 16QAM

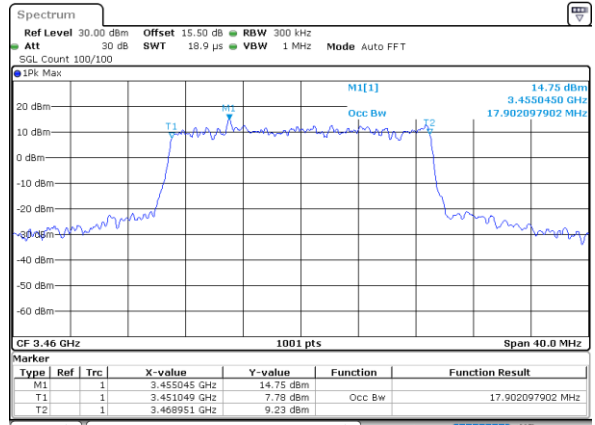

Date: 27_MAR.2022 09:25:03

Middle Channel / 20MHz / QPSK

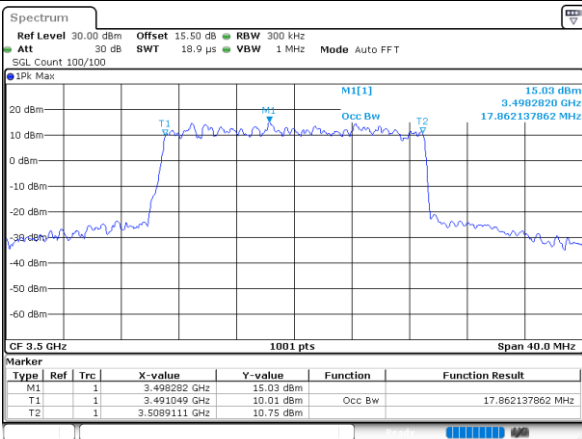

Date: 27_MAR.2022 09:27:35

Middle Channel / 20MHz / 16QAM

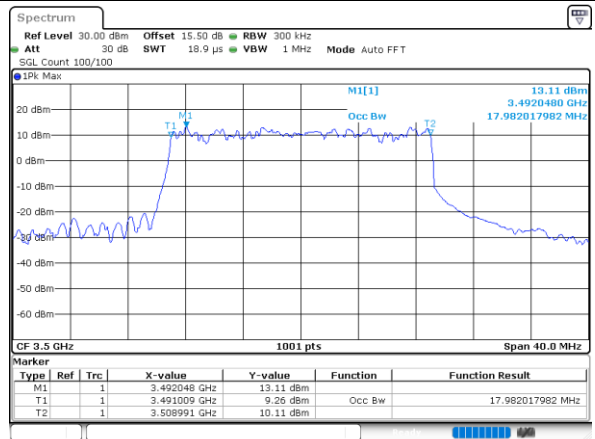

Date: 27_MAR.2022 09:26:59

Highest Channel / 20MHz / QPSK

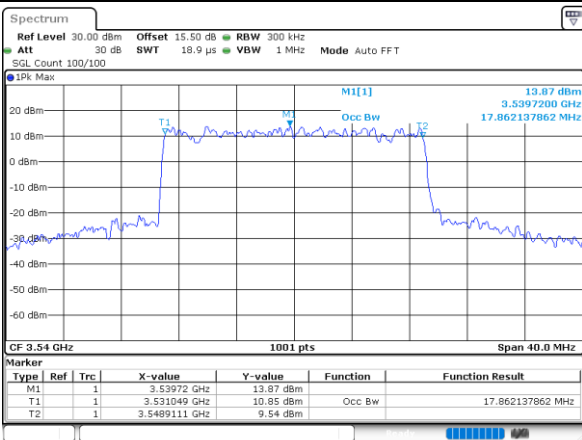

Date: 27_MAR.2022 09:28:12

Highest Channel / 20MHz / 16QAM

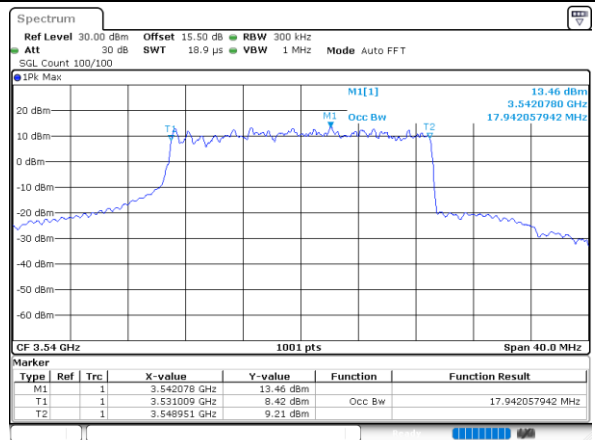

Date: 27_MAR.2022 09:28:39



LTE Band 42

Lowest Channel / 5MHz / 64QAM

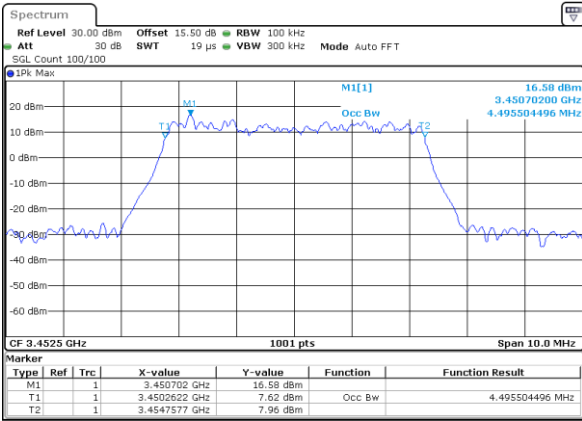

Date: 27_MAR.2022 09:10:03

Lowest Channel / 10MHz / 64QAM

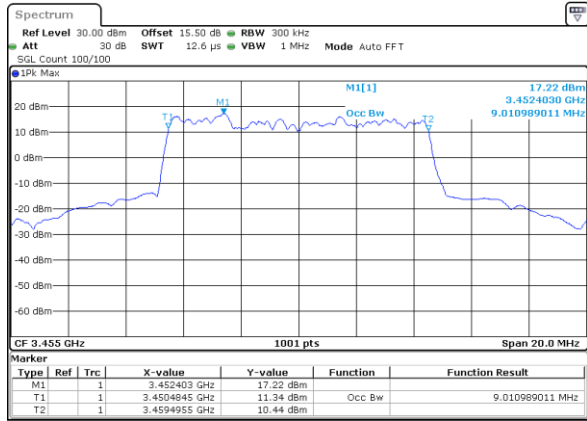

Date: 27_MAR.2022 09:11:12

Middle Channel / 5MHz / 64QAM

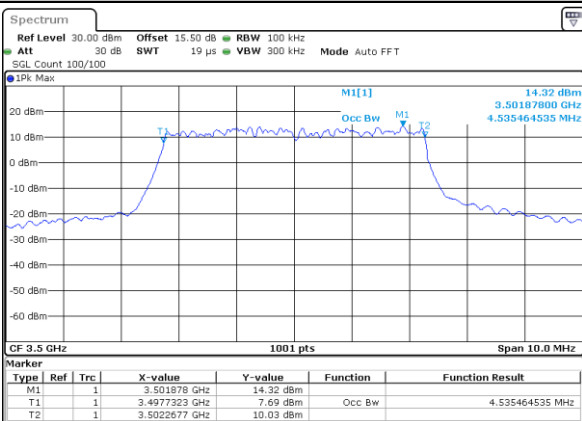

Date: 27_MAR.2022 09:10:40

Middle Channel / 10MHz / 64QAM

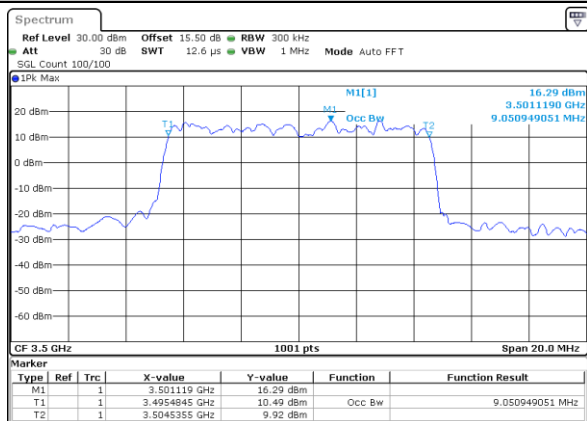

Date: 27_MAR.2022 09:11:39

Highest Channel / 5MHz / 64QAM

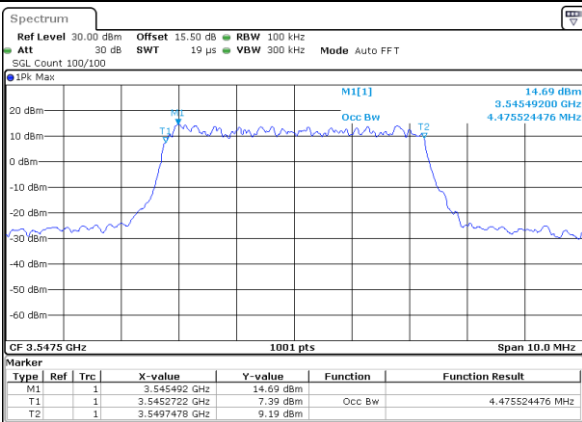

Date: 27_MAR.2022 09:11:12

Highest Channel / 10MHz / 64QAM

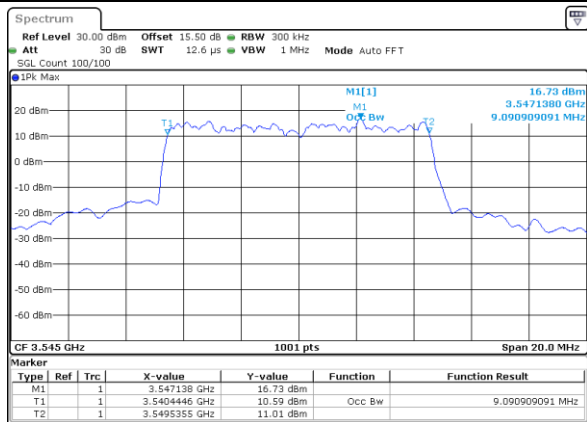

Date: 27_MAR.2022 09:11:22



LTE Band 42

Lowest Channel / 15MHz / 64QAM

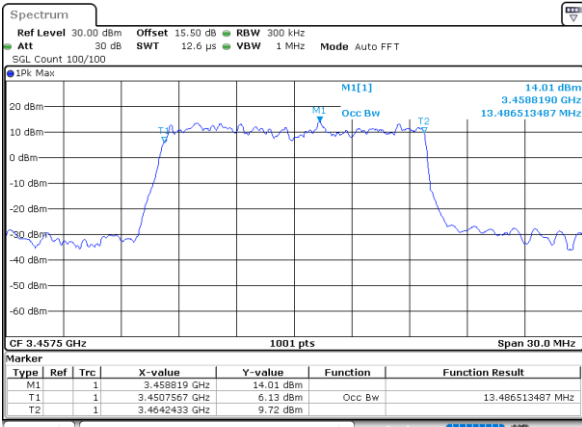

Date: 27_MAR_2022 09:18:50

Lowest Channel / 20MHz / 64QAM

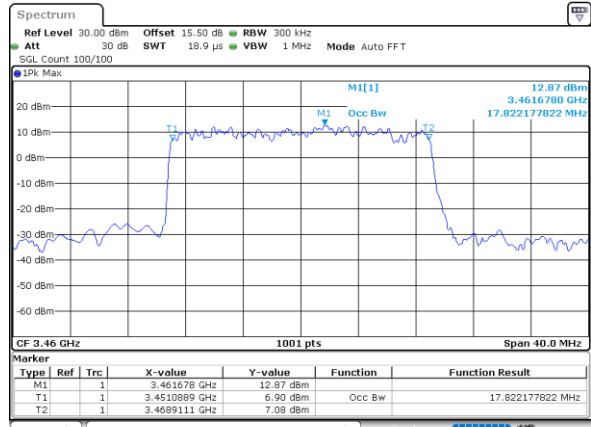

Date: 27_MAR_2022 09:25:58

Middle Channel / 15MHz / 64QAM

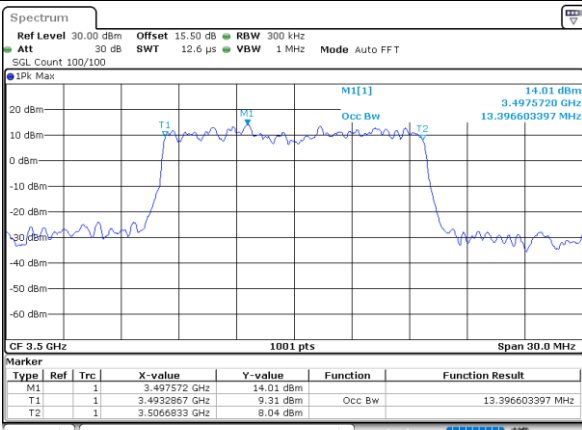

Date: 27_MAR_2022 09:22:01

Middle Channel / 20MHz / 64QAM

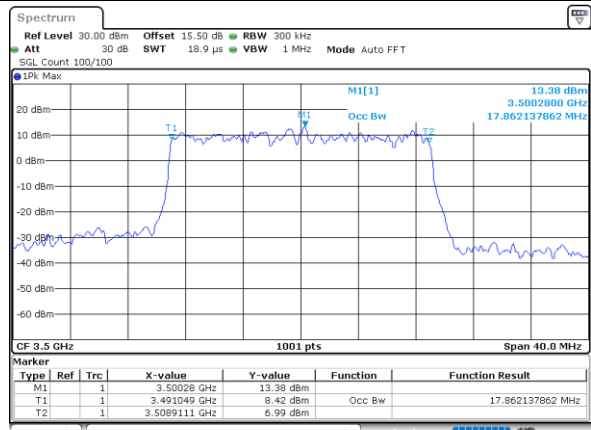

Date: 27_MAR_2022 09:26:32

Highest Channel / 15MHz / 64QAM

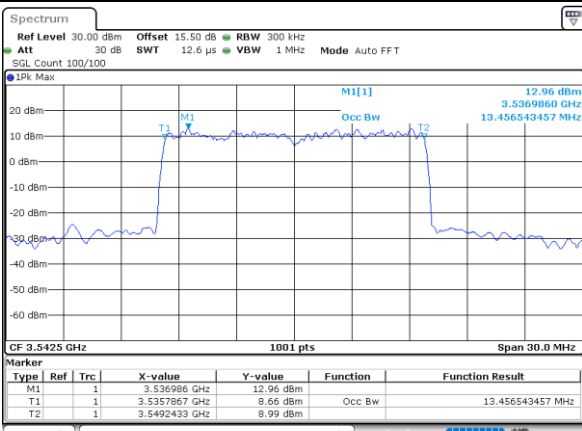

Date: 27_MAR_2022 09:22:59

Highest Channel / 20MHz / 64QAM

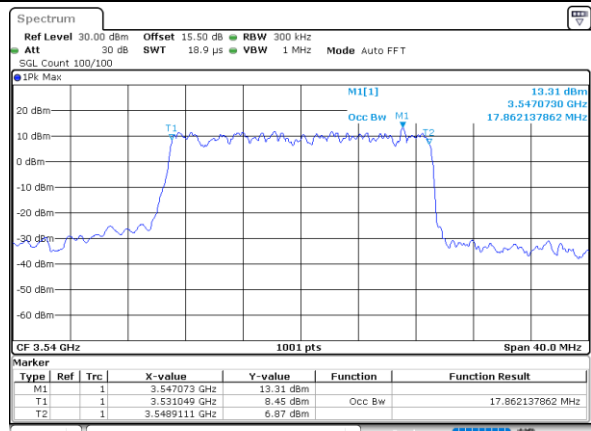

Date: 27_MAR_2022 09:29:09



Conducted Band Edge

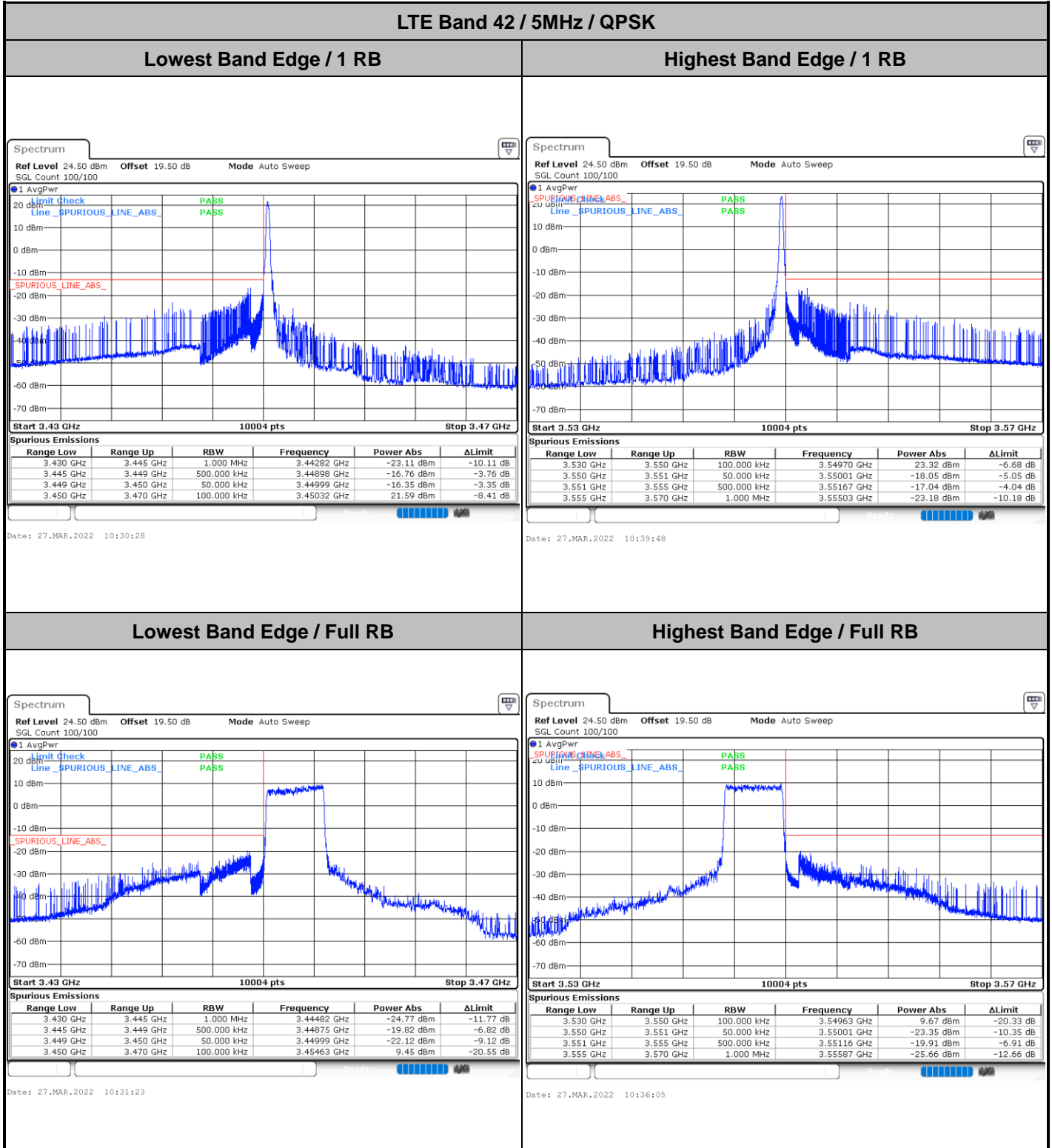



LTE Band 42 / 5MHz / 16QAM

Lowest Band Edge / 1 RB

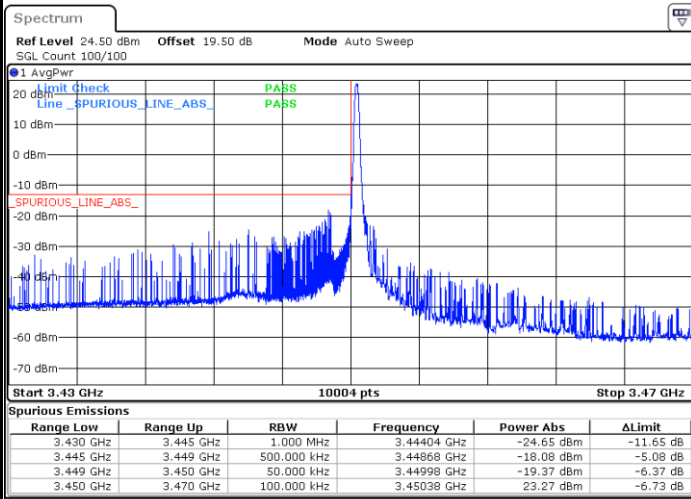

Date: 27.MAR.2022 10:34:20

Highest Band Edge / 1 RB

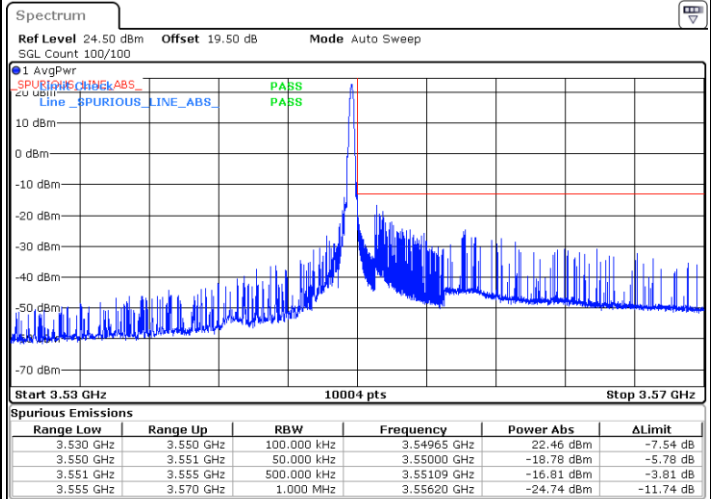

Date: 27.MAR.2022 10:39:22

Lowest Band Edge / Full RB

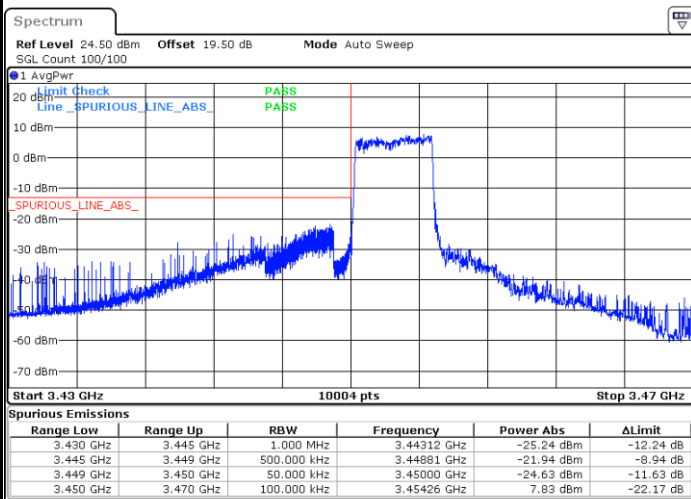

Date: 27.MAR.2022 10:33:24

Highest Band Edge / Full RB

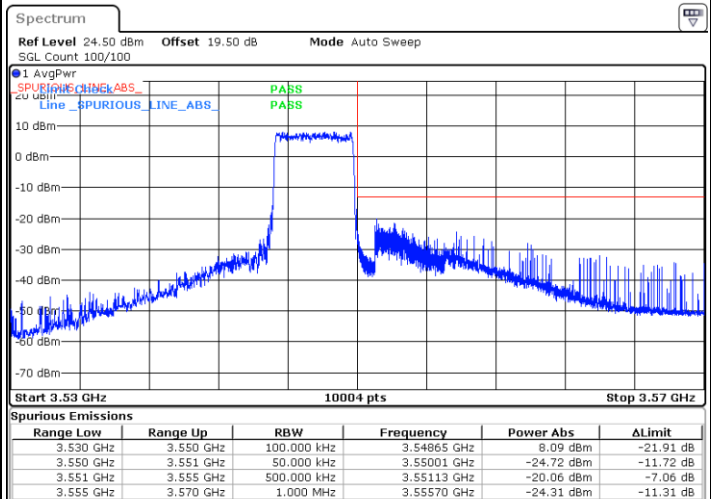

Date: 27.MAR.2022 10:36:30