

Fig.A.6.1.25 Transmitter Spurious Emission - Conducted (802.11g, Ch1, Center Frequency)

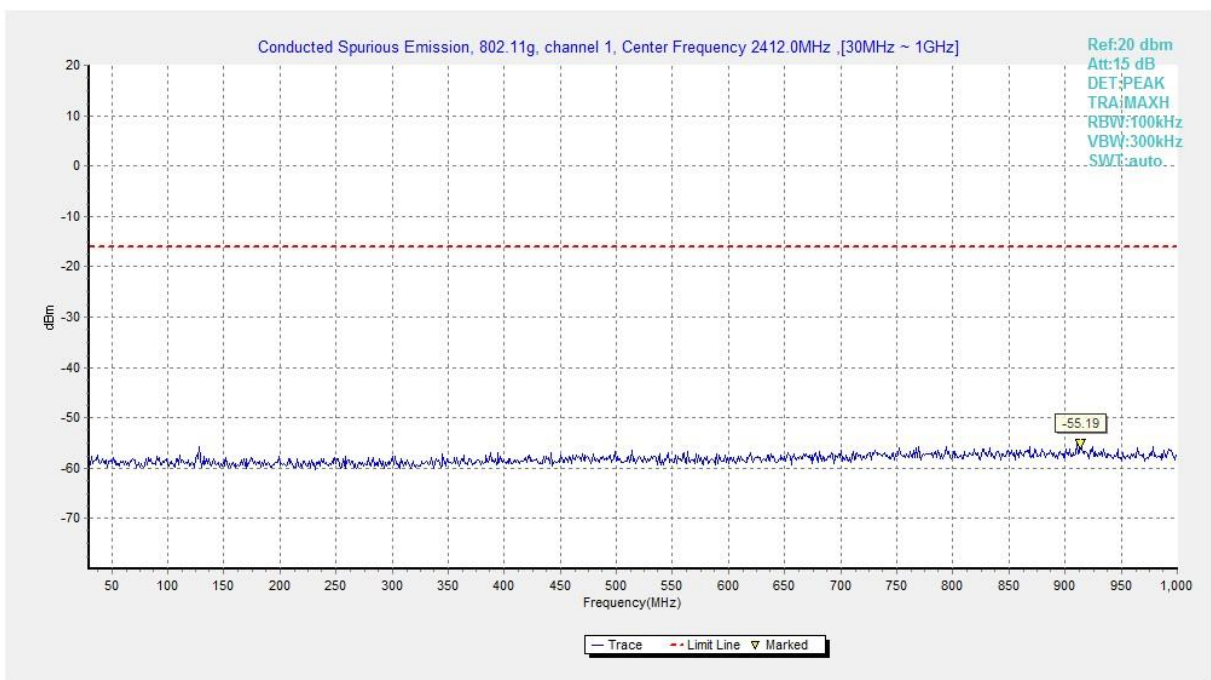

Fig.A.6.1.26 Transmitter Spurious Emission - Conducted (802.11g, Ch1, 30 MHz-1 GHz)

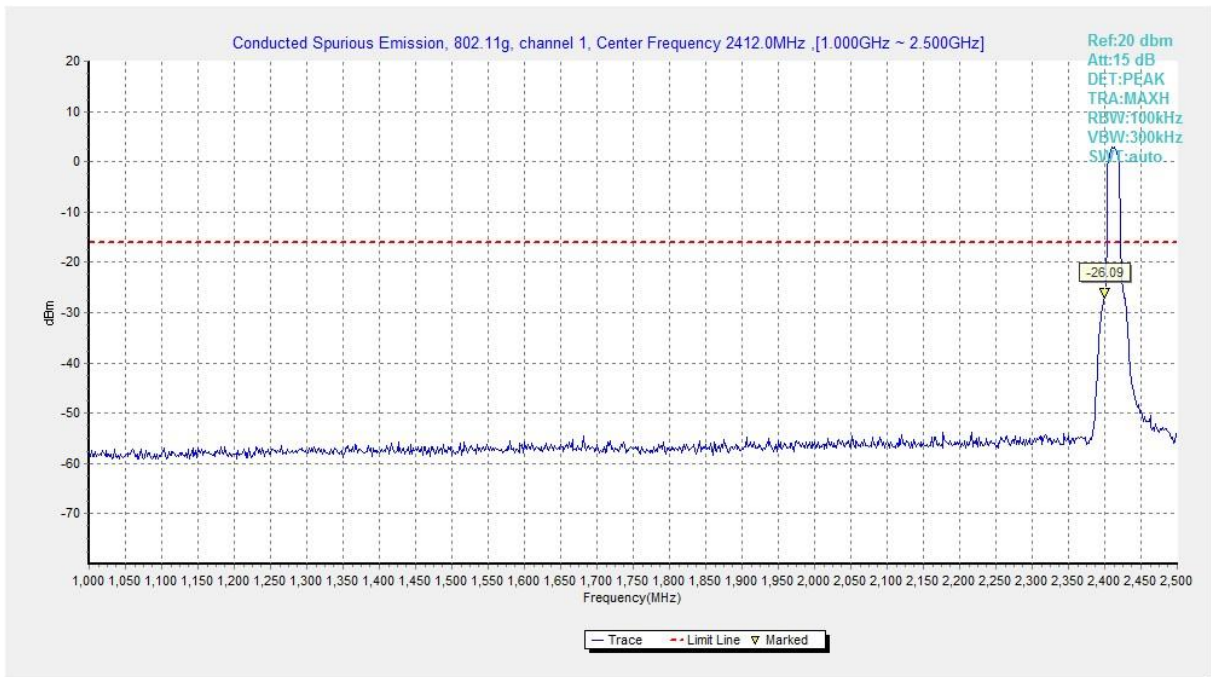

Fig.A.6.1.27 Transmitter Spurious Emission - Conducted (802.11g, Ch1, 1 GHz-2.5 GHz)

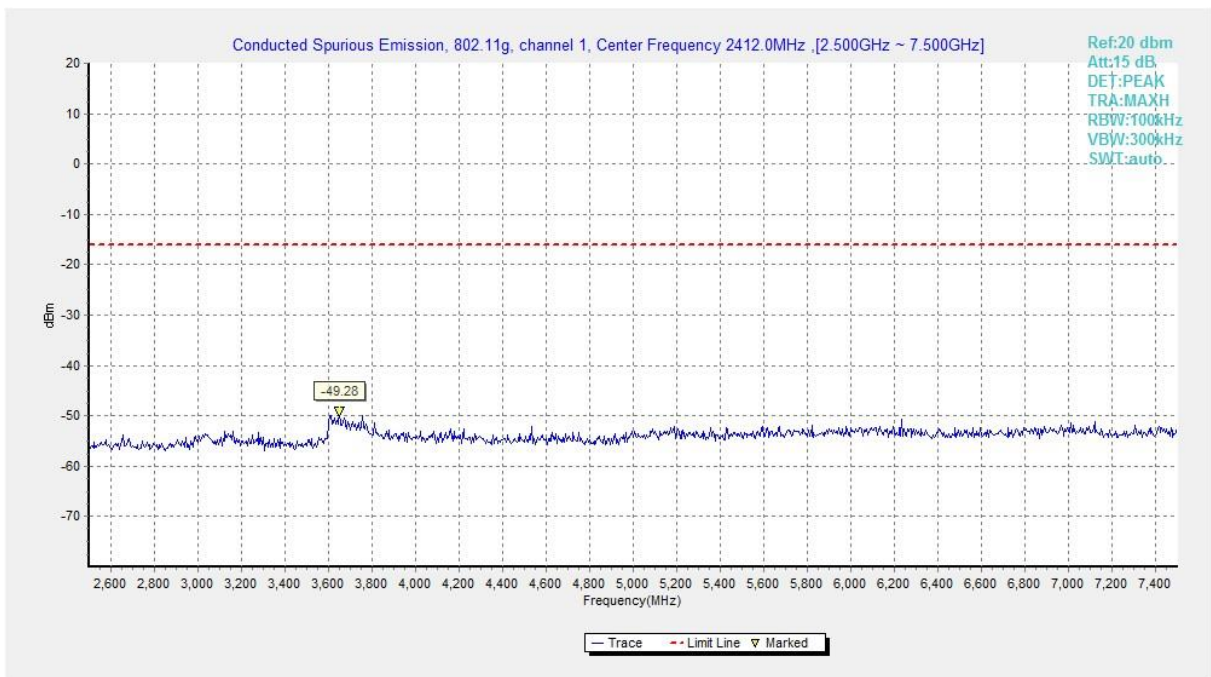

Fig.A.6.1.28 Transmitter Spurious Emission - Conducted (802.11g, Ch1, 2.5 GHz-7.5 GHz)

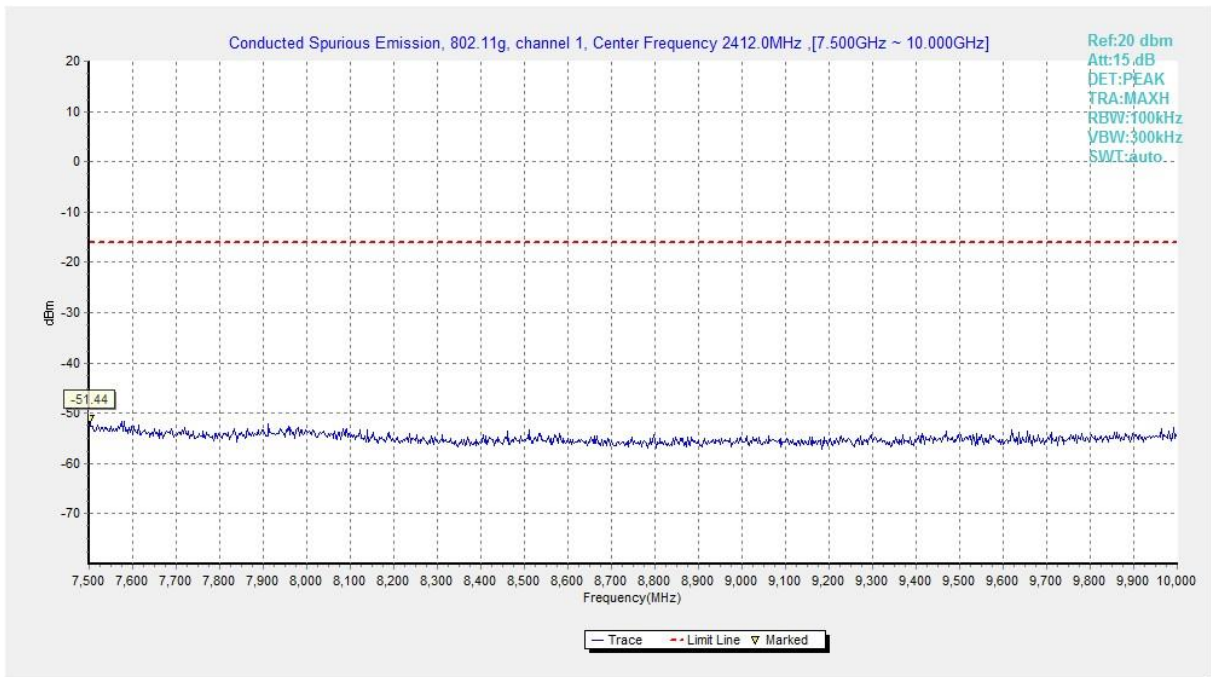

Fig.A.6.1.29 Transmitter Spurious Emission - Conducted (802.11g, Ch1, 7.5 GHz-10 GHz)

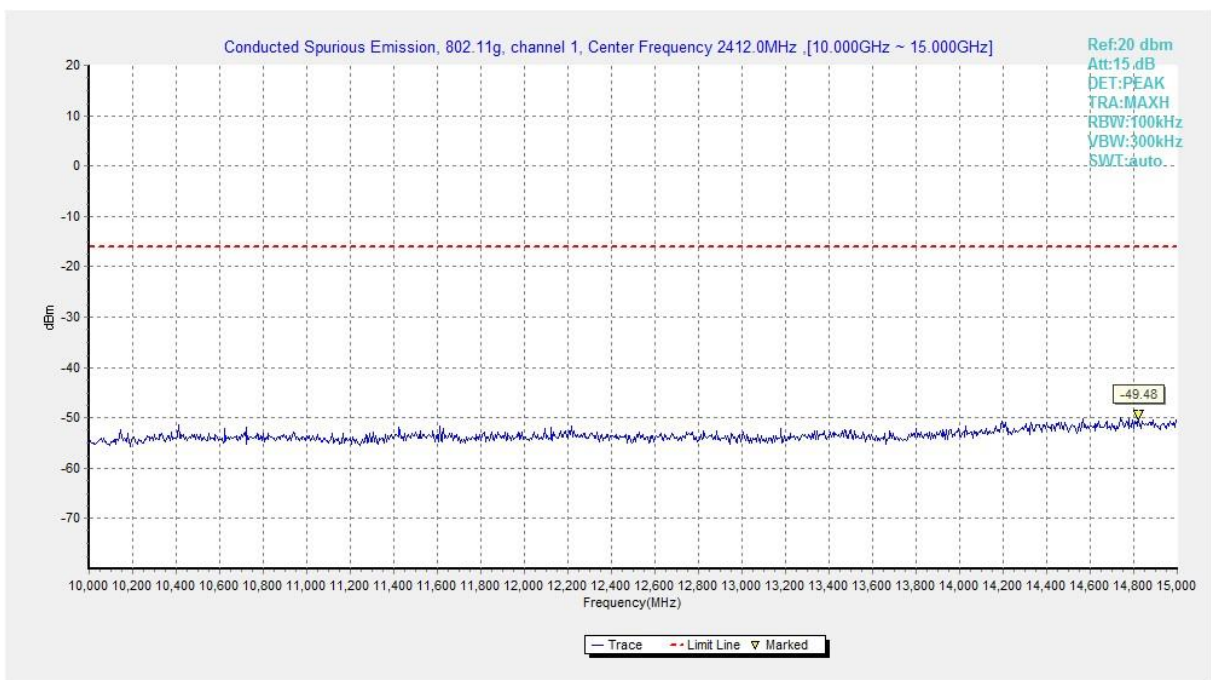

Fig.A.6.1.30 Transmitter Spurious Emission - Conducted (802.11g, Ch1, 10 GHz-15 GHz)

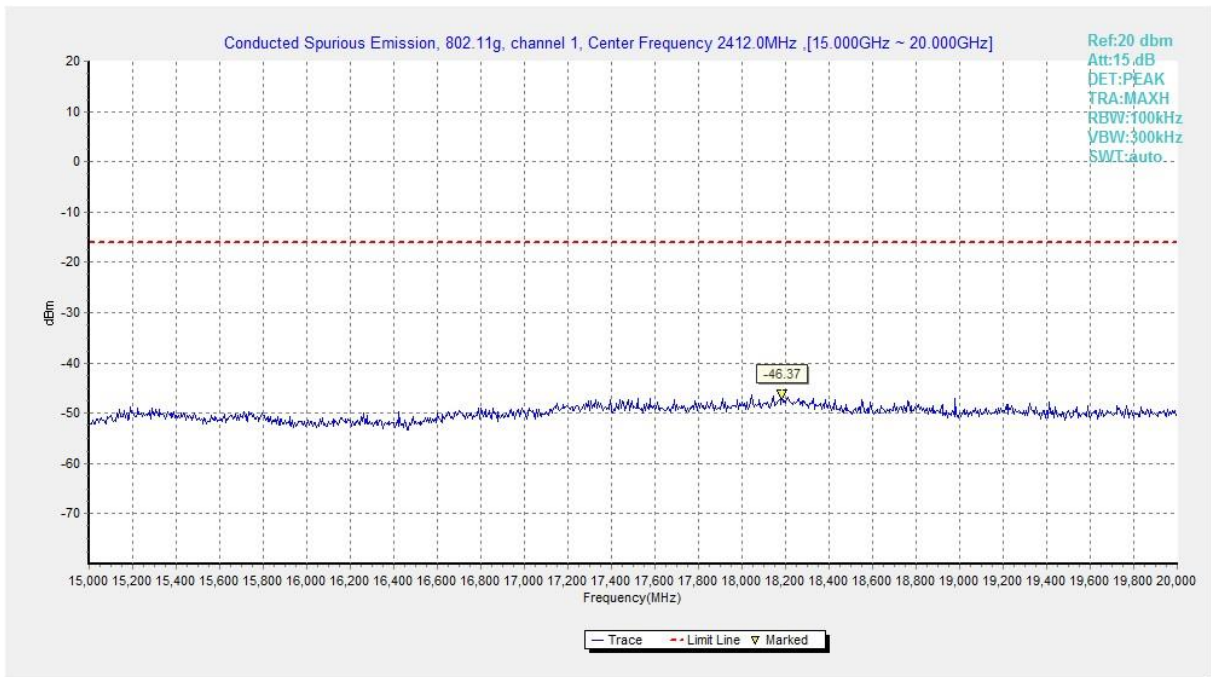

Fig.A.6.1.31 Transmitter Spurious Emission - Conducted (802.11g, Ch1, 15 GHz-20 GHz)

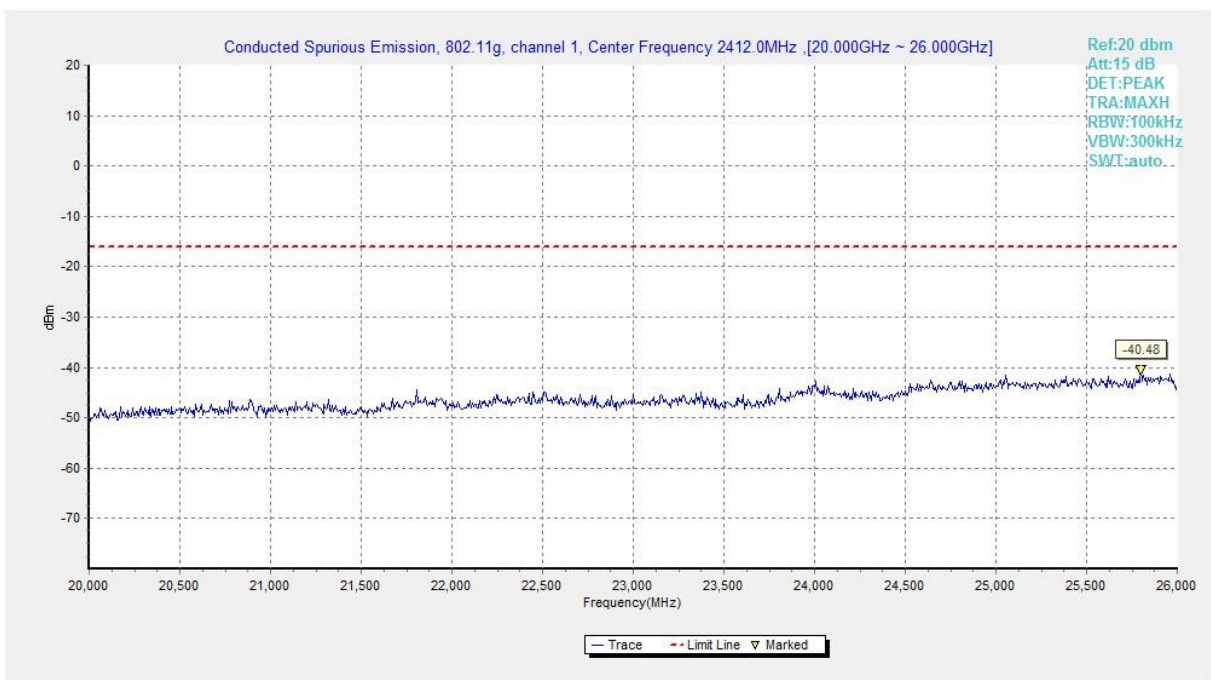

Fig.A.6.1.32 Transmitter Spurious Emission - Conducted (802.11g, Ch1, 20 GHz-26 GHz)

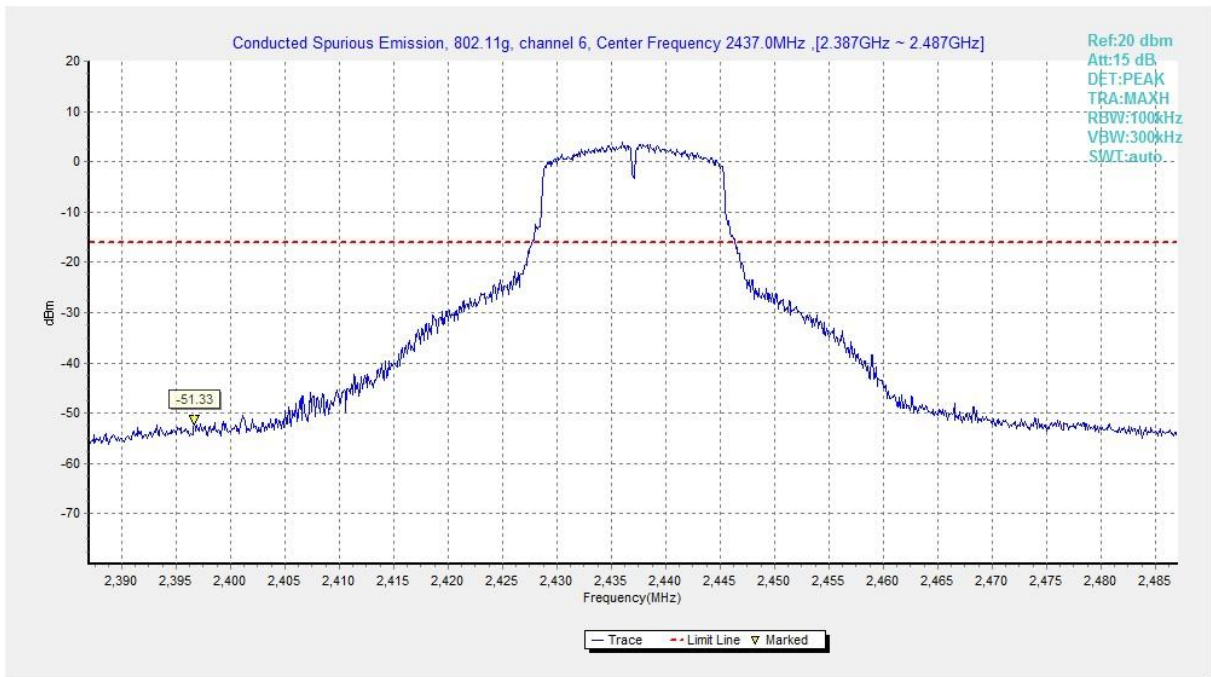

Fig.A.6.1.33 Transmitter Spurious Emission - Conducted (802.11g, Ch6, Center Frequency)

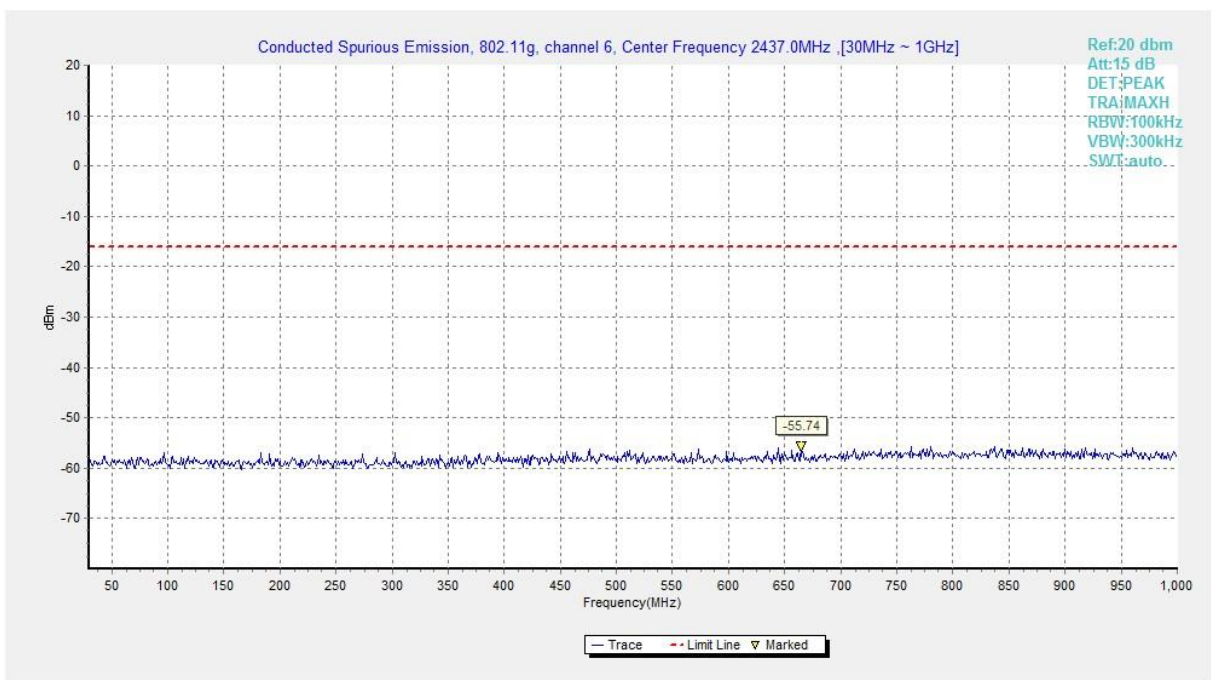

Fig.A.6.1.34 Transmitter Spurious Emission - Conducted (802.11g, Ch6, 30 MHz-1 GHz)

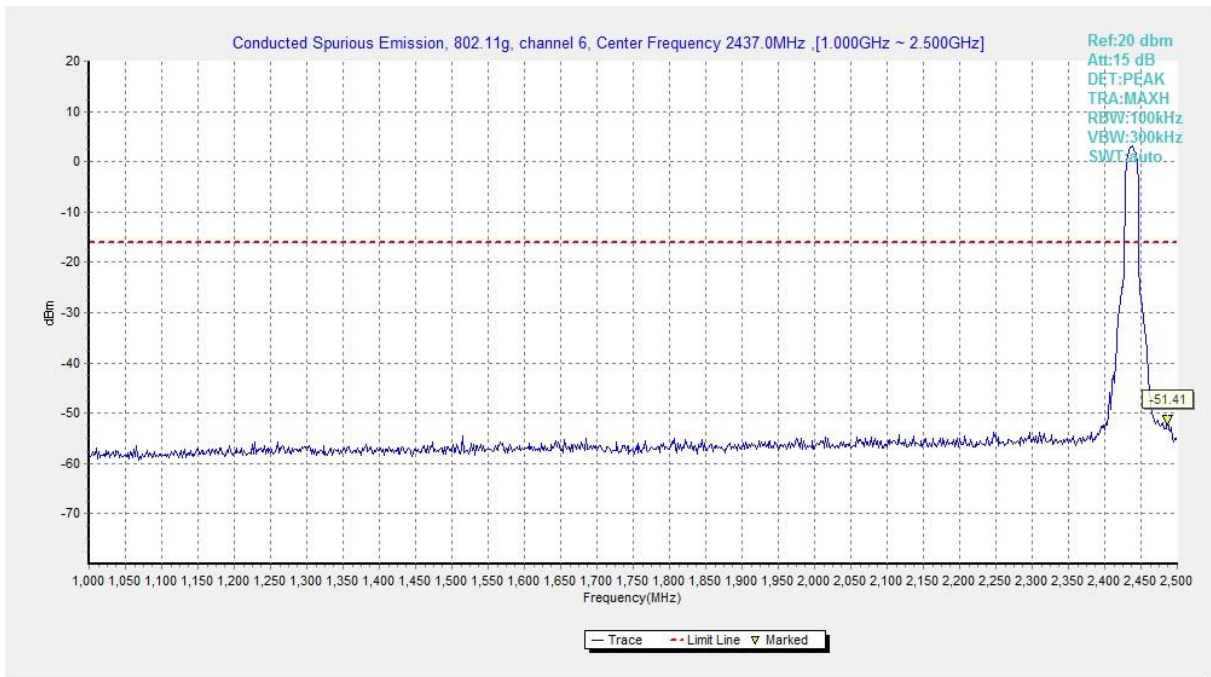

Fig.A.6.1.35 Transmitter Spurious Emission - Conducted (802.11g, Ch6, 1 GHz-2.5 GHz)

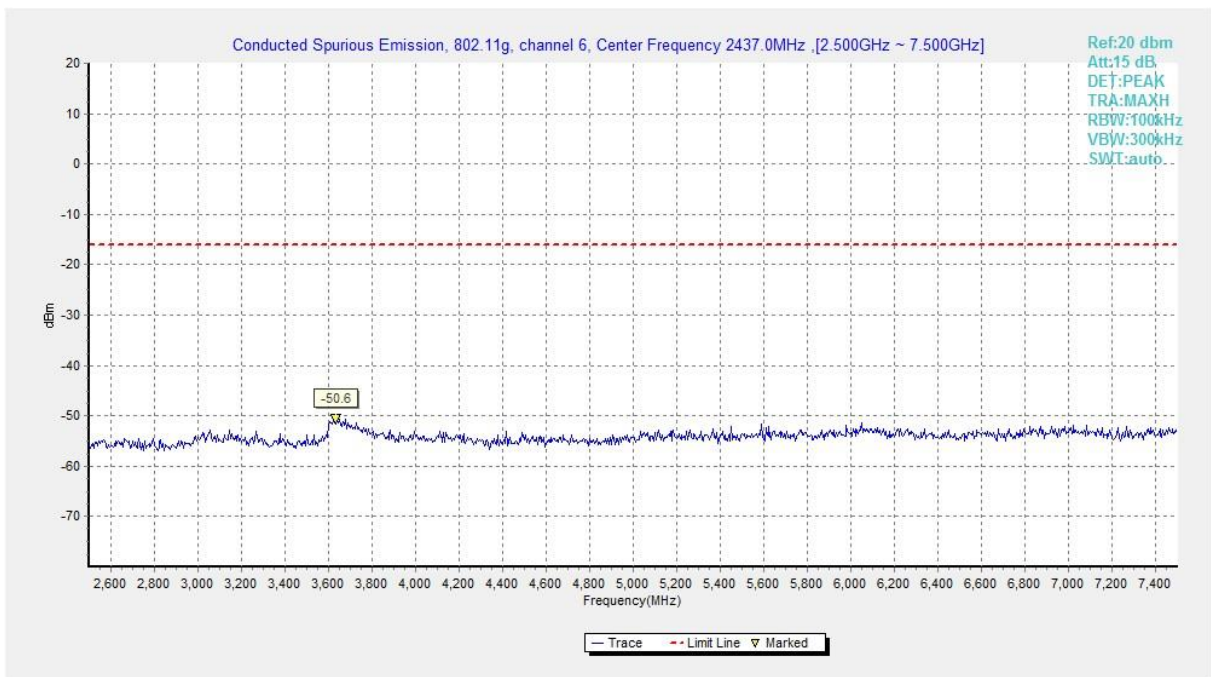

Fig.A.6.1.36 Transmitter Spurious Emission - Conducted (802.11g, Ch6, 2.5 GHz-7.5 GHz)

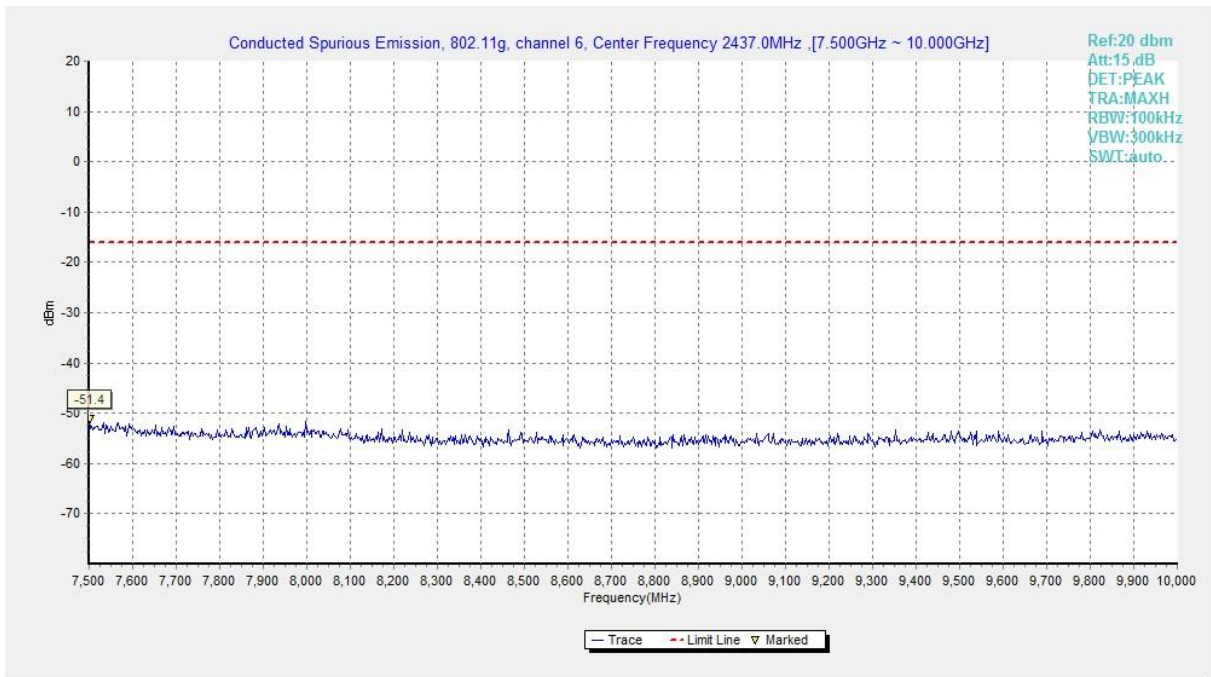

Fig.A.6.1.37 Transmitter Spurious Emission - Conducted (802.11g, Ch6, 7.5 GHz-10 GHz)

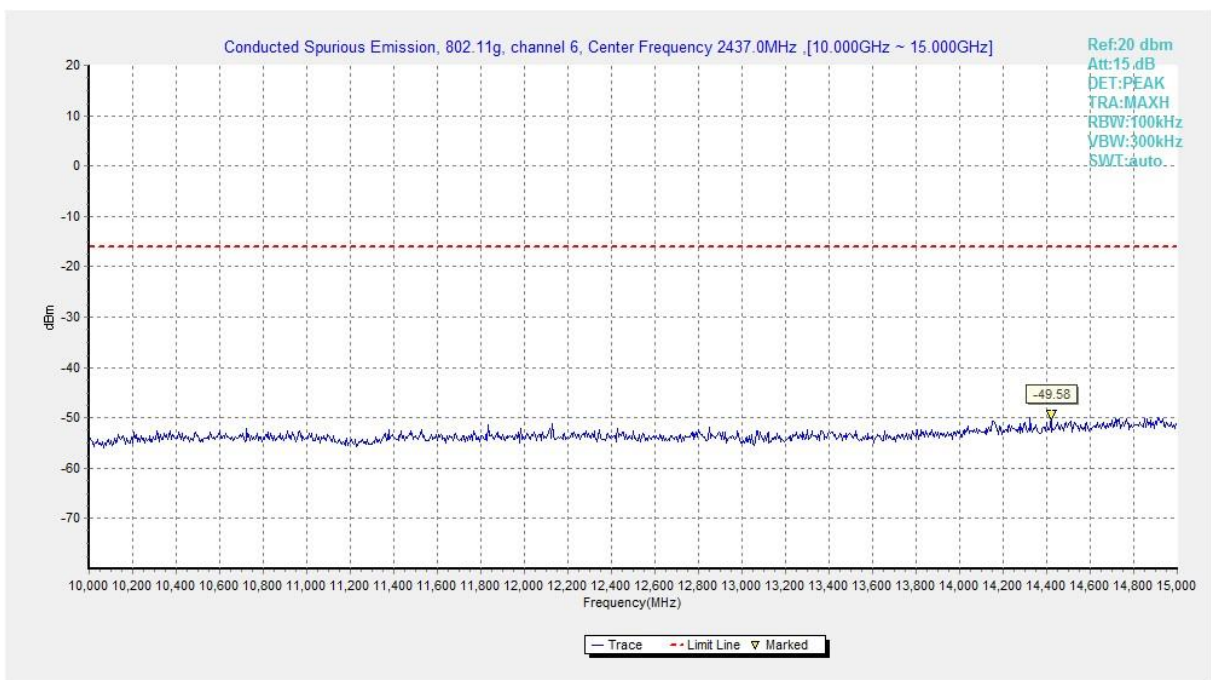

Fig.A.6.1.38 Transmitter Spurious Emission - Conducted (802.11g, Ch6, 10 GHz-15 GHz)

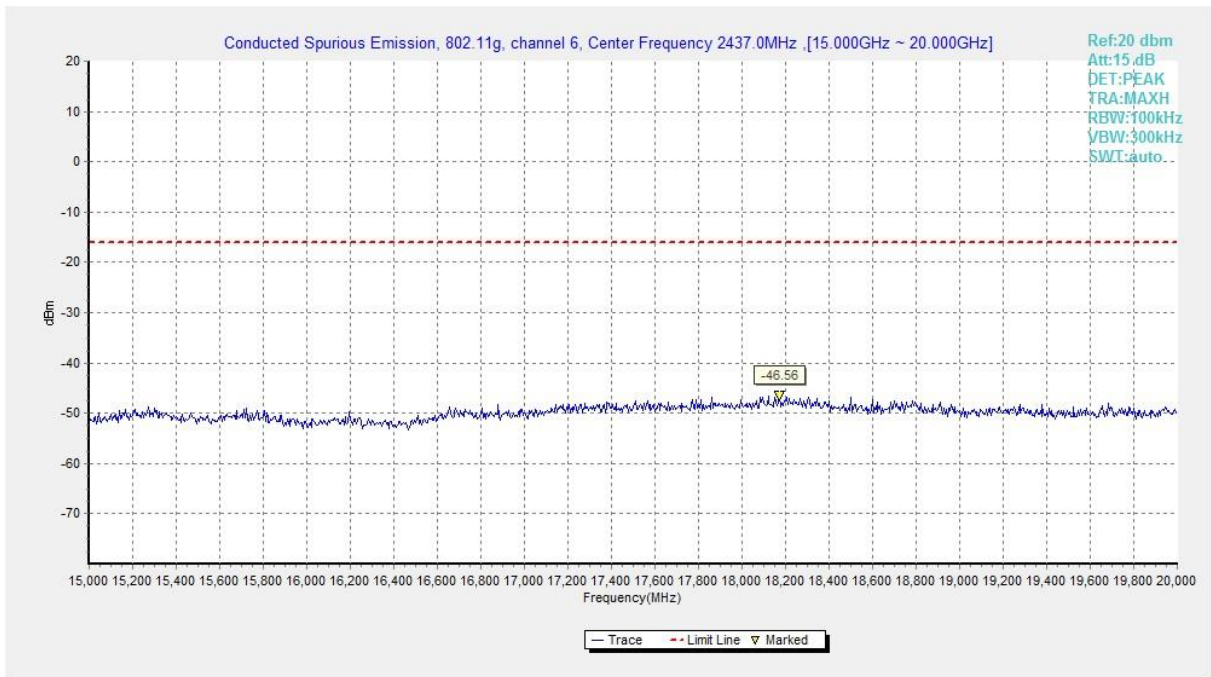

Fig.A.6.1.39 Transmitter Spurious Emission - Conducted (802.11g, Ch6, 15 GHz-20 GHz)

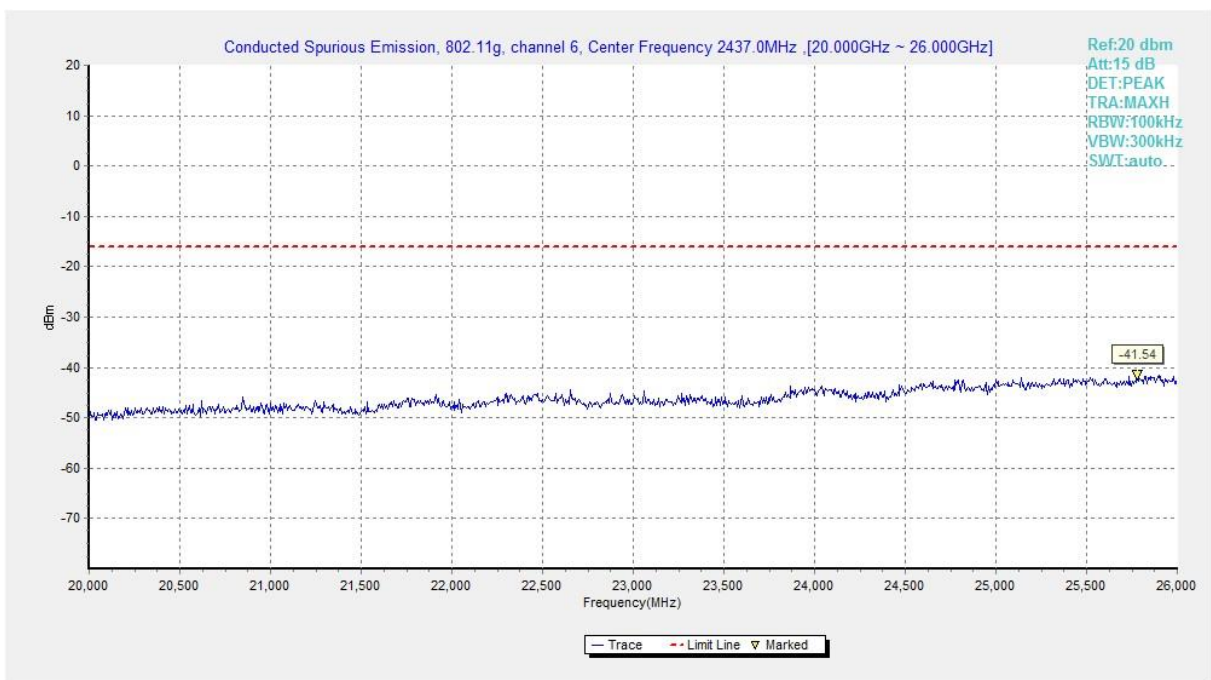

Fig.A.6.1.40 Transmitter Spurious Emission - Conducted (802.11g, Ch6, 20 GHz-26 GHz)

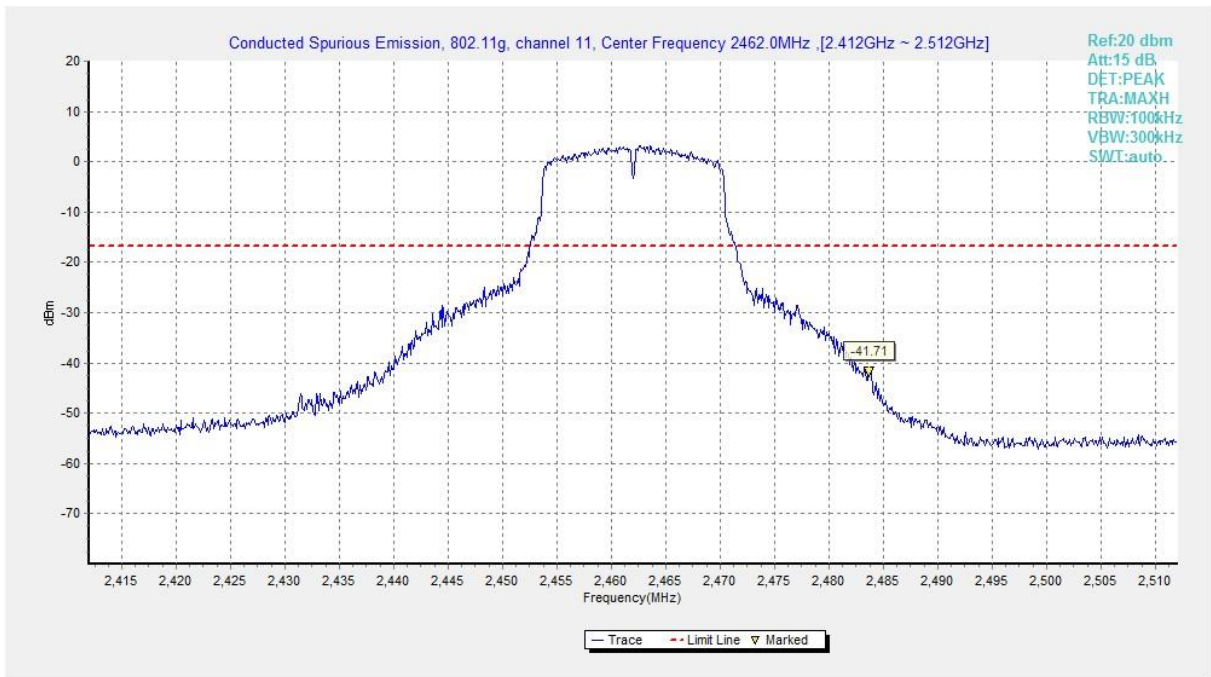

Fig.A.6.1.41 Transmitter Spurious Emission - Conducted (802.11g, Ch11, Center Frequency)

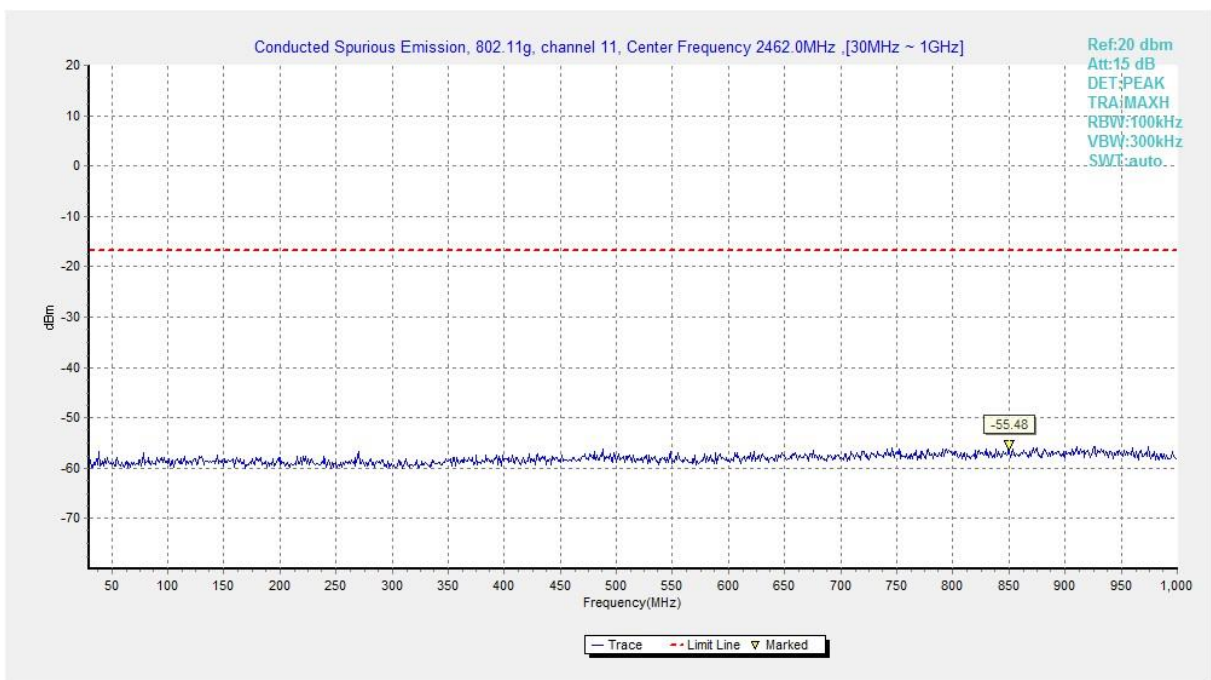

Fig.A.6.1.42 Transmitter Spurious Emission - Conducted (802.11g, Ch11, 30 MHz-1 GHz)

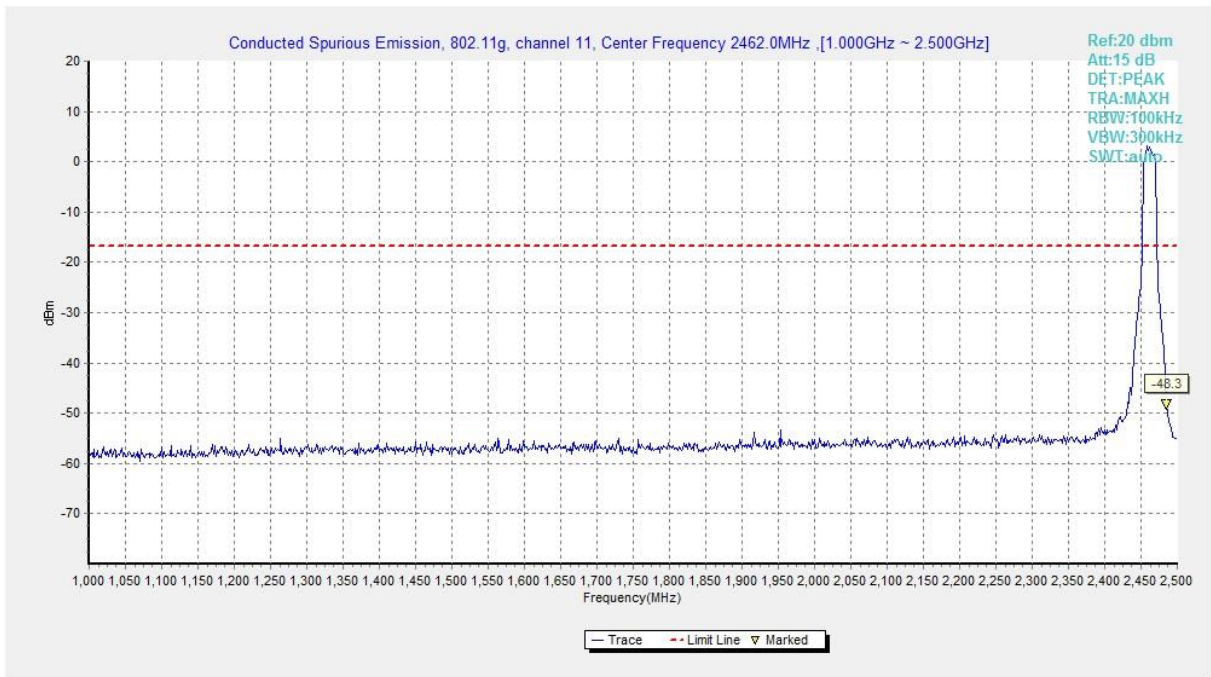

Fig.A.6.1.43 Transmitter Spurious Emission - Conducted (802.11g, Ch11, 1 GHz-2.5 GHz)

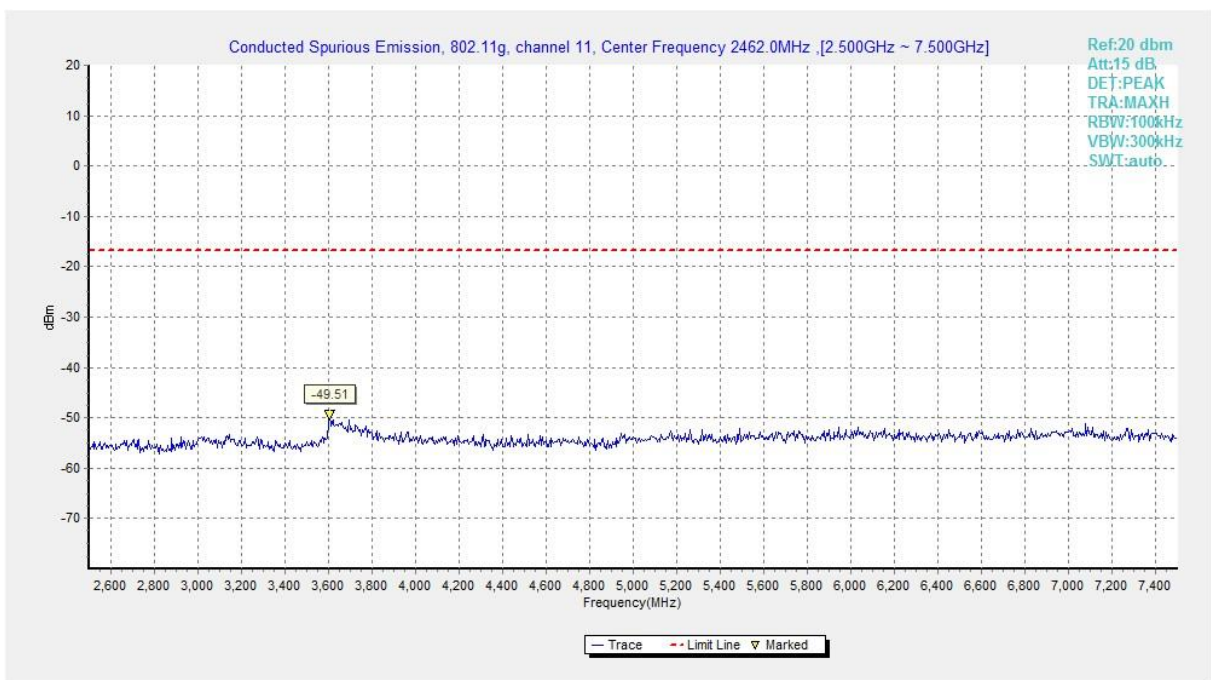

Fig.A.6.1.44 Transmitter Spurious Emission - Conducted (802.11g, Ch11, 2.5 GHz-7.5 GHz)

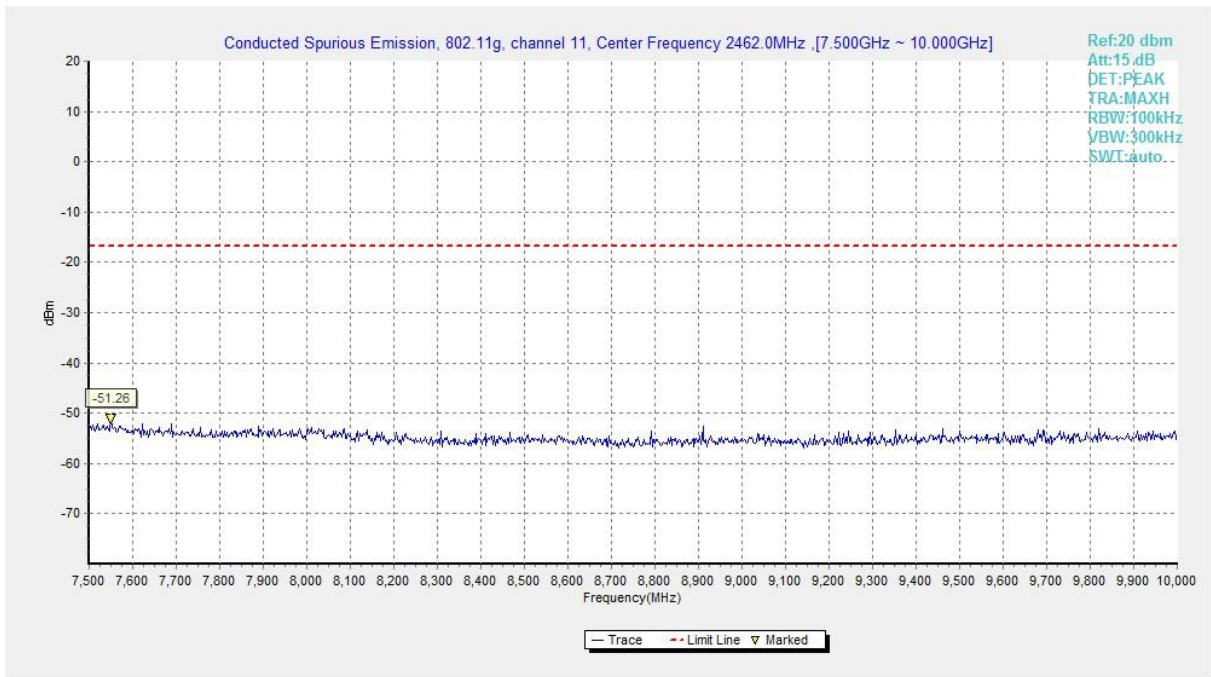

Fig.A.6.1.45 Transmitter Spurious Emission - Conducted (802.11g, Ch11, 7.5 GHz-10 GHz)

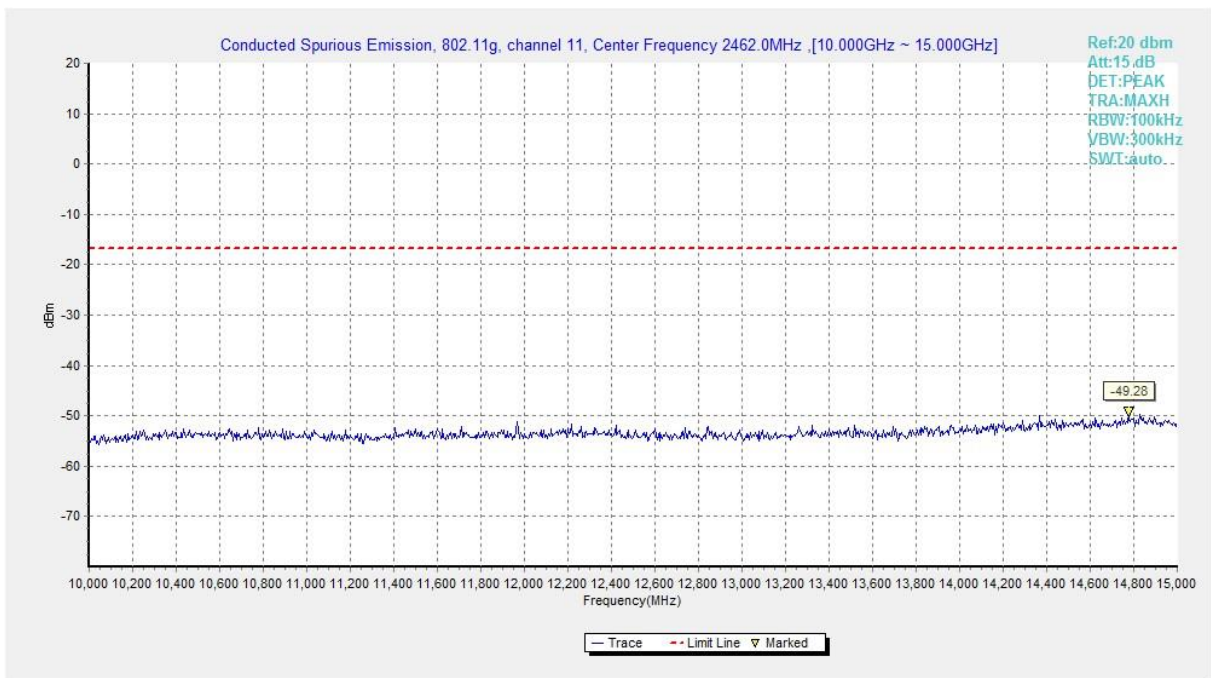

Fig.A.6.1.46 Transmitter Spurious Emission - Conducted (802.11g, Ch11, 10 GHz-15 GHz)

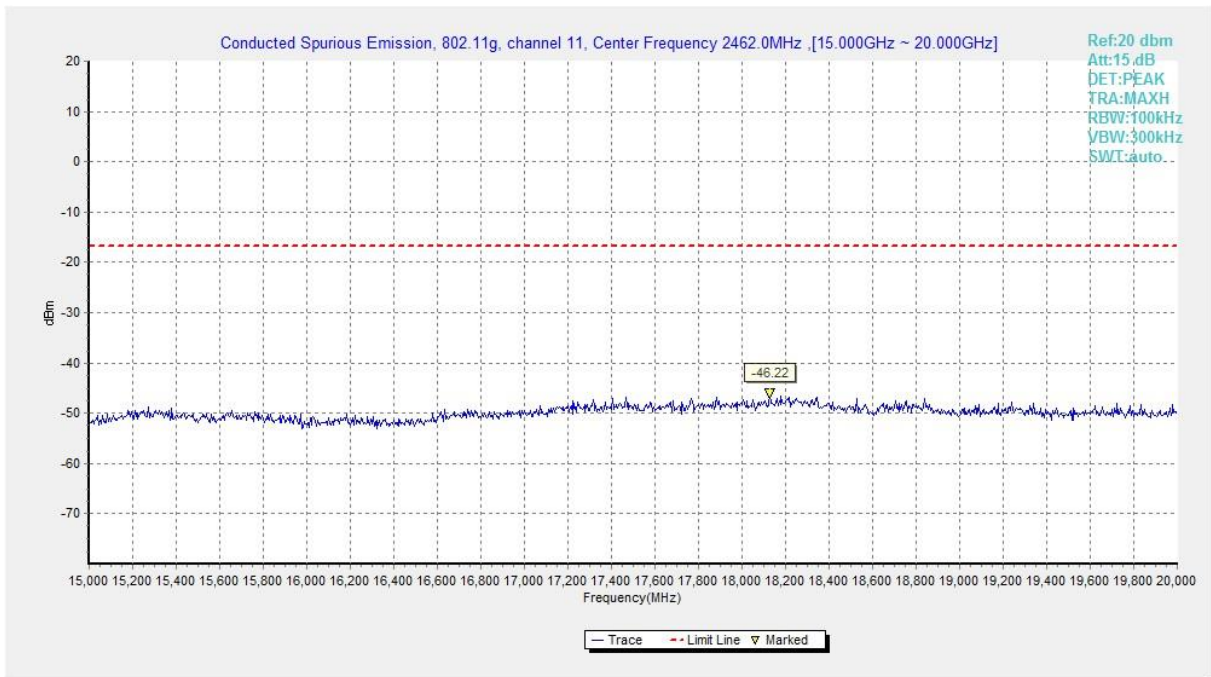

Fig.A.6.1.47 Transmitter Spurious Emission - Conducted (802.11g, Ch11, 15 GHz-20 GHz)

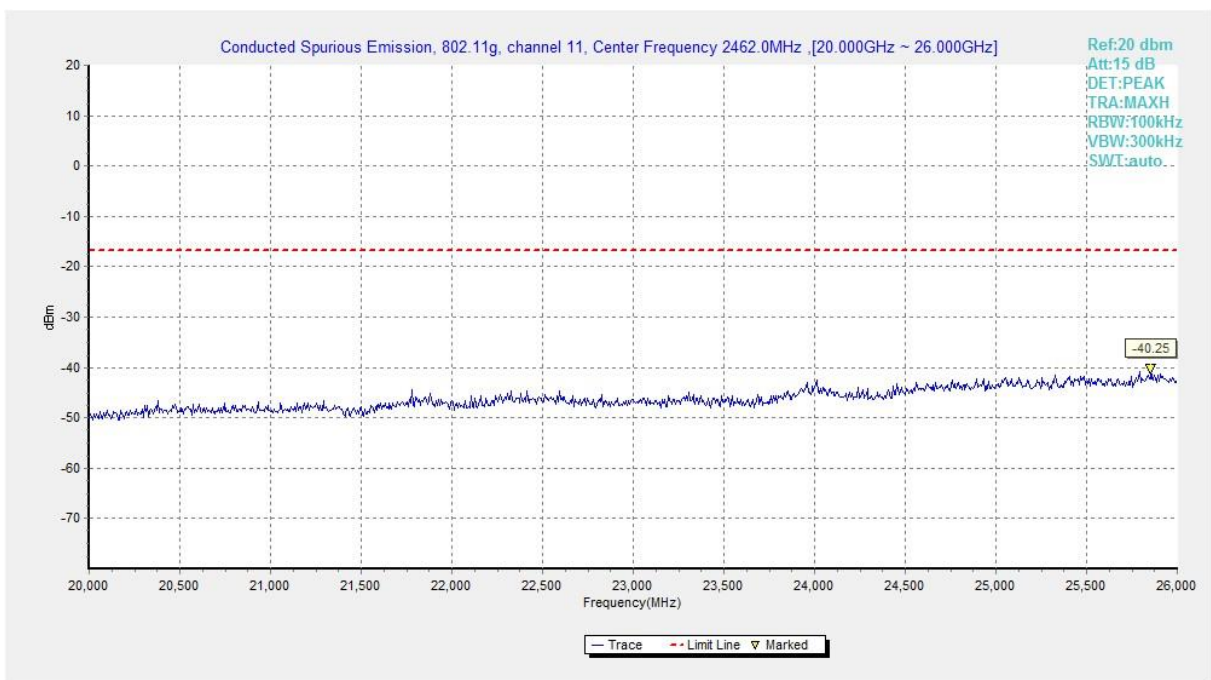

Fig.A.6.1.48 Transmitter Spurious Emission - Conducted (802.11g, Ch11, 20 GHz-26 GHz)

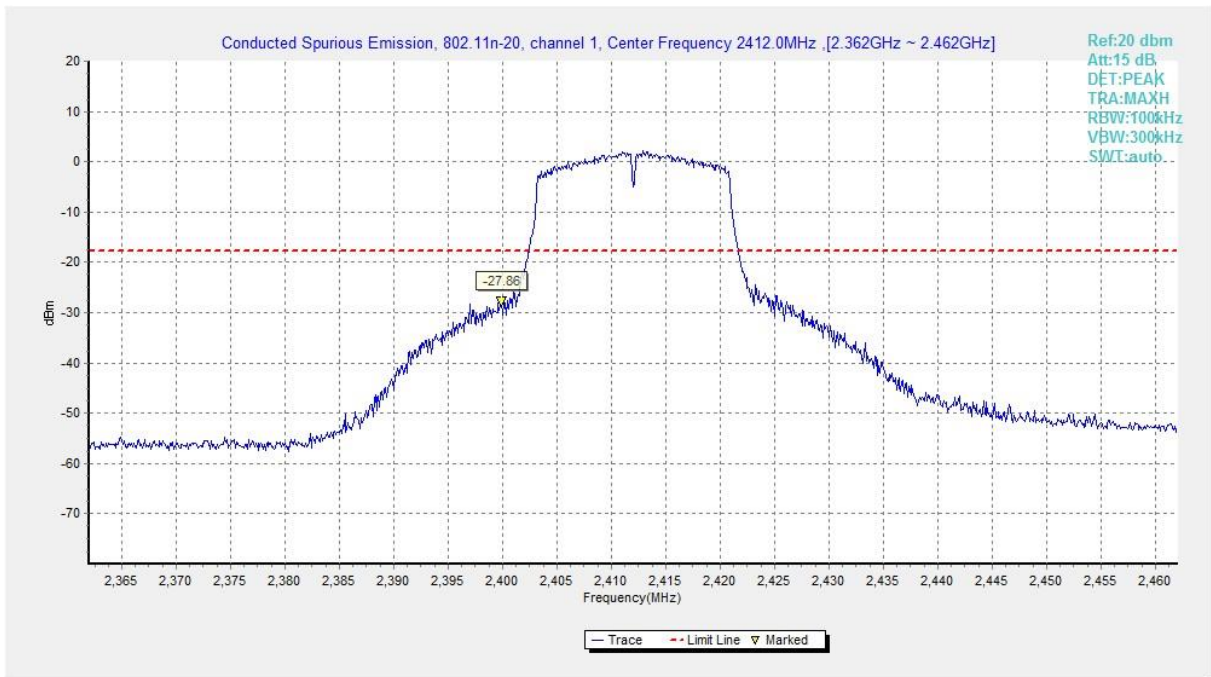

Fig.A.6.1.49 Transmitter Spurious Emission - Conducted (802.11n-HT20, Ch1, Center Frequency)

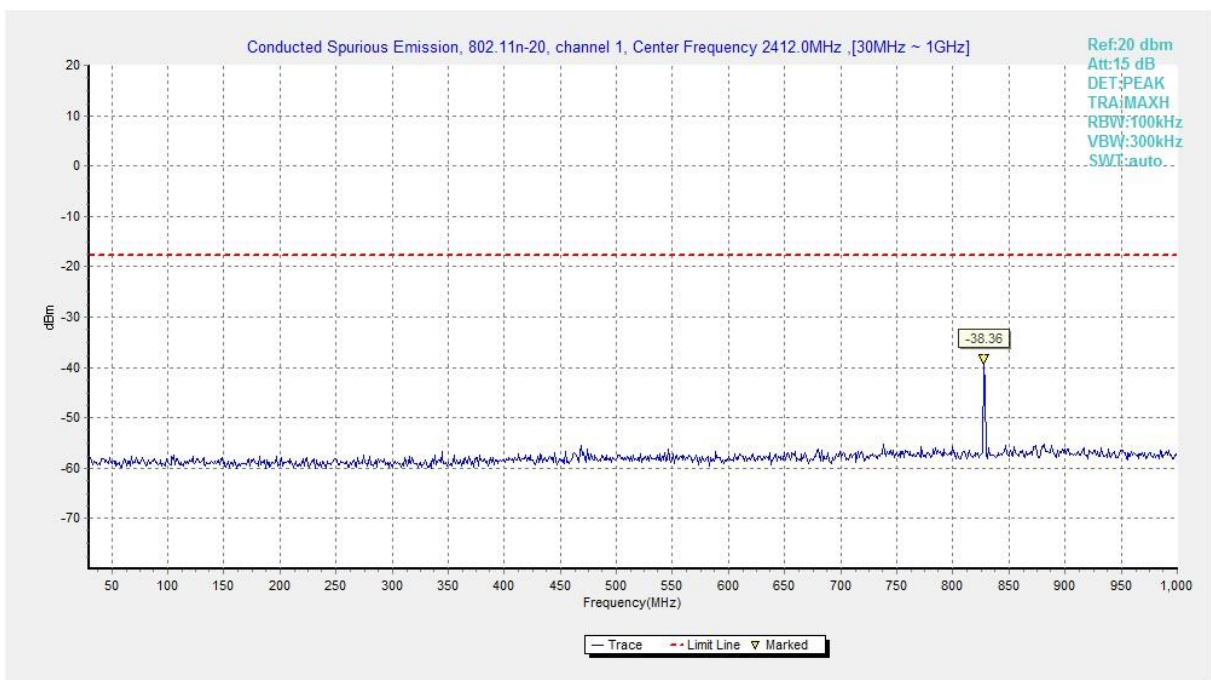

Fig.A.6.1.50 Transmitter Spurious Emission - Conducted (802.11n-HT20, Ch1, 30 MHz-1 GHz)

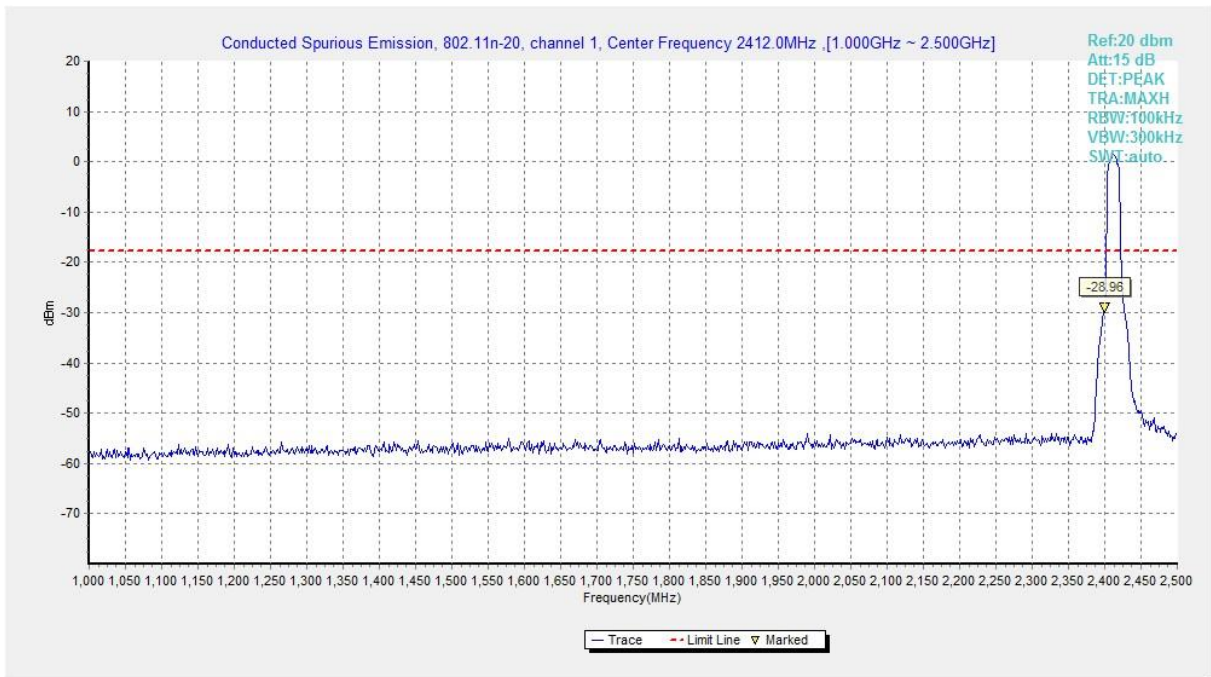

Fig.A.6.1.51 Transmitter Spurious Emission - Conducted (802.11n-HT20, Ch1, 1 GHz-2.5 GHz)

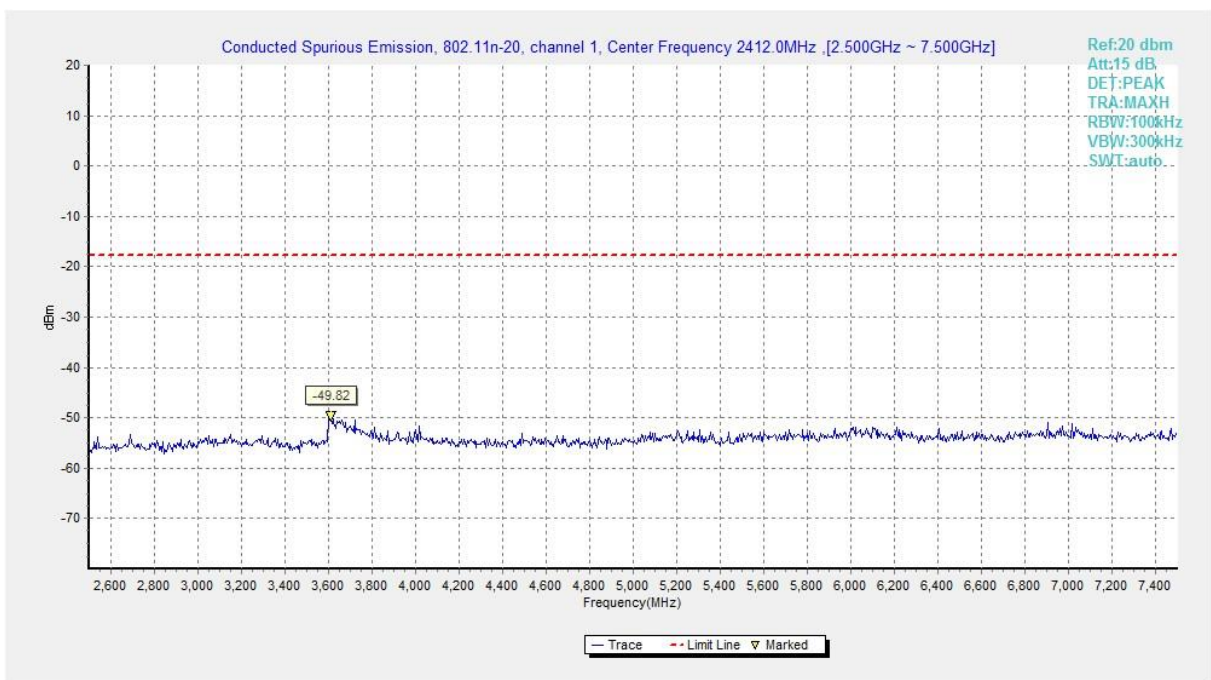

Fig.A.6.1.52 Transmitter Spurious Emission - Conducted (802.11n-HT20, Ch1, 2.5 GHz-7.5 GHz)

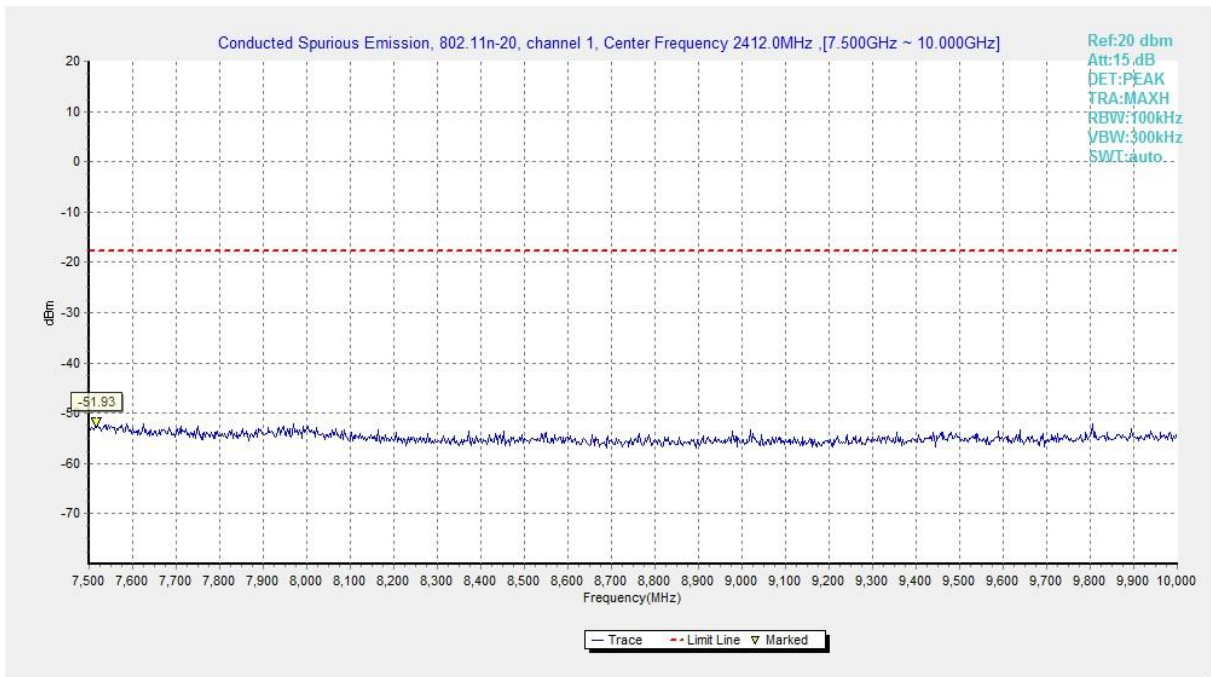

Fig.A.6.1.53 Transmitter Spurious Emission - Conducted (802.11n-HT20, Ch1, 7.5 GHz-10 GHz)

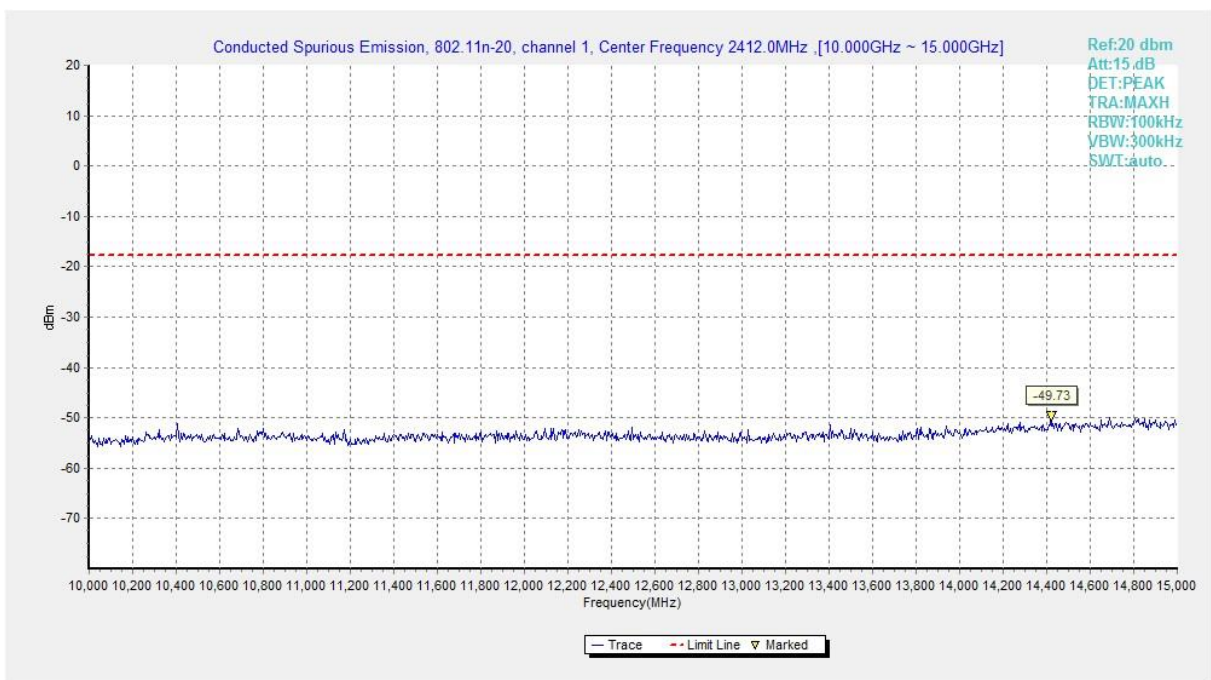

Fig.A.6.1.54 Transmitter Spurious Emission - Conducted (802.11n-HT20, Ch1, 10 GHz-15 GHz)

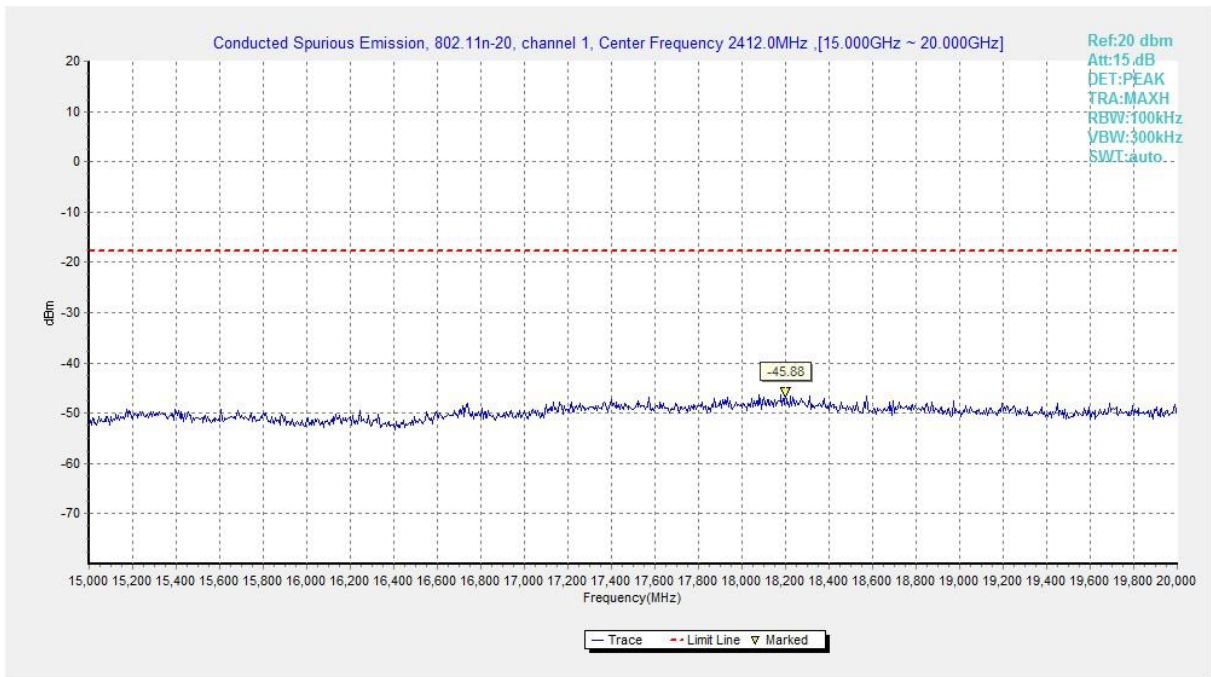

Fig.A.6.1.55 Transmitter Spurious Emission - Conducted (802.11n-HT20, Ch1, 15 GHz-20 GHz)

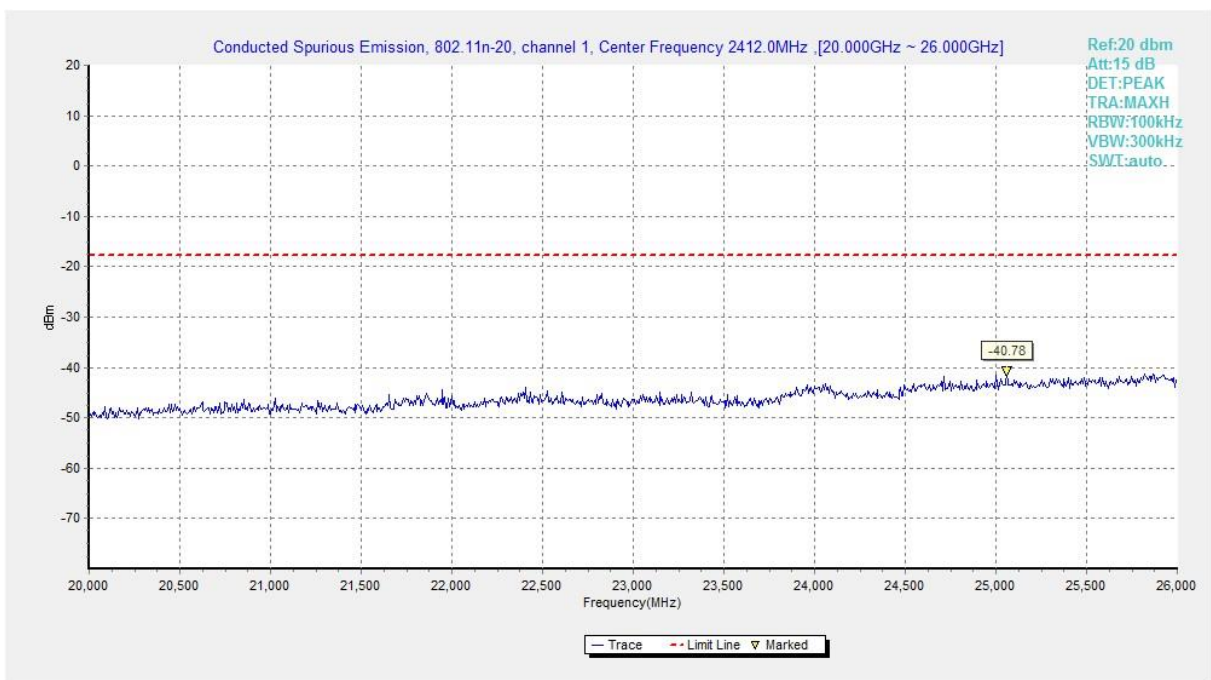

Fig.A.6.1.56 Transmitter Spurious Emission - Conducted (802.11n-HT20, Ch1, 20 GHz-26 GHz)

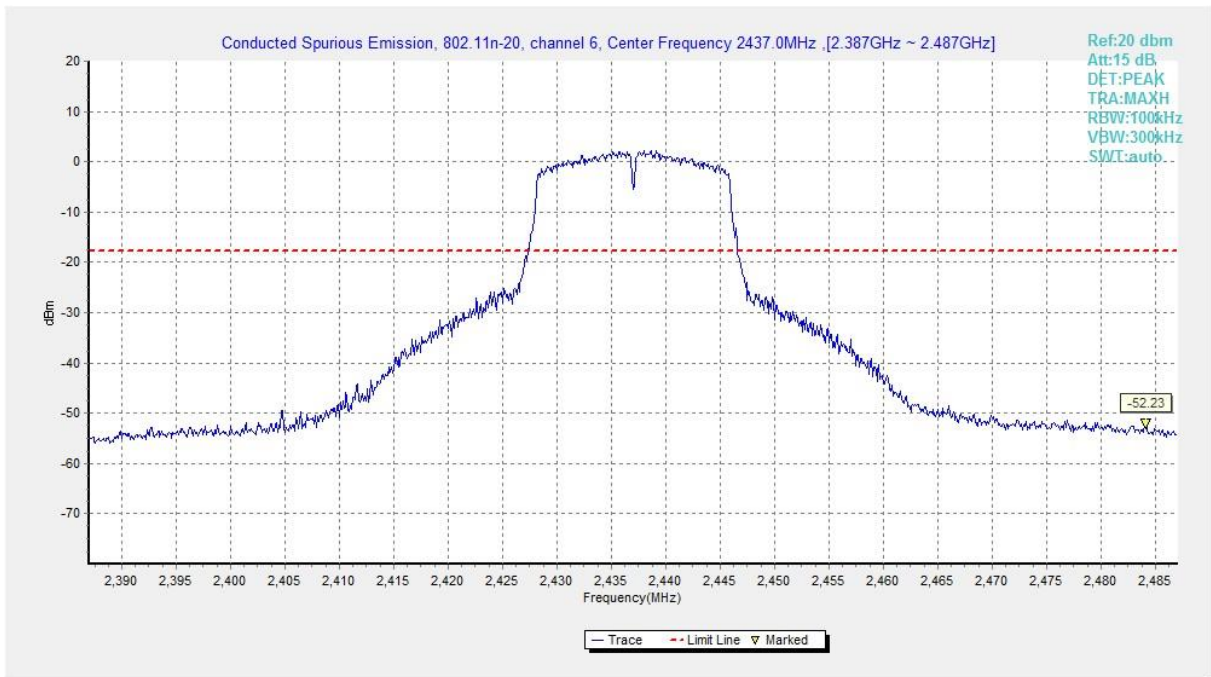

Fig.A.6.1.57 Transmitter Spurious Emission - Conducted (802.11n-HT20, Ch6, Center Frequency)

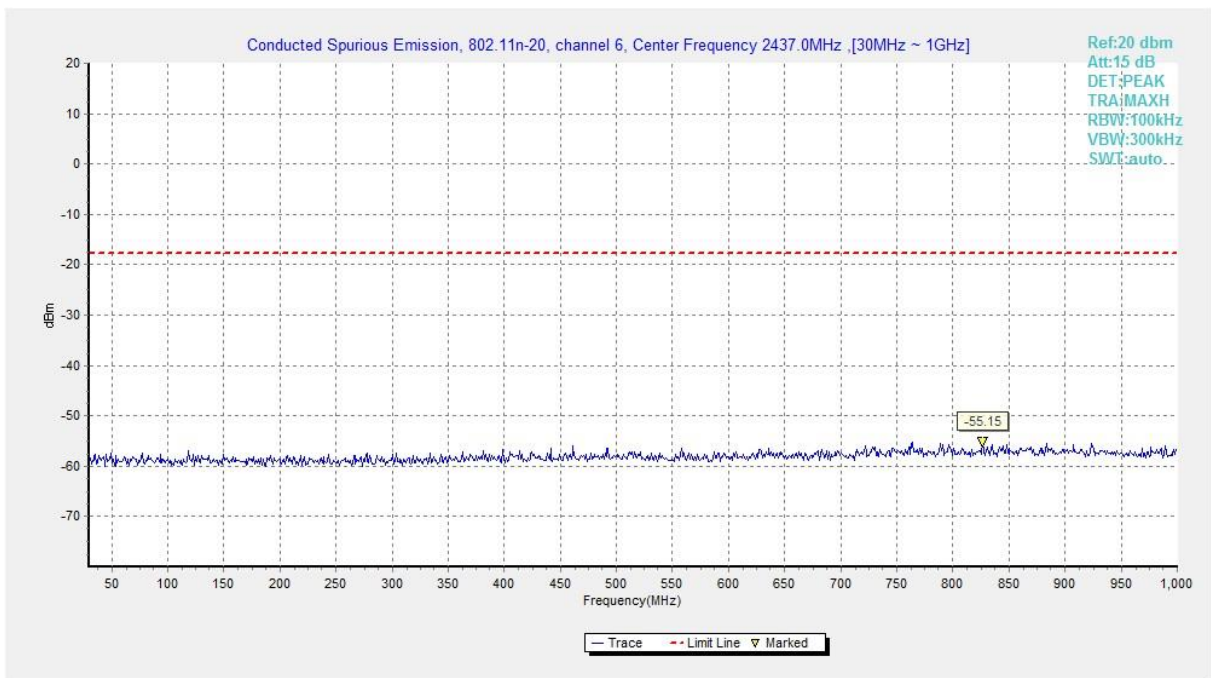

Fig.A.6.1.58 Transmitter Spurious Emission - Conducted (802.11n-HT20, Ch6, 30 MHz-1 GHz)

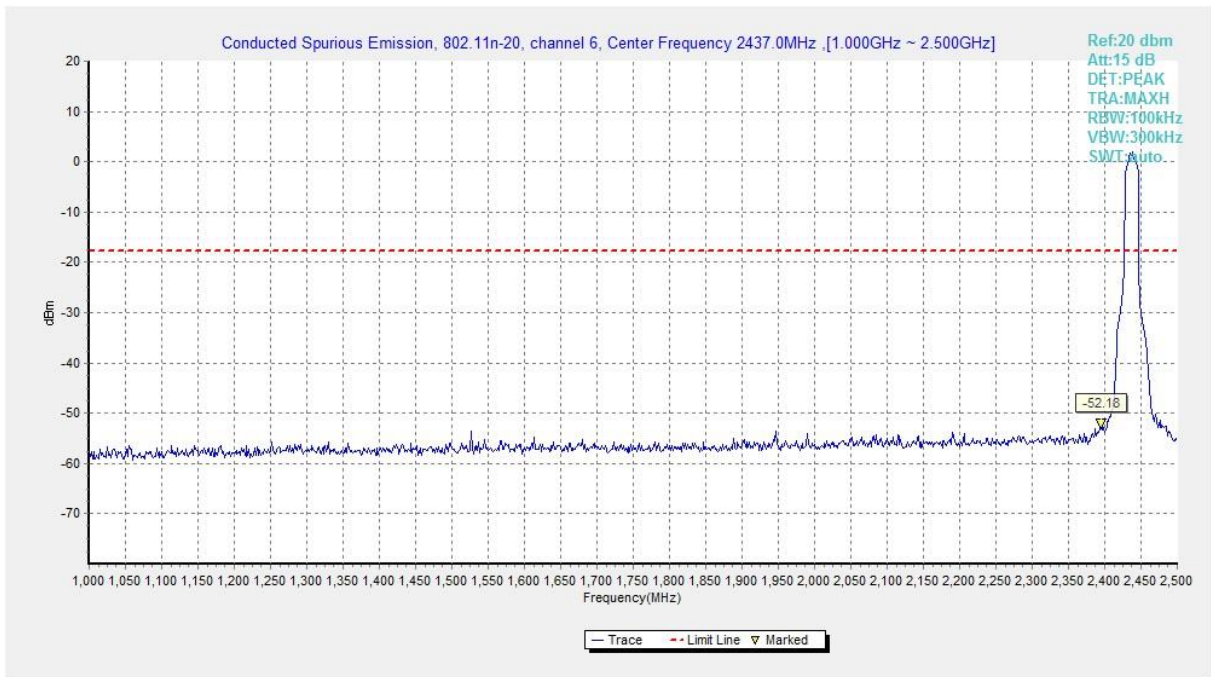

Fig.A.6.1.59 Transmitter Spurious Emission - Conducted (802.11n-HT20, Ch6, 1 GHz-2.5 GHz)

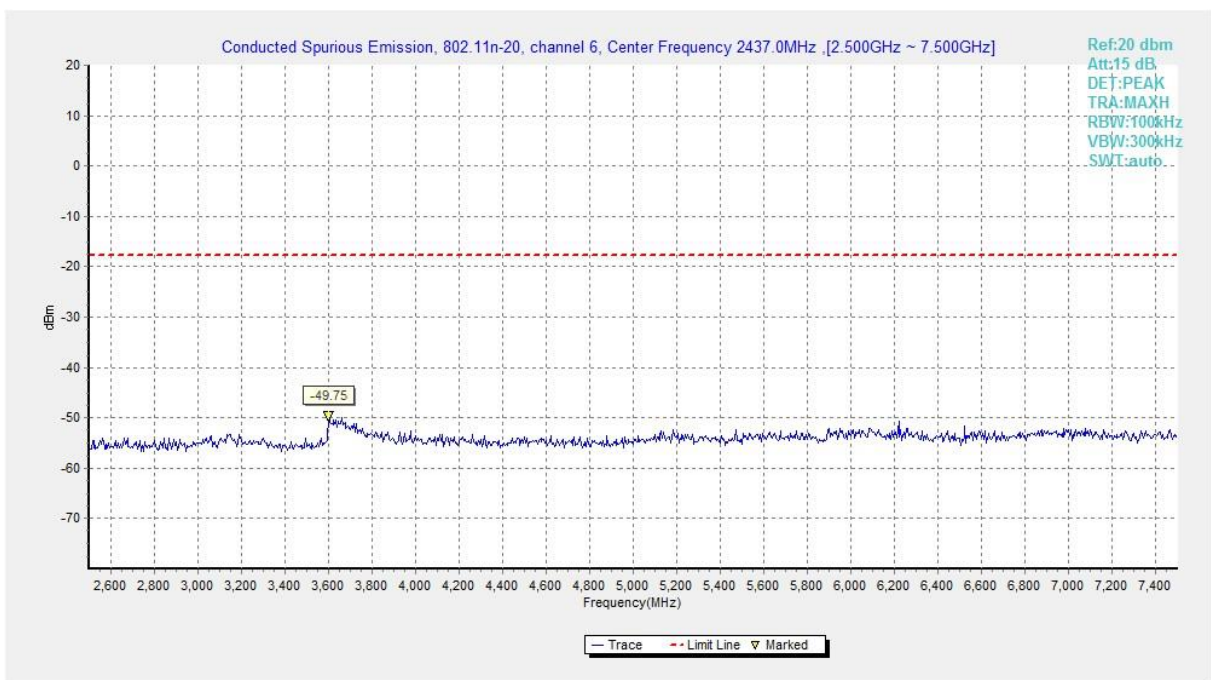

Fig.A.6.1.60 Transmitter Spurious Emission - Conducted (802.11n-HT20, Ch6, 2.5 GHz-7.5 GHz)

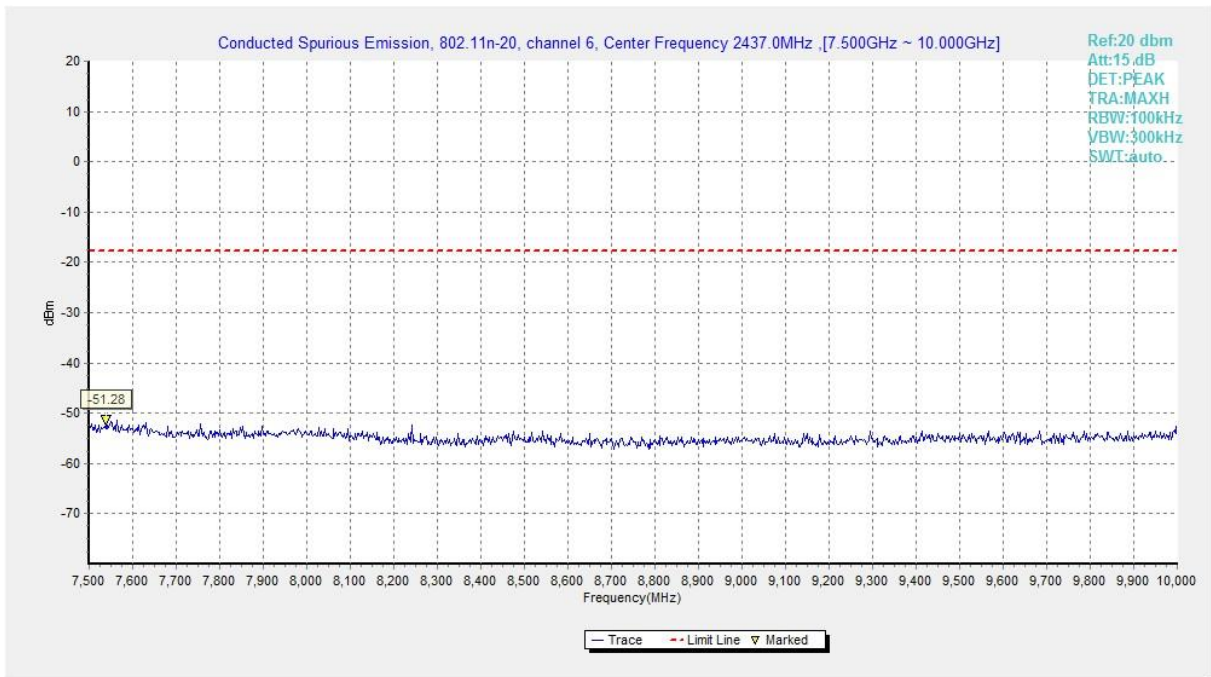

Fig.A.6.1.61 Transmitter Spurious Emission - Conducted (802.11n-HT20, Ch6, 7.5 GHz-10 GHz)

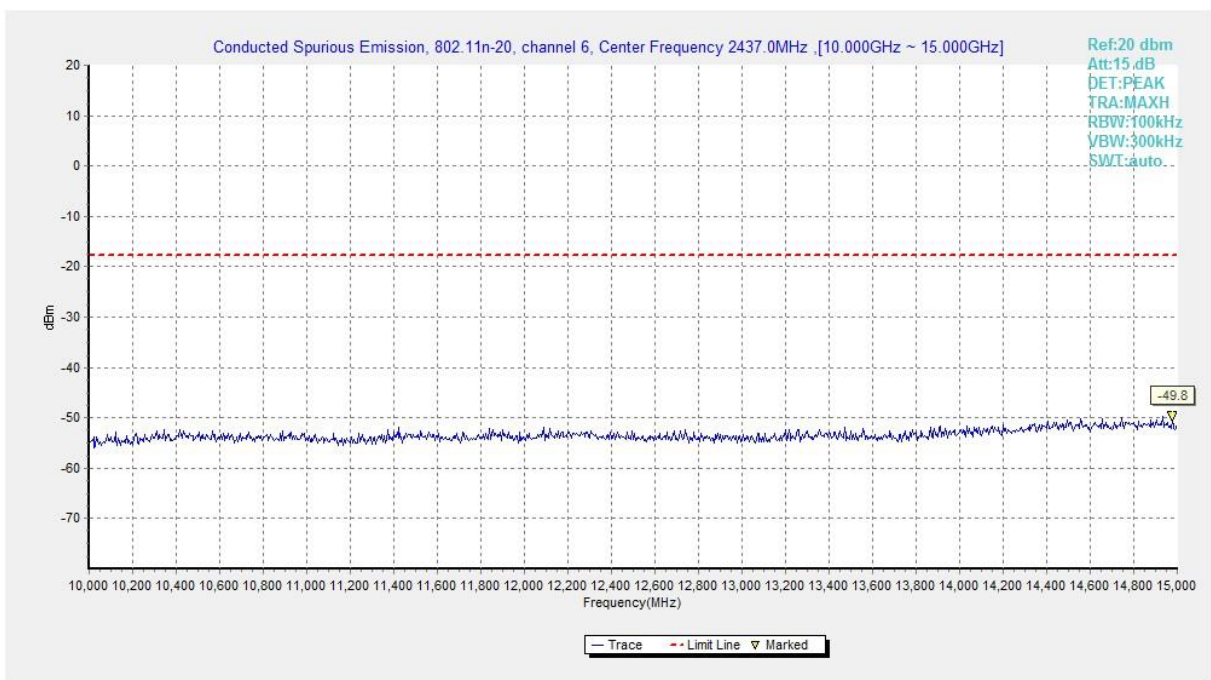

Fig.A.6.1.62 Transmitter Spurious Emission - Conducted (802.11n-HT20, Ch6, 10 GHz-15 GHz)

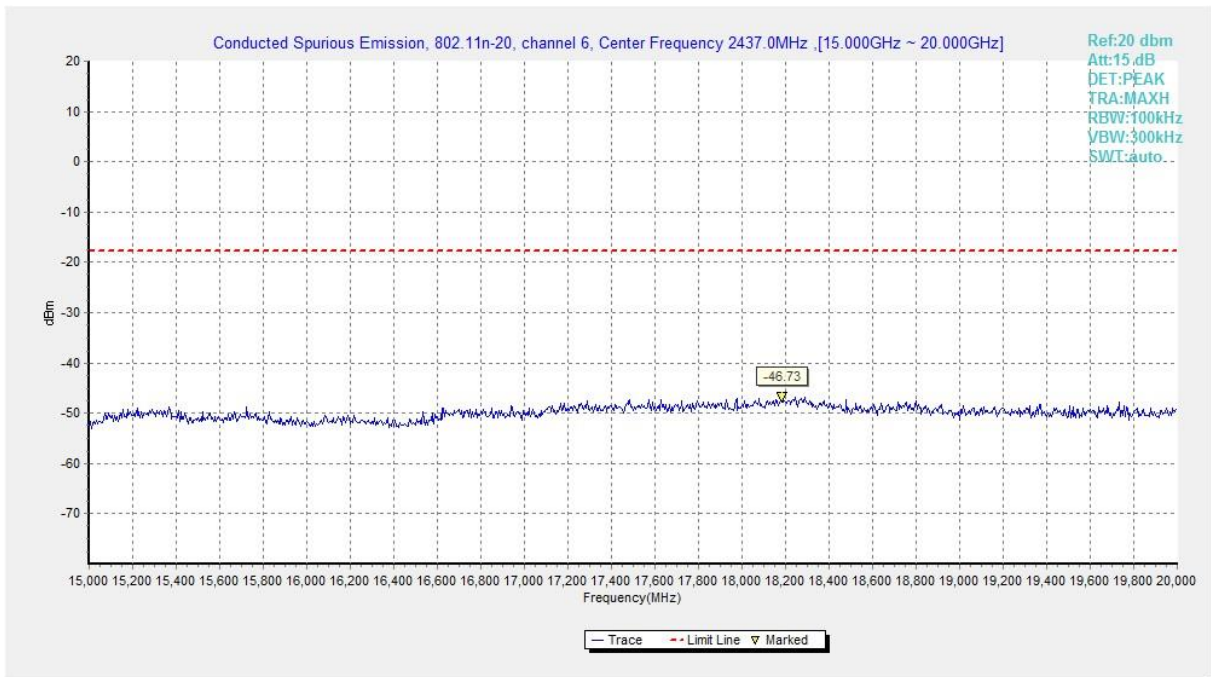

Fig.A.6.1.63 Transmitter Spurious Emission - Conducted (802.11n-HT20, Ch6, 15 GHz-20 GHz)

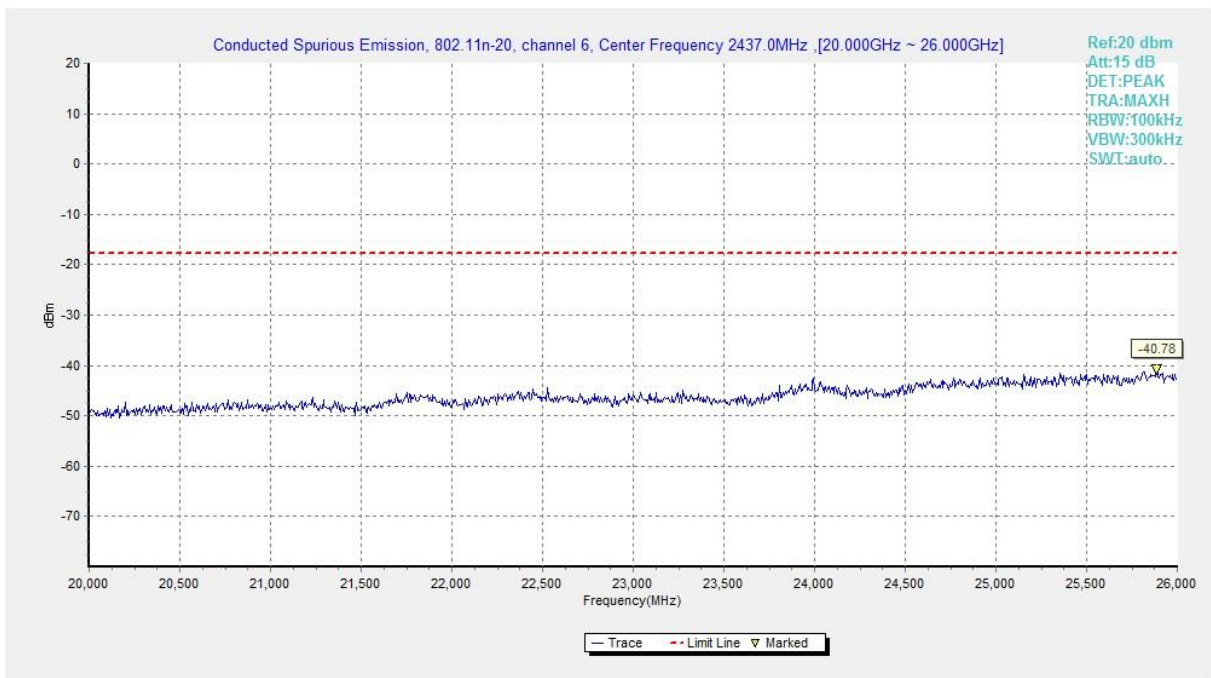

Fig.A.6.1.64 Transmitter Spurious Emission - Conducted (802.11n-HT20, Ch6, 20 GHz-26 GHz)

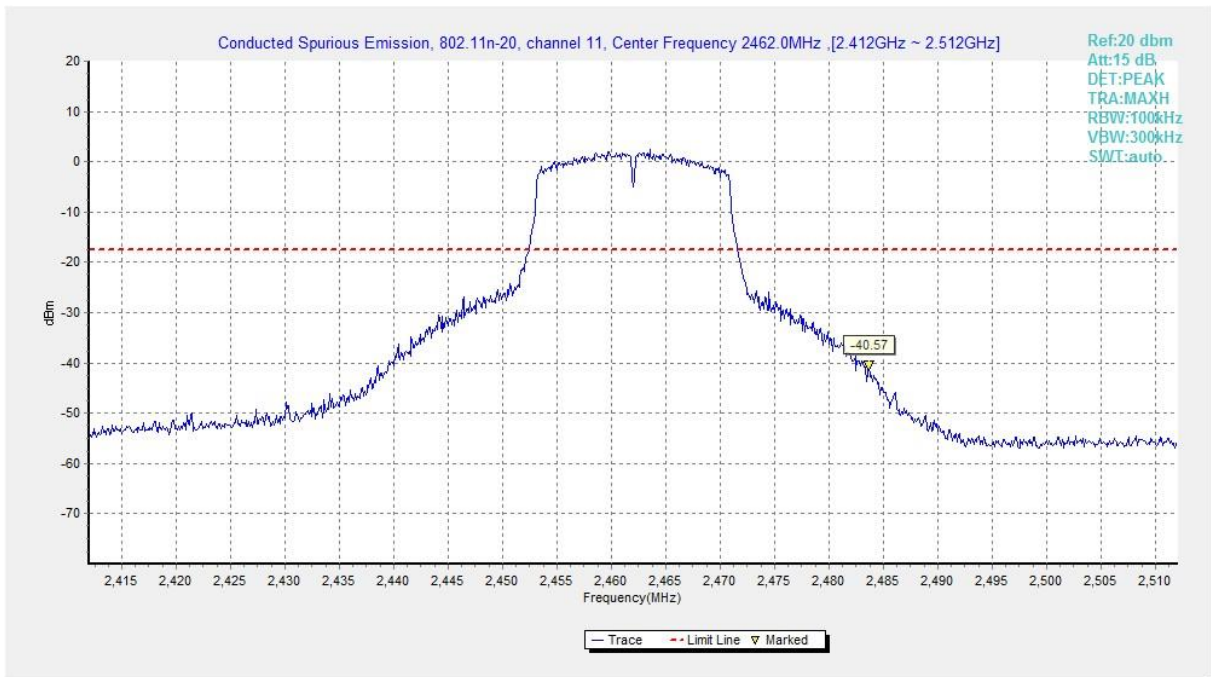

Fig.A.6.1.65 Transmitter Spurious Emission - Conducted (802.11n-HT20, Ch11, Center Frequency)

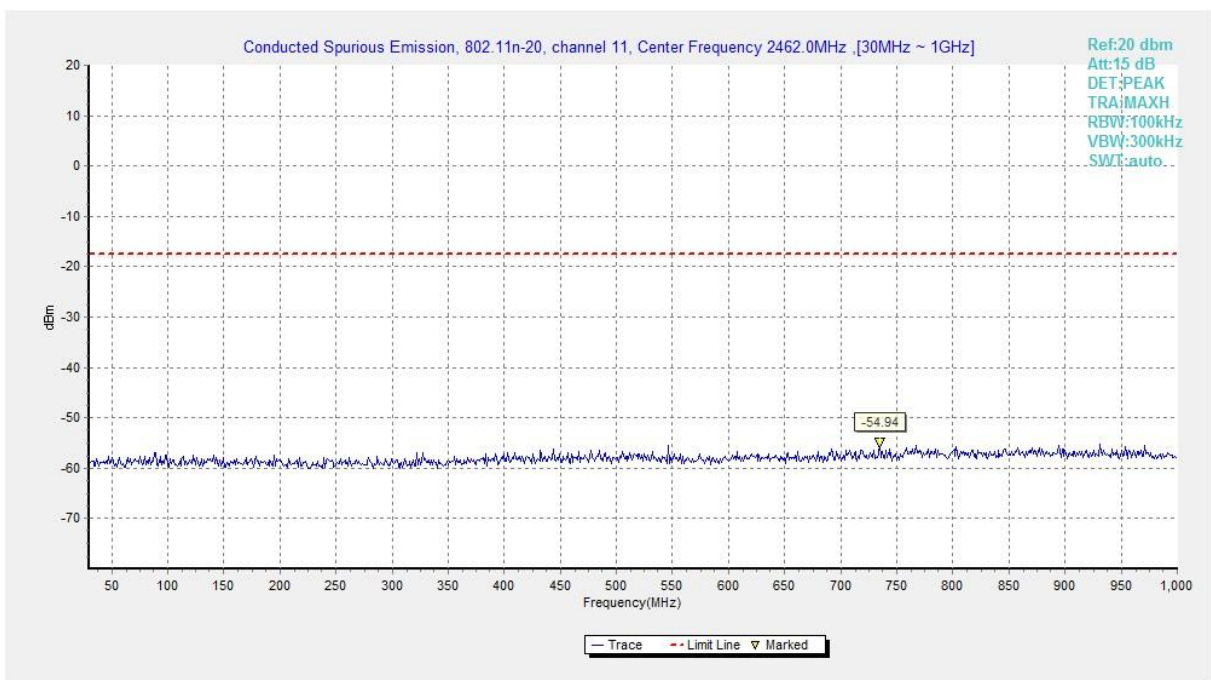

Fig.A.6.1.66 Transmitter Spurious Emission - Conducted (802.11n-HT20, Ch11, 30 MHz-1 GHz)

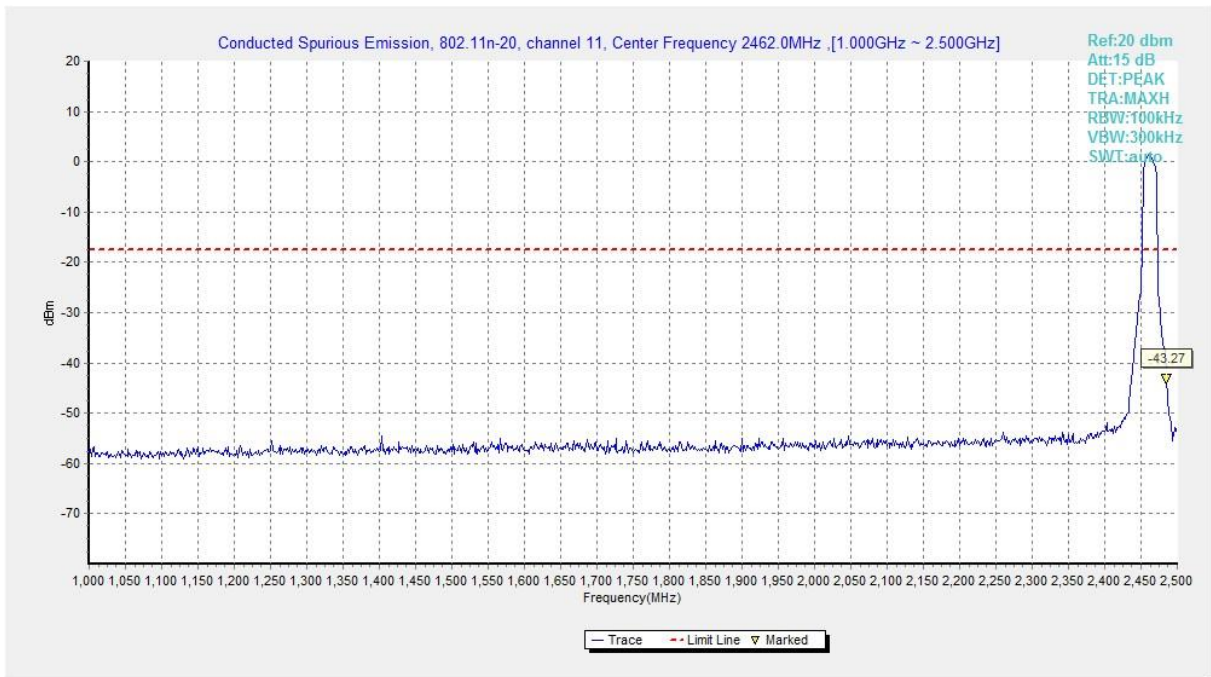

Fig.A.6.1.67 Transmitter Spurious Emission - Conducted (802.11n-HT20, Ch11, 1 GHz-2.5 GHz)

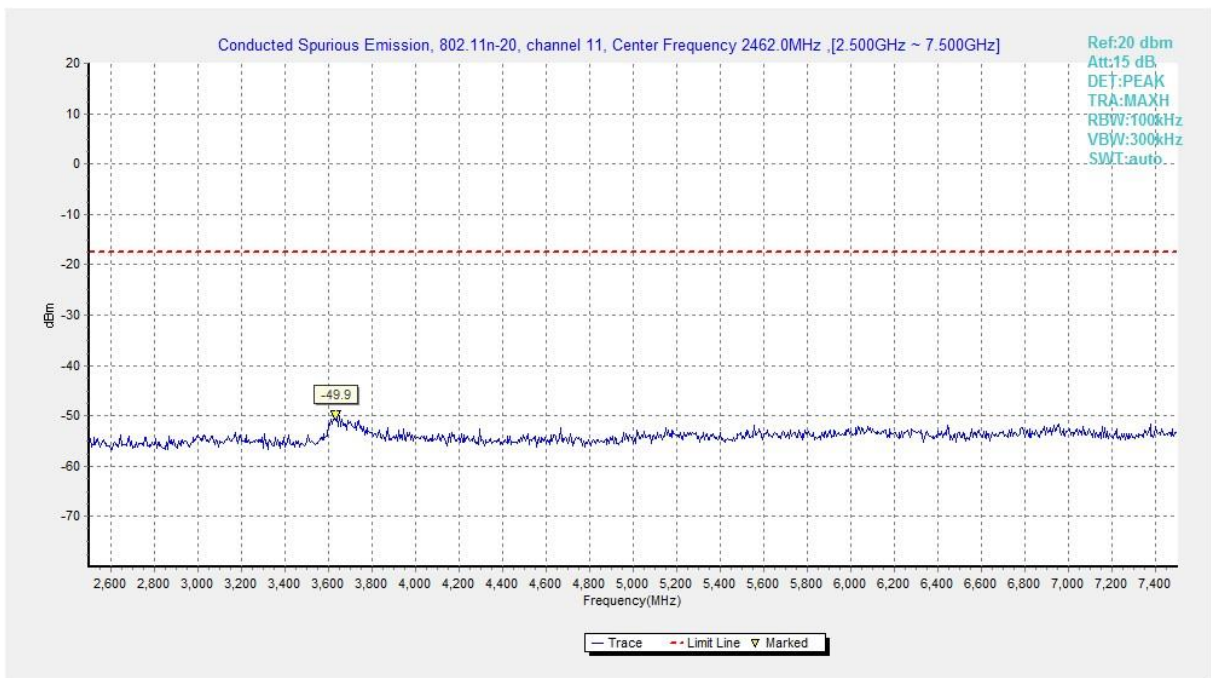

Fig.A.6.1.68 Transmitter Spurious Emission - Conducted (802.11n-HT20, Ch11, 2.5 GHz-7.5 GHz)

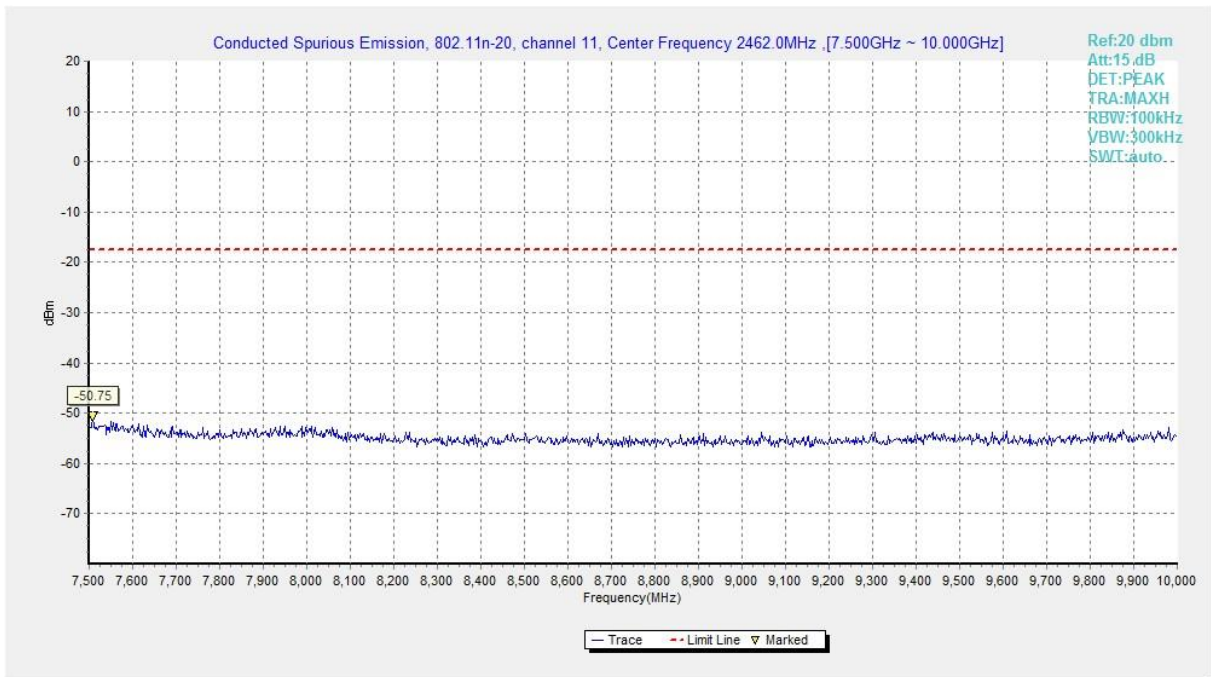

Fig.A.6.1.69 Transmitter Spurious Emission - Conducted (802.11n-HT20, Ch11, 7.5 GHz-10 GHz)

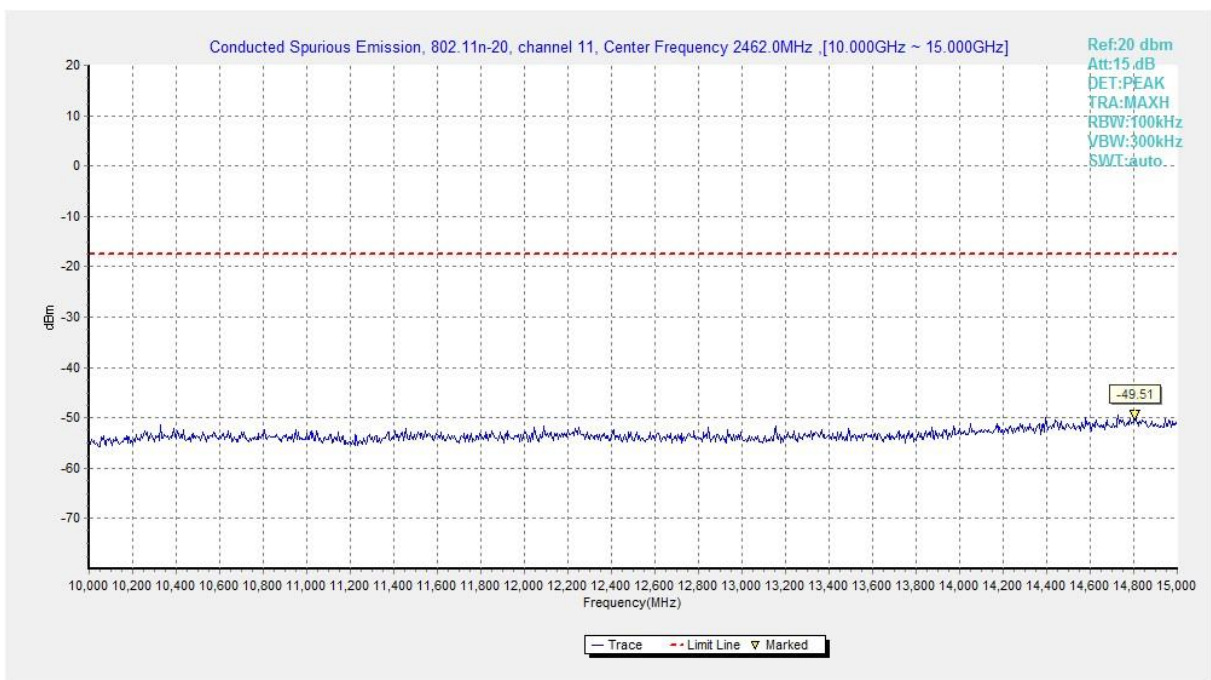

Fig.A.6.1.70 Transmitter Spurious Emission - Conducted (802.11n-HT20, Ch11, 10 GHz-15 GHz)

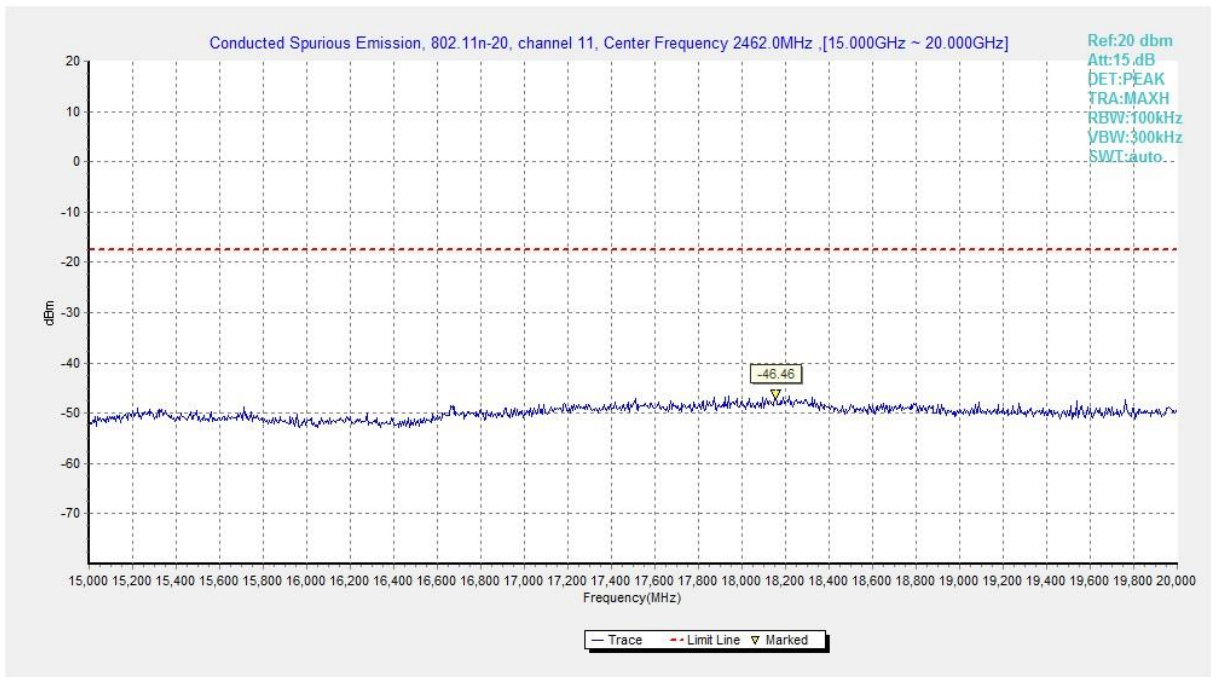

Fig.A.6.1.71 Transmitter Spurious Emission - Conducted (802.11n-HT20, Ch11, 15 GHz-20 GHz)

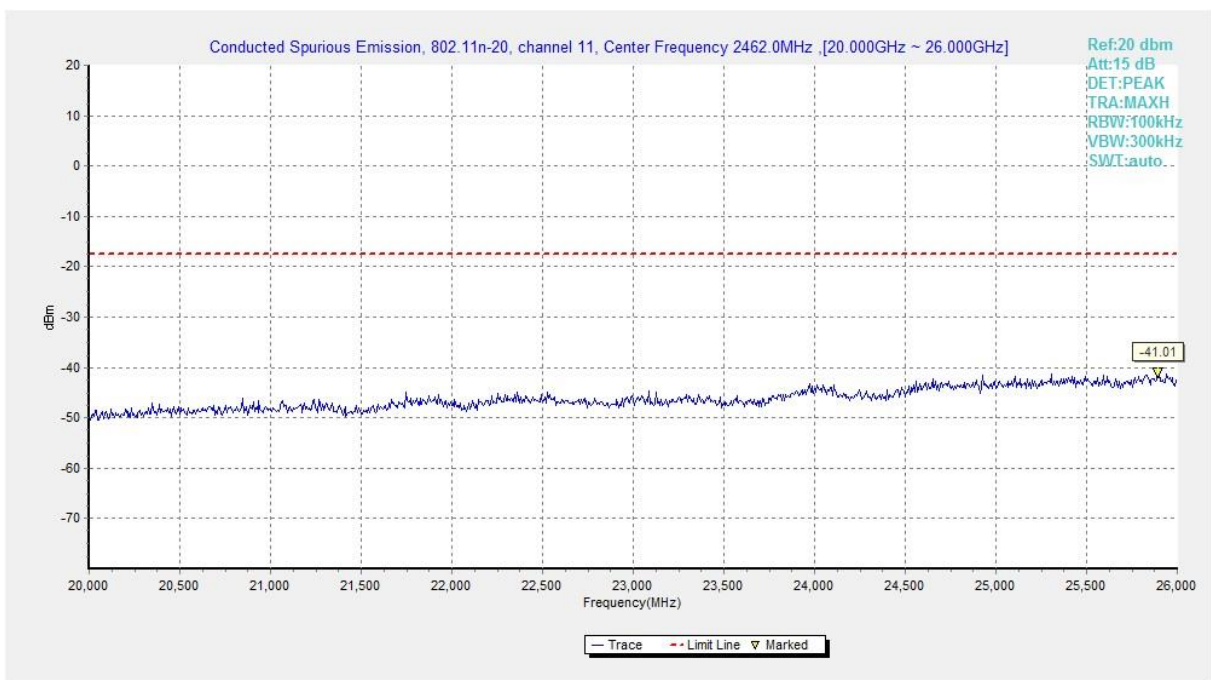

Fig.A.6.1.72 Transmitter Spurious Emission - Conducted (802.11n-HT20, Ch11, 20 GHz-26 GHz)

A.6.2 Transmitter Spurious Emission - Radiated

Method of Measurement: See ANSI C63.10-2013-clause 6.4 & 6.5 & 6.6

Measurement Limit:

Standard	Limit
FCC 47 CFR Part 15.247, 15.205, 15.209	20dB below peak output power

radiated emissions which fall in the restricted bands, as defined in § 15.205(a), must also comply with the radiated emission limits specified in § 15.209(a) (see § 15.205(c)).

Limit in restricted band:

Frequency (MHz)	Field strength(μ V/m)	Measurement distance (m)
0.009 - 0.490	2400/F(kHz)	300
0.490 - 1.705	24000/F(kHz)	30
1.705 – 30.0	30	30

Frequency of emission (MHz)	Field strength(μ V/m)	Field strength(dBuV/m)
30-88	100	40
88-216	150	43.5
216-960	200	46
Above 960	500	54

Set up:

Tabletop devices shall be placed on a nonconducting platform with nominal top surface dimensions 1 m by 1.5 m. For emissions testing at or below 1 GHz, the table height shall be 80 cm above the reference ground plane. For emission measurements above 1 GHz, the table height shall be 1.5 m.

The EUT and transmitting antenna shall be centered on the turntable.

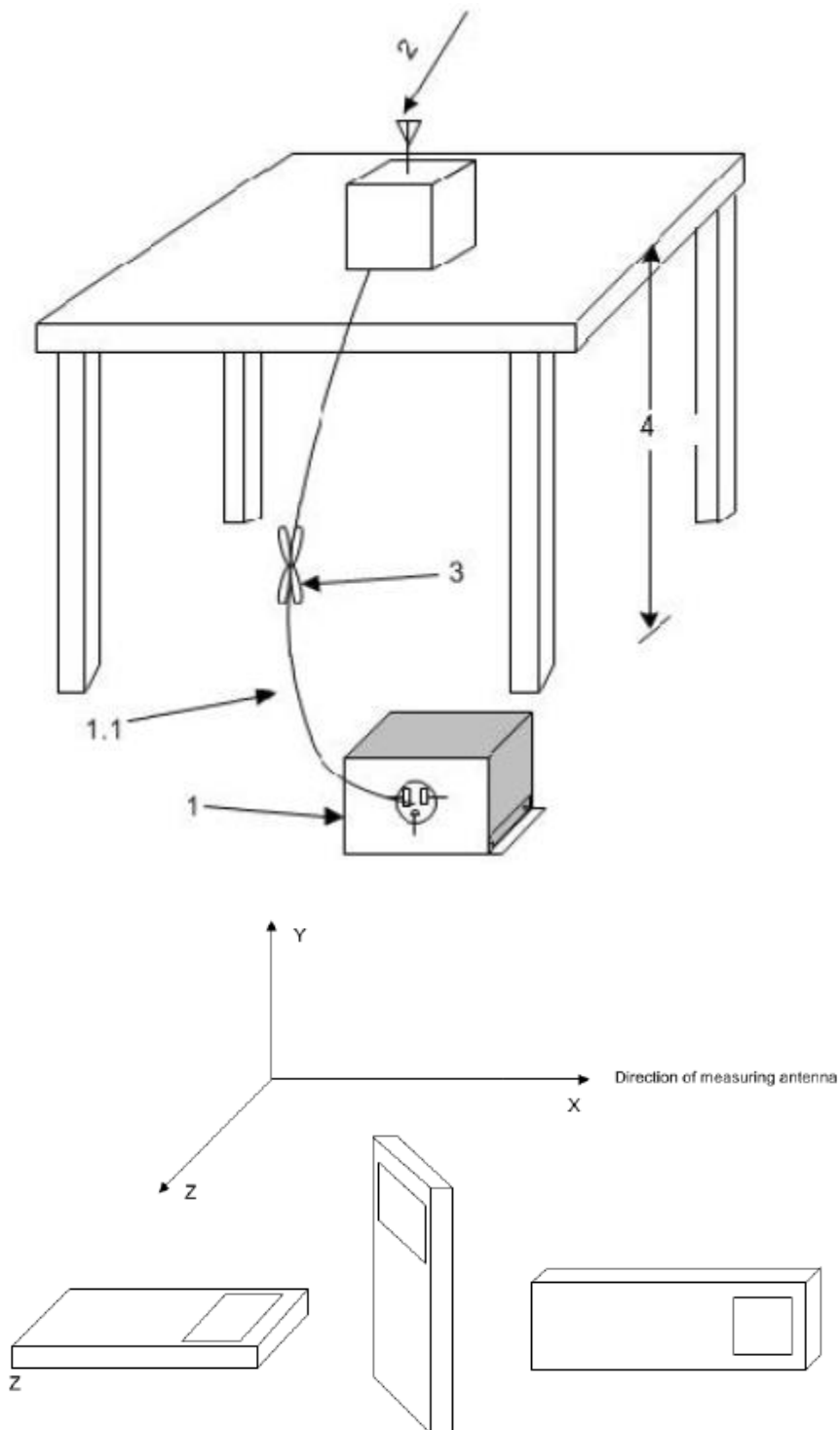

Test Condition

The EUT shall be tested 1 near top, 1 near middle, and 1 near bottom. Set the unlicensed wireless device to operate in continuous transmit mode. For unlicensed wireless devices unable to be configured for 100% duty cycle even in test mode, configure the system for the maximum duty cycle supported.

When required for unlicensed wireless devices, measurements of the variation of the input power or the radiated signal level of the fundamental frequency component of the emission, as

appropriate, shall be performed with the supply voltage varied between 85% and 115% of the nominal rated supply voltage.

Exploratory radiated emissions measurements

Exploratory radiated measurements shall be performed at the measurement distance or at a closer distance than that specified for compliance to determine the emission characteristics of the EUT and, if applicable, the EUT configuration that produces the maximum level of emissions. The frequencies of maximum emission may be determined by manually positioning the antenna close to the EUT, and then moving the antenna over all sides of the EUT while observing a spectral display. It is advantageous to have prior knowledge of the frequencies of emissions, although this may be determined from such a near-field scan. The near-field scan shall only be used to determine the frequency but not the amplitude of the emissions. Where exploratory measurements are not adequate to determine the worst-case operating modes and are used only to identify the frequencies of the highest emissions, additional preliminary tests can be required.

For emissions from the EUT, the maximum level shall be determined by rotating the EUT and its antenna through 0° to 360°. For each mode of operation required to be tested, the frequency spectrum (based on findings from exploratory measurements) shall be monitored.

Broadband antennas and a spectrum analyzer or a radio-noise meter with a panoramic display are often useful in this type of test. If either antenna height or EUT azimuth are not fully measured during exploratory testing, then complete testing can be required at the OATS or semi-anechoic chamber when the final full spectrum testing is performed.

Final radiated emissions measurements

The final measurements are using the orientation and equipment arrangement of the EUT based on the measurement results found during the preliminary (exploratory) measurements, the EUT arrangement, appropriate modulation, and modes of operation that produce the emissions that have the highest amplitude relative to the limit shall be selected for the final measurement.

For each mode of operation required to be tested, the frequency spectrum (based on findings from exploratory measurements) shall be monitored. The highest signal levels relative to the limit shall be determined by rotating the EUT from 0° to 360° and with varying the measurement antenna height between 1 m and 4 m in vertical and horizontal polarizations.

For each mode selected, record the frequency and amplitude of the highest fundamental emission (if applicable), as well as the frequency and amplitude of the six highest spurious emissions relative to the limit. Emissions more than 20 dB below the limit do not need to be reported.

This maximization process was repeated with the EUT positioned in each of its three orthogonal orientations.

The receiver references:

Frequency of emission (MHz)	RBW/VBW	Sweep Time(s)
30-1000	100KHz/300KHz	5
1000-4000	1MHz/3MHz	15
4000-18000	1MHz/3MHz	40
18000-26500	1MHz/3MHz	20

Measurement Results:

EUT ID: EUT04a

802.11b mode

Mode	Channel	Frequency Range	Test Results	Conclusion
802.11b	Power	2.38GHz ~2.45GHz	Fig.A.6.2.1	P
	Power	2.45GHz ~2.5GHz	Fig.A.6.2.2	P

802.11g mode

Mode	Channel	Frequency Range	Test Results	Conclusion
802.11g	Power	2.38GHz ~2.43GHz	Fig.A.6.2.3	P
	Power	2.45GHz ~2.5GHz	Fig.A.6.2.4	P

802.11n-HT20 mode

Mode	Channel	Frequency Range	Test Results	Conclusion
802.11n (HT20)	Power	2.38GHz ~2.45GHz	Fig.A.6.2.5	P
	Power	2.45GHz ~2.5GHz	Fig.A.6.2.6	P

Conclusion: Pass

Note:

A "reference path loss" is established and the A_{Rpl} is the attenuation of "reference path loss", and including the gain of receive antenna, the gain of the preamplifier, the cable loss.

P_{Mea} is the field strength recorded from the instrument.

The measurement results are obtained as described below:

$$\text{Result} = P_{Mea} + A_{Rpl} = P_{Mea} + \text{Cable Loss} + \text{Antenna Factor}$$

Average Measurement results
802.11b
Ch1

Frequency (MHz)	Measurement Result (dBμV/m)	Cable loss (dB)	Antenna Factor (dB/m)	Receiver Reading (dBμV)	Limit (dBμV/m)	Margin (dB)	Antenna Pol. (H/V)
17599.50	42.76	-25.70	46.00	22.56	54.00	11.24	H
14188.00	39.34	-29.00	42.00	26.34	54.00	14.66	H
12858.00	37.52	-30.70	39.10	29.02	54.00	16.48	H
9700.50	35.18	-33.00	38.00	30.18	54.00	18.82	H
7880.00	34.42	-34.90	37.10	32.22	54.00	19.58	H
2386.40	44.69	-20.00	28.10	36.69	54.00	9.31	H

Ch6

Frequency (MHz)	Measurement Result (dBμV/m)	Cable loss (dB)	Antenna Factor (dB/m)	Receiver Reading (dBμV)	Limit (dBμV/m)	Margin (dB)	Antenna Pol. (H/V)
17915.50	42.74	-25.50	46.70	21.54	54.00	11.26	V
13788.50	42.00	-29.10	40.90	30.20	54.00	12.00	H
12879.50	37.54	-30.70	39.10	29.04	54.00	16.46	H
9610.00	35.49	-33.10	38.00	30.59	54.00	18.51	H
7216.50	34.33	-35.50	36.40	33.43	54.00	19.67	V
4595.50	29.54	-37.30	32.70	34.24	54.00	24.46	V

Ch11

Frequency (MHz)	Measurement Result (dBμV/m)	Cable loss (dB)	Antenna Factor (dB/m)	Receiver Reading (dBμV)	Limit (dBμV/m)	Margin (dB)	Antenna Pol. (H/V)
17587.00	42.78	-25.70	46.00	22.58	54.00	11.22	V
14170.00	39.50	-29.00	42.00	26.50	54.00	14.50	V
12846.50	37.48	-30.70	39.10	28.98	54.00	16.52	V
9617.50	35.28	-33.10	38.00	30.38	54.00	18.72	V
7787.50	34.37	-35.10	37.00	32.47	54.00	19.63	H
2485.50	43.81	-20.00	28.30	35.51	54.00	10.19	H

802.11g

Ch1

Frequency (MHz)	Measurement Result (dBμV/m)	Cable loss (dB)	Antenna Factor (dB/m)	Receiver Reading (dBμV)	Limit (dBμV/m)	Margin (dB)	Antenna Pol. (H/V)
17934.50	42.87	-25.50	46.70	21.67	54.00	11.13	V
14183.00	39.45	-29.00	42.00	26.45	54.00	14.55	H
12835.50	37.84	-30.70	39.10	29.34	54.00	16.16	V
8999.00	35.45	-33.30	38.20	30.55	54.00	18.55	H
7879.50	34.57	-34.90	37.10	32.37	54.00	19.43	V
2390.00	48.85	-20.00	28.10	40.85	54.00	5.15	H

Ch6

Frequency (MHz)	Measurement Result (dBμV/m)	Cable loss (dB)	Antenna Factor (dB/m)	Receiver Reading (dBμV)	Limit (dBμV/m)	Margin (dB)	Antenna Pol. (H/V)
17399.50	42.77	-26.90	45.20	24.37	54.00	11.23	V
14167.50	39.40	-29.00	42.00	26.40	54.00	14.60	V
12889.50	37.43	-30.70	39.10	28.93	54.00	16.57	V
9214.00	35.21	-33.70	38.00	30.91	54.00	18.79	H
7992.50	34.48	-34.80	37.10	32.18	54.00	19.52	H
4695.50	29.63	-37.40	32.90	34.13	54.00	24.37	H

Ch11

Frequency (MHz)	Measurement Result (dBμV/m)	Cable loss (dB)	Antenna Factor (dB/m)	Receiver Reading (dBμV)	Limit (dBμV/m)	Margin (dB)	Antenna Pol. (H/V)
17607.00	42.78	-25.70	46.00	22.58	54.00	11.22	H
13792.50	39.27	-29.10	40.90	27.47	54.00	14.73	H
12849.50	37.58	-30.70	39.10	29.08	54.00	16.42	V
9003.00	35.23	-33.30	38.20	30.33	54.00	18.77	V
7978.50	34.21	-34.80	37.10	31.91	54.00	19.79	H
2485.00	46.17	-20.00	28.30	37.87	54.00	7.83	H

802.11n-HT20

Ch1

Frequency (MHz)	Measurement Result (dBμV/m)	Cable loss (dB)	Antenna Factor (dB/m)	Receiver Reading (dBμV)	Limit (dBμV/m)	Margin (dB)	Antenna Pol. (H/V)
17601.00	42.69	-25.70	46.00	22.49	54.00	11.31	H
14176.50	39.27	-29.00	42.00	26.27	54.00	14.73	H
12864.00	37.48	-30.70	39.10	28.98	54.00	16.52	V
9708.50	35.49	-33.00	38.00	30.49	54.00	18.51	V
7989.50	34.23	-34.80	37.10	31.93	54.00	19.77	H
2389.80	45.72	-20.00	28.10	37.72	54.00	8.28	H

Ch6

Frequency (MHz)	Measurement Result (dBμV/m)	Cable loss (dB)	Antenna Factor (dB/m)	Receiver Reading (dBμV)	Limit (dBμV/m)	Margin (dB)	Antenna Pol. (H/V)
17921.00	42.83	-25.50	46.70	21.63	54.00	11.17	V
14191.00	39.46	-29.00	42.00	26.46	54.00	14.54	V
12910.50	37.65	-30.50	39.20	28.95	54.00	16.35	V
9103.50	35.20	-33.80	38.10	30.80	54.00	18.80	H
7994.00	34.28	-34.80	37.10	31.98	54.00	19.72	H
4707.50	29.48	-37.40	32.90	33.98	54.00	24.52	V

Ch11

Frequency (MHz)	Measurement Result (dBμV/m)	Cable loss (dB)	Antenna Factor (dB/m)	Receiver Reading (dBμV)	Limit (dBμV/m)	Margin (dB)	Antenna Pol. (H/V)
17595.00	42.74	-25.70	46.00	22.54	54.00	11.26	V
14194.50	39.31	-29.00	42.00	26.31	54.00	14.69	H
12358.00	37.35	-31.10	38.90	29.55	54.00	16.65	V
9824.00	35.22	-33.50	38.00	30.72	54.00	18.78	H
7885.00	34.36	-34.90	37.10	32.16	54.00	19.64	V
2485.00	46.29	-20.00	28.30	37.99	54.00	7.71	H

Peak Measurement results
802.11b

Ch1

Frequency (MHz)	Measurement Result (dBμV/m)	Cable loss (dB)	Antenna Factor (dB/m)	Receiver Reading (dBμV)	Limit (dBμV/m)	Margin (dB)	Antenna Pol. (H/V)
17694.00	54.20	-25.70	46.00	34.00	74.00	19.80	V
14309.00	51.75	-28.40	42.30	37.85	74.00	22.25	V
12766.50	49.55	-30.50	39.10	40.95	74.00	24.45	H
9898.00	47.22	-33.50	38.10	42.62	74.00	26.78	V
7706.50	45.82	-34.80	37.00	43.72	74.00	28.18	H
2386.90	56.87	-20.00	28.10	48.87	74.00	17.13	H

Ch6

Frequency (MHz)	Measurement Result (dBμV/m)	Cable loss (dB)	Antenna Factor (dB/m)	Receiver Reading (dBμV)	Limit (dBμV/m)	Margin (dB)	Antenna Pol. (H/V)
17494.00	53.97	-26.90	45.20	35.57	74.00	20.03	V
13788.50	51.49	-29.10	40.90	39.69	74.00	22.51	H
12768.50	48.96	-30.50	39.10	40.36	74.00	25.04	H
9881.50	46.77	-33.50	38.10	42.17	74.00	27.23	H
7982.50	46.20	-34.80	37.10	43.90	74.00	27.80	V
4711.50	41.17	-37.40	32.90	45.67	74.00	32.83	V

Ch11

Frequency (MHz)	Measurement Result (dBμV/m)	Cable loss (dB)	Antenna Factor (dB/m)	Receiver Reading (dBμV)	Limit (dBμV/m)	Margin (dB)	Antenna Pol. (H/V)
17618.00	54.38	-25.70	46.00	34.18	74.00	19.62	V
14105.50	51.31	-29.40	41.70	39.11	74.00	22.69	V
12864.50	48.95	-30.70	39.10	40.45	74.00	25.05	H
9571.00	46.63	-33.10	38.00	41.73	74.00	27.37	H
7320.00	46.19	-35.10	36.60	44.69	74.00	27.81	V
2498.70	57.29	-20.00	28.40	48.89	74.00	16.71	V

802.11g

Ch1

Frequency (MHz)	Measurement Result (dBμV/m)	Cable loss (dB)	Antenna Factor (dB/m)	Receiver Reading (dBμV)	Limit (dBμV/m)	Margin (dB)	Antenna Pol. (H/V)
17974.00	54.33	-25.50	46.70	33.13	74.00	19.67	H
14216.50	51.27	-29.00	42.00	38.27	74.00	22.73	V
12933.00	49.18	-30.50	39.20	40.48	74.00	24.82	V
9523.50	47.15	-33.20	37.90	42.45	74.00	26.85	V
7328.50	46.30	-35.10	36.60	44.80	74.00	27.70	V
2389.80	69.03	-20.00	28.10	61.03	74.00	4.97	H

Ch6

Frequency (MHz)	Measurement Result (dBμV/m)	Cable loss (dB)	Antenna Factor (dB/m)	Receiver Reading (dBμV)	Limit (dBμV/m)	Margin (dB)	Antenna Pol. (H/V)
17941.00	54.39	-25.50	46.70	33.19	74.00	19.61	V
13704.00	51.30	-29.10	40.90	39.50	74.00	22.70	V
12844.00	49.06	-30.70	39.10	40.56	74.00	24.94	H
8449.00	46.68	-34.40	37.80	43.28	74.00	27.32	V
7169.50	46.09	-35.40	36.30	45.19	74.00	27.91	H
4791.50	41.15	-37.30	33.00	45.35	74.00	32.85	V

Ch11

Frequency (MHz)	Measurement Result (dBμV/m)	Cable loss (dB)	Antenna Factor (dB/m)	Receiver Reading (dBμV)	Limit (dBμV/m)	Margin (dB)	Antenna Pol. (H/V)
17233.50	54.47	-25.90	44.40	36.07	74.00	19.53	V
14233.50	51.75	-29.00	42.00	38.75	74.00	22.25	H
12766.00	48.81	-30.50	39.10	40.21	74.00	25.19	V
8895.50	46.87	-33.50	38.10	42.27	74.00	27.13	H
7711.50	46.20	-34.80	37.00	44.10	74.00	27.80	V
2485.70	62.17	-20.00	28.30	53.87	74.00	11.83	H

802.11n-HT20

Ch1

Frequency (MHz)	Measurement Result (dBμV/m)	Cable loss (dB)	Antenna Factor (dB/m)	Receiver Reading (dBμV)	Limit (dBμV/m)	Margin (dB)	Antenna Pol. (H/V)
17208.50	54.70	-26.60	43.40	37.90	74.00	19.30	V
14203.00	52.85	-29.00	42.00	39.85	74.00	21.15	V
12747.00	49.60	-30.50	39.10	41.00	74.00	24.40	V
9714.00	46.90	-33.00	38.00	41.90	74.00	27.10	H
7027.00	45.98	-35.20	36.10	45.08	74.00	28.02	H
2389.80	66.64	-20.00	28.10	58.64	74.00	7.36	H

Ch6

Frequency (MHz)	Measurement Result (dBμV/m)	Cable loss (dB)	Antenna Factor (dB/m)	Receiver Reading (dBμV)	Limit (dBμV/m)	Margin (dB)	Antenna Pol. (H/V)
17903.00	54.25	-25.50	46.70	33.05	74.00	19.75	V
13794.00	50.70	-29.10	40.90	38.90	74.00	23.30	V
12355.50	49.66	-31.10	38.90	41.86	74.00	24.34	H
9309.50	46.87	-33.90	38.00	42.77	74.00	27.13	H
7876.00	46.02	-34.90	37.10	43.82	74.00	27.98	H
4808.00	41.11	-37.30	33.00	45.31	74.00	32.89	H

Ch11

Frequency (MHz)	Measurement Result (dBμV/m)	Cable loss (dB)	Antenna Factor (dB/m)	Receiver Reading (dBμV)	Limit (dBμV/m)	Margin (dB)	Antenna Pol. (H/V)
17697.00	54.65	-25.70	46.00	34.45	74.00	19.35	H
13537.00	51.02	-29.60	40.00	40.62	74.00	22.98	V
11423.50	49.44	-32.40	38.80	43.04	74.00	24.56	V
9184.00	47.28	-33.80	38.10	43.08	74.00	26.72	H
7807.50	45.84	-35.10	37.00	43.94	74.00	28.16	H
2485.00	66.08	-20.00	28.30	57.78	74.00	7.92	H

Sample calculation: 802.11n CH11–Peak, 17697.00 MHz

$$\text{Peak ERP(dBm)} = P_{\text{Mea}}(34.45 \text{ dB}\mu\text{V/m}) + \text{Cable Loss}(-25.70) + \text{Antenna Factor}(46.00) = 54.65 \text{ dB}\mu\text{V/m}$$

A.7. AC Power-line Conducted Emission

Method of Measurement: See ANSI C63.10-clause 6.2

Setup:

A stand-alone EUT shall be placed in the center along the back edge of the tabletop. For multiunit tabletop systems, the EUT shall be centered laterally (left to right facing the tabletop) on the tabletop and its rear shall be flush with the rear of the table.

Accessories that are part of an EUT system tested on a tabletop shall be placed in a test arrangement on one or both sides of the host with a 10 cm separation between the nearest points of the cabinets. The rear of the host and accessories shall be flush with the back of the supporting tabletop unless that would not be typical of normal use. If more than two accessories are present, then an equipment test arrangement shall be chosen that maintains 10 cm spacing between cabinets unless the equipment is normally located closer together.

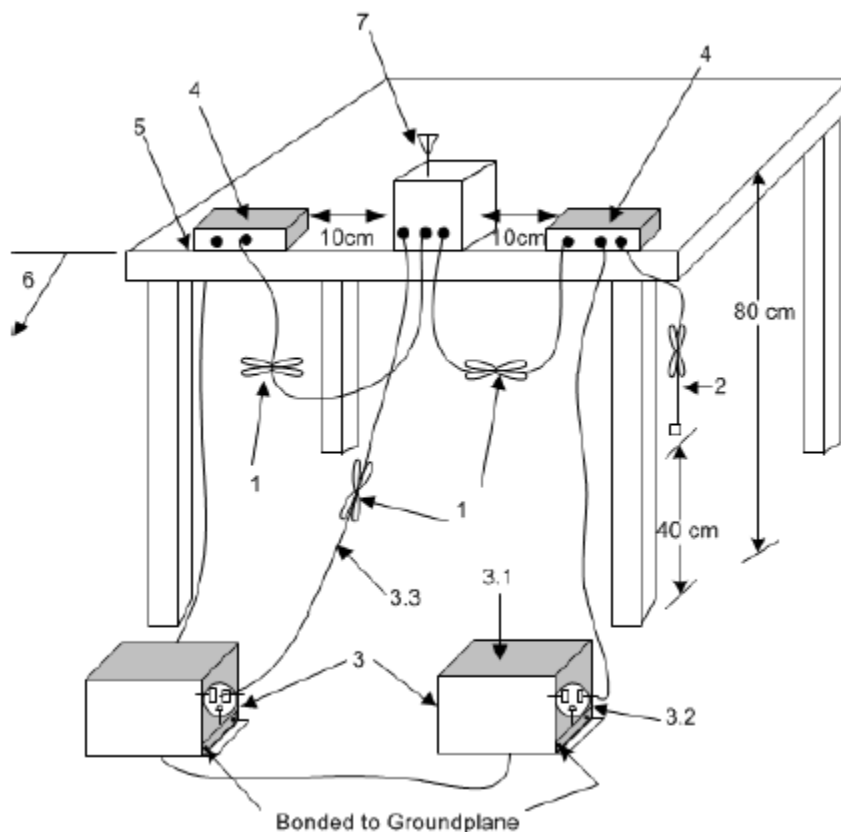

Exploratory ac power-line conducted emission measurements

Exploratory measurements shall be used to identify the frequency of the emission that has the highest amplitude relative to the limit by operating the EUT in a range of typical modes of operation, cable positions, and with a typical system equipment configuration and arrangement. For each mode of operation and for each ac power current-carrying conductor, cable manipulation shall be performed within the range of likely configurations. For this measurement or series of measurements, the frequency spectrum of interest shall be monitored looking for the emission that has the highest amplitude relative to the limit. Once that emission is found for each current-carrying conductor of each power cord associated with the EUT (but not the cords associated with non-EUT equipment in the overall system), the one configuration and

arrangement and mode of operation that produces the emission closest to the limit over all of the measured conductors shall be recorded.

Final ac power-line conducted emission measurements

Based on the exploratory tests of the EUT, the one EUT cable configuration and arrangement and mode of operation that produced the emission with the highest amplitude relative to the limit is selected for the final measurement, while applying the appropriate modulating signal to the EUT. If the EUT is relocated from an exploratory test site to a final test site, the highest emissions shall be remaximized at the final test location before final ac power-line conducted emission measurements are performed. The final test on all current-carrying conductors of all of the power cords to the equipment that comprises the EUT (but not the cords associated with other non-EUT equipment in the system) is then performed for the full frequency range for which the EUT is being tested for compliance without further variation of the EUT arrangement, cable positions, or EUT mode of operation. If the EUT is composed of equipment units that have their own separate ac power connections (e.g., floor-standing equipment with independent power cords for each shelf that are able to connect directly to the ac power network), then each current-carrying conductor of one unit is measured while the other units are connected to a second (or more) LISN(s). All units shall be measured separately. If a power strip is provided by the manufacturer, to supply all of the units making up the EUT, only the conductors in the power cord of the power strip shall be measured.

Test Condition:

Voltage (V)	Frequency (Hz)
120	60

Measurement Result and limit:

Conclusion: Pass

EUT ID: UT04a(I22Z60871)

WLAN (Quasi-peak Limit)

Frequency range (MHz)	Quasi-peak Limit (dB μ V)	Result (dB μ V)		Conclusion
		With charger		
		802.11b	Idle	
0.15 to 0.5	66 to 56	Fig.A.7.1	Fig.A.7.2	P
0.5 to 5	56			
5 to 30	60			

NOTE: The limit decreases linearly with the logarithm of the frequency in the range 0.15 MHz to 0.5 MHz.

WLAN (Average Limit)

Frequency range (MHz)	Average Limit (dB μ V)	Result (dB μ V)		Conclusion
		With charger		
		802.11b	Idle	
0.15 to 0.5	56 to 46	Fig.A.7.1	Fig.A.7.2	P
0.5 to 5	46			
5 to 30	50			

NOTE: The limit decreases linearly with the logarithm of the frequency in the range 0.15 MHz to 0.5 MHz.

Test graphs as below:

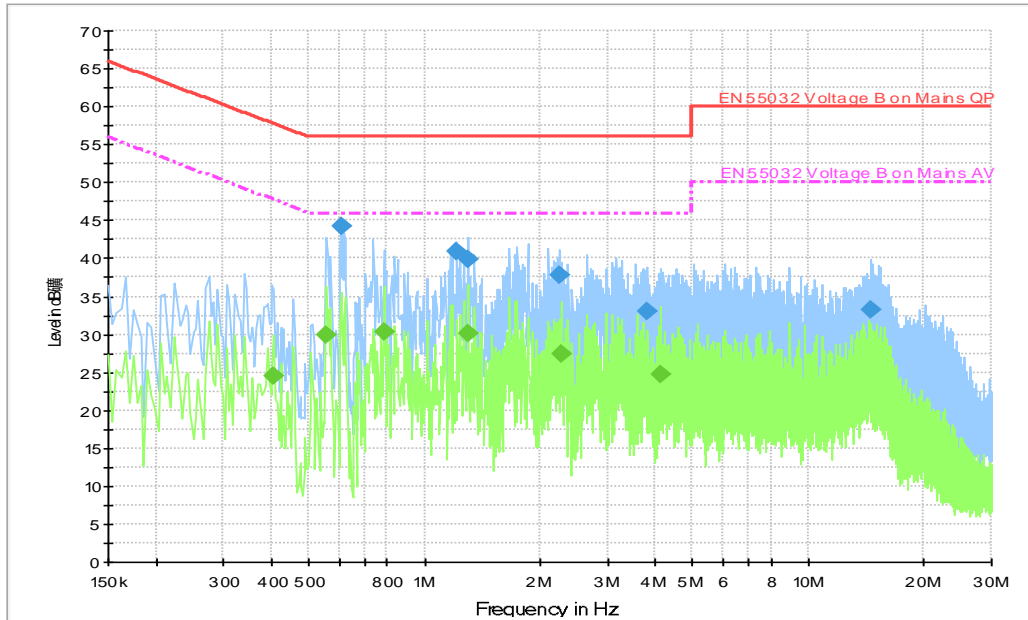

Fig.A.7.1 AC Powerline Conducted Emission-802.11b

Note: The graphic result above is the maximum of the measurements for both phase line and neutral line.

Final Result 1

Frequency (MHz)	QuasiPeak (dB μ V)	Line	Corr. (dB)	Margin (dB)	Limit (dB μ V)
0.606000	44.3	L1	19.6	11.7	56.0
1.214000	40.9	L1	19.7	15.1	56.0
1.298000	39.8	L1	19.7	16.2	56.0
2.254000	37.8	L1	19.6	18.2	56.0
3.806000	33.1	L1	19.5	22.9	56.0
14.482000	33.2	L1	19.7	26.8	60.0

Final Result 2

Frequency (MHz)	QuasiPeak (dB μ V)	Line	Corr. (dB)	Margin (dB)	Limit (dB μ V)
0.406000	24.6	L1	19.7	23.2	47.7
0.554000	29.9	L1	19.7	16.1	46.0
0.786000	30.3	L1	19.7	15.7	46.0
1.298000	30.1	L1	19.7	15.9	46.0
2.282000	27.4	L1	19.6	18.6	46.0
4.142000	24.7	L1	19.6	21.3	46.0

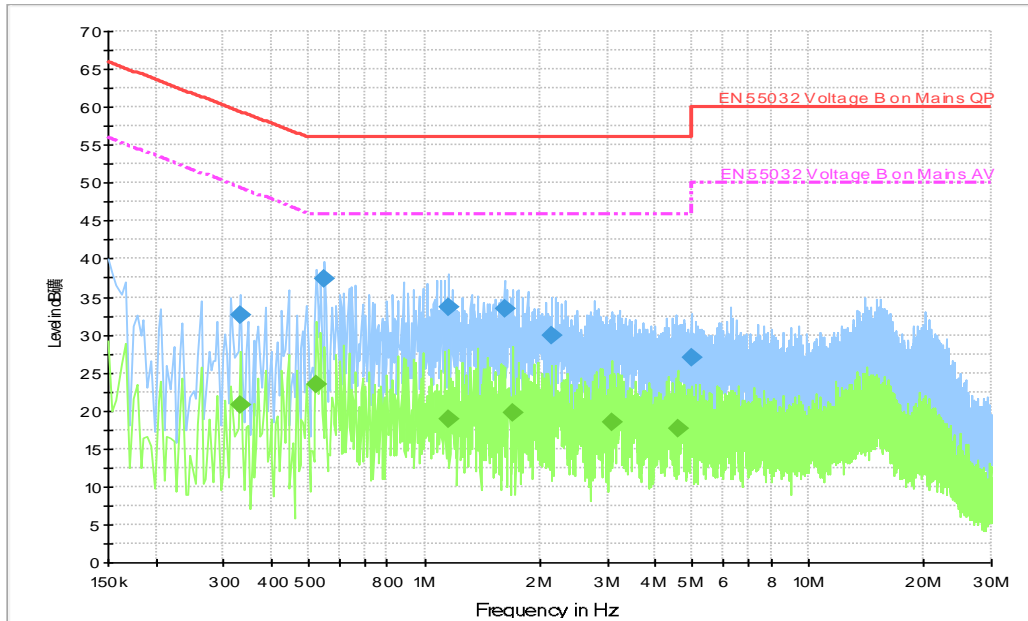

Fig.A.7.2 AC Powerline Conducted Emission-Idle

Note: The graphic result above is the maximum of the measurements for both phase line and neutral line.

Final Result 1

Frequency (MHz)	QuasiPeak (dBμV)	Line	Corr. (dB)	Margin (dB)	Limit (dBμV)
0.330000	32.5	L1	19.8	26.9	59.5
0.550000	37.5	L1	19.7	18.5	56.0
1.158000	33.6	L1	19.8	22.4	56.0
1.614000	33.4	L1	19.7	22.6	56.0
2.154000	29.9	N	19.7	26.1	56.0
4.946000	27.1	L1	19.6	28.9	56.0

Final Result 2

Frequency (MHz)	QuasiPeak (dBμV)	Line	Corr. (dB)	Margin (dB)	Limit (dBμV)
0.330000	20.8	L1	19.8	28.6	49.5
0.522000	23.4	L1	19.7	22.6	46.0
1.158000	18.8	L1	19.8	27.2	46.0
1.694000	19.7	L1	19.6	26.3	46.0
3.082000	18.5	L1	19.6	27.5	46.0
4.558000	17.6	L1	19.5	28.4	46.0

ANNEX B: EUT parameters

Disclaimer: The worse case provided by the client may affect the validity of the measurement results in this report, and the client shall bear the impact and consequences arising therefrom.

ANNEX C: Accreditation Certificate

United States Department of Commerce National Institute of Standards and Technology	
	
<hr/> Certificate of Accreditation to ISO/IEC 17025:2017 <hr/>	
NVLAP LAB CODE: 600118-0	
Telecommunication Technology Labs, CAICT Beijing China	
<i>is accredited by the National Voluntary Laboratory Accreditation Program for specific services, listed on the Scope of Accreditation, for:</i>	
Electromagnetic Compatibility & Telecommunications	
<i>This laboratory is accredited in accordance with the recognized International Standard ISO/IEC 17025:2017. This accreditation demonstrates technical competence for a defined scope and the operation of a laboratory quality management system (refer to joint ISO-ILAC-IAF Communiqué dated January 2009).</i>	
<hr/> 2021-09-29 through 2022-09-30 <i>Effective Dates</i>	 For the National Voluntary Laboratory Accreditation Program

END OF REPORT