



FCC PART 15C TEST REPORT No.I22Z60871-IOT03

for

vivo Mobile Communication Co., Ltd.

Mobile Phone

Model Name: V2160

FCC ID: 2AUCY-V2127

with

Hardware Version: MP_0.1

Software Version: PD2197BF_EX_A_3.13.15

Issued Date: 2022-05-20

Note:

The test results in this test report relate only to the devices specified in this report. This report shall not be reproduced except in full without the written approval of CTTL.

The report must not be used by the client to claim product certification, approval, or endorsement by NVLAP, NIST, or any agency of the U.S. Government.

Test Laboratory:

CTTL-Telecommunication Technology Labs, CAICT

No. 52, Huayuan North Road, Haidian District, Beijing, P. R. China 100191.

Tel:+86(0)10-62304633-2512, Fax:+86(0)10-62304633-2504

Email: ctl_terminals@caict.ac.cn, website: www.caict.ac.cn



REPORT HISTORY

Report Number	Revision	Description	Issue Date
I22Z60871-IOT03	Rev.0	1st edition	2022-05-20

CONTENTS

CONTENTS	3
1. TEST LATORATORY.....	5
1.1. INTRODUCTION & ACCREDITATION	5
1.2. TESTING LOCATION	5
1.3. TESTING ENVIRONMENT	5
1.4. PROJECT DATE	5
1.5. SIGNATURE	5
2. CLIENT INFORMATION.....	6
2.1. APPLICANT INFORMATION	6
2.2. MANUFACTURER INFORMATION	6
3. EQUIPMENT UNDER TEST (EUT) AND ANCILLARY EQUIPMENT(AE)	7
3.1. ABOUT EUT	7
3.2. INTERNAL IDENTIFICATION OF EUT USED DURING THE TEST	7
3.3. INTERNAL IDENTIFICATION OF AE USED DURING THE TEST	7
3.4. GENERAL DESCRIPTION.....	8
4. REFERENCE DOCUMENTS	8
4.1. DOCUMENTS SUPPLIED BY APPLICANT	8
4.2. REFERENCE DOCUMENTS FOR TESTING.....	8
5. LABORATORY ENVIRONMENT	8
6. SUMMARY OF TEST RESULTS	9
6.1. SUMMARY OF TEST RESULTS	9
6.2. STATEMENTS.....	9
6.3. TEST CONDITIONS	9
7. TEST EQUIPMENTS UTILIZED	10
8. MEASUREMENT UNCERTAINTY	11
8.1. TRANSMITTER OUTPUT POWER	11
8.2. PEAK POWER SPECTRAL DENSITY	11
8.3. OCCUPIED 6DB BANDWIDTH.....	11
8.4. BAND EDGES COMPLIANCE	11
8.5. SPURIOUS EMISSIONS	11
8.6. AC POWER-LINE CONDUCTED EMISSION	11
ANNEX A: MEASUREMENT RESULTS.....	12
A.1. MEASUREMENT METHOD	12
A.2. MAXIMUM PEAK OUTPUT POWER	13
A.2.1 ANTENNA GAIN.....	13
A.2.2. MAXIMUM PEAK OUTPUT POWER-CONDUCTED	13



A.3. PEAK POWER SPECTRAL DENSITY 17

A.4. OCCUPIED 6DB BANDWIDTH 18

A.5. TRANSMITTER SPURIOUS EMISSION 23

A.5.1 TRANSMITTER SPURIOUS EMISSION - RADIATED 23

A.6. BAND EDGES COMPLIANCE 36

A.6.1 BAND EDGES - RADIATED 36

A.7. AC POWERLINE CONDUCTED EMISSION 43

ANNEX B: EUT PARAMETERS..... 47

ANNEX C: ACCREDITATION CERTIFICATE 47

1. TEST LABORATORY

1.1. Introduction & Accreditation

Telecommunication Technology Labs, CAICT is an ISO/IEC 17025:2017 accredited test laboratory under NATIONAL VOLUNTARY LABORATORY ACCREDITATION PROGRAM (NVLAP) with lab code 600118-0, and is also an FCC accredited test laboratory (CN5017), and ISED accredited test laboratory (ISED#: 24849). The detail accreditation scope can be found on NVLAP website.

1.2. Testing Location

Testing Location: CTTL(huayuan North Road)

Address: No. 52, Huayuan North Road, Haidian District, Beijing,
P. R. China100191

1.3. Testing Environment

Normal Temperature: 15-35°C

Relative Humidity: 20-75%

1.4. Project date

Testing Start Date: 2021-11-15

Testing End Date: 2022-05-18

1.5. Signature

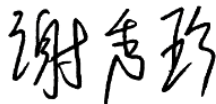

Xie Xiuzhen
(Prepared this test report)

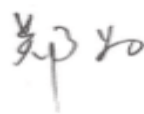

Zheng Wei
(Reviewed this test report)

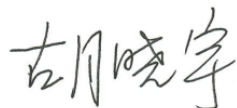

Hu Xiaoyu
(Approved this test report)



2. CLIENT INFORMATION

2.1. Applicant Information

Company Name: vivo Mobile Communication Co., Ltd.
Address: No.1, vivo Road, Chang'an, Dongguan, Guangdong, China
City: Dongguan
Postal Code: /
Country: China
Telephone: /
Fax: /

2.2. Manufacturer Information

Company Name: vivo Mobile Communication Co., Ltd.
Address: No.1, vivo Road, Chang'an, Dongguan, Guangdong, China
City: Dongguan
Postal Code: /
Country: China
Telephone: /
Fax: /

3. EQUIPMENT UNDER TEST (EUT) AND ANCILLARY

EQUIPMENT(AE)

3.1. About EUT

Description	Mobile Phone
Model name	V2160
FCC ID	2AUCY-V2127
WLAN Frequency Band	ISM Band: 5725MHz~5850MHz
Type of modulation	OFDM
Voltage	3.87 V

3.2. Internal Identification of EUT used during the test

EUT ID*	IMEI	HW Version	SW Version
UT01a	/	MP_0.1	PD2197BF_EX_A_3.13.15
UT04a	/	MP_0.1	PD2197BF_EX_A_3.13.15
UT04a(I22Z60871)	866590060198770/ 866590060198762	MP_0.1	PD2197BF_EX_A_3.13.15

*EUT ID: is used to identify the test sample in the lab internally.

3.3. Internal Identification of AE used during the test

AE ID*	Description
AE1	Charger
AE4	Charger
AE5	Battery
AE7	USB Cable
AE1	
Model	V1020D-EU
Manufacturer	Dongguan Aohai Technology Co.,Ltd
AE4	
Model	V1020D-US
Manufacturer	PHIHONG TECHNOLOGY CO LTD
AE5	
Model	B-T6
Manufacturer	Dongguan NVT Technology Co.,Ltd
Typical capacity	5000mAh
AE7	
Model	BK-C-32
Manufacturer	vivo

*AE ID: is used to identify the test sample in the lab internally.

3.4. General Description

Equipment Under Test (EUT) is a model of Mobile Phone with integrated antenna. It consists of normal options: Battery and Charger.

Manual and specifications of the EUT were provided to fulfil the test.

Samples undergoing test were selected by the Client.

4. REFERENCE DOCUMENTS

4.1. Documents supplied by applicant

EUT feature information is supplied by the applicant or manufacturer, which is the basis of testing.

4.2. Reference Documents for testing

The following documents listed in this section are referred for testing.

FCC Part15	FCC CFR 47, Part 15, Subpart C and E: 15.205 Restricted bands of operation; 15.209 Radiated emission limits, general requirements; 15.407 General technical requirements	2018
ANSI C63.10	Methods of Measurement of Radio-Noise Emissions from Low-Voltage Electrical and Electronic Equipment in the Range of 9 kHz to 40 GHz	2013
UNII: KDB 789033 D02	General U-NII Test Procedures New Rules v02r01	2017-12

5. LABORATORY ENVIRONMENT

Conducted RF performance testing is performed in shielding room.

EMC performance testing is performed in Semi-anechoic chamber.

6. SUMMARY OF TEST RESULTS

6.1. Summary of Test Results

SUMMARY OF MEASUREMENT RESULTS	Sub-clause of Part15C	Sub-clause of IC	Verdict
Maximum Peak Output Power	15.407 (a)	/	P
Peak Power Spectral Density	15.407 (a)	/	P
Occupied 6dB Bandwidth	15.407 (e)	/	P
Band Edges Compliance - Conducted& Radiated	15.407 (b)	/	P
Transmitter Spurious Emission - Conducted	15.407	/	P
Transmitter Spurious Emission - Radiated	15.407, 15.205, 15.209	/	P
AC Powerline Conducted Emission	15.107, 15.207	/	P

Please refer to **ANNEX A** for detail.

Terms used in Verdict column

P	Pass, The EUT complies with the essential requirements in the standard.
NM	Not measured, The test was not measured by CTTL
NA	Not Applicable, The test was not applicable
F	Fail, The EUT does not comply with the essential requirements in the standard

6.2. Statements

CTTL has evaluated the test cases requested by the client/manufacturer as listed in section 6.1 of this report for the EUT specified in section 3 according to the standards or reference documents listed in section 4.1.

This report only deals with the WLAN function among the features described in section 3.

The Equipment Under Test (EUT) model V2160 (FCC ID: 2AUCY-V2127) is a variant product of V2127 (FCC ID: 2AUCY-V2127), according to the declaration of changes provided by the applicant and FCC KDB publication 178919 D01, all the test results are derived from test report No.I21Z62219-IOT03, except the following result:

EUT set-up No	Function	Test Item
UT04a(I22Z60871)+ V1020D-US	802.11a	CE

The Other results are cited from the initial model. The report number for initial model is I21Z62219-IOT03.

6.3. Test Conditions

For this report, all the test cases are tested under normal temperature and normal voltage, and also under norm humidity, the specific condition is shown as follows:

Temperature	26°C
Voltage	3.87 V
Humidity	44%

7. TEST EQUIPMENTS UTILIZED

Equipment of I21Z62219

Conducted test system

No.	Equipment	Model	Serial Number	Manufacturer	Calibration Period	Calibration Due date
1	Vector Signal Analyzer	FSQ40	200089	Rohde & Schwarz	1 year	2022-05-24
2	LISN	ENV216	101200	R&S	1 year	2022-05-30
3	Test Receiver	ESC17	100344	R&S	1 year	2022-02-23
4	Shielding Room	S81	/	ETS-Lindgren	/	/
5	Attenuator	K40	/	Rosenberger	/	/

Radiated emission test system

No.	Equipment	Model	Serial Number	Manufacturer	Calibration Period	Calibration Due date
1	Test Receiver	ESU26	100235	R&S	1 year	2022-02-23
2	BiLog Antenna	VULB9163	01223	Schwarzbeck	1 year	2022-03-22
3	Dual-Ridge Waveguide Horn Antenna	3115	6914	ETS-Lindgren	1 year	2022-02-03
4	EMI Antenna	3116	2661	ETS-Lindgren	1 year	2022-01-05
5	Spectrum Analyzer	FSV40	101047	Rohde & Schwarz	1 year	2022-06-03

Equipment of I22Z60871

Conducted test system

No.	Equipment	Model	Serial Number	Manufacturer	Calibration Period	Calibration Due date
2	LISN	ENV216	101200	R&S	1 year	2022-05-30
3	Test Receiver	ESC17	100344	R&S	1 year	2023-03-21

8. Measurement Uncertainty

8.1. Transmitter Output Power

Measurement Uncertainty: 0.387dB,k=1.96

8.2. Peak Power Spectral Density

Measurement Uncertainty: 0.705dB,k=1.96

8.3. Occupied 6dB Bandwidth

Measurement Uncertainty: 60.80Hz,k=1.96

8.4. Band Edges Compliance

Measurement Uncertainty : 0.62dB,k=1.96

8.5. Spurious Emissions

Conducted (k=1.96)

Frequency Range	Uncertainty(dB)
$30\text{MHz} \leq f \leq 2\text{GHz}$	1.22
$2\text{GHz} \leq f \leq 3.6\text{GHz}$	1.22
$3.6\text{GHz} \leq f \leq 8\text{GHz}$	1.22
$8\text{GHz} \leq f \leq 12.75\text{GHz}$	1.51
$12.75\text{GHz} \leq f \leq 26\text{GHz}$	1.51
$26\text{GHz} \leq f \leq 40\text{GHz}$	1.59

Radiated (k=2)

Frequency Range	Uncertainty(dB)
9kHz-30MHz	4.92
$30\text{MHz} \leq f \leq 1\text{GHz}$	5.18
$1\text{GHz} \leq f \leq 18\text{GHz}$	5.54
$18\text{GHz} \leq f \leq 40\text{GHz}$	5.26

8.6. AC Power-line Conducted Emission

Measurement Uncertainty : 3.08dB,k=2

ANNEX A: MEASUREMENT RESULTS

A.1. Measurement Method

A.1.1. Conducted Measurements

- 1). Connect the EUT to the test system correctly.
- 2). Set the EUT to the required work mode.
- 3). Set the EUT to the required channel.
- 4). Set the spectrum analyzer to start measurement.
- 5). Record the values. Vector Signal Analyzer

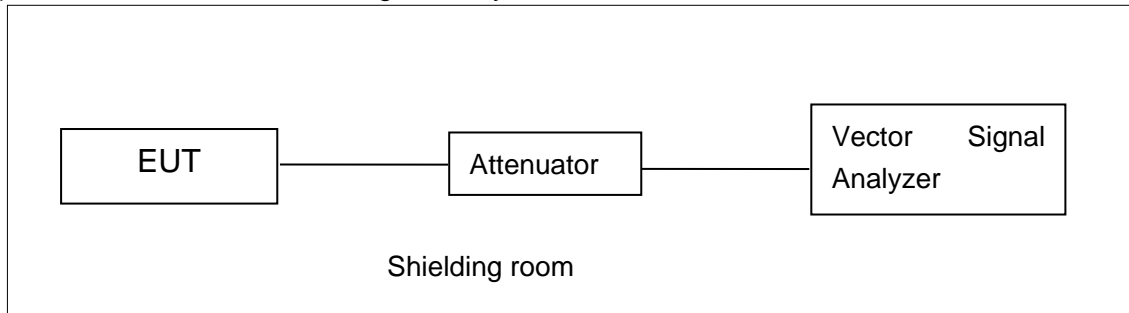

The measurement is made according to ANSI C63.10.

A.1.2. Radiated Emission Measurements

In the case of radiated emission, the used settings are as follows,

Sweep frequency from 30 MHz to 1GHz, RBW = 100 kHz, VBW = 300 kHz;

Sweep frequency from 1 GHz to 26GHz, RBW = 1MHz, VBW = 10Hz;

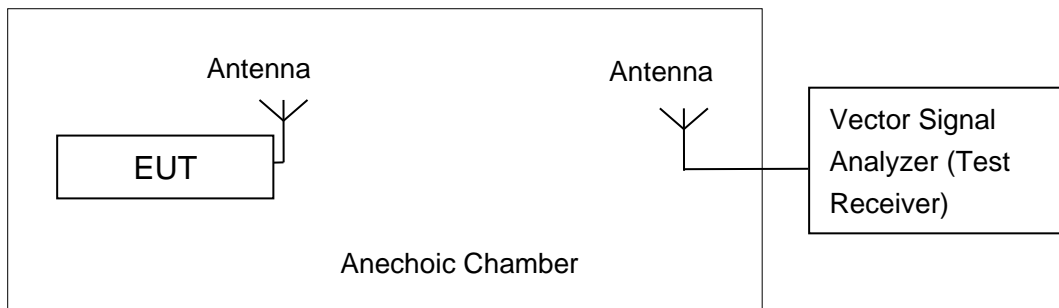

The measurement is made according to ANSI C63.10.

The radiated emission test is performed in semi-anechoic chamber. The distance from the EUT to the reference point of measurement antenna is 3m. The test is carried out on both vertical and horizontal polarization and only maximization result of both polarizations is kept. During the test, the turntable is rotated 360° and the measurement antenna is moved from 1m to 4m to get the maximization result.

A.2. Maximum Peak Output Power

Measurement Limit and Method:

Standard	Limit (dBm)
FCC CRF Part 15.407(a)	< 30

A.2.1 Antenna Gain

Antenna gain is -3 dBi and the value is supplied by the applicant or manufacturer.

A.2.2. Maximum Peak Output Power-conducted

Note:

The following test results were tested at 100% duty cycle

Measurement Results:

802.11a mode

Mode	Data Rate (Mbps)	Test Result (dBm)		
		5745MHz (Ch149)	5785MHz (Ch157)	5825MHz (Ch165)
802.11a	6	18.28	17.72	18.06
	9	/	/	/
	12	/	/	/
	18	/	/	/
	24	/	/	/
	36	/	/	/
	48	/	/	/
	54	/	/	/

The data rate 6 Mbps is selected as worse condition, and the following cases are performed with this condition.

802.11n-HT20 mode

Mode	Data Rate (Index)	Test Result (dBm)		
		5745MHz (Ch149)	5785MHz (Ch157)	5825MHz (Ch165)
802.11n (20MHz)	MCS0	16.41	16.50	16.26
	MCS1	/	/	/
	MCS2	/	/	/
	MCS3	/	/	/
	MCS4	/	/	/
	MCS5	/	/	/
	MCS6	/	/	/
	MCS7	/	/	/

The data rate MCS0 is selected as worse condition, and the following cases are performed with this condition.

802.11ac-HT20 mode

Mode	Data Rate (Index)	Test Result (dBm)		
		5745MHz (Ch149)	5785MHz (Ch157)	5825MHz (Ch165)
802.11ac (20MHz)	MCS0	16.04	15.85	16.22
	MCS1	/	/	/
	MCS2	/	/	/
	MCS3	/	/	/
	MCS4	/	/	/
	MCS5	/	/	/
	MCS6	/	/	/
	MCS7	/	/	/
	MCS8	/	/	/

The data rate MCS0 is selected as worse condition, and the following cases are performed with this condition.

802.11n-HT40 mode

Mode	Data Rate (Index)	Test Result (dBm)	
		5755MHz (Ch151)	5795MHz (Ch159)
802.11n (40MHz)	MCS0	16.16	16.22
	MCS1	/	/
	MCS2	/	/
	MCS3	/	/
	MCS4	/	/
	MCS5	/	/
	MCS6	/	/
	MCS7	/	/

The data rate MCS0 is selected as worse condition, and the following cases are performed with this condition.

802.11ac-HT40 mode

Mode	Data Rate (Index)	Test Result (dBm)	
		5755MHz (Ch151)	5795MHz (Ch159)
802.11ac (40MHz)	MCS0	15.63	15.66
	MCS1	/	/
	MCS2	/	/
	MCS3	/	/
	MCS4	/	/
	MCS5	/	/
	MCS6	/	/
	MCS7	/	/

	MCS8	/	/
	MCS9	/	/

The data rate MCS0 is selected as worse condition, and the following cases are performed with this condition.

802.11ac-HT80 mode

Mode	Data Rate (Index)	Test Result (dBm)
		5775MHz (Ch155)
802.11ac (80MHz)	MCS0	13.63
	MCS1	/
	MCS2	/
	MCS3	/
	MCS4	/
	MCS5	/
	MCS6	/
	MCS7	/
	MCS8	/
	MCS9	/

The data rate MCS0 is selected as worse condition, and the following cases are performed with this condition.

Conclusion: PASS

Test graphs as below:

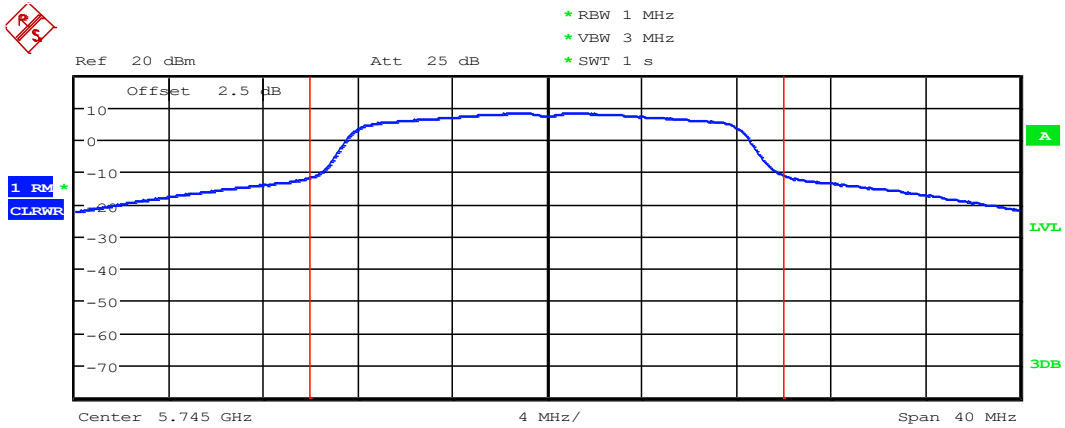

Tx Channel		WLAN 802.11A
Bandwidth	20 MHz	Power 18.28 dBm
Adjacent Channel		
Bandwidth	20 MHz	Lower -----
Spacing	20 MHz	Upper -----
Alternate Channel		
Bandwidth	20 MHz	Lower -----
Spacing	40 MHz	Upper -----

Date: 14.JAN.2022 04:59:14

802.11a 6Mbps ch149 5745MHz

A.3. Peak Power Spectral Density

Measurement Limit:

Standard	Limit
FCC 47 CFR Part 15.407(a)	< 30 dBm/500 kHz

The measurement is made according to ANSI C63.10 and KDB789033 D02

Measurement Uncertainty:

Measurement Uncertainty	0.75dB
-------------------------	--------

Measurement Results:

Mode	Channel	Power Spectral Density (dBm/500kHz)	Conclusion
802.11a	149	6.19	P
	157	5.85	P
	165	6.14	P
802.11n HT20	149	5.01	P
	157	4.98	P
	165	5.08	P
802.11n HT40	151	1.97	P
	159	1.92	P
802.11ac HT80	155	4.56	P

Conclusion: PASS

Test graphs as below:

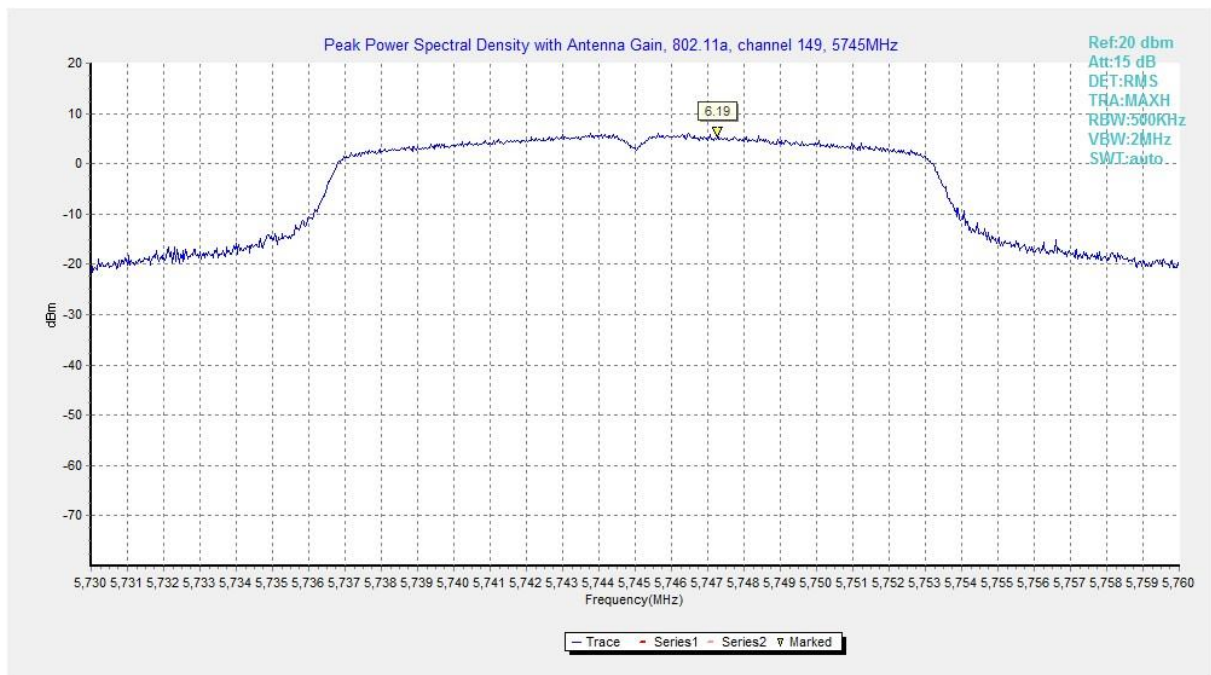

802.11a 6Mbps ch149 5745MHz

A.4. Occupied 6dB Bandwidth

Measurement Limit:

Standard	Limit (kHz)
FCC 47 CFR Part 15.407 (e)	≥ 500

The measurement is made according to KDB789033 D02 .

Measurement Uncertainty:

Measurement Uncertainty	60.80Hz
-------------------------	---------

Measurement Result:

Mode	Channel	Occupied 6dB Bandwidth (MHz)		conclusion
802.11a	149	Fig.1	16.35	P
	157	Fig.2	16.35	P
	165	Fig.3	16.35	P
802.11n HT20	149	Fig.4	17.60	P
	157	Fig.5	17.55	P
	165	Fig.6	17.55	P
802.11n HT40	151	Fig.7	36.32	P
	159	Fig.8	36.32	P
802.11ac HT80	155	Fig.9	76.32	P

Conclusion: PASS

Test graphs as below:

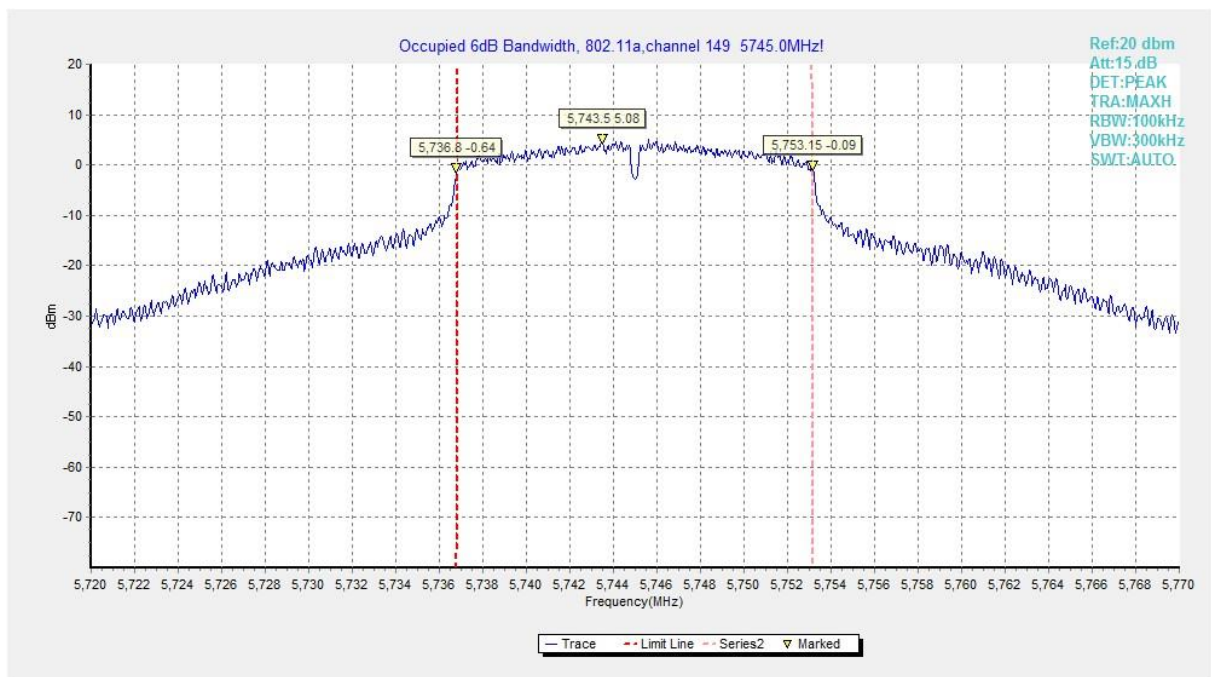

Fig. 1 Occupied 6dB Bandwidth (802.11a, Ch 149)

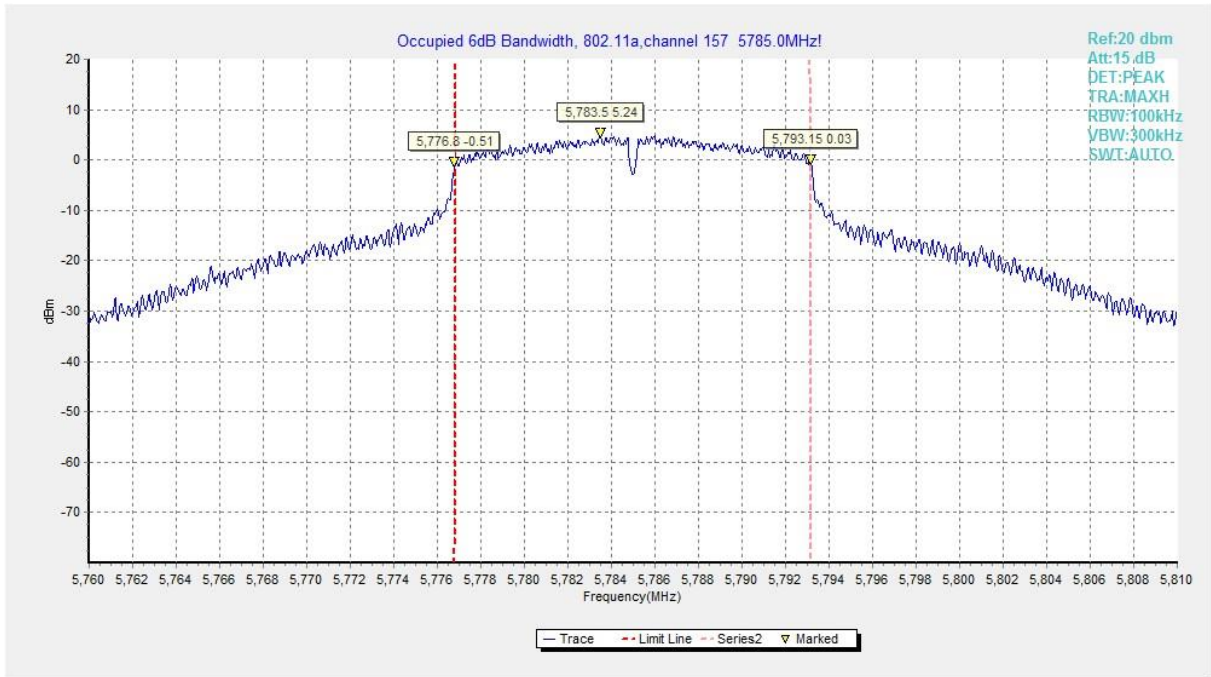

Fig. 2 Occupied 6dB Bandwidth (802.11a, Ch 157)

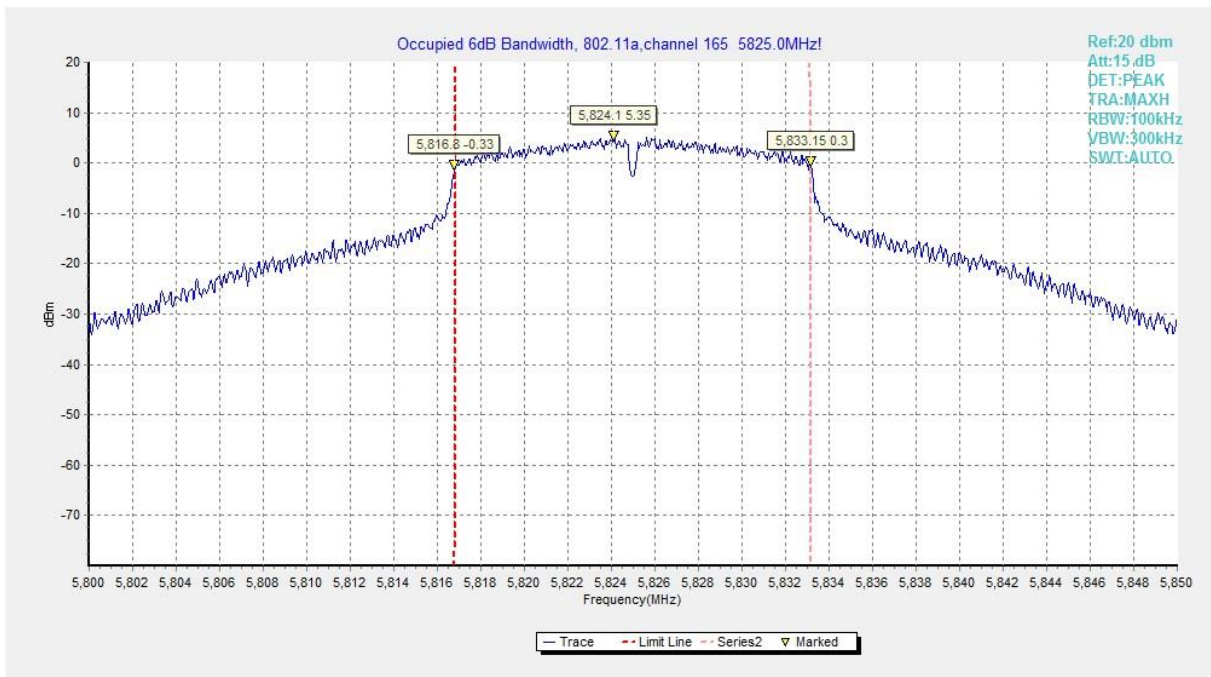

Fig. 3 Occupied 6dB Bandwidth (802.11a, Ch 165)

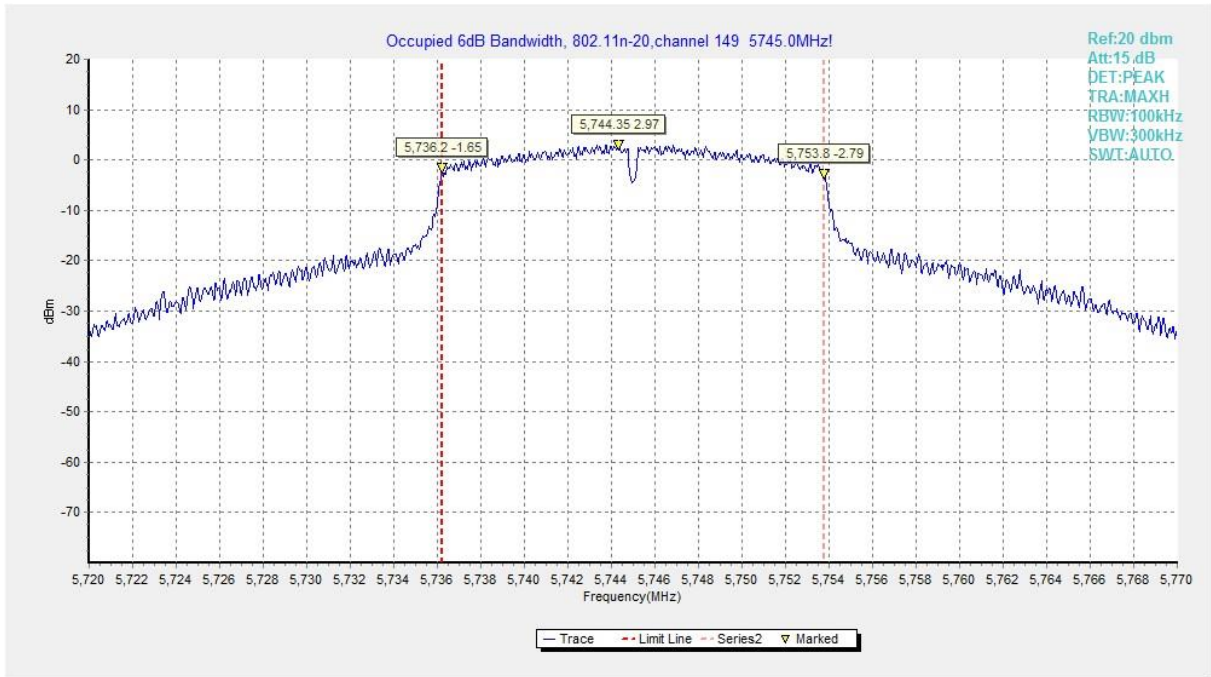

Fig. 4 Occupied 6dB Bandwidth (802.11n-HT20, Ch 149)

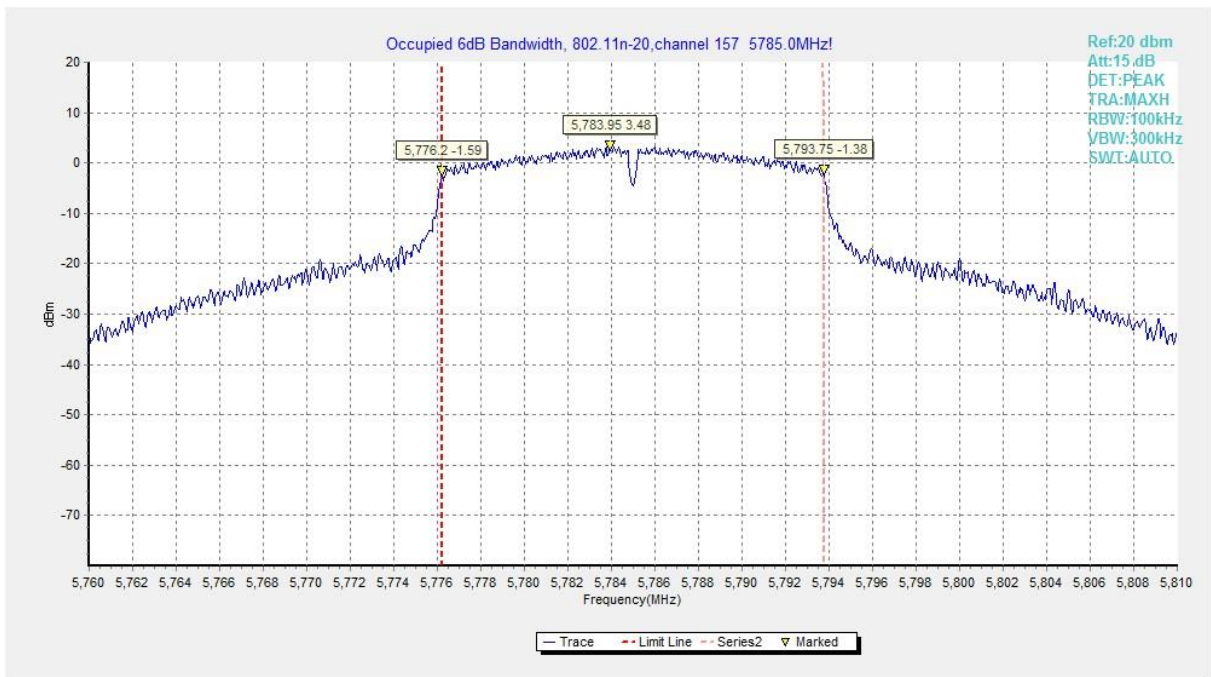

Fig. 5 Occupied 6dB Bandwidth (802.11n-HT20, Ch 157)

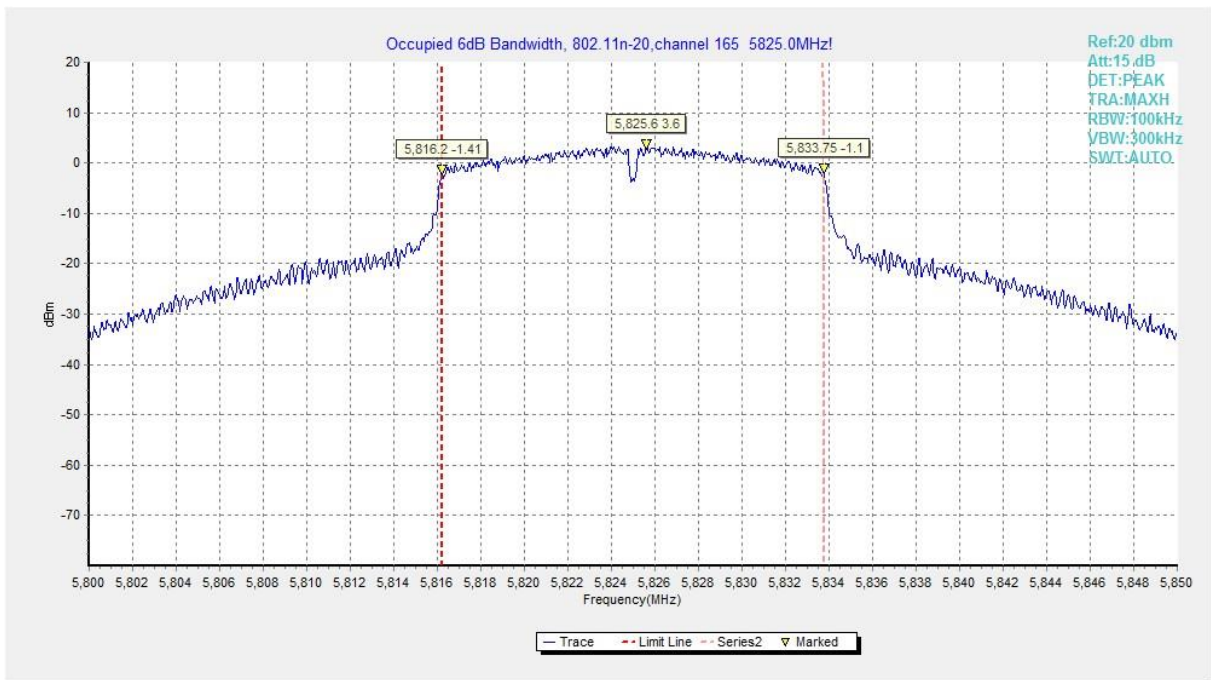

Fig. 6 Occupied 6dB Bandwidth (802.11n-HT20, Ch 165)

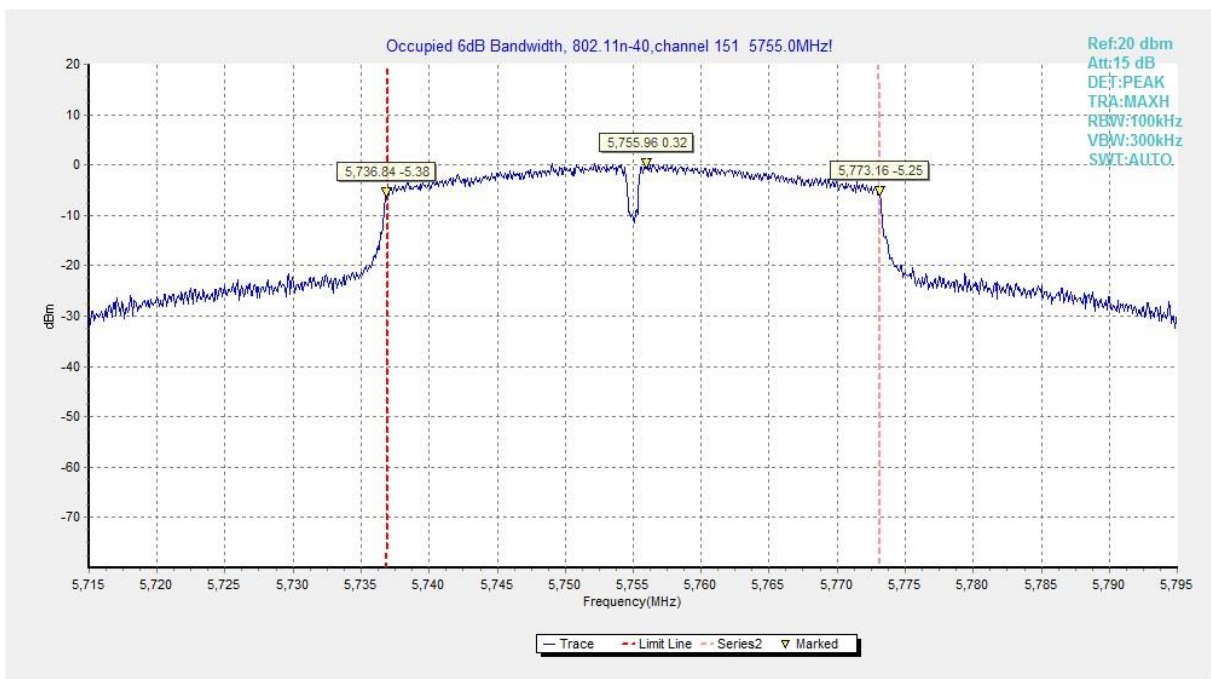

Fig. 7 Occupied 6dB Bandwidth (802.11n-HT40, Ch 151)

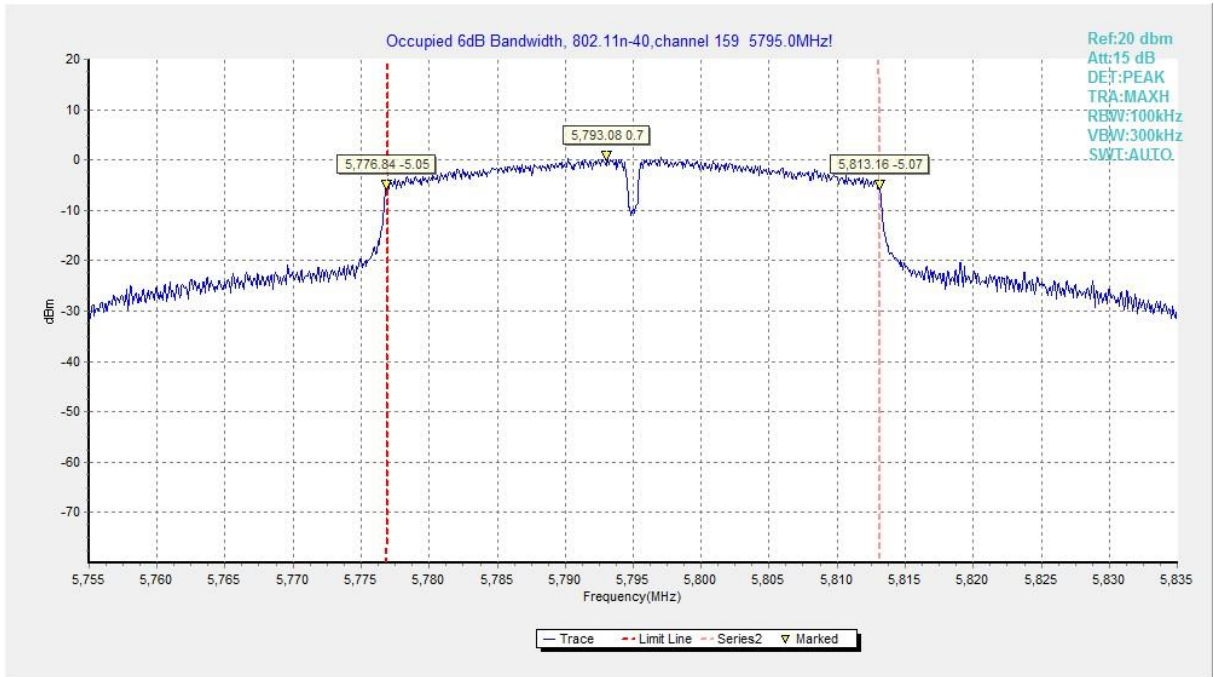

Fig. 8 Occupied 6dB Bandwidth (802.11n-HT40, Ch 159)

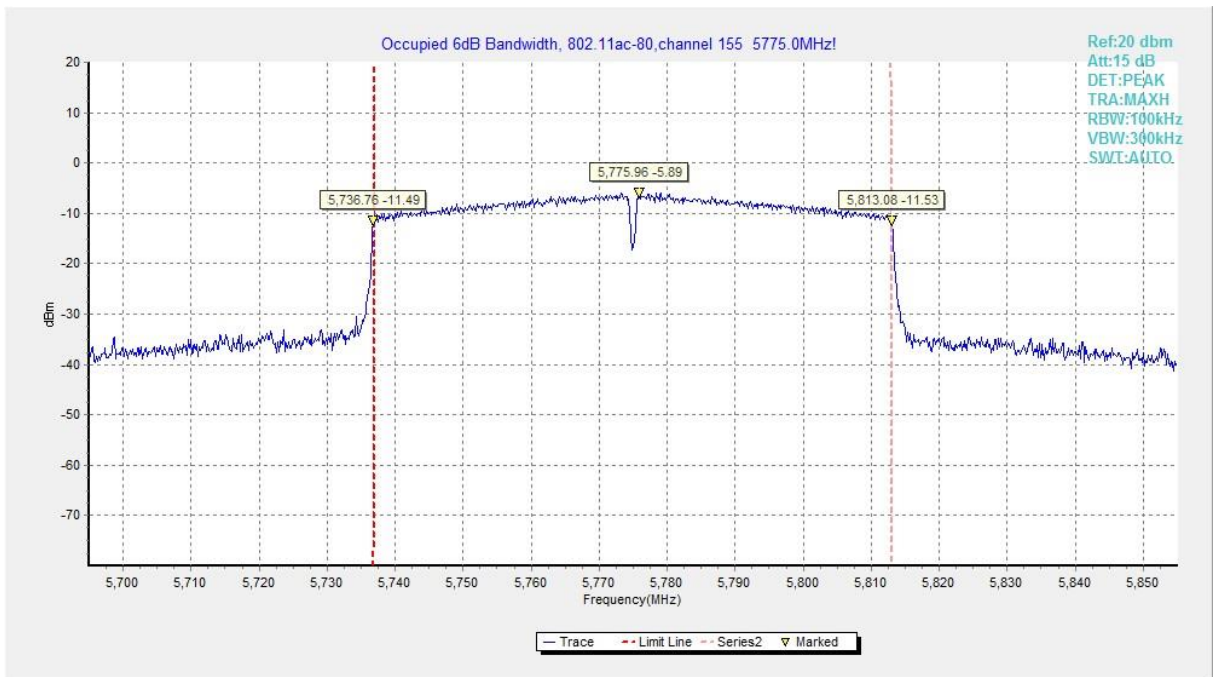

Fig. 9 Occupied 6dB Bandwidth (802.11ac-HT80, Ch 155)

A.5. Transmitter Spurious Emission

A.5.1 Transmitter Spurious Emission - Radiated

Method of Measurement: See ANSI C63.10-2013-clause 6.4 & 6.5 & 6.6

Measurement Limit:

Standard	Limit
FCC 47 CFR Part 15.247, 15.205, 15.209	20dB below peak output power

radiated emissions which fall in the restricted bands, as defined in § 15.205(a), must also comply with the radiated emission limits specified in § 15.209(a) (see § 15.205(c)).

Limit in restricted band:

Frequency (MHz)	Field strength(μ V/m)	Measurement distance (m)
0.009 - 0.490	2400/F(kHz)	300
0.490 - 1.705	24000/F(kHz)	30
1.705 – 30.0	30	30

Frequency of emission (MHz)	Field strength(μ V/m)	Field strength(dBuV/m)
30-88	100	40
88-216	150	43.5
216-960	200	46
Above 960	500	54

Set up:

Tabletop devices shall be placed on a nonconducting platform with nominal top surface dimensions 1 m by 1.5 m. For emissions testing at or below 1 GHz, the table height shall be 80 cm above the reference ground plane. For emission measurements above 1 GHz, the table height shall be 1.5 m

The EUT and transmitting antenna shall be centered on the turntable.

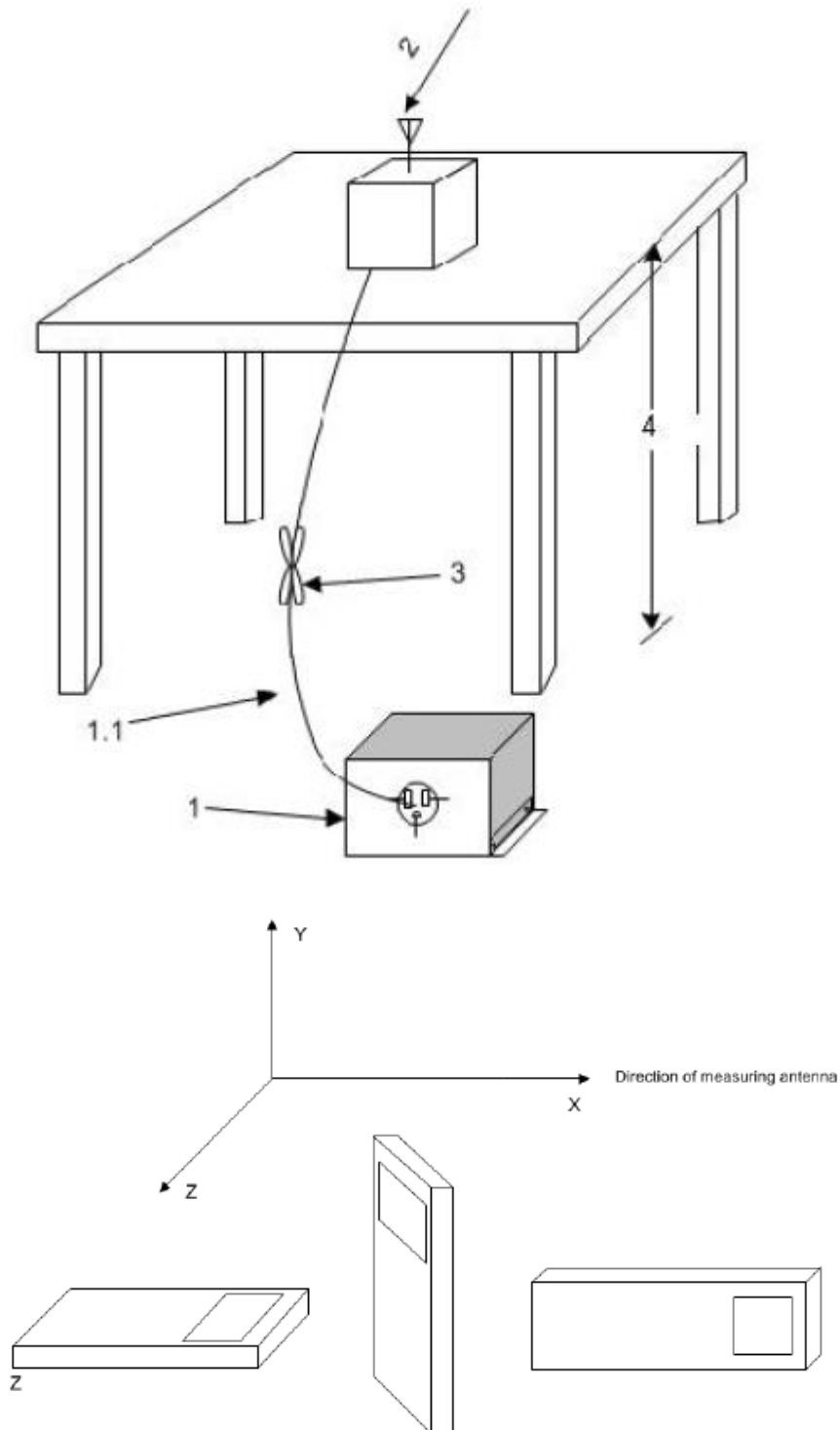

Test Condition

The EUT shall be tested 1 near top, 1 near middle, and 1 near bottom. Set the unlicensed wireless device to operate in continuous transmit mode. For unlicensed wireless devices unable to be configured for 100% duty cycle even in test mode, configure the system for the maximum duty cycle supported.

When required for unlicensed wireless devices, measurements of the variation of the input power or the radiated signal level of the fundamental frequency component of the emission, as appropriate, shall be performed with the supply voltage varied between 85% and 115% of the

nominal rated supply voltage.

Exploratory radiated emissions measurements

Exploratory radiated measurements shall be performed at the measurement distance or at a closer distance than that specified for compliance to determine the emission characteristics of the EUT and, if applicable, the EUT configuration that produces the maximum level of emissions. The frequencies of maximum emission may be determined by manually positioning the antenna close to the EUT, and then moving the antenna over all sides of the EUT while observing a spectral display. It is advantageous to have prior knowledge of the frequencies of emissions, although this may be determined from such a near-field scan. The near-field scan shall only be used to determine the frequency but not the amplitude of the emissions. Where exploratory measurements are not adequate to determine the worst-case operating modes and are used only to identify the frequencies of the highest emissions, additional preliminary tests can be required.

For emissions from the EUT, the maximum level shall be determined by rotating the EUT and its antenna through 0° to 360°. For each mode of operation required to be tested, the frequency spectrum (based on findings from exploratory measurements) shall be monitored.

Broadband antennas and a spectrum analyzer or a radio-noise meter with a panoramic display are often useful in this type of test. If either antenna height or EUT azimuth are not fully measured during exploratory testing, then complete testing can be required at the OATS or semi-anechoic chamber when the final full spectrum testing is performed.

Final radiated emissions measurements

The final measurements are using the orientation and equipment arrangement of the EUT based on the measurement results found during the preliminary (exploratory) measurements, the EUT arrangement, appropriate modulation, and modes of operation that produce the emissions that have the highest amplitude relative to the limit shall be selected for the final measurement.

For each mode of operation required to be tested, the frequency spectrum (based on findings from exploratory measurements) shall be monitored. The highest signal levels relative to the limit shall be determined by rotating the EUT from 0° to 360° and with varying the measurement antenna height between 1 m and 4 m in vertical and horizontal polarizations.

For each mode selected, record the frequency and amplitude of the highest fundamental emission (if applicable), as well as the frequency and amplitude of the six highest spurious emissions relative to the limit. Emissions more than 20 dB below the limit do not need to be reported.

This maximization process was repeated with the EUT positioned in each of its three orthogonal orientations.

The receiver references:

Frequency of emission (MHz)	RBW/VBW	Sweep Time(s)
30-1000	100KHz/300KHz	5
1000-4000	1MHz/3MHz	15
4000-18000	1MHz/3MHz	40
18000-40000	1MHz/3MHz	20

P_{Mea} is the field strength recorded from the instrument.

The measurement results are obtained as described below:

Result= P_{Mea} + Cable Loss + Antenna Factor

Where:

P_{Mea} field strength recorded from the instrument

Conclusion: PASS

EUT ID: UT04a

Average Results:

802.11a

Ch149

Frequency (MHz)	Measurement Result (dB μ V/m)	Cable loss (dB)	Antenna Factor (dB/m)	Receiver Reading (dB μ V)	Limit (dB μ V/m)	Margin (dB)	Antenna Pol. (H/V)
17997.20	41.90	-25.50	46.66	20.74	54.00	12.10	V
17973.00	41.87	-25.50	46.66	20.71	54.00	12.13	H
13262.30	37.25	-29.67	39.55	27.37	54.00	16.75	V
13252.40	37.24	-29.67	39.55	27.36	54.00	16.76	V
11819.10	36.12	-31.85	39.05	28.92	54.00	17.88	V
11825.20	36.03	-31.85	39.05	28.83	54.00	17.97	H

Ch157

Frequency (MHz)	Measurement Result (dB μ V/m)	Cable loss (dB)	Antenna Factor (dB/m)	Receiver Reading (dB μ V)	Limit (dB μ V/m)	Margin (dB)	Antenna Pol. (H/V)
17994.50	41.90	-25.50	46.66	20.74	54.00	12.10	V
17996.20	41.85	-25.50	46.66	20.69	54.00	12.15	V
13352.50	37.25	-29.49	39.71	27.03	54.00	16.75	V
13326.60	37.23	-29.49	39.71	27.01	54.00	16.77	H
11816.90	36.13	-31.85	39.05	28.93	54.00	17.87	V
11810.30	36.06	-31.85	39.05	28.86	54.00	17.94	V

Ch165

Frequency (MHz)	Measurement Result (dB μ V/m)	Cable loss (dB)	Antenna Factor (dB/m)	Receiver Reading (dB μ V)	Limit (dB μ V/m)	Margin (dB)	Antenna Pol. (H/V)
17984.00	41.89	-25.50	46.66	20.73	54.00	12.11	H
17996.20	41.87	-25.50	46.66	20.71	54.00	12.13	H
13277.10	37.20	-29.67	39.55	27.32	54.00	16.80	V
13250.80	37.18	-29.67	39.55	27.30	54.00	16.82	V
11891.20	36.09	-31.85	39.05	28.89	54.00	17.91	V
11841.10	36.05	-31.85	39.05	28.85	54.00	17.95	V

802.11n-HT20

Ch149

Frequency (MHz)	Measurement Result (dBμV/m)	Cable loss (dB)	Antenna Factor (dB/m)	Receiver Reading (dBμV)	Limit (dBμV/m)	Margin (dB)	Antenna Pol. (H/V)
17974.20	41.95	-25.50	46.66	20.79	54.00	12.05	V
17985.70	41.87	-25.50	46.66	20.71	54.00	12.13	V
15652.00	37.24	-27.23	38.61	25.86	54.00	16.76	H
13253.00	37.21	-29.67	39.55	27.33	54.00	16.79	H
11808.10	36.07	-31.85	39.05	28.87	54.00	17.93	H
11795.50	36.05	-31.85	39.05	28.85	54.00	17.95	V

Ch157

Frequency (MHz)	Measurement Result (dBμV/m)	Cable loss (dB)	Antenna Factor (dB/m)	Receiver Reading (dBμV)	Limit (dBμV/m)	Margin (dB)	Antenna Pol. (H/V)
17990.70	41.86	-25.50	46.66	20.70	54.00	12.14	V
17994.50	41.85	-25.50	46.66	20.69	54.00	12.15	H
13259.50	37.29	-29.67	39.55	27.41	54.00	16.71	H
15652.60	37.26	-27.23	38.61	25.88	54.00	16.74	H
11821.30	36.03	-31.85	39.05	28.83	54.00	17.97	H
11818.60	35.97	-31.85	39.05	28.77	54.00	18.03	V

Ch165

Frequency (MHz)	Measurement Result (dBμV/m)	Cable loss (dB)	Antenna Factor (dB/m)	Receiver Reading (dBμV)	Limit (dBμV/m)	Margin (dB)	Antenna Pol. (H/V)
17991.80	42.00	-25.50	46.66	20.84	54.00	12.00	V
17987.30	41.97	-25.50	46.66	20.81	54.00	12.03	V
13256.80	37.41	-29.67	39.55	27.53	54.00	16.59	H
13262.90	37.37	-29.67	39.55	27.49	54.00	16.63	V
11887.90	36.03	-31.85	39.05	28.83	54.00	17.97	V
11822.40	36.02	-31.85	39.05	28.82	54.00	17.98	H

802.11n-HT40

Ch151

Frequency (MHz)	Measurement Result (dBμV/m)	Cable loss (dB)	Antenna Factor (dB/m)	Receiver Reading (dBμV)	Limit (dBμV/m)	Margin (dB)	Antenna Pol. (H/V)
17983.50	42.00	-25.50	46.66	20.84	54.00	12.00	V
17988.50	42.00	-25.50	46.66	20.84	54.00	12.00	V
13251.90	37.50	-29.67	39.55	27.62	54.00	16.50	V
13265.00	37.38	-29.67	39.55	27.50	54.00	16.62	H
11820.20	36.08	-31.85	39.05	28.88	54.00	17.92	V
11823.00	35.99	-31.85	39.05	28.79	54.00	18.01	V

Ch159

Frequency (MHz)	Measurement Result (dBμV/m)	Cable loss (dB)	Antenna Factor (dB/m)	Receiver Reading (dBμV)	Limit (dBμV/m)	Margin (dB)	Antenna Pol. (H/V)
17982.40	42.11	-25.50	46.66	20.95	54.00	11.89	V
17995.60	42.07	-25.50	46.66	20.91	54.00	11.93	H
13345.40	37.46	-29.49	39.71	27.24	54.00	16.54	V
16050.80	37.35	-27.35	38.54	26.16	54.00	16.65	V
11818.60	36.03	-31.85	39.05	28.83	54.00	17.97	V
11820.20	36.02	-31.85	39.05	28.82	54.00	17.98	V

802.11ac-HT20

Ch149

Frequency (MHz)	Measurement Result (dBμV/m)	Cable loss (dB)	Antenna Factor (dB/m)	Receiver Reading (dBμV)	Limit (dBμV/m)	Margin (dB)	Antenna Pol. (H/V)
17995.60	41.82	-25.50	46.66	20.66	54.00	12.18	V
17964.80	41.81	-25.50	46.66	20.65	54.00	12.19	V
13323.90	37.32	-29.49	39.71	27.10	54.00	16.68	H
13266.70	37.30	-29.67	39.55	27.42	54.00	16.70	H
11801.50	36.08	-31.85	39.05	28.88	54.00	17.92	H
11829.60	35.98	-31.85	39.05	28.78	54.00	18.02	V

Ch157

Frequency (MHz)	Measurement Result (dB μ V/m)	Cable loss (dB)	Antenna Factor (dB/m)	Receiver Reading (dB μ V)	Limit (dB μ V/m)	Margin (dB)	Antenna Pol. (H/V)
17989.50	41.91	-25.50	46.66	20.75	54.00	12.09	H
17994.00	41.90	-25.50	46.66	20.74	54.00	12.10	V
13257.90	37.25	-29.67	39.55	27.37	54.00	16.75	H
13360.20	37.22	-29.49	39.71	27.00	54.00	16.78	H
11820.80	36.09	-31.85	39.05	28.89	54.00	17.91	H
11819.70	36.05	-31.85	39.05	28.85	54.00	17.95	H

Ch165

Frequency (MHz)	Measurement Result (dB μ V/m)	Cable loss (dB)	Antenna Factor (dB/m)	Receiver Reading (dB μ V)	Limit (dB μ V/m)	Margin (dB)	Antenna Pol. (H/V)
17984.00	42.02	-25.50	46.66	20.86	54.00	11.98	V
17989.00	41.90	-25.50	46.66	20.74	54.00	12.10	V
13263.40	37.26	-29.67	39.55	27.38	54.00	16.74	H
13297.50	37.14	-29.49	39.71	26.92	54.00	16.86	H
11834.50	35.97	-31.85	39.05	28.77	54.00	18.03	V
11838.90	35.97	-31.85	39.05	28.77	54.00	18.03	H

802.11ac-HT40

Ch151

Frequency (MHz)	Measurement Result (dB μ V/m)	Cable loss (dB)	Antenna Factor (dB/m)	Receiver Reading (dB μ V)	Limit (dB μ V/m)	Margin (dB)	Antenna Pol. (H/V)
17983.00	41.93	-25.50	46.66	20.77	54.00	12.07	H
17986.80	41.93	-25.50	46.66	20.77	54.00	12.07	H
15947.40	37.43	-27.35	38.54	26.24	54.00	16.57	H
13378.90	37.34	-29.49	39.71	27.12	54.00	16.66	H
11820.20	36.02	-31.85	39.05	28.82	54.00	17.98	H
11814.20	35.99	-31.85	39.05	28.79	54.00	18.01	H

Ch159

Frequency (MHz)	Measurement Result (dBμV/m)	Cable loss (dB)	Antenna Factor (dB/m)	Receiver Reading (dBμV)	Limit (dBμV/m)	Margin (dB)	Antenna Pol. (H/V)
17997.20	42.65	-25.50	46.66	21.49	54.00	11.35	H
17983.50	42.61	-25.50	46.66	21.45	54.00	11.39	V
16142.10	38.30	-26.77	38.93	26.14	54.00	15.70	H
13336.00	38.28	-29.49	39.71	28.06	54.00	15.72	H
11837.30	36.80	-31.85	39.05	29.60	54.00	17.20	H
11830.10	36.76	-31.85	39.05	29.56	54.00	17.24	V

802.11ac-HT80

Ch155

Frequency (MHz)	Measurement Result (dBμV/m)	Cable loss (dB)	Antenna Factor (dB/m)	Receiver Reading (dBμV)	Limit (dBμV/m)	Margin (dB)	Antenna Pol. (H/V)
17973.60	42.58	-25.50	46.66	21.42	54.00	11.42	H
17997.80	42.56	-25.50	46.66	21.40	54.00	11.44	H
13278.20	37.89	-29.67	39.55	28.01	54.00	16.11	H
13353.60	37.88	-29.49	39.71	27.66	54.00	16.12	V
11813.60	36.39	-31.85	39.05	29.19	54.00	17.61	H
11814.20	36.39	-31.85	39.05	29.19	54.00	17.61	V

Peak Results:
802.11a

Ch149

Frequency (MHz)	Measurement Result (dBμV/m)	Cable loss (dB)	Antenna Factor (dB/m)	Receiver Reading (dBμV)	Limit (dBμV/m)	Margin (dB)	Antenna Pol. (H/V)
17918.00	54.57	-25.50	46.66	33.41	74.00	19.43	H
17984.60	54.23	-25.50	46.66	33.07	74.00	19.77	H
16567.20	52.03	-26.87	40.65	38.25	68.30	16.27	H
16922.50	51.91	-26.32	42.36	35.86	68.30	16.39	H
11798.20	48.69	-31.85	39.05	41.49	74.00	25.31	V
11860.90	48.52	-31.85	39.05	41.32	74.00	25.48	H

Ch157

Frequency (MHz)	Measurement Result (dB μ V/m)	Cable loss (dB)	Antenna Factor (dB/m)	Receiver Reading (dB μ V)	Limit (dB μ V/m)	Margin (dB)	Antenna Pol. (H/V)
17994.50	54.44	-25.50	46.66	33.28	74.00	19.56	V
17984.60	54.10	-25.50	46.66	32.94	74.00	19.90	V
16435.20	52.30	-26.96	39.82	39.44	68.30	16.00	H
16740.50	51.67	-26.62	41.49	36.80	68.30	16.63	H
11839.50	49.13	-31.85	39.05	41.93	74.00	24.87	V
11233.40	49.06	-32.36	38.77	42.66	74.00	24.94	V

Ch165

Frequency (MHz)	Measurement Result (dB μ V/m)	Cable loss (dB)	Antenna Factor (dB/m)	Receiver Reading (dB μ V)	Limit (dB μ V/m)	Margin (dB)	Antenna Pol. (H/V)
17963.70	54.69	-25.50	46.66	33.53	74.00	19.31	V
17937.80	54.24	-25.50	46.66	33.08	74.00	19.76	H
16574.40	52.93	-26.87	40.65	39.15	68.30	15.37	H
16744.90	52.08	-26.62	41.49	37.21	68.30	16.22	H
11805.90	48.85	-31.85	39.05	41.65	74.00	25.15	H
11893.40	48.76	-31.85	39.05	41.56	74.00	25.24	H

802.11n-HT20

Ch149

Frequency (MHz)	Measurement Result (dB μ V/m)	Cable loss (dB)	Antenna Factor (dB/m)	Receiver Reading (dB μ V)	Limit (dB μ V/m)	Margin (dB)	Antenna Pol. (H/V)
17387.30	54.93	-25.95	44.35	36.52	68.30	13.37	V
17954.30	54.04	-25.50	46.66	32.88	74.00	19.96	H
16432.50	51.72	-26.96	39.82	38.86	68.30	16.58	H
16528.20	51.54	-26.96	39.82	38.68	68.30	16.76	V
11889.50	48.62	-31.85	39.05	41.42	74.00	25.38	H
11746.00	48.59	-31.99	38.98	41.60	74.00	25.41	H

Ch157

Frequency (MHz)	Measurement Result (dB μ V/m)	Cable loss (dB)	Antenna Factor (dB/m)	Receiver Reading (dB μ V)	Limit (dB μ V/m)	Margin (dB)	Antenna Pol. (H/V)
17990.10	54.33	-25.50	46.66	33.17	74.00	19.67	V
17964.20	54.26	-25.50	46.66	33.10	74.00	19.74	H
16569.50	51.94	-26.87	40.65	38.16	68.30	16.36	H
16446.20	51.66	-26.96	39.82	38.80	68.30	16.64	H
11910.40	48.67	-31.85	39.05	41.47	74.00	25.33	V
11906.60	48.62	-31.85	39.05	41.42	74.00	25.38	V

Ch165

Frequency (MHz)	Measurement Result (dB μ V/m)	Cable loss (dB)	Antenna Factor (dB/m)	Receiver Reading (dB μ V)	Limit (dB μ V/m)	Margin (dB)	Antenna Pol. (H/V)
17958.80	54.36	-25.50	46.66	33.20	74.00	19.64	H
17409.80	54.34	-26.85	45.25	35.94	68.30	13.96	H
16732.80	52.21	-26.62	41.49	37.34	68.30	16.09	V
16564.50	52.14	-26.87	40.65	38.36	68.30	16.16	H
11681.10	48.54	-31.99	38.98	41.55	74.00	25.46	V
11798.80	48.42	-31.85	39.05	41.22	74.00	25.58	H

802.11n-HT40

Ch151

Frequency (MHz)	Measurement Result (dB μ V/m)	Cable loss (dB)	Antenna Factor (dB/m)	Receiver Reading (dB μ V)	Limit (dB μ V/m)	Margin (dB)	Antenna Pol. (H/V)
17906.50	54.62	-25.50	46.66	33.46	74.00	19.38	H
17937.30	54.36	-25.50	46.66	33.20	74.00	19.64	H
16665.70	51.98	-26.87	40.65	38.20	68.30	16.32	V
16553.50	51.86	-26.87	40.65	38.08	68.30	16.44	H
11387.90	48.71	-32.42	38.79	42.34	74.00	25.29	H
11781.20	48.61	-31.99	38.98	41.62	74.00	25.39	V

Ch159

Frequency (MHz)	Measurement Result (dB μ V/m)	Cable loss (dB)	Antenna Factor (dB/m)	Receiver Reading (dB μ V)	Limit (dB μ V/m)	Margin (dB)	Antenna Pol. (H/V)
17957.10	54.82	-25.50	46.66	33.66	74.00	19.18	H
17973.60	54.52	-25.50	46.66	33.36	74.00	19.48	H
16674.50	52.11	-26.87	40.65	38.33	68.30	16.19	H
16591.50	52.09	-26.87	40.65	38.31	68.30	16.21	H
11932.40	48.90	-31.48	39.09	41.29	74.00	25.10	V
11809.20	48.84	-31.85	39.05	41.64	74.00	25.16	V

802.11ac-HT20

Ch149

Frequency (MHz)	Measurement Result (dB μ V/m)	Cable loss (dB)	Antenna Factor (dB/m)	Receiver Reading (dB μ V)	Limit (dB μ V/m)	Margin (dB)	Antenna Pol. (H/V)
17954.30	54.37	-25.50	46.66	33.21	74.00	19.63	V
17903.80	54.25	-25.50	46.66	33.09	74.00	19.75	V
16516.10	52.78	-26.96	39.82	39.92	68.30	15.52	H
16504.50	51.85	-26.96	39.82	38.99	68.30	16.45	V
11876.30	49.55	-31.85	39.05	42.35	74.00	24.45	V
11917.00	48.54	-31.48	39.09	40.93	74.00	25.46	H

Ch157

Frequency (MHz)	Measurement Result (dB μ V/m)	Cable loss (dB)	Antenna Factor (dB/m)	Receiver Reading (dB μ V)	Limit (dB μ V/m)	Margin (dB)	Antenna Pol. (H/V)
17965.90	54.70	-25.50	46.66	33.54	74.00	19.30	V
17973.00	54.60	-25.50	46.66	33.44	74.00	19.40	H
16436.90	51.93	-26.96	39.82	39.07	68.30	16.37	H
13733.60	51.68	-29.10	40.86	39.91	68.30	16.62	V
11613.40	48.61	-32.31	38.91	42.02	74.00	25.39	V
11895.60	48.56	-31.85	39.05	41.36	74.00	25.44	V

Ch165

Frequency (MHz)	Measurement Result (dB μ V/m)	Cable loss (dB)	Antenna Factor (dB/m)	Receiver Reading (dB μ V)	Limit (dB μ V/m)	Margin (dB)	Antenna Pol. (H/V)
17991.80	54.28	-25.50	46.66	33.12	74.00	19.72	V
17921.90	54.13	-25.50	46.66	32.97	74.00	19.87	V
16527.70	52.31	-26.96	39.82	39.45	68.30	15.99	V
16758.70	52.00	-26.62	41.49	37.13	68.30	16.30	H
11928.60	49.09	-31.48	39.09	41.48	74.00	24.91	V
11797.10	49.02	-31.85	39.05	41.82	74.00	24.98	H

802.11ac-HT40

Ch151

Frequency (MHz)	Measurement Result (dB μ V/m)	Cable loss (dB)	Antenna Factor (dB/m)	Receiver Reading (dB μ V)	Limit (dB μ V/m)	Margin (dB)	Antenna Pol. (H/V)
17931.20	54.45	-25.50	46.66	33.29	74.00	19.55	H
17968.70	54.13	-25.50	46.66	32.97	74.00	19.87	H
16535.30	52.73	-26.96	39.82	39.87	68.30	15.57	V
16546.30	52.09	-26.87	40.65	38.31	68.30	16.21	H
11998.40	48.83	-31.48	39.09	41.22	74.00	25.17	H
11840.60	48.70	-31.85	39.05	41.50	74.00	25.30	H

Ch159

Frequency (MHz)	Measurement Result (dB μ V/m)	Cable loss (dB)	Antenna Factor (dB/m)	Receiver Reading (dB μ V)	Limit (dB μ V/m)	Margin (dB)	Antenna Pol. (H/V)
17966.50	55.19	-25.50	46.66	34.03	74.00	18.81	H
17980.20	55.04	-25.50	46.66	33.88	74.00	18.96	H
16578.20	52.64	-26.87	40.65	38.86	68.30	15.66	H
16749.80	52.61	-26.62	41.49	37.74	68.30	15.69	H
11231.20	49.37	-32.36	38.77	42.97	74.00	24.63	H
11905.50	49.00	-31.85	39.05	41.80	74.00	25.00	H

802.11ac-HT80

Ch155

Frequency (MHz)	Measurement Result (dBμV/m)	Cable loss (dB)	Antenna Factor (dB/m)	Receiver Reading (dBμV)	Limit (dBμV/m)	Margin (dB)	Antenna Pol. (H/V)
17985.70	54.79	-25.50	46.66	33.63	74.00	19.21	H
17986.20	54.76	-25.50	46.66	33.60	74.00	19.24	H
16589.20	52.83	-26.87	40.65	39.05	68.30	15.47	H
16518.30	52.56	-26.96	39.82	39.70	68.30	15.74	V
10932.50	49.43	-32.82	38.70	43.55	74.00	24.57	V
11838.40	48.99	-31.85	39.05	41.79	74.00	25.01	H

Sample calculation: 802.11ac 80MHz CH155–Peak, 17985.70MHz

$$\text{Peak ERP(dBm)} = P_{\text{Mea}}(33.63\text{dBuV/m}) + \text{Cable Loss}(-25.50) + \text{Antenna Factor}(46.66) = 54.79 \text{ dBuV/m}$$

A.6. Band Edges Compliance

A6.1 Band Edges - Radiated

Measurement Limit:

Standard	Limit (dBm/MHz)	
FCC 47 CFR Part 15.407	at the band edge	27
	at 5 MHz above or below the band edge	15.6
	at 25 MHz above or below the band edge	10
	at 75 MHz or more above or below the band edge	-27
	Note: increasing linearly from point to point.	

The measurement is made according to KDB 789033 D02

In addition, radiated emissions which fall in the restricted bands, as defined in § 15.205(a), must also comply with the radiated emission limits specified in § 15.209(a) (see § 15.205(c)).

Measurement Result:

Mode	Channel	Test Results	Conclusion
802.11a	5745 MHz	Fig.10	P
	5825 MHz	Fig.11	P
802.11n HT20	5745 MHz	Fig.12	P
	5825 MHz	Fig.13	P
802.11ac HT20	5745 MHz	Fig.14	P
	5825 MHz	Fig.15	P
802.11n HT40	5755 MHz	Fig.16	P
	5795 MHz	Fig.17	P
802.11ac HT40	5755 MHz	Fig.18	P
	5795 MHz	Fig.19	P
802.11ac HT80	5775 MHz	Fig.20	P
	5775 MHz	Fig.21	P

EUT ID: UT04a

Conclusion: PASS

Test graphs as below:

Full Spectrum

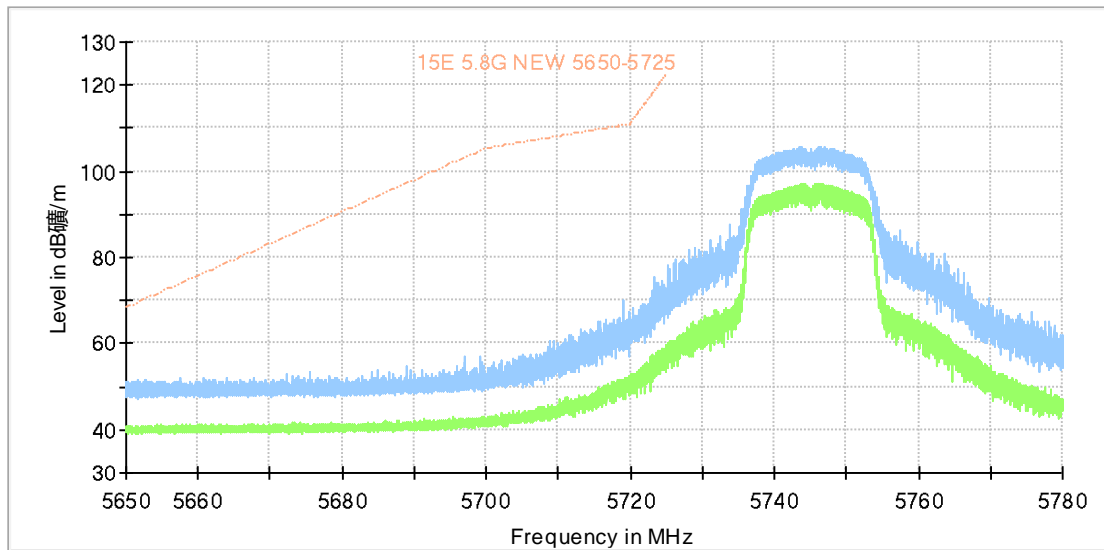

- Preview Result 2-AVG [Preview Result 2.Result 2]
- Preview Result 1-PK+ [Preview Result 1.Result 1]
- * Critical_Freqs AVG [Critical_Freqs.Result 5]
- * Critical_Freqs PK+ [Critical_Freqs.Result 4]
- - - 15E 5.8G NEW 5650-5725 [..]
- ◆ Final_Result PK+ [Final_Result.Result 4]
- ◆ Final_Result AVG [Final_Result.Result 5]

Fig. 10 Band Edges (802.11a, 5745MHz)

Full Spectrum

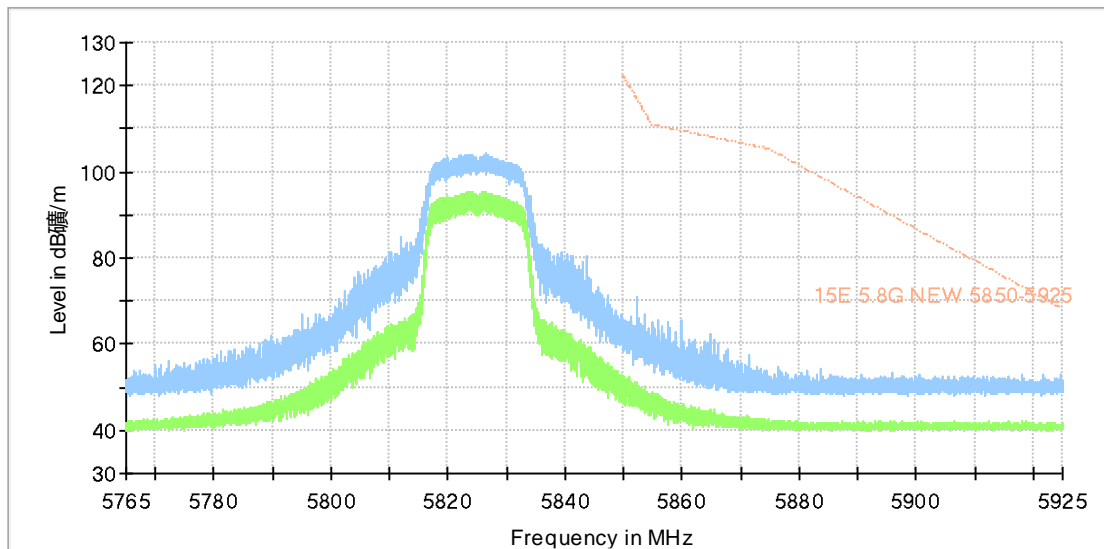

- Preview Result 2-AVG [Preview Result 2.Result 2]
- Preview Result 1-PK+ [Preview Result 1.Result 1]
- * Critical_Freqs AVG [Critical_Freqs.Result 5]
- * Critical_Freqs PK+ [Critical_Freqs.Result 4]
- - - 15E 5.8G NEW 5850-5925 [..]
- ◆ Final_Result PK+ [Final_Result.Result 4]
- ◆ Final_Result AVG [Final_Result.Result 5]

Fig. 11 Band Edges (802.11a, 5825MHz)

Full Spectrum

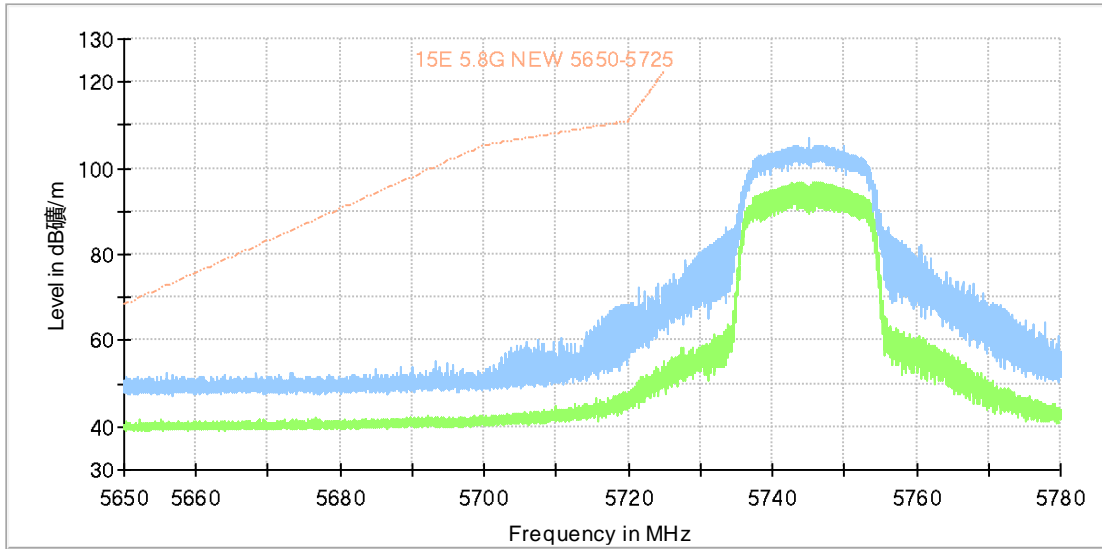

- Preview Result 2-AVG [Preview Result 2.Result 2]
- Preview Result 1-PK+ [Preview Result 1.Result 1]
- Critical Freqs AVG [Critical Freqs.Result 5]
- Critical Freqs PK+ [Critical Freqs.Result 4]
- 15E 5.8G NEW 5650-5725 [..]
- Final Result PK+ [Final Result.Result 4]
- Final Result AVG [Final Result.Result 5]

Fig. 12 Band Edges (802.11n-HT20, 5745MHz)

Full Spectrum

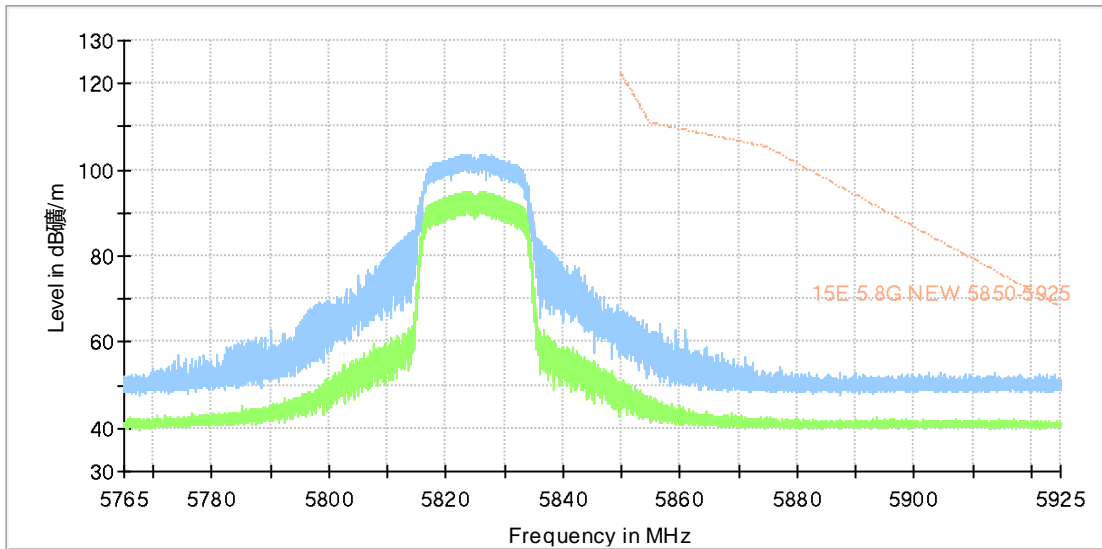

- Preview Result 2-AVG [Preview Result 2.Result 2]
- Preview Result 1-PK+ [Preview Result 1.Result 1]
- Critical Freqs AVG [Critical Freqs.Result 5]
- Critical Freqs PK+ [Critical Freqs.Result 4]
- 15E 5.8G NEW 5850-5925 [..]
- Final Result PK+ [Final Result.Result 4]
- Final Result AVG [Final Result.Result 5]

Fig. 13 Band Edges (802.11n-HT20, 5825MHz)

Full Spectrum

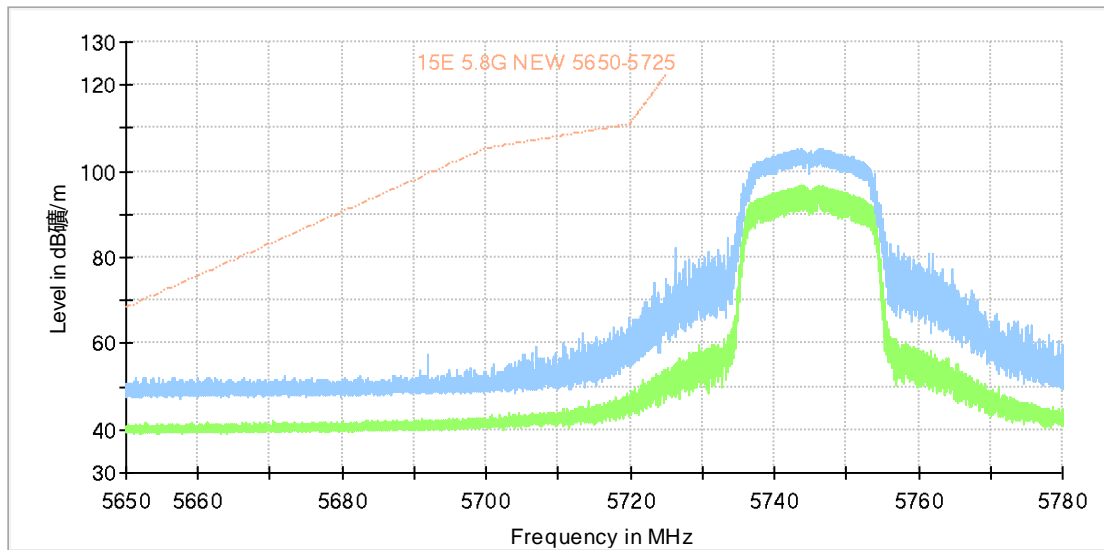

- Preview Result 2-AVG [Preview Result 2.Result 2]
- Preview Result 1-PK+ [Preview Result 1.Result 1]
- * Critical_Freqs AVG [Critical_Freqs.Result 5]
- * Critical_Freqs PK+ [Critical_Freqs.Result 4]
- - - 15E 5.8G NEW 5650-5725 [..]
- ◆ Final_Result PK+ [Final_Result.Result 4]
- ◆ Final_Result AVG [Final_Result.Result 5]

Fig. 14 Band Edges (802.11ac-HT20, 5745MHz)

Full Spectrum

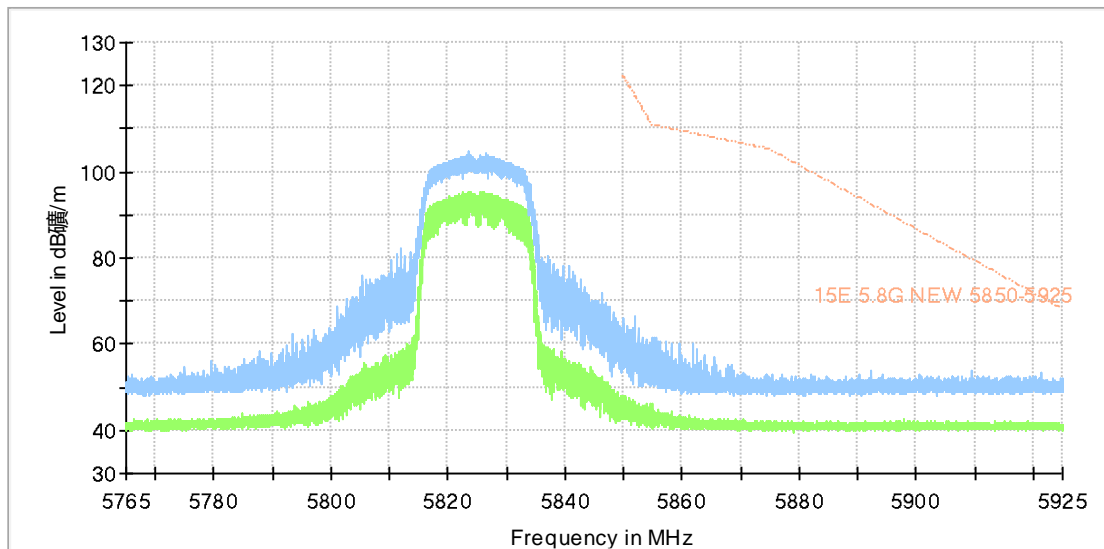

- Preview Result 2-AVG [Preview Result 2.Result 2]
- Preview Result 1-PK+ [Preview Result 1.Result 1]
- * Critical_Freqs AVG [Critical_Freqs.Result 5]
- * Critical_Freqs PK+ [Critical_Freqs.Result 4]
- - - 15E 5.8G NEW 5850-5925 [..]
- ◆ Final_Result PK+ [Final_Result.Result 4]
- ◆ Final_Result AVG [Final_Result.Result 5]

Fig. 15 Band Edges (802.11ac-HT20, 5825MHz)

Full Spectrum

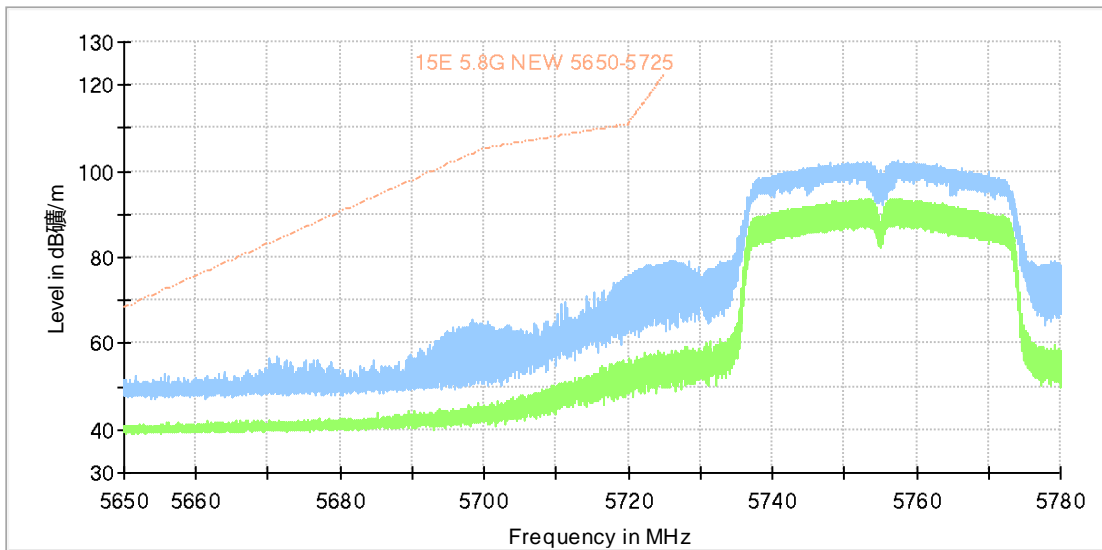

- Preview Result 2-AVG [Preview Result 2.Result 2]
- Preview Result 1-PK+ [Preview Result 1.Result 1]
- * Critical Freqs AVG [Critical Freqs.Result 5]
- * Critical Freqs PK+ [Critical Freqs.Result 4]
- - - 15E 5.8G NEW 5650-5725 [..]
- ◆ Final Result PK+ [Final Result.Result 4]
- ◆ Final Result AVG [Final Result.Result 5]

Fig. 16 Band Edges (802.11n-HT40, 5755MHz)

Full Spectrum

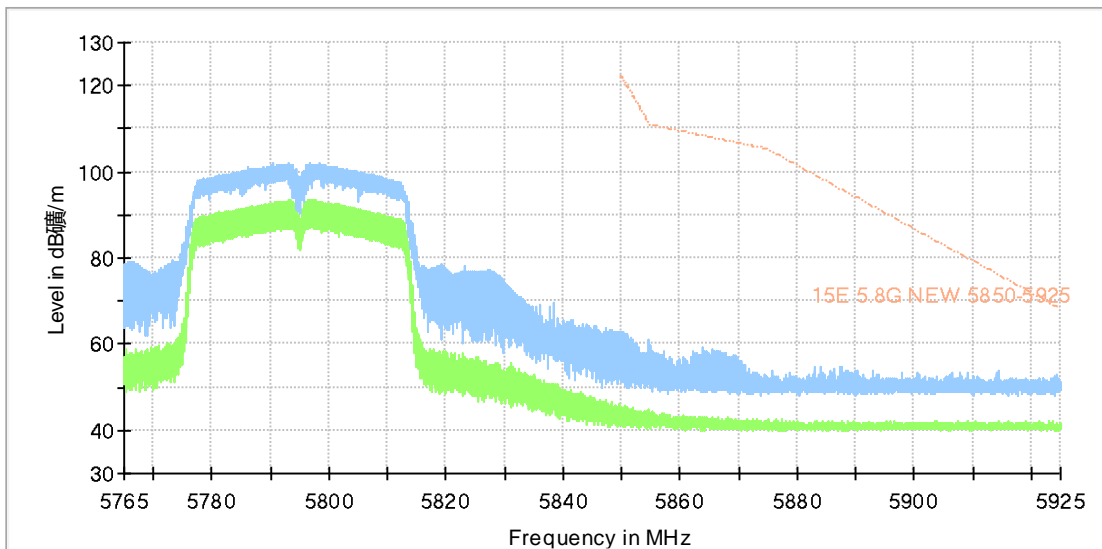

- Preview Result 2-AVG [Preview Result 2.Result 2]
- Preview Result 1-PK+ [Preview Result 1.Result 1]
- * Critical Freqs AVG [Critical Freqs.Result 5]
- * Critical Freqs PK+ [Critical Freqs.Result 4]
- - - 15E 5.8G NEW 5850-5925 [..]
- ◆ Final Result PK+ [Final Result.Result 4]
- ◆ Final Result AVG [Final Result.Result 5]

Fig. 17 Band Edges (802.11n-HT40, 5795MHz)

Full Spectrum

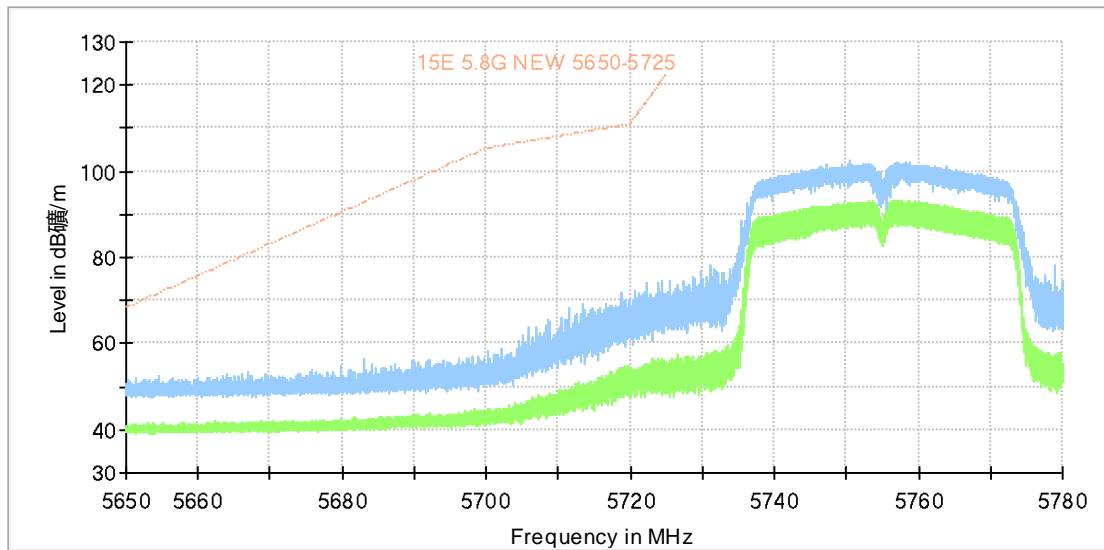

- Preview Result 2-AVG [Preview Result 2.Result 2]
- Preview Result 1-PK+ [Preview Result 1.Result 1]
- Critical Freqs AVG [Critical Freqs.Result 5]
- Critical Freqs PK+ [Critical Freqs.Result 4]
- 15E 5.8G NEW 5650-5725 [..]
- Final Result PK+ [Final Result.Result 4]
- Final Result AVG [Final Result.Result 5]

Fig. 18 Band Edges (802.11ac-HT40, 5755MHz)

Full Spectrum

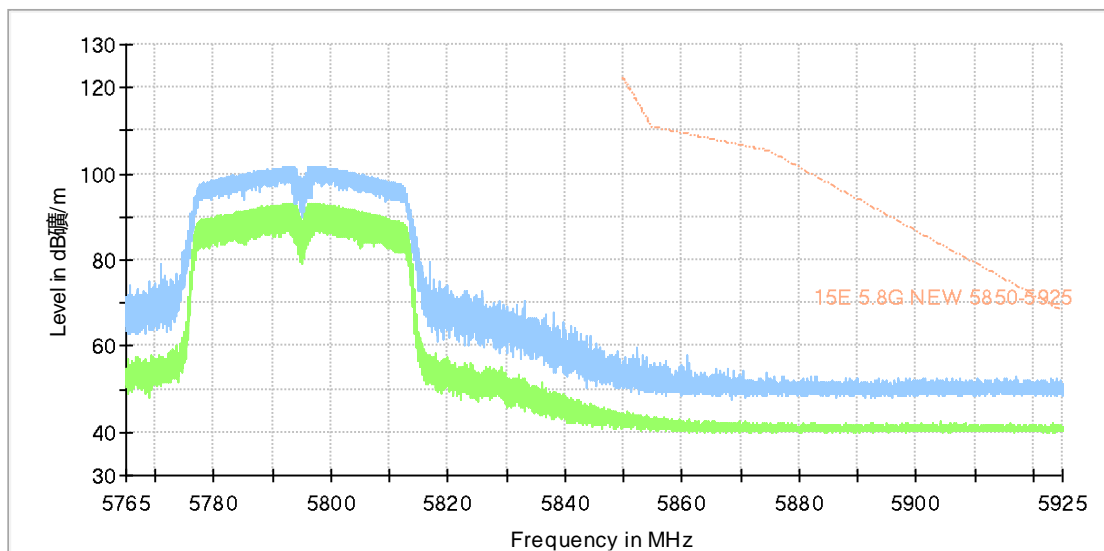

- Preview Result 2-AVG [Preview Result 2.Result 2]
- Preview Result 1-PK+ [Preview Result 1.Result 1]
- Critical Freqs AVG [Critical Freqs.Result 5]
- Critical Freqs PK+ [Critical Freqs.Result 4]
- 15E 5.8G NEW 5850-5925 [..]
- Final Result PK+ [Final Result.Result 4]
- Final Result AVG [Final Result.Result 5]

Fig. 19 Band Edges (802.11ac-HT40, 5795MHz)

Full Spectrum

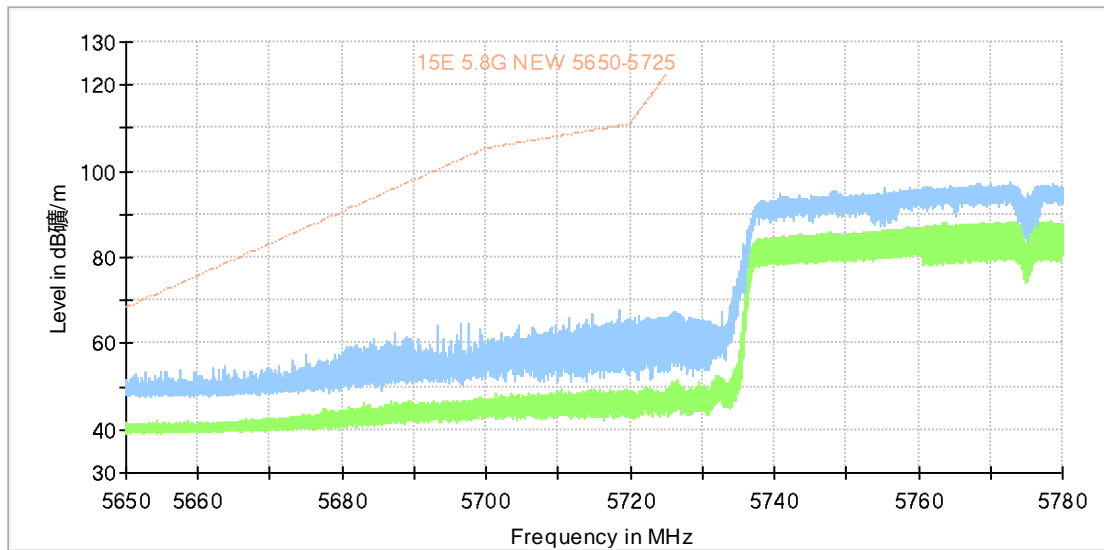

Fig. 20 Band Edges (802.11ac-HT80, 5775MHz)

Full Spectrum

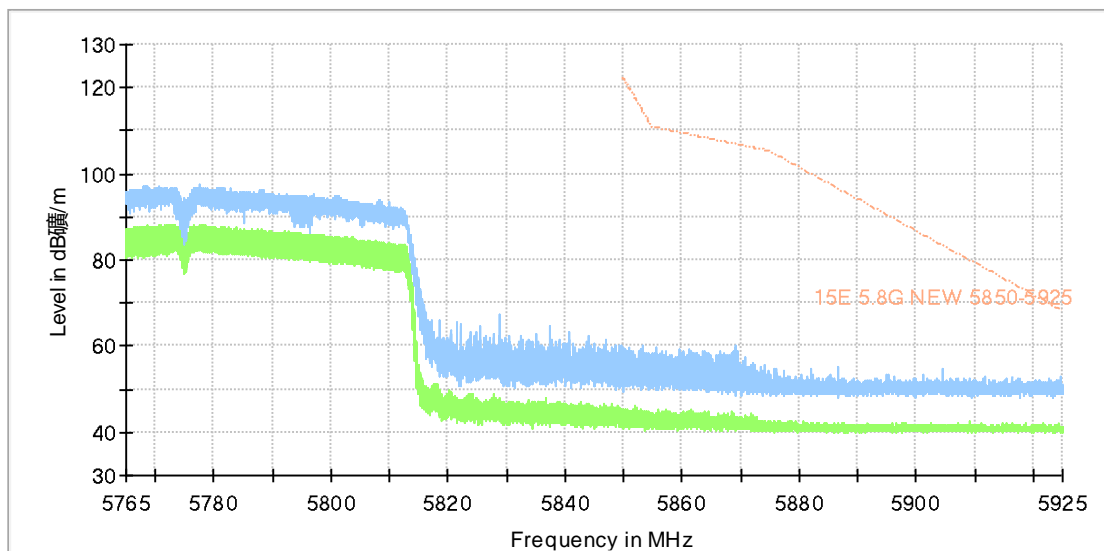

Fig. 21 Band Edges (802.11ac-HT80, 5775MHz)

A.7. AC Powerline Conducted Emission

Method of Measurement: See ANSI C63.10-clause 6.2

Setup:

A stand-alone EUT shall be placed in the center along the back edge of the tabletop. For multiunit tabletop systems, the EUT shall be centered laterally (left to right facing the tabletop) on the tabletop and its rear shall be flush with the rear of the table.

Accessories that are part of an EUT system tested on a tabletop shall be placed in a test arrangement on one or both sides of the host with a 10 cm separation between the nearest points of the cabinets. The rear of the host and accessories shall be flush with the back of the supporting tabletop unless that would not be typical of normal use. If more than two accessories are present, then an equipment test arrangement shall be chosen that maintains 10 cm spacing between cabinets unless the equipment is normally located closer together.

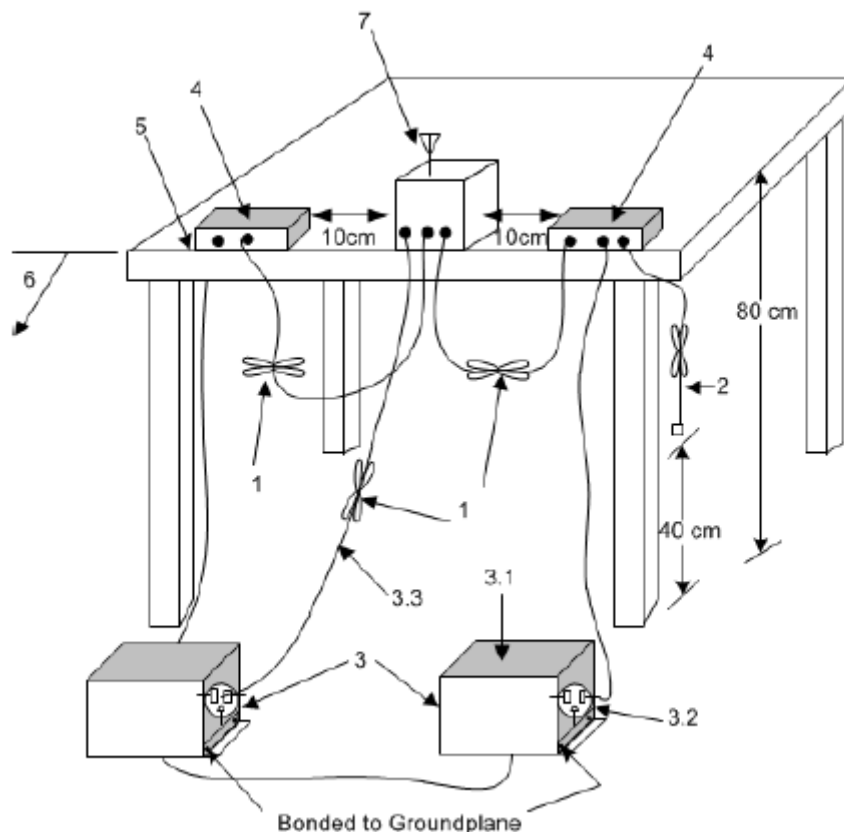

Exploratory ac power-line conducted emission measurements

Exploratory measurements shall be used to identify the frequency of the emission that has the highest amplitude relative to the limit by operating the EUT in a range of typical modes of operation, cable positions, and with a typical system equipment configuration and arrangement. For each mode of operation and for each ac power current-carrying conductor, cable manipulation shall be performed within the range of likely configurations. For this measurement or series of measurements, the frequency spectrum of interest shall be monitored looking for the emission that has the highest amplitude relative to the limit. Once that emission is found for each current-carrying conductor of each power cord associated with the EUT (but not the cords associated with non-EUT equipment in the overall system), the one configuration and arrangement and mode of operation that produces the emission closest to the limit over all of the

measured conductors shall be recorded.

Final ac power-line conducted emission measurements

Based on the exploratory tests of the EUT, the one EUT cable configuration and arrangement and mode of operation that produced the emission with the highest amplitude relative to the limit is selected for the final measurement, while applying the appropriate modulating signal to the EUT. If the EUT is relocated from an exploratory test site to a final test site, the highest emissions shall be remaximized at the final test location before final ac power-line conducted emission measurements are performed. The final test on all current-carrying conductors of all of the power cords to the equipment that comprises the EUT (but not the cords associated with other non-EUT equipment in the system) is then performed for the full frequency range for which the EUT is being tested for compliance without further variation of the EUT arrangement, cable positions, or EUT mode of operation. If the EUT is composed of equipment units that have their own separate ac power connections (e.g., floor-standing equipment with independent power cords for each shelf that are able to connect directly to the ac power network), then each current-carrying conductor of one unit is measured while the other units are connected to a second (or more) LISN(s). All units shall be measured separately. If a power strip is provided by the manufacturer, to supply all of the units making up the EUT, only the conductors in the power cord of the power strip shall be measured.

Test Condition:

Voltage (V)	Frequency (Hz)
120	60

Measurement Result and limit:

EUT ID: UT04a(I22Z60871)

WLAN (Quasi-peak Limit)

Frequency range (MHz)	Quasi-peak Limit (dB μ V)	Result (dB μ V)		Conclusion
		With charger		
		802.11a	Idle	
0.15 to 0.5	66 to 56	Fig. 22	Fig. 23	P
0.5 to 5	56			
5 to 30	60			

NOTE: The limit decreases linearly with the logarithm of the frequency in the range 0.15 MHz to 0.5 MHz.

WLAN (Average Limit)

Frequency range (MHz)	Average Limit (dB μ V)	Result (dB μ V)		Conclusion
		With charger		
		802.11a	Idle	
0.15 to 0.5	56 to 46	Fig. 22	Fig.23	P
0.5 to 5	46			
5 to 30	50			

NOTE: The limit decreases linearly with the logarithm of the frequency in the range 0.15 MHz to 0.5 MHz.

Conclusion: PASS

Test graphs as below:

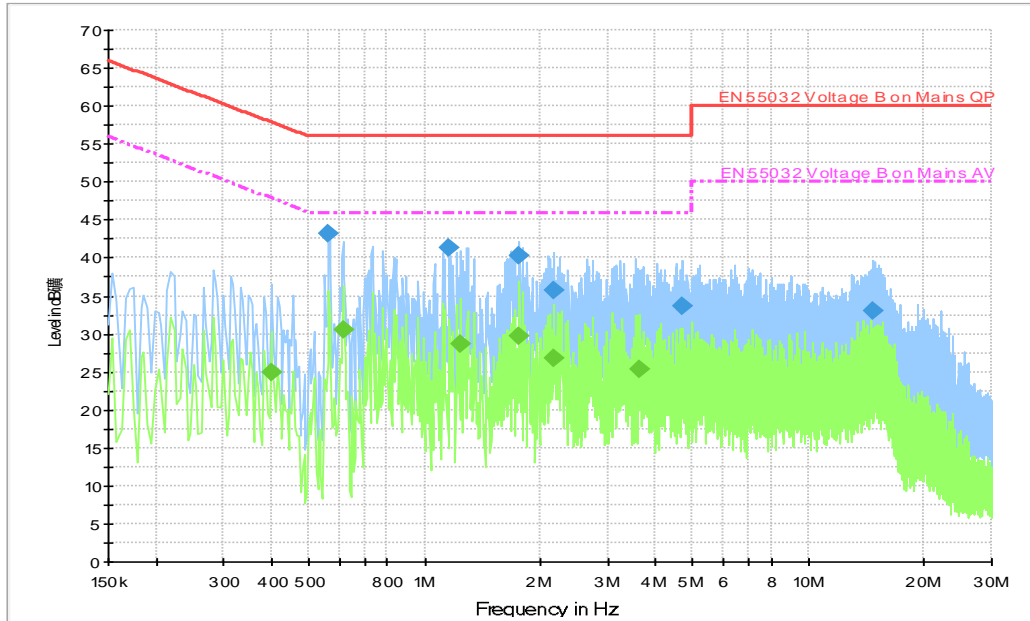

Fig. 22 AC Powerline Conducted Emission-802.11a

Final Result 1

Frequency (MHz)	QuasiPeak (dBμV)	Line	Corr. (dB)	Margin (dB)	Limit (dBμV)
0.562000	43.1	L1	19.7	12.9	56.0
1.162000	41.4	L1	19.8	14.6	56.0
1.770000	40.4	L1	19.6	15.6	56.0
2.166000	35.7	L1	19.6	20.3	56.0
4.710000	33.6	L1	19.6	22.4	56.0
14.802000	33.0	L1	19.7	27.0	60.0

Final Result 2

Frequency (MHz)	Average (dBμV)	Line	Corr. (dB)	Margin (dB)	Limit (dBμV)
0.398000	25.0	L1	19.7	22.9	47.9
0.614000	30.6	L1	19.6	15.4	46.0
1.242000	28.8	L1	19.7	17.2	46.0
1.770000	29.8	L1	19.6	16.2	46.0
2.166000	26.8	L1	19.6	19.2	46.0
3.646000	25.3	L1	19.6	20.7	46.0

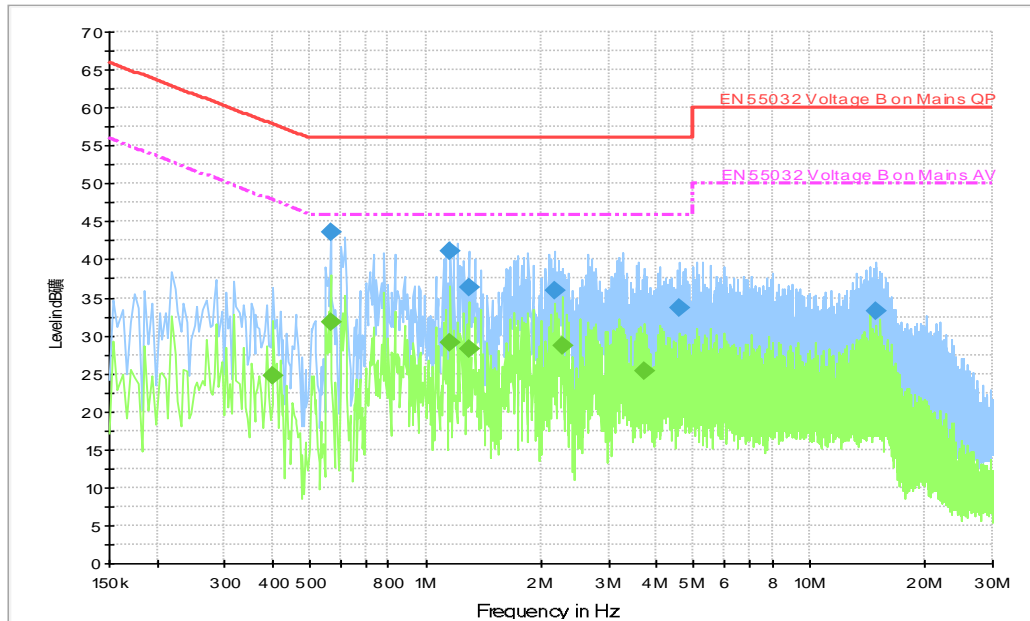

Fig. 23 AC Powerline Conducted Emission-Idle

Final Result 1

Frequency (MHz)	QuasiPeak (dBµV)	Line	Corr. (dB)	Margin (dB)	Limit (dBµV)
0.566000	43.6	L1	19.7	12.4	56.0
1.162000	41.1	L1	19.8	14.9	56.0
1.294000	36.4	L1	19.7	19.6	56.0
2.162000	36.0	L1	19.6	20.0	56.0
4.606000	33.6	L1	19.5	22.4	56.0
14.878000	33.3	L1	19.7	26.7	60.0

Final Result 2

Frequency (MHz)	Average (dBµV)	Line	Corr. (dB)	Margin (dB)	Limit (dBµV)
0.402000	24.7	L1	19.7	23.1	47.8
0.566000	31.8	L1	19.7	14.2	46.0
1.162000	29.0	L1	19.8	17.0	46.0
1.294000	28.3	L1	19.7	17.7	46.0
2.278000	28.7	L1	19.6	17.3	46.0
3.714000	25.4	L1	19.5	20.6	46.0

ANNEX B: EUT parameters

Disclaimer: The worse case and antenna gain provided by the client may affect the validity of the measurement results in this report, and the client shall bear the impact and consequences arising therefrom.

ANNEX C: Accreditation Certificate

United States Department of Commerce National Institute of Standards and Technology	
	
<hr/> Certificate of Accreditation to ISO/IEC 17025:2017 <hr/>	
NVLAP LAB CODE: 600118-0	
Telecommunication Technology Labs, CAICT Beijing China	
<i>is accredited by the National Voluntary Laboratory Accreditation Program for specific services, listed on the Scope of Accreditation, for:</i>	
Electromagnetic Compatibility & Telecommunications	
<i>This laboratory is accredited in accordance with the recognized International Standard ISO/IEC 17025:2017. This accreditation demonstrates technical competence for a defined scope and the operation of a laboratory quality management system (refer to joint ISO-ILAC-IAF Communique dated January 2009).</i>	
2021-09-29 through 2022-09-30 <i>Effective Dates</i>	 For the National Voluntary Laboratory Accreditation Program

*** END OF REPORT BODY ***