

FCC PART 15 TEST REPORT No.I21Z62219-IOT02

for

vivo Mobile Communication Co., Ltd.

Mobile Phone

V2127

With

FCC ID: 2AUCY-V2127

Hardware Version: MP_0.1

Software Version: PD2166DF_EX_A_3.5.8

Issued Date: 2022-01-13

Note:

The test results in this test report relate only to the devices specified in this report. This report shall not be reproduced except in full without the written approval of CTTL.

The report must not be used by the client to claim product certification, approval, or endorsement by NVLAP, NIST, or any agency of the U.S. Government.

Test Laboratory:

CTTL-Telecommunication Technology Labs, CAICT

No. 52, Huayuan North Road, Haidian District, Beijing, P. R. China 100191.

Tel:+86(0)10-62304633-2512, Fax:+86(0)10-62304633-2504

Email: ctl_terminals@caict.ac.cn, website: www.caict.ac.cn

REPORT HISTORY

Report Number	Revision	Description	Issue Date
I21Z62219-IOT02	Rev.0	1st edition	2021-12-31
I21Z62219-IOT02	Rev.1	Modified the calibration period of test receiver and LISN in P10 Add antenna gain on page 7. Add duty cycle on page 13. The Maximum Output Power result graph is added on page 16. The PSD result graph is added on page 18 Modified the limit for A.5.1 in P37	2022-01-13

CONTENTS

CONTENTS	3
1. TEST LATORATORY	5
1.1. INTRODUCTION & ACCREDITATION	5
1.2. TESTING LOCATION	5
1.3. TESTING ENVIRONMENT	5
1.4. PROJECT DATE.....	5
1.5. SIGNATURE	5
2. CLIENT INFORMATION	6
2.1 APPLICANT INFORMATION	6
2.2 MANUFACTURER INFORMATION.....	6
3. EQUIPMENT UNDER TEST (EUT) AND ANCILLARYEQUIPMENT(AE)	7
3.1. ABOUT EUT	7
3.2. INTERNAL IDENTIFICATION OF EUT USED DURING THE TEST	7
3.3. INTERNAL IDENTIFICATION OF AE USED DURING THE TEST	7
3.4. GENERAL DESCRIPTION	8
3.5. INTERPRETATION OF THE TEST ENVIRONMENT	8
4. REFERENCE DOCUMENTS	8
4.1. DOCUMENTS SUPPLIED BY APPLICANT.....	8
4.2. REFERENCE DOCUMENTS FOR TESTING	8
5. LABORATORY ENVIRONMENT.....	9
6. SUMMARY OF TEST RESULTS.....	9
6.1. SUMMARY OF TEST RESULTS.....	9
6.2. STATEMENTS.....	9
6.3. TEST CONDITIONS.....	10
7. TEST EQUIPMENTS UTILIZED	10
8. MEASUREMENT UNCERTAINTY	11
8.1 TRANSMITTER OUTPUT POWER	11
8.2 PEAK POWER SPECTRAL DENSITY	11
8.3 OCCUPIED CHANNEL BANDWIDTH	11
8.4 BAND EDGES COMPLIANCE	11
8.5 SPURIOUS EMISSIONS.....	11
8.6 AC POWER-LINE CONDUCTED EMISSION	11
ANNEX A: MEASUREMENT RESULTS	12
A.1. MEASUREMENT METHOD.....	12
A.2. MAXIMUM OUTPUT POWER.....	13

A.3. PEAK POWER SPECTRAL DENSITY (CONDUCTED).....	17
A.4. OCCUPIED 26DB BANDWIDTH(CONDUCTED).....	19
A.5. BAND EDGES COMPLIANCE.....	37
A5.1 BAND EDGES - RADIATED.....	37
A.6. TRANSMITTER SPURIOUS EMISSION.....	53
A.7. AC POWERLINE CONDUCTED EMISSION (150kHz- 30MHz).....	80
A.8. 99% OCCUPIED BANDWIDTH.....	85
A.9. POWER CONTROL.....	91
ANNEX B: EUT PARAMETERS.....	91
ANNEX C: ACCREDITATION CERTIFICATE	91

1. TEST LABORATORY

1.1. Introduction & Accreditation

Telecommunication Technology Labs, CAICT is an ISO/IEC 17025:2017 accredited test laboratory under NATIONAL VOLUNTARY LABORATORY ACCREDITATION PROGRAM (NVLAP) with lab code 600118-0, and is also an FCC accredited test laboratory (CN5017), and ISED accredited test laboratory (ISED#: 24849). The detail accreditation scope can be found on NVLAP website.

1.2. Testing Location

Conducted testing Location: CTTL(Huayuan North Road)

Address: No. 52, Huayuan North Road, Haidian District, Beijing,
P. R. China100191

Radiated testing Location: CTTL(huayuan North Road)

Address: No. 52, Huayuan North Road, Haidian District, Beijing,
P. R. China100191

1.3. Testing Environment

Normal Temperature: 15-35°C

Relative Humidity: 20-75%

1.4. Project date

Testing Start Date: 2021-11-15

Testing End Date: 2021-12-31

1.5. Signature

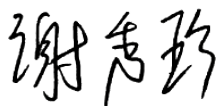

Xie Xiuzhen
(Prepared this test report)

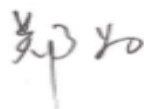

Zheng Wei
(Reviewed this test report)

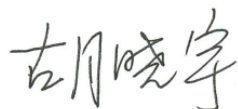

Hu Xiaoyu
(Approved this test report)

2. CLIENT INFORMATION

2.1 Applicant Information

Company Name: vivo Mobile Communication Co., Ltd.
Address: No.168 Jinghai East Rd.,Chang'an, Dongguan, Guangdong,China
City: Guangdong
Postal Code: /
Country: China
Telephone: 188 2371 0059
Fax: /

2.2 Manufacturer Information

Company Name: vivo Mobile Communication Co., Ltd.
Address: No.168 Jinghai East Rd.,Chang'an, Dongguan, Guangdong,China
City: Guangdong
Postal Code: /
Country: China
Telephone: 188 2371 0059
Fax: /

3. EQUIPMENT UNDER TEST (EUT) AND

ANCILLARY EQUIPMENT (AE)

3.1. About EUT

Description	Mobile Phone
Model name	V2127
FCC ID	2AUCY-V2127
WLAN Frequency Band	ISM Bands: -5150MHz~5250MHz -5250MHz~5350MHz -5470MHz~5725MHz
Type of modulation	OFDM
Antenna	-3 dBi
Voltage	3.87V

3.2. Internal Identification of EUT used during the test

EUT ID*	SN or IMEI	HW Version	SW Version
UT07a	863582059997034/	MP_0.1	PD2166DF_EX_A_3.5.8
	863582059997026		
UT04a	863582059998933/	MP_0.1	PD2166DF_EX_A_3.5.8
	863582059998925		

*EUT ID: is used to identify the test sample in the lab internally.

3.3. Internal Identification of AE used during the test

AE ID*	Description	
AE1	Charger	/
AE2	Charger	/
AE3	Charger	/
AE4	Charger	/
AE5	Battery	Inbuilt
AE7	USB Cable	/
AE1		
Model	V1820L0B1-EU	
Manufacturer	Dongguan Aohai Technology Co.,Ltd	
AE2		
Model	V1820L0B1-UK	
Manufacturer	Dongguan Aohai Technology Co.,Ltd.	
AE3		
Model	V1820L0B1-AU	
Manufacturer	Dongguan Aohai Technology Co.,Ltd.	

AE4

Model V1820L0B1-US
 Manufacturer Dongguan Aohai Technology Co.,Ltd

AE5

Model B-T6
 Manufacturer Dongguan NVT Technology Co.,Ltd

AE7

Model BK-C-32
 Manufacturer vivo

*AE ID: is used to identify the test sample in the lab internally.

3.4. General Description

The Equipment under Test (EUT) is a model of Mobile Phone with integrated antenna and inbuilt battery.

It has Bluetooth (EDR)function.

It consists of normal options: travel charger, USB cable.

Manual and specifications of the EUT were provided to fulfil the test.

Samples undergoing test were selected by the client.

3.5. Interpretation of the Test Environment

For the test methods, the test environment uncertainty figures correspond to an expansion factor k=2.

Measurement Uncertainty

Parameter	Uncertainty
temperature	0.48°C
humidity	2 %
DC voltages	0.003V

4. REFERENCE DOCUMENTS

4.1. Documents supplied by applicant

EUT feature information is supplied by the applicant or manufacturer, which is the basis of testing.

4.2. Reference Documents for testing

The following documents listed in this section are referred for testing.

FCC Part15	Title 47 of the Code of Federal Regulations; Chapter I Part 15 - Radio frequency devices	2018
ANSI C63.10	Methods of Measurement of Radio-Noise Emissions from Low-Voltage Electrical and Electronic Equipment in the Range of 9 kHz to 40 GHz	2013

UNII: KDB 789033
D02

General U-NII Test Procedures New Rules v02r01

2017-12

Federal Communications Commission Office of
Engineering and Technology Laboratory Division

KDB 558074 D01

GUIDANCE FOR COMPLIANCE MEASUREMENTS ON
DIGITAL TRANSMISSION SYSTEM, FREQUENCY
HOPPING SPREAD SPECTRUM SYSTEM, AND HYBRID
SYSTEM DEVICES OPERATING UNDER SECTION
15.247 OF THE FCC RULES

2019

5. LABORATORY ENVIRONMENT

Conducted RF performance testing is performed in shielding room.

EMC performance testing is performed in Semi-anechoic chamber.

6. SUMMARY OF TEST RESULTS

6.1. Summary of Test Results

SUMMARY OF MEASUREMENT RESULTS	Sub-clause of Part15E	Sub-clause of IC	Verdict
Maximum Output Power	15.407	/	P
Peak Power Spectral Density	15.407	/	P
Occupied 26dB Bandwidth	15.403	/	P
Band edge compliance (Radiated)	15.209	/	P
Transmitter spurious emissions (Radiated)	15.407	/	P
AC Powerline Conducted Emission (150kHz- 30MHz)	15.407	/	P
Frequency Stability	15.407	/	P
99% Occupied bandwidth	/	/	P
Transmit Power Control	15.407	/	NA

Please refer to **ANNEX A** for detail.

Terms used in Verdict column

P	Pass, The EUT complies with the essential requirements in the standard.
NM	Not measured, The test was not measured by CTTL
NA	Not Applicable, The test was not applicable
F	Fail, The EUT does not comply with the essential requirements in the standard

6.2. Statements

CTTL has evaluated the test cases requested by the client/manufacturer as listed in section 6.1 of this report for the EUT specified in section 3 according to the standards or reference documents listed in section 4.1.

This report only deals with the WLAN function among the features described in section 3.

6.3. Test Conditions

For this report, all the test cases are tested under normal temperature and normal voltage, and also under norm humidity, the specific condition is shown as follows:

Temperature	26°C
Voltage	3.87V
Humidity	44%

7. TEST EQUIPMENTS UTILIZED

Conducted test system

No.	Equipment	Model	Serial Number	Manufacturer	Calibration Period	Calibration Due date
1	Vector Signal Analyzer	FSQ40	200089	Rohde & Schwarz	1 year	2022-05-24
2	LISN	ENV216	101200	R&S	1 year	2022-05-30
3	Test Receiver	ESC17	100344	R&S	1 year	2022-02-23
4	Shielding Room	S81	/	ETS-Lindgren	/	/
5	Attenuator	K40	/	Rosenberger	/	/

Radiated emission test system

No.	Equipment	Model	Serial Number	Manufacturer	Calibration Period	Calibration Due date
1	Test Receiver	ESU26	100235	R&S	1 year	2022-02-23
2	BiLog Antenna	VULB9163	01223	Schwarzbeck	1 year	2022-03-22
3	Dual-Ridge Waveguide Horn Antenna	3115	6914	ETS-Lindgren	1 year	2022-02-03
4	EMI Antenna	3116	2661	ETS-Lindgren	1 year	2022-01-05
5	Spectrum Analyzer	FSV40	101047	Rohde & Schwarz	1 year	2022-06-03

8. Measurement Uncertainty

8.1 Transmitter Output Power

Measurement Uncertainty: 0.387dB,k=1.96

8.2 Peak Power Spectral Density

Measurement Uncertainty: 0.705dB,k=1.96

8.3 Occupied Channel Bandwidth

Measurement Uncertainty: 60.80Hz,k=1.96

8.4 Band Edges Compliance

Measurement Uncertainty : 0.62dB,k=1.96

8.5 Spurious Emissions

Conducted (k=1.96)

Frequency Range	Uncertainty(dB)
$30\text{MHz} \leq f \leq 2\text{GHz}$	1.22
$2\text{GHz} \leq f \leq 3.6\text{GHz}$	1.22
$3.6\text{GHz} \leq f \leq 8\text{GHz}$	1.22
$8\text{GHz} \leq f \leq 12.75\text{GHz}$	1.51
$12.75\text{GHz} \leq f \leq 26\text{GHz}$	1.51
$26\text{GHz} \leq f \leq 40\text{GHz}$	1.59

Radiated (k=2)

Frequency Range	Uncertainty(dB)
9kHz-30MHz	4.92
$30\text{MHz} \leq f \leq 1\text{GHz}$	5.18
$1\text{GHz} \leq f \leq 18\text{GHz}$	5.54
$18\text{GHz} \leq f \leq 40\text{GHz}$	5.26

8.6 AC Power-line Conducted Emission

Measurement Uncertainty : 3.08dB,k=2

ANNEX A: MEASUREMENT RESULTS

A.1. Measurement Method

A.1.1. Conducted Measurements

- 1). Connect the EUT to the test system correctly.
- 2). Set the EUT to the required work mode.
- 3). Set the EUT to the required channel.
- 4). Set the spectrum analyzer to start measurement.
- 5). Record the values. Vector Signal Analyzer

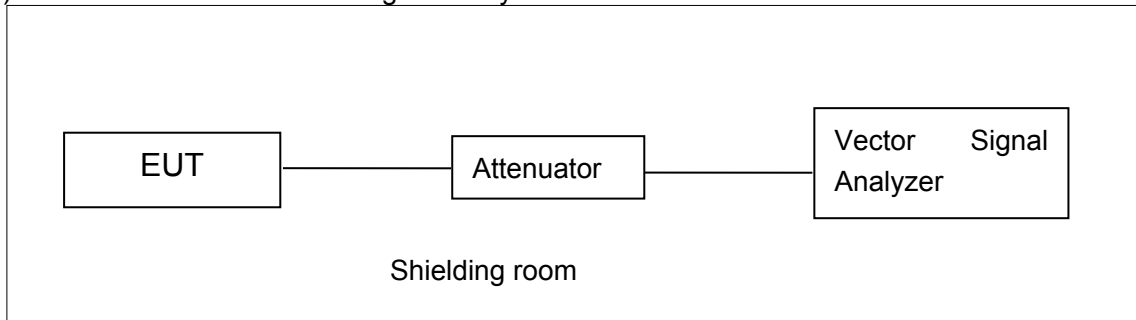

A.1.2. Radiated Emission Measurements

In the case of radiated emission, the used settings are as follows,

Sweep frequency from 30 MHz to 1GHz, RBW = 100 kHz, VBW = 300 kHz;

Sweep frequency from 1 GHz to 26GHz, RBW = 1MHz, VBW = 10Hz;

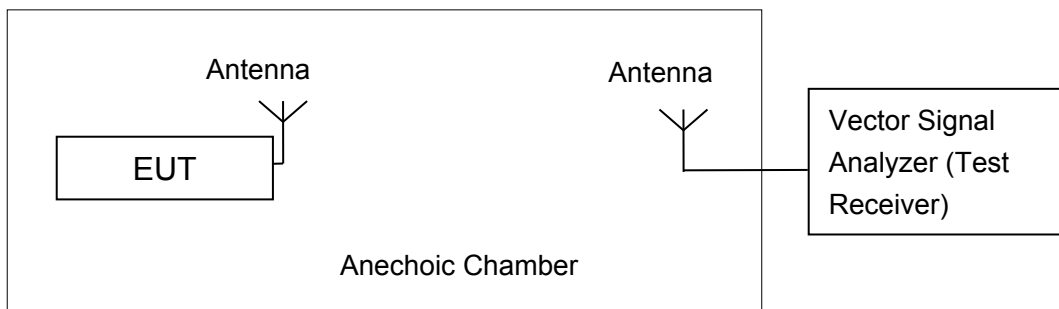

The measurement is made according to KDB 789033

The radiated emission test is performed in semi-anechoic chamber. The distance from the EUT to the reference point of measurement antenna is 3m. The test is carried out on both vertical and horizontal polarization and only maximization result of both polarizations is kept. During the test, the turntable is rotated 360° and the measurement antenna is moved from 1m to 4m to get the maximization result.

A.2. Maximum output Power

Measurement Limit and Method:

Standard	Frequency (MHz)	Limit (dBm)
FCC CRF Part 15.407(a)	5150MHz~5250MHz	24dBm
	5250MHz~5350MHz	24dBm or 11+10logB
	5470MHz~5725MHz	24dBm or 11+10logB

Limit use the less value, and B is the 26dB bandwidth.

The measurement method SA-2 is made according to KDB 789033

The following test results were tested at 100% duty cycle

Note:

For straddle channel 20MHz Bandwidth 5720MHz, Conducted Output Power Limit:

802.11a=11+10*log(B)=24.98, B=40.00/2+5=25MHz

802.11n-HT20=11+10*log(B)=24.78, B=37.75/2+5=23.875MHz,

802.11ac-VHT20=11+10*log(B)=24.67, B=36.55/2+5=23.275MHz,

For straddle channel 40/80MHz Bandwidth, conducted output power limit=24 dBm

802.11n-HT40: B=64.8/2+15=47.40MHz,

802.11ac-VHT40: B=64.80/2+15=47.40MHz,

802.11ac-VHT80: B=112.16/2+35=91.08MHz,

Measurement Results:

802.11a mode

Mode	Frequency	Test Result (dBm)							
		Data Rate (Mbps)							
		6	9	12	18	24	36	48	54
802.11a	5180MHz	17.27	/	/	/	/	/	/	/
	5200MHz	17.43	/	/	/	/	/	/	/
	5240MHz	17.38	/	/	/	/	/	/	/
	5260MHz	17.32	/	/	/	/	/	/	/
	5280MHz	17.45	/	/	/	/	/	/	/
	5320MHz	17.63	/	/	/	/	/	/	/
	5500MHz	17.20	/	/	/	/	/	/	/
	5580MHz	17.26	/	/	/	/	/	/	/
	5700MHz	17.70	/	/	/	/	/	/	/
	5720MHz	17.50	/	/	/	/	/	/	/

The data rate 6 Mbps is selected as worse condition, and the following cases are performed with this condition.

802.11n-HT20 mode

Mode	Frequency	Test Result (dBm)							
		Data Rate							
		MCS0	MCS1	MCS2	MCS3	MCS4	MCS5	MCS6	MCS7
802.11n	5180MHz	16.55	/	/	/	/	/	/	/

(HT20)	5200MHz	16.41	/	/	/	/	/	/	/
	5240MHz	16.42	/	/	/	/	/	/	/
	5260MHz	16.36	/	/	/	/	/	/	/
	5280MHz	16.18	/	/	/	/	/	/	/
	5320MHz	16.11	/	/	/	/	/	/	/
	5500MHz	16.62	/	/	/	/	/	/	/
	5580MHz	16.04	/	/	/	/	/	/	/
	5700MHz	16.09	/	/	/	/	/	/	/
	5720MHz	15.97	/	/	/	/	/	/	/

The data rate MCS0 is selected as worse condition, and the following cases are performed with this condition.

802.11ac-HT20 mode

Mode	Frequency	Test Result (dBm)								
		Data Rate								
		MCS0	MCS1	MCS2	MCS3	MCS4	MCS5	MCS6	MCS7	MCS8
802.11ac (HT20)	5180MHz	15.70	/	/	/	/	/	/	/	/
	5200MHz	15.79	/	/	/	/	/	/	/	/
	5240MHz	15.82	/	/	/	/	/	/	/	/
	5260MHz	16.09	/	/	/	/	/	/	/	/
	5280MHz	15.76	/	/	/	/	/	/	/	/
	5320MHz	15.77	/	/	/	/	/	/	/	/
	5500MHz	16.15	/	/	/	/	/	/	/	/
	5580MHz	15.64	/	/	/	/	/	/	/	/
	5700MHz	15.74	/	/	/	/	/	/	/	/
	5720MHz	15.64	/	/	/	/	/	/	/	/

The data rate MCS0 is selected as worse condition, and the following cases are performed with this condition.

802.11n-HT40 mode

Mode	Frequency	Test Result (dBm)							
		Data Rate							
		MCS0	MCS1	MCS2	MCS3	MCS4	MCS5	MCS6	MCS7
802.11n (HT40)	5190MHz	16.04	/	/	/	/	/	/	/
	5230MHz	15.75	/	/	/	/	/	/	/
	5270MHz	15.79	/	/	/	/	/	/	/
	5310MHz	15.66	/	/	/	/	/	/	/
	5510MHz	15.93	/	/	/	/	/	/	/
	5550MHz	15.41	/	/	/	/	/	/	/
	5670MHz	15.72	/	/	/	/	/	/	/
	5710MHz	15.79	/	/	/	/	/	/	/

The data rate MCS0 is selected as worse condition, and the following cases are performed with this condition.

802.11ac-HT40 mode

Mode	Frequency	Test Result (dBm)									
		Data Rate									
		MCS0	MCS1	MCS2	MCS3	MCS4	MCS5	MCS6	MCS7	MCS8	MCS9
802.11ac (HT40)	5190MHz	15.74	/	/	/	/	/	/	/	/	/
	5230MHz	15.36	/	/	/	/	/	/	/	/	/
	5270MHz	15.42	/	/	/	/	/	/	/	/	/
	5310MHz	15.27	/	/	/	/	/	/	/	/	/
	5510MHz	15.59	/	/	/	/	/	/	/	/	/
	5550MHz	15.13	/	/	/	/	/	/	/	/	/
	5670MHz	15.24	/	/	/	/	/	/	/	/	/
	5710MHz	15.31	/	/	/	/	/	/	/	/	/

The data rate MCS0 is selected as worse condition, and the following cases are performed with this condition.

802.11ac-HT80 mode

Mode	Frequency	Test Result (dBm)									
		Data Rate									
		MCS0	MCS1	MCS2	MCS3	MCS4	MCS5	MCS6	MCS7	MCS8	MCS9
802.11ac (HT80)	5210MHz	13.37	/	/	/	/	/	/	/	/	/
	5290MHz	13.07	/	/	/	/	/	/	/	/	/
	5530MHz	13.25	/	/	/	/	/	/	/	/	/
	5610MHz	13.37	/	/	/	/	/	/	/	/	/
	5690MHz	13.45	/	/	/	/	/	/	/	/	/

The data rate MCS0 is selected as worse condition, and the following cases are performed with this condition.

Test graphs as below:

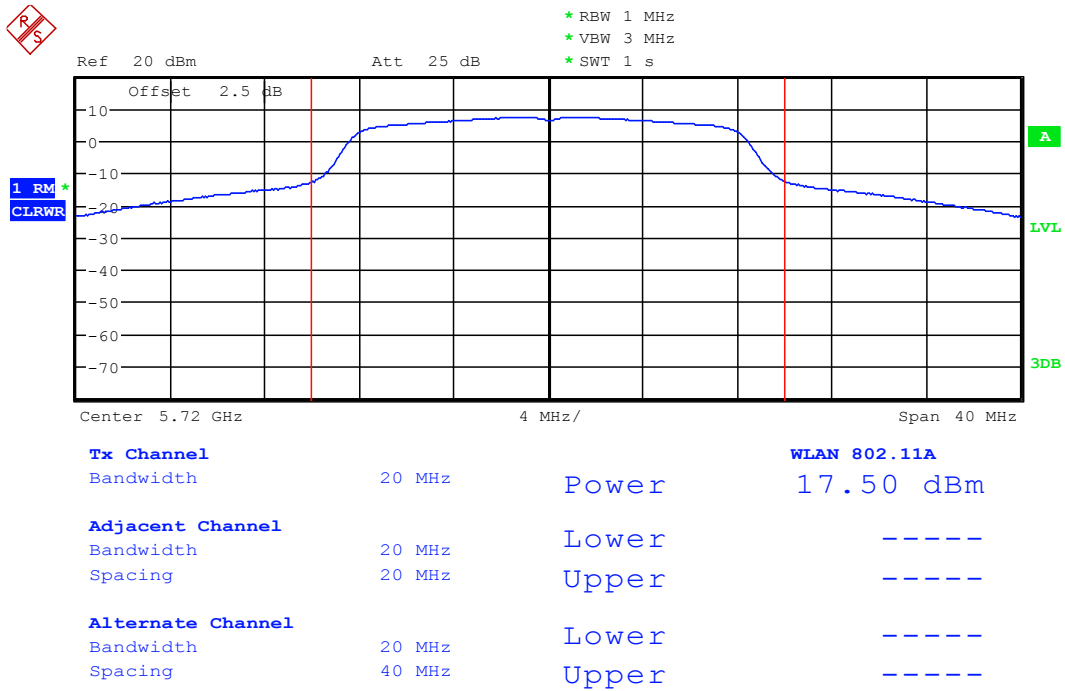

Date: 14.JAN.2022 04:44:38

802.11a 6Mbps ch144 5720MHz

A.3. Peak Power Spectral Density (conducted)

Measurement Limit:

Standard	Frequency (MHz)	Limit (dBm/MHz)
FCC CRF Part 15.407(a)	5150MHz~5250MHz	11
	5250MHz~5350MHz	11
	5470MHz~5725MHz	11

The output power measurement method Section F is made according to KDB 789033

Measurement Results:

Mode	Frequency	Power Spectral Density (dBm/MHz)	Conclusion
802.11a	5180 MHz	8.98	P
	5200 MHz	8.90	P
	5240 MHz	9.07	P
	5260 MHz	9.03	P
	5280 MHz	8.96	P
	5320 MHz	8.82	P
	5500 MHz	8.97	P
	5580 MHz	8.34	P
	5700 MHz	8.28	P
802.11n HT20	5180 MHz	8.14	P
	5200 MHz	8.27	P
	5240 MHz	7.94	P
	5260 MHz	8.41	P
	5280 MHz	7.82	P
	5320 MHz	7.96	P
	5500 MHz	8.04	P
	5580 MHz	7.53	P
	5700 MHz	7.41	P
802.11n HT40	5190 MHz	4.71	P
	5230 MHz	4.42	P
	5270 MHz	4.50	P
	5310 MHz	4.47	P
	5510 MHz	4.28	P
	5550 MHz	3.92	P
	5670 MHz	4.17	P
	5710 MHz	3.80	P
802.11ac HT80	5210MHz	-1.16	P
	5290MHz	-1.49	P

	5530MHz	-1.43	P
	5610MHz	-0.93	P
	5690 MHz	-1.83	P

Conclusion: PASS

Test graphs as below:

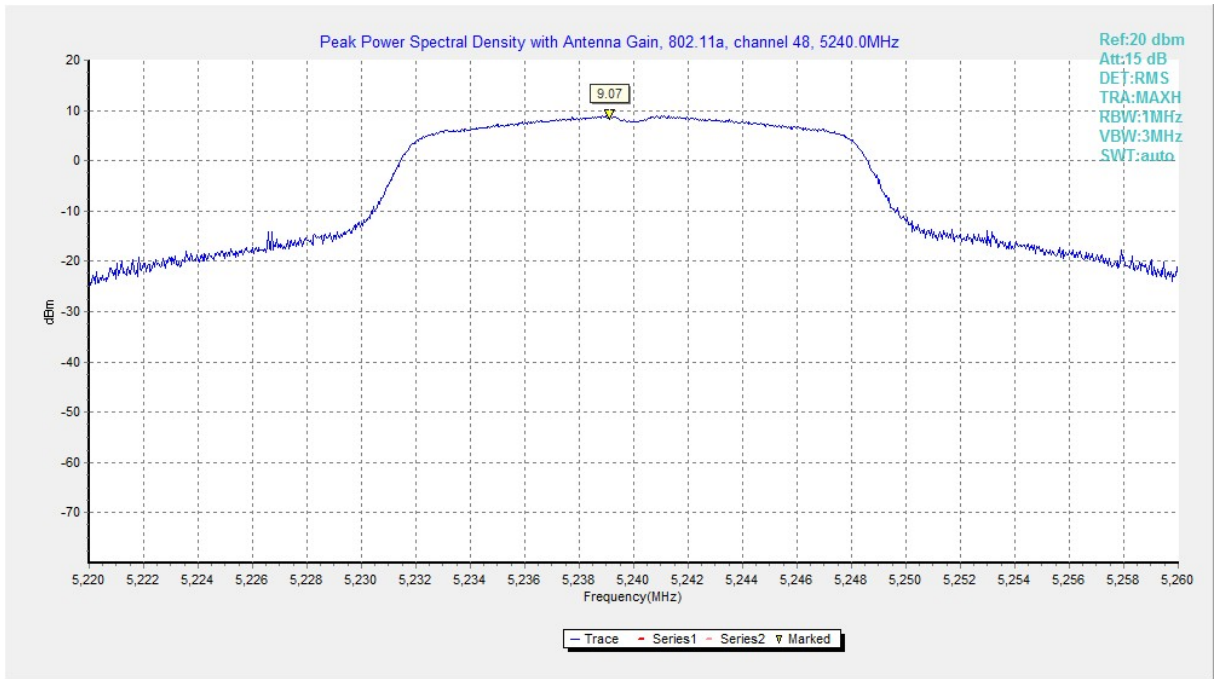

802.11a 6Mbps ch48 5240MHz

A.4. Occupied 26dB Bandwidth(conducted)

Measurement Limit:

Standard	Limit (kHz)
FCC 47 CFR Part 15.403 (i)	/

The measurement is made according to KDB 789033

Measurement Uncertainty:

Measurement Uncertainty	60.80Hz
-------------------------	---------

Measurement Result:

Mode	Frequency	Occupied 26dB Bandwidth (MHz)		conclusion
		Fig.	Value	
802.11a	5180 MHz	Fig.1	39.20	P
	5200 MHz	Fig.2	39.15	P
	5240 MHz	Fig.3	39.95	P
	5260 MHz	Fig.4	39.40	P
	5280 MHz	Fig.5	39.70	P
	5320 MHz	Fig.6	39.85	P
	5500 MHz	Fig.7	39.10	P
	5580 MHz	Fig.8	39.10	P
	5700 MHz	Fig.9	40.25	P
	5720 MHz	Fig.10	40.00	P
802.11n HT20	5180 MHz	Fig.11	37.20	P
	5200 MHz	Fig.12	34.80	P
	5240 MHz	Fig.13	37.60	P
	5260 MHz	Fig.14	35.90	P
	5280 MHz	Fig.15	36.80	P
	5320 MHz	Fig.16	37.00	P
	5500 MHz	Fig.17	38.60	P
	5580 MHz	Fig.18	37.75	P
	5700 MHz	Fig.19	37.70	P
	5720 MHz	Fig.20	37.75	P
802.11n HT40	5190 MHz	Fig.21	56.56	P
	5230 MHz	Fig.22	71.44	P
	5270 MHz	Fig.23	60.80	P
	5310 MHz	Fig.24	59.12	P
	5510 MHz	Fig.25	59.52	P
	5550 MHz	Fig.26	66.08	P
	5670 MHz	Fig.27	70.08	P
	5710 MHz	Fig.28	64.80	P
802.11ac HT80	5210MHz	Fig.29	81.44	P
	5290MHz	Fig.30	89.44	P

	5530MHz	Fig.31	103.52	P
	5610MHz	Fig.32	88.00	P
	5690 MHz	Fig.33	112.16	P

Conclusion: PASS

Test graphs as below:

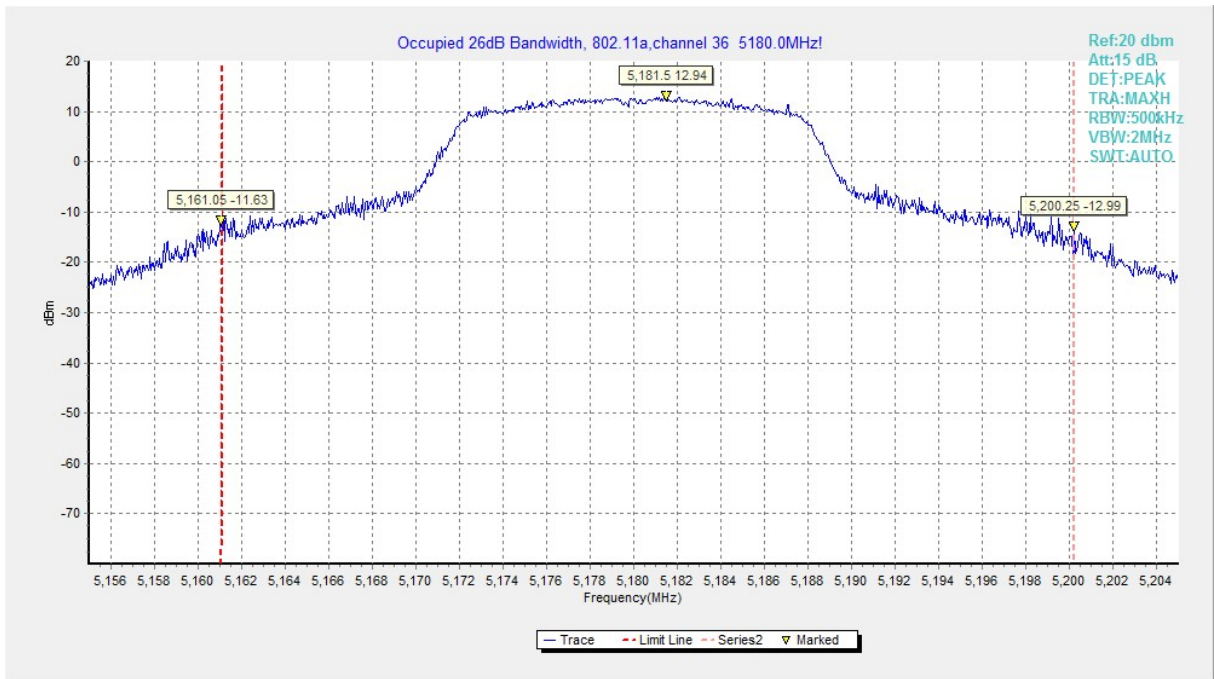

Fig.1 Occupied 26dB Bandwidth (802.11a, 5180MHz)

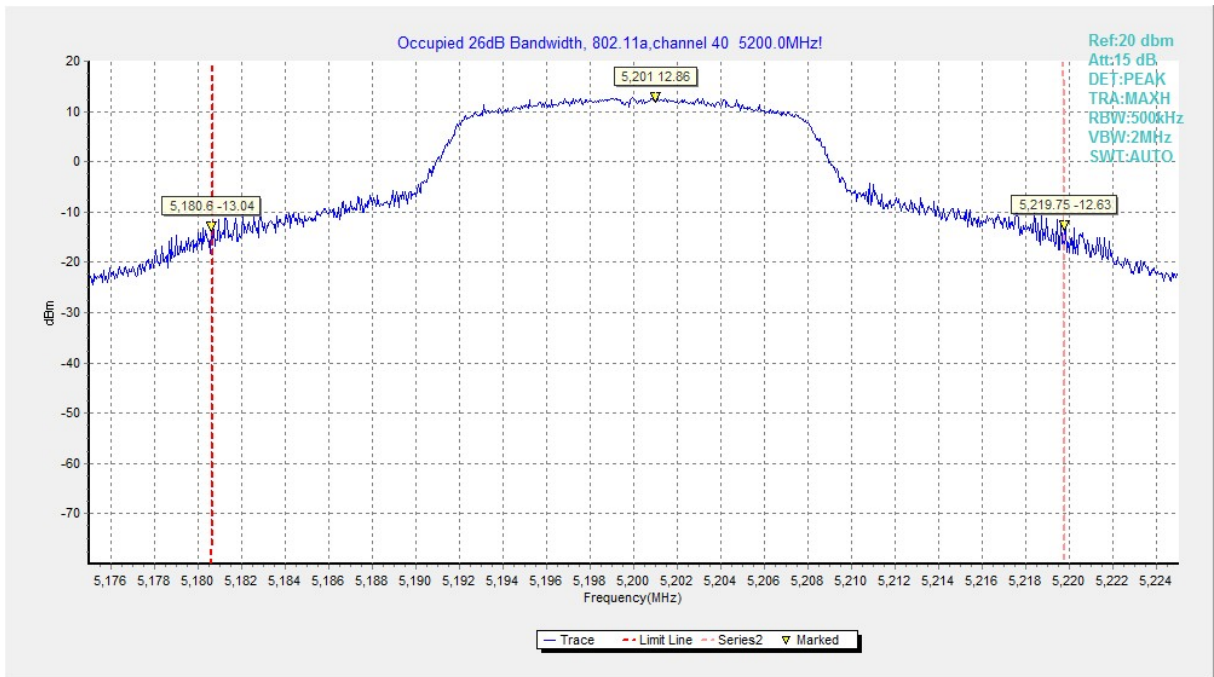

Fig.2 Occupied 26dB Bandwidth (802.11a, 5200MHz)

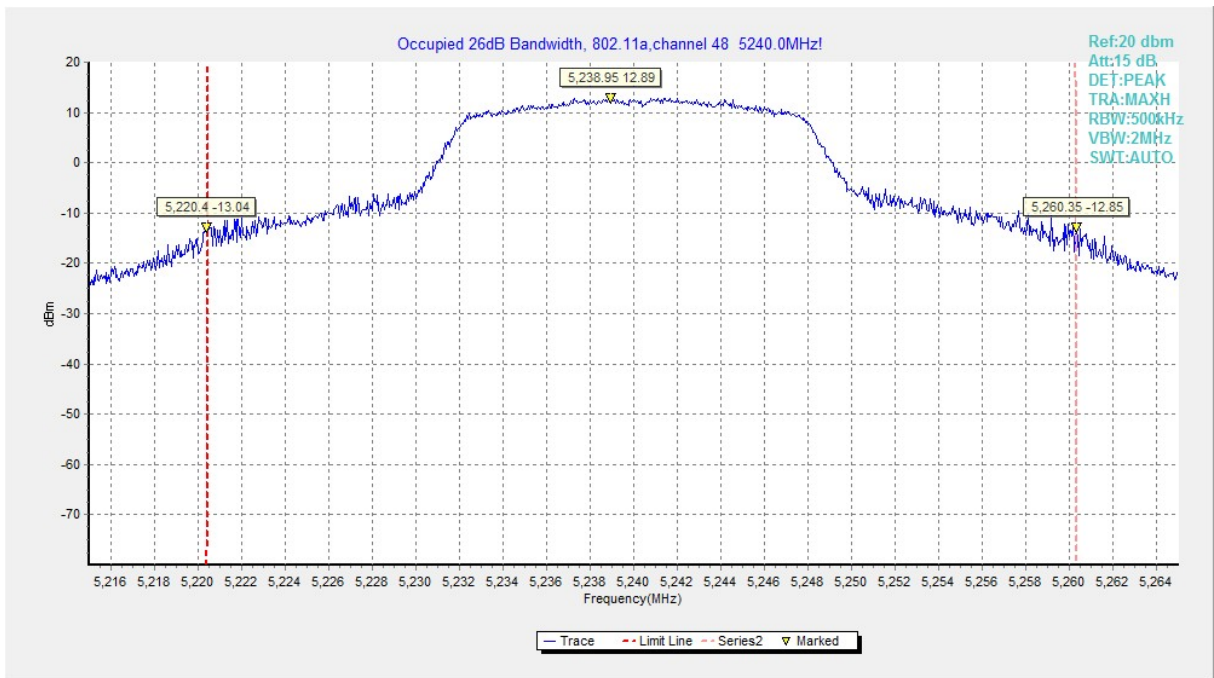

Fig.3 Occupied 26dB Bandwidth (802.11a, 5240MHz)

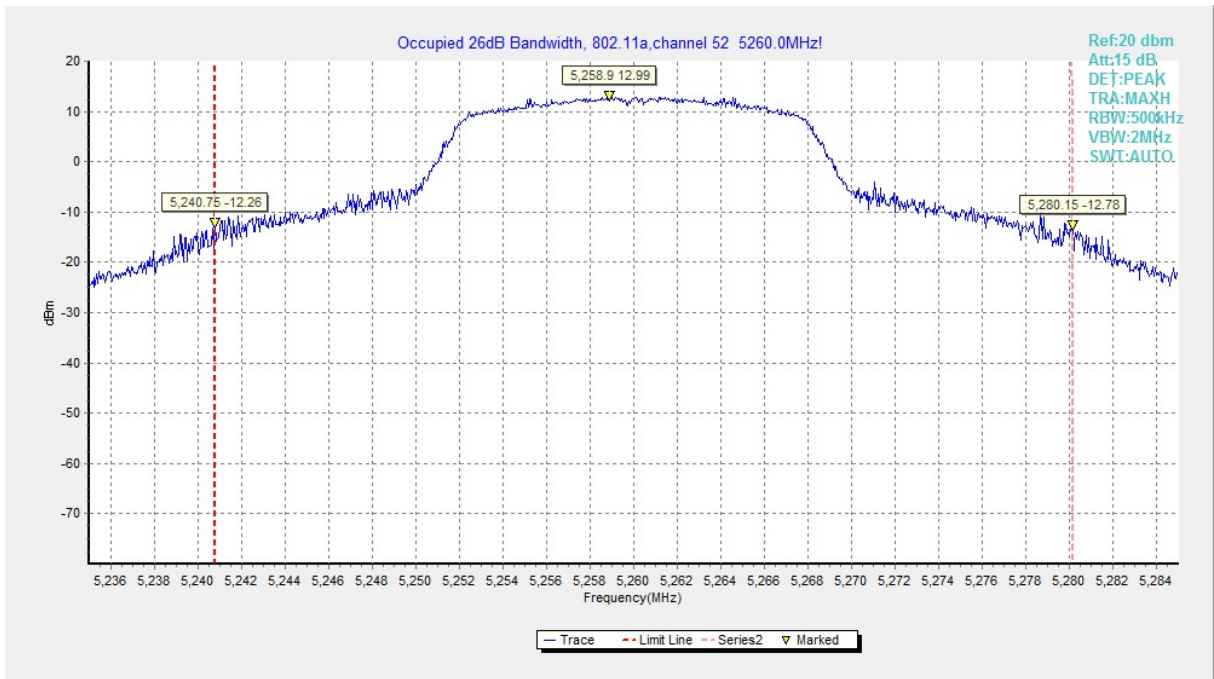

Fig.4 Occupied 26dB Bandwidth (802.11a, 5260MHz)

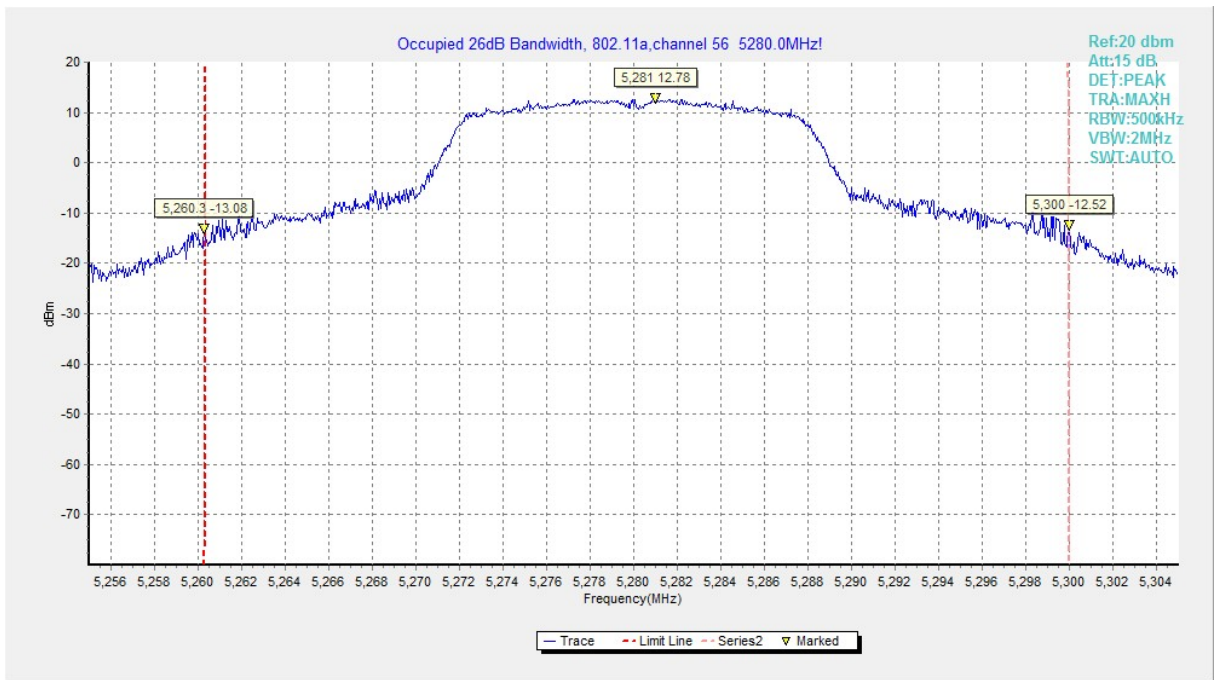

Fig.5 Occupied 26dB Bandwidth (802.11a, 5280MHz)

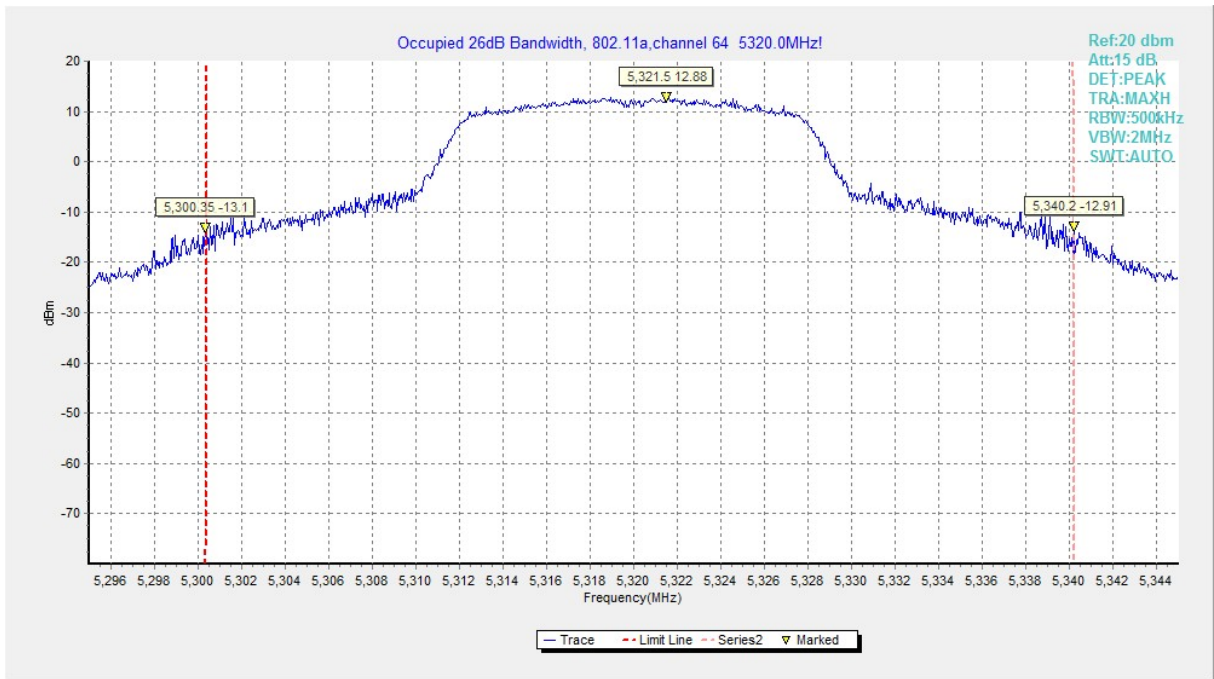

Fig.6 Occupied 26dB Bandwidth (802.11a, 5320MHz)

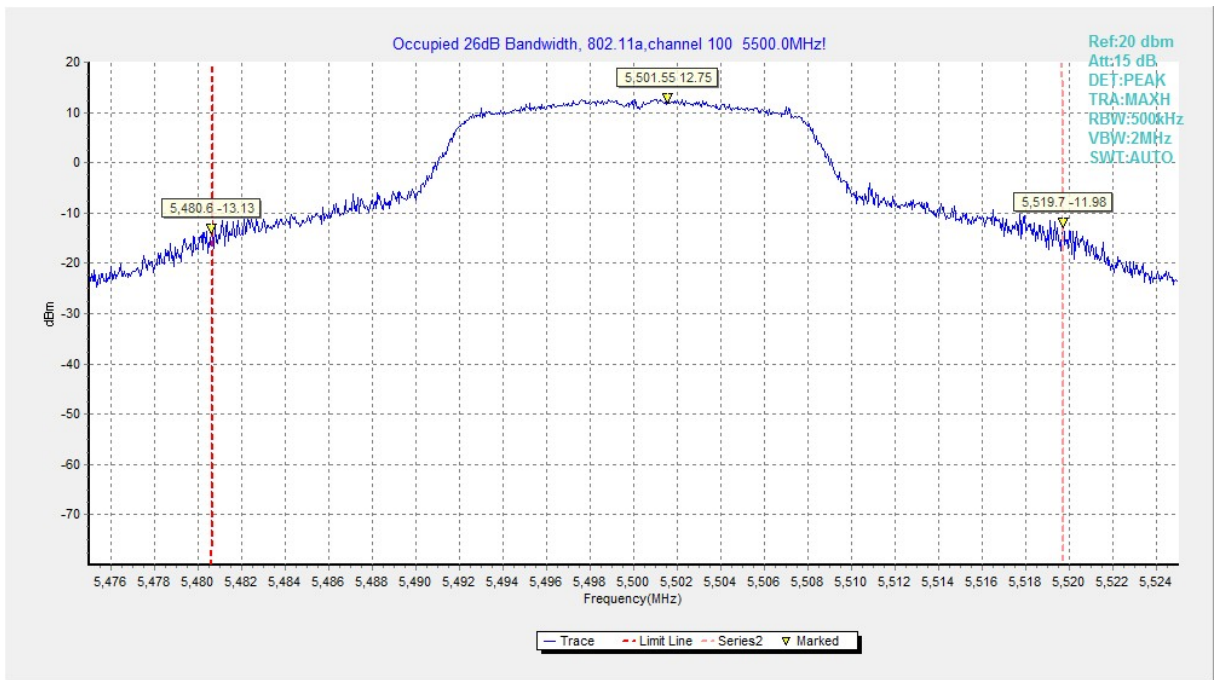

Fig.7 Occupied 26dB Bandwidth (802.11a, 5500MHz)

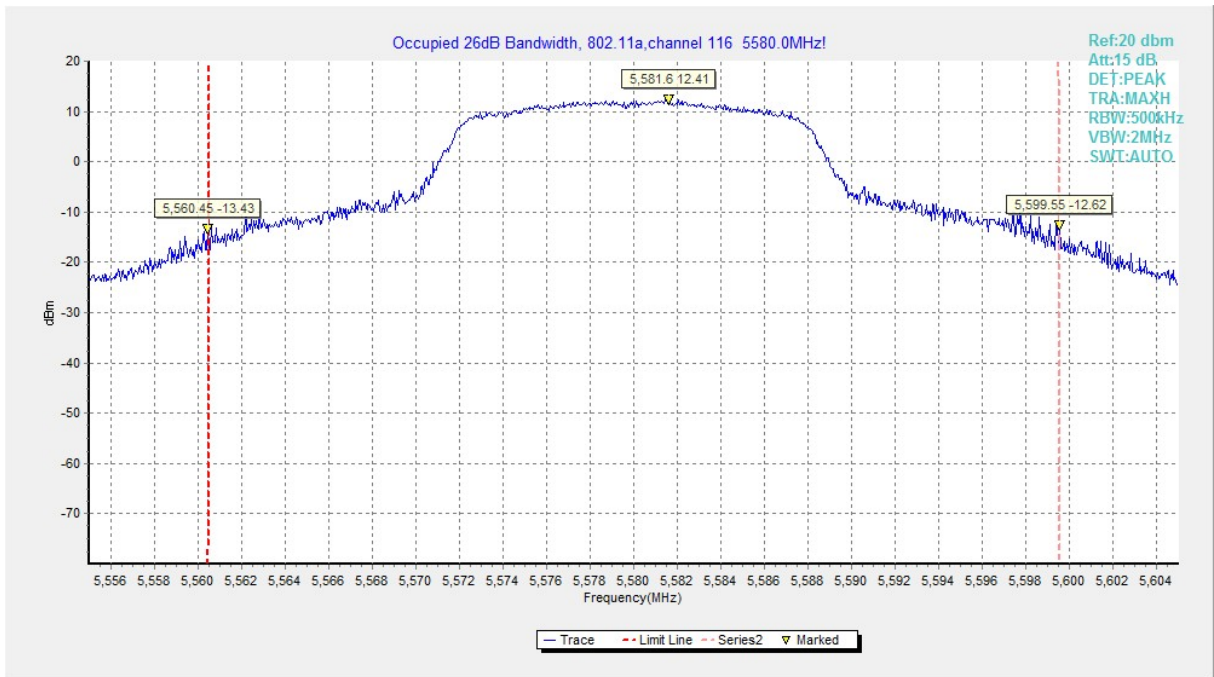

Fig.8 Occupied 26dB Bandwidth (802.11a, 5580MHz)

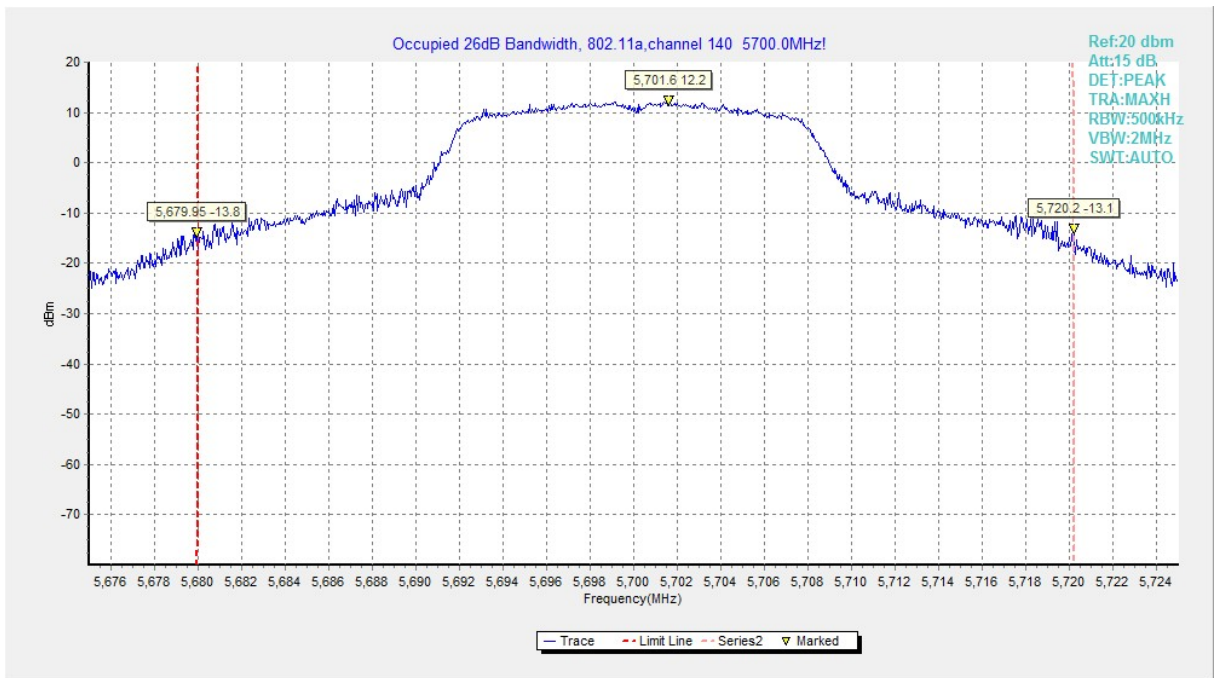

Fig.9 Occupied 26dB Bandwidth (802.11a, 5700MHz)

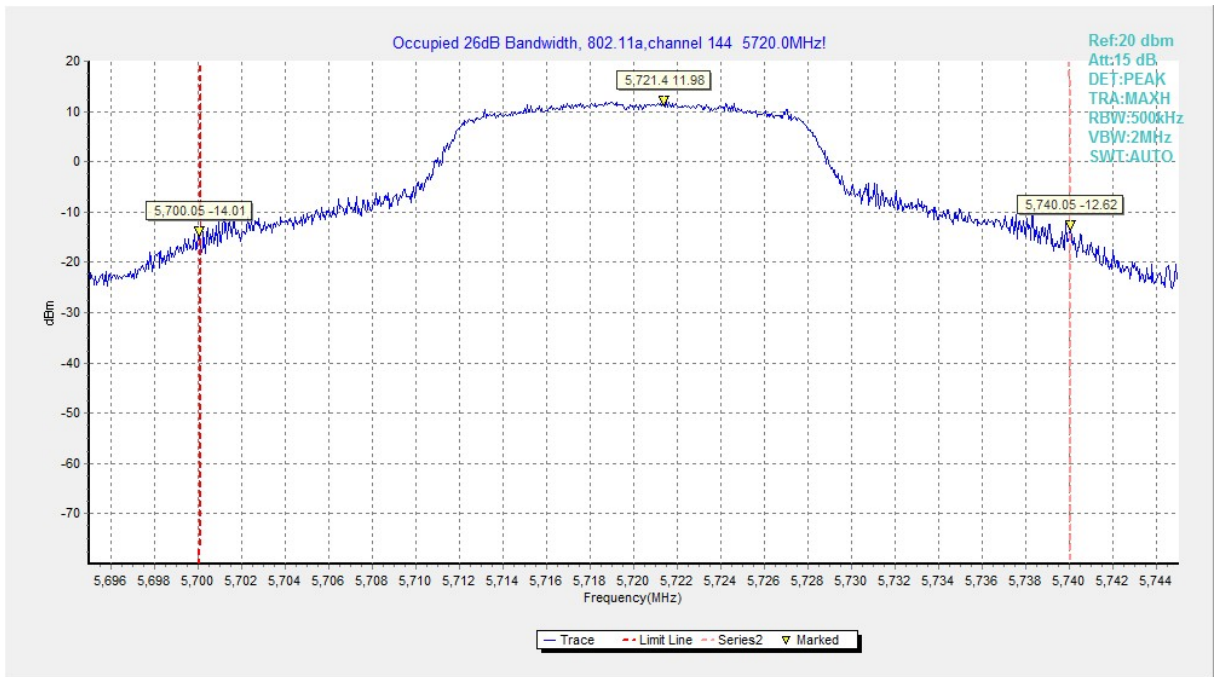

Fig.10 Occupied 26dB Bandwidth (802.11a, 5720MHz)

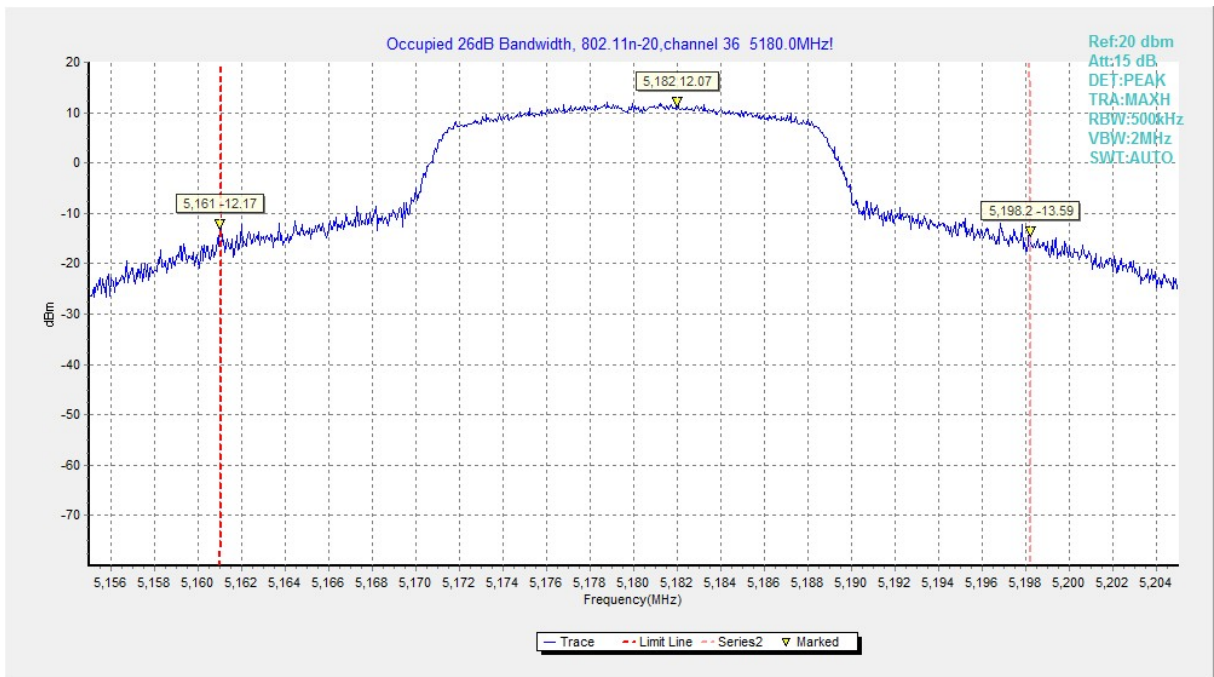

Fig.11 Occupied 26dB Bandwidth (802.11n-HT20, 5180MHz)

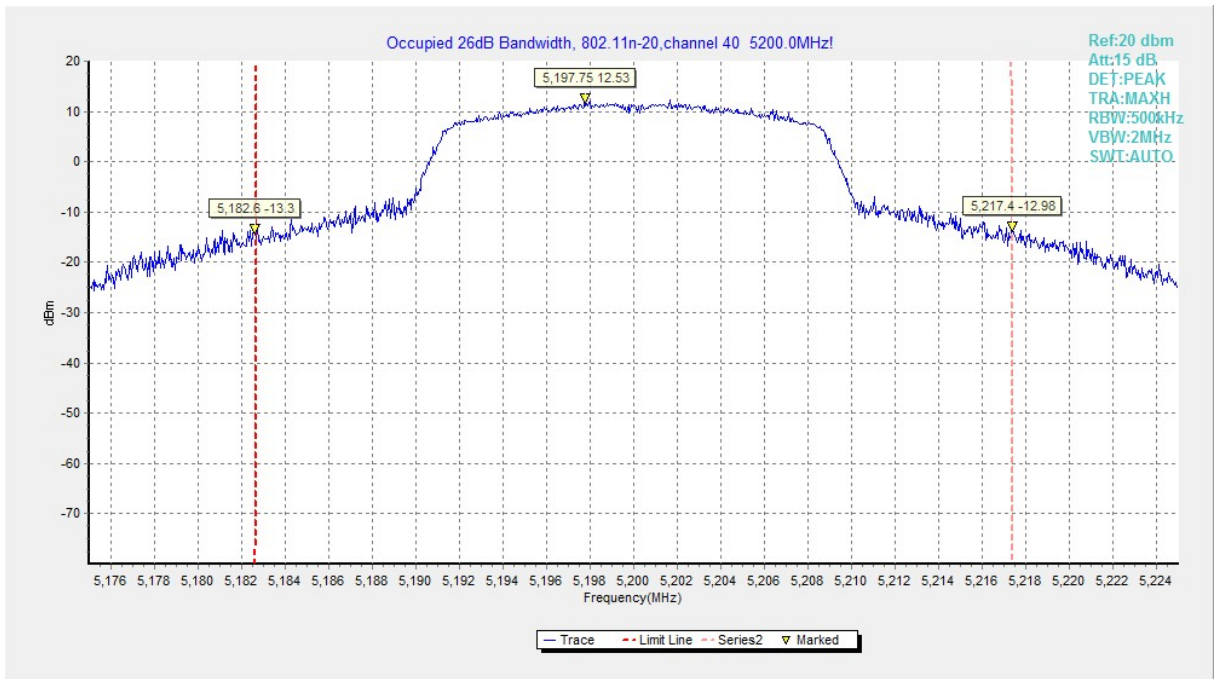

Fig.12 Occupied 26dB Bandwidth (802.11n-HT20, 5200MHz)

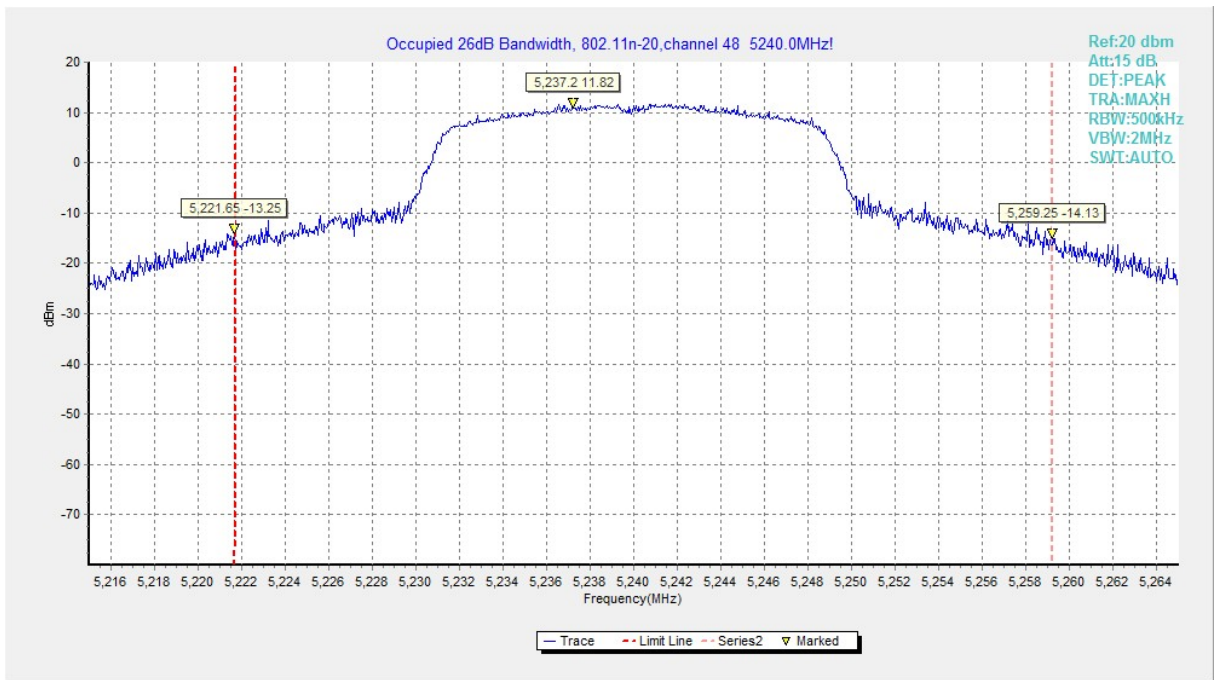

Fig.13 Occupied 26dB Bandwidth (802.11n-HT20, 5240MHz)

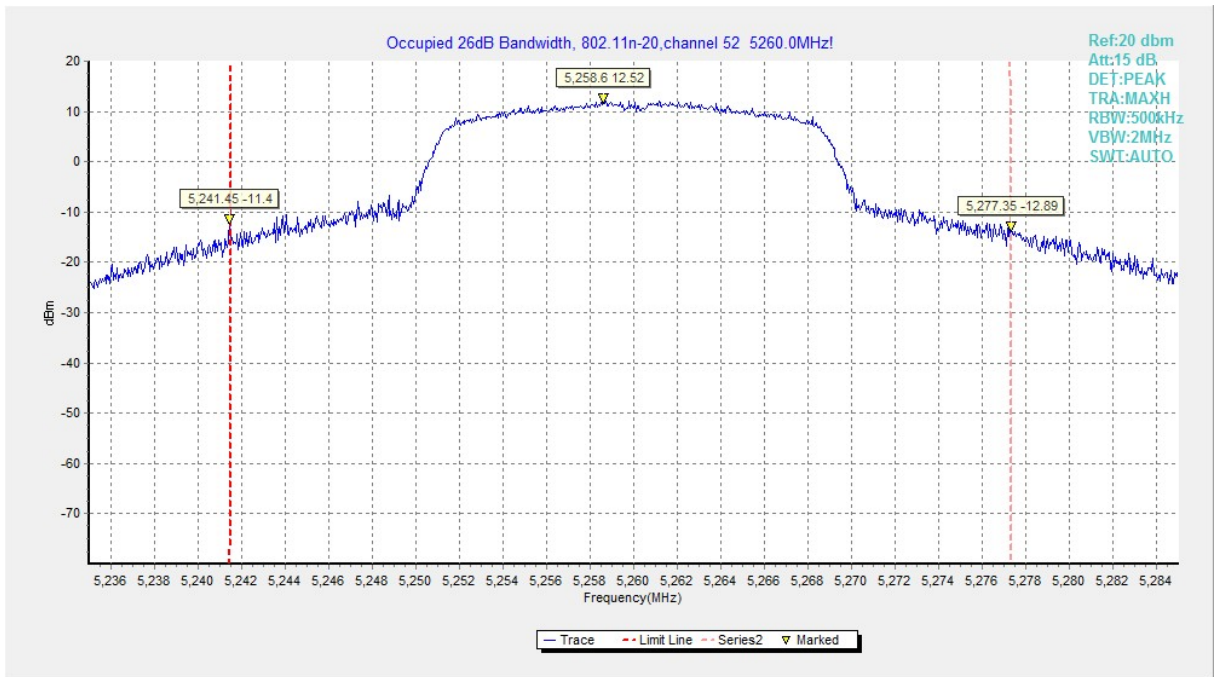

Fig.14 Occupied 26dB Bandwidth (802.11n-HT20, 5260MHz)

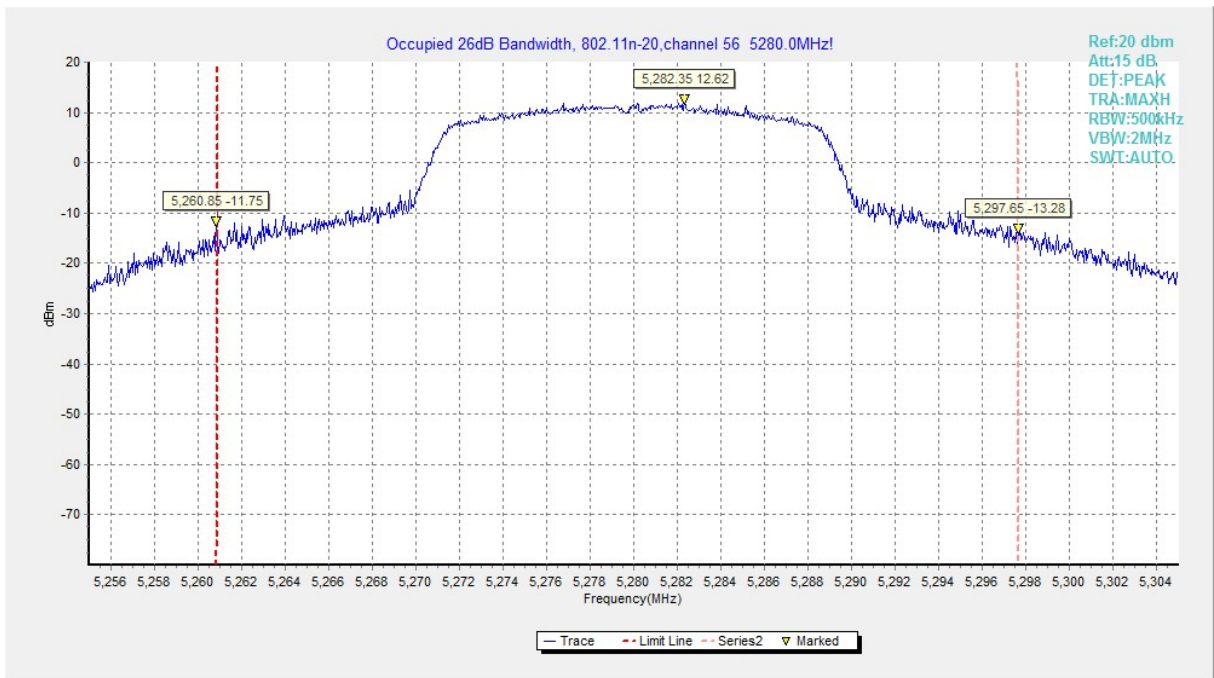

Fig.15 Occupied 26dB Bandwidth (802.11n-HT20, 5280MHz)

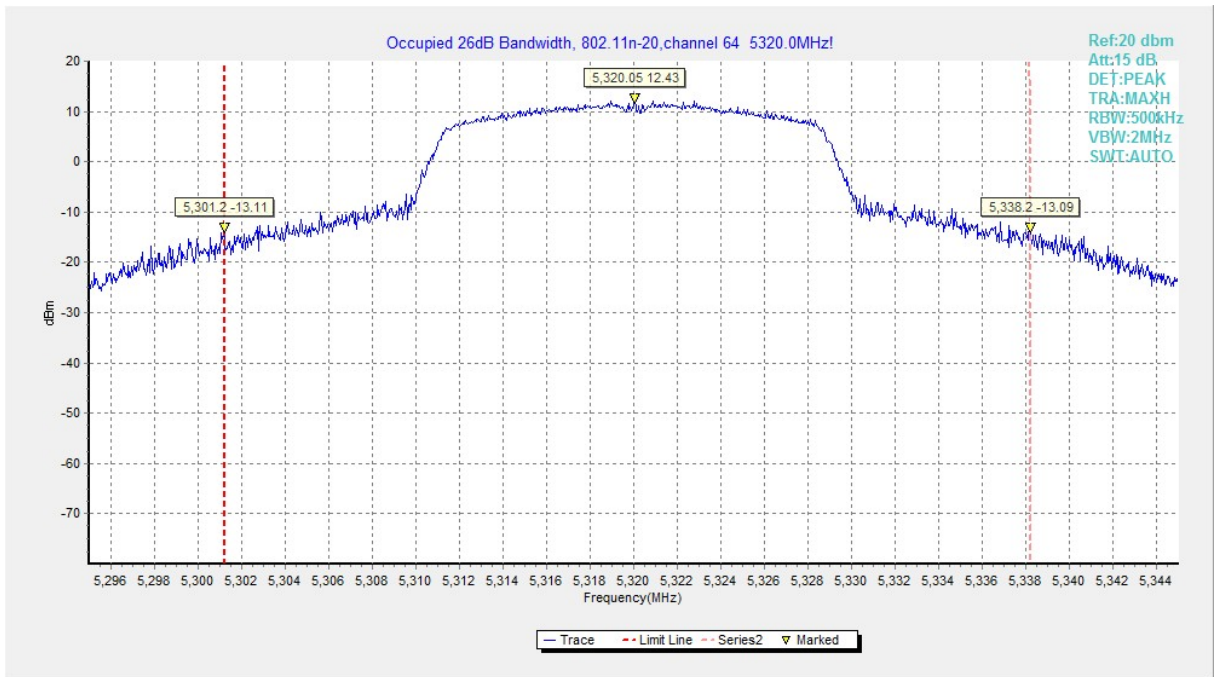

Fig.16 Occupied 26dB Bandwidth (802.11n-HT20, 5320MHz)

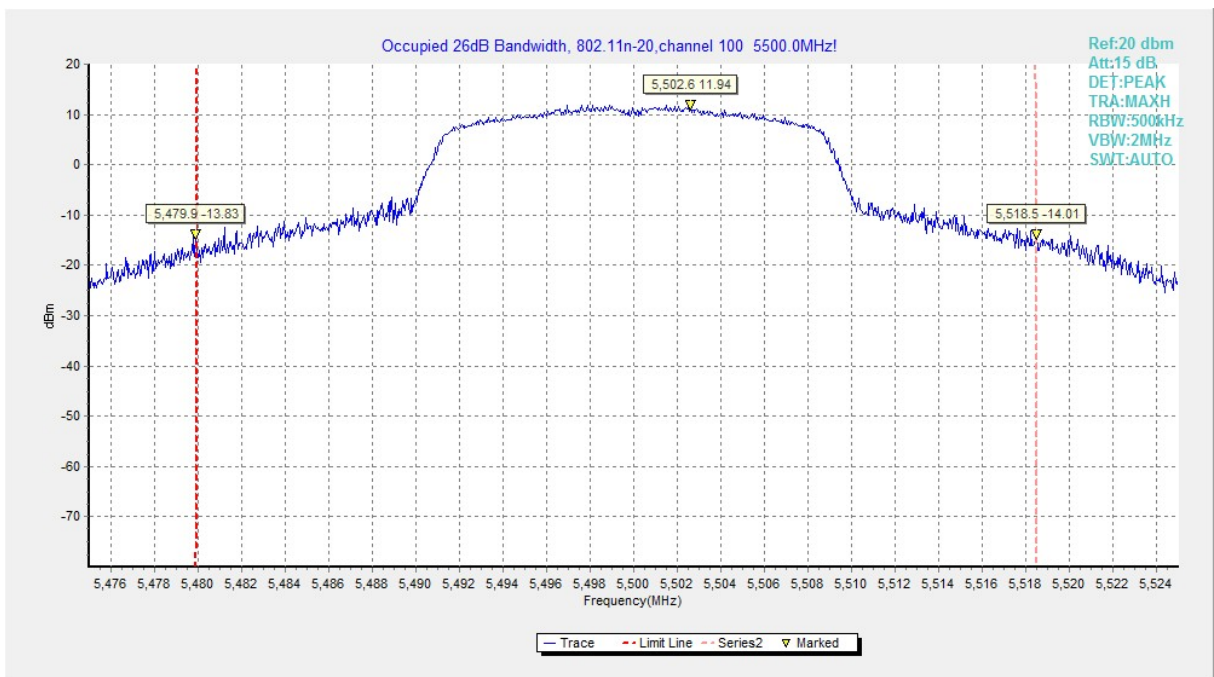

Fig.17 Occupied 26dB Bandwidth (802.11n-HT20, 5500MHz)

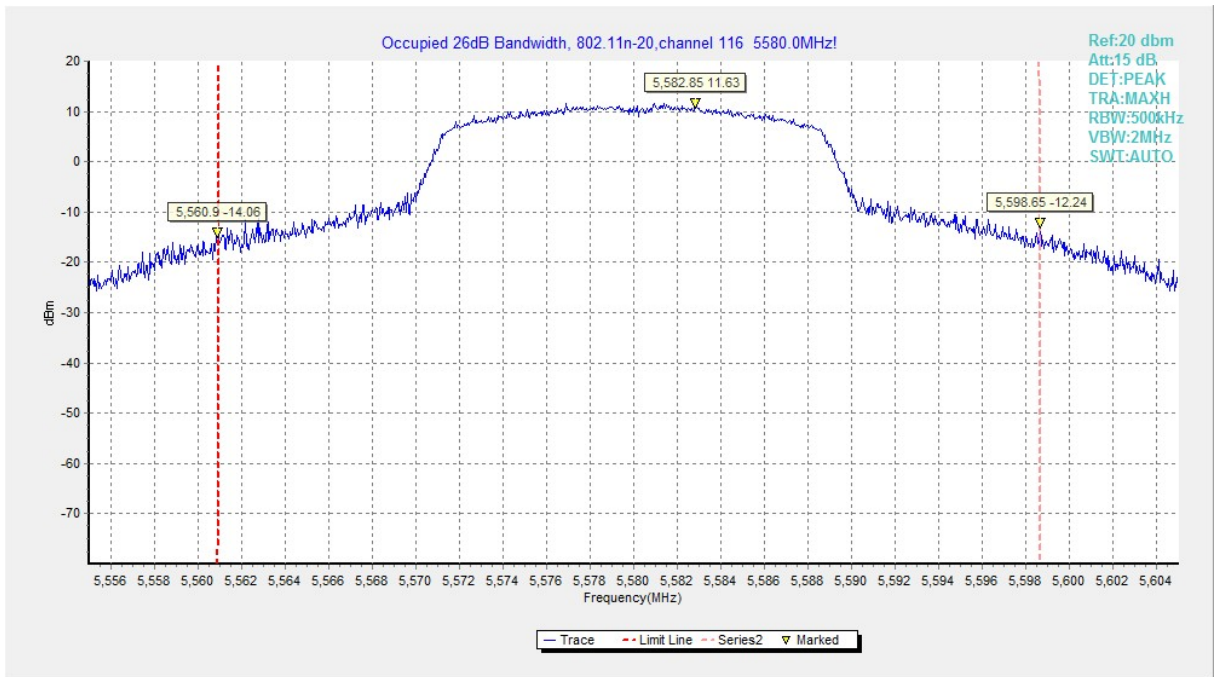

Fig.18 Occupied 26dB Bandwidth (802. 11n-HT20, 5580MHz)

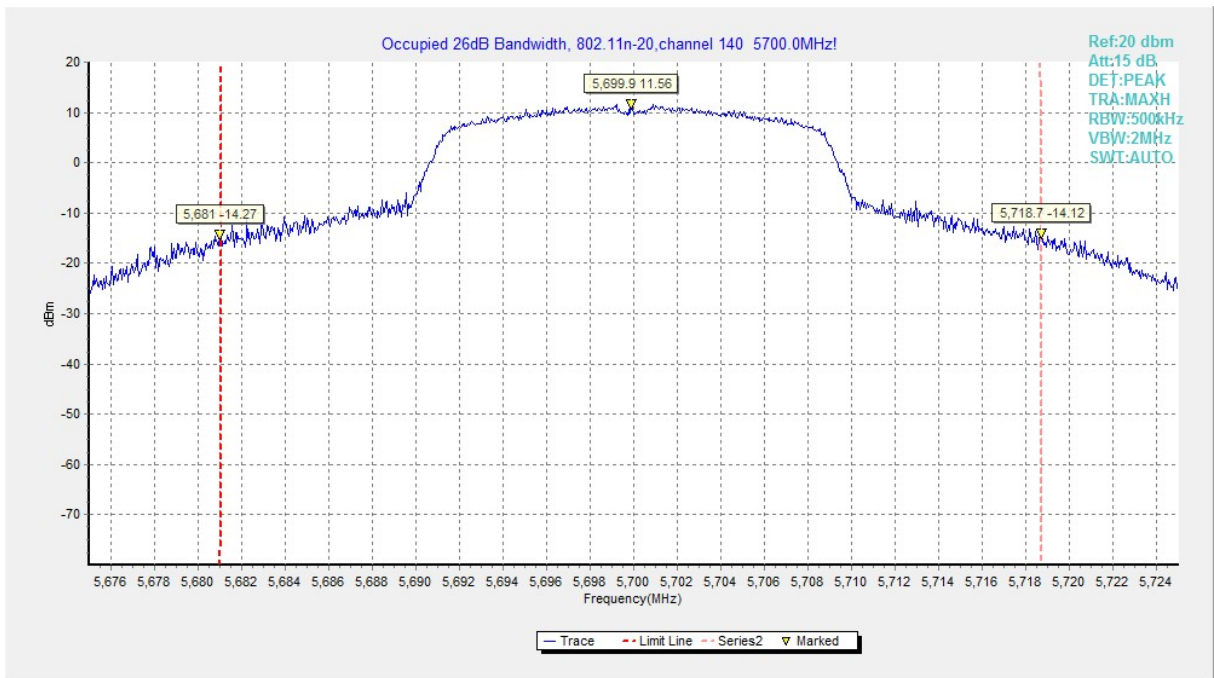

Fig.19 Occupied 26dB Bandwidth (802. 11n-HT20, 5700MHz)

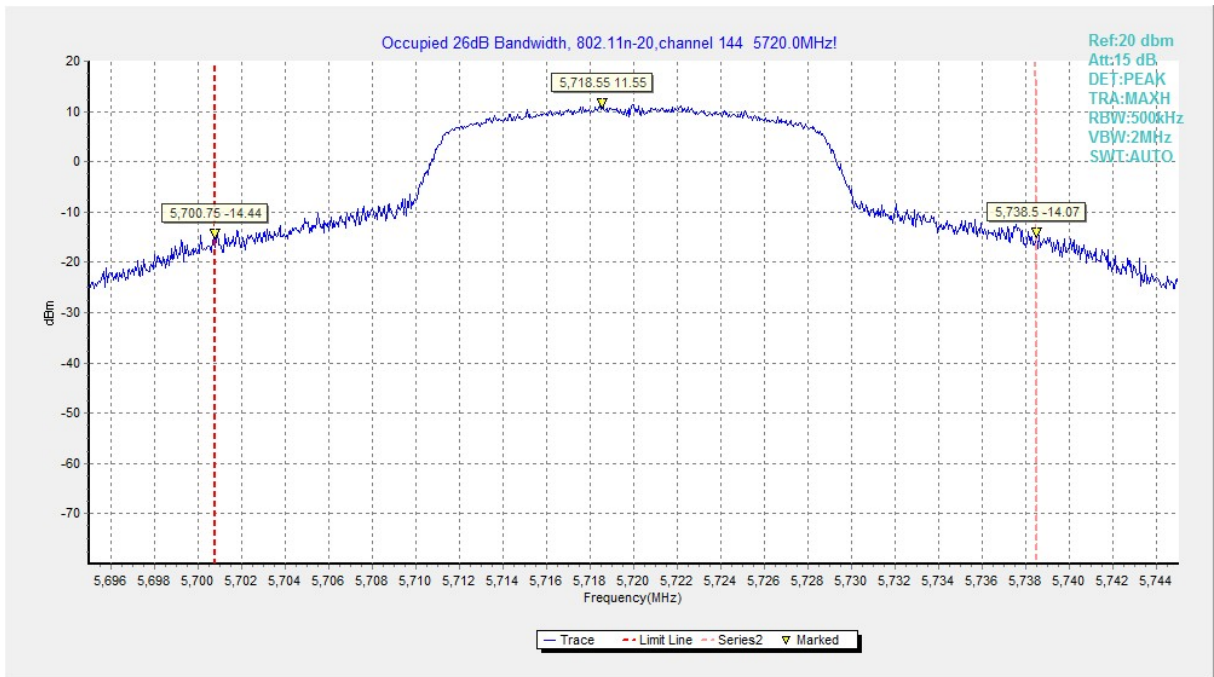

Fig.20 Occupied 26dB Bandwidth (802. 11n-HT20, 5720MHz)

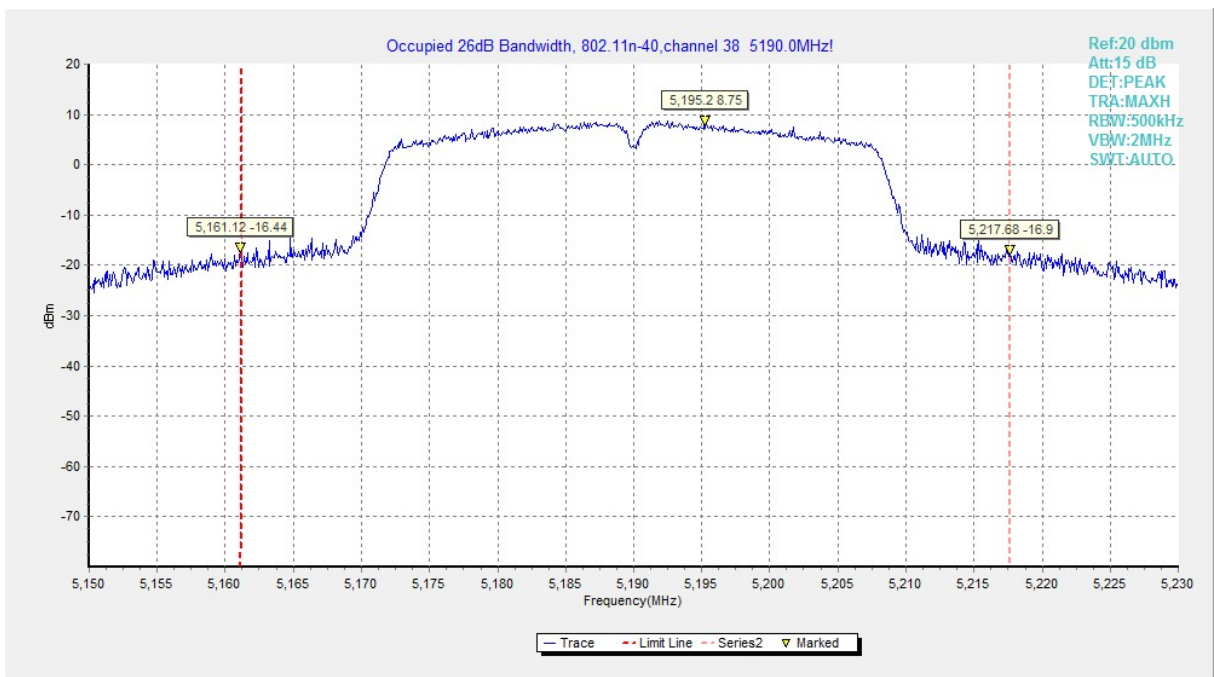

Fig.21 Occupied 26dB Bandwidth (802.11n-HT40, 5190MHz)

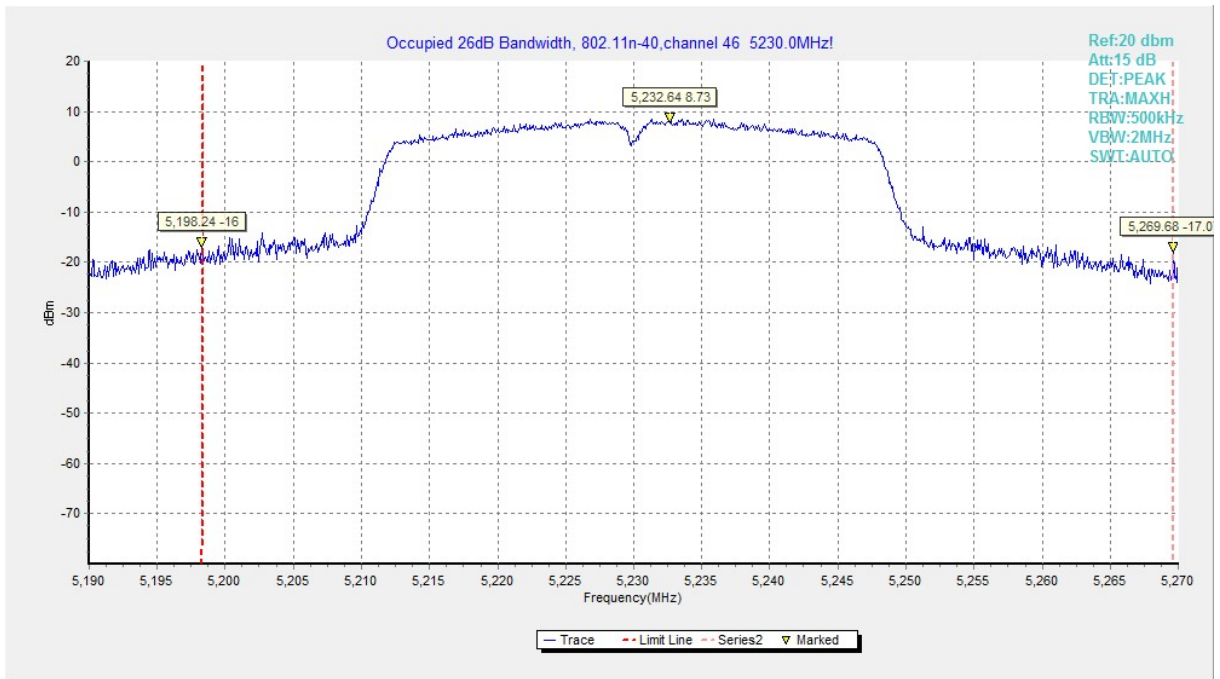

Fig.22 Occupied 26dB Bandwidth (802.11n-HT40, 5230MHz)

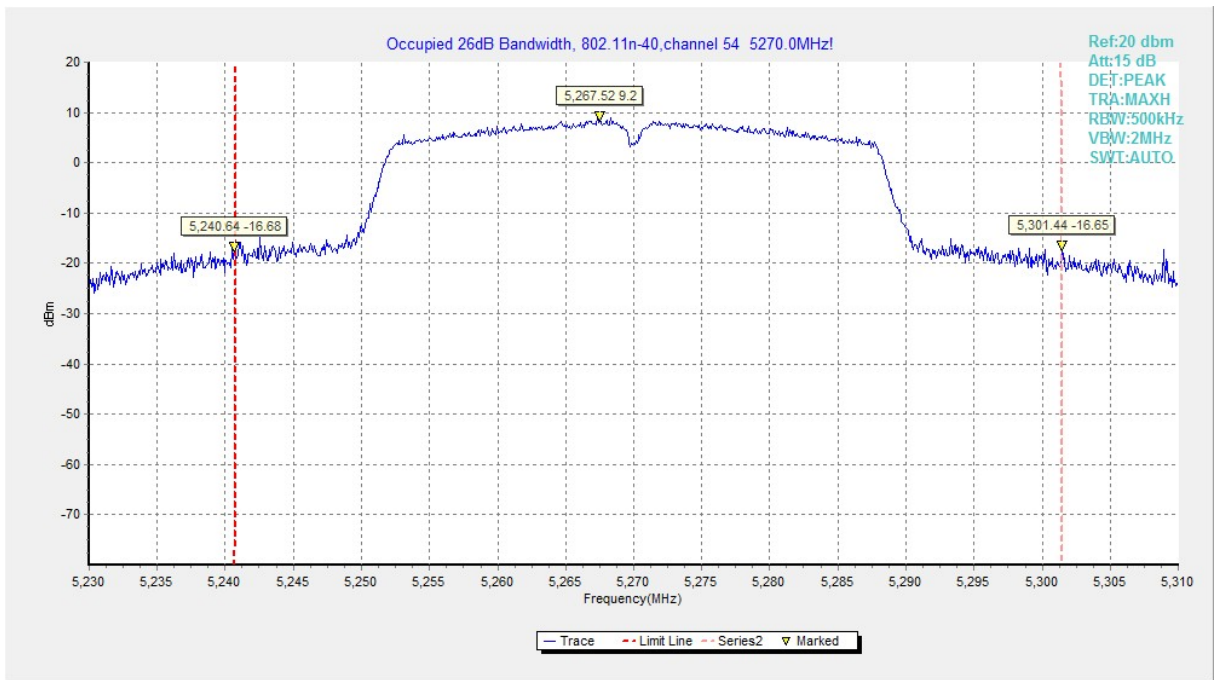

Fig.23 Occupied 26dB Bandwidth (802.11n-HT40, 5270MHz)

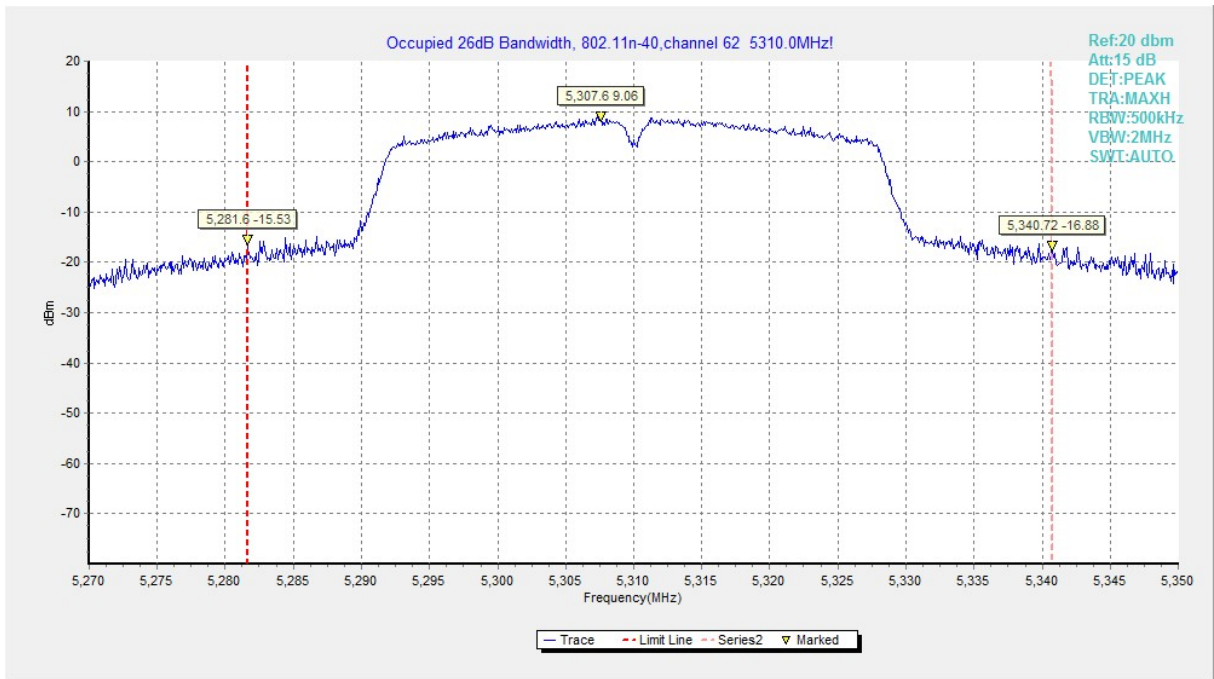

Fig.24 Occupied 26dB Bandwidth (802.11n-HT40, 5310MHz)

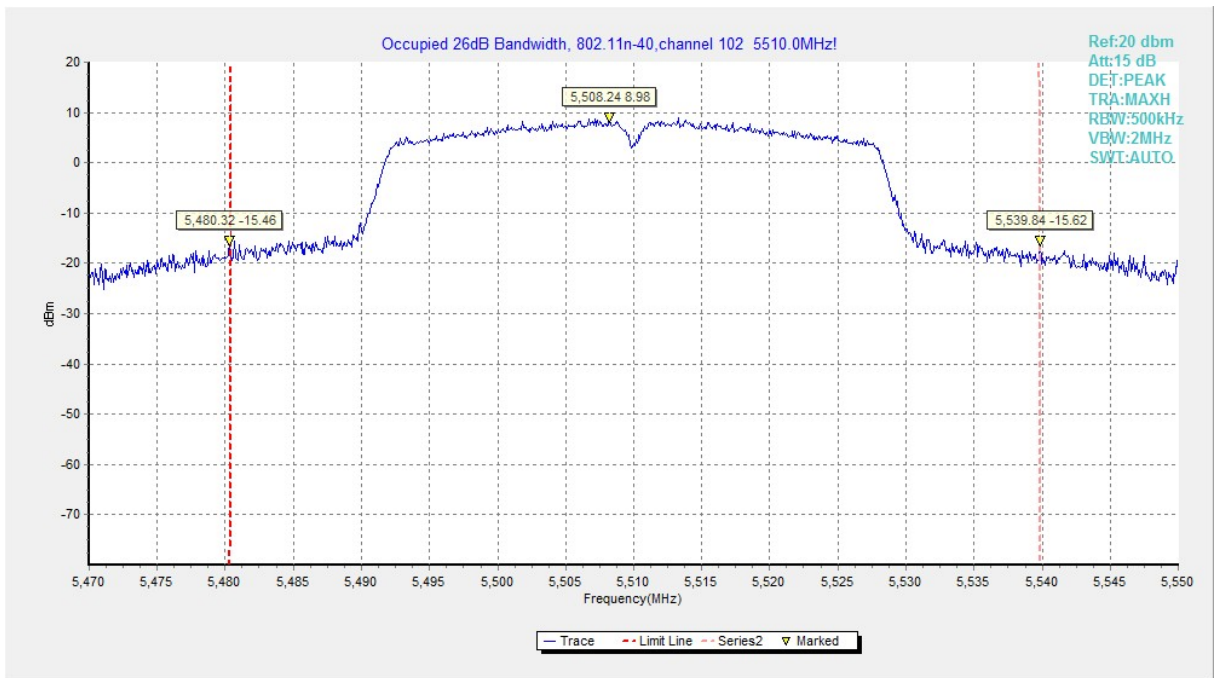

Fig.25 Occupied 26dB Bandwidth (802.11n-HT40, 5510MHz)

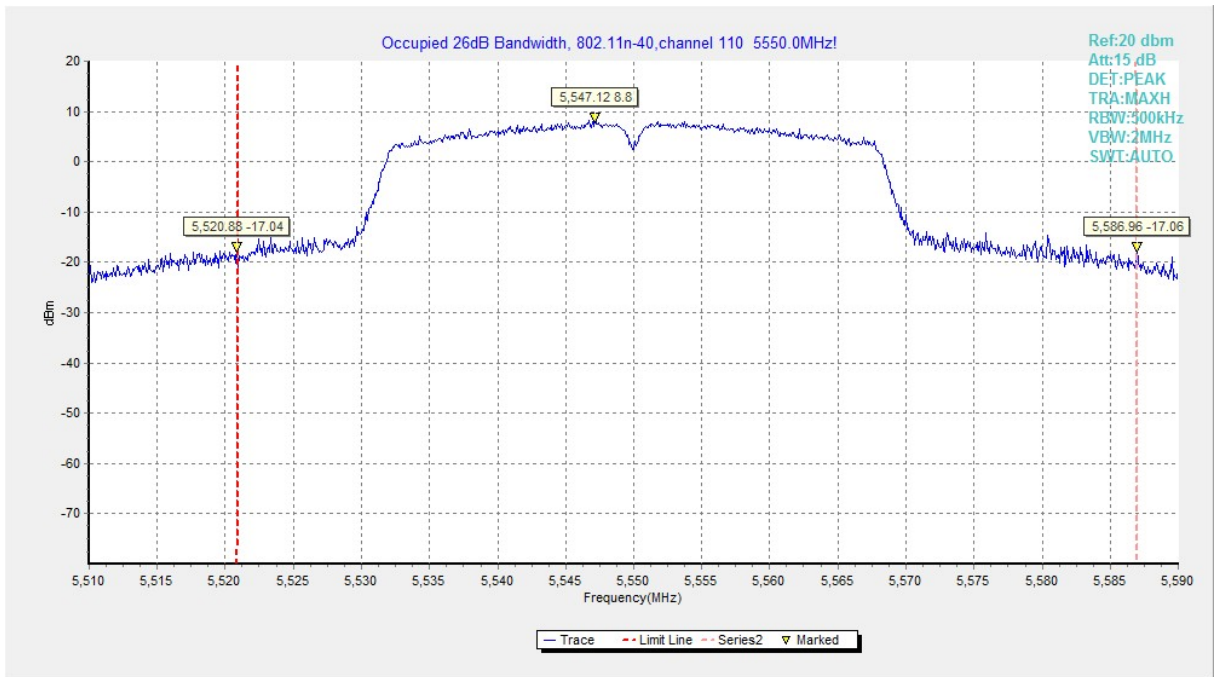

Fig.26 Occupied 26dB Bandwidth (802. 11n-HT40, 5550MHz)

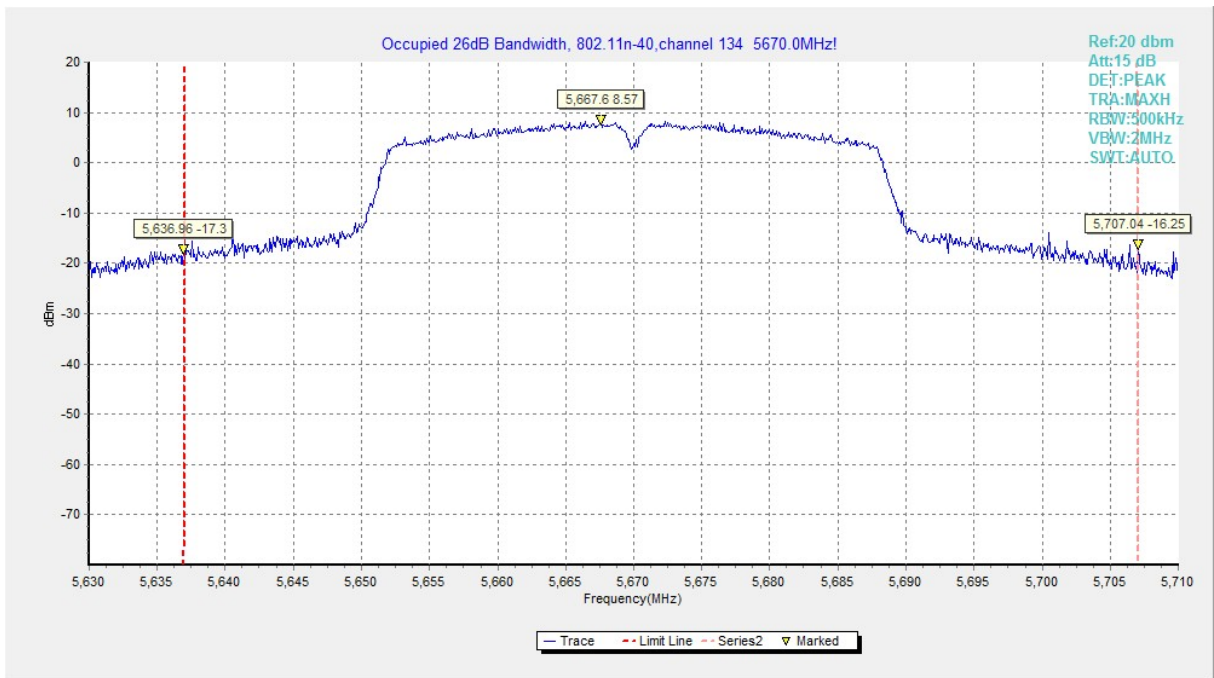

Fig.27 Occupied 26dB Bandwidth (802. 11n-HT40, 5670MHz)

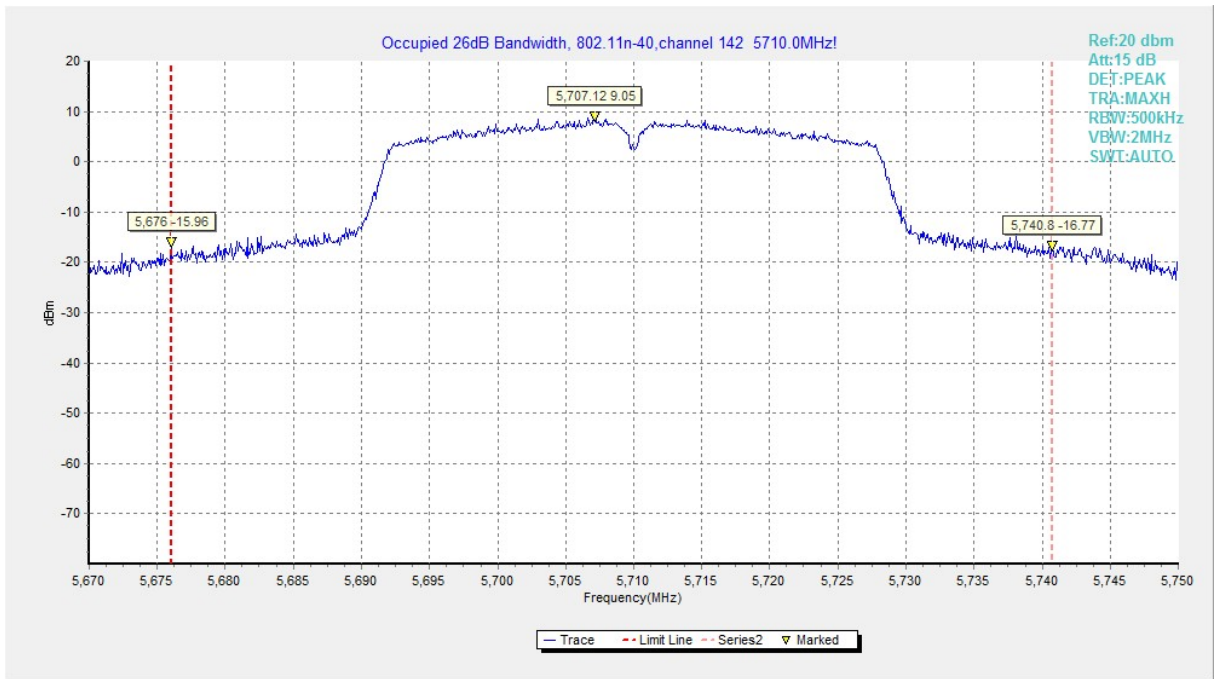

Fig.28 Occupied 26dB Bandwidth (802. 11n-HT40, 5710MHz)

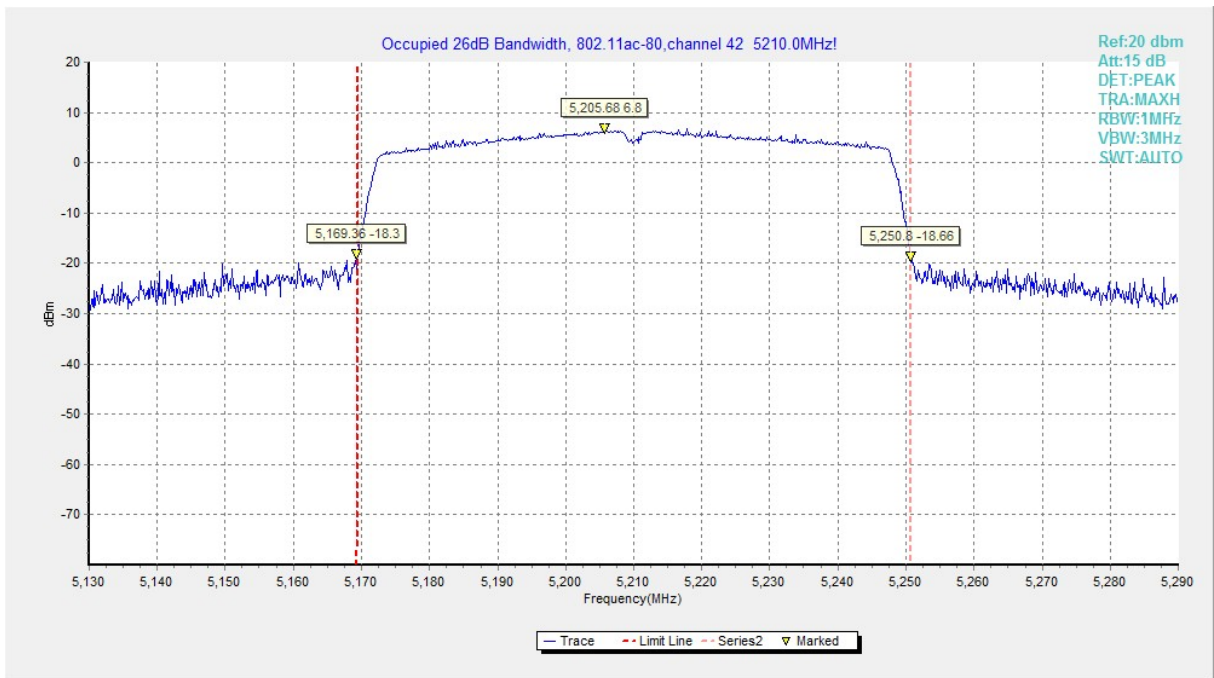

Fig.29 Occupied 26dB Bandwidth (802. 11ac-HT80, 5210MHz)

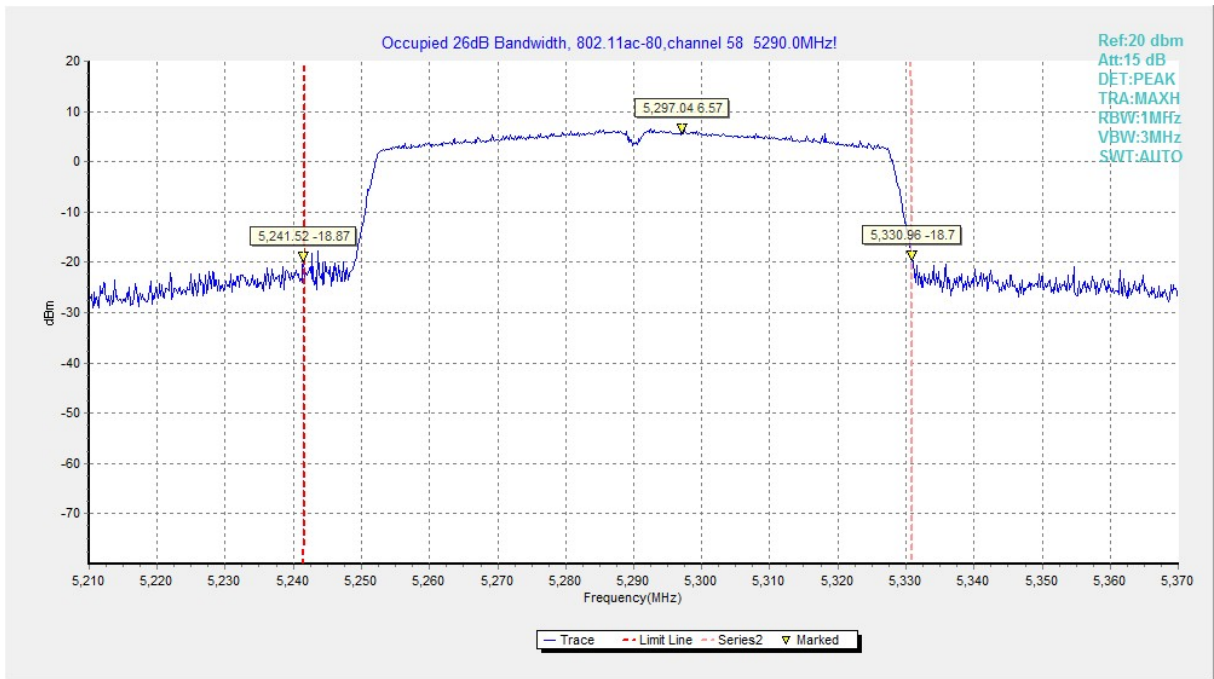

Fig.30 Occupied 26dB Bandwidth (802. 11ac-HT80, 5290MHz)

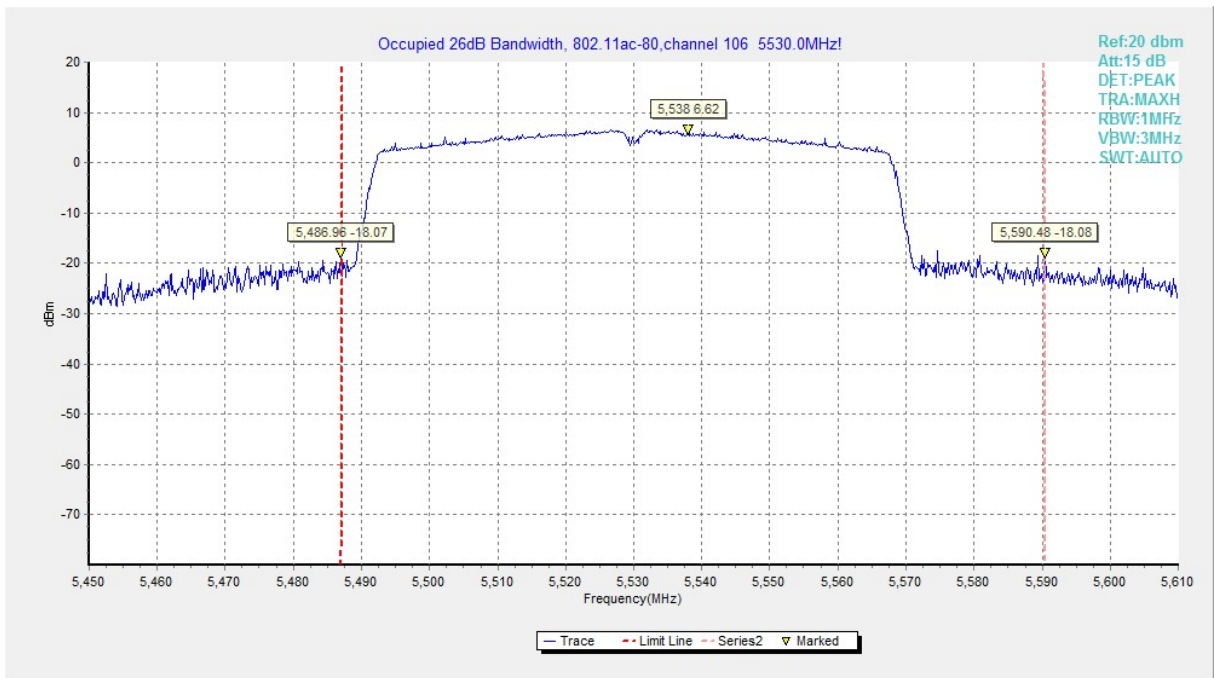

Fig.31 Occupied 26dB Bandwidth (802. 11ac-HT80, 5530MHz)

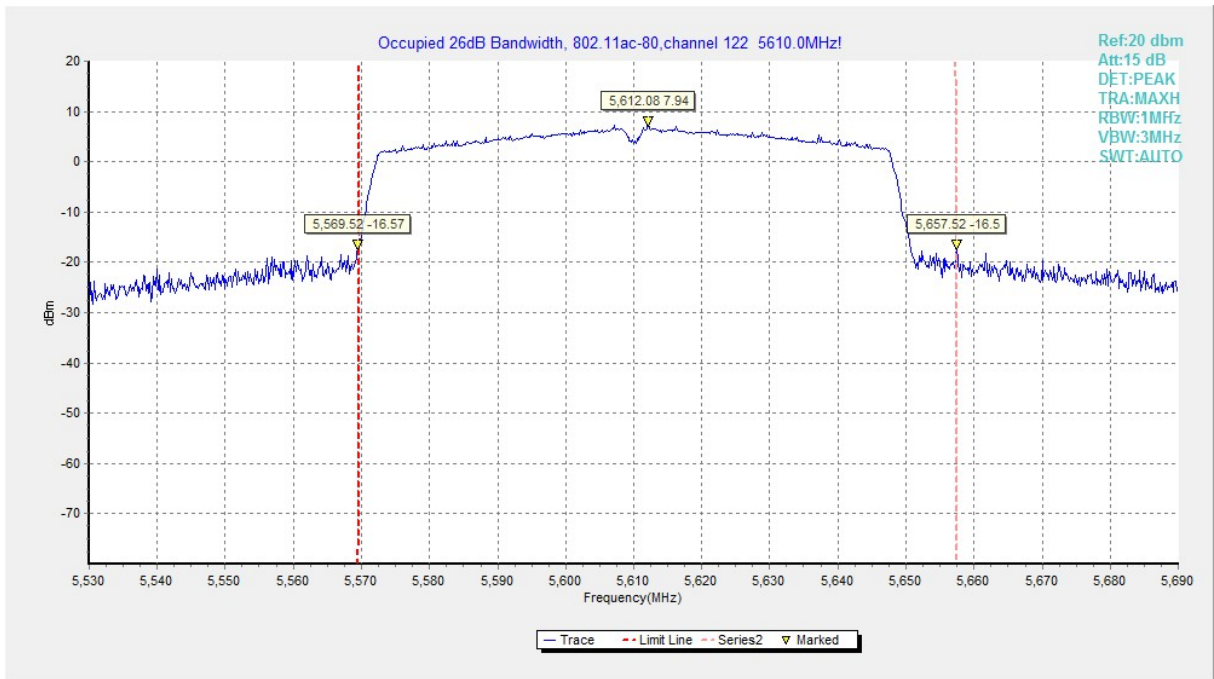

Fig.32 Occupied 26dB Bandwidth (802.11ac-HT80, 5610MHz)

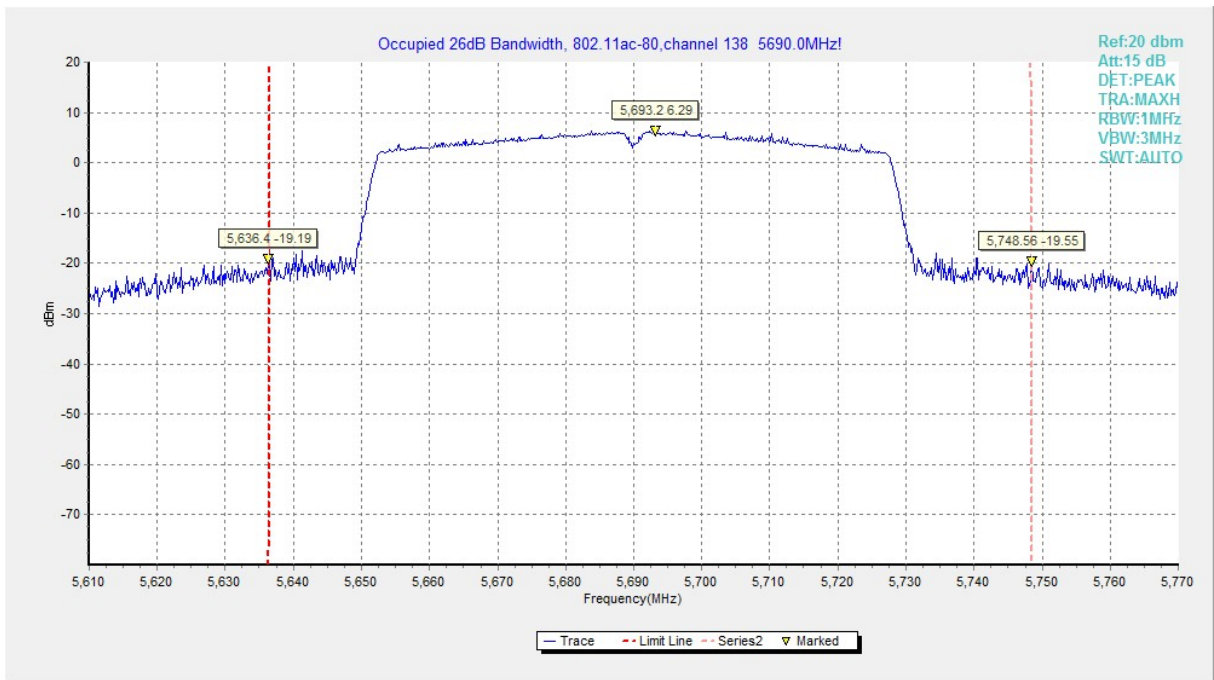

Fig.33 Occupied 26dB Bandwidth (802.11ac-HT80, 5690MHz)

A.5. Band Edges Compliance

A.5.1 Band Edges - Radiated

Method of Measurement: See ANSI C63.10-2013-clause 6.4 & 6.5 & 6.6

Measurement Limit:

15.407(b) Undesirable emission limits.

Except as shown in paragraph (b)(7) of this section, the maximum emissions outside of the frequency bands of operation shall be attenuated in accordance with the following limits:

- (1) For transmitters operating in the 5.15–5.25 GHz band: All emissions outside of the 5.15–5.35 GHz band shall not exceed an e.i.r.p. of -27 dBm/MHz.
- (2) For transmitters operating in the 5.25–5.35 GHz band: All emissions outside of the 5.15–5.35 GHz band shall not exceed an e.i.r.p. of -27 dBm/MHz.
- (3) For transmitters operating in the 5.47–5.725 GHz band: All emissions outside of the 5.47–5.725 GHz band shall not exceed an e.i.r.p. of -27 dBm/MHz.

radiated emissions which fall in the restricted bands, as defined in § 15.205(a), must also comply with the radiated emission limits specified in § 15.209(a) (see § 15.205(c)).

Limit in restricted band:

Frequency (MHz)	Field strength(μ V/m)	Measurement distance (m)
0.009 - 0.490	2400/F(kHz)	300
0.490 - 1.705	24000/F(kHz)	30
1.705 – 30.0	30	30

Frequency of emission (MHz)	Field strength(μ V/m)	Field strength(dBuV/m)
30-88	100	40
88-216	150	43.5
216-960	200	46
Above 960	500	54

Set up:

Tabletop devices shall be placed on a nonconducting platform with nominal top surface dimensions 1 m by 1.5 m and the table height shall be 1.5 m.

The EUT and transmitting antenna shall be centered on the turntable.

Test Condition

The EUT shall be tested 1 near top, 1 near middle, and 1 near bottom. Set the unlicensed wireless device to operate in continuous transmit mode. For unlicensed wireless devices unable to be configured for 100% duty cycle even in test mode, configure the system for the maximum duty cycle supported.

When required for unlicensed wireless devices, measurements of the variation of the input power or the radiated signal level of the fundamental frequency component of the emission, as

appropriate, shall be performed with the supply voltage varied between 85% and 115% of the nominal rated supply voltage.

Exploratory radiated emissions measurements

Exploratory radiated measurements shall be performed at the measurement distance or at a closer distance than that specified for compliance to determine the emission characteristics of the EUT and, if applicable, the EUT configuration that produces the maximum level of emissions. The frequencies of maximum emission may be determined by manually positioning the antenna close to the EUT, and then moving the antenna over all sides of the EUT while observing a spectral display. It is advantageous to have prior knowledge of the frequencies of emissions, although this may be determined from such a near-field scan. The near-field scan shall only be used to determine the frequency but not the amplitude of the emissions. Where exploratory measurements are not adequate to determine the worst-case operating modes and are used only to identify the frequencies of the highest emissions, additional preliminary tests can be required.

For emissions from the EUT, the maximum level shall be determined by rotating the EUT and its antenna through 0° to 360°. For each mode of operation required to be tested, the frequency spectrum (based on findings from exploratory measurements) shall be monitored.

Broadband antennas and a spectrum analyzer or a radio-noise meter with a panoramic display are often useful in this type of test. If either antenna height or EUT azimuth are not fully measured during exploratory testing, then complete testing can be required at the OATS or semi-anechoic chamber when the final full spectrum testing is performed.

Final radiated emissions measurements

The final measurements are using the orientation and equipment arrangement of the EUT based on the measurement results found during the preliminary (exploratory) measurements, the EUT arrangement, appropriate modulation, and modes of operation that produce the emissions that have the highest amplitude relative to the limit shall be selected for the final measurement.

For emissions from the EUT, the maximum level shall be determined by rotating the EUT and its antenna through 0° to 360°. Final measurements for the EUT require a measurement antenna height scan of 1 m to 4 m and the antenna rotated to repeat the measurements for both the horizontal and vertical antenna polarizations. For each mode of operation required to be tested, the frequency spectrum (based on findings from exploratory measurements) shall be monitored.

For each mode selected, record the frequency and amplitude of the highest fundamental emission (if applicable), as well as the frequency and amplitude of the six highest spurious emissions relative to the limit. Emissions more than 20 dB below the limit do not need to be reported.

This maximization process was repeated with the EUT positioned in each of its three orthogonal orientations.

The receiver references:

Frequency of emission (MHz)	RBW/VBW	Sweep Time(s)
30-1000	100KHz/300KHz	5
1000-4000	1MHz/3MHz	15
4000-18000	1MHz/3MHz	40

18000-26500	1MHz/3MHz	20
-------------	-----------	----

Measurement Result:

Mode	Frequency	Test Results	Conclusion
802.11a	5180 MHz	Fig.34	P
	5320 MHz	Fig.35	P
	5500 MHz	Fig.36	P
	5700 MHz	Fig.37	P
802.11n HT20	5180 MHz	Fig.38	P
	5320 MHz	Fig.39	P
	5500 MHz	Fig.40	P
	5700 MHz	Fig.41	P
802.11ac HT20	5180 MHz	Fig.42	P
	5320 MHz	Fig.43	P
	5500 MHz	Fig.44	P
	5700 MHz	Fig.45	P

802.11n HT40	5190 MHz	Fig.46	P
	5310 MHz	Fig.47	P
	5510 MHz	Fig.48	P
	5670 MHz	Fig.49	P
802.11ac HT40	5190 MHz	Fig.50	P
	5310 MHz	Fig.51	P
	5510 MHz	Fig.52	P
	5670 MHz	Fig.53	P

802.11ac HT80	5210MHz	Fig.54	P
	5290MHz	Fig.55	P
	5530MHz	Fig.56	P

EUT ID: UT04a

Conclusion: PASS

Test graphs as below:

Full Spectrum

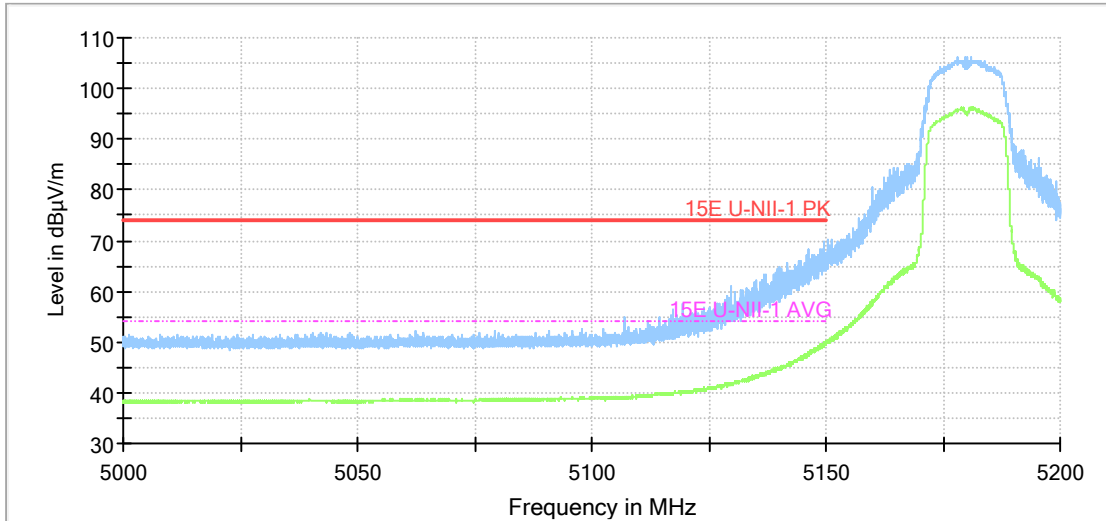

- Preview Result 2-AVG [Preview Result 2.Result:2]
- Preview Result 1-PK+ [Preview Result 1.Result:1]
- * Critical_Freqs AVG [Critical_Freqs.Result:5]
- * Critical_Freqs PK+ [Critical_Freqs.Result:4]
- 15E U-NII-1 PK [..]
- - - 15E U-NII-1 AVG [..]
- ◆ Final_Result PK+ [Final_Result.Result:4]
- ◆ Final_Result AVG [Final_Result.Result:5]

Fig.34 Band Edges (802.11a, 5180MHz)

Full Spectrum

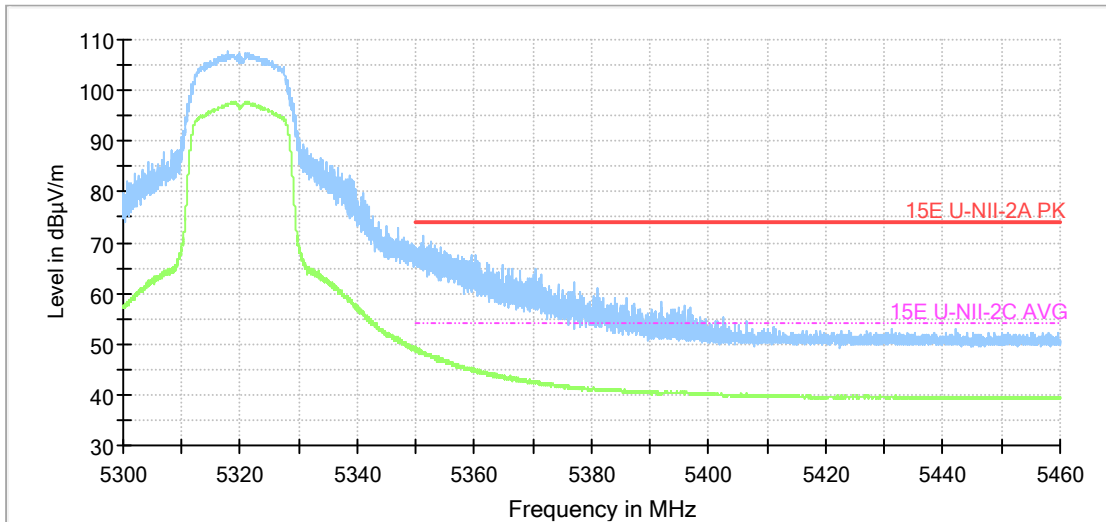

- Preview Result 2-AVG [Preview Result 2.Result:2]
- Preview Result 1-PK+ [Preview Result 1.Result:1]
- * Critical_Freqs AVG [Critical_Freqs.Result:5]
- * Critical_Freqs PK+ [Critical_Freqs.Result:4]
- 15E U-NII-2A PK [..]
- - - 15E U-NII-2C AVG [..]
- ◆ Final_Result PK+ [Final_Result.Result:4]
- ◆ Final_Result AVG [Final_Result.Result:5]

Fig.35 Band Edges (802.11a, 5320MHz)

Full Spectrum

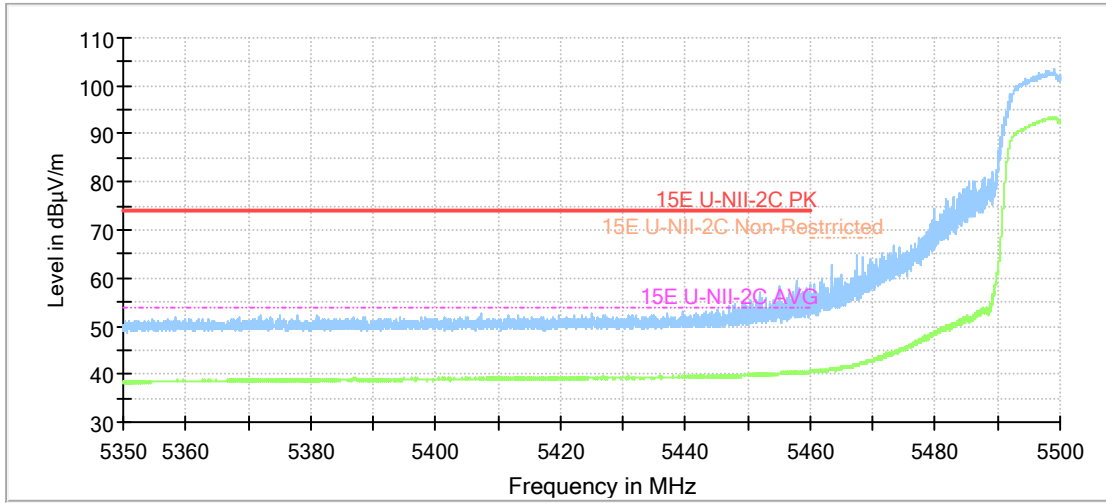

- Preview Result 2-AVG [Preview Result 2.Result:2]
- Preview Result 1-PK+ [Preview Result 1.Result:1]
- * Critical_Freqs AVG [Critical_Freqs.Result:5]
- * Critical_Freqs PK+ [Critical_Freqs.Result:4]
- 15E U-NII-2C PK [..]
- 15E U-NII-2C AVG [..]
- 15E U-NII-2C Non-Restricted [..]
- ◆ Final_Result PK+ [Final_Result.Result:4]
- ◆ Final_Result AVG [Final_Result.Result:5]

Fig.36 Band Edges (802.11a, 5500MHz)

Full Spectrum

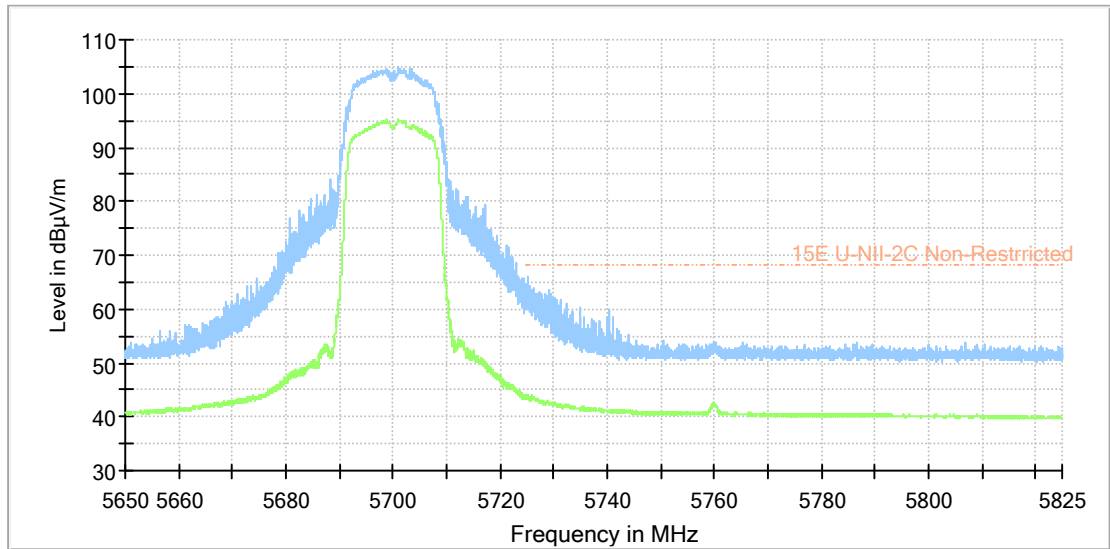

- Preview Result 2-AVG [Preview Result 2.Result:2]
- Preview Result 1-PK+ [Preview Result 1.Result:1]
- * Critical_Freqs AVG [Critical_Freqs.Result:5]
- * Critical_Freqs PK+ [Critical_Freqs.Result:4]
- 15E U-NII-2C Non-Restricted [..]
- ◆ Final_Result PK+ [Final_Result.Result:4]
- ◆ Final_Result AVG [Final_Result.Result:5]

Fig.37 Band Edges (802.11a, 5700MHz)

Full Spectrum

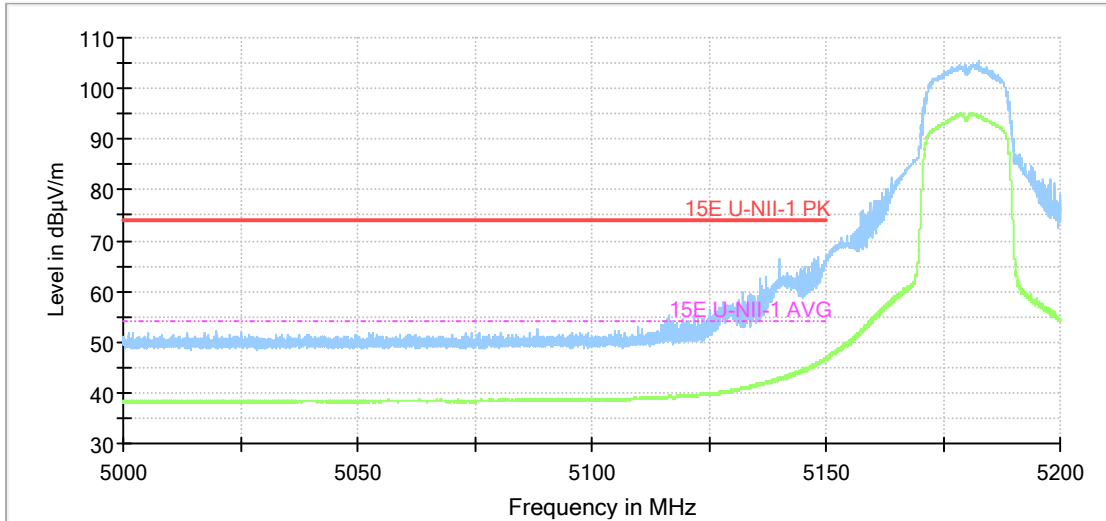

- Preview Result 2-AVG [Preview Result 2.Result:2]
- Preview Result 1-PK+ [Preview Result 1.Result:1]
- * Critical_Freqs AVG [Critical_Freqs.Result:5]
- * Critical_Freqs PK+ [Critical_Freqs.Result:4]
- 15E U-NII-1 PK [..]
- - - 15E U-NII-1 AVG [..]
- ◆ Final_Result PK+ [Final_Result.Result:4]
- ◆ Final_Result AVG [Final_Result.Result:5]

Fig.38 Band Edges (802.11n-HT20, 5180MHz)

Full Spectrum

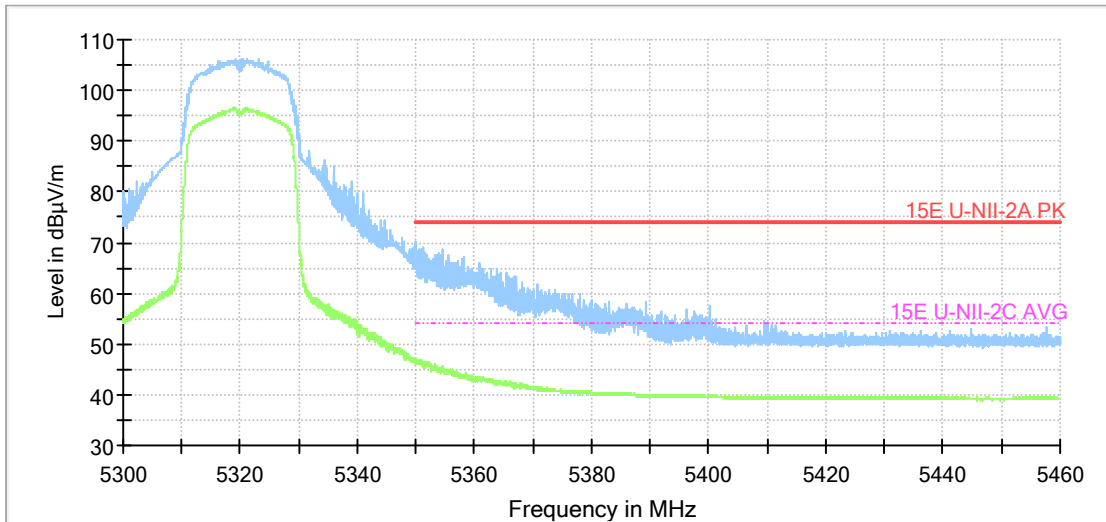

- Preview Result 2-AVG [Preview Result 2.Result:2]
- Preview Result 1-PK+ [Preview Result 1.Result:1]
- * Critical_Freqs AVG [Critical_Freqs.Result:5]
- * Critical_Freqs PK+ [Critical_Freqs.Result:4]
- 15E U-NII-2A PK [..]
- - - 15E U-NII-2C AVG [..]
- ◆ Final_Result PK+ [Final_Result.Result:4]
- ◆ Final_Result AVG [Final_Result.Result:5]

Fig.39 Band Edges (802.11n-HT20, 5320MHz)

Full Spectrum

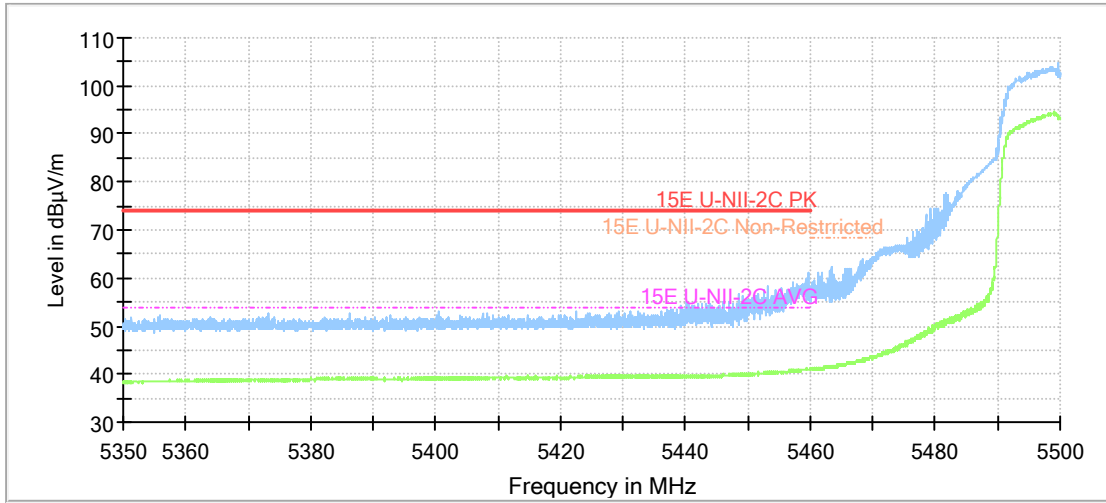

- Preview Result 2-AVG [Preview Result 2.Result:2]
- Preview Result 1-PK+ [Preview Result 1.Result:1]
- * Critical_Freqs AVG [Critical_Freqs.Result:5]
- * Critical_Freqs PK+ [Critical_Freqs.Result:4]
- 15E U-NII-2C PK [..]
- - - 15E U-NII-2C AVG [..]
- - - 15E U-NII-2C Non-Restricted [..]
- ◆ Final_Result PK+ [Final_Result.Result:4]
- ◆ Final_Result AVG [Final_Result.Result:5]

Fig.40 Band Edges (802.11n-HT20, 5500MHz)

Full Spectrum

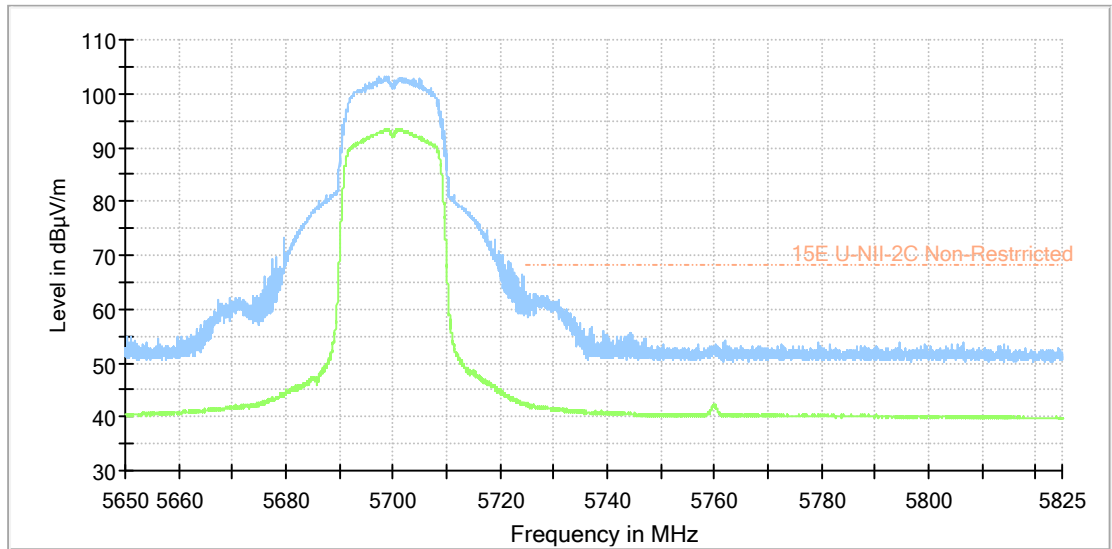

- Preview Result 2-AVG [Preview Result 2.Result:2]
- Preview Result 1-PK+ [Preview Result 1.Result:1]
- * Critical_Freqs AVG [Critical_Freqs.Result:5]
- * Critical_Freqs PK+ [Critical_Freqs.Result:4]
- - - 15E U-NII-2C Non-Restricted [..]
- ◆ Final_Result PK+ [Final_Result.Result:4]
- ◆ Final_Result AVG [Final_Result.Result:5]

Fig.41 Band Edges (802.11n-HT20, 5700MHz)

Full Spectrum

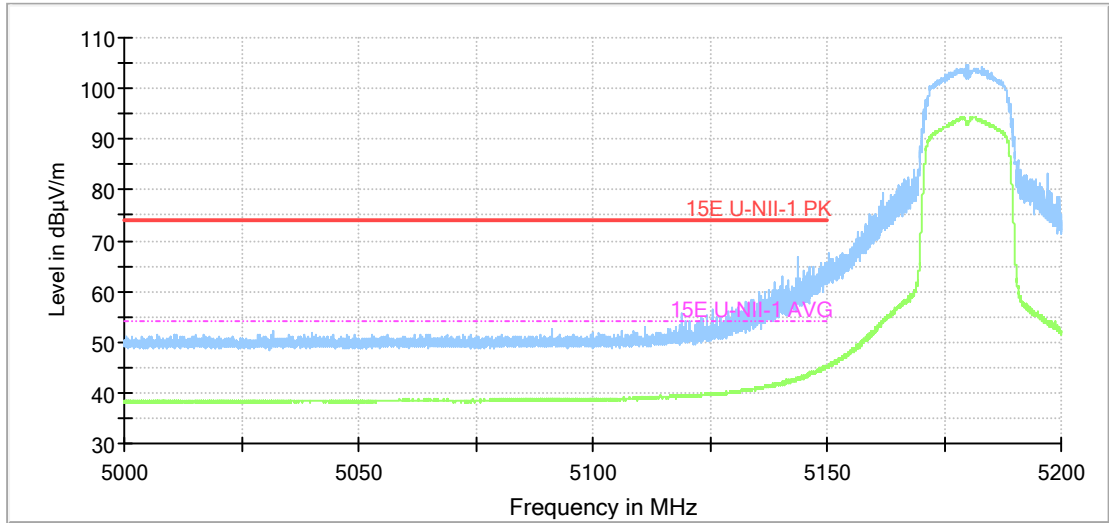

- Preview Result 2-AVG [Preview Result 2.Result:2]
- Preview Result 1-PK+ [Preview Result 1.Result:1]
- * Critical_Freqs AVG [Critical_Freqs.Result:5]
- * Critical_Freqs PK+ [Critical_Freqs.Result:4]
- 15E U-NII-1 PK [..]
- - - 15E U-NII-1 AVG [..]
- ◆ Final_Result PK+ [Final_Result.Result:4]
- ◆ Final_Result AVG [Final_Result.Result:5]

Fig.42 Band Edges (802.11ac-HT20, 5180MHz)

Full Spectrum

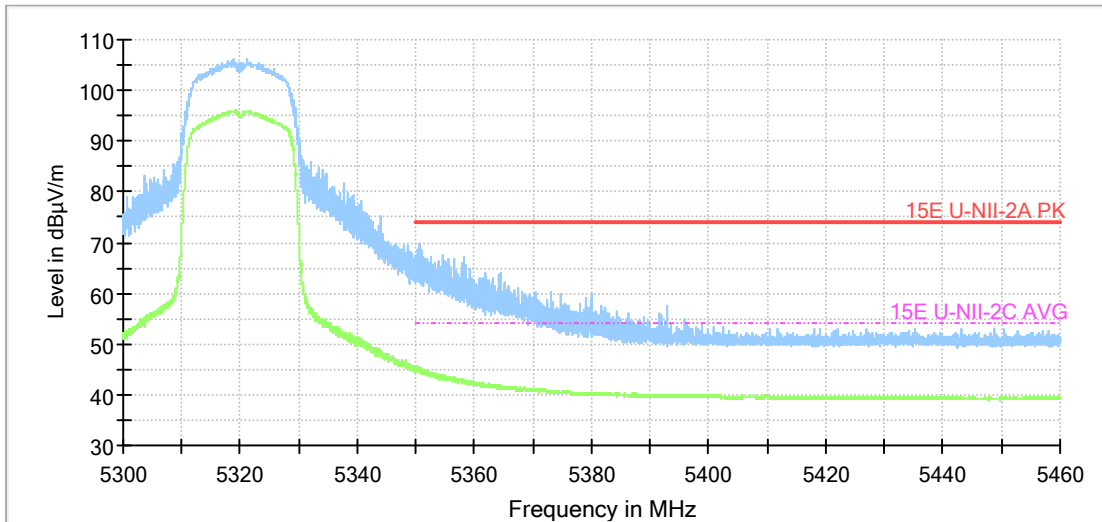

- Preview Result 2-AVG [Preview Result 2.Result:2]
- Preview Result 1-PK+ [Preview Result 1.Result:1]
- * Critical_Freqs AVG [Critical_Freqs.Result:5]
- * Critical_Freqs PK+ [Critical_Freqs.Result:4]
- 15E U-NII-2A PK [..]
- - - 15E U-NII-2C AVG [..]
- ◆ Final_Result PK+ [Final_Result.Result:4]
- ◆ Final_Result AVG [Final_Result.Result:5]

Fig.43 Band Edges (802.11ac-HT20, 5320MHz)

Full Spectrum

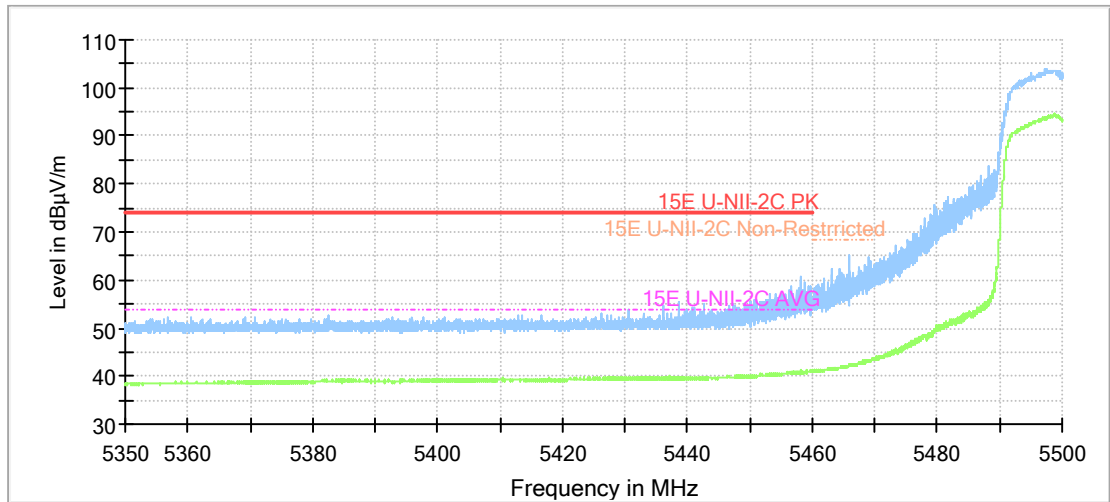

- Preview Result 2-AVG [Preview Result 2.Result:2]
- Preview Result 1-PK+ [Preview Result 1.Result:1]
- * Critical_Freqs AVG [Critical_Freqs.Result:5]
- * Critical_Freqs PK+ [Critical_Freqs.Result:4]
- 15E U-NII-2C PK [..]
- - - 15E U-NII-2C AVG [..]
- - - 15E U-NII-2C Non-Restricted [..]
- ◆ Final_Result PK+ [Final_Result.Result:4]
- ◆ Final_Result AVG [Final_Result.Result:5]

Fig.44 Band Edges (802.11ac-HT20, 5500MHz)

Full Spectrum

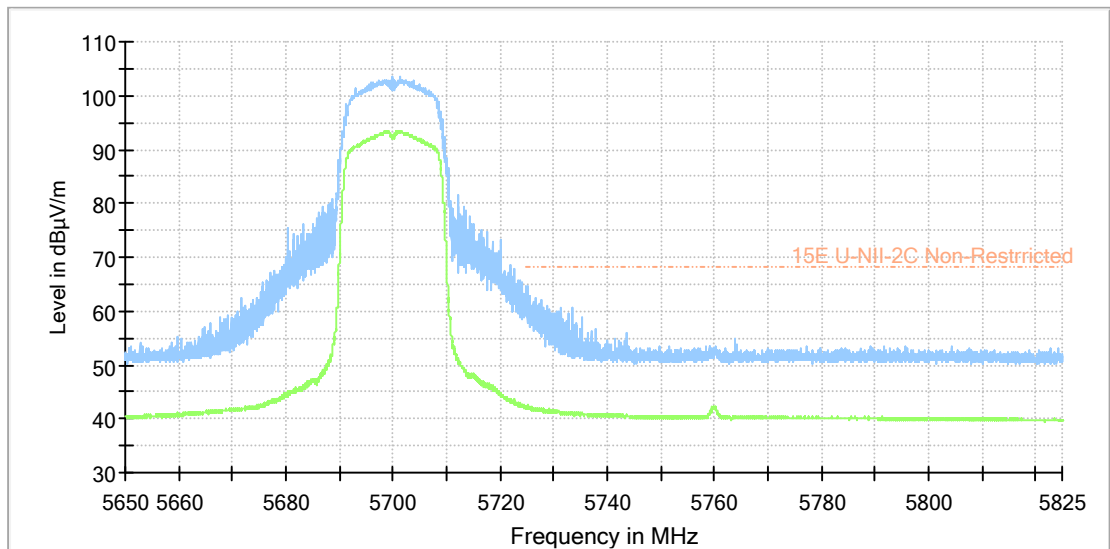

- Preview Result 2-AVG [Preview Result 2.Result:2]
- Preview Result 1-PK+ [Preview Result 1.Result:1]
- * Critical_Freqs AVG [Critical_Freqs.Result:5]
- * Critical_Freqs PK+ [Critical_Freqs.Result:4]
- - - 15E U-NII-2C Non-Restricted [..]
- ◆ Final_Result PK+ [Final_Result.Result:4]
- ◆ Final_Result AVG [Final_Result.Result:5]

Fig.45 Band Edges (802.11ac-HT20, 5700MHz)

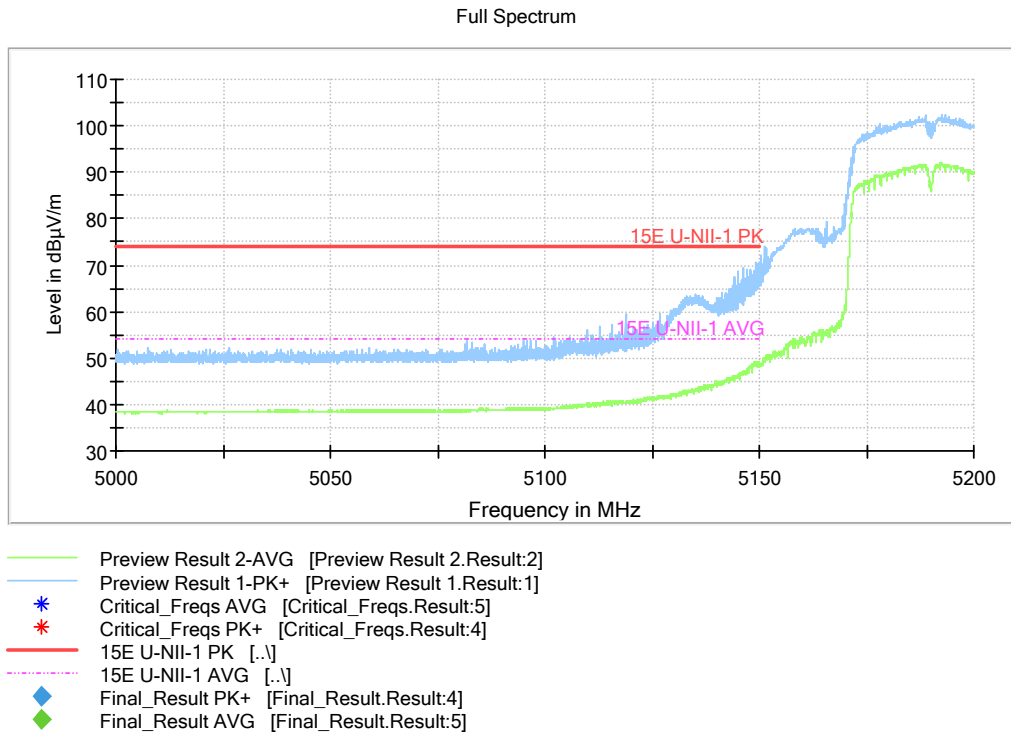

Fig.46 Band Edges (802.11n-HT40, 5190MHz)

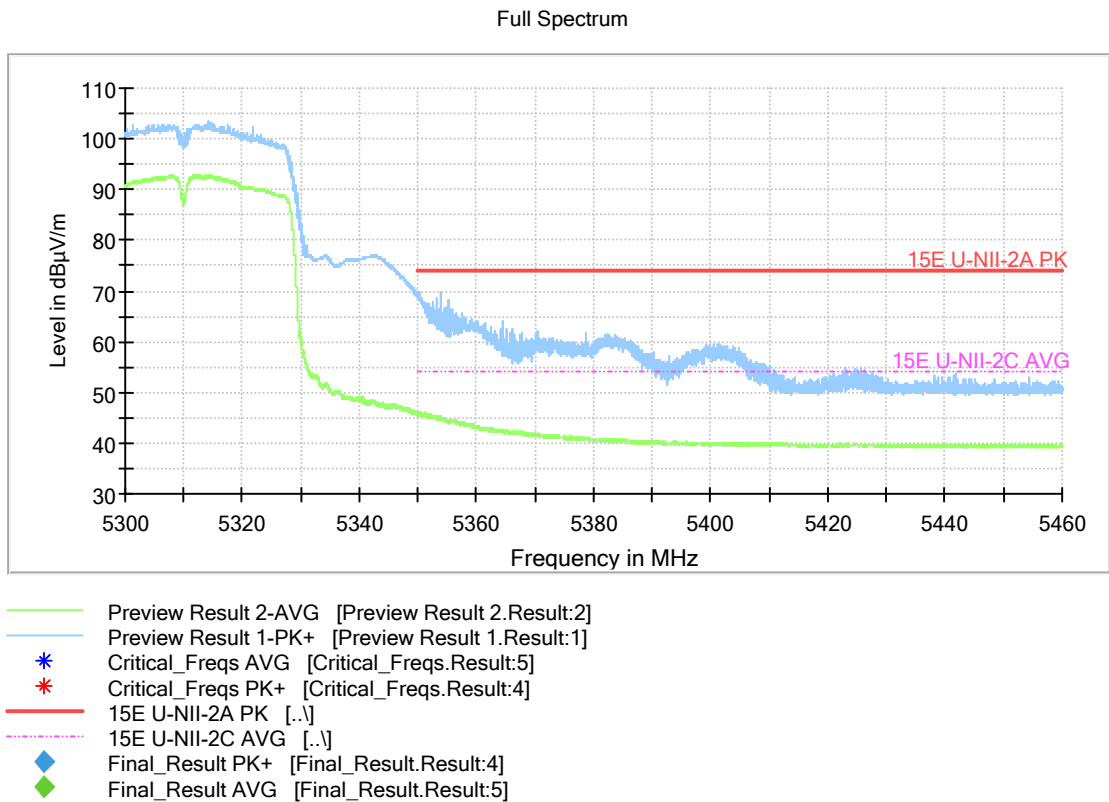
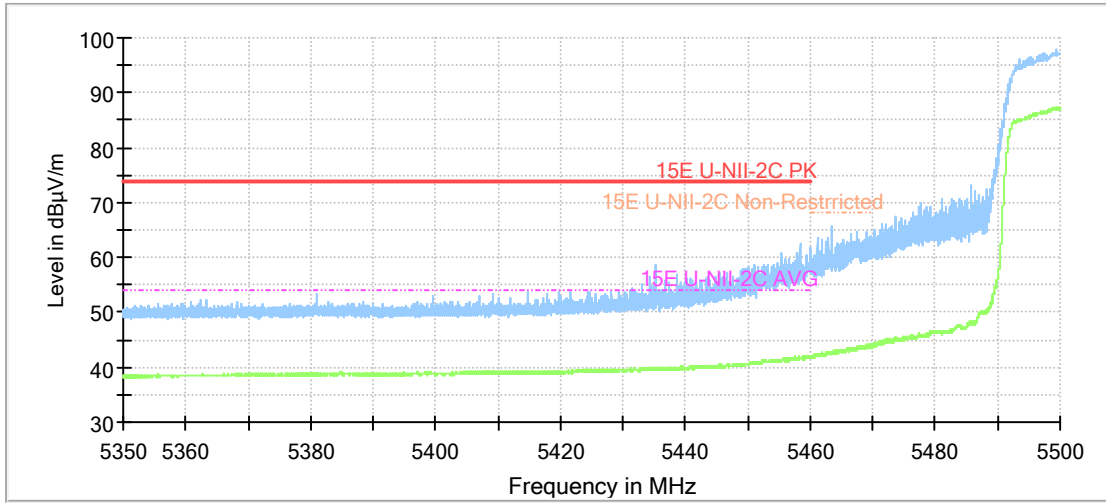

Fig.47 Band Edges (802.11n-HT40, 5310MHz)

Full Spectrum



- Preview Result 2-AVG [Preview Result 2.Result:2]
- Preview Result 1-PK+ [Preview Result 1.Result:1]
- * Critical_Freqs AVG [Critical_Freqs.Result:5]
- * Critical_Freqs PK+ [Critical_Freqs.Result:4]
- 15E U-NII-2C PK [..]
- 15E U-NII-2C AVG [..]
- 15E U-NII-2C Non-Restricted [..]
- ◆ Final_Result PK+ [Final_Result.Result:4]
- ◆ Final_Result AVG [Final_Result.Result:5]

Fig.48 Band Edges (802.11n-HT40, 5510MHz)

Full Spectrum

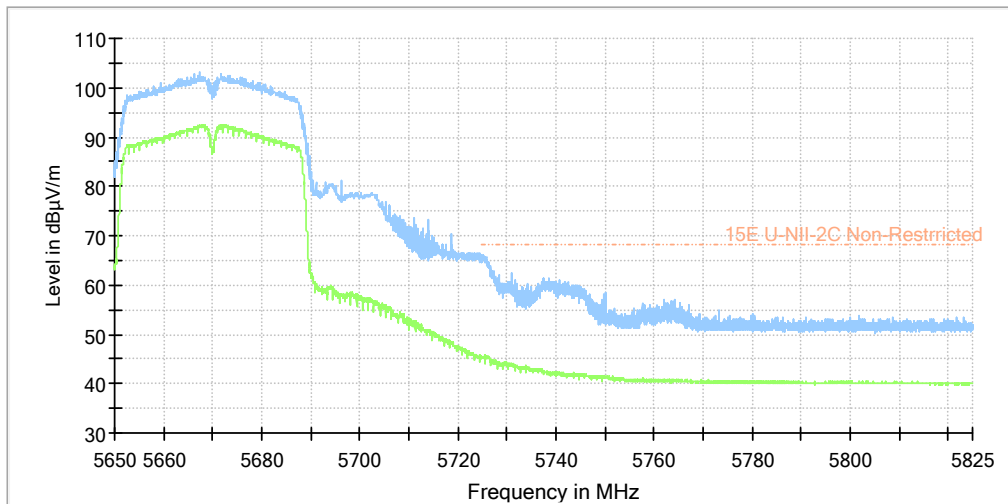

- Preview Result 2-AVG [Preview Result 2.Result:2]
- Preview Result 1-PK+ [Preview Result 1.Result:1]
- * Critical_Freqs AVG [Critical_Freqs.Result:5]
- * Critical_Freqs PK+ [Critical_Freqs.Result:4]
- 15E U-NII-2C Non-Restricted [..]
- ◆ Final_Result PK+ [Final_Result.Result:4]
- ◆ Final_Result AVG [Final_Result.Result:5]

Fig.49 Band Edges (802.11n-HT40, 5670MHz)

Full Spectrum

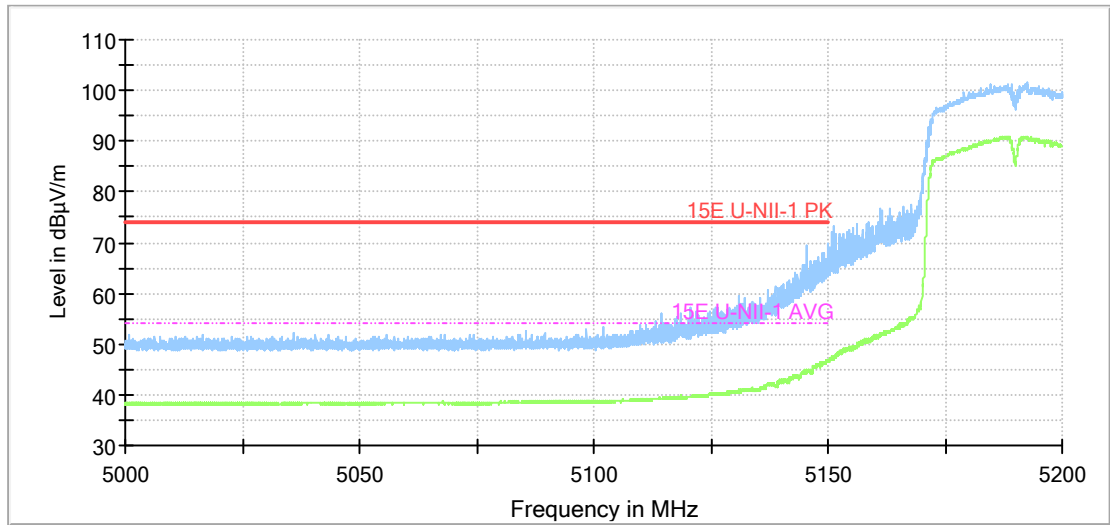

- Preview Result 2-AVG [Preview Result 2.Result:2]
- Preview Result 1-PK+ [Preview Result 1.Result:1]
- * Critical_Freqs AVG [Critical_Freqs.Result:5]
- * Critical_Freqs PK+ [Critical_Freqs.Result:4]
- 15E U-NII-1 PK [..]
- - - 15E U-NII-1 AVG [..]
- ◆ Final_Result PK+ [Final_Result.Result:4]
- ◆ Final_Result AVG [Final_Result.Result:5]

Fig.50 Band Edges (802.11ac-HT40, 5190MHz)

Full Spectrum

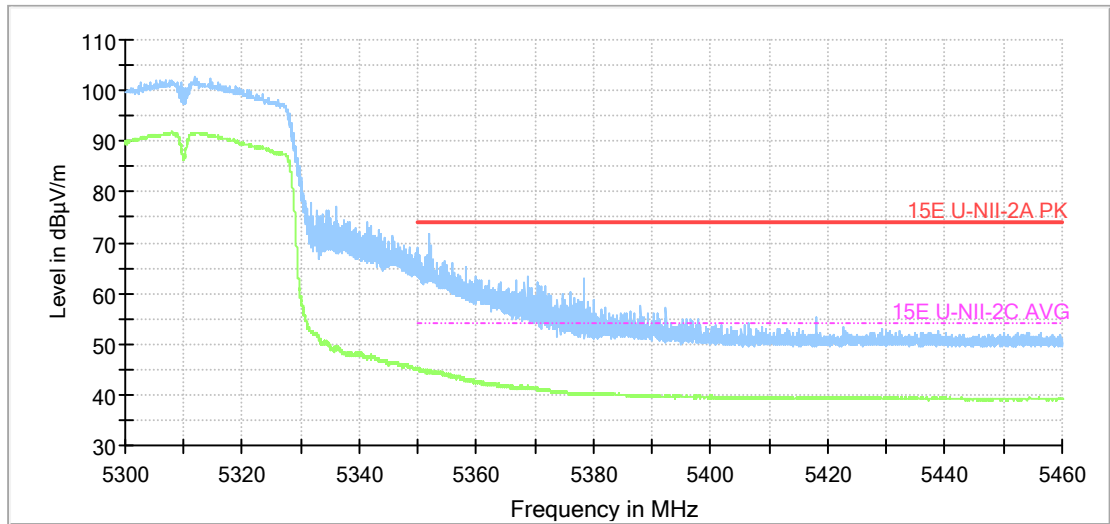

- Preview Result 2-AVG [Preview Result 2.Result:2]
- Preview Result 1-PK+ [Preview Result 1.Result:1]
- * Critical_Freqs AVG [Critical_Freqs.Result:5]
- * Critical_Freqs PK+ [Critical_Freqs.Result:4]
- 15E U-NII-2A PK [..]
- - - 15E U-NII-2C AVG [..]
- ◆ Final_Result PK+ [Final_Result.Result:4]
- ◆ Final_Result AVG [Final_Result.Result:5]

Fig.51 Band Edges (802.11ac-HT40, 5310MHz)

Full Spectrum

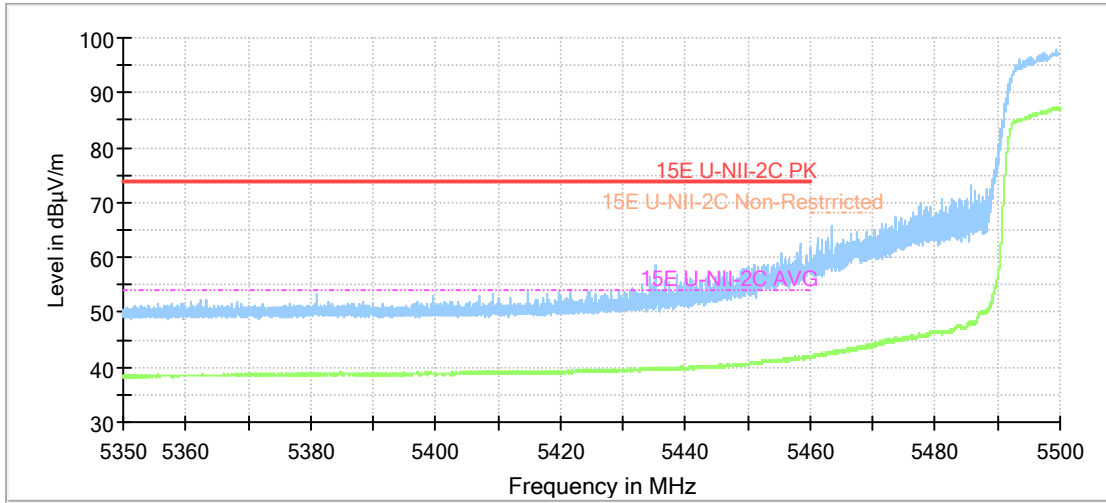

- Preview Result 2-AVG [Preview Result 2.Result:2]
- Preview Result 1-PK+ [Preview Result 1.Result:1]
- * Critical_Freqs AVG [Critical_Freqs.Result:5]
- * Critical_Freqs PK+ [Critical_Freqs.Result:4]
- 15E U-NII-2C PK [..]
- 15E U-NII-2C AVG [..]
- 15E U-NII-2C Non-Restricted [..]
- ◆ Final_Result PK+ [Final_Result.Result:4]
- ◆ Final_Result AVG [Final_Result.Result:5]

Fig.52 Band Edges (802.11ac-HT40, 5510MHz)

Full Spectrum

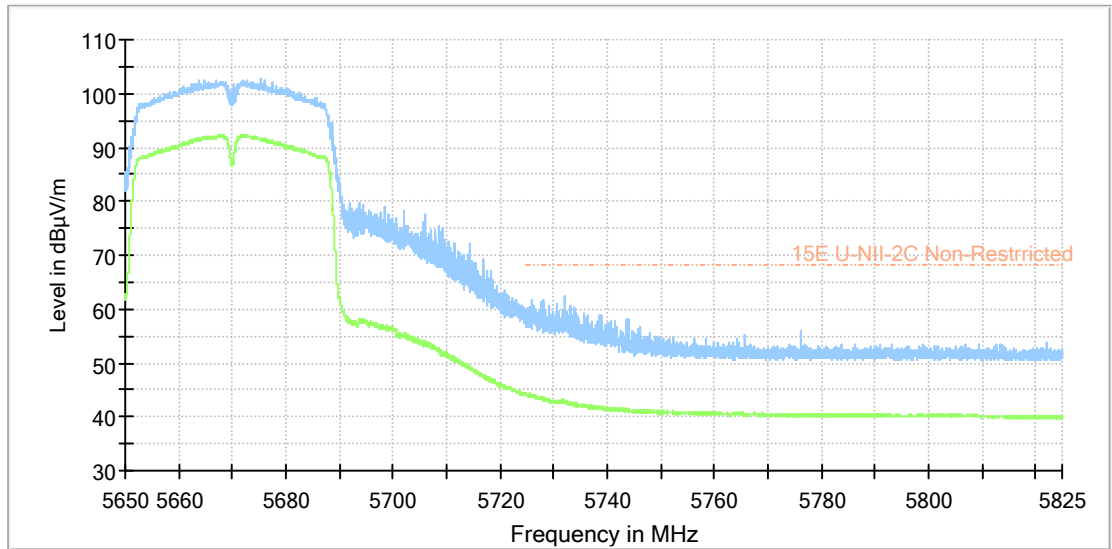

- Preview Result 2-AVG [Preview Result 2.Result:2]
- Preview Result 1-PK+ [Preview Result 1.Result:1]
- * Critical_Freqs AVG [Critical_Freqs.Result:5]
- * Critical_Freqs PK+ [Critical_Freqs.Result:4]
- 15E U-NII-2C Non-Restricted [..]
- ◆ Final_Result PK+ [Final_Result.Result:4]
- ◆ Final_Result AVG [Final_Result.Result:5]

Fig.53 Band Edges (802.11ac-HT40, 5670MHz)

Full Spectrum

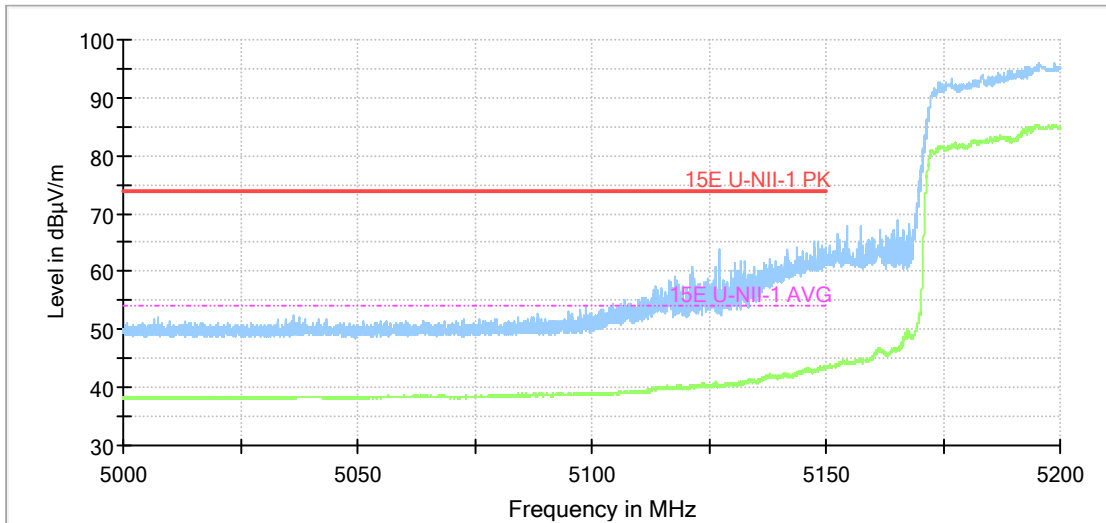

- Preview Result 2-AVG [Preview Result 2.Result:2]
- Preview Result 1-PK+ [Preview Result 1.Result:1]
- * Critical_Freqs AVG [Critical_Freqs.Result:5]
- * Critical_Freqs PK+ [Critical_Freqs.Result:4]
- 15E U-NII-1 PK [..]
- - - 15E U-NII-1 AVG [..]
- ◆ Final_Result PK+ [Final_Result.Result:4]
- ◆ Final_Result AVG [Final_Result.Result:5]

Fig.54 Band Edges (802.11ac-HT80, 5210MHz)

Full Spectrum

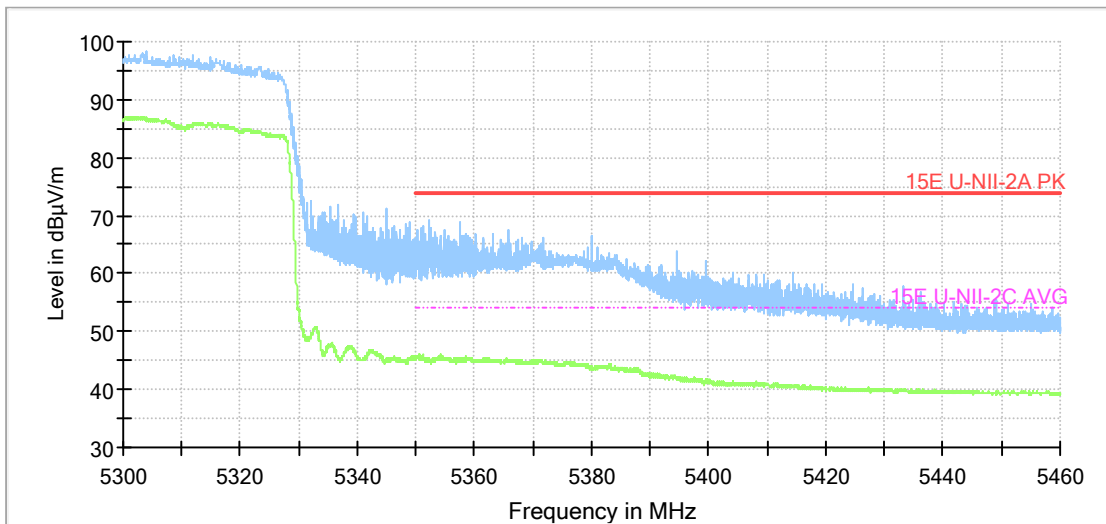

- Preview Result 2-AVG [Preview Result 2.Result:2]
- Preview Result 1-PK+ [Preview Result 1.Result:1]
- * Critical_Freqs AVG [Critical_Freqs.Result:5]
- * Critical_Freqs PK+ [Critical_Freqs.Result:4]
- 15E U-NII-2A PK [..]
- - - 15E U-NII-2C AVG [..]
- ◆ Final_Result PK+ [Final_Result.Result:4]
- ◆ Final_Result AVG [Final_Result.Result:5]

Fig.55 Band Edges (802.11ac-HT80, 5290MHz)

Full Spectrum

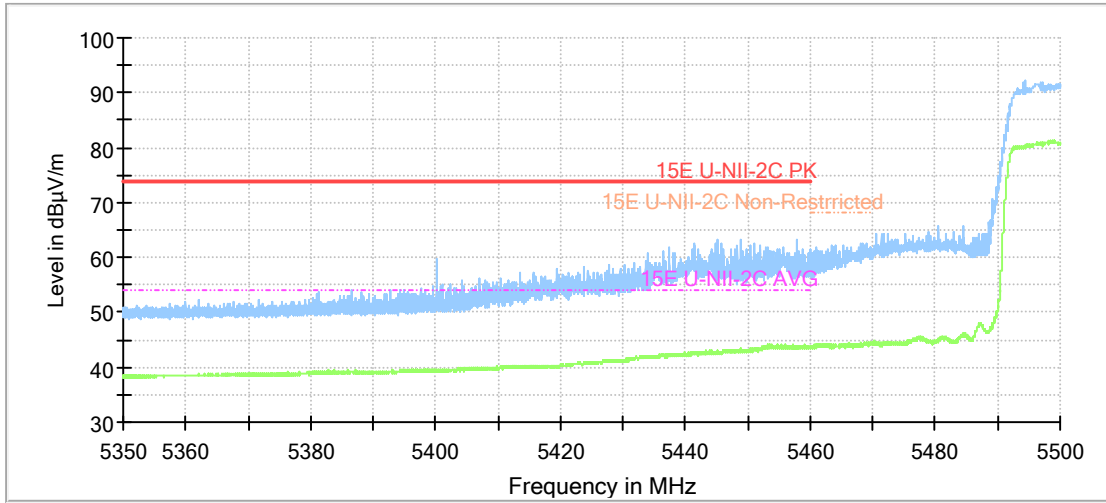

- Preview Result 2-AVG [Preview Result 2.Result:2]
- Preview Result 1-PK+ [Preview Result 1.Result:1]
- * Critical_Freqs AVG [Critical_Freqs.Result:5]
- * Critical_Freqs PK+ [Critical_Freqs.Result:4]
- 15E U-NII-2C PK [.]
- - - 15E U-NII-2C AVG [.]
- - - 15E U-NII-2C Non-Restricted [.]
- ◆ Final_Result PK+ [Final_Result.Result:4]
- ◆ Final_Result AVG [Final_Result.Result:5]

Fig.56 Band Edges (802.11ac-HT80, 5530MHz)

A.6. Transmitter Spurious Emission

Method of Measurement: See ANSI C63.10-2013-clause 6.4 & 6.5 & 6.6

Measurement Limit:

Standard	Limit
FCC 47 CFR Part 15.247, 15.205, 15.209	20dB below peak output power

radiated emissions which fall in the restricted bands, as defined in § 15.205(a), must also comply with the radiated emission limits specified in § 15.209(a) (see § 15.205(c)).

Limit in restricted band:

Frequency (MHz)	Field strength(μ V/m)	Measurement distance (m)
0.009 - 0.490	2400/F(kHz)	300
0.490 - 1.705	24000/F(kHz)	30
1.705 – 30.0	30	30

Frequency of emission (MHz)	Field strength(uV/m)	Field strength(dBuV/m)
30-88	100	40
88-216	150	43.5
216-960	200	46
Above 960	500	54

Set up:

Tabletop devices shall be placed on a nonconducting platform with nominal top surface dimensions 1 m by 1.5 m. For emissions testing at or below 1 GHz, the table height shall be 80 cm above the reference ground plane. For emission measurements above 1 GHz, the table height shall be 1.5 m

The EUT and transmitting antenna shall be centered on the turntable.

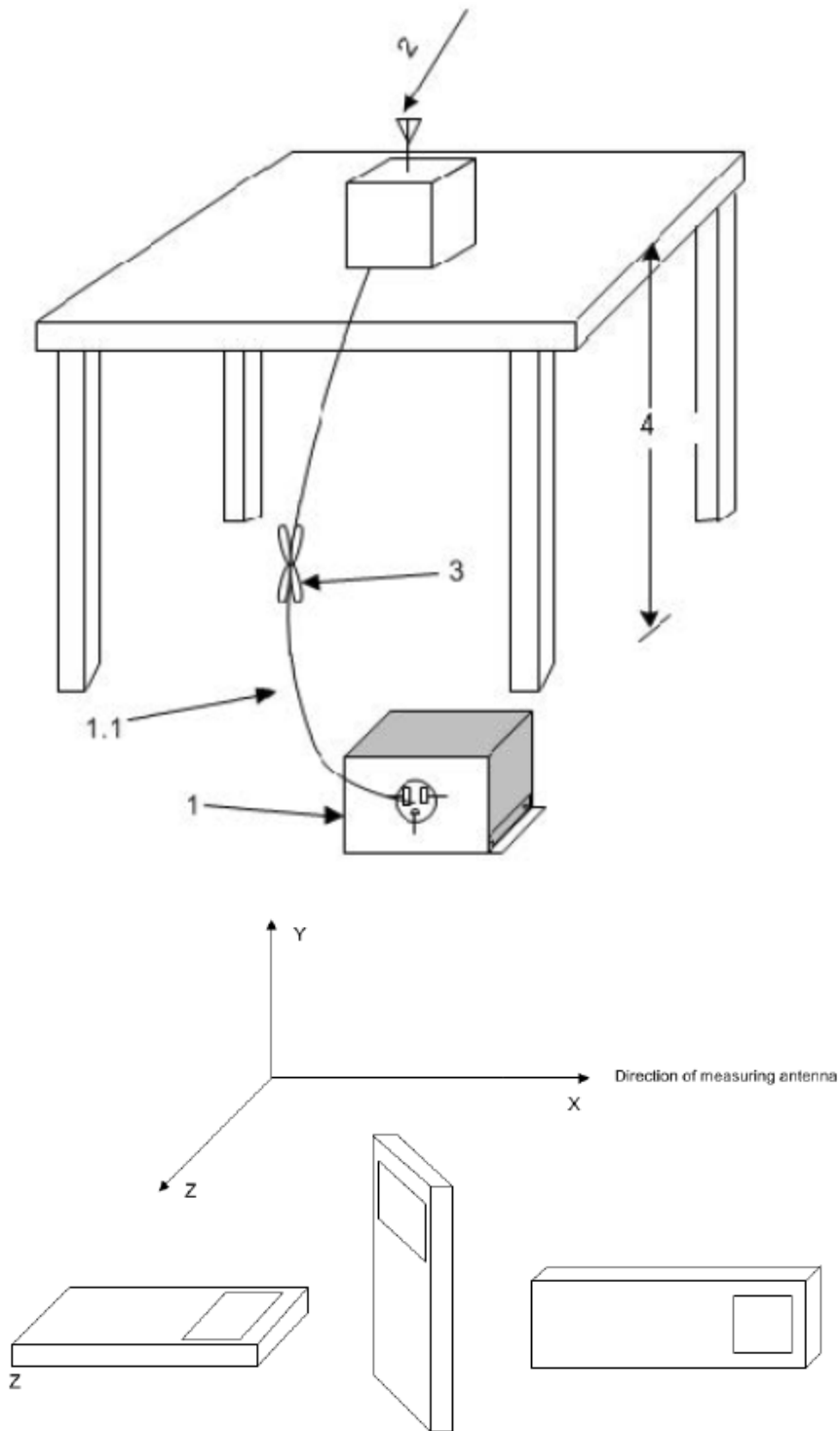

Test Condition

The EUT shall be tested 1 near top, 1 near middle, and 1 near bottom. Set the unlicensed wireless device to operate in continuous transmit mode. For unlicensed wireless devices unable to be configured for 100% duty cycle even in test mode, configure the system for the maximum duty cycle supported.

When required for unlicensed wireless devices, measurements of the variation of the input power or the radiated signal level of the fundamental frequency component of the emission, as

appropriate, shall be performed with the supply voltage varied between 85% and 115% of the nominal rated supply voltage.

Exploratory radiated emissions measurements

Exploratory radiated measurements shall be performed at the measurement distance or at a closer distance than that specified for compliance to determine the emission characteristics of the EUT and, if applicable, the EUT configuration that produces the maximum level of emissions. The frequencies of maximum emission may be determined by manually positioning the antenna close to the EUT, and then moving the antenna over all sides of the EUT while observing a spectral display. It is advantageous to have prior knowledge of the frequencies of emissions, although this may be determined from such a near-field scan. The near-field scan shall only be used to determine the frequency but not the amplitude of the emissions. Where exploratory measurements are not adequate to determine the worst-case operating modes and are used only to identify the frequencies of the highest emissions, additional preliminary tests can be required.

For emissions from the EUT, the maximum level shall be determined by rotating the EUT and its antenna through 0° to 360°. For each mode of operation required to be tested, the frequency spectrum (based on findings from exploratory measurements) shall be monitored.

Broadband antennas and a spectrum analyzer or a radio-noise meter with a panoramic display are often useful in this type of test. If either antenna height or EUT azimuth are not fully measured during exploratory testing, then complete testing can be required at the OATS or semi-anechoic chamber when the final full spectrum testing is performed.

Final radiated emissions measurements

The final measurements are using the orientation and equipment arrangement of the EUT based on the measurement results found during the preliminary (exploratory) measurements, the EUT arrangement, appropriate modulation, and modes of operation that produce the emissions that have the highest amplitude relative to the limit shall be selected for the final measurement.

For each mode of operation required to be tested, the frequency spectrum (based on findings from exploratory measurements) shall be monitored. The highest signal levels relative to the limit shall be determined by rotating the EUT from 0° to 360° and with varying the measurement antenna height between 1 m and 4 m in vertical and horizontal polarizations.

For each mode selected, record the frequency and amplitude of the highest fundamental emission (if applicable), as well as the frequency and amplitude of the six highest spurious emissions relative to the limit. Emissions more than 20 dB below the limit do not need to be reported.

This maximization process was repeated with the EUT positioned in each of its three orthogonal orientations.

The receiver references:

Frequency of emission (MHz)	RBW/VBW	Sweep Time(s)
30-1000	100KHz/300KHz	5
1000-4000	1MHz/3MHz	15
4000-18000	1MHz/3MHz	40
18000-26500	1MHz/3MHz	20