

# HAC TEST REPORT

ISSUED BY  
Shenzhen BALUN Technology Co., Ltd.



FOR  
**Mobile Phone**

ISSUED TO  
vivo Mobile Communication Co., Ltd.

No.168 Jinghai East Rd., Chang'an, Dongguan, Guangdong, China

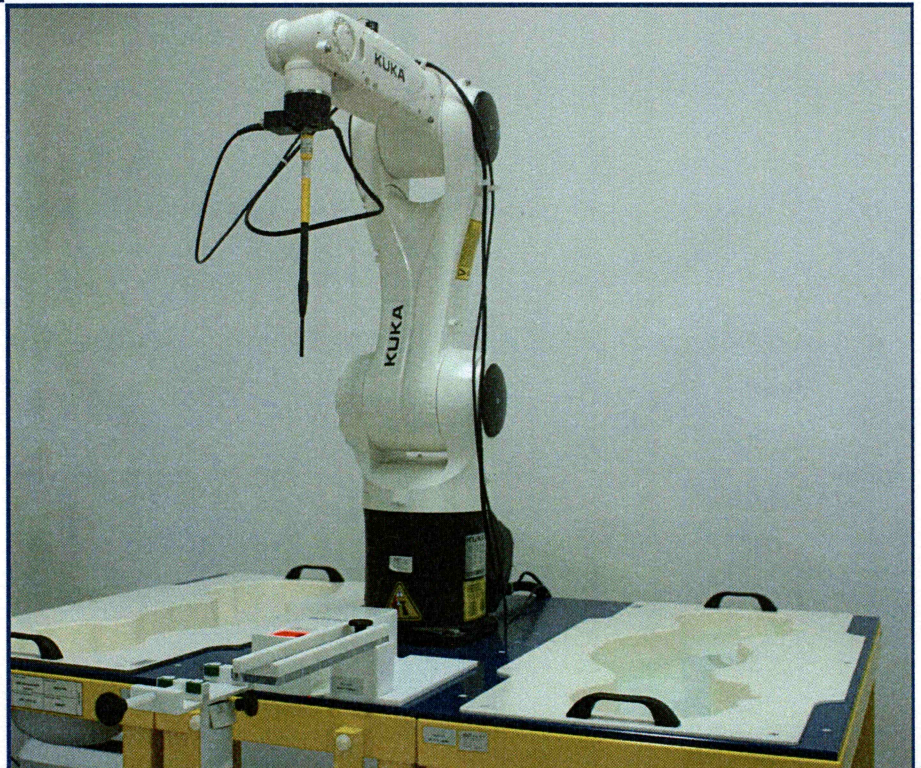

Tested by: Zhang Jiwei  
Zhang Jiwei  
Date: Jun. 23, 2021

Approved by: Wei Yanquan  
Wei Yanquan  
(Chief Engineer)  
Date: Jun. 23, 2021

Report No: BL-SZ2150617-702  
EUT Name: Mobile Phone  
Model Name: V2058  
Brand Name: vivo  
FCC ID: 2AUCY-V2058  
Test Standard: 47 CFR Part 20.19  
ANSI C63.19-2011  
M-Rating: E-Field: M4  
Test Conclusion: Pass  
Test Date: May 28, 2021 ~ Jun. 01, 2021  
Date of Issue: Jun. 23, 2021

**NOTE:** This test report of test results only related to testing samples, which can be duplicated completely for the legal use with the approval of the applicant; it shall not be reproduced except in full, without the written approval of Shenzhen BALUN Technology Co., Ltd. Any objections should be raised within thirty days from the date of issue. To validate the report, please contact us.

**Revision History**

<u>Version</u>	<u>Issue Date</u>	<u>Revisions Content</u>
<u>Rev. 01</u>	<u>Jun. 22, 2021</u>	<u>Initial Issue</u>
<u>Rev. 02</u>	<u>Jun. 23, 2021</u>	<u>Remove the test setup photos</u>

**TABLE OF CONTENTS**

1 GENERAL INFORMATION ..... 4

1.1 Identification of the Testing Laboratory ..... 4

1.2 Identification of the Responsible Testing Location ..... 4

1.3 Test Environment Condition ..... 4

1.4 Announce ..... 4

2 PRODUCT INFORMATION ..... 5

2.1 Applicant Information ..... 5

2.2 Manufacturer Information ..... 5

2.3 Factory Information ..... 5

2.4 General Description for Equipment under Test (EUT) ..... 5

2.5 Ancillary Equipment ..... 5

2.6 Technical Information ..... 6

2.7 EUT Air Interface description ..... 8

3 SUMMARY OF TEST RESULTS ..... 9

3.1 Test Standards ..... 9

3.2 HAC Test Configuration and Setting ..... 9

3.3 Summary Of HAC M-Rating ..... 10

3.4 ANSI C63.19 HAC RF Categories ..... 11

3.5 HAC Test Uncertainty ..... 12

4 SATIMO HSC MEASUREMENT SYSTEM ..... 13

4.1 Definition of Hearing Aid Compatibility (HAC) ..... 13

4.2 SATIMO HAC System ..... 14

5 SYSTEM VERIFICATION ..... 20

5.1 System Check Procedure ..... 20

5.2 Validation Procedure ..... 20

5.3 System Validation Setup ..... 21

5.4	System Validation Results.....	21
6	Modulation Interference Factor (MIF) .....	22
7	HAC RF IMMUNITY MEASUREMENT PROCEDURES .....	23
7.1	HAC Measurement Process Diagram .....	23
7.2	HAC RF Test Setup.....	24
7.3	RF Emission Measurement Procedure .....	24
8	CONDUCTED RF OUPUT POWER.....	25
8.1	GSM .....	25
8.2	WCDMA .....	27
8.3	LTE.....	29
8.4	WIFI.....	75
8.5	Bluetooth .....	78
9	LOW-POWER EXEMPTION.....	79
9.1	Tune-up Power .....	79
10	HAC RF Emission Test Results.....	81
10.1	E-Filled Emission Test Results.....	81
11	TEST EQUIPMENTS LIST .....	82
12	REFERENCES .....	83
ANNEX A	HAC TEST RESULT OF SYSTEM VERIFICAION.....	84
ANNEX B	HAC RF MEASUREMENT RESULT .....	87
ANNEX C	TEST SETUP PHOTO .....	115
ANNEX D	EUT EXTERNAL PHOTO .....	115
ANNEX E	CALIBRATION REPORT .....	115

# 1 GENERAL INFORMATION

## 1.1 Identification of the Testing Laboratory

Company Name	Shenzhen BALUN Technology Co., Ltd.
Address	Block B, 1st FL, Baisha Science and Technology Park, Shahe Xi Road, Nanshan District, Shenzhen, Guangdong Province, P. R. China
Phone Number	+86 755 6685 0100
Fax Number	+86 755 6182 4271

## 1.2 Identification of the Responsible Testing Location

Test Location	Shenzhen BALUN Technology Co., Ltd.
Address	Block B, 1st FL, Baisha Science and Technology Park, Shahe Xi Road, Nanshan District, Shenzhen, Guangdong Province, P. R. China
Description	All measurement facilities used to collect the measurement data are located at Block B, FL 1, Baisha Science and Technology Park, Shahe Xi Road, Nanshan District, Shenzhen, Guangdong Province, P. R. China 518055

## 1.3 Test Environment Condition

Ambient Temperature	20°C to 23°C
Ambient Relative Humidity	35% to 51%
Ambient Pressure	100 KPa to 102 KPa

## 1.4 Announce

- (1) The test report reference to the report template version v1.1.
- (2) The test report is invalid if not marked with the signatures of the persons responsible for preparing and approving the test report.
- (3) The test report is invalid if there is any evidence and/or falsification.
- (4) The results documented in this report apply only to the tested sample, under the conditions and modes of operation as described herein.
- (5) This document may not be altered or revised in any way unless done so by BALUN and all revisions are duly noted in the revisions section.
- (6) Content of the test report, in part or in full, cannot be used for publicity and/or promotional purposes without prior written approval from the laboratory.
- (7) The laboratory is only responsible for the data released by the laboratory, except for the part provided by the applicant.

## 2 PRODUCT INFORMATION

### 2.1 Applicant Information

Applicant	vivo Mobile Communication Co., Ltd.
Address	No.168 Jinghai East Rd., Chang'an, Dongguan, Guangdong, China

### 2.2 Manufacturer Information

Manufacturer	vivo Mobile Communication Co., Ltd.
Address	No.168 Jinghai East Rd., Chang'an, Dongguan, Guangdong, China

### 2.3 Factory Information

Factory	N/A
Address	N/A

### 2.4 General Description for Equipment under Test (EUT)

EUT Name	Mobile Phone
Model Name Under Test	V2058
Series Model Name	N/A
Description of Model name differentiation	N/A
Hardware Version	MP_0.1
Software Version	PD2103BF_EX_A_3.6.4
Dimensions (Approx.)	163.96*75.3*8.495mm
Weight (Approx.)	193g

### 2.5 Ancillary Equipment

Ancillary Equipment 1	Battery	
	Brand Name	vivo
	Model No.	B-Q8
	Serial No.	N/A
	Capacity	Rated capacity: 4880 mAh/18.88Wh Typical capacity: 5000 mAh/19.35Wh
	Rated Voltage	3.87 V
Ancillary Equipment 2	Limit Charge Voltage	4.45 V
	Headset	
	Model No.	XE160
	Length (Approx.)	1.0 m

## 2.6 Technical Information

Network and Wireless connectivity	2G Network GSM/GPRS/EGPRS 850/1900 MHz 3G Network WCDMA/HSDPA/HSUPA Band 2/4/5 4G Network FDD LTE Band 2/4/5/7/12/17/66 TDD LTE Band 38/41 LTE CA Uplink (UL): CA_7C, CA_38C, CA_41C Bluetooth (BR+EDR+BLE) 2.4G WIFI 802.11b, 802.11g, 802.11n(HT20) 5G WIFI 802.11a, 802.11n(HT20/40), 802.11ac(VHT20/40/80) U-NII-1/2A/2C/3 GPS, GLONASS, BDS, Galileo, FM receiver
Note : The EUT is a mobile phone, which supports dual SIM card under the same transceiver. Each SIM supports GSM, WCDMA and LTE, and both SIM share the same transmitting electro circuit, NV parameters, so only SIM1 was tested in this report.	

The requirement for the following technical information of the EUT was tested in this report:

Operating Mode	GSM, WCDMA, LTE, WLAN, Bluetooth		
Frequency Range	GSM 850	TX: 824 ~ 849 MHz	RX: 869 ~ 894 MHz
	GSM 1900	TX: 1850 ~ 1910 MHz	RX: 1930 ~ 1990 MHz
	WCDMA Band 2	TX: 1850 ~ 1910 MHz	RX: 1930 ~ 1990 MHz
	WCDMA Band 4	TX: 1710 ~ 1755 MHz	RX: 2110 ~ 2155 MHz
	WCDMA Band 5	TX: 824 ~ 849 MHz	RX: 869 ~ 894 MHz
	LTE Band 2	TX: 1850 ~ 1910 MHz	RX: 1930 ~ 1990 MHz
	LTE Band 4	TX: 1710 ~ 1755 MHz	RX: 2110 ~ 2155 MHz
	LTE Band 5	TX: 824 ~ 849 MHz	RX: 869 ~ 894 MHz
	LTE Band 7	TX: 2500 ~ 2570 MHz	RX: 2620 ~ 2690 MHz
	LTE Band 12	TX: 699 ~ 716 MHz	RX: 729 ~ 746 MHz
	LTE Band 17	TX: 704 ~ 716 MHz	RX: 734 ~ 746 MHz
	LTE Band 38	TX: 2570 ~ 2620 MHz	RX: 2570 ~ 2620 MHz
	LTE Band 41	TX: 2496 ~ 2690 MHz	RX: 2496 ~ 2690 MHz
	LTE Band 66	TX: 1710 ~ 1780 MHz	RX: 2110 ~ 2180 MHz
	802.11b/g	2412 ~ 2462 MHz	
	802.11n(HT20)	2412 ~ 2462 MHz	
	802.11a	5150 ~ 5250 MHz	
		5250 ~ 5350 MHz	
		5470 ~ 5725 MHz	
		5725 ~ 5850 MHz	
	802.11n(HT20/HT40)	5150 ~ 5250 MHz	
		5250 ~ 5350 MHz	
		5470 ~ 5725 MHz	
802.11ac(VHT20/VHT40/VHT80)	5150 ~ 5250 MHz		
	5250 ~ 5350 MHz		
	5470 ~ 5725 MHz		
	5725 ~ 5850 MHz		

	Bluetooth	2402 ~ 2480 MHz
Antenna Type	WWAN: PIFA Antenna WLAN: PIFA Antenna Bluetooth: PIFA Antenna	
DTM	Not Support	
Hotspot Function	Support	
Power Reduction	Support	
Exposure Category	General Population/Uncontrolled exposure	
EUT Stage	Portable Device	
Product	Type	
	<input checked="" type="checkbox"/> Production unit	<input type="checkbox"/> Identical prototype
Note: 1. The device utilizes independent power reduction mechanisms for SAR compliance for the 2/3/4G transmitter for held-to-ear exposure conditions. 2. The device utilizes independent power reduction mechanisms for SAR compliance for the 2/3/4G transmitter for near to body exposure conditions.		

## 2.7 EUT Air Interface description

Air Interface	Band	Type	C63.19 Tested	Simultaneous Transmitter	OTT	Power Reduction
GSM	850	VO	Yes	Bluetooth/WLAN	NA	Not Support
	1900	VO	Yes	Bluetooth/WLAN	NA	Not Support
	GPRS/EDGE	DT	No	Bluetooth/WLAN	Yes	Not Support
WCDMA	Band 2	VO	No	Bluetooth/WLAN	NA	Not Support
	Band 4	VO	No	Bluetooth/WLAN	NA	Not Support
	Band 5	VO	No	Bluetooth/WLAN	NA	Not Support
	HSUPA/HSDPA	VD	No	Bluetooth/WLAN	Yes	Not Support
LTE	Band 2	VD	No	Bluetooth/WLAN	Yes	Not Support
	Band 4	VD	No	Bluetooth/WLAN	Yes	Not Support
	Band 5	VD	No	Bluetooth/WLAN	Yes	Not Support
	Band 7	VD	No	Bluetooth/WLAN	Yes	Not Support
	Band 12	VD	No	Bluetooth/WLAN	Yes	Not Support
	Band 17	VD	No	Bluetooth/WLAN	Yes	Not Support
	Band 66	VD	No	Bluetooth/WLAN	Yes	Not Support
	Band 38	VD	No	Bluetooth/WLAN	Yes	Not Support
	Band 41	VD	Yes	Bluetooth/WLAN	Yes	Not Support
2.4G WLAN	2412~2462 MHz	DT	No	WWAN	Yes	Not Support
5G WLAN	5150~5250 MHz	DT	No	WWAN	Yes	Not Support
	5250~5350 MHz	DT	No	WWAN	Yes	Not Support
	5470~5725 MHz	DT	No	WWAN	Yes	Not Support
	5725~5850 MHz	DT	No	WWAN	Yes	Not Support
Bluetooth	2402~2480 MHz	DT	No	WWAN	NA	Not Support

VO=CMRS Voice Service

DT=Digital Transport

VD=CMRS IP Voice Service and Digital Transport

OTT= OTT VoIP Calling (eg. Volet, Wi-Fi calling and etc.)

Note1: The air interface is exempted from testing by low power exemption that its average antenna input power plus its MIF is  $\leq 17$  dBm, and is rated as M4.

Note2: According to ANSI C63.19 2011 -version, for the air interface technology of a device is exempt from testing whose peak antenna input power, averaged over intervals  $\leq 50 \mu s$ , is  $\leq 23$  dBm. An RF air interface technology that is exempted from testing shall be rated as M4.



### 3 SUMMARY OF TEST RESULTS

#### 3.1 Test Standards

No.	Identity	Document Title
1	47 CFR Part 20.19	Hearing aid-compatible mobile handsets.
2	ANSI C63.19-2011	American National Standard Methods of Measurement of Compatibility between Wireless Communications Devices and Hearing Aids
3	KDB 285076 D01 HAC Guidance v05	Provides equipment authorization guidance for mobile handsets subject to the requirements of Section 20.19 for hearing aid compatibility

#### 3.2 HAC Test Configuration and Setting

For HAC RF emission testing, the EUT was linked and controlled by wireless communication test set. Communication between the EUT and the wireless communication test set was established by air link. The distance between the EUT and the communicating antenna of the test set is larger than 50 cm and the output power radiated from the wireless communication test set antenna is at least 30 dB smaller than the output power of EUT. The EUT was set from the wireless communication test set to radiate maximum output power during HAC testing.

### 3.3 Summary Of HAC M-Rating

Band	Measurement Result		M-Rating
GSM 850	E-Field dB (V/m)	38.07	M4
GSM 1900	E-Field dB (V/m)	28.62	M4
LTE B38	E-Field dB (V/m)	21.91	M4
LTE B41	E-Field dB (V/m)	22.03	M4

Note: For other frequency, the air interface is exempted from testing by low power exemption that its average antenna input power plus its MIF is  $\leq 17$  dBm, and is rated as M4.

### 3.4 ANSI C63.19 HAC RF Categories

#### 3.4.1 RF Emissions

The ANSI Standard presents performance requirements for acceptable interoperability of hearing with wireless communications devices. When these parameters are met, a hearing aid operates acceptably in close proximity to a wireless communications device.

**WD RF audio interference level categories:**

Category	Limits for E-Field Emission (V/m)	
	<960MHz	>960MHz
M1	50 to 55	40 to 45
M2	45 to 50	35 to 40
M3	40 to 45	30 to 35
M4	<40	<30

### 3.5 HAC Test Uncertainty

The following measurement uncertainty levels have been estimated for tests performed on the EUT as specified in ANSI C 63.19:2011. This uncertainty represents an expanded uncertainty expressed at approximately the 95% confidence level using a coverage factor of  $k=2$ .

Uncertainty Component	Uncertainty Value	Prob. Dist.	Div.	Ci (E)	Ci (H)	Std. Unc. (+/- %)	
						E	H
<b>Measurement System</b>							
Probe calibration	6.00	N	1.000	1	1	6.00	6.00
Axial Isotropy	2.02	R	1.732		1	1.17	1.17
Sensor Displacement	14.30	R	1.732	1	0.217	8.26	1.79
Boundary effect	2.50	R	1.732	1	1	0.87	0.87
Phantom Boundary Effect	6.89	R	1.732	1	0	3.52	0.00
Linearity	2.58	R	1.732	1	1	1.49	1.49
Scaling to PMR Calibration	9.02	N	1.000	1	1	9.02	9.02
System detection limits	1.30	R	1.732	1	1	0.75	0.75
Readout Electronics	0.25	R	1.732	1	1	0.14	0.14
Response Time	1.23	R	1.732	1	1	0.71	0.71
Integration Time	2.15	R	1.732	1	1	1.24	1.24
RF ambient Conditions	2.03	R	1.732	1	1	1.17	1.17
RF Reflections	9.09	R	1.732	1	1	5.25	5.25
Probe positioner	0.63	N	1.000	1	0.71	0.63	0.45
Probe positioning	3.12	N	1.000	1	0.71	3.12	2.22
Extrapolation and Interpolation	1.18	R	1.732	1	1	0.68	0.68
<b>Test sample Related</b>							
Test sample positioning Vertical	2.73	R	1.732	1	0.71	1.58	1.12
Test sample positioning Lateral	1.19	R	1.732	1	1	0.69	0.69
Device holder and Phantom	2.20	N	1.000	1	1	2.20	2.20
Power drift	4.08	R	1.732	1	1	2.36	2.36
<b>Phantom and Setup Related</b>							
Phantom Thickness	2.00	N	1.000	1	0.6	2.00	1.20
<b>Combined Std. Uncertainty(k=1)</b>						16.18	13.25
<b>Expanded Uncertainty on Power</b>						32.35	26.50
<b>Expanded Uncertainty on Field</b>						16.18	13.25

## 4 SATIMO HSC MEASUREMENT SYSTEM

### 4.1 Definition of Hearing Aid Compatibility (HAC)

On July 10, 2003, the Federal Communications Commission (FCC) adopted new rules requiring wireless manufacturers and service providers to provide digital wireless phones that are compatible with hearing aids. The FCC has modified the exemption for wireless phones under the Hearing Aid Compatibility Act of 1998 (HAC Act) in WT Docket 01-309 RM-8658 to extend the benefits of wireless telecommunications to individuals with hearing disabilities. These benefits encompass business, social and emergency communications, which increase the value of the wireless network for everyone. An estimated more than 10% of the population in the United States show signs of hearing impairment and of that fraction, almost 80% use hearing aids. Approximately 500 million people worldwide suffer from hearing loss.

Compatibility Tests involved:

The standard calls for wireless communications devices to be measured for:

- RF Electric-field emissions.
- RF Magnetic- field emissions.
- T-coil mode, magnetic-signal strength in the audio band.
- T-coil mode, magnetic-signal frequency response through the audio band.
- T-coil mode, magnetic-signal and noise articulation index.

The hearing aid must be measured for:

- RF immunity in microphone mode
- RF immunity in T-coil mode

## 4.2 SATIMO HAC System

SATIMO HAC System Diagram:

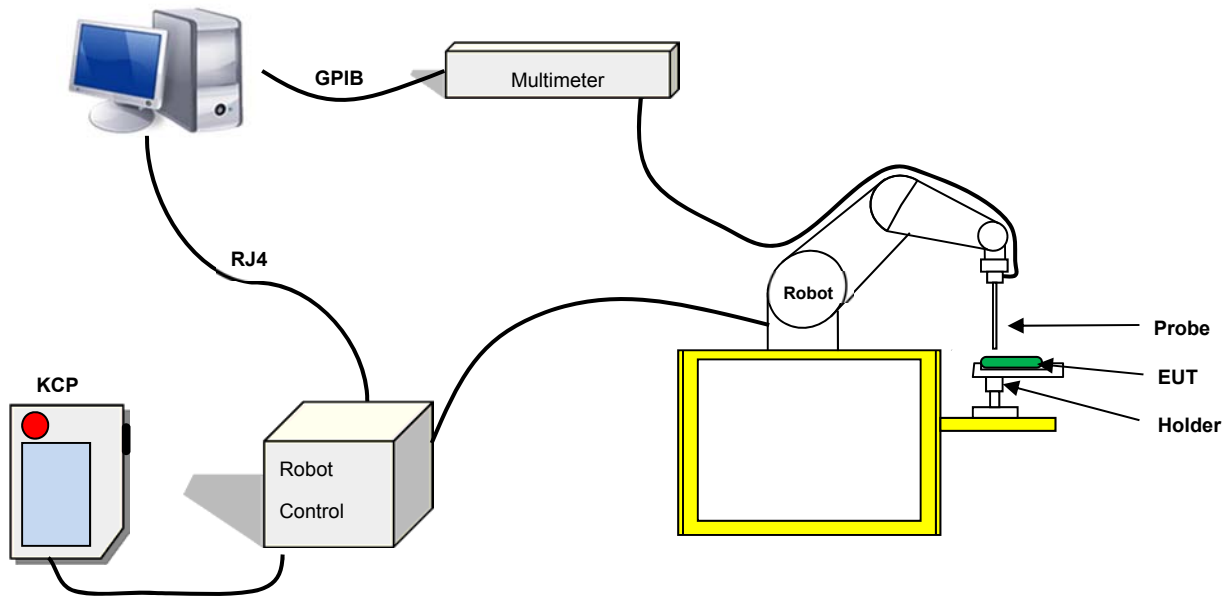

#### 4.2.1 Robot

The SATIMO HAC system uses the high precision robots from KUKA. For the 6-axis controller system, the robot controller version (KUKA) from KUKA is used. The KUKA robot series have many features that are important for our application:



- High precision (repeatability  $\pm 0.035$  mm)
- High reliability (industrial design)
- Jerk-free straight movements
- Low ELF interference (the closed metallic construction shields against motor control fields)

#### 4.2.2 HAC E-Field Probe



Serial Number:	SN 24/13 EPH41
Frequency:	0.7GHz – 2.5GHz
Probe length:	330mm
Length of one dipole:	3.3mm
Maximum external diameter:	8mm
Probe extremity diameter:	5mm
Distance between dipoles/probe extremity:	3mm
Resistance of the three dipole (at the connector):	Dipole 1:R1=2.1807 M $\Omega$ Dipole 2:R1=2.0612 M $\Omega$ Dipole 3:R3=2.1892 M $\Omega$
Connector (HIROSE series SR30)	6 wire male (Hirose SR30series)

### E-Field Probe Calibration Process

All methods used to perform the measurements and calibrations comply with the ANSI C63.19 and IEEE 1309 standards.

### LINEARITY

The linearity was determined using a standard dipole with the probe positioned 10 mm above the dipole. The input power of the dipole was adjusted from -15 to 36 dBm using a 1dB step (to cover the range 2V/m to 1000V/m).

Linearity: +/- 1.49% (+/- 0.07 dB)

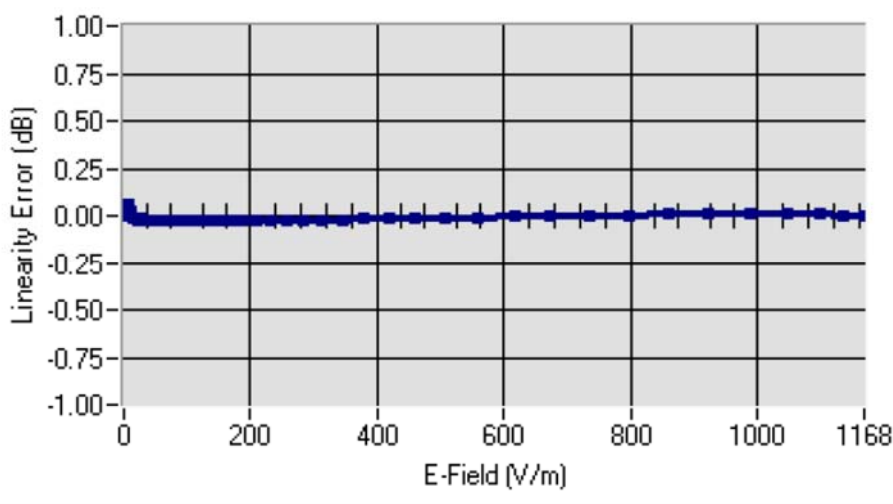

### SENSITIVITY

The sensitivity factors of the three dipoles were determined using the waveguide method outlined in the fore mentioned standards.

Calibration curves

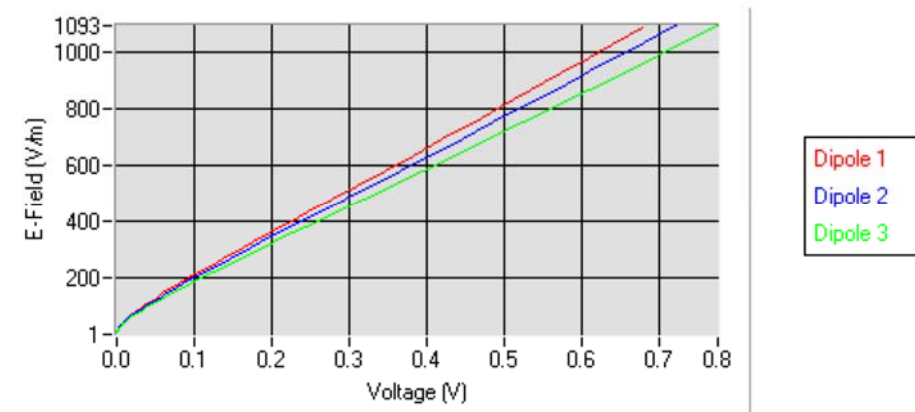

Frequency (GHz)	Normz dipole 1 ( $\mu\text{V}/(\text{V}/\text{m})^2$ )	Normz dipole 2 ( $\mu\text{V}/(\text{V}/\text{m})^2$ )	Normz dipole 3 ( $\mu\text{V}/(\text{V}/\text{m})^2$ )
0.7GHz-2.5GHz	6.54	4.86	5.80
Frequency (GHz)	DCP dipole 1 (mV)	DCP dipole 2 (mV)	DCP dipole 3 (mV)
0.7GHz-2.5GHz	96	96	92



## ISOTROPY

The axial isotropy was evaluated by exposing the probe to a reference wave from a standard dipole. The probe was rotated along its main axis from 0 - 360 degrees in 15 degree steps.

**Isotropy: +/- 1.22% (+/- 0.05 dB)**

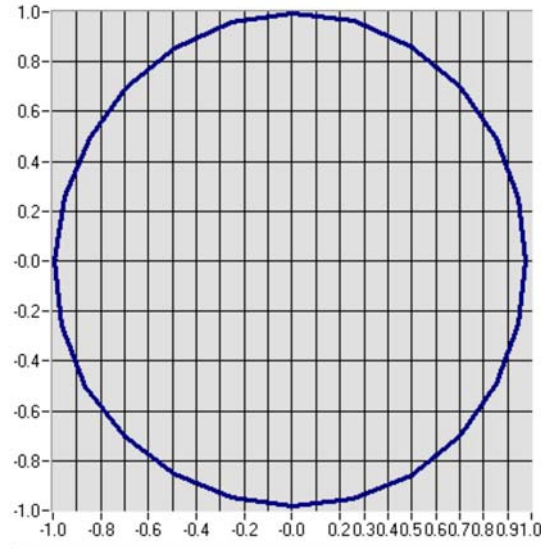

### 4.2.3 HAC H-Field Probe



Serial Number:	SN 24/13 EPH49
Frequency:	0.7GHz – 2.5GHz
Probe length:	330mm
Length of one dipole:	3.3mm
Maximum external diameter:	8mm
Probe extremity diameter:	5mm
Distance between dipoles/probe extremity:	3mm
Resistance of the three dipole (at the connector):	Dipole 1:R1=0.289 MΩ Dipole 2:R1=0.287 MΩ Dipole 3:R3=0.281 MΩ
Connector (HIROSE series SR30)	6 wire male (Hirose SR30series)

### Calibration Method Procedure

All methods used to perform the measurements and calibrations comply with the ANSI C63.19 and IEEE 1309 standards.

## LINEARITY

The linearity was determined using a standard dipole with the probe positioned 10 mm above the dipole. The input power of the dipole was adjusted from -15 to 36 dBm using a 1dB step (to cover the range 0.01A/m to 2A/m).

Linearity: +/- 1.83% (+/- 0.08 dB)

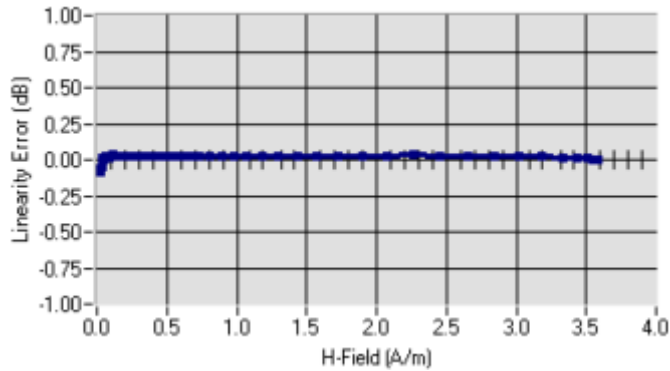

Linearity @ 835MHz

Linearity: +/- 1.36% (+/- 0.06 dB)

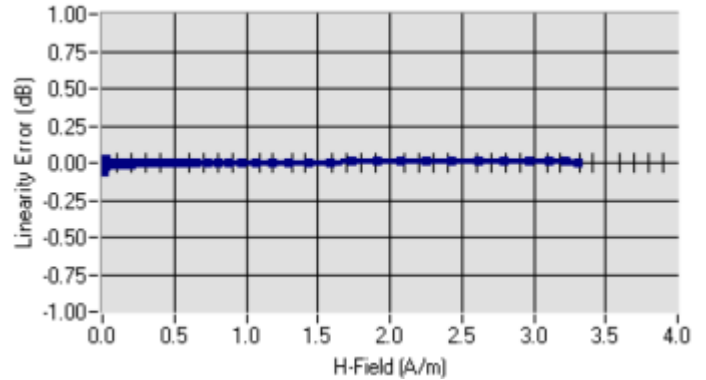

Linearity @ 1900MHz

## SENSITIVITY

The sensitivity factors of the three dipoles were determined using the waveguide method outlined in the fore mentioned standards.

Frequency (GHz)	Normz loop 1 ( $\mu\text{V}/(\text{A}/\text{m})^2$ )	Normz loop 2 ( $\mu\text{V}/(\text{A}/\text{m})^2$ )	Normz loop 3 ( $\mu\text{V}/(\text{A}/\text{m})^2$ )
0.7GHz-1.0GHz	0.062	0.072	0.068
1.7GHz-2.5GHz	0.35	0.41	0.37

Frequency (GHz)	DCP dipole 1 (mV)	DCP dipole 2 (mV)	DCP dipole 3 (mV)
0.7GHz-2.5GHz	112	102	106

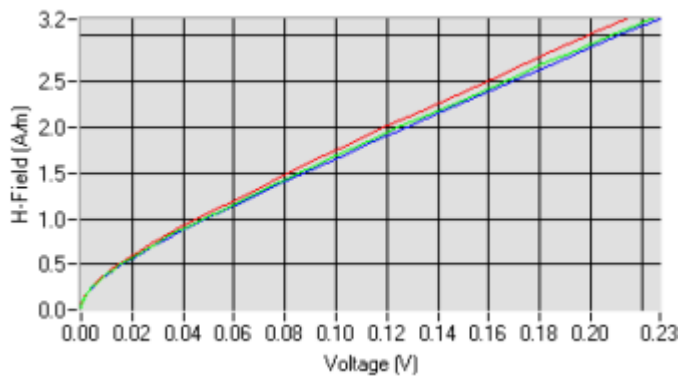

Calibration Curves @ 835MHz

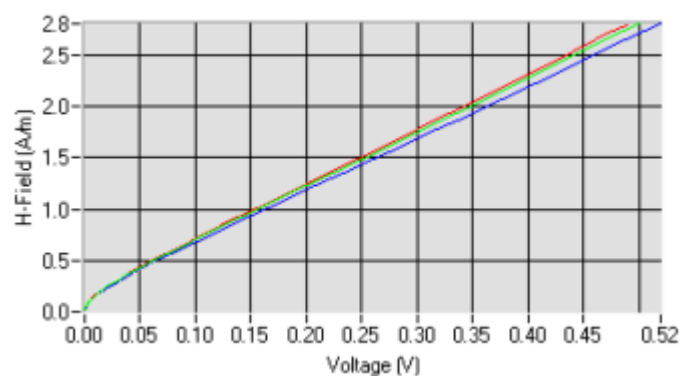

Calibration Curves @ 1900MHz

## ISOTROPY

The axial isotropy was evaluated by exposing the probe to a reference wave from a standard dipole. The probe was rotated along its main axis from 0 - 360 degrees in 15 degree steps.

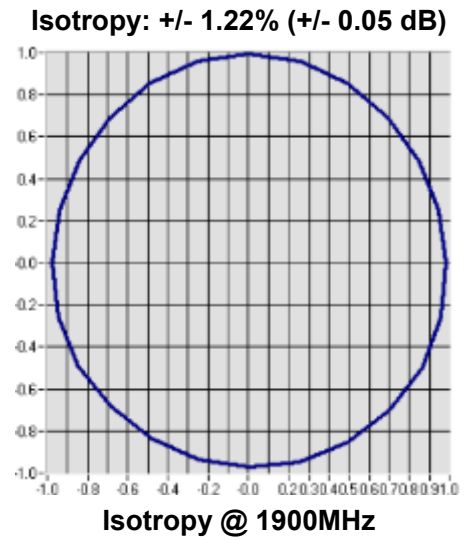
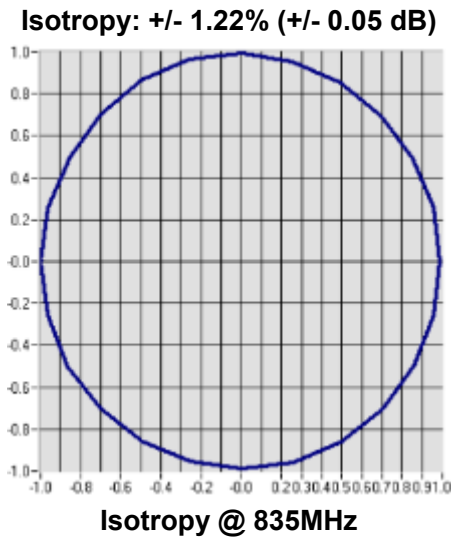

## 5 SYSTEM VERIFICATION

### 5.1 System Check Procedure

The input signal was an unmodulated continuous wave. The following points were taken into consideration in performing this check:

- Average Input Power  $P = 100\text{mW RMS}$  ( $20\text{dBm RMS}$ ) after adjustment for return loss
- The test fixture must meet the 2 wavelength separation criterion
- The proper measurement of the 1 cm probe to dipole separation, which is measured from top surface of the dipole to the calibration reference point of the sensor, defined by the probe manufacturer is shown in the following diagram:

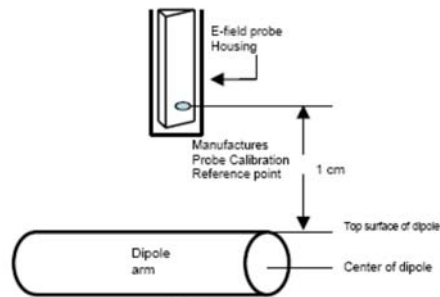

**Figure 15**  
Separation Distance from Dipole to Field Probe

RF power was recorded using both an average reading meter and a peak reading meter. Readings of the probe are provided by the measurement system. To assure proper operation of the near-field measurement probe the input power to the dipole shall be commensurate with the full rated output power of the wireless device (e.g. - for a cellular phone wireless device the average peak antenna input power will be on the order of  $100\text{mW}$  (i.e. -  $20\text{dBm}$ ) RMS after adjustment for any mismatch.

### 5.2 Validation Procedure

A dipole antenna meeting the requirements given in PC63.19 was placed in the position normally occupied by the WD. The length of the dipole was scanned with both E-field and H-field probes and the maximum values for each were recorded. Using the near-field measurement system, scan the antenna over the radiating dipole and record the greatest field reading observed. Due to the nature of E-fields about free-space dipoles, the two E-field peaks measured over the dipole are averaged to compensate for non-parallelity of the setup see manufacturer method on dipole calibration certificates, Field strength measurements shall be made only when the probe is stationary. RF power was recorded using both an average and a peak power reading meter.

Setup for Desired Output Power to Dipole

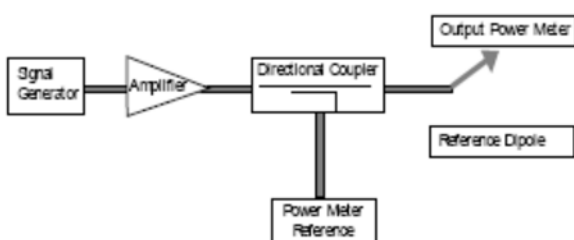

Setup to Dipole

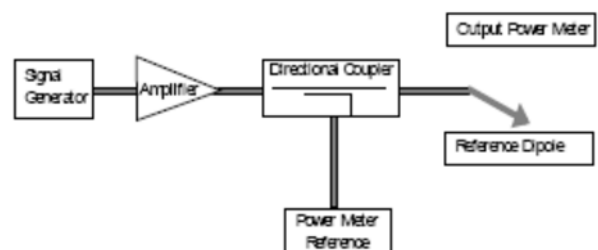

### 5.3 System Validation Setup

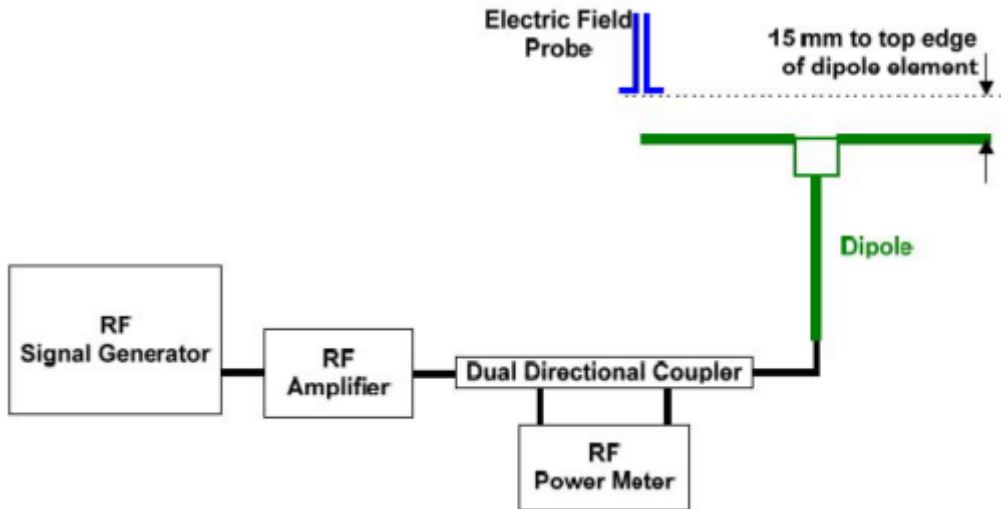

Using this setup configuration, the signal generator was adjusted for the desired output power 20dBm (100mW) at a specified frequency. The reference power from the coupled port of the directional coupler is recorded. Next, the output cable is connected to the reference dipole

### 5.4 System Validation Results

Comparing to the original HAC value provided by SATIMO, the validation data should be within its specification of 10 %.

Frequency	Input Power (dBm)	E-field Result (V/m)	Target Field (V/m)	Tolerance (%)	Date
835 MHz	20.0	214.12	220.4	-2.86	31/5/2020
1900MHz	20.0	155.84	153.4	1.62	28/5/2020
2450MHz	20.0	136.81	134.7	1.57	30/5/2020

## 6 Modulation Interference Factor (MIF)

The HAC Standard ANSI C63.19-2011 defines a new scaling using the Modulation Interference Factor (MIF). For any specific fixed and repeatable modulated signal, a modulation interference factor (MIF, expressed in dB) may be developed that relates its interference potential to its steady-state rms signal level or average power level. This factor is a function only of the audio-frequency amplitude modulation characteristics of the signal and is the same for field-strength and conducted power measurements. It is important to emphasize that the MIF is valid only for a specific repeatable audio-frequency amplitude modulation characteristic. Any change in modulation characteristic requires determination and application of a new MIF.

The MIF may be determined using a radiated RF field, a conducted RF signal, or in a preliminary stage, a mathematical analysis of a modeled RF signal:

- a) Verify the slope accuracy and dynamic range capability over the desired operating frequency band of a fast probe or sensor, square-law detector, as specified in D.3, and weighting system as specified in D.4 and D.5. For the probe and instrumentation included in the measurement of MIF, additional calibration and application of calibration factors are not required.
- b) Using RF illumination or conducted coupling, apply the specific modulated signal in question to the measurement system at a level within its confirmed operating dynamic range.
- c) Measure the steady-state rms level at the output of the fast probe or sensor.
- d) Measure the steady-state average level at the weighting output.
- e) Without changing the square-law detector or weighting system, and using RF illumination or conducted coupling, substitute for the specific modulated signal a 1kHz, 80% amplitude-modulated carrier at the same frequency and adjust its strength until the level at the weighting output equals the step d) measurement.
- f) Without changing the carrier level from step e), remove the 1 kHz modulation and again measure the steady-state rms level indicated at the output of the fast probe or sensor.
- g) The MIF for the specific modulation characteristic is provided by the ratio of the step f) measurement to the step c) measurement, expressed in dB ( $20 \times \log(\text{step f})/\text{step c})$ ).

In practice, step e) and step f) need not be repeated for each MIF determination if the relationship between the two measurements has been preestablished for the measurement system over the operating frequency and dynamic ranges.

Probe	Signal Type	MIF
E-Field Probe	CW	-99.00
	GSM-FDD (TDMA, GMSK)	3.63
	EDGE-FDD (TDMA, 8PSK, TN 0)	3.75
	UMTS-FDD (WCDMA, AMR)	-25.43
	UMTS-FDD (HSPA+)	-20.39
	LTE-FDD(SC-FDMA, 1RB, 20MHz, 16-QAM)	-9.76
	LTE-TDD (SC-FDMA, 1 RB, 20 MHz, QPSK)	-1.62
	LTE-TDD (SC-FDMA, 1 RB, 20 MHz, 16-QAM)	-1.44

## 7 HAC RF IMMUNITY MEASUREMENT PROCEDURES

### 7.1 HAC Measurement Process Diagram

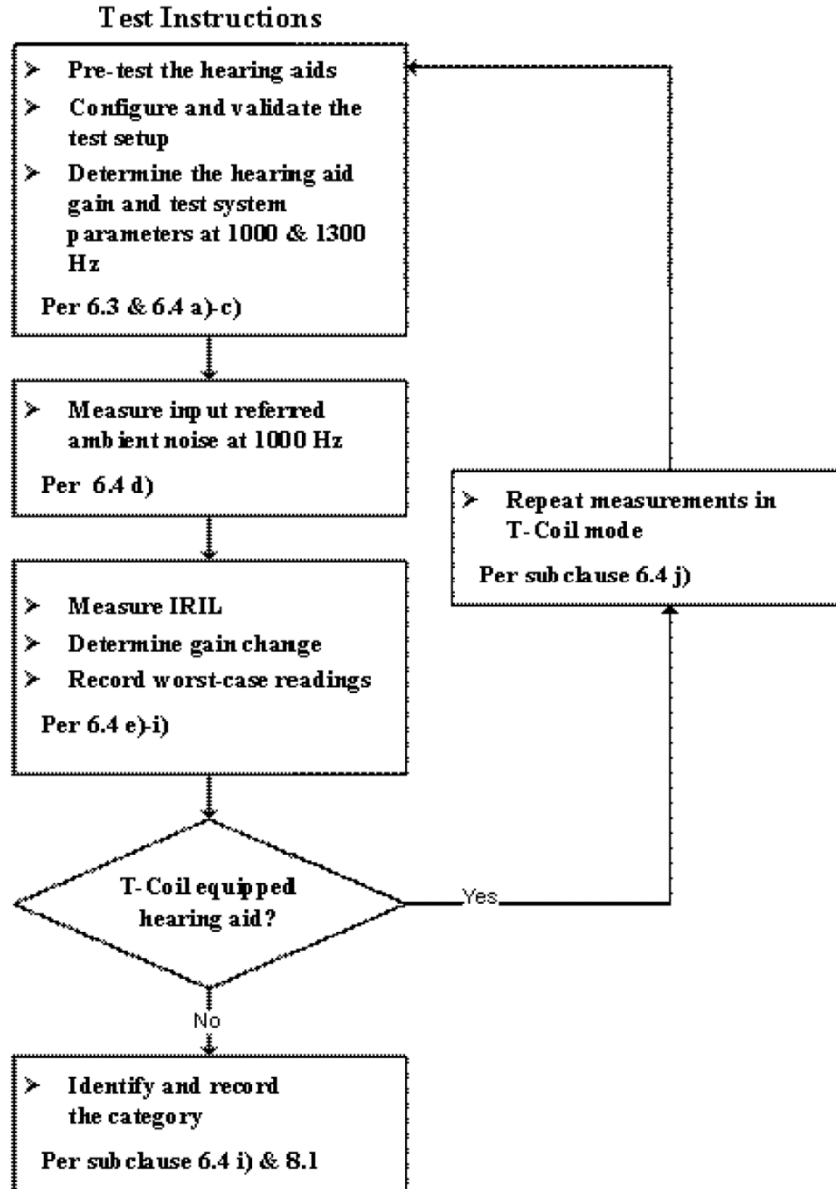

## 7.2 HAC RF Test Setup



Reference and plane for RF emission measurements

## 7.3 RF Emission Measurement Procedure

The following illustrate a typical RF emissions test scan over a wireless communications device:

- Proper operation of the field probe, probe measurement system, other instrumentation, and the positioning system was confirmed.
- WD is positioned in its intended test position, acoustic output point of the device perpendicular to the field probe.
- The WD operation for maximum rated RF output power was configured and confirmed with the base station simulator, at the test channel and other normal operating parameters as intended for the test. The battery was ensured to be fully charged before each test.
- The center sub-grid was centered over the center of the acoustic output (also audio band magnetic output, if applicable). The WD audio output was positioned tangent (as physically possible) to the measurement plane.
- A surface calibration was performed before each setup change to ensure repeatable spacing and proper maintenance of the measurement plane using the HAC Phantom.
- The measurement system measured the field strength at the reference location.



## 8 CONDUCTED RF OUTPUT POWER

### 8.1 GSM

GSM 850 (Up Antenna)								
GSM850 Band	Burst Average Power(dBm)			Tune-up Limit (dBm)	Frame-Averaged power (dBm)			Tune-up Limit (dBm)
Channel	128	190	251		128	190	251	
GSM (GMSK, 1-Slot)	32.27	32.39	32.47	33.00	23.08	23.20	23.28	23.81
GPRS (GMSK, 1-Slot)	32.25	32.36	32.45	33.00	23.06	23.17	23.26	23.81
GPRS (GMSK, 2-Slots)	29.13	29.22	29.31	29.50	23.00	23.09	23.18	23.37
GPRS (GMSK, 3-Slots)	27.68	27.77	27.84	28.00	23.26	23.35	<b>23.42</b>	23.58
GPRS (GMSK, 4-Slots)	26.16	26.24	26.35	26.50	22.98	23.06	23.17	23.32
EGPRS (8PSK, 1-Slot)	27.15	27.11	27.00	27.80	17.96	17.92	17.81	18.61
EGPRS (8PSK, 2-Slots)	25.14	25.06	25.24	25.80	19.01	18.93	19.11	19.67
EGPRS (8PSK, 3-Slots)	22.98	22.98	23.13	23.50	18.56	18.56	18.71	19.08
EGPRS (8PSK, 4-Slots)	20.87	20.80	20.99	21.50	17.69	17.62	17.81	18.32
GSM 1900 (Up Antenna)								
GSM1900 Band	Burst Average Power(dBm)			Tune-up Limit (dBm)	Frame-Averaged power(dBm)			Tune-up Limit (dBm)
Channel	512	661	810		512	661	810	
GSM (GMSK, 1-Slot)	22.09	23.11	23.62	24.00	12.90	13.92	14.43	14.81
GPRS (GMSK, 1-Slot)	22.08	23.12	23.61	24.00	12.89	13.93	14.42	14.81
GPRS (GMSK, 2-Slots)	19.12	20.13	20.49	21.00	12.99	14.00	14.36	14.87
GPRS (GMSK, 3-Slots)	17.74	18.64	18.94	19.50	13.32	14.22	14.52	15.08
GPRS (GMSK, 4-Slots)	16.71	17.12	17.71	18.00	13.53	13.94	<b>14.53</b>	14.82
EGPRS (8PSK, 1-Slot)	22.84	23.14	23.49	24.50	13.65	13.95	14.30	15.31
EGPRS (8PSK, 2-Slots)	19.57	19.98	20.31	21.50	13.44	13.85	14.18	15.37
EGPRS (8PSK, 3-Slots)	17.52	18.06	18.38	19.50	13.10	13.64	13.96	15.08
EGPRS (8PSK, 4-Slots)	16.85	17.08	17.10	18.50	13.67	13.90	13.92	15.32

GSM 850 (Down Antenna)								
GSM850 Band	Burst Average Power(dBm)			Tune-up Limit (dBm)	Frame-Averaged power (dBm)			Tune-up Limit (dBm)
Channel	128	190	251		128	190	251	
GSM (GMSK, 1-Slot)	32.42	32.51	32.57	33.20	23.23	23.32	23.38	24.01
GPRS (GMSK, 1-Slot)	32.40	32.49	32.53	33.20	23.21	23.30	23.34	24.01
GPRS (GMSK, 2-Slots)	31.01	31.06	31.11	31.60	24.88	24.93	<b>24.98</b>	25.47
GPRS (GMSK, 3-Slots)	28.99	29.03	29.07	29.60	24.57	24.61	24.65	25.18
GPRS (GMSK, 4-Slots)	27.01	27.04	27.07	27.60	23.83	23.86	23.89	24.42
EGPRS (8PSK, 1-Slot)	27.10	26.84	26.96	27.60	17.91	17.65	17.77	18.41
EGPRS (8PSK, 2-Slots)	25.11	24.66	24.88	25.80	18.98	18.53	18.75	19.73
EGPRS (8PSK, 3-Slots)	22.60	22.60	22.69	23.30	18.18	18.18	18.27	18.88
EGPRS (8PSK, 4-Slots)	20.52	20.40	20.60	21.30	17.34	17.22	17.42	18.12
GSM 1900 (Down Antenna)								
GSM1900 Band	Burst Average Power(dBm)			Tune-up Limit (dBm)	Frame-Averaged power(dBm)			Tune-up Limit (dBm)
Channel	512	661	810		512	661	810	
GSM (GMSK, 1-Slot)	30.01	29.89	29.84	30.50	20.82	20.70	20.65	21.31
GPRS (GMSK, 1-Slot)	29.99	29.85	29.81	30.50	20.80	20.66	20.62	21.31
GPRS (GMSK, 2-Slots)	27.91	27.80	27.82	28.50	21.78	21.67	21.69	22.37
GPRS (GMSK, 3-Slots)	26.42	26.31	26.38	27.00	<b>22.00</b>	21.89	21.96	22.58
GPRS (GMSK, 4-Slots)	24.39	24.27	24.33	25.00	21.21	21.09	21.15	21.82
EGPRS (8PSK, 1-Slot)	26.30	26.10	26.11	27.00	17.11	16.91	16.92	17.81
EGPRS (8PSK, 2-Slots)	24.32	24.14	24.43	25.00	18.19	18.01	18.30	18.87
EGPRS (8PSK, 3-Slots)	22.19	22.26	22.10	23.00	17.77	17.84	17.68	18.58
EGPRS (8PSK, 4-Slots)	20.06	19.95	19.84	21.00	16.88	16.77	16.66	17.82

## 8.2 WCDMA

WCDMA	Band 2 (Up Antenna)				Band 4 (Up Antenna)			
Channel	9262	9400	9538	Tune-up Limit (dBm)	1312	1412	1513	Tune-up Limit (dBm)
RMC 12.2Kbps	14.28	14.27	<b>14.36</b>	15.00	15.94	15.85	<b>16.01</b>	16.50
HSDPA Subtest-1	13.40	13.15	13.15	14.00	15.15	14.83	15.18	15.50
HSDPA Subtest-2	13.31	13.12	13.27	14.00	15.01	14.91	14.83	15.50
HSDPA Subtest-3	12.72	12.72	12.85	13.50	14.23	14.52	14.22	15.00
HSDPA Subtest-4	12.88	12.74	12.83	13.50	14.33	14.43	14.39	15.00
HSUPA Subtest-1	11.21	11.22	11.05	12.00	12.77	12.77	13.01	13.50
HSUPA Subtest-2	11.39	11.11	11.13	12.00	12.81	12.97	12.78	13.50
HSUPA Subtest-3	12.15	12.05	12.13	13.00	14.04	14.01	13.88	14.50
HSUPA Subtest-4	10.78	10.69	10.56	11.50	12.23	12.50	12.57	13.00
HSUPA Subtest-5	11.97	12.37	12.13	13.00	13.98	13.71	14.01	14.50
WCDMA	Band 5 (Up Antenna)				/			
Channel	4132	4182	4233	Tune-up Limit (dBm)	/	/	/	/
RMC 12.2Kbps	23.05	23.07	<b>23.09</b>	23.90	/	/	/	/
HSDPA Subtest-1	22.12	22.09	21.93	23.00	/	/	/	/
HSDPA Subtest-2	21.90	22.10	21.89	23.00	/	/	/	/
HSDPA Subtest-3	21.53	21.57	21.33	22.50	/	/	/	/
HSDPA Subtest-4	21.63	21.59	21.44	22.50	/	/	/	/
HSUPA Subtest-1	19.90	20.07	19.97	21.00	/	/	/	/
HSUPA Subtest-2	20.09	20.05	19.97	21.00	/	/	/	/
HSUPA Subtest-3	21.09	21.07	21.00	22.00	/	/	/	/
HSUPA Subtest-4	19.35	19.61	19.34	20.50	/	/	/	/
HSUPA Subtest-5	21.02	21.06	21.08	22.00	/	/	/	/

WCDMA	Band 2 (Down Antenna)				Band 4 (Down Antenna)			
Channel	9262	9400	9538	Tune-up Limit (dBm)	1312	1412	1513	Tune-up Limit (dBm)
RMC 12.2Kbps	22.34	22.28	<b>22.43</b>	23.70	22.62	22.63	<b>22.71</b>	23.80
HSDPA Subtest-1	22.28	22.25	22.23	23.00	21.89	21.87	21.72	23.00
HSDPA Subtest-2	22.26	22.36	22.08	23.00	21.77	21.73	21.81	23.00
HSDPA Subtest-3	21.84	22.03	21.71	22.50	21.45	21.31	21.39	22.50
HSDPA Subtest-4	21.81	21.96	21.79	22.50	21.23	21.27	21.49	22.50
HSUPA Subtest-1	20.24	20.21	19.99	21.00	19.86	19.86	19.69	21.00
HSUPA Subtest-2	20.56	20.52	20.55	21.00	20.00	19.84	19.68	21.00
HSUPA Subtest-3	21.52	21.48	21.22	22.00	20.89	20.95	20.69	22.00
HSUPA Subtest-4	19.91	20.02	19.77	20.50	19.52	19.18	19.35	20.50
HSUPA Subtest-5	21.28	21.40	21.41	22.00	20.89	20.72	21.04	22.00
WCDMA	Band 5 (Down Antenna)				/			
Channel	4132	4182	4233	Tune-up Limit (dBm)	/	/	/	/
RMC 12.2Kbps	22.48	22.54	<b>22.55</b>	23.70	/	/	/	/
HSDPA Subtest-1	22.05	21.95	21.73	23.00	/	/	/	/
HSDPA Subtest-2	21.71	21.82	21.98	23.00	/	/	/	/
HSDPA Subtest-3	21.55	21.37	21.41	22.50	/	/	/	/
HSDPA Subtest-4	21.54	21.40	21.54	22.50	/	/	/	/
HSUPA Subtest-1	19.91	20.05	19.86	21.00	/	/	/	/
HSUPA Subtest-2	19.95	20.04	19.83	21.00	/	/	/	/
HSUPA Subtest-3	20.74	20.75	20.83	22.00	/	/	/	/
HSUPA Subtest-4	19.44	19.18	19.28	20.50	/	/	/	/
HSUPA Subtest-5	20.94	20.90	21.05	22.00	/	/	/	/

### 8.3 LTE

FDD LTE Band 2 (Up Antenna)							
Bandwidth (MHz)	RB Set	RB offset	Modulation	Power (dBm)			
	Channel			18607	18900	19193	Tune up limit (dBm)
1.4 MHz	1 (RB_Pos:0)	LOW	QPSK	13.84	13.75	13.81	15.00
	1 (RB_Pos:3)	MIDDLE	QPSK	13.99	13.93	14.05	15.00
	1 (RB_Pos:5)	HIGH	QPSK	13.81	13.75	13.79	15.00
	3 (RB_Pos:0)	LOW	QPSK	13.97	13.84	13.95	15.00
	3 (RB_Pos:1)	MIDDLE	QPSK	13.93	13.91	13.94	15.00
	3 (RB_Pos:3)	HIGH	QPSK	13.93	13.85	13.97	15.00
	6 (RB_Pos:0)	LOW	QPSK	13.88	13.83	13.89	15.00
	1 (RB_Pos:0)	LOW	16QAM	13.98	14.20	13.88	15.00
	1 (RB_Pos:3)	MIDDLE	16QAM	14.15	14.37	14.09	15.00
	1 (RB_Pos:5)	HIGH	16QAM	13.98	14.21	13.94	15.00
	3 (RB_Pos:0)	LOW	16QAM	13.93	14.09	14.11	15.00
	3 (RB_Pos:1)	MIDDLE	16QAM	13.98	14.05	14.17	15.00
	3 (RB_Pos:3)	HIGH	16QAM	13.97	14.10	14.10	15.00
	6 (RB_Pos:0)	LOW	16QAM	14.07	13.75	14.07	15.00
	1 (RB_Pos:0)	LOW	64QAM	13.72	14.03	13.88	15.00
	1 (RB_Pos:3)	MIDDLE	64QAM	13.77	14.18	13.93	15.00
	1 (RB_Pos:5)	HIGH	64QAM	13.73	13.87	13.80	15.00
	3 (RB_Pos:0)	LOW	64QAM	13.79	13.91	14.11	15.00
	3 (RB_Pos:1)	MIDDLE	64QAM	13.99	13.93	14.12	15.00
	3 (RB_Pos:3)	HIGH	64QAM	13.66	14.07	13.98	15.00
6 (RB_Pos:0)	LOW	64QAM	13.71	13.58	14.02	15.00	
Bandwidth (MHz)	RB Set	RB offset	Modulation	Power (dBm)			
	Channel			18615	18900	19185	Tune up limit (dBm)
3 MHz	1 (RB_Pos:0)	LOW	QPSK	13.89	13.84	13.89	15.00
	1 (RB_Pos:8)	MIDDLE	QPSK	13.88	13.87	13.88	15.00
	1 (RB_Pos:14)	HIGH	QPSK	13.85	13.82	13.87	15.00
	8 (RB_Pos:0)	LOW	QPSK	13.90	13.83	13.88	15.00
	8 (RB_Pos:3)	MIDDLE	QPSK	13.95	13.89	13.95	15.00
	8 (RB_Pos:7)	HIGH	QPSK	13.90	13.83	13.90	15.00
	15 (RB_Pos:0)	LOW	QPSK	13.88	13.87	13.91	15.00
	1 (RB_Pos:0)	LOW	16QAM	13.84	14.25	13.99	15.00
	1 (RB_Pos:8)	MIDDLE	16QAM	13.88	14.26	13.98	15.00
	1 (RB_Pos:14)	HIGH	16QAM	13.79	14.26	13.98	15.00
	8 (RB_Pos:0)	LOW	16QAM	14.05	14.01	13.94	15.00
	8 (RB_Pos:3)	MIDDLE	16QAM	14.10	13.96	14.03	15.00
	8 (RB_Pos:7)	HIGH	16QAM	14.00	13.92	13.97	15.00
	15 (RB_Pos:0)	LOW	16QAM	13.94	13.90	13.90	15.00
	1 (RB_Pos:0)	LOW	64QAM	13.65	13.96	13.67	15.00

	1 (RB_Pos:8)	MIDDLE	64QAM	13.52	14.15	13.66	15.00
	1 (RB_Pos:14)	HIGH	64QAM	13.40	14.21	13.75	15.00
	8 (RB_Pos:0)	LOW	64QAM	13.67	13.94	13.63	15.00
	8 (RB_Pos:3)	MIDDLE	64QAM	13.96	13.85	13.71	15.00
	8 (RB_Pos:7)	HIGH	64QAM	13.92	13.86	13.94	15.00
	15 (RB_Pos:0)	LOW	64QAM	13.59	13.55	13.72	15.00
Bandwidth (MHz)	RB Set	RB offset	Modulation	Power (dBm)			
	Channel			18625	18900	19175	Tune up limit (dBm)
5 MHz	1 (RB_Pos:0)	LOW	QPSK	13.82	13.77	13.75	15.00
	1 (RB_Pos:13)	MIDDLE	QPSK	13.94	13.87	13.92	15.00
	1 (RB_Pos:24)	HIGH	QPSK	13.78	13.75	13.80	15.00
	12 (RB_Pos:0)	LOW	QPSK	13.84	13.81	13.90	15.00
	12 (RB_Pos:6)	MIDDLE	QPSK	13.94	13.92	13.99	15.00
	12 (RB_Pos:13)	HIGH	QPSK	13.90	13.81	13.89	15.00
	25 (RB_Pos:0)	LOW	QPSK	13.88	13.86	13.87	15.00
	1 (RB_Pos:0)	LOW	16QAM	13.99	14.06	13.87	15.00
	1 (RB_Pos:13)	MIDDLE	16QAM	14.12	14.21	14.07	15.00
	1 (RB_Pos:24)	HIGH	16QAM	13.99	14.19	13.98	15.00
	12 (RB_Pos:0)	LOW	16QAM	13.94	14.01	13.95	15.00
	12 (RB_Pos:6)	MIDDLE	16QAM	14.04	14.06	14.06	15.00
	12 (RB_Pos:13)	HIGH	16QAM	13.95	14.02	13.96	15.00
	25 (RB_Pos:0)	LOW	16QAM	13.92	13.98	13.89	15.00
	1 (RB_Pos:0)	LOW	64QAM	13.71	13.94	13.67	15.00
	1 (RB_Pos:13)	MIDDLE	64QAM	13.79	14.15	13.97	15.00
	1 (RB_Pos:24)	HIGH	64QAM	14.01	14.15	13.67	15.00
	12 (RB_Pos:0)	LOW	64QAM	13.97	13.84	13.76	15.00
	12 (RB_Pos:6)	MIDDLE	64QAM	13.87	13.99	13.98	15.00
	12 (RB_Pos:13)	HIGH	64QAM	13.79	13.86	13.75	15.00
25 (RB_Pos:0)	LOW	64QAM	13.83	13.71	13.51	15.00	
Bandwidth (MHz)	RB Set	RB offset	Modulation	Power (dBm)			
	Channel			18650	18900	19150	Tune up limit (dBm)
10 MHz	1 (RB_Pos:0)	LOW	QPSK	13.88	13.84	13.88	15.00
	1 (RB_Pos:25)	MIDDLE	QPSK	13.95	14.04	14.01	15.00
	1 (RB_Pos:49)	HIGH	QPSK	13.82	13.74	13.84	15.00
	25 (RB_Pos:0)	LOW	QPSK	13.92	13.89	13.96	15.00
	25 (RB_Pos:12)	MIDDLE	QPSK	13.92	13.90	13.90	15.00
	25 (RB_Pos:25)	HIGH	QPSK	13.91	13.85	13.85	15.00
	50 (RB_Pos:0)	LOW	QPSK	13.96	13.89	13.88	15.00
	1 (RB_Pos:0)	LOW	16QAM	13.82	14.24	13.87	15.00
	1 (RB_Pos:25)	MIDDLE	16QAM	14.01	14.41	14.07	15.00
	1 (RB_Pos:49)	HIGH	16QAM	13.77	14.18	13.94	15.00
	25 (RB_Pos:0)	LOW	16QAM	13.95	13.99	14.05	15.00
	25 (RB_Pos:12)	MIDDLE	16QAM	14.01	13.94	13.99	15.00

	25 (RB_Pos:25)	HIGH	16QAM	13.94	13.97	14.00	15.00
	50 (RB_Pos:0)	LOW	16QAM	13.91	13.94	13.98	15.00
	1 (RB_Pos:0)	LOW	64QAM	13.78	13.93	13.90	15.00
	1 (RB_Pos:25)	MIDDLE	64QAM	13.87	14.41	13.89	15.00
	1 (RB_Pos:49)	HIGH	64QAM	13.47	14.16	13.78	15.00
	25 (RB_Pos:0)	LOW	64QAM	13.86	13.63	13.77	15.00
	25 (RB_Pos:12)	MIDDLE	64QAM	13.90	13.62	14.01	15.00
	25 (RB_Pos:25)	HIGH	64QAM	13.76	14.00	13.83	15.00
	50 (RB_Pos:0)	LOW	64QAM	13.91	13.79	13.92	15.00
Bandwidth (MHz)	RB Set	RB offset	Modulation	Power (dBm)			
	Channel			18675	18900	19125	Tune up limit (dBm)
15 MHz	1 (RB_Pos:0)	LOW	QPSK	13.83	13.80	13.82	15.00
	1 (RB_Pos:38)	MIDDLE	QPSK	13.91	13.90	13.92	15.00
	1 (RB_Pos:74)	HIGH	QPSK	13.74	13.73	13.79	15.00
	36 (RB_Pos:0)	LOW	QPSK	13.95	13.91	14.01	15.00
	36 (RB_Pos:20)	MIDDLE	QPSK	14.00	13.93	13.92	15.00
	36 (RB_Pos:39)	HIGH	QPSK	13.91	13.86	13.86	15.00
	75 (RB_Pos:0)	LOW	QPSK	13.93	13.91	13.90	15.00
	1 (RB_Pos:0)	LOW	16QAM	13.79	14.20	14.23	15.00
	1 (RB_Pos:38)	MIDDLE	16QAM	13.86	14.29	14.32	15.00
	1 (RB_Pos:74)	HIGH	16QAM	13.73	14.08	14.19	15.00
	36 (RB_Pos:0)	LOW	16QAM	13.94	13.96	13.92	15.00
	36 (RB_Pos:20)	MIDDLE	16QAM	13.93	13.99	13.88	15.00
	36 (RB_Pos:39)	HIGH	16QAM	13.88	13.94	13.84	15.00
	75 (RB_Pos:0)	LOW	16QAM	13.93	13.95	13.89	15.00
	1 (RB_Pos:0)	LOW	64QAM	13.72	13.96	13.84	15.00
	1 (RB_Pos:38)	MIDDLE	64QAM	13.56	14.18	14.18	15.00
	1 (RB_Pos:74)	HIGH	64QAM	13.42	13.72	14.13	15.00
	36 (RB_Pos:0)	LOW	64QAM	13.78	13.66	13.73	15.00
	36 (RB_Pos:20)	MIDDLE	64QAM	13.64	13.92	13.50	15.00
	36 (RB_Pos:39)	HIGH	64QAM	13.75	13.81	13.86	15.00
75 (RB_Pos:0)	LOW	64QAM	13.61	13.66	13.73	15.00	
Bandwidth (MHz)	RB Set	RB offset	Modulation	Power (dBm)			
	Channel			18700	18900	19100	Tune up limit (dBm)
20 MHz	1 (RB_Pos:0)	LOW	QPSK	13.83	13.80	13.68	15.00
	1 (RB_Pos:50)	MIDDLE	QPSK	14.08	<b>14.12</b>	14.02	15.00
	1 (RB_Pos:99)	HIGH	QPSK	13.75	13.71	13.69	15.00
	50 (RB_Pos:0)	LOW	QPSK	13.89	13.90	13.92	15.00
	50 (RB_Pos:25)	MIDDLE	QPSK	13.92	14.01	13.89	15.00
	50 (RB_Pos:50)	HIGH	QPSK	13.82	13.84	13.76	15.00
	100 (RB_Pos:0)	LOW	QPSK	13.86	13.89	13.87	15.00
	1 (RB_Pos:0)	LOW	16QAM	14.31	14.25	14.13	15.00
	1 (RB_Pos:50)	MIDDLE	16QAM	14.32	14.25	14.43	15.00

	1 (RB_Pos:99)	HIGH	16QAM	14.10	14.16	14.17	15.00
	50 (RB_Pos:0)	LOW	16QAM	13.97	13.93	13.92	15.00
	50 (RB_Pos:25)	MIDDLE	16QAM	13.96	13.95	13.91	15.00
	50 (RB_Pos:50)	HIGH	16QAM	13.87	13.88	13.74	15.00
	100 (RB_Pos:0)	LOW	16QAM	13.92	13.89	13.91	15.00
	1 (RB_Pos:0)	LOW	64QAM	14.31	13.86	13.79	15.00
	1 (RB_Pos:50)	MIDDLE	64QAM	14.31	14.27	14.32	15.00
	1 (RB_Pos:99)	HIGH	64QAM	13.93	14.13	14.11	15.00
	50 (RB_Pos:0)	LOW	64QAM	14.00	13.67	13.86	15.00
	50 (RB_Pos:25)	MIDDLE	64QAM	13.61	13.75	13.82	15.00
	50 (RB_Pos:50)	HIGH	64QAM	13.67	13.49	13.41	15.00
	100 (RB_Pos:0)	LOW	64QAM	13.60	13.85	13.71	15.00

FDD LTE Band 4 (Up Antenna)							
Bandwidth (MHz)	RB Set	RB offset	Modulation	Power (dBm)			
	Channel			19957	20175	20393	Tune up limit (dBm)
1.4 MHz	1 (RB_Pos:0)	LOW	QPSK	15.46	15.45	15.44	16.50
	1 (RB_Pos:3)	MIDDLE	QPSK	15.68	15.61	15.68	16.50
	1 (RB_Pos:5)	HIGH	QPSK	15.47	15.47	15.42	16.50
	3 (RB_Pos:0)	LOW	QPSK	15.49	15.49	15.55	16.50
	3 (RB_Pos:1)	MIDDLE	QPSK	15.58	15.52	15.60	16.50
	3 (RB_Pos:3)	HIGH	QPSK	15.51	15.53	15.57	16.50
	6 (RB_Pos:0)	LOW	QPSK	15.56	15.52	15.51	16.50
	1 (RB_Pos:0)	LOW	16QAM	15.61	15.81	15.50	16.50
	1 (RB_Pos:3)	MIDDLE	16QAM	15.82	16.00	15.72	16.50
	1 (RB_Pos:5)	HIGH	16QAM	15.61	15.85	15.52	16.50
	3 (RB_Pos:0)	LOW	16QAM	15.62	15.75	15.73	16.50
	3 (RB_Pos:1)	MIDDLE	16QAM	15.62	15.80	15.80	16.50
	3 (RB_Pos:3)	HIGH	16QAM	15.68	15.75	15.82	16.50
	6 (RB_Pos:0)	LOW	16QAM	15.70	15.43	15.69	16.50
	1 (RB_Pos:0)	LOW	64QAM	15.51	15.57	15.43	16.50
	1 (RB_Pos:3)	MIDDLE	64QAM	15.50	15.82	15.55	16.50
	1 (RB_Pos:5)	HIGH	64QAM	15.60	15.54	15.52	16.50
	3 (RB_Pos:0)	LOW	64QAM	15.64	15.50	15.69	16.50
	3 (RB_Pos:1)	MIDDLE	64QAM	15.37	15.76	15.51	16.50
	3 (RB_Pos:3)	HIGH	64QAM	15.43	15.59	15.45	16.50
6 (RB_Pos:0)	LOW	64QAM	15.42	15.12	15.47	16.50	
Bandwidth (MHz)	RB Set	RB offset	Modulation	Power (dBm)			
	Channel			19965	20175	20385	Tune up limit (dBm)
3 MHz	1 (RB_Pos:0)	LOW	QPSK	15.49	15.44	15.46	16.50
	1 (RB_Pos:8)	MIDDLE	QPSK	15.41	15.43	15.46	16.50
	1 (RB_Pos:14)	HIGH	QPSK	15.42	15.43	15.44	16.50



	8 (RB_Pos:0)	LOW	QPSK	15.50	15.42	15.49	16.50
	8 (RB_Pos:3)	MIDDLE	QPSK	15.50	15.47	15.48	16.50
	8 (RB_Pos:7)	HIGH	QPSK	15.45	15.45	15.46	16.50
	15 (RB_Pos:0)	LOW	QPSK	15.45	15.43	15.50	16.50
	1 (RB_Pos:0)	LOW	16QAM	15.44	15.86	15.52	16.50
	1 (RB_Pos:8)	MIDDLE	16QAM	15.41	15.86	15.54	16.50
	1 (RB_Pos:14)	HIGH	16QAM	15.35	15.82	15.47	16.50
	8 (RB_Pos:0)	LOW	16QAM	15.58	15.58	15.54	16.50
	8 (RB_Pos:3)	MIDDLE	16QAM	15.63	15.60	15.58	16.50
	8 (RB_Pos:7)	HIGH	16QAM	15.56	15.54	15.50	16.50
	15 (RB_Pos:0)	LOW	16QAM	15.48	15.50	15.46	16.50
	1 (RB_Pos:0)	LOW	64QAM	15.16	15.87	15.26	16.50
	1 (RB_Pos:8)	MIDDLE	64QAM	15.25	15.71	15.24	16.50
	1 (RB_Pos:14)	HIGH	64QAM	15.17	15.74	15.20	16.50
	8 (RB_Pos:0)	LOW	64QAM	15.36	15.58	15.21	16.50
	8 (RB_Pos:3)	MIDDLE	64QAM	15.25	15.63	15.59	16.50
	8 (RB_Pos:7)	HIGH	64QAM	15.37	15.27	15.12	16.50
	15 (RB_Pos:0)	LOW	64QAM	15.19	15.19	15.07	16.50
Bandwidth (MHz)	RB Set	RB offset	Modulation	Power (dBm)			
	Channel			19975	20175	20375	Tune up limit (dBm)
5 MHz	1 (RB_Pos:0)	LOW	QPSK	15.41	15.37	15.38	16.50
	1 (RB_Pos:13)	MIDDLE	QPSK	15.48	15.46	15.46	16.50
	1 (RB_Pos:24)	HIGH	QPSK	15.34	15.39	15.37	16.50
	12 (RB_Pos:0)	LOW	QPSK	15.43	15.37	15.42	16.50
	12 (RB_Pos:6)	MIDDLE	QPSK	15.48	15.46	15.53	16.50
	12 (RB_Pos:13)	HIGH	QPSK	15.40	15.45	15.43	16.50
	25 (RB_Pos:0)	LOW	QPSK	15.43	15.40	15.44	16.50
	1 (RB_Pos:0)	LOW	16QAM	15.62	15.85	15.54	16.50
	1 (RB_Pos:13)	MIDDLE	16QAM	15.66	15.90	15.64	16.50
	1 (RB_Pos:24)	HIGH	16QAM	15.56	15.85	15.53	16.50
	12 (RB_Pos:0)	LOW	16QAM	15.50	15.60	15.55	16.50
	12 (RB_Pos:6)	MIDDLE	16QAM	15.56	15.65	15.63	16.50
	12 (RB_Pos:13)	HIGH	16QAM	15.54	15.65	15.54	16.50
	25 (RB_Pos:0)	LOW	16QAM	15.51	15.58	15.46	16.50
	1 (RB_Pos:0)	LOW	64QAM	15.25	15.77	15.24	16.50
	1 (RB_Pos:13)	MIDDLE	64QAM	15.46	15.82	15.53	16.50
	1 (RB_Pos:24)	HIGH	64QAM	15.44	15.73	15.36	16.50
	12 (RB_Pos:0)	LOW	64QAM	15.33	15.60	15.25	16.50
	12 (RB_Pos:6)	MIDDLE	64QAM	15.46	15.58	15.44	16.50
	12 (RB_Pos:13)	HIGH	64QAM	15.27	15.46	15.37	16.50
25 (RB_Pos:0)	LOW	64QAM	15.16	15.58	15.45	16.50	
Bandwidth (MHz)	RB Set	RB offset	Modulation	Power (dBm)			
	Channel			20000	20175	20350	Tune up limit (dBm)

10 MHz	1 (RB_Pos:0)	LOW	QPSK	15.52	15.48	15.48	16.50
	1 (RB_Pos:25)	MIDDLE	QPSK	15.60	15.59	15.61	16.50
	1 (RB_Pos:49)	HIGH	QPSK	15.50	15.44	15.47	16.50
	25 (RB_Pos:0)	LOW	QPSK	15.46	15.45	15.50	16.50
	25 (RB_Pos:12)	MIDDLE	QPSK	15.45	15.49	15.50	16.50
	25 (RB_Pos:25)	HIGH	QPSK	15.52	15.56	15.49	16.50
	50 (RB_Pos:0)	LOW	QPSK	15.47	15.50	15.50	16.50
	1 (RB_Pos:0)	LOW	16QAM	15.46	15.87	15.48	16.50
	1 (RB_Pos:25)	MIDDLE	16QAM	15.55	16.00	15.67	16.50
	1 (RB_Pos:49)	HIGH	16QAM	15.42	15.84	15.53	16.50
	25 (RB_Pos:0)	LOW	16QAM	15.56	15.58	15.65	16.50
	25 (RB_Pos:12)	MIDDLE	16QAM	15.54	15.57	15.63	16.50
	25 (RB_Pos:25)	HIGH	16QAM	15.58	15.63	15.64	16.50
	50 (RB_Pos:0)	LOW	16QAM	15.53	15.58	15.60	16.50
	1 (RB_Pos:0)	LOW	64QAM	15.30	15.55	15.37	16.50
	1 (RB_Pos:25)	MIDDLE	64QAM	15.18	15.86	15.56	16.50
	1 (RB_Pos:49)	HIGH	64QAM	15.12	15.67	15.14	16.50
	25 (RB_Pos:0)	LOW	64QAM	15.42	15.43	15.28	16.50
	25 (RB_Pos:12)	MIDDLE	64QAM	15.51	15.20	15.26	16.50
	25 (RB_Pos:25)	HIGH	64QAM	15.46	15.37	15.38	16.50
50 (RB_Pos:0)	LOW	64QAM	15.27	15.41	15.61	16.50	
Bandwidth (MHz)	RB Set	RB offset	Modulation	Power (dBm)			
	Channel			20025	20175	20325	Tune up limit (dBm)
15 MHz	1 (RB_Pos:0)	LOW	QPSK	15.45	15.45	15.39	16.50
	1 (RB_Pos:38)	MIDDLE	QPSK	15.46	15.49	15.44	16.50
	1 (RB_Pos:74)	HIGH	QPSK	15.40	15.38	15.40	16.50
	36 (RB_Pos:0)	LOW	QPSK	15.57	15.51	15.55	16.50
	36 (RB_Pos:20)	MIDDLE	QPSK	15.56	15.57	15.53	16.50
	36 (RB_Pos:39)	HIGH	QPSK	15.57	15.53	15.48	16.50
	75 (RB_Pos:0)	LOW	QPSK	15.51	15.53	15.53	16.50
	1 (RB_Pos:0)	LOW	16QAM	15.38	15.84	15.79	16.50
	1 (RB_Pos:38)	MIDDLE	16QAM	15.44	15.88	15.85	16.50
	1 (RB_Pos:74)	HIGH	16QAM	15.34	15.80	15.82	16.50
	36 (RB_Pos:0)	LOW	16QAM	15.48	15.51	15.49	16.50
	36 (RB_Pos:20)	MIDDLE	16QAM	15.49	15.59	15.50	16.50
	36 (RB_Pos:39)	HIGH	16QAM	15.51	15.60	15.47	16.50
	75 (RB_Pos:0)	LOW	16QAM	15.52	15.53	15.47	16.50
	1 (RB_Pos:0)	LOW	64QAM	15.00	15.51	15.84	16.50
	1 (RB_Pos:38)	MIDDLE	64QAM	15.21	15.49	15.75	16.50
	1 (RB_Pos:74)	HIGH	64QAM	15.10	15.71	15.62	16.50
	36 (RB_Pos:0)	LOW	64QAM	15.40	15.51	15.15	16.50
	36 (RB_Pos:20)	MIDDLE	64QAM	15.13	15.32	15.34	16.50
	36 (RB_Pos:39)	HIGH	64QAM	15.37	15.52	15.17	16.50
75 (RB_Pos:0)	LOW	64QAM	15.33	15.49	15.42	16.50	

Bandwidth (MHz)	RB Set	RB offset	Modulation	Power (dBm)			
	Channel			20050	20175	20300	Tune up limit (dBm)
20 MHz	1 (RB_Pos:0)	LOW	QPSK	15.38	15.43	15.30	16.50
	1 (RB_Pos:50)	MIDDLE	QPSK	15.63	<b>15.69</b>	15.56	16.50
	1 (RB_Pos:99)	HIGH	QPSK	15.37	15.41	15.31	16.50
	50 (RB_Pos:0)	LOW	QPSK	15.47	15.40	15.48	16.50
	50 (RB_Pos:25)	MIDDLE	QPSK	15.50	15.52	15.46	16.50
	50 (RB_Pos:50)	HIGH	QPSK	15.41	15.47	15.40	16.50
	100 (RB_Pos:0)	LOW	QPSK	15.49	15.40	15.43	16.50
	1 (RB_Pos:0)	LOW	16QAM	15.80	15.87	15.73	16.50
	1 (RB_Pos:50)	MIDDLE	16QAM	16.10	16.04	15.95	16.50
	1 (RB_Pos:99)	HIGH	16QAM	15.79	15.72	15.69	16.50
	50 (RB_Pos:0)	LOW	16QAM	15.50	15.51	15.51	16.50
	50 (RB_Pos:25)	MIDDLE	16QAM	15.57	15.57	15.52	16.50
	50 (RB_Pos:50)	HIGH	16QAM	15.58	15.49	15.40	16.50
	100 (RB_Pos:0)	LOW	16QAM	15.58	15.49	15.46	16.50
	1 (RB_Pos:0)	LOW	64QAM	15.72	15.66	15.48	16.50
	1 (RB_Pos:50)	MIDDLE	64QAM	15.85	15.87	15.72	16.50
	1 (RB_Pos:99)	HIGH	64QAM	15.60	15.63	15.70	16.50
	50 (RB_Pos:0)	LOW	64QAM	15.51	15.42	15.25	16.50
	50 (RB_Pos:25)	MIDDLE	64QAM	15.37	15.49	15.35	16.50
	50 (RB_Pos:50)	HIGH	64QAM	15.31	15.13	15.34	16.50
100 (RB_Pos:0)	LOW	64QAM	15.23	15.21	15.33	16.50	

FDD LTE Band 5 (Up Antenna)							
Bandwidth (MHz)	RB Set	RB offset	Modulation	Power (dBm)			
	Channel			20407	20525	20643	Tune up limit (dBm)
1.4 MHz	1 (RB_Pos:0)	LOW	QPSK	23.47	23.53	23.51	24.50
	1 (RB_Pos:3)	MIDDLE	QPSK	23.63	23.66	23.75	24.50
	1 (RB_Pos:5)	HIGH	QPSK	23.45	23.49	23.53	24.50
	3 (RB_Pos:0)	LOW	QPSK	23.59	23.67	23.60	24.50
	3 (RB_Pos:1)	MIDDLE	QPSK	23.65	23.69	23.65	24.50
	3 (RB_Pos:3)	HIGH	QPSK	23.60	23.70	23.64	24.50
	6 (RB_Pos:0)	LOW	QPSK	22.58	22.55	22.52	23.50
	1 (RB_Pos:0)	LOW	16QAM	22.56	22.92	22.48	23.50
	1 (RB_Pos:3)	MIDDLE	16QAM	22.75	23.06	22.62	23.50
	1 (RB_Pos:5)	HIGH	16QAM	22.56	22.96	22.44	23.50
	3 (RB_Pos:0)	LOW	16QAM	22.62	22.87	22.78	23.50
	3 (RB_Pos:1)	MIDDLE	16QAM	22.64	22.84	22.75	23.50
	3 (RB_Pos:3)	HIGH	16QAM	22.62	22.85	22.74	23.50
	6 (RB_Pos:0)	LOW	16QAM	21.74	21.53	21.73	22.50
	1 (RB_Pos:0)	LOW	64QAM	21.43	21.77	21.36	22.50

	1 (RB_Pos:3)	MIDDLE	64QAM	21.52	22.00	21.45	22.50
	1 (RB_Pos:5)	HIGH	64QAM	21.32	21.89	21.43	22.50
	3 (RB_Pos:0)	LOW	64QAM	21.59	21.90	21.41	22.50
	3 (RB_Pos:1)	MIDDLE	64QAM	21.55	21.49	21.47	22.50
	3 (RB_Pos:3)	HIGH	64QAM	21.25	21.52	21.76	22.50
	6 (RB_Pos:0)	LOW	64QAM	20.42	20.24	20.36	21.50
Bandwidth (MHz)	RB Set	RB offset	Modulation	Power (dBm)			
	Channel			20415	20525	20635	Tune up limit (dBm)
3 MHz	1 (RB_Pos:0)	LOW	QPSK	23.47	23.50	23.58	24.50
	1 (RB_Pos:8)	MIDDLE	QPSK	23.47	23.55	23.57	24.50
	1 (RB_Pos:14)	HIGH	QPSK	23.45	23.49	23.53	24.50
	8 (RB_Pos:0)	LOW	QPSK	22.48	22.52	22.54	23.50
	8 (RB_Pos:3)	MIDDLE	QPSK	22.53	22.54	22.57	23.50
	8 (RB_Pos:7)	HIGH	QPSK	22.49	22.50	22.49	23.50
	15 (RB_Pos:0)	LOW	QPSK	22.49	22.58	22.57	23.50
	1 (RB_Pos:0)	LOW	16QAM	22.41	22.86	22.55	23.50
	1 (RB_Pos:8)	MIDDLE	16QAM	22.42	22.95	22.48	23.50
	1 (RB_Pos:14)	HIGH	16QAM	22.41	22.90	22.42	23.50
	8 (RB_Pos:0)	LOW	16QAM	21.65	21.68	21.64	22.50
	8 (RB_Pos:3)	MIDDLE	16QAM	21.75	21.75	21.65	22.50
	8 (RB_Pos:7)	HIGH	16QAM	21.65	21.67	21.58	22.50
	15 (RB_Pos:0)	LOW	16QAM	21.58	21.68	21.52	22.50
	1 (RB_Pos:0)	LOW	64QAM	21.10	21.53	21.27	22.50
	1 (RB_Pos:8)	MIDDLE	64QAM	21.45	21.85	21.32	22.50
	1 (RB_Pos:14)	HIGH	64QAM	21.03	21.78	21.42	22.50
	8 (RB_Pos:0)	LOW	64QAM	20.65	20.57	20.41	21.50
	8 (RB_Pos:3)	MIDDLE	64QAM	20.74	20.37	20.68	21.50
	8 (RB_Pos:7)	HIGH	64QAM	20.68	20.29	20.24	21.50
15 (RB_Pos:0)	LOW	64QAM	20.37	20.54	20.41	21.50	
Bandwidth (MHz)	RB Set	RB offset	Modulation	Power (dBm)			
	Channel			20425	20525	20625	Tune up limit (dBm)
5 MHz	1 (RB_Pos:0)	LOW	QPSK	23.38	23.42	23.41	24.50
	1 (RB_Pos:13)	MIDDLE	QPSK	23.50	23.54	23.58	24.50
	1 (RB_Pos:24)	HIGH	QPSK	23.38	23.38	23.38	24.50
	12 (RB_Pos:0)	LOW	QPSK	22.47	22.57	22.51	23.50
	12 (RB_Pos:6)	MIDDLE	QPSK	22.56	22.61	22.58	23.50
	12 (RB_Pos:13)	HIGH	QPSK	22.51	22.53	22.45	23.50
	25 (RB_Pos:0)	LOW	QPSK	22.48	22.59	22.49	23.50
	1 (RB_Pos:0)	LOW	16QAM	22.55	22.92	22.45	23.50
	1 (RB_Pos:13)	MIDDLE	16QAM	22.70	23.12	22.60	23.50
	1 (RB_Pos:24)	HIGH	16QAM	22.54	22.95	22.44	23.50
	12 (RB_Pos:0)	LOW	16QAM	21.58	21.75	21.63	22.50
	12 (RB_Pos:6)	MIDDLE	16QAM	21.67	21.83	21.69	22.50

	12 (RB_Pos:13)	HIGH	16QAM	21.58	21.74	21.54	22.50
	25 (RB_Pos:0)	LOW	16QAM	21.60	21.76	21.52	22.50
	1 (RB_Pos:0)	LOW	64QAM	21.51	21.79	21.16	22.50
	1 (RB_Pos:13)	MIDDLE	64QAM	21.57	22.14	21.60	22.50
	1 (RB_Pos:24)	HIGH	64QAM	21.51	21.80	21.17	22.50
	12 (RB_Pos:0)	LOW	64QAM	20.55	20.39	20.37	21.50
	12 (RB_Pos:6)	MIDDLE	64QAM	20.42	20.48	20.68	21.50
	12 (RB_Pos:13)	HIGH	64QAM	20.45	20.37	20.20	21.50
	25 (RB_Pos:0)	LOW	64QAM	20.24	20.59	20.37	21.50
Bandwidth (MHz)	RB Set	RB offset	Modulation	Power (dBm)			
	Channel			20450	20525	20600	Tune up limit (dBm)
10 MHz	1 (RB_Pos:0)	LOW	QPSK	23.48	23.56	23.45	24.50
	1 (RB_Pos:25)	MIDDLE	QPSK	23.57	23.65	<b>23.80</b>	24.50
	1 (RB_Pos:49)	HIGH	QPSK	23.46	23.44	23.53	24.50
	25 (RB_Pos:0)	LOW	QPSK	22.50	22.51	22.64	23.50
	25 (RB_Pos:12)	MIDDLE	QPSK	22.51	22.53	22.62	23.50
	25 (RB_Pos:25)	HIGH	QPSK	22.44	22.52	22.67	23.50
	50 (RB_Pos:0)	LOW	QPSK	22.49	22.68	22.76	23.50
	1 (RB_Pos:0)	LOW	16QAM	22.40	22.82	22.56	23.50
	1 (RB_Pos:25)	MIDDLE	16QAM	22.54	23.06	22.67	23.50
	1 (RB_Pos:49)	HIGH	16QAM	22.37	22.87	22.42	23.50
	25 (RB_Pos:0)	LOW	16QAM	21.58	21.78	21.75	22.50
	25 (RB_Pos:12)	MIDDLE	16QAM	21.57	21.77	21.72	22.50
	25 (RB_Pos:25)	HIGH	16QAM	21.53	21.78	21.66	22.50
	50 (RB_Pos:0)	LOW	16QAM	21.51	21.78	21.69	22.50
	1 (RB_Pos:0)	LOW	64QAM	21.35	21.54	21.40	22.50
	1 (RB_Pos:25)	MIDDLE	64QAM	21.43	21.79	21.65	22.50
	1 (RB_Pos:49)	HIGH	64QAM	21.18	21.56	21.34	22.50
	25 (RB_Pos:0)	LOW	64QAM	20.36	20.53	20.68	21.50
	25 (RB_Pos:12)	MIDDLE	64QAM	20.19	20.39	20.54	21.50
	25 (RB_Pos:25)	HIGH	64QAM	20.39	20.50	20.56	21.50
50 (RB_Pos:0)	LOW	64QAM	20.18	20.49	20.36	21.50	

FDD LTE Band 7 (Up Antenna)							
Bandwidth (MHz)	RB Set	RB offset	Modulation	Power (dBm)			
	Channel			20775	21100	21425	Tune up limit (dBm)
5 MHz	1 (RB_Pos:0)	LOW	QPSK	15.76	15.79	15.81	17.00
	1 (RB_Pos:13)	MIDDLE	QPSK	15.85	15.87	15.95	17.00
	1 (RB_Pos:24)	HIGH	QPSK	15.77	15.77	15.84	17.00
	12 (RB_Pos:0)	LOW	QPSK	15.79	15.82	15.92	17.00
	12 (RB_Pos:6)	MIDDLE	QPSK	15.85	15.86	15.94	17.00
	12 (RB_Pos:13)	HIGH	QPSK	15.85	15.84	15.92	17.00
	25 (RB_Pos:0)	LOW	QPSK	15.79	15.82	15.94	17.00
	1 (RB_Pos:0)	LOW	16QAM	15.87	16.20	15.92	17.00
	1 (RB_Pos:13)	MIDDLE	16QAM	15.96	16.30	15.95	17.00
	1 (RB_Pos:24)	HIGH	16QAM	15.87	16.21	15.92	17.00
	12 (RB_Pos:0)	LOW	16QAM	15.76	15.90	15.86	17.00
	12 (RB_Pos:6)	MIDDLE	16QAM	15.82	15.93	15.90	17.00
	12 (RB_Pos:13)	HIGH	16QAM	15.82	15.89	15.88	17.00
	25 (RB_Pos:0)	LOW	16QAM	15.77	15.82	15.84	17.00
	1 (RB_Pos:0)	LOW	64QAM	15.90	15.84	15.71	17.00
	1 (RB_Pos:13)	MIDDLE	64QAM	15.90	16.04	15.89	17.00
	1 (RB_Pos:24)	HIGH	64QAM	15.85	15.97	15.73	17.00
	12 (RB_Pos:0)	LOW	64QAM	15.59	15.56	15.69	17.00
	12 (RB_Pos:6)	MIDDLE	64QAM	15.61	15.62	15.65	17.00
12 (RB_Pos:13)	HIGH	64QAM	15.57	15.86	15.87	17.00	
25 (RB_Pos:0)	LOW	64QAM	15.48	15.84	15.53	17.00	
Bandwidth (MHz)	RB Set	RB offset	Modulation	Power (dBm)			
	Channel			20800	21100	21400	Tune up limit (dBm)
10 MHz	1 (RB_Pos:0)	LOW	QPSK	15.85	15.86	15.93	17.00
	1 (RB_Pos:25)	MIDDLE	QPSK	15.98	15.96	16.07	17.00
	1 (RB_Pos:49)	HIGH	QPSK	15.82	15.82	15.96	17.00
	25 (RB_Pos:0)	LOW	QPSK	15.82	15.93	15.99	17.00
	25 (RB_Pos:12)	MIDDLE	QPSK	15.87	15.88	15.96	17.00
	25 (RB_Pos:25)	HIGH	QPSK	15.90	15.86	15.98	17.00
	50 (RB_Pos:0)	LOW	QPSK	15.86	15.86	15.95	17.00
	1 (RB_Pos:0)	LOW	16QAM	15.71	16.08	15.84	17.00
	1 (RB_Pos:25)	MIDDLE	16QAM	15.87	16.35	16.00	17.00
	1 (RB_Pos:49)	HIGH	16QAM	15.72	16.14	15.93	17.00
	25 (RB_Pos:0)	LOW	16QAM	15.79	15.84	15.99	17.00
	25 (RB_Pos:12)	MIDDLE	16QAM	15.86	15.85	16.04	17.00
	25 (RB_Pos:25)	HIGH	16QAM	15.89	15.84	16.04	17.00
	50 (RB_Pos:0)	LOW	16QAM	15.76	15.83	15.91	17.00
	1 (RB_Pos:0)	LOW	64QAM	15.68	16.04	15.82	17.00
1 (RB_Pos:25)	MIDDLE	64QAM	15.48	16.37	15.96	17.00	

Bandwidth (MHz)	RB Set	RB offset	Modulation	Power (dBm)			
	Channel			20825	21100	21375	Tune up limit (dBm)
	1 (RB_Pos:49)	HIGH	64QAM	15.34	15.83	15.56	17.00
	25 (RB_Pos:0)	LOW	64QAM	15.51	15.63	15.62	17.00
	25 (RB_Pos:12)	MIDDLE	64QAM	15.49	15.53	15.80	17.00
	25 (RB_Pos:25)	HIGH	64QAM	15.66	15.58	15.83	17.00
	50 (RB_Pos:0)	LOW	64QAM	15.66	15.86	15.73	17.00
15 MHz	1 (RB_Pos:0)	LOW	QPSK	15.78	15.82	15.87	17.00
	1 (RB_Pos:38)	MIDDLE	QPSK	15.85	15.92	15.98	17.00
	1 (RB_Pos:74)	HIGH	QPSK	15.74	15.77	15.91	17.00
	36 (RB_Pos:0)	LOW	QPSK	15.92	15.98	16.08	17.00
	36 (RB_Pos:20)	MIDDLE	QPSK	15.96	15.98	16.04	17.00
	36 (RB_Pos:39)	HIGH	QPSK	15.95	15.90	16.06	17.00
	75 (RB_Pos:0)	LOW	QPSK	15.94	15.93	16.06	17.00
	1 (RB_Pos:0)	LOW	16QAM	15.62	16.06	16.11	17.00
	1 (RB_Pos:38)	MIDDLE	16QAM	15.77	16.17	16.27	17.00
	1 (RB_Pos:74)	HIGH	16QAM	15.64	16.06	16.22	17.00
	36 (RB_Pos:0)	LOW	16QAM	15.79	15.92	15.93	17.00
	36 (RB_Pos:20)	MIDDLE	16QAM	15.88	15.93	15.91	17.00
	36 (RB_Pos:39)	HIGH	16QAM	15.90	15.94	15.97	17.00
	75 (RB_Pos:0)	LOW	16QAM	15.90	15.91	16.03	17.00
	1 (RB_Pos:0)	LOW	64QAM	15.50	15.74	15.78	17.00
	1 (RB_Pos:38)	MIDDLE	64QAM	15.78	15.83	16.09	17.00
	1 (RB_Pos:74)	HIGH	64QAM	15.47	16.04	15.93	17.00
	36 (RB_Pos:0)	LOW	64QAM	15.65	15.66	15.67	17.00
	36 (RB_Pos:20)	MIDDLE	64QAM	15.50	15.84	15.67	17.00
	36 (RB_Pos:39)	HIGH	64QAM	15.68	15.93	15.97	17.00
75 (RB_Pos:0)	LOW	64QAM	15.63	15.76	15.66	17.00	
Bandwidth (MHz)	RB Set	RB offset	Modulation	Power (dBm)			
	Channel			20850	21100	21350	Tune up limit (dBm)
20 MHz	1 (RB_Pos:0)	LOW	QPSK	15.74	15.98	15.74	17.00
	1 (RB_Pos:50)	MIDDLE	QPSK	16.01	<b>16.13</b>	16.09	17.00
	1 (RB_Pos:99)	HIGH	QPSK	15.73	15.89	15.80	17.00
	50 (RB_Pos:0)	LOW	QPSK	15.74	15.81	15.85	17.00
	50 (RB_Pos:25)	MIDDLE	QPSK	15.87	15.88	15.91	17.00
	50 (RB_Pos:50)	HIGH	QPSK	15.89	15.97	15.83	17.00
	100 (RB_Pos:0)	LOW	QPSK	15.79	15.86	15.95	17.00
	1 (RB_Pos:0)	LOW	16QAM	16.18	16.09	16.03	17.00
	1 (RB_Pos:50)	MIDDLE	16QAM	16.48	16.42	16.34	17.00
	1 (RB_Pos:99)	HIGH	16QAM	16.13	16.16	16.14	17.00
	50 (RB_Pos:0)	LOW	16QAM	15.70	15.83	15.84	17.00
	50 (RB_Pos:25)	MIDDLE	16QAM	15.84	15.84	15.83	17.00
	50 (RB_Pos:50)	HIGH	16QAM	15.82	15.79	15.77	17.00

	100 (RB_Pos:0)	LOW	16QAM	15.79	15.83	15.87	17.00
	1 (RB_Pos:0)	LOW	64QAM	16.01	15.96	16.01	17.00
	1 (RB_Pos:50)	MIDDLE	64QAM	16.49	16.11	16.00	17.00
	1 (RB_Pos:99)	HIGH	64QAM	15.98	15.81	15.75	17.00
	50 (RB_Pos:0)	LOW	64QAM	15.66	15.73	15.59	17.00
	50 (RB_Pos:25)	MIDDLE	64QAM	15.86	15.65	15.44	17.00
	50 (RB_Pos:50)	HIGH	64QAM	15.61	15.46	15.68	17.00
	100 (RB_Pos:0)	LOW	64QAM	15.51	15.70	15.88	17.00

FDD LTE Band 12 (Up Antenna)							
Bandwidth (MHz)	RB Set	RB offset	Modulation	Power (dBm)			
	Channel			23017	23095	23173	Tune up limit (dBm)
1.4 MHz	1 (RB_Pos:0)	LOW	QPSK	22.62	22.62	22.53	24.00
	1 (RB_Pos:3)	MIDDLE	QPSK	22.77	22.78	22.69	24.00
	1 (RB_Pos:5)	HIGH	QPSK	22.59	22.60	22.49	24.00
	3 (RB_Pos:0)	LOW	QPSK	22.66	22.64	22.60	24.00
	3 (RB_Pos:1)	MIDDLE	QPSK	22.67	22.71	22.63	24.00
	3 (RB_Pos:3)	HIGH	QPSK	22.67	22.66	22.63	24.00
	6 (RB_Pos:0)	LOW	QPSK	21.69	21.64	21.57	23.00
	1 (RB_Pos:0)	LOW	16QAM	21.72	21.93	21.52	23.00
	1 (RB_Pos:3)	MIDDLE	16QAM	21.88	22.10	21.69	23.00
	1 (RB_Pos:5)	HIGH	16QAM	21.69	21.90	21.56	23.00
	3 (RB_Pos:0)	LOW	16QAM	21.70	21.81	21.71	23.00
	3 (RB_Pos:1)	MIDDLE	16QAM	21.68	21.84	21.76	23.00
	3 (RB_Pos:3)	HIGH	16QAM	21.70	21.84	21.74	23.00
	6 (RB_Pos:0)	LOW	16QAM	20.82	20.55	20.73	22.00
	1 (RB_Pos:0)	LOW	64QAM	20.75	20.57	20.42	22.00
	1 (RB_Pos:3)	MIDDLE	64QAM	20.83	20.95	20.33	22.00
	1 (RB_Pos:5)	HIGH	64QAM	20.37	20.90	20.35	22.00
	3 (RB_Pos:0)	LOW	64QAM	20.67	20.63	20.32	22.00
	3 (RB_Pos:1)	MIDDLE	64QAM	20.46	20.48	20.71	22.00
	3 (RB_Pos:3)	HIGH	64QAM	20.58	20.60	20.53	22.00
6 (RB_Pos:0)	LOW	64QAM	19.82	19.50	19.52	21.00	
Bandwidth (MHz)	RB Set	RB offset	Modulation	Power (dBm)			
	Channel			23025	23095	23165	Tune up limit (dBm)
3 MHz	1 (RB_Pos:0)	LOW	QPSK	22.64	22.64	22.62	24.00
	1 (RB_Pos:8)	MIDDLE	QPSK	22.62	22.64	22.55	24.00
	1 (RB_Pos:14)	HIGH	QPSK	22.63	22.62	22.52	24.00
	8 (RB_Pos:0)	LOW	QPSK	21.66	21.63	21.67	23.00
	8 (RB_Pos:3)	MIDDLE	QPSK	21.74	21.68	21.65	23.00
	8 (RB_Pos:7)	HIGH	QPSK	21.66	21.63	21.57	23.00
	15 (RB_Pos:0)	LOW	QPSK	21.62	21.64	21.61	23.00



	1 (RB_Pos:0)	LOW	16QAM	21.60	21.98	21.57	23.00
	1 (RB_Pos:8)	MIDDLE	16QAM	21.50	21.97	21.52	23.00
	1 (RB_Pos:14)	HIGH	16QAM	21.51	21.96	21.59	23.00
	8 (RB_Pos:0)	LOW	16QAM	20.72	20.72	20.64	22.00
	8 (RB_Pos:3)	MIDDLE	16QAM	20.78	20.77	20.65	22.00
	8 (RB_Pos:7)	HIGH	16QAM	20.76	20.71	20.61	22.00
	15 (RB_Pos:0)	LOW	16QAM	20.62	20.65	20.53	22.00
	1 (RB_Pos:0)	LOW	64QAM	20.37	20.85	20.24	22.00
	1 (RB_Pos:8)	MIDDLE	64QAM	20.50	20.92	20.50	22.00
	1 (RB_Pos:14)	HIGH	64QAM	20.51	20.73	20.28	22.00
	8 (RB_Pos:0)	LOW	64QAM	19.59	19.61	19.61	21.00
	8 (RB_Pos:3)	MIDDLE	64QAM	19.49	19.59	19.67	21.00
	8 (RB_Pos:7)	HIGH	64QAM	19.71	19.39	19.34	21.00
	15 (RB_Pos:0)	LOW	64QAM	19.30	19.26	19.29	21.00
Bandwidth (MHz)	RB Set	RB offset	Modulation	Power (dBm)			
	Channel			23035	23095	23155	Tune up limit (dBm)
5 MHz	1 (RB_Pos:0)	LOW	QPSK	22.51	22.62	22.48	24.00
	1 (RB_Pos:13)	MIDDLE	QPSK	22.67	22.66	22.57	24.00
	1 (RB_Pos:24)	HIGH	QPSK	22.57	22.59	22.45	24.00
	12 (RB_Pos:0)	LOW	QPSK	21.56	21.63	21.54	23.00
	12 (RB_Pos:6)	MIDDLE	QPSK	21.68	21.70	21.67	23.00
	12 (RB_Pos:13)	HIGH	QPSK	21.54	21.63	21.47	23.00
	25 (RB_Pos:0)	LOW	QPSK	21.55	21.68	21.55	23.00
	1 (RB_Pos:0)	LOW	16QAM	21.70	22.05	21.57	23.00
	1 (RB_Pos:13)	MIDDLE	16QAM	21.77	22.12	21.65	23.00
	1 (RB_Pos:24)	HIGH	16QAM	21.68	22.03	21.57	23.00
	12 (RB_Pos:0)	LOW	16QAM	20.63	20.72	20.59	22.00
	12 (RB_Pos:6)	MIDDLE	16QAM	20.74	20.79	20.63	22.00
	12 (RB_Pos:13)	HIGH	16QAM	20.57	20.76	20.49	22.00
	25 (RB_Pos:0)	LOW	16QAM	20.55	20.74	20.50	22.00
	1 (RB_Pos:0)	LOW	64QAM	20.44	20.81	20.59	22.00
	1 (RB_Pos:13)	MIDDLE	64QAM	20.59	20.76	20.45	22.00
	1 (RB_Pos:24)	HIGH	64QAM	20.35	20.91	20.22	22.00
	12 (RB_Pos:0)	LOW	64QAM	19.30	19.45	19.44	21.00
	12 (RB_Pos:6)	MIDDLE	64QAM	19.57	19.61	19.64	21.00
	12 (RB_Pos:13)	HIGH	64QAM	19.18	19.43	19.50	21.00
25 (RB_Pos:0)	LOW	64QAM	19.43	19.45	19.41	21.00	
Bandwidth (MHz)	RB Set	RB offset	Modulation	Power (dBm)			
	Channel			23060	23095	23130	Tune up limit (dBm)
10 MHz	1 (RB_Pos:0)	LOW	QPSK	22.62	22.62	22.67	24.00
	1 (RB_Pos:25)	MIDDLE	QPSK	<b>22.84</b>	22.79	22.75	24.00
	1 (RB_Pos:49)	HIGH	QPSK	22.60	22.62	22.60	24.00
	25 (RB_Pos:0)	LOW	QPSK	21.77	21.76	21.57	23.00

25 (RB_Pos:12)	MIDDLE	QPSK	21.73	21.70	21.63	23.00
25 (RB_Pos:25)	HIGH	QPSK	21.68	21.71	21.49	23.00
50 (RB_Pos:0)	LOW	QPSK	21.78	21.74	21.60	23.00
1 (RB_Pos:0)	LOW	16QAM	21.54	21.91	21.64	23.00
1 (RB_Pos:25)	MIDDLE	16QAM	21.68	22.14	21.73	23.00
1 (RB_Pos:49)	HIGH	16QAM	21.60	21.93	21.55	23.00
25 (RB_Pos:0)	LOW	16QAM	20.73	20.78	20.68	22.00
25 (RB_Pos:12)	MIDDLE	16QAM	20.70	20.72	20.74	22.00
25 (RB_Pos:25)	HIGH	16QAM	20.69	20.80	20.55	22.00
50 (RB_Pos:0)	LOW	16QAM	20.69	20.82	20.58	22.00
1 (RB_Pos:0)	LOW	64QAM	20.54	20.92	20.65	22.00
1 (RB_Pos:25)	MIDDLE	64QAM	20.62	21.01	20.55	22.00
1 (RB_Pos:49)	HIGH	64QAM	20.53	20.71	20.20	22.00
25 (RB_Pos:0)	LOW	64QAM	19.58	19.53	19.65	21.00
25 (RB_Pos:12)	MIDDLE	64QAM	19.56	19.33	19.75	21.00
25 (RB_Pos:25)	HIGH	64QAM	19.41	19.59	19.53	21.00
50 (RB_Pos:0)	LOW	64QAM	19.56	19.71	19.40	21.00

FDD LTE Band 17 (Up Antenna)							
Bandwidth (MHz)	RB Set	RB offset	Modulation	Power (dBm)			
	Channel			23755	23790	23825	Tune up limit (dBm)
5 MHz	1 (RB_Pos:0)	LOW	QPSK	22.73	22.75	22.66	24.00
	1 (RB_Pos:13)	MIDDLE	QPSK	22.86	22.84	22.80	24.00
	1 (RB_Pos:24)	HIGH	QPSK	22.73	22.69	22.69	24.00
	12 (RB_Pos:0)	LOW	QPSK	21.85	21.75	21.73	23.00
	12 (RB_Pos:6)	MIDDLE	QPSK	21.83	21.84	21.80	23.00
	12 (RB_Pos:13)	HIGH	QPSK	21.87	21.82	21.69	23.00
	25 (RB_Pos:0)	LOW	QPSK	21.87	21.81	21.72	23.00
	1 (RB_Pos:0)	LOW	16QAM	21.84	22.20	21.77	23.00
	1 (RB_Pos:13)	MIDDLE	16QAM	22.01	22.33	21.84	23.00
	1 (RB_Pos:24)	HIGH	16QAM	21.91	22.13	21.77	23.00
	12 (RB_Pos:0)	LOW	16QAM	20.92	20.85	20.75	22.00
	12 (RB_Pos:6)	MIDDLE	16QAM	20.88	20.93	20.80	22.00
	12 (RB_Pos:13)	HIGH	16QAM	20.89	20.98	20.65	22.00
	25 (RB_Pos:0)	LOW	16QAM	20.83	20.84	20.67	22.00
	1 (RB_Pos:0)	LOW	64QAM	20.62	21.08	20.58	22.00
	1 (RB_Pos:13)	MIDDLE	64QAM	20.66	21.13	20.73	22.00
	1 (RB_Pos:24)	HIGH	64QAM	20.63	20.77	20.74	22.00
	12 (RB_Pos:0)	LOW	64QAM	19.59	19.57	19.65	21.00
	12 (RB_Pos:6)	MIDDLE	64QAM	19.88	19.61	19.83	21.00
	12 (RB_Pos:13)	HIGH	64QAM	19.76	19.63	19.67	21.00
25 (RB_Pos:0)	LOW	64QAM	19.82	19.66	19.50	21.00	
Bandwidth	RB Set	RB offset	Modulation	Power (dBm)			

(MHz)	Channel			23780	23790	23800	Tune up limit (dBm)
10 MHz	1 (RB_Pos:0)	LOW	QPSK	22.83	22.80	22.83	24.00
	1 (RB_Pos:25)	MIDDLE	QPSK	22.92	22.95	<b>22.97</b>	24.00
	1 (RB_Pos:49)	HIGH	QPSK	22.78	22.79	22.79	24.00
	25 (RB_Pos:0)	LOW	QPSK	21.73	21.82	21.86	23.00
	25 (RB_Pos:12)	MIDDLE	QPSK	21.81	21.77	21.84	23.00
	25 (RB_Pos:25)	HIGH	QPSK	21.69	21.76	21.88	23.00
	50 (RB_Pos:0)	LOW	QPSK	21.79	21.82	21.87	23.00
	1 (RB_Pos:0)	LOW	16QAM	21.67	22.08	21.75	23.00
	1 (RB_Pos:25)	MIDDLE	16QAM	21.83	22.23	21.89	23.00
	1 (RB_Pos:49)	HIGH	16QAM	21.60	22.02	21.71	23.00
	25 (RB_Pos:0)	LOW	16QAM	20.84	20.84	20.84	22.00
	25 (RB_Pos:12)	MIDDLE	16QAM	20.86	20.85	20.87	22.00
	25 (RB_Pos:25)	HIGH	16QAM	20.90	20.77	20.73	22.00
	50 (RB_Pos:0)	LOW	16QAM	20.86	20.79	20.71	22.00
	1 (RB_Pos:0)	LOW	64QAM	20.67	21.09	20.50	22.00
	1 (RB_Pos:25)	MIDDLE	64QAM	20.86	21.09	20.68	22.00
	1 (RB_Pos:49)	HIGH	64QAM	20.22	20.95	20.38	22.00
	25 (RB_Pos:0)	LOW	64QAM	19.53	19.60	19.62	21.00
	25 (RB_Pos:12)	MIDDLE	64QAM	19.84	19.70	19.50	21.00
	25 (RB_Pos:25)	HIGH	64QAM	19.71	19.42	19.64	21.00
50 (RB_Pos:0)	LOW	64QAM	19.72	19.62	19.60	21.00	

FDD LTE Band 66 (Up Antenna)							
Bandwidth (MHz)	RB Set	RB offset	Modulation	Power (dBm)			Tune up limit (dBm)
	Channel			131979	132322	132665	
1.4 MHz	1 (RB_Pos:0)	LOW	QPSK	14.34	14.32	14.33	15.50
	1 (RB_Pos:3)	MIDDLE	QPSK	14.48	14.50	14.50	15.50
	1 (RB_Pos:5)	HIGH	QPSK	14.29	14.31	14.31	15.50
	3 (RB_Pos:0)	LOW	QPSK	14.38	14.36	14.37	15.50
	3 (RB_Pos:1)	MIDDLE	QPSK	14.41	14.43	14.45	15.50
	3 (RB_Pos:3)	HIGH	QPSK	14.34	14.35	14.41	15.50
	6 (RB_Pos:0)	LOW	QPSK	14.39	14.41	14.32	15.50
	1 (RB_Pos:0)	LOW	16QAM	14.42	14.65	14.34	15.50
	1 (RB_Pos:3)	MIDDLE	16QAM	14.62	14.81	14.53	15.50
	1 (RB_Pos:5)	HIGH	16QAM	14.42	14.67	14.39	15.50
	3 (RB_Pos:0)	LOW	16QAM	14.42	14.53	14.57	15.50
	3 (RB_Pos:1)	MIDDLE	16QAM	14.43	14.56	14.63	15.50
	3 (RB_Pos:3)	HIGH	16QAM	14.38	14.54	14.61	15.50
	6 (RB_Pos:0)	LOW	16QAM	14.53	14.26	14.56	15.50
	1 (RB_Pos:0)	LOW	64QAM	14.07	14.50	13.99	15.50
	1 (RB_Pos:3)	MIDDLE	64QAM	14.56	14.60	14.52	15.50

Bandwidth (MHz)	RB Set	RB offset	Modulation	Power (dBm)			
	Channel			131987	132322	132657	Tune up limit (dBm)
	1 (RB_Pos:5)	HIGH	64QAM	14.29	14.54	14.10	15.50
	3 (RB_Pos:0)	LOW	64QAM	14.42	14.23	14.32	15.50
	3 (RB_Pos:1)	MIDDLE	64QAM	14.18	14.44	14.53	15.50
	3 (RB_Pos:3)	HIGH	64QAM	14.34	14.56	14.40	15.50
	6 (RB_Pos:0)	LOW	64QAM	14.27	14.23	14.57	15.50
3 MHz	1 (RB_Pos:0)	LOW	QPSK	14.39	14.39	14.43	15.50
	1 (RB_Pos:8)	MIDDLE	QPSK	14.36	14.42	14.42	15.50
	1 (RB_Pos:14)	HIGH	QPSK	14.38	14.40	14.42	15.50
	8 (RB_Pos:0)	LOW	QPSK	14.38	14.41	14.39	15.50
	8 (RB_Pos:3)	MIDDLE	QPSK	14.44	14.44	14.44	15.50
	8 (RB_Pos:7)	HIGH	QPSK	14.36	14.41	14.38	15.50
	15 (RB_Pos:0)	LOW	QPSK	14.34	14.38	14.41	15.50
	1 (RB_Pos:0)	LOW	16QAM	14.32	14.76	14.48	15.50
	1 (RB_Pos:8)	MIDDLE	16QAM	14.28	14.76	14.42	15.50
	1 (RB_Pos:14)	HIGH	16QAM	14.27	14.76	14.37	15.50
	8 (RB_Pos:0)	LOW	16QAM	14.50	14.48	14.46	15.50
	8 (RB_Pos:3)	MIDDLE	16QAM	14.52	14.52	14.54	15.50
	8 (RB_Pos:7)	HIGH	16QAM	14.46	14.46	14.47	15.50
	15 (RB_Pos:0)	LOW	16QAM	14.38	14.40	14.41	15.50
	1 (RB_Pos:0)	LOW	64QAM	14.35	14.47	14.29	15.50
	1 (RB_Pos:8)	MIDDLE	64QAM	14.00	14.38	14.31	15.50
	1 (RB_Pos:14)	HIGH	64QAM	14.30	14.73	14.11	15.50
	8 (RB_Pos:0)	LOW	64QAM	14.24	14.25	14.46	15.50
	8 (RB_Pos:3)	MIDDLE	64QAM	14.30	14.53	14.21	15.50
	8 (RB_Pos:7)	HIGH	64QAM	14.18	14.35	14.14	15.50
15 (RB_Pos:0)	LOW	64QAM	14.25	14.02	14.08	15.50	
Bandwidth (MHz)	RB Set	RB offset	Modulation	Power (dBm)			
	Channel			131997	132322	132647	Tune up limit (dBm)
5 MHz	1 (RB_Pos:0)	LOW	QPSK	14.32	14.30	14.25	15.50
	1 (RB_Pos:13)	MIDDLE	QPSK	14.38	14.45	14.44	15.50
	1 (RB_Pos:24)	HIGH	QPSK	14.25	14.31	14.27	15.50
	12 (RB_Pos:0)	LOW	QPSK	14.35	14.38	14.38	15.50
	12 (RB_Pos:6)	MIDDLE	QPSK	14.40	14.41	14.44	15.50
	12 (RB_Pos:13)	HIGH	QPSK	14.28	14.33	14.39	15.50
	25 (RB_Pos:0)	LOW	QPSK	14.37	14.36	14.35	15.50
	1 (RB_Pos:0)	LOW	16QAM	14.45	14.71	14.42	15.50
	1 (RB_Pos:13)	MIDDLE	16QAM	14.52	14.89	14.54	15.50
	1 (RB_Pos:24)	HIGH	16QAM	14.41	14.78	14.47	15.50
	12 (RB_Pos:0)	LOW	16QAM	14.43	14.47	14.42	15.50
	12 (RB_Pos:6)	MIDDLE	16QAM	14.45	14.55	14.48	15.50
	12 (RB_Pos:13)	HIGH	16QAM	14.38	14.48	14.44	15.50

	25 (RB_Pos:0)	LOW	16QAM	14.41	14.42	14.35	15.50
	1 (RB_Pos:0)	LOW	64QAM	14.07	14.61	14.17	15.50
	1 (RB_Pos:13)	MIDDLE	64QAM	14.27	14.51	14.39	15.50
	1 (RB_Pos:24)	HIGH	64QAM	14.44	14.55	14.48	15.50
	12 (RB_Pos:0)	LOW	64QAM	14.12	14.14	14.08	15.50
	12 (RB_Pos:6)	MIDDLE	64QAM	14.09	14.20	14.16	15.50
	12 (RB_Pos:13)	HIGH	64QAM	14.01	14.12	14.40	15.50
	25 (RB_Pos:0)	LOW	64QAM	14.20	14.25	14.05	15.50
Bandwidth (MHz)	RB Set	RB offset	Modulation	Power (dBm)			
	Channel			132022	132322	132622	Tune up limit (dBm)
10 MHz	1 (RB_Pos:0)	LOW	QPSK	14.36	14.37	14.38	15.50
	1 (RB_Pos:25)	MIDDLE	QPSK	14.51	14.68	14.60	15.50
	1 (RB_Pos:49)	HIGH	QPSK	14.37	14.38	14.41	15.50
	25 (RB_Pos:0)	LOW	QPSK	14.38	14.42	14.39	15.50
	25 (RB_Pos:12)	MIDDLE	QPSK	14.38	14.45	14.45	15.50
	25 (RB_Pos:25)	HIGH	QPSK	14.37	14.39	14.46	15.50
	50 (RB_Pos:0)	LOW	QPSK	14.38	14.37	14.46	15.50
	1 (RB_Pos:0)	LOW	16QAM	14.26	14.69	14.41	15.50
	1 (RB_Pos:25)	MIDDLE	16QAM	14.46	14.91	14.57	15.50
	1 (RB_Pos:49)	HIGH	16QAM	14.29	14.70	14.42	15.50
	25 (RB_Pos:0)	LOW	16QAM	14.42	14.49	14.54	15.50
	25 (RB_Pos:12)	MIDDLE	16QAM	14.39	14.49	14.53	15.50
	25 (RB_Pos:25)	HIGH	16QAM	14.43	14.39	14.60	15.50
	50 (RB_Pos:0)	LOW	16QAM	14.41	14.39	14.50	15.50
	1 (RB_Pos:0)	LOW	64QAM	14.01	14.45	14.19	15.50
	1 (RB_Pos:25)	MIDDLE	64QAM	14.37	14.66	14.30	15.50
	1 (RB_Pos:49)	HIGH	64QAM	14.20	14.33	14.17	15.50
	25 (RB_Pos:0)	LOW	64QAM	14.22	14.46	14.18	15.50
	25 (RB_Pos:12)	MIDDLE	64QAM	14.16	14.29	14.19	15.50
	25 (RB_Pos:25)	HIGH	64QAM	14.05	14.07	14.21	15.50
50 (RB_Pos:0)	LOW	64QAM	14.32	14.18	14.38	15.50	
Bandwidth (MHz)	RB Set	RB offset	Modulation	Power (dBm)			
	Channel			132047	132322	132597	Tune up limit (dBm)
15 MHz	1 (RB_Pos:0)	LOW	QPSK	14.34	14.30	14.34	15.50
	1 (RB_Pos:38)	MIDDLE	QPSK	14.32	14.43	14.48	15.50
	1 (RB_Pos:74)	HIGH	QPSK	14.30	14.33	14.37	15.50
	36 (RB_Pos:0)	LOW	QPSK	14.45	14.47	14.45	15.50
	36 (RB_Pos:20)	MIDDLE	QPSK	14.44	14.51	14.49	15.50
	36 (RB_Pos:39)	HIGH	QPSK	14.47	14.43	14.52	15.50
	75 (RB_Pos:0)	LOW	QPSK	14.47	14.47	14.46	15.50
	1 (RB_Pos:0)	LOW	16QAM	14.24	14.72	14.79	15.50
	1 (RB_Pos:38)	MIDDLE	16QAM	14.28	14.78	14.94	15.50
	1 (RB_Pos:74)	HIGH	16QAM	14.27	14.67	14.83	15.50

	36 (RB_Pos:0)	LOW	16QAM	14.36	14.45	14.44	15.50
	36 (RB_Pos:20)	MIDDLE	16QAM	14.38	14.48	14.47	15.50
	36 (RB_Pos:39)	HIGH	16QAM	14.39	14.43	14.46	15.50
	75 (RB_Pos:0)	LOW	16QAM	14.36	14.43	14.45	15.50
	1 (RB_Pos:0)	LOW	64QAM	13.88	14.43	14.72	15.50
	1 (RB_Pos:38)	MIDDLE	64QAM	14.04	14.48	14.88	15.50
	1 (RB_Pos:74)	HIGH	64QAM	14.24	14.46	14.54	15.50
	36 (RB_Pos:0)	LOW	64QAM	14.08	14.24	14.28	15.50
	36 (RB_Pos:20)	MIDDLE	64QAM	14.39	14.33	14.08	15.50
	36 (RB_Pos:39)	HIGH	64QAM	14.06	14.19	14.45	15.50
	75 (RB_Pos:0)	LOW	64QAM	14.02	14.28	14.41	15.50
Bandwidth (MHz)	RB Set	RB offset	Modulation	Power (dBm)			
	Channel			132072	132322	132572	Tune up limit (dBm)
20 MHz	1 (RB_Pos:0)	LOW	QPSK	14.26	14.31	14.24	15.50
	1 (RB_Pos:50)	MIDDLE	QPSK	14.53	<b>14.69</b>	14.58	15.50
	1 (RB_Pos:99)	HIGH	QPSK	14.31	14.36	14.29	15.50
	50 (RB_Pos:0)	LOW	QPSK	14.31	14.27	14.39	15.50
	50 (RB_Pos:25)	MIDDLE	QPSK	14.34	14.37	14.43	15.50
	50 (RB_Pos:50)	HIGH	QPSK	14.41	14.46	14.40	15.50
	100 (RB_Pos:0)	LOW	QPSK	14.34	14.40	14.40	15.50
	1 (RB_Pos:0)	LOW	16QAM	14.66	14.78	14.62	15.50
	1 (RB_Pos:50)	MIDDLE	16QAM	14.94	15.02	15.00	15.50
	1 (RB_Pos:99)	HIGH	16QAM	14.73	14.76	14.71	15.50
	50 (RB_Pos:0)	LOW	16QAM	14.37	14.42	14.46	15.50
	50 (RB_Pos:25)	MIDDLE	16QAM	14.39	14.39	14.43	15.50
	50 (RB_Pos:50)	HIGH	16QAM	14.46	14.29	14.39	15.50
	100 (RB_Pos:0)	LOW	16QAM	14.45	14.34	14.43	15.50
	1 (RB_Pos:0)	LOW	64QAM	14.70	14.59	14.34	15.50
	1 (RB_Pos:50)	MIDDLE	64QAM	14.86	14.88	14.78	15.50
	1 (RB_Pos:99)	HIGH	64QAM	14.72	14.66	14.49	15.50
	50 (RB_Pos:0)	LOW	64QAM	14.12	14.44	14.19	15.50
	50 (RB_Pos:25)	MIDDLE	64QAM	14.28	14.07	14.28	15.50
	50 (RB_Pos:50)	HIGH	64QAM	14.47	14.04	14.05	15.50
100 (RB_Pos:0)	LOW	64QAM	14.35	14.36	14.17	15.50	

TDD LTE Band 38 (Up Antenna)							
Bandwidth (MHz)	RB Set	RB offset	Modulation	Power (dBm)			
	Channel			37775	38000	38225	Tune up limit (dBm)
5 MHz	1 (RB_Pos:0)	LOW	QPSK	18.34	18.33	18.29	19.50
	1 (RB_Pos:13)	MIDDLE	QPSK	18.44	18.47	18.41	19.50
	1 (RB_Pos:24)	HIGH	QPSK	18.27	18.32	18.27	19.50
	12 (RB_Pos:0)	LOW	QPSK	18.42	18.36	18.37	19.50
	12 (RB_Pos:6)	MIDDLE	QPSK	18.43	18.43	18.43	19.50
	12 (RB_Pos:13)	HIGH	QPSK	18.39	18.37	18.34	19.50
	25 (RB_Pos:0)	LOW	QPSK	18.37	18.39	18.32	19.50
	1 (RB_Pos:0)	LOW	16QAM	18.66	18.74	18.55	19.50
	1 (RB_Pos:13)	MIDDLE	16QAM	18.76	18.86	18.69	19.50
	1 (RB_Pos:24)	HIGH	16QAM	18.61	18.71	18.54	19.50
	12 (RB_Pos:0)	LOW	16QAM	18.39	18.47	18.41	19.50
	12 (RB_Pos:6)	MIDDLE	16QAM	18.48	18.56	18.50	19.50
	12 (RB_Pos:13)	HIGH	16QAM	18.42	18.49	18.42	19.50
	25 (RB_Pos:0)	LOW	16QAM	18.44	18.45	18.39	19.50
	1 (RB_Pos:0)	LOW	64QAM	18.40	18.55	18.27	19.50
	1 (RB_Pos:13)	MIDDLE	64QAM	18.71	18.65	18.60	19.50
	1 (RB_Pos:24)	HIGH	64QAM	18.30	18.56	18.46	19.50
	12 (RB_Pos:0)	LOW	64QAM	18.08	18.21	18.02	19.50
	12 (RB_Pos:6)	MIDDLE	64QAM	18.44	18.59	18.47	19.50
12 (RB_Pos:13)	HIGH	64QAM	18.31	18.37	18.35	19.50	
25 (RB_Pos:0)	LOW	64QAM	18.25	18.48	18.15	19.50	
Bandwidth (MHz)	RB Set	RB offset	Modulation	Power (dBm)			
	Channel			37800	38000	38200	Tune up limit (dBm)
10 MHz	1 (RB_Pos:0)	LOW	QPSK	18.42	18.43	18.39	19.50
	1 (RB_Pos:25)	MIDDLE	QPSK	18.68	18.74	18.74	19.50
	1 (RB_Pos:49)	HIGH	QPSK	18.37	18.42	18.41	19.50
	25 (RB_Pos:0)	LOW	QPSK	18.46	18.45	18.45	19.50
	25 (RB_Pos:12)	MIDDLE	QPSK	18.41	18.45	18.48	19.50
	25 (RB_Pos:25)	HIGH	QPSK	18.40	18.46	18.46	19.50
	50 (RB_Pos:0)	LOW	QPSK	18.39	18.42	18.42	19.50
	1 (RB_Pos:0)	LOW	16QAM	18.70	18.87	18.80	19.50
	1 (RB_Pos:25)	MIDDLE	16QAM	18.97	19.17	19.14	19.50
	1 (RB_Pos:49)	HIGH	16QAM	18.67	18.86	18.81	19.50
	25 (RB_Pos:0)	LOW	16QAM	18.51	18.52	18.51	19.50
	25 (RB_Pos:12)	MIDDLE	16QAM	18.47	18.51	18.56	19.50
	25 (RB_Pos:25)	HIGH	16QAM	18.50	18.51	18.51	19.50
	50 (RB_Pos:0)	LOW	16QAM	18.48	18.48	18.52	19.50
	1 (RB_Pos:0)	LOW	64QAM	18.54	18.80	18.70	19.50
	1 (RB_Pos:25)	MIDDLE	64QAM	18.98	18.96	18.91	19.50

Bandwidth (MHz)	RB Set	RB offset	Modulation	Power (dBm)			
	Channel			37825	38000	38175	Tune up limit (dBm)
	1 (RB_Pos:49)	HIGH	64QAM	18.55	18.62	18.73	19.50
	25 (RB_Pos:0)	LOW	64QAM	18.28	18.40	18.24	19.50
	25 (RB_Pos:12)	MIDDLE	64QAM	18.15	18.44	18.44	19.50
	25 (RB_Pos:25)	HIGH	64QAM	18.18	18.36	18.20	19.50
	50 (RB_Pos:0)	LOW	64QAM	18.24	18.19	18.33	19.50
15 MHz	1 (RB_Pos:0)	LOW	QPSK	18.39	18.35	18.33	19.50
	1 (RB_Pos:38)	MIDDLE	QPSK	18.41	18.44	18.45	19.50
	1 (RB_Pos:74)	HIGH	QPSK	18.30	18.34	18.28	19.50
	36 (RB_Pos:0)	LOW	QPSK	18.39	18.44	18.42	19.50
	36 (RB_Pos:20)	MIDDLE	QPSK	18.42	18.43	18.42	19.50
	36 (RB_Pos:39)	HIGH	QPSK	18.38	18.39	18.41	19.50
	75 (RB_Pos:0)	LOW	QPSK	18.39	18.47	18.42	19.50
	1 (RB_Pos:0)	LOW	16QAM	18.64	18.83	18.69	19.50
	1 (RB_Pos:38)	MIDDLE	16QAM	18.70	18.91	18.75	19.50
	1 (RB_Pos:74)	HIGH	16QAM	18.59	18.76	18.60	19.50
	36 (RB_Pos:0)	LOW	16QAM	18.34	18.37	18.39	19.50
	36 (RB_Pos:20)	MIDDLE	16QAM	18.36	18.39	18.44	19.50
	36 (RB_Pos:39)	HIGH	16QAM	18.33	18.33	18.39	19.50
	75 (RB_Pos:0)	LOW	16QAM	18.39	18.40	18.39	19.50
	1 (RB_Pos:0)	LOW	64QAM	18.62	18.73	18.66	19.50
	1 (RB_Pos:38)	MIDDLE	64QAM	18.71	18.52	18.41	19.50
	1 (RB_Pos:74)	HIGH	64QAM	18.51	18.73	18.35	19.50
	36 (RB_Pos:0)	LOW	64QAM	18.20	18.39	18.11	19.50
	36 (RB_Pos:20)	MIDDLE	64QAM	18.13	18.20	18.46	19.50
	36 (RB_Pos:39)	HIGH	64QAM	17.98	18.26	18.25	19.50
75 (RB_Pos:0)	LOW	64QAM	18.04	18.43	18.27	19.50	
Bandwidth (MHz)	RB Set	RB offset	Modulation	Power (dBm)			
	Channel			37850	38000	38150	Tune up limit (dBm)
20 MHz	1 (RB_Pos:0)	LOW	QPSK	18.27	18.26	18.34	19.50
	1 (RB_Pos:50)	MIDDLE	QPSK	18.61	18.63	<b>18.75</b>	19.50
	1 (RB_Pos:99)	HIGH	QPSK	18.23	18.26	18.31	19.50
	50 (RB_Pos:0)	LOW	QPSK	18.33	18.37	18.37	19.50
	50 (RB_Pos:25)	MIDDLE	QPSK	18.37	18.40	18.42	19.50
	50 (RB_Pos:50)	HIGH	QPSK	18.33	18.35	18.33	19.50
	100 (RB_Pos:0)	LOW	QPSK	18.35	18.34	18.36	19.50
	1 (RB_Pos:0)	LOW	16QAM	18.59	18.50	18.71	19.50
	1 (RB_Pos:50)	MIDDLE	16QAM	18.96	18.88	19.05	19.50
	1 (RB_Pos:99)	HIGH	16QAM	18.57	18.49	18.69	19.50
	50 (RB_Pos:0)	LOW	16QAM	18.37	18.45	18.43	19.50
	50 (RB_Pos:25)	MIDDLE	16QAM	18.43	18.46	18.49	19.50
	50 (RB_Pos:50)	HIGH	16QAM	18.38	18.36	18.44	19.50



	100 (RB_Pos:0)	LOW	16QAM	18.38	18.39	18.41	19.50
	1 (RB_Pos:0)	LOW	64QAM	18.24	18.13	18.46	19.50
	1 (RB_Pos:50)	MIDDLE	64QAM	18.59	18.87	18.75	19.50
	1 (RB_Pos:99)	HIGH	64QAM	18.24	18.43	18.69	19.50
	50 (RB_Pos:0)	LOW	64QAM	18.39	18.41	18.28	19.50
	50 (RB_Pos:25)	MIDDLE	64QAM	18.43	18.43	18.34	19.50
	50 (RB_Pos:50)	HIGH	64QAM	18.12	18.33	18.35	19.50
	100 (RB_Pos:0)	LOW	64QAM	18.35	18.20	18.43	19.50

TDD LTE Band 41 (Up Antenna)									
Bandwidth (MHz)	RB Set	RB offset	Modulation	Power (dBm)					Tune up limit (dBm)
	Channel			39675	40110	40620	41130	41565	
5 MHz	1 (RB_Pos:0)	LOW	QPSK	18.21	18.09	18.35	18.05	18.25	19.50
	1 (RB_Pos:13)	MIDDLE	QPSK	18.35	18.36	18.47	18.41	18.40	19.50
	1 (RB_Pos:24)	HIGH	QPSK	18.22	18.09	18.33	18.11	18.21	19.50
	12 (RB_Pos:0)	LOW	QPSK	18.30	18.16	18.42	18.29	18.30	19.50
	12 (RB_Pos:6)	MIDDLE	QPSK	18.35	18.41	18.50	18.20	18.39	19.50
	12 (RB_Pos:13)	HIGH	QPSK	18.32	18.13	18.43	18.22	18.34	19.50
	25 (RB_Pos:0)	LOW	QPSK	18.29	18.15	18.47	18.30	18.33	19.50
	1 (RB_Pos:0)	LOW	16QAM	18.33	18.13	18.61	18.44	18.61	19.50
	1 (RB_Pos:13)	MIDDLE	16QAM	18.48	18.42	18.74	18.75	18.73	19.50
	1 (RB_Pos:24)	HIGH	16QAM	18.36	18.30	18.63	18.60	18.58	19.50
	12 (RB_Pos:0)	LOW	16QAM	18.23	18.21	18.39	18.33	18.40	19.50
	12 (RB_Pos:6)	MIDDLE	16QAM	18.27	18.17	18.47	18.31	18.45	19.50
	12 (RB_Pos:13)	HIGH	16QAM	18.22	18.22	18.36	18.22	18.39	19.50
	25 (RB_Pos:0)	LOW	16QAM	18.20	18.22	18.43	18.30	18.33	19.50
	1 (RB_Pos:0)	LOW	64QAM	17.97	18.10	18.27	18.34	18.37	19.50
	1 (RB_Pos:13)	MIDDLE	64QAM	18.29	18.34	18.60	18.69	18.39	19.50
	1 (RB_Pos:24)	HIGH	64QAM	18.35	18.18	18.43	18.53	18.50	19.50
	12 (RB_Pos:0)	LOW	64QAM	18.11	18.15	18.13	18.03	18.40	19.50
12 (RB_Pos:6)	MIDDLE	64QAM	17.90	17.89	18.27	17.92	18.15	19.50	
12 (RB_Pos:13)	HIGH	64QAM	17.94	18.21	18.25	17.86	18.05	19.50	
25 (RB_Pos:0)	LOW	64QAM	17.82	18.08	18.25	18.05	18.29	19.50	
Bandwidth (MHz)	RB Set	RB offset	Modulation	Power (dBm)					Tune up limit (dBm)
	Channel			39700	40135	40620	41105	41540	
10 MHz	1 (RB_Pos:0)	LOW	QPSK	18.27	18.22	18.47	18.16	18.34	19.50
	1 (RB_Pos:25)	MIDDLE	QPSK	18.54	18.57	18.65	18.54	18.67	19.50
	1 (RB_Pos:49)	HIGH	QPSK	18.26	18.28	18.46	18.17	18.31	19.50
	25 (RB_Pos:0)	LOW	QPSK	18.31	18.15	18.50	18.16	18.32	19.50
	25 (RB_Pos:12)	MIDDLE	QPSK	18.29	18.11	18.42	18.26	18.37	19.50

	25 (RB_Pos:25)	HIGH	QPSK	18.30	18.17	18.47	18.43	18.35	19.50
	50 (RB_Pos:0)	LOW	QPSK	18.24	18.29	18.42	18.22	18.32	19.50
	1 (RB_Pos:0)	LOW	16QAM	18.45	18.32	18.83	18.55	18.65	19.50
	1 (RB_Pos:25)	MIDDLE	16QAM	18.73	18.64	19.11	18.83	18.97	19.50
	1 (RB_Pos:49)	HIGH	16QAM	18.49	18.58	18.83	18.62	18.65	19.50
	25 (RB_Pos:0)	LOW	16QAM	18.25	18.31	18.43	18.49	18.41	19.50
	25 (RB_Pos:12)	MIDDLE	16QAM	18.27	18.23	18.47	18.44	18.35	19.50
	25 (RB_Pos:25)	HIGH	16QAM	18.29	18.38	18.50	18.19	18.39	19.50
	50 (RB_Pos:0)	LOW	16QAM	18.23	18.22	18.44	18.43	18.34	19.50
	1 (RB_Pos:0)	LOW	64QAM	18.28	18.15	18.81	18.23	18.48	19.50
	1 (RB_Pos:25)	MIDDLE	64QAM	18.34	18.28	18.81	18.74	18.75	19.50
	1 (RB_Pos:49)	HIGH	64QAM	18.19	18.39	18.81	18.49	18.54	19.50
	25 (RB_Pos:0)	LOW	64QAM	17.90	18.00	18.07	18.14	18.05	19.50
	25 (RB_Pos:12)	MIDDLE	64QAM	18.16	18.21	18.22	18.45	18.12	19.50
	25 (RB_Pos:25)	HIGH	64QAM	18.19	18.09	18.33	17.94	18.16	19.50
	50 (RB_Pos:0)	LOW	64QAM	18.07	18.19	18.43	18.05	18.08	19.50
Bandwidth (MHz)	RB Set	RB offset	Modulation	Power (dBm)					Tune up limit (dBm)
	Channel			39725	40160	40620	41080	41515	
15 MHz	1 (RB_Pos:0)	LOW	QPSK	18.29	18.35	18.40	18.40	18.32	19.50
	1 (RB_Pos:38)	MIDDLE	QPSK	18.31	18.34	18.50	18.31	18.37	19.50
	1 (RB_Pos:74)	HIGH	QPSK	18.19	18.26	18.40	18.11	18.21	19.50
	36 (RB_Pos:0)	LOW	QPSK	18.36	18.24	18.47	18.31	18.36	19.50
	36 (RB_Pos:20)	MIDDLE	QPSK	18.39	18.48	18.49	18.40	18.41	19.50
	36 (RB_Pos:39)	HIGH	QPSK	18.37	18.40	18.46	18.22	18.35	19.50
	75 (RB_Pos:0)	LOW	QPSK	18.36	18.45	18.49	18.39	18.39	19.50
	1 (RB_Pos:0)	LOW	16QAM	18.40	18.46	18.79	18.43	18.57	19.50
	1 (RB_Pos:38)	MIDDLE	16QAM	18.51	18.49	18.87	18.57	18.65	19.50
	1 (RB_Pos:74)	HIGH	16QAM	18.39	18.23	18.77	18.49	18.49	19.50
	36 (RB_Pos:0)	LOW	16QAM	18.25	18.29	18.44	18.37	18.36	19.50
	36 (RB_Pos:20)	MIDDLE	16QAM	18.29	18.35	18.42	18.24	18.37	19.50
	36 (RB_Pos:39)	HIGH	16QAM	18.27	18.35	18.42	18.42	18.34	19.50
	75 (RB_Pos:0)	LOW	16QAM	18.31	18.24	18.47	18.28	18.37	19.50
	1 (RB_Pos:0)	LOW	64QAM	18.31	18.47	18.50	18.27	18.56	19.50
	1 (RB_Pos:38)	MIDDLE	64QAM	18.47	18.29	18.51	18.52	18.37	19.50
	1 (RB_Pos:74)	HIGH	64QAM	18.28	18.24	18.75	18.28	18.51	19.50
	36 (RB_Pos:0)	LOW	64QAM	17.95	18.14	18.36	18.04	18.20	19.50
	36 (RB_Pos:20)	MIDDLE	64QAM	17.92	18.24	18.39	18.26	18.17	19.50
36 (RB_Pos:39)	HIGH	64QAM	18.22	18.20	18.11	18.36	18.19	19.50	
75 (RB_Pos:0)	LOW	64QAM	18.22	17.90	18.47	17.97	18.07	19.50	
Bandwidth (MHz)	RB Set	RB offset	Modulation	Power (dBm)					Tune up limit (dBm)
	Channel			39750	40185	40620	41055	41490	

20 MHz	1 (RB_Pos:0)	LOW	QPSK	18.26	18.10	18.32	18.19	18.35	19.50
	1 (RB_Pos:50)	MIDDLE	QPSK	18.54	18.62	<b>18.76</b>	18.55	18.64	19.50
	1 (RB_Pos:99)	HIGH	QPSK	18.19	18.26	18.35	18.23	18.24	19.50
	50 (RB_Pos:0)	LOW	QPSK	18.23	18.03	18.41	18.21	18.28	19.50
	50 (RB_Pos:25)	MIDDLE	QPSK	18.29	18.23	18.44	18.31	18.35	19.50
	50 (RB_Pos:50)	HIGH	QPSK	18.24	18.09	18.39	18.32	18.28	19.50
	100 (RB_Pos:0)	LOW	QPSK	18.25	18.11	18.37	18.18	18.30	19.50
	1 (RB_Pos:0)	LOW	16QAM	18.41	18.48	18.48	18.57	18.60	19.50
	1 (RB_Pos:50)	MIDDLE	16QAM	18.75	18.74	18.85	18.84	18.95	19.50
	1 (RB_Pos:99)	HIGH	16QAM	18.42	18.35	18.50	18.38	18.57	19.50
	50 (RB_Pos:0)	LOW	16QAM	18.13	18.09	18.41	18.20	18.31	19.50
	50 (RB_Pos:25)	MIDDLE	16QAM	18.19	18.05	18.41	18.30	18.35	19.50
	50 (RB_Pos:50)	HIGH	16QAM	18.21	18.27	18.37	18.36	18.30	19.50
	100 (RB_Pos:0)	LOW	16QAM	18.19	18.00	18.41	18.28	18.30	19.50
	1 (RB_Pos:0)	LOW	64QAM	18.29	18.40	18.29	18.32	18.49	19.50
	1 (RB_Pos:50)	MIDDLE	64QAM	18.56	18.51	18.70	18.87	18.62	19.50
	1 (RB_Pos:99)	HIGH	64QAM	18.17	18.28	18.43	18.35	18.27	19.50
	50 (RB_Pos:0)	LOW	64QAM	18.00	17.92	18.22	17.97	18.33	19.50
	50 (RB_Pos:25)	MIDDLE	64QAM	18.14	18.06	18.18	18.03	18.20	19.50
	50 (RB_Pos:50)	HIGH	64QAM	17.89	17.88	18.35	18.31	18.09	19.50
100 (RB_Pos:0)	LOW	64QAM	18.22	17.68	18.10	17.96	18.00	19.50	

FDD LTE Band 2 (Down Antenna)							
Bandwidth (MHz)	RB Set	RB offset	Modulation	Power (dBm)			
	Channel			18607	18900	19193	Tune up limit (dBm)
1.4 MHz	1 (RB_Pos:0)	LOW	QPSK	23.07	23.02	23.02	23.80
	1 (RB_Pos:3)	MIDDLE	QPSK	23.19	23.14	23.19	23.80
	1 (RB_Pos:5)	HIGH	QPSK	23.02	22.99	23.03	23.80
	3 (RB_Pos:0)	LOW	QPSK	23.14	23.12	23.26	23.80
	3 (RB_Pos:1)	MIDDLE	QPSK	23.16	23.18	23.28	23.80
	3 (RB_Pos:3)	HIGH	QPSK	23.14	23.13	23.25	23.80
	6 (RB_Pos:0)	LOW	QPSK	22.13	22.03	22.08	22.80
	1 (RB_Pos:0)	LOW	16QAM	22.19	22.46	22.09	22.80
	1 (RB_Pos:3)	MIDDLE	16QAM	22.30	22.52	22.24	22.80
	1 (RB_Pos:5)	HIGH	16QAM	22.21	22.46	22.12	22.80
	3 (RB_Pos:0)	LOW	16QAM	22.17	22.35	22.47	22.80
	3 (RB_Pos:1)	MIDDLE	16QAM	22.21	22.35	22.40	22.80
	3 (RB_Pos:3)	HIGH	16QAM	22.24	22.37	22.43	22.80
	6 (RB_Pos:0)	LOW	16QAM	21.29	21.00	21.32	21.80
	1 (RB_Pos:0)	LOW	64QAM	20.97	21.33	21.04	21.80
	1 (RB_Pos:3)	MIDDLE	64QAM	21.07	21.19	21.12	21.80
	1 (RB_Pos:5)	HIGH	64QAM	21.01	21.20	21.12	21.80
	3 (RB_Pos:0)	LOW	64QAM	20.94	21.19	21.20	21.80
	3 (RB_Pos:1)	MIDDLE	64QAM	20.99	21.11	21.04	21.80
3 (RB_Pos:3)	HIGH	64QAM	21.01	21.10	21.44	21.80	
6 (RB_Pos:0)	LOW	64QAM	20.06	19.99	20.13	20.80	
Bandwidth (MHz)	RB Set	RB offset	Modulation	Power (dBm)			
	Channel			18615	18900	19185	Tune up limit (dBm)
3 MHz	1 (RB_Pos:0)	LOW	QPSK	23.14	23.10	23.11	23.80
	1 (RB_Pos:8)	MIDDLE	QPSK	23.14	23.06	23.16	23.80
	1 (RB_Pos:14)	HIGH	QPSK	23.08	23.04	23.13	23.80
	8 (RB_Pos:0)	LOW	QPSK	22.18	22.06	22.14	22.80
	8 (RB_Pos:3)	MIDDLE	QPSK	22.22	22.13	22.18	22.80
	8 (RB_Pos:7)	HIGH	QPSK	22.16	22.06	22.10	22.80
	15 (RB_Pos:0)	LOW	QPSK	22.19	22.08	22.16	22.80
	1 (RB_Pos:0)	LOW	16QAM	22.11	22.45	22.17	22.80
	1 (RB_Pos:8)	MIDDLE	16QAM	22.05	22.50	22.18	22.80
	1 (RB_Pos:14)	HIGH	16QAM	22.08	22.50	22.08	22.80
	8 (RB_Pos:0)	LOW	16QAM	21.30	21.22	21.19	21.80
	8 (RB_Pos:3)	MIDDLE	16QAM	21.32	21.27	21.27	21.80
	8 (RB_Pos:7)	HIGH	16QAM	21.26	21.17	21.21	21.80
	15 (RB_Pos:0)	LOW	16QAM	21.19	21.16	21.20	21.80
	1 (RB_Pos:0)	LOW	64QAM	20.88	21.16	21.08	21.80
	1 (RB_Pos:8)	MIDDLE	64QAM	21.00	21.38	20.93	21.80

Bandwidth (MHz)	RB Set	RB offset	Modulation	Power (dBm)			
	Channel			18625	18900	19175	Tune up limit (dBm)
	1 (RB_Pos:14)	HIGH	64QAM	20.93	21.21	20.74	21.80
	8 (RB_Pos:0)	LOW	64QAM	20.09	20.16	19.84	20.80
	8 (RB_Pos:3)	MIDDLE	64QAM	20.30	20.17	20.27	20.80
	8 (RB_Pos:7)	HIGH	64QAM	20.04	20.03	20.06	20.80
	15 (RB_Pos:0)	LOW	64QAM	19.86	20.05	20.11	20.80
5 MHz	1 (RB_Pos:0)	LOW	QPSK	23.05	22.97	22.97	23.80
	1 (RB_Pos:13)	MIDDLE	QPSK	23.20	23.14	23.18	23.80
	1 (RB_Pos:24)	HIGH	QPSK	23.07	23.00	22.98	23.80
	12 (RB_Pos:0)	LOW	QPSK	22.11	22.10	22.17	22.80
	12 (RB_Pos:6)	MIDDLE	QPSK	22.22	22.15	22.22	22.80
	12 (RB_Pos:13)	HIGH	QPSK	22.18	22.13	22.15	22.80
	25 (RB_Pos:0)	LOW	QPSK	22.17	22.10	22.10	22.80
	1 (RB_Pos:0)	LOW	16QAM	22.22	22.54	22.06	22.80
	1 (RB_Pos:13)	MIDDLE	16QAM	22.35	22.65	22.21	22.80
	1 (RB_Pos:24)	HIGH	16QAM	22.22	22.49	22.10	22.80
	12 (RB_Pos:0)	LOW	16QAM	21.23	21.21	21.20	21.80
	12 (RB_Pos:6)	MIDDLE	16QAM	21.29	21.35	21.32	21.80
	12 (RB_Pos:13)	HIGH	16QAM	21.23	21.27	21.24	21.80
	25 (RB_Pos:0)	LOW	16QAM	21.19	21.24	21.16	21.80
	1 (RB_Pos:0)	LOW	64QAM	21.25	21.32	20.95	21.80
	1 (RB_Pos:13)	MIDDLE	64QAM	21.14	21.55	21.07	21.80
	1 (RB_Pos:24)	HIGH	64QAM	21.00	21.46	20.92	21.80
	12 (RB_Pos:0)	LOW	64QAM	20.15	20.19	20.08	20.80
	12 (RB_Pos:6)	MIDDLE	64QAM	20.06	20.04	20.07	20.80
	12 (RB_Pos:13)	HIGH	64QAM	20.22	20.04	20.08	20.80
25 (RB_Pos:0)	LOW	64QAM	19.90	20.14	19.93	20.80	
Bandwidth (MHz)	RB Set	RB offset	Modulation	Power (dBm)			
	Channel			18650	18900	19150	Tune up limit (dBm)
10 MHz	1 (RB_Pos:0)	LOW	QPSK	23.13	23.03	23.09	23.80
	1 (RB_Pos:25)	MIDDLE	QPSK	23.29	23.16	23.22	23.80
	1 (RB_Pos:49)	HIGH	QPSK	23.11	23.05	23.11	23.80
	25 (RB_Pos:0)	LOW	QPSK	22.22	22.18	22.20	22.80
	25 (RB_Pos:12)	MIDDLE	QPSK	22.19	22.14	22.12	22.80
	25 (RB_Pos:25)	HIGH	QPSK	22.23	22.17	22.10	22.80
	50 (RB_Pos:0)	LOW	QPSK	22.21	22.18	22.18	22.80
	1 (RB_Pos:0)	LOW	16QAM	22.05	22.48	22.02	22.80
	1 (RB_Pos:25)	MIDDLE	16QAM	22.17	22.64	22.25	22.80
	1 (RB_Pos:49)	HIGH	16QAM	22.05	22.47	22.11	22.80
	25 (RB_Pos:0)	LOW	16QAM	21.24	21.23	21.32	21.80
	25 (RB_Pos:12)	MIDDLE	16QAM	21.23	21.23	21.25	21.80
	25 (RB_Pos:25)	HIGH	16QAM	21.27	21.23	21.25	21.80

	50 (RB_Pos:0)	LOW	16QAM	21.22	21.19	21.27	21.80
	1 (RB_Pos:0)	LOW	64QAM	20.69	21.19	20.70	21.80
	1 (RB_Pos:25)	MIDDLE	64QAM	20.80	21.32	21.12	21.80
	1 (RB_Pos:49)	HIGH	64QAM	20.93	21.24	20.75	21.80
	25 (RB_Pos:0)	LOW	64QAM	20.15	20.22	20.20	20.80
	25 (RB_Pos:12)	MIDDLE	64QAM	19.84	20.22	19.98	20.80
	25 (RB_Pos:25)	HIGH	64QAM	19.99	19.92	20.18	20.80
	50 (RB_Pos:0)	LOW	64QAM	20.02	19.86	19.94	20.80
Bandwidth (MHz)	RB Set	RB offset	Modulation	Power (dBm)			
	Channel			18675	18900	19125	Tune up limit (dBm)
15 MHz	1 (RB_Pos:0)	LOW	QPSK	23.02	23.03	22.97	23.80
	1 (RB_Pos:38)	MIDDLE	QPSK	23.16	23.11	23.15	23.80
	1 (RB_Pos:74)	HIGH	QPSK	22.99	22.99	23.03	23.80
	36 (RB_Pos:0)	LOW	QPSK	22.24	22.13	22.20	22.80
	36 (RB_Pos:20)	MIDDLE	QPSK	22.25	22.19	22.21	22.80
	36 (RB_Pos:39)	HIGH	QPSK	22.25	22.10	22.16	22.80
	75 (RB_Pos:0)	LOW	QPSK	22.21	22.17	22.17	22.80
	1 (RB_Pos:0)	LOW	16QAM	21.99	22.41	22.37	22.80
	1 (RB_Pos:38)	MIDDLE	16QAM	22.12	22.56	22.47	22.80
	1 (RB_Pos:74)	HIGH	16QAM	22.00	22.36	22.38	22.80
	36 (RB_Pos:0)	LOW	16QAM	21.13	21.13	21.13	21.80
	36 (RB_Pos:20)	MIDDLE	16QAM	21.19	21.20	21.14	21.80
	36 (RB_Pos:39)	HIGH	16QAM	21.11	21.22	21.09	21.80
	75 (RB_Pos:0)	LOW	16QAM	21.16	21.16	21.14	21.80
	1 (RB_Pos:0)	LOW	64QAM	20.90	21.32	21.16	21.80
	1 (RB_Pos:38)	MIDDLE	64QAM	20.95	21.49	21.36	21.80
	1 (RB_Pos:74)	HIGH	64QAM	20.94	21.14	21.00	21.80
	36 (RB_Pos:0)	LOW	64QAM	19.92	20.04	19.89	20.80
	36 (RB_Pos:20)	MIDDLE	64QAM	19.81	20.03	20.06	20.80
	36 (RB_Pos:39)	HIGH	64QAM	19.72	20.12	20.08	20.80
75 (RB_Pos:0)	LOW	64QAM	19.93	19.91	20.14	20.80	
Bandwidth (MHz)	RB Set	RB offset	Modulation	Power (dBm)			
	Channel			18700	18900	19100	Tune up limit (dBm)
20 MHz	1 (RB_Pos:0)	LOW	QPSK	23.00	22.99	22.88	23.80
	1 (RB_Pos:50)	MIDDLE	QPSK	23.29	<b>23.36</b>	23.22	23.80
	1 (RB_Pos:99)	HIGH	QPSK	22.96	22.95	22.92	23.80
	50 (RB_Pos:0)	LOW	QPSK	22.13	22.14	22.16	22.80
	50 (RB_Pos:25)	MIDDLE	QPSK	22.16	22.19	22.18	22.80
	50 (RB_Pos:50)	HIGH	QPSK	22.13	22.07	22.01	22.80
	100 (RB_Pos:0)	LOW	QPSK	22.08	22.13	22.10	22.80
	1 (RB_Pos:0)	LOW	16QAM	22.16	22.09	22.07	22.80
	1 (RB_Pos:50)	MIDDLE	16QAM	22.52	22.43	22.20	22.80
	1 (RB_Pos:99)	HIGH	16QAM	22.19	22.06	22.07	22.80

	50 (RB_Pos:0)	LOW	16QAM	21.21	21.20	21.20	21.80
	50 (RB_Pos:25)	MIDDLE	16QAM	21.19	21.25	21.16	21.80
	50 (RB_Pos:50)	HIGH	16QAM	21.13	21.20	21.04	21.80
	100 (RB_Pos:0)	LOW	16QAM	21.16	21.17	21.13	21.80
	1 (RB_Pos:0)	LOW	64QAM	21.28	21.10	21.04	21.80
	1 (RB_Pos:50)	MIDDLE	64QAM	21.24	21.33	21.31	21.80
	1 (RB_Pos:99)	HIGH	64QAM	21.14	21.21	21.19	21.80
	50 (RB_Pos:0)	LOW	64QAM	19.92	19.82	19.95	20.80
	50 (RB_Pos:25)	MIDDLE	64QAM	20.04	20.08	19.96	20.80
	50 (RB_Pos:50)	HIGH	64QAM	19.98	19.95	19.66	20.80
	100 (RB_Pos:0)	LOW	64QAM	19.90	19.83	19.89	20.80

**FDD LTE Band 4 (Down Antenna)**

Bandwidth (MHz)	RB Set	RB offset	Modulation	Power (dBm)			Tune up limit (dBm)
	Channel			19957	20175	20393	
1.4 MHz	1 (RB_Pos:0)	LOW	QPSK	23.04	23.06	23.06	23.90
	1 (RB_Pos:3)	MIDDLE	QPSK	23.22	23.20	23.25	23.90
	1 (RB_Pos:5)	HIGH	QPSK	23.05	23.06	23.02	23.90
	3 (RB_Pos:0)	LOW	QPSK	23.08	23.10	23.18	23.90
	3 (RB_Pos:1)	MIDDLE	QPSK	23.13	23.16	23.23	23.90
	3 (RB_Pos:3)	HIGH	QPSK	23.10	23.14	23.18	23.90
	6 (RB_Pos:0)	LOW	QPSK	22.09	22.11	22.10	22.90
	1 (RB_Pos:0)	LOW	16QAM	22.04	22.40	22.09	22.90
	1 (RB_Pos:3)	MIDDLE	16QAM	22.23	22.51	22.25	22.90
	1 (RB_Pos:5)	HIGH	16QAM	22.09	22.35	22.16	22.90
	3 (RB_Pos:0)	LOW	16QAM	22.09	22.23	22.29	22.90
	3 (RB_Pos:1)	MIDDLE	16QAM	22.08	22.21	22.34	22.90
	3 (RB_Pos:3)	HIGH	16QAM	22.07	22.23	22.36	22.90
	6 (RB_Pos:0)	LOW	16QAM	21.25	21.01	21.33	21.90
	1 (RB_Pos:0)	LOW	64QAM	20.76	21.30	21.09	21.90
	1 (RB_Pos:3)	MIDDLE	64QAM	20.86	21.52	20.91	21.90
	1 (RB_Pos:5)	HIGH	64QAM	20.89	21.13	21.03	21.90
	3 (RB_Pos:0)	LOW	64QAM	20.98	21.18	21.15	21.90
	3 (RB_Pos:1)	MIDDLE	64QAM	20.76	21.22	21.05	21.90
	3 (RB_Pos:3)	HIGH	64QAM	20.89	20.86	21.21	21.90
6 (RB_Pos:0)	LOW	64QAM	20.22	19.65	20.11	20.90	
Bandwidth (MHz)	RB Set	RB offset	Modulation	Power (dBm)			Tune up limit (dBm)
	Channel			19965	20175	20385	
3 MHz	1 (RB_Pos:0)	LOW	QPSK	23.10	23.05	23.11	23.90
	1 (RB_Pos:8)	MIDDLE	QPSK	22.96	23.06	23.09	23.90
	1 (RB_Pos:14)	HIGH	QPSK	22.98	23.06	23.04	23.90
	8 (RB_Pos:0)	LOW	QPSK	22.05	22.07	22.08	22.90

	8 (RB_Pos:3)	MIDDLE	QPSK	22.11	22.12	22.11	22.90
	8 (RB_Pos:7)	HIGH	QPSK	22.05	22.08	22.08	22.90
	15 (RB_Pos:0)	LOW	QPSK	22.03	22.03	22.10	22.90
	1 (RB_Pos:0)	LOW	16QAM	21.88	22.36	22.10	22.90
	1 (RB_Pos:8)	MIDDLE	16QAM	21.87	22.37	22.07	22.90
	1 (RB_Pos:14)	HIGH	16QAM	21.84	22.38	22.05	22.90
	8 (RB_Pos:0)	LOW	16QAM	21.13	21.13	21.14	21.90
	8 (RB_Pos:3)	MIDDLE	16QAM	21.17	21.17	21.19	21.90
	8 (RB_Pos:7)	HIGH	16QAM	21.11	21.12	21.17	21.90
	15 (RB_Pos:0)	LOW	16QAM	21.06	21.11	21.11	21.90
	1 (RB_Pos:0)	LOW	64QAM	20.78	21.23	21.08	21.90
	1 (RB_Pos:8)	MIDDLE	64QAM	20.80	21.39	20.79	21.90
	1 (RB_Pos:14)	HIGH	64QAM	20.87	21.05	20.71	21.90
	8 (RB_Pos:0)	LOW	64QAM	20.10	19.79	19.82	20.90
	8 (RB_Pos:3)	MIDDLE	64QAM	19.82	20.00	19.83	20.90
	8 (RB_Pos:7)	HIGH	64QAM	19.77	20.06	20.16	20.90
	15 (RB_Pos:0)	LOW	64QAM	19.98	20.01	19.87	20.90
Bandwidth (MHz)	RB Set	RB offset	Modulation	Power (dBm)			
	Channel			19975	20175	20375	Tune up limit (dBm)
5 MHz	1 (RB_Pos:0)	LOW	QPSK	22.90	22.99	22.99	23.90
	1 (RB_Pos:13)	MIDDLE	QPSK	23.02	23.07	23.07	23.90
	1 (RB_Pos:24)	HIGH	QPSK	22.88	23.03	23.00	23.90
	12 (RB_Pos:0)	LOW	QPSK	22.01	22.00	22.09	22.90
	12 (RB_Pos:6)	MIDDLE	QPSK	22.05	22.07	22.14	22.90
	12 (RB_Pos:13)	HIGH	QPSK	21.98	22.06	22.09	22.90
	25 (RB_Pos:0)	LOW	QPSK	22.03	22.01	22.10	22.90
	1 (RB_Pos:0)	LOW	16QAM	22.06	22.41	22.07	22.90
	1 (RB_Pos:13)	MIDDLE	16QAM	22.18	22.52	22.22	22.90
	1 (RB_Pos:24)	HIGH	16QAM	22.05	22.46	22.15	22.90
	12 (RB_Pos:0)	LOW	16QAM	21.05	21.10	21.12	21.90
	12 (RB_Pos:6)	MIDDLE	16QAM	21.15	21.21	21.25	21.90
	12 (RB_Pos:13)	HIGH	16QAM	21.08	21.17	21.21	21.90
	25 (RB_Pos:0)	LOW	16QAM	21.06	21.11	21.11	21.90
	1 (RB_Pos:0)	LOW	64QAM	21.08	21.39	21.05	21.90
	1 (RB_Pos:13)	MIDDLE	64QAM	20.94	21.52	20.84	21.90
	1 (RB_Pos:24)	HIGH	64QAM	20.78	21.13	20.81	21.90
	12 (RB_Pos:0)	LOW	64QAM	19.72	20.06	20.10	20.90
	12 (RB_Pos:6)	MIDDLE	64QAM	19.91	19.88	20.01	20.90
	12 (RB_Pos:13)	HIGH	64QAM	19.93	19.98	20.17	20.90
25 (RB_Pos:0)	LOW	64QAM	20.07	20.10	20.06	20.90	
Bandwidth (MHz)	RB Set	RB offset	Modulation	Power (dBm)			
	Channel			20000	20175	20350	Tune up limit (dBm)
10 MHz	1 (RB_Pos:0)	LOW	QPSK	23.06	23.04	23.05	23.90



	1 (RB_Pos:25)	MIDDLE	QPSK	23.14	23.27	23.23	23.90
	1 (RB_Pos:49)	HIGH	QPSK	23.03	23.11	23.09	23.90
	25 (RB_Pos:0)	LOW	QPSK	22.08	22.07	22.13	22.90
	25 (RB_Pos:12)	MIDDLE	QPSK	22.05	22.07	22.11	22.90
	25 (RB_Pos:25)	HIGH	QPSK	22.11	22.11	22.12	22.90
	50 (RB_Pos:0)	LOW	QPSK	22.11	22.08	22.13	22.90
	1 (RB_Pos:0)	LOW	16QAM	21.85	22.37	22.02	22.90
	1 (RB_Pos:25)	MIDDLE	16QAM	22.06	22.51	22.22	22.90
	1 (RB_Pos:49)	HIGH	16QAM	22.01	22.38	22.13	22.90
	25 (RB_Pos:0)	LOW	16QAM	21.09	21.14	21.24	21.90
	25 (RB_Pos:12)	MIDDLE	16QAM	21.12	21.16	21.27	21.90
	25 (RB_Pos:25)	HIGH	16QAM	21.19	21.21	21.25	21.90
	50 (RB_Pos:0)	LOW	16QAM	21.11	21.14	21.21	21.90
	1 (RB_Pos:0)	LOW	64QAM	20.74	21.21	20.79	21.90
	1 (RB_Pos:25)	MIDDLE	64QAM	20.88	21.25	21.04	21.90
	1 (RB_Pos:49)	HIGH	64QAM	20.65	21.21	21.12	21.90
	25 (RB_Pos:0)	LOW	64QAM	19.96	19.82	19.96	20.90
	25 (RB_Pos:12)	MIDDLE	64QAM	19.86	20.17	20.18	20.90
	25 (RB_Pos:25)	HIGH	64QAM	20.10	19.94	20.25	20.90
	50 (RB_Pos:0)	LOW	64QAM	19.77	19.93	20.15	20.90
Bandwidth (MHz)	RB Set	RB offset	Modulation	Power (dBm)			
	Channel			20025	20175	20325	Tune up limit (dBm)
15 MHz	1 (RB_Pos:0)	LOW	QPSK	22.95	23.01	23.02	23.90
	1 (RB_Pos:38)	MIDDLE	QPSK	23.01	23.11	23.12	23.90
	1 (RB_Pos:74)	HIGH	QPSK	22.98	23.03	23.04	23.90
	36 (RB_Pos:0)	LOW	QPSK	22.11	22.13	22.22	22.90
	36 (RB_Pos:20)	MIDDLE	QPSK	22.13	22.20	22.19	22.90
	36 (RB_Pos:39)	HIGH	QPSK	22.18	22.18	22.22	22.90
	75 (RB_Pos:0)	LOW	QPSK	22.16	22.16	22.22	22.90
	1 (RB_Pos:0)	LOW	16QAM	21.81	22.33	22.34	22.90
	1 (RB_Pos:38)	MIDDLE	16QAM	21.95	22.42	22.46	22.90
	1 (RB_Pos:74)	HIGH	16QAM	21.95	22.30	22.43	22.90
	36 (RB_Pos:0)	LOW	16QAM	21.07	21.11	21.16	21.90
	36 (RB_Pos:20)	MIDDLE	16QAM	21.12	21.26	21.18	21.90
	36 (RB_Pos:39)	HIGH	16QAM	21.13	21.25	21.12	21.90
	75 (RB_Pos:0)	LOW	16QAM	21.12	21.13	21.18	21.90
	1 (RB_Pos:0)	LOW	64QAM	20.57	20.94	21.26	21.90
	1 (RB_Pos:38)	MIDDLE	64QAM	20.88	21.39	21.49	21.90
	1 (RB_Pos:74)	HIGH	64QAM	20.63	21.08	21.17	21.90
	36 (RB_Pos:0)	LOW	64QAM	19.80	20.09	20.08	20.90
	36 (RB_Pos:20)	MIDDLE	64QAM	19.92	20.03	19.85	20.90
	36 (RB_Pos:39)	HIGH	64QAM	19.89	19.95	20.12	20.90
75 (RB_Pos:0)	LOW	64QAM	19.87	19.92	19.95	20.90	
Bandwidth	RB Set	RB offset	Modulation	Power (dBm)			

(MHz)	Channel			20050	20175	20300	Tune up limit (dBm)
20 MHz	1 (RB_Pos:0)	LOW	QPSK	22.89	22.99	22.94	23.90
	1 (RB_Pos:50)	MIDDLE	QPSK	23.19	<b>23.27</b>	23.26	23.90
	1 (RB_Pos:99)	HIGH	QPSK	22.95	23.04	23.00	23.90
	50 (RB_Pos:0)	LOW	QPSK	22.02	22.03	22.15	22.90
	50 (RB_Pos:25)	MIDDLE	QPSK	22.10	22.06	22.12	22.90
	50 (RB_Pos:50)	HIGH	QPSK	22.07	22.17	22.07	22.90
	100 (RB_Pos:0)	LOW	QPSK	22.12	22.15	22.11	22.90
	1 (RB_Pos:0)	LOW	16QAM	22.37	22.35	22.31	22.90
	1 (RB_Pos:50)	MIDDLE	16QAM	22.75	22.57	22.60	22.90
	1 (RB_Pos:99)	HIGH	16QAM	22.46	22.34	22.42	22.90
	50 (RB_Pos:0)	LOW	16QAM	21.09	21.10	21.13	21.90
	50 (RB_Pos:25)	MIDDLE	16QAM	21.21	21.17	21.15	21.90
	50 (RB_Pos:50)	HIGH	16QAM	21.29	21.11	21.09	21.90
	100 (RB_Pos:0)	LOW	16QAM	21.18	21.09	21.18	21.90
	1 (RB_Pos:0)	LOW	64QAM	21.29	21.22	21.17	21.90
	1 (RB_Pos:50)	MIDDLE	64QAM	21.55	21.27	21.59	21.90
	1 (RB_Pos:99)	HIGH	64QAM	21.26	21.15	21.42	21.90
	50 (RB_Pos:0)	LOW	64QAM	20.01	20.03	19.90	20.90
	50 (RB_Pos:25)	MIDDLE	64QAM	20.17	20.05	19.93	20.90
	50 (RB_Pos:50)	HIGH	64QAM	19.94	19.91	20.08	20.90
100 (RB_Pos:0)	LOW	64QAM	20.02	20.01	19.85	20.90	

**FDD LTE Band 5 (Down Antenna)**

Bandwidth (MHz)	RB Set	RB offset	Modulation	Power (dBm)			Tune up limit (dBm)
	Channel			20407	20525	20643	
1.4 MHz	1 (RB_Pos:0)	LOW	QPSK	23.24	23.29	23.28	24.50
	1 (RB_Pos:3)	MIDDLE	QPSK	23.45	23.42	23.48	24.50
	1 (RB_Pos:5)	HIGH	QPSK	23.22	23.21	23.28	24.50
	3 (RB_Pos:0)	LOW	QPSK	23.39	23.40	23.40	24.50
	3 (RB_Pos:1)	MIDDLE	QPSK	23.41	23.45	23.44	24.50
	3 (RB_Pos:3)	HIGH	QPSK	23.37	23.42	23.42	24.50
	6 (RB_Pos:0)	LOW	QPSK	22.27	22.25	22.27	23.50
	1 (RB_Pos:0)	LOW	16QAM	22.33	22.64	22.24	23.50
	1 (RB_Pos:3)	MIDDLE	16QAM	22.53	22.82	22.40	23.50
	1 (RB_Pos:5)	HIGH	16QAM	22.35	22.68	22.24	23.50
	3 (RB_Pos:0)	LOW	16QAM	22.40	22.62	22.53	23.50
	3 (RB_Pos:1)	MIDDLE	16QAM	22.44	22.64	22.48	23.50
	3 (RB_Pos:3)	HIGH	16QAM	22.38	22.68	22.53	23.50
	6 (RB_Pos:0)	LOW	16QAM	21.49	21.28	21.53	22.50
	1 (RB_Pos:0)	LOW	64QAM	21.33	21.49	21.03	22.50
	1 (RB_Pos:3)	MIDDLE	64QAM	21.49	21.68	21.35	22.50

Bandwidth (MHz)	RB Set	RB offset	Modulation	Power (dBm)			
	Channel			20415	20525	20635	Tune up limit (dBm)
	1 (RB_Pos:5)	HIGH	64QAM	21.32	21.46	20.96	22.50
	3 (RB_Pos:0)	LOW	64QAM	21.18	21.46	21.38	22.50
	3 (RB_Pos:1)	MIDDLE	64QAM	21.43	21.38	21.38	22.50
	3 (RB_Pos:3)	HIGH	64QAM	21.11	21.63	21.37	22.50
	6 (RB_Pos:0)	LOW	64QAM	20.22	20.16	20.16	21.50
3 MHz	1 (RB_Pos:0)	LOW	QPSK	23.19	23.24	23.37	24.50
	1 (RB_Pos:8)	MIDDLE	QPSK	23.16	23.25	23.35	24.50
	1 (RB_Pos:14)	HIGH	QPSK	23.19	23.24	23.35	24.50
	8 (RB_Pos:0)	LOW	QPSK	22.20	22.25	22.32	23.50
	8 (RB_Pos:3)	MIDDLE	QPSK	22.27	22.32	22.37	23.50
	8 (RB_Pos:7)	HIGH	QPSK	22.21	22.27	22.27	23.50
	15 (RB_Pos:0)	LOW	QPSK	22.23	22.32	22.32	23.50
	1 (RB_Pos:0)	LOW	16QAM	22.17	22.62	22.29	23.50
	1 (RB_Pos:8)	MIDDLE	16QAM	22.14	22.71	22.26	23.50
	1 (RB_Pos:14)	HIGH	16QAM	22.12	22.65	22.19	23.50
	8 (RB_Pos:0)	LOW	16QAM	21.39	21.45	21.40	22.50
	8 (RB_Pos:3)	MIDDLE	16QAM	21.50	21.53	21.42	22.50
	8 (RB_Pos:7)	HIGH	16QAM	21.40	21.43	21.34	22.50
	15 (RB_Pos:0)	LOW	16QAM	21.37	21.45	21.33	22.50
	1 (RB_Pos:0)	LOW	64QAM	20.86	21.63	20.95	22.50
	1 (RB_Pos:8)	MIDDLE	64QAM	20.78	21.70	21.02	22.50
	1 (RB_Pos:14)	HIGH	64QAM	20.84	21.64	21.01	22.50
	8 (RB_Pos:0)	LOW	64QAM	20.23	20.18	20.19	21.50
	8 (RB_Pos:3)	MIDDLE	64QAM	20.32	20.47	20.30	21.50
	8 (RB_Pos:7)	HIGH	64QAM	20.33	20.09	19.96	21.50
15 (RB_Pos:0)	LOW	64QAM	20.01	20.09	20.04	21.50	
Bandwidth (MHz)	RB Set	RB offset	Modulation	Power (dBm)			
	Channel			20425	20525	20625	Tune up limit (dBm)
5 MHz	1 (RB_Pos:0)	LOW	QPSK	23.10	23.18	23.14	24.50
	1 (RB_Pos:13)	MIDDLE	QPSK	23.26	23.28	23.34	24.50
	1 (RB_Pos:24)	HIGH	QPSK	23.19	23.15	23.19	24.50
	12 (RB_Pos:0)	LOW	QPSK	22.18	22.29	22.23	23.50
	12 (RB_Pos:6)	MIDDLE	QPSK	22.28	22.35	22.33	23.50
	12 (RB_Pos:13)	HIGH	QPSK	22.29	22.33	22.19	23.50
	25 (RB_Pos:0)	LOW	QPSK	22.25	22.36	22.26	23.50
	1 (RB_Pos:0)	LOW	16QAM	22.33	22.68	22.22	23.50
	1 (RB_Pos:13)	MIDDLE	16QAM	22.43	22.84	22.40	23.50
	1 (RB_Pos:24)	HIGH	16QAM	22.34	22.70	22.23	23.50
	12 (RB_Pos:0)	LOW	16QAM	21.30	21.50	21.37	22.50
	12 (RB_Pos:6)	MIDDLE	16QAM	21.43	21.56	21.43	22.50
	12 (RB_Pos:13)	HIGH	16QAM	21.38	21.51	21.30	22.50

	25 (RB_Pos:0)	LOW	16QAM	21.32	21.54	21.30	22.50
	1 (RB_Pos:0)	LOW	64QAM	21.16	21.29	20.84	22.50
	1 (RB_Pos:13)	MIDDLE	64QAM	21.05	21.46	21.33	22.50
	1 (RB_Pos:24)	HIGH	64QAM	21.17	21.60	20.93	22.50
	12 (RB_Pos:0)	LOW	64QAM	20.18	20.23	20.23	21.50
	12 (RB_Pos:6)	MIDDLE	64QAM	20.27	20.17	20.10	21.50
	12 (RB_Pos:13)	HIGH	64QAM	20.20	20.14	19.94	21.50
	25 (RB_Pos:0)	LOW	64QAM	20.32	20.22	19.98	21.50
Bandwidth (MHz)	RB Set	RB offset	Modulation	Power (dBm)			
	Channel			20450	20525	20600	Tune up limit (dBm)
10 MHz	1 (RB_Pos:0)	LOW	QPSK	23.15	23.26	23.21	24.50
	1 (RB_Pos:25)	MIDDLE	QPSK	23.40	23.32	<b>23.51</b>	24.50
	1 (RB_Pos:49)	HIGH	QPSK	23.20	23.27	23.32	24.50
	25 (RB_Pos:0)	LOW	QPSK	22.22	22.24	22.43	23.50
	25 (RB_Pos:12)	MIDDLE	QPSK	22.25	22.30	22.39	23.50
	25 (RB_Pos:25)	HIGH	QPSK	22.15	22.29	22.48	23.50
	50 (RB_Pos:0)	LOW	QPSK	22.21	22.31	22.35	23.50
	1 (RB_Pos:0)	LOW	16QAM	22.10	22.57	22.32	23.50
	1 (RB_Pos:25)	MIDDLE	16QAM	22.28	22.78	22.43	23.50
	1 (RB_Pos:49)	HIGH	16QAM	22.14	22.70	22.25	23.50
	25 (RB_Pos:0)	LOW	16QAM	21.29	21.54	21.44	22.50
	25 (RB_Pos:12)	MIDDLE	16QAM	21.30	21.52	21.55	22.50
	25 (RB_Pos:25)	HIGH	16QAM	21.19	21.62	21.44	22.50
	50 (RB_Pos:0)	LOW	16QAM	21.24	21.59	21.40	22.50
	1 (RB_Pos:0)	LOW	64QAM	20.76	21.36	20.94	22.50
	1 (RB_Pos:25)	MIDDLE	64QAM	21.02	21.44	21.35	22.50
	1 (RB_Pos:49)	HIGH	64QAM	20.88	21.59	20.94	22.50
	25 (RB_Pos:0)	LOW	64QAM	20.03	20.54	20.38	21.50
	25 (RB_Pos:12)	MIDDLE	64QAM	19.99	20.49	20.27	21.50
	25 (RB_Pos:25)	HIGH	64QAM	20.07	20.27	20.15	21.50
50 (RB_Pos:0)	LOW	64QAM	20.06	20.61	20.24	21.50	

FDD LTE Band 7 (Down Antenna)							
Bandwidth (MHz)	RB Set	RB offset	Modulation	Power (dBm)			
	Channel			20775	21100	21425	Tune up limit (dBm)
5 MHz	1 (RB_Pos:0)	LOW	QPSK	23.20	23.18	23.12	23.80
	1 (RB_Pos:13)	MIDDLE	QPSK	23.28	23.27	23.25	23.80
	1 (RB_Pos:24)	HIGH	QPSK	23.16	23.17	23.20	23.80
	12 (RB_Pos:0)	LOW	QPSK	22.30	22.30	22.30	22.80
	12 (RB_Pos:6)	MIDDLE	QPSK	22.39	22.34	22.35	22.80
	12 (RB_Pos:13)	HIGH	QPSK	22.32	22.28	22.35	22.80
	25 (RB_Pos:0)	LOW	QPSK	22.33	22.30	22.29	22.80
	1 (RB_Pos:0)	LOW	16QAM	22.43	22.68	22.28	22.80
	1 (RB_Pos:13)	MIDDLE	16QAM	22.50	22.79	22.38	22.80
	1 (RB_Pos:24)	HIGH	16QAM	22.43	22.71	22.32	22.80
	12 (RB_Pos:0)	LOW	16QAM	21.38	21.45	21.37	21.80
	12 (RB_Pos:6)	MIDDLE	16QAM	21.42	21.47	21.41	21.80
	12 (RB_Pos:13)	HIGH	16QAM	21.40	21.43	21.37	21.80
	25 (RB_Pos:0)	LOW	16QAM	21.39	21.39	21.30	21.80
	1 (RB_Pos:0)	LOW	64QAM	21.39	21.63	21.20	21.80
	1 (RB_Pos:13)	MIDDLE	64QAM	21.41	21.48	21.16	21.80
	1 (RB_Pos:24)	HIGH	64QAM	21.06	21.41	21.26	21.80
	12 (RB_Pos:0)	LOW	64QAM	20.21	20.46	20.11	20.80
	12 (RB_Pos:6)	MIDDLE	64QAM	20.08	20.33	20.32	20.80
12 (RB_Pos:13)	HIGH	64QAM	20.07	20.06	20.33	20.80	
25 (RB_Pos:0)	LOW	64QAM	20.04	20.40	20.04	20.80	
Bandwidth (MHz)	RB Set	RB offset	Modulation	Power (dBm)			
	Channel			20800	21100	21400	Tune up limit (dBm)
10 MHz	1 (RB_Pos:0)	LOW	QPSK	23.27	23.26	23.27	23.80
	1 (RB_Pos:25)	MIDDLE	QPSK	23.42	23.44	23.44	23.80
	1 (RB_Pos:49)	HIGH	QPSK	23.21	23.22	23.29	23.80
	25 (RB_Pos:0)	LOW	QPSK	22.35	22.38	22.36	22.80
	25 (RB_Pos:12)	MIDDLE	QPSK	22.39	22.34	22.36	22.80
	25 (RB_Pos:25)	HIGH	QPSK	22.44	22.33	22.40	22.80
	50 (RB_Pos:0)	LOW	QPSK	22.43	22.37	22.37	22.80
	1 (RB_Pos:0)	LOW	16QAM	22.21	22.62	22.25	22.80
	1 (RB_Pos:25)	MIDDLE	16QAM	22.32	22.76	22.41	22.80
	1 (RB_Pos:49)	HIGH	16QAM	22.28	22.62	22.29	22.80
	25 (RB_Pos:0)	LOW	16QAM	21.41	21.45	21.46	21.80
	25 (RB_Pos:12)	MIDDLE	16QAM	21.47	21.41	21.45	21.80
	25 (RB_Pos:25)	HIGH	16QAM	21.52	21.40	21.48	21.80
	50 (RB_Pos:0)	LOW	16QAM	21.46	21.42	21.43	21.80
	1 (RB_Pos:0)	LOW	64QAM	20.93	21.57	21.17	21.80
	1 (RB_Pos:25)	MIDDLE	64QAM	21.15	21.78	21.43	21.80

	1 (RB_Pos:49)	HIGH	64QAM	21.29	21.64	21.32	21.80
	25 (RB_Pos:0)	LOW	64QAM	20.24	20.09	20.23	20.80
	25 (RB_Pos:12)	MIDDLE	64QAM	20.13	20.37	20.35	20.80
	25 (RB_Pos:25)	HIGH	64QAM	20.20	20.35	20.40	20.80
	50 (RB_Pos:0)	LOW	64QAM	20.22	20.03	20.13	20.80
Bandwidth (MHz)	RB Set	RB offset	Modulation	Power (dBm)			
	Channel			20825	21100	21375	Tune up limit (dBm)
15 MHz	1 (RB_Pos:0)	LOW	QPSK	23.16	23.15	23.15	23.80
	1 (RB_Pos:38)	MIDDLE	QPSK	23.24	23.21	23.26	23.80
	1 (RB_Pos:74)	HIGH	QPSK	23.10	23.11	23.16	23.80
	36 (RB_Pos:0)	LOW	QPSK	22.33	22.40	22.39	22.80
	36 (RB_Pos:20)	MIDDLE	QPSK	22.40	22.34	22.40	22.80
	36 (RB_Pos:39)	HIGH	QPSK	22.35	22.33	22.39	22.80
	75 (RB_Pos:0)	LOW	QPSK	22.38	22.36	22.37	22.80
	1 (RB_Pos:0)	LOW	16QAM	22.12	22.52	22.53	22.80
	1 (RB_Pos:38)	MIDDLE	16QAM	22.29	22.70	22.65	22.80
	1 (RB_Pos:74)	HIGH	16QAM	22.13	22.48	22.52	22.80
	36 (RB_Pos:0)	LOW	16QAM	21.27	21.34	21.31	21.80
	36 (RB_Pos:20)	MIDDLE	16QAM	21.37	21.38	21.31	21.80
	36 (RB_Pos:39)	HIGH	16QAM	21.27	21.34	21.31	21.80
	75 (RB_Pos:0)	LOW	16QAM	21.34	21.34	21.30	21.80
	1 (RB_Pos:0)	LOW	64QAM	21.01	21.24	21.36	21.80
	1 (RB_Pos:38)	MIDDLE	64QAM	21.28	21.66	21.50	21.80
	1 (RB_Pos:74)	HIGH	64QAM	21.05	21.22	21.50	21.80
	36 (RB_Pos:0)	LOW	64QAM	20.20	20.04	20.21	20.80
	36 (RB_Pos:20)	MIDDLE	64QAM	19.98	20.30	20.06	20.80
	36 (RB_Pos:39)	HIGH	64QAM	19.95	20.22	20.10	20.80
75 (RB_Pos:0)	LOW	64QAM	20.31	20.10	20.24	20.80	
Bandwidth (MHz)	RB Set	RB offset	Modulation	Power (dBm)			
	Channel			20850	21100	21350	Tune up limit (dBm)
20 MHz	1 (RB_Pos:0)	LOW	QPSK	23.11	23.14	23.02	23.80
	1 (RB_Pos:50)	MIDDLE	QPSK	23.38	<b>23.45</b>	23.34	23.80
	1 (RB_Pos:99)	HIGH	QPSK	23.08	23.08	23.04	23.80
	50 (RB_Pos:0)	LOW	QPSK	22.30	22.32	22.31	22.80
	50 (RB_Pos:25)	MIDDLE	QPSK	22.35	22.37	22.28	22.80
	50 (RB_Pos:50)	HIGH	QPSK	22.34	22.39	22.22	22.80
	100 (RB_Pos:0)	LOW	QPSK	22.29	22.29	22.30	22.80
	1 (RB_Pos:0)	LOW	16QAM	22.66	22.51	22.45	22.80
	1 (RB_Pos:50)	MIDDLE	16QAM	22.73	22.65	22.65	22.80
	1 (RB_Pos:99)	HIGH	16QAM	22.66	22.58	22.47	22.80
	50 (RB_Pos:0)	LOW	16QAM	21.30	21.32	21.26	21.80
	50 (RB_Pos:25)	MIDDLE	16QAM	21.47	21.38	21.28	21.80
	50 (RB_Pos:50)	HIGH	16QAM	21.40	21.34	21.21	21.80

	100 (RB_Pos:0)	LOW	16QAM	21.36	21.33	21.30	21.80
	1 (RB_Pos:0)	LOW	64QAM	21.34	21.36	21.34	21.80
	1 (RB_Pos:50)	MIDDLE	64QAM	21.72	21.68	21.50	21.80
	1 (RB_Pos:99)	HIGH	64QAM	21.44	21.29	21.08	21.80
	50 (RB_Pos:0)	LOW	64QAM	20.27	20.17	19.98	20.80
	50 (RB_Pos:25)	MIDDLE	64QAM	20.08	20.35	20.17	20.80
	50 (RB_Pos:50)	HIGH	64QAM	20.08	20.02	20.00	20.80
	100 (RB_Pos:0)	LOW	64QAM	20.03	20.00	20.10	20.80

FDD LTE Band 12 (Down Antenna)							
Bandwidth (MHz)	RB Set	RB offset	Modulation	Power (dBm)			
	Channel			23017	23095	23173	Tune up limit (dBm)
1.4 MHz	1 (RB_Pos:0)	LOW	QPSK	22.88	22.85	22.51	23.90
	1 (RB_Pos:3)	MIDDLE	QPSK	23.26	23.06	22.76	23.90
	1 (RB_Pos:5)	HIGH	QPSK	22.76	22.85	22.60	23.90
	3 (RB_Pos:0)	LOW	QPSK	22.82	22.90	22.54	23.90
	3 (RB_Pos:1)	MIDDLE	QPSK	22.95	22.75	22.69	23.90
	3 (RB_Pos:3)	HIGH	QPSK	22.88	22.74	22.73	23.90
	6 (RB_Pos:0)	LOW	QPSK	21.90	21.90	21.63	22.90
	1 (RB_Pos:0)	LOW	16QAM	21.92	22.08	21.47	22.90
	1 (RB_Pos:3)	MIDDLE	16QAM	22.09	22.23	21.71	22.90
	1 (RB_Pos:5)	HIGH	16QAM	22.07	22.02	21.71	22.90
	3 (RB_Pos:0)	LOW	16QAM	22.03	21.86	21.75	22.90
	3 (RB_Pos:1)	MIDDLE	16QAM	21.87	21.85	21.86	22.90
	3 (RB_Pos:3)	HIGH	16QAM	22.03	21.87	21.85	22.90
	6 (RB_Pos:0)	LOW	16QAM	21.11	20.74	20.77	21.90
	1 (RB_Pos:0)	LOW	64QAM	21.01	20.96	20.14	21.90
	1 (RB_Pos:3)	MIDDLE	64QAM	20.88	20.89	20.42	21.90
	1 (RB_Pos:5)	HIGH	64QAM	20.93	20.96	20.61	21.90
	3 (RB_Pos:0)	LOW	64QAM	20.91	20.71	20.75	21.90
	3 (RB_Pos:1)	MIDDLE	64QAM	20.95	20.59	20.66	21.90
	3 (RB_Pos:3)	HIGH	64QAM	20.74	20.72	20.36	21.90
6 (RB_Pos:0)	LOW	64QAM	19.92	19.37	19.64	20.90	
Bandwidth (MHz)	RB Set	RB offset	Modulation	Power (dBm)			
	Channel			23025	23095	23165	Tune up limit (dBm)
3 MHz	1 (RB_Pos:0)	LOW	QPSK	22.80	22.84	22.72	23.90
	1 (RB_Pos:8)	MIDDLE	QPSK	22.59	22.74	22.53	23.90
	1 (RB_Pos:14)	HIGH	QPSK	22.72	22.70	22.68	23.90
	8 (RB_Pos:0)	LOW	QPSK	21.64	21.63	21.55	22.90
	8 (RB_Pos:3)	MIDDLE	QPSK	21.77	21.80	21.70	22.90
	8 (RB_Pos:7)	HIGH	QPSK	21.83	21.76	21.51	22.90
	15 (RB_Pos:0)	LOW	QPSK	21.75	21.66	21.55	22.90

	1 (RB_Pos:0)	LOW	16QAM	21.74	21.91	21.55	22.90
	1 (RB_Pos:8)	MIDDLE	16QAM	21.73	22.06	21.62	22.90
	1 (RB_Pos:14)	HIGH	16QAM	21.51	22.12	21.60	22.90
	8 (RB_Pos:0)	LOW	16QAM	20.88	20.73	20.57	21.90
	8 (RB_Pos:3)	MIDDLE	16QAM	20.82	20.83	20.57	21.90
	8 (RB_Pos:7)	HIGH	16QAM	20.75	20.81	20.59	21.90
	15 (RB_Pos:0)	LOW	16QAM	20.74	20.63	20.66	21.90
	1 (RB_Pos:0)	LOW	64QAM	20.46	20.62	20.24	21.90
	1 (RB_Pos:8)	MIDDLE	64QAM	20.42	20.89	20.28	21.90
	1 (RB_Pos:14)	HIGH	64QAM	20.11	20.97	20.14	21.90
	8 (RB_Pos:0)	LOW	64QAM	19.64	19.63	19.37	20.90
	8 (RB_Pos:3)	MIDDLE	64QAM	19.79	19.28	19.45	20.90
	8 (RB_Pos:7)	HIGH	64QAM	19.77	19.71	19.31	20.90
	15 (RB_Pos:0)	LOW	64QAM	19.24	19.39	19.07	20.90
Bandwidth (MHz)	RB Set	RB offset	Modulation	Power (dBm)			
	Channel			23035	23095	23155	Tune up limit (dBm)
5 MHz	1 (RB_Pos:0)	LOW	QPSK	22.60	22.69	22.56	23.90
	1 (RB_Pos:13)	MIDDLE	QPSK	22.69	22.60	22.67	23.90
	1 (RB_Pos:24)	HIGH	QPSK	22.61	22.66	22.52	23.90
	12 (RB_Pos:0)	LOW	QPSK	21.74	21.71	21.68	22.90
	12 (RB_Pos:6)	MIDDLE	QPSK	21.69	21.63	21.68	22.90
	12 (RB_Pos:13)	HIGH	QPSK	21.60	21.62	21.45	22.90
	25 (RB_Pos:0)	LOW	QPSK	21.62	21.68	21.66	22.90
	1 (RB_Pos:0)	LOW	16QAM	21.70	22.13	21.72	22.90
	1 (RB_Pos:13)	MIDDLE	16QAM	21.74	22.21	21.75	22.90
	1 (RB_Pos:24)	HIGH	16QAM	21.80	21.93	21.56	22.90
	12 (RB_Pos:0)	LOW	16QAM	20.64	20.75	20.75	21.90
	12 (RB_Pos:6)	MIDDLE	16QAM	20.78	20.72	20.81	21.90
	12 (RB_Pos:13)	HIGH	16QAM	20.55	20.74	20.62	21.90
	25 (RB_Pos:0)	LOW	16QAM	20.63	20.78	20.56	21.90
	1 (RB_Pos:0)	LOW	64QAM	20.88	21.12	20.65	21.90
	1 (RB_Pos:13)	MIDDLE	64QAM	20.77	21.01	20.78	21.90
	1 (RB_Pos:24)	HIGH	64QAM	20.62	20.54	20.57	21.90
	12 (RB_Pos:0)	LOW	64QAM	19.23	19.52	19.46	20.90
	12 (RB_Pos:6)	MIDDLE	64QAM	19.76	19.33	19.28	20.90
	12 (RB_Pos:13)	HIGH	64QAM	19.35	19.79	19.53	20.90
25 (RB_Pos:0)	LOW	64QAM	19.32	19.75	19.63	20.90	
Bandwidth (MHz)	RB Set	RB offset	Modulation	Power (dBm)			
	Channel			23060	23095	23130	Tune up limit (dBm)
10 MHz	1 (RB_Pos:0)	LOW	QPSK	22.89	22.97	22.98	23.90
	1 (RB_Pos:25)	MIDDLE	QPSK	23.17	23.15	23.08	23.90
	1 (RB_Pos:49)	HIGH	QPSK	22.94	23.01	22.99	23.90
	25 (RB_Pos:0)	LOW	QPSK	<b>22.18</b>	22.15	21.90	22.90



25 (RB_Pos:12)	MIDDLE	QPSK	22.00	22.06	21.99	22.90
25 (RB_Pos:25)	HIGH	QPSK	22.02	22.05	21.89	22.90
50 (RB_Pos:0)	LOW	QPSK	22.01	22.16	21.95	22.90
1 (RB_Pos:0)	LOW	16QAM	21.88	22.23	21.92	22.90
1 (RB_Pos:25)	MIDDLE	16QAM	22.12	22.46	22.08	22.90
1 (RB_Pos:49)	HIGH	16QAM	21.95	22.34	21.91	22.90
25 (RB_Pos:0)	LOW	16QAM	21.06	21.15	21.03	21.90
25 (RB_Pos:12)	MIDDLE	16QAM	21.03	21.11	21.07	21.90
25 (RB_Pos:25)	HIGH	16QAM	21.05	21.21	20.96	21.90
50 (RB_Pos:0)	LOW	16QAM	21.06	21.17	20.95	21.90
1 (RB_Pos:0)	LOW	64QAM	20.22	21.01	20.43	21.90
1 (RB_Pos:25)	MIDDLE	64QAM	20.73	20.86	20.38	21.90
1 (RB_Pos:49)	HIGH	64QAM	20.71	20.61	20.20	21.90
25 (RB_Pos:0)	LOW	64QAM	19.42	19.76	19.37	20.90
25 (RB_Pos:12)	MIDDLE	64QAM	19.78	19.77	19.52	20.90
25 (RB_Pos:25)	HIGH	64QAM	19.68	19.86	19.24	20.90
50 (RB_Pos:0)	LOW	64QAM	19.51	19.88	19.45	20.90

**FDD LTE Band 17 (Down Antenna)**

Bandwidth (MHz)	RB Set	RB offset	Modulation	Power (dBm)			
	Channel			23755	23790	23825	Tune up limit (dBm)
5 MHz	1 (RB_Pos:0)	LOW	QPSK	22.75	22.98	22.75	23.90
	1 (RB_Pos:13)	MIDDLE	QPSK	22.88	23.00	22.83	23.90
	1 (RB_Pos:24)	HIGH	QPSK	22.89	22.73	22.72	23.90
	12 (RB_Pos:0)	LOW	QPSK	22.01	21.92	21.81	22.90
	12 (RB_Pos:6)	MIDDLE	QPSK	21.99	21.91	21.85	22.90
	12 (RB_Pos:13)	HIGH	QPSK	21.98	21.93	21.84	22.90
	25 (RB_Pos:0)	LOW	QPSK	21.93	21.94	21.79	22.90
	1 (RB_Pos:0)	LOW	16QAM	21.90	22.25	21.91	22.90
	1 (RB_Pos:13)	MIDDLE	16QAM	22.13	22.39	21.96	22.90
	1 (RB_Pos:24)	HIGH	16QAM	21.91	22.22	21.79	22.90
	12 (RB_Pos:0)	LOW	16QAM	20.88	20.90	20.77	21.90
	12 (RB_Pos:6)	MIDDLE	16QAM	20.93	20.94	21.00	21.90
	12 (RB_Pos:13)	HIGH	16QAM	21.12	20.97	20.77	21.90
	25 (RB_Pos:0)	LOW	16QAM	21.00	20.91	20.78	21.90
	1 (RB_Pos:0)	LOW	64QAM	20.57	21.04	20.60	21.90
	1 (RB_Pos:13)	MIDDLE	64QAM	20.76	21.34	20.58	21.90
	1 (RB_Pos:24)	HIGH	64QAM	20.67	20.96	20.45	21.90
	12 (RB_Pos:0)	LOW	64QAM	19.65	19.79	19.62	20.90
	12 (RB_Pos:6)	MIDDLE	64QAM	19.84	20.05	19.49	20.90
	12 (RB_Pos:13)	HIGH	64QAM	19.79	19.76	19.64	20.90
25 (RB_Pos:0)	LOW	64QAM	19.80	19.96	19.56	20.90	
Bandwidth	RB Set	RB offset	Modulation	Power (dBm)			

(MHz)	Channel			23780	23790	23800	Tune up limit (dBm)
10 MHz	1 (RB_Pos:0)	LOW	QPSK	23.20	23.13	23.12	23.90
	1 (RB_Pos:25)	MIDDLE	QPSK	<b>23.34</b>	23.23	23.23	23.90
	1 (RB_Pos:49)	HIGH	QPSK	23.19	23.19	23.18	23.90
	25 (RB_Pos:0)	LOW	QPSK	22.20	22.17	22.10	22.90
	25 (RB_Pos:12)	MIDDLE	QPSK	22.22	22.21	22.18	22.90
	25 (RB_Pos:25)	HIGH	QPSK	22.31	22.18	22.10	22.90
	50 (RB_Pos:0)	LOW	QPSK	22.29	22.20	22.08	22.90
	1 (RB_Pos:0)	LOW	16QAM	22.07	22.02	22.39	22.90
	1 (RB_Pos:25)	MIDDLE	16QAM	22.28	22.20	22.58	22.90
	1 (RB_Pos:49)	HIGH	16QAM	22.09	21.99	22.43	22.90
	25 (RB_Pos:0)	LOW	16QAM	21.29	21.19	21.16	21.90
	25 (RB_Pos:12)	MIDDLE	16QAM	21.30	21.23	21.20	21.90
	25 (RB_Pos:25)	HIGH	16QAM	21.38	21.21	21.09	21.90
	50 (RB_Pos:0)	LOW	16QAM	21.32	21.15	21.09	21.90
	1 (RB_Pos:0)	LOW	64QAM	20.63	20.69	21.49	21.90
	1 (RB_Pos:25)	MIDDLE	64QAM	20.79	21.12	21.65	21.90
	1 (RB_Pos:49)	HIGH	64QAM	20.37	20.89	21.14	21.90
	25 (RB_Pos:0)	LOW	64QAM	19.79	19.96	20.42	20.90
	25 (RB_Pos:12)	MIDDLE	64QAM	19.51	20.03	19.92	20.90
	25 (RB_Pos:25)	HIGH	64QAM	19.74	20.12	20.12	20.90
50 (RB_Pos:0)	LOW	64QAM	19.73	20.29	20.09	20.90	

FDD LTE Band 66 (Down Antenna)							
Bandwidth (MHz)	RB Set	RB offset	Modulation	Power (dBm)			Tune up limit (dBm)
	Channel			131979	132322	132665	
1.4 MHz	1 (RB_Pos:0)	LOW	QPSK	22.69	22.90	22.90	23.90
	1 (RB_Pos:3)	MIDDLE	QPSK	22.87	23.05	23.09	23.90
	1 (RB_Pos:5)	HIGH	QPSK	22.64	22.88	22.73	23.90
	3 (RB_Pos:0)	LOW	QPSK	22.68	22.93	22.90	23.90
	3 (RB_Pos:1)	MIDDLE	QPSK	22.71	22.98	22.90	23.90
	3 (RB_Pos:3)	HIGH	QPSK	22.63	22.91	22.91	23.90
	6 (RB_Pos:0)	LOW	QPSK	21.72	21.98	21.83	22.90
	1 (RB_Pos:0)	LOW	16QAM	21.63	22.17	21.87	22.90
	1 (RB_Pos:3)	MIDDLE	16QAM	22.13	22.16	22.06	22.90
	1 (RB_Pos:5)	HIGH	16QAM	21.93	22.09	21.84	22.90
	3 (RB_Pos:0)	LOW	16QAM	21.85	21.90	22.10	22.90
	3 (RB_Pos:1)	MIDDLE	16QAM	21.87	21.96	22.03	22.90
	3 (RB_Pos:3)	HIGH	16QAM	21.88	21.94	22.10	22.90
	6 (RB_Pos:0)	LOW	16QAM	21.03	20.76	21.07	21.90
	1 (RB_Pos:0)	LOW	64QAM	20.64	20.83	20.58	21.90
	1 (RB_Pos:3)	MIDDLE	64QAM	21.13	21.18	20.68	21.90

	1 (RB_Pos:5)	HIGH	64QAM	20.67	20.74	20.77	21.90
	3 (RB_Pos:0)	LOW	64QAM	20.68	20.76	20.96	21.90
	3 (RB_Pos:1)	MIDDLE	64QAM	20.83	20.57	20.76	21.90
	3 (RB_Pos:3)	HIGH	64QAM	20.73	20.75	20.86	21.90
	6 (RB_Pos:0)	LOW	64QAM	19.90	19.58	19.70	20.90
Bandwidth (MHz)	RB Set	RB offset	Modulation	Power (dBm)			
	Channel			131987	132322	132657	Tune up limit (dBm)
3 MHz	1 (RB_Pos:0)	LOW	QPSK	22.93	22.88	22.88	23.90
	1 (RB_Pos:8)	MIDDLE	QPSK	22.86	22.90	22.86	23.90
	1 (RB_Pos:14)	HIGH	QPSK	22.84	22.88	22.85	23.90
	8 (RB_Pos:0)	LOW	QPSK	21.91	21.89	21.88	22.90
	8 (RB_Pos:3)	MIDDLE	QPSK	21.95	21.95	21.93	22.90
	8 (RB_Pos:7)	HIGH	QPSK	21.86	21.89	21.86	22.90
	15 (RB_Pos:0)	LOW	QPSK	21.85	21.84	21.89	22.90
	1 (RB_Pos:0)	LOW	16QAM	21.72	22.18	21.97	22.90
	1 (RB_Pos:8)	MIDDLE	16QAM	21.68	22.16	21.92	22.90
	1 (RB_Pos:14)	HIGH	16QAM	21.67	22.16	21.93	22.90
	8 (RB_Pos:0)	LOW	16QAM	20.96	20.96	20.98	21.90
	8 (RB_Pos:3)	MIDDLE	16QAM	21.00	20.98	21.03	21.90
	8 (RB_Pos:7)	HIGH	16QAM	20.95	20.93	20.98	21.90
	15 (RB_Pos:0)	LOW	16QAM	20.84	20.88	20.90	21.90
	1 (RB_Pos:0)	LOW	64QAM	20.43	21.06	20.68	21.90
	1 (RB_Pos:8)	MIDDLE	64QAM	20.47	20.79	20.86	21.90
	1 (RB_Pos:14)	HIGH	64QAM	20.70	20.78	20.58	21.90
	8 (RB_Pos:0)	LOW	64QAM	19.88	19.97	19.66	20.90
	8 (RB_Pos:3)	MIDDLE	64QAM	19.83	19.99	19.68	20.90
	8 (RB_Pos:7)	HIGH	64QAM	19.75	19.95	19.91	20.90
15 (RB_Pos:0)	LOW	64QAM	19.86	19.86	19.79	20.90	
Bandwidth (MHz)	RB Set	RB offset	Modulation	Power (dBm)			
	Channel			131997	132322	132647	Tune up limit (dBm)
5 MHz	1 (RB_Pos:0)	LOW	QPSK	22.77	22.75	22.80	23.90
	1 (RB_Pos:13)	MIDDLE	QPSK	22.88	22.95	22.90	23.90
	1 (RB_Pos:24)	HIGH	QPSK	22.72	22.79	22.80	23.90
	12 (RB_Pos:0)	LOW	QPSK	21.81	21.81	21.85	22.90
	12 (RB_Pos:6)	MIDDLE	QPSK	21.89	21.91	21.97	22.90
	12 (RB_Pos:13)	HIGH	QPSK	21.75	21.81	21.86	22.90
	25 (RB_Pos:0)	LOW	QPSK	21.81	21.79	21.85	22.90
	1 (RB_Pos:0)	LOW	16QAM	21.87	22.21	21.87	22.90
	1 (RB_Pos:13)	MIDDLE	16QAM	21.98	22.33	22.04	22.90
	1 (RB_Pos:24)	HIGH	16QAM	21.84	22.18	22.00	22.90
	12 (RB_Pos:0)	LOW	16QAM	20.86	21.01	21.05	21.90
	12 (RB_Pos:6)	MIDDLE	16QAM	20.90	21.04	21.15	21.90
	12 (RB_Pos:13)	HIGH	16QAM	20.82	20.93	21.07	21.90

	25 (RB_Pos:0)	LOW	16QAM	20.81	20.90	20.99	21.90
	1 (RB_Pos:0)	LOW	64QAM	20.70	20.96	20.60	21.90
	1 (RB_Pos:13)	MIDDLE	64QAM	20.96	21.13	21.01	21.90
	1 (RB_Pos:24)	HIGH	64QAM	20.56	21.03	20.62	21.90
	12 (RB_Pos:0)	LOW	64QAM	19.52	20.03	19.84	20.90
	12 (RB_Pos:6)	MIDDLE	64QAM	19.69	19.82	19.94	20.90
	12 (RB_Pos:13)	HIGH	64QAM	19.63	19.68	19.92	20.90
	25 (RB_Pos:0)	LOW	64QAM	19.76	19.88	19.96	20.90
Bandwidth (MHz)	RB Set	RB offset	Modulation	Power (dBm)			
	Channel			132022	132322	132622	Tune up limit (dBm)
10 MHz	1 (RB_Pos:0)	LOW	QPSK	22.95	22.78	22.81	23.90
	1 (RB_Pos:25)	MIDDLE	QPSK	23.10	23.03	23.02	23.90
	1 (RB_Pos:49)	HIGH	QPSK	22.88	22.90	22.88	23.90
	25 (RB_Pos:0)	LOW	QPSK	21.96	21.87	21.95	22.90
	25 (RB_Pos:12)	MIDDLE	QPSK	21.94	21.92	21.94	22.90
	25 (RB_Pos:25)	HIGH	QPSK	21.97	21.85	21.99	22.90
	50 (RB_Pos:0)	LOW	QPSK	21.95	21.86	21.96	22.90
	1 (RB_Pos:0)	LOW	16QAM	21.78	22.14	21.90	22.90
	1 (RB_Pos:25)	MIDDLE	16QAM	21.86	22.34	22.11	22.90
	1 (RB_Pos:49)	HIGH	16QAM	21.76	22.08	21.89	22.90
	25 (RB_Pos:0)	LOW	16QAM	20.87	20.94	21.10	21.90
	25 (RB_Pos:12)	MIDDLE	16QAM	20.85	20.97	21.14	21.90
	25 (RB_Pos:25)	HIGH	16QAM	20.89	20.86	21.20	21.90
	50 (RB_Pos:0)	LOW	16QAM	20.89	20.94	21.10	21.90
	1 (RB_Pos:0)	LOW	64QAM	20.60	21.03	20.89	21.90
	1 (RB_Pos:25)	MIDDLE	64QAM	20.88	21.37	20.74	21.90
	1 (RB_Pos:49)	HIGH	64QAM	20.62	21.02	20.63	21.90
	25 (RB_Pos:0)	LOW	64QAM	19.60	19.94	19.99	20.90
	25 (RB_Pos:12)	MIDDLE	64QAM	19.60	19.58	20.16	20.90
	25 (RB_Pos:25)	HIGH	64QAM	19.81	19.82	20.16	20.90
50 (RB_Pos:0)	LOW	64QAM	19.75	19.72	19.73	20.90	
Bandwidth (MHz)	RB Set	RB offset	Modulation	Power (dBm)			
	Channel			132047	132322	132597	Tune up limit (dBm)
15 MHz	1 (RB_Pos:0)	LOW	QPSK	22.83	22.75	22.78	23.90
	1 (RB_Pos:38)	MIDDLE	QPSK	22.81	22.92	22.93	23.90
	1 (RB_Pos:74)	HIGH	QPSK	22.77	22.85	22.85	23.90
	36 (RB_Pos:0)	LOW	QPSK	21.94	21.93	21.92	22.90
	36 (RB_Pos:20)	MIDDLE	QPSK	21.93	22.05	21.99	22.90
	36 (RB_Pos:39)	HIGH	QPSK	21.91	22.00	22.04	22.90
	75 (RB_Pos:0)	LOW	QPSK	21.95	22.00	22.00	22.90
	1 (RB_Pos:0)	LOW	16QAM	21.63	22.17	22.19	22.90
	1 (RB_Pos:38)	MIDDLE	16QAM	21.75	22.19	22.38	22.90
	1 (RB_Pos:74)	HIGH	16QAM	21.75	22.00	22.25	22.90

	36 (RB_Pos:0)	LOW	16QAM	20.93	20.97	20.91	21.90
	36 (RB_Pos:20)	MIDDLE	16QAM	20.91	21.00	21.00	21.90
	36 (RB_Pos:39)	HIGH	16QAM	20.90	20.89	21.01	21.90
	75 (RB_Pos:0)	LOW	16QAM	20.92	20.98	21.02	21.90
	1 (RB_Pos:0)	LOW	64QAM	20.54	21.08	21.02	21.90
	1 (RB_Pos:38)	MIDDLE	64QAM	20.47	20.97	21.14	21.90
	1 (RB_Pos:74)	HIGH	64QAM	20.77	20.78	21.17	21.90
	36 (RB_Pos:0)	LOW	64QAM	19.74	19.66	19.54	20.90
	36 (RB_Pos:20)	MIDDLE	64QAM	19.77	19.99	19.71	20.90
	36 (RB_Pos:39)	HIGH	64QAM	19.81	19.57	19.71	20.90
	75 (RB_Pos:0)	LOW	64QAM	19.95	19.93	19.76	20.90
Bandwidth (MHz)	RB Set	RB offset	Modulation	Power (dBm)			
	Channel			132072	132322	132572	Tune up limit (dBm)
20 MHz	1 (RB_Pos:0)	LOW	QPSK	22.76	22.75	22.66	23.90
	1 (RB_Pos:50)	MIDDLE	QPSK	23.03	<b>23.12</b>	23.00	23.90
	1 (RB_Pos:99)	HIGH	QPSK	22.78	22.82	22.76	23.90
	50 (RB_Pos:0)	LOW	QPSK	21.82	21.96	21.86	22.90
	50 (RB_Pos:25)	MIDDLE	QPSK	21.86	21.97	21.85	22.90
	50 (RB_Pos:50)	HIGH	QPSK	21.92	21.95	21.76	22.90
	100 (RB_Pos:0)	LOW	QPSK	21.90	21.94	21.87	22.90
	1 (RB_Pos:0)	LOW	16QAM	22.18	22.22	22.05	22.90
	1 (RB_Pos:50)	MIDDLE	16QAM	22.55	22.40	22.47	22.90
	1 (RB_Pos:99)	HIGH	16QAM	22.29	22.09	22.26	22.90
	50 (RB_Pos:0)	LOW	16QAM	20.92	20.95	20.98	21.90
	50 (RB_Pos:25)	MIDDLE	16QAM	20.92	20.91	21.04	21.90
	50 (RB_Pos:50)	HIGH	16QAM	20.99	20.75	21.04	21.90
	100 (RB_Pos:0)	LOW	16QAM	20.98	20.85	21.00	21.90
	1 (RB_Pos:0)	LOW	64QAM	21.19	21.11	20.66	21.90
	1 (RB_Pos:50)	MIDDLE	64QAM	21.16	21.16	21.49	21.90
	1 (RB_Pos:99)	HIGH	64QAM	20.96	20.79	21.04	21.90
	50 (RB_Pos:0)	LOW	64QAM	19.57	19.95	19.68	20.90
	50 (RB_Pos:25)	MIDDLE	64QAM	19.91	19.58	19.86	20.90
	50 (RB_Pos:50)	HIGH	64QAM	19.80	19.41	19.89	20.90
100 (RB_Pos:0)	LOW	64QAM	19.68	19.53	20.01	20.90	

TDD LTE Band 38 (Down Antenna)							
Bandwidth (MHz)	RB Set	RB offset	Modulation	Power (dBm)			
	Channel			37775	38000	38225	Tune up limit (dBm)
5 MHz	1 (RB_Pos:0)	LOW	QPSK	23.18	23.07	23.10	24.00
	1 (RB_Pos:13)	MIDDLE	QPSK	23.25	23.19	23.24	24.00
	1 (RB_Pos:24)	HIGH	QPSK	23.10	23.06	23.09	24.00
	12 (RB_Pos:0)	LOW	QPSK	22.24	22.16	22.17	23.00
	12 (RB_Pos:6)	MIDDLE	QPSK	22.32	22.22	22.26	23.00
	12 (RB_Pos:13)	HIGH	QPSK	22.21	22.18	22.17	23.00
	25 (RB_Pos:0)	LOW	QPSK	22.22	22.11	22.19	23.00
	1 (RB_Pos:0)	LOW	16QAM	22.37	22.35	22.44	23.00
	1 (RB_Pos:13)	MIDDLE	16QAM	22.47	22.49	22.56	23.00
	1 (RB_Pos:24)	HIGH	16QAM	22.29	22.34	22.43	23.00
	12 (RB_Pos:0)	LOW	16QAM	21.25	21.12	21.24	22.00
	12 (RB_Pos:6)	MIDDLE	16QAM	21.27	21.17	21.31	22.00
	12 (RB_Pos:13)	HIGH	16QAM	21.22	21.12	21.21	22.00
	25 (RB_Pos:0)	LOW	16QAM	21.21	21.16	21.19	22.00
	1 (RB_Pos:0)	LOW	64QAM	21.27	21.30	21.17	22.00
	1 (RB_Pos:13)	MIDDLE	64QAM	21.23	21.19	21.51	22.00
	1 (RB_Pos:24)	HIGH	64QAM	21.25	21.24	21.31	22.00
	12 (RB_Pos:0)	LOW	64QAM	20.27	20.04	20.19	21.00
	12 (RB_Pos:6)	MIDDLE	64QAM	20.22	20.18	20.27	21.00
12 (RB_Pos:13)	HIGH	64QAM	19.86	20.04	19.89	21.00	
25 (RB_Pos:0)	LOW	64QAM	19.89	19.88	19.99	21.00	
Bandwidth (MHz)	RB Set	RB offset	Modulation	Power (dBm)			
	Channel			37800	38000	38200	Tune up limit (dBm)
10 MHz	1 (RB_Pos:0)	LOW	QPSK	23.24	23.17	23.16	24.00
	1 (RB_Pos:25)	MIDDLE	QPSK	23.49	23.49	23.52	24.00
	1 (RB_Pos:49)	HIGH	QPSK	23.15	23.14	23.20	24.00
	25 (RB_Pos:0)	LOW	QPSK	22.32	22.22	22.23	23.00
	25 (RB_Pos:12)	MIDDLE	QPSK	22.28	22.25	22.26	23.00
	25 (RB_Pos:25)	HIGH	QPSK	22.28	22.23	22.26	23.00
	50 (RB_Pos:0)	LOW	QPSK	22.22	22.19	22.20	23.00
	1 (RB_Pos:0)	LOW	16QAM	22.50	22.56	22.47	23.00
	1 (RB_Pos:25)	MIDDLE	16QAM	22.74	22.85	22.84	23.00
	1 (RB_Pos:49)	HIGH	16QAM	22.47	22.53	22.52	23.00
	25 (RB_Pos:0)	LOW	16QAM	21.30	21.23	21.24	22.00
	25 (RB_Pos:12)	MIDDLE	16QAM	21.27	21.25	21.28	22.00
	25 (RB_Pos:25)	HIGH	16QAM	21.27	21.22	21.26	22.00
	50 (RB_Pos:0)	LOW	16QAM	21.24	21.22	21.26	22.00
	1 (RB_Pos:0)	LOW	64QAM	21.37	21.44	21.43	22.00
	1 (RB_Pos:25)	MIDDLE	64QAM	21.77	21.85	21.86	22.00

	1 (RB_Pos:49)	HIGH	64QAM	21.40	21.31	21.14	22.00
	25 (RB_Pos:0)	LOW	64QAM	20.30	20.00	19.94	21.00
	25 (RB_Pos:12)	MIDDLE	64QAM	20.24	20.02	20.15	21.00
	25 (RB_Pos:25)	HIGH	64QAM	20.24	19.91	20.09	21.00
	50 (RB_Pos:0)	LOW	64QAM	20.10	19.98	20.02	21.00
Bandwidth (MHz)	RB Set	RB offset	Modulation	Power (dBm)			
	Channel			37825	38000	38175	Tune up limit (dBm)
15 MHz	1 (RB_Pos:0)	LOW	QPSK	23.17	23.10	23.11	24.00
	1 (RB_Pos:38)	MIDDLE	QPSK	23.22	23.22	23.25	24.00
	1 (RB_Pos:74)	HIGH	QPSK	23.04	23.04	23.09	24.00
	36 (RB_Pos:0)	LOW	QPSK	22.26	22.23	22.23	23.00
	36 (RB_Pos:20)	MIDDLE	QPSK	22.30	22.27	22.25	23.00
	36 (RB_Pos:39)	HIGH	QPSK	22.22	22.22	22.22	23.00
	75 (RB_Pos:0)	LOW	QPSK	22.28	22.25	22.23	23.00
	1 (RB_Pos:0)	LOW	16QAM	22.45	22.51	22.41	23.00
	1 (RB_Pos:38)	MIDDLE	16QAM	22.49	22.63	22.51	23.00
	1 (RB_Pos:74)	HIGH	16QAM	22.30	22.44	22.35	23.00
	36 (RB_Pos:0)	LOW	16QAM	21.20	21.18	21.19	22.00
	36 (RB_Pos:20)	MIDDLE	16QAM	21.22	21.19	21.22	22.00
	36 (RB_Pos:39)	HIGH	16QAM	21.20	21.15	21.21	22.00
	75 (RB_Pos:0)	LOW	16QAM	21.22	21.20	21.20	22.00
	1 (RB_Pos:0)	LOW	64QAM	21.10	21.32	21.25	22.00
	1 (RB_Pos:38)	MIDDLE	64QAM	21.36	21.47	21.15	22.00
	1 (RB_Pos:74)	HIGH	64QAM	21.28	21.46	21.13	22.00
	36 (RB_Pos:0)	LOW	64QAM	19.86	20.18	19.83	21.00
	36 (RB_Pos:20)	MIDDLE	64QAM	20.19	19.99	20.07	21.00
	36 (RB_Pos:39)	HIGH	64QAM	20.20	19.99	20.11	21.00
75 (RB_Pos:0)	LOW	64QAM	20.25	19.86	20.04	21.00	
Bandwidth (MHz)	RB Set	RB offset	Modulation	Power (dBm)			
	Channel			37850	38000	38150	Tune up limit (dBm)
20 MHz	1 (RB_Pos:0)	LOW	QPSK	23.11	23.02	23.05	24.00
	1 (RB_Pos:50)	MIDDLE	QPSK	<b>23.46</b>	23.42	23.45	24.00
	1 (RB_Pos:99)	HIGH	QPSK	23.03	22.99	23.07	24.00
	50 (RB_Pos:0)	LOW	QPSK	22.17	22.12	22.10	23.00
	50 (RB_Pos:25)	MIDDLE	QPSK	22.19	22.16	22.17	23.00
	50 (RB_Pos:50)	HIGH	QPSK	22.15	22.11	22.10	23.00
	100 (RB_Pos:0)	LOW	QPSK	22.14	22.12	22.10	23.00
	1 (RB_Pos:0)	LOW	16QAM	22.37	22.21	22.39	23.00
	1 (RB_Pos:50)	MIDDLE	16QAM	22.73	22.59	22.79	23.00
	1 (RB_Pos:99)	HIGH	16QAM	22.31	22.19	22.40	23.00
	50 (RB_Pos:0)	LOW	16QAM	21.14	21.15	21.16	22.00
	50 (RB_Pos:25)	MIDDLE	16QAM	21.17	21.19	21.19	22.00
	50 (RB_Pos:50)	HIGH	16QAM	21.11	21.12	21.16	22.00

	100 (RB_Pos:0)	LOW	16QAM	21.13	21.12	21.07	22.00
	1 (RB_Pos:0)	LOW	64QAM	21.30	21.24	21.42	22.00
	1 (RB_Pos:50)	MIDDLE	64QAM	21.48	21.48	21.41	22.00
	1 (RB_Pos:99)	HIGH	64QAM	21.08	21.00	21.16	22.00
	50 (RB_Pos:0)	LOW	64QAM	20.13	19.89	20.08	21.00
	50 (RB_Pos:25)	MIDDLE	64QAM	20.14	19.99	20.02	21.00
	50 (RB_Pos:50)	HIGH	64QAM	19.76	20.01	19.82	21.00
	100 (RB_Pos:0)	LOW	64QAM	20.11	19.98	19.69	21.00

TDD LTE Band 41 (Down Antenna)									
Bandwidth (MHz)	RB Set	RB offset	Modulation	Power (dBm)					Tune up limit (dBm)
	Channel			39675	40110	40620	41130	41565	
5 MHz	1 (RB_Pos:0)	LOW	QPSK	23.69	23.71	23.59	23.44	23.61	24.50
	1 (RB_Pos:13)	MIDDLE	QPSK	23.83	23.64	23.75	23.77	23.77	24.50
	1 (RB_Pos:24)	HIGH	QPSK	23.71	23.71	23.59	23.52	23.61	24.50
	12 (RB_Pos:0)	LOW	QPSK	22.79	22.71	22.72	22.69	22.78	23.50
	12 (RB_Pos:6)	MIDDLE	QPSK	22.89	22.86	22.80	22.77	22.86	23.50
	12 (RB_Pos:13)	HIGH	QPSK	22.79	22.78	22.72	22.68	22.77	23.50
	25 (RB_Pos:0)	LOW	QPSK	22.80	22.71	22.70	22.66	22.78	23.50
	1 (RB_Pos:0)	LOW	16QAM	22.90	22.82	22.88	23.05	23.05	23.50
	1 (RB_Pos:13)	MIDDLE	16QAM	23.07	22.99	23.05	23.08	23.18	23.50
	1 (RB_Pos:24)	HIGH	16QAM	22.92	22.88	22.88	22.88	23.05	23.50
	12 (RB_Pos:0)	LOW	16QAM	21.74	21.69	21.70	21.87	21.89	22.50
	12 (RB_Pos:6)	MIDDLE	16QAM	21.85	21.83	21.76	21.85	21.95	22.50
	12 (RB_Pos:13)	HIGH	16QAM	21.75	21.62	21.71	21.90	21.88	22.50
	25 (RB_Pos:0)	LOW	16QAM	21.77	21.58	21.76	21.70	21.82	22.50
	1 (RB_Pos:0)	LOW	64QAM	21.86	21.46	21.74	21.99	21.68	22.50
	1 (RB_Pos:13)	MIDDLE	64QAM	21.86	21.72	21.82	21.86	21.88	22.50
	1 (RB_Pos:24)	HIGH	64QAM	21.92	21.86	21.72	21.86	21.89	22.50
	12 (RB_Pos:0)	LOW	64QAM	20.71	20.49	20.46	20.67	20.56	21.50
	12 (RB_Pos:6)	MIDDLE	64QAM	20.75	20.59	20.43	20.78	20.93	21.50
12 (RB_Pos:13)	HIGH	64QAM	20.61	20.28	20.72	20.80	20.88	21.50	
25 (RB_Pos:0)	LOW	64QAM	20.56	20.35	20.53	20.40	20.48	21.50	
Bandwidth (MHz)	RB Set	RB offset	Modulation	Power (dBm)					Tune up limit (dBm)
	Channel			39700	40135	40620	41105	41540	
10 MHz	1 (RB_Pos:0)	LOW	QPSK	23.71	23.66	23.72	23.60	23.67	24.50
	1 (RB_Pos:25)	MIDDLE	QPSK	23.85	23.91	23.94	23.96	23.89	24.50
	1 (RB_Pos:49)	HIGH	QPSK	23.71	23.67	23.72	23.60	23.70	24.50
	25 (RB_Pos:0)	LOW	QPSK	22.81	22.65	22.78	22.74	22.81	23.50
	25 (RB_Pos:12)	MIDDLE	QPSK	22.83	22.83	22.75	22.70	22.80	23.50



	25 (RB_Pos:25)	HIGH	QPSK	22.80	22.66	22.77	22.74	22.82	23.50
	50 (RB_Pos:0)	LOW	QPSK	22.72	22.65	22.72	22.79	22.82	23.50
	1 (RB_Pos:0)	LOW	16QAM	22.99	22.85	23.11	23.05	23.09	23.50
	1 (RB_Pos:25)	MIDDLE	16QAM	23.26	23.21	23.27	23.34	23.27	23.50
	1 (RB_Pos:49)	HIGH	16QAM	23.00	22.91	23.07	23.05	23.09	23.50
	25 (RB_Pos:0)	LOW	16QAM	21.74	21.59	21.79	21.75	21.88	22.50
	25 (RB_Pos:12)	MIDDLE	16QAM	21.77	21.59	21.76	21.68	21.87	22.50
	25 (RB_Pos:25)	HIGH	16QAM	21.77	21.79	21.76	21.78	21.86	22.50
	50 (RB_Pos:0)	LOW	16QAM	21.68	21.69	21.77	21.66	21.85	22.50
	1 (RB_Pos:0)	LOW	64QAM	21.72	21.80	21.79	21.94	22.10	22.50
	1 (RB_Pos:25)	MIDDLE	64QAM	22.08	21.92	22.36	22.29	22.07	22.50
	1 (RB_Pos:49)	HIGH	64QAM	21.77	21.52	21.95	21.94	21.91	22.50
	25 (RB_Pos:0)	LOW	64QAM	20.43	20.29	20.59	20.72	20.55	21.50
	25 (RB_Pos:12)	MIDDLE	64QAM	20.76	20.51	20.70	20.38	20.83	21.50
	25 (RB_Pos:25)	HIGH	64QAM	20.68	20.61	20.52	20.54	20.56	21.50
	50 (RB_Pos:0)	LOW	64QAM	20.29	20.38	20.42	20.36	20.53	21.50
Bandwidth (MHz)	RB Set	RB offset	Modulation	Power (dBm)					Tune up limit (dBm)
	Channel			39725	40160	40620	41080	41515	
15 MHz	1 (RB_Pos:0)	LOW	QPSK	23.68	23.65	23.63	23.46	23.63	24.50
	1 (RB_Pos:38)	MIDDLE	QPSK	23.76	23.57	23.69	23.56	23.74	24.50
	1 (RB_Pos:74)	HIGH	QPSK	23.65	23.48	23.58	23.56	23.62	24.50
	36 (RB_Pos:0)	LOW	QPSK	22.82	22.82	22.77	22.77	22.77	23.50
	36 (RB_Pos:20)	MIDDLE	QPSK	22.82	22.68	22.80	22.66	22.81	23.50
	36 (RB_Pos:39)	HIGH	QPSK	22.81	22.79	22.75	22.78	22.78	23.50
	75 (RB_Pos:0)	LOW	QPSK	22.79	22.77	22.77	22.72	22.82	23.50
	1 (RB_Pos:0)	LOW	16QAM	22.94	22.87	23.06	22.96	22.95	23.50
	1 (RB_Pos:38)	MIDDLE	16QAM	23.01	22.92	23.10	23.00	23.06	23.50
	1 (RB_Pos:74)	HIGH	16QAM	22.91	22.78	23.03	22.92	22.93	23.50
	36 (RB_Pos:0)	LOW	16QAM	21.72	21.71	21.69	21.64	21.72	22.50
	36 (RB_Pos:20)	MIDDLE	16QAM	21.75	21.58	21.74	21.62	21.78	22.50
	36 (RB_Pos:39)	HIGH	16QAM	21.72	21.57	21.74	21.78	21.78	22.50
	75 (RB_Pos:0)	LOW	16QAM	21.74	21.76	21.74	21.76	21.79	22.50
	1 (RB_Pos:0)	LOW	64QAM	21.67	21.75	21.68	21.83	21.87	22.50
	1 (RB_Pos:38)	MIDDLE	64QAM	21.69	21.67	21.75	21.98	22.09	22.50
	1 (RB_Pos:74)	HIGH	64QAM	21.75	21.48	21.93	21.95	21.69	22.50
	36 (RB_Pos:0)	LOW	64QAM	20.53	20.56	20.42	20.60	20.40	21.50
	36 (RB_Pos:20)	MIDDLE	64QAM	20.36	20.55	20.58	20.61	20.81	21.50
	36 (RB_Pos:39)	HIGH	64QAM	20.72	20.56	20.62	20.68	20.53	21.50
75 (RB_Pos:0)	LOW	64QAM	20.42	20.78	20.69	20.51	20.63	21.50	
Bandwidth (MHz)	RB Set	RB offset	Modulation	Power (dBm)					Tune up limit (dBm)
	Channel			39750	40185	40620	41055	41490	

20 MHz	1 (RB_Pos:0)	LOW	QPSK	23.63	23.61	23.55	23.56	23.56	24.50
	1 (RB_Pos:50)	MIDDLE	QPSK	23.95	23.78	<b>23.96</b>	23.86	23.91	24.50
	1 (RB_Pos:99)	HIGH	QPSK	23.59	23.48	23.54	23.47	23.61	24.50
	50 (RB_Pos:0)	LOW	QPSK	22.67	22.67	22.67	22.55	22.70	23.50
	50 (RB_Pos:25)	MIDDLE	QPSK	22.71	22.67	22.79	22.73	22.76	23.50
	50 (RB_Pos:50)	HIGH	QPSK	22.76	22.69	22.64	22.62	22.70	23.50
	100 (RB_Pos:0)	LOW	QPSK	22.68	22.63	22.72	22.62	22.63	23.50
	1 (RB_Pos:0)	LOW	16QAM	22.90	22.75	22.78	22.77	22.96	23.50
	1 (RB_Pos:50)	MIDDLE	16QAM	23.25	23.26	23.11	23.35	23.34	23.50
	1 (RB_Pos:99)	HIGH	16QAM	22.92	22.86	22.73	22.95	23.05	23.50
	50 (RB_Pos:0)	LOW	16QAM	21.63	21.57	21.70	21.66	21.72	22.50
	50 (RB_Pos:25)	MIDDLE	16QAM	21.70	21.52	21.75	21.65	21.81	22.50
	50 (RB_Pos:50)	HIGH	16QAM	21.66	21.47	21.66	21.67	21.76	22.50
	100 (RB_Pos:0)	LOW	16QAM	21.66	21.54	21.67	21.70	21.74	22.50
	1 (RB_Pos:0)	LOW	64QAM	21.90	21.43	21.45	21.38	21.77	22.50
	1 (RB_Pos:50)	MIDDLE	64QAM	22.24	22.14	21.88	22.36	22.35	22.50
	1 (RB_Pos:99)	HIGH	64QAM	21.91	21.78	21.72	21.86	22.07	22.50
	50 (RB_Pos:0)	LOW	64QAM	20.46	20.41	20.50	20.35	20.68	21.50
	50 (RB_Pos:25)	MIDDLE	64QAM	20.44	20.23	20.58	20.60	20.55	21.50
	50 (RB_Pos:50)	HIGH	64QAM	20.44	20.22	20.31	20.62	20.55	21.50
100 (RB_Pos:0)	LOW	64QAM	20.47	20.53	20.56	20.49	20.69	21.50	

## 8.4 WIFI

### 8.4.1 2.4G WIFI

Band (GHz)	Mode	Channel	Freq. (MHz)	Average Power (dBm)	Tune-up Limit (dBm)	SAR Test Require.
2.4 (2.4~2.4835)	802.11b	1	2412	16.71	18.00	Yes
		6	2437	16.69	18.00	Yes
		11	2462	<b>16.76</b>	18.00	Yes
	802.11g	1	2412	16.08	17.50	No
		6	2437	16.26	17.50	No
		11	2462	16.08	17.50	No
	802.11n(HT20)	1	2412	15.59	17.00	No
		6	2437	15.62	17.00	No
		11	2462	15.66	17.00	No

## 8.4.2 5G WIFI

Band (GHz)	Mode	Channel	Freq. (MHz)	Average Power (dBm)	Tune-up Limit (dBm)	SAR Test Require.	
5.2 (5.15~5.25)	802.11a	36	5180	15.12	16.50	No	
		40	5200	16.04	17.50	No	
		44	5220	16.10	17.50	No	
		48	5240	16.01	17.50	No	
	802.11n(HT20)	36	5180	15.11	16.50	No	
		40	5200	16.11	17.50	No	
		44	5220	16.19	17.50	No	
		48	5240	16.18	17.50	No	
	802.11n(HT40)	38	5190	15.07	16.50	No	
		46	5230	15.06	16.50	No	
	802.11ac(VHT20)	36	5180	15.73	17.00	No	
		44	5220	15.77	17.00	No	
		48	5240	15.69	17.00	No	
	802.11ac(VHT40)	38	5190	14.06	15.50	No	
		46	5230	14.09	15.50	No	
	802.11ac(VHT80)	42	5210	12.75	14.50	No	
5.3 (5.25~5.35)	802.11a	52	5260	16.14	14.50	No	
		60	5300	<b>16.28</b>	17.50	Yes	
		64	5320	16.19	17.50	No	
	802.11n(HT20)	52	5260	16.15	17.50	No	
		60	5300	16.36	17.50	No	
		64	5320	16.34	17.50	No	
	802.11n(HT40)	54	5270	15.11	16.50	No	
		62	5310	13.09	14.50	No	
	802.11ac(VHT20)	52	5260	15.65	17.00	No	
		60	5300	15.85	17.00	No	
		64	5320	15.93	17.00	No	
	802.11ac(VHT40)	54	5270	14.14	15.50	No	
		62	5310	13.10	14.50	No	
	802.11ac(VHT80)	58	5290	12.32	14.00	No	
	5.6 (5.47~5.725)	802.11a	100	5500	14.52	16.00	No
			/	/	/	/	No
116			5580	<b>14.71</b>	16.00	Yes	
/			/	/	/	No	
140			5700	14.58	16.00	No	
144			5720	14.39	16.00	No	
802.11n(HT20)		100	5500	14.61	16.00	No	
		116	5580	14.60	16.00	No	

		/	/	/	/	No
		140	5700	14.47	16.00	No
		144	5720	14.63	16.00	No
	802.11n(HT40)	102	5510	12.46	14.00	No
		110	5550	14.53	16.00	No
		118	5590	14.55	16.00	No
		134	5670	14.47	16.00	No
		142	5710	14.54	16.00	No
	802.11ac(VHT20)	100	5500	14.31	16.00	No
		116	5580	14.41	16.00	No
		140	5700	14.56	16.00	No
		144	5720	14.30	16.00	No
	802.11ac(VHT40)	102	5510	14.21	15.50	No
		118	5590	14.18	15.50	No
		134	5670	14.12	15.50	No
		142	5710	14.09	15.50	No
802.11ac(VHT80)	106	5530	12.83	14.50	No	
	122	5610	12.89	14.50	No	
	138	5690	12.73	14.50	No	
5.8 (5.725~5.850)	802.11a	149	5745	<b>12.25</b>	14.00	Yes
		157	5785	12.19	14.00	No
		165	5825	12.26	14.00	No
	802.11n(HT20)	149	5745	12.09	14.00	No
		157	5785	12.02	14.00	No
		165	5825	12.04	14.00	No
	802.11n(HT40)	151	5755	12.21	14.00	No
		159	5795	12.19	14.00	No
	802.11ac(VHT20)	149	5745	12.22	14.00	No
		157	5785	12.16	14.00	No
		165	5825	12.04	14.00	No
	802.11ac(VHT40)	151	5755	12.40	14.00	No
		159	5795	12.04	14.00	No
	802.11ac(VHT80)	155	5775	12.35	14.00	No

## 8.5 Bluetooth

Mode	GFSK			$\pi/4$ -DQPSK		
Channel	0	39	78	0	39	78
Frequency (MHz)	2402	2441	2480	2402	2441	2480
Average Power (dBm)	<b>9.65</b>	8.96	9.41	<b>9.65</b>	8.78	8.63
Tune-Up Limit (dBm)	10.00			10.00		
Mode	8-DPSK			/		
Channel	0	39	78	/	/	/
Frequency (MHz)	2402	2441	2480	/	/	/
Average Power (dBm)	9.25	8.80	8.61	/	/	/
Tune-Up Limit (dBm)	10.00			/		
Mode	BLE-1Mbps			BLE-2Mbps		
Channel	0	19	39	0	19	39
Frequency (MHz)	2402	2440	2480	2402	2440	2480
Average Power (dBm)	-2.74	-2.62	-3.49	-2.58	-2.42	-3.28
Tune-Up Limit (dBm)	-2.00			-2.00		

## 9 LOW-POWER EXEMPTION

### 9.1 Tune-up Power

Mode	Antenna	Tune-up Limit power(dBm)
GSM 850	Up	33.00
	Down	33.20
EGPRS 850	Up	27.80
	Down	27.60
GSM 1900	Up	24.00
	Down	30.50
EGPRS 1900	Up	24.50
	Down	27.00
WCDMA Band2	Up	15.00
	Down	23.70
WCDMABand2HSPA	Up	14.00
	Down	23.00
WCDMA Band4	Up	16.50
	Down	23.80
WCDMABand4HSPA	Up	15.50
	Down	23.00
WCDMA Band5	Up	23.90
	Down	23.70
WCDMABand5HSPA	Up	23.00
	Down	23.00
LTE Band2	Up	15.00
	Down	23.80
LTE Band4	Up	16.50
	Down	23.90
LTE Band5	Up	24.50
	Down	24.50
LTE Band7	Up	17.00
	Down	23.80
LTE Band12	Up	24.00
	Down	23.90
LTE Band17	Up	24.00
	Down	23.90
LTE Band66	Up	15.50
	Down	23.90
LTE Band38	Up	19.50
	Down	24.00
LTE Band41	Up	19.50
	Down	24.50

Mode	Tune-up Power (dBm)
2.4G WLAN 802.11b	18.00
2.4G WLAN 802.11g	17.50
2.4G WLAN 802.11n20	17.00
5G WLAN 802.11a	17.50
5G WLAN 802.11n20	17.50
5G WLAN 802.11n40	16.50
5G WLAN 802.11ac20	17.00
5G WLAN 802.11ac40	15.50
5G WLAN 802.11ac80	14.50

Note: According to ANSI C63.19 2011, for 2.4GHz or 5GHz WLAN RF emissions testing exemption shall be applied to an RF air interface technology in a device whose peak antenna input power, averaged over intervals  $\leq 50 \mu s$ , is  $\leq 23$  dBm.



## 10 HAC RF Emission Test Results

### 10.1 E-Filled Emission Test Results

Band	Mode	Antenna	Ch.	Freq. (MHz)	Peak E-Field dB (V/m)	M-Rating	Meas. No.
GSM 850	Voice	Up	128	824.20	36.52	M4	1#
			190	836.60	38.07	M4	2#
			251	848.80	38.05	M4	3#
GSM 850	Voice	Down	128	824.20	31.57	M4	4#
			190	836.60	33.54	M4	5#
			251	848.80	34.01	M4	6#
GSM 1900	Voice	Up	512	1850.20	27.92	M4	7#
			661	1880.00	28.30	M4	8#
			810	1909.80	28.62	M4	9#
GSM 1900	Voice	Down	512	1850.20	21.60	M4	10#
			661	1880.00	21.89	M4	11#
			810	1909.80	21.46	M4	12#
LTE Band 38	QPSK	Up	37850	2580.00	21.28	M4	13#
			38000	2595.00	21.91	M4	14#
			38150	2610.00	21.43	M4	15#
LTE Band 38	QPSK	Down	37850	2580.00	14.90	M4	16#
			38000	2595.00	16.05	M4	17#
			38150	2610.00	16.32	M4	18#
LTE Band 41	QPSK	Up	39750	2506.00	20.55	M4	19#
			40185	2549.50	21.53	M4	20#
			40620	2593.00	22.03	M4	21#
			41055	2636.50	20.53	M4	22#
			41490	2680.00	21.24	M4	23#
LTE Band 41	QPSK	Down	39750	2506.00	15.70	M4	24#
			40185	2549.50	15.69	M4	25#
			40620	2593.00	16.91	M4	26#
			41055	2636.50	17.10	M4	27#
			41490	2680.00	17.47	M4	28#

## 11 TEST EQUIPMENTS LIST

Description	Manufacturer	Model	Serial No.	Cal. Date	Cal. Due
PC	Dell	N/A	N/A	N/A	N/A
800-950MHz Dipole	SATIMO	SIDB835	SN 18/12 DHA41	2020/10/15	2021/10/14
1700-2000MHz Dipole	SATIMO	SIDB1900	SN 18/12 DHB46	2020/10/15	2021/10/14
2100-2600MHZ Dipole	SATIMO	SIDB2450	SN 18/12 DHB48	2020/10/13	2021/10/12
E-Field Probe	SATIMO	SCE	SN 24/13 EPH41	2020/10/15	2021/10/14
Antenna	SATIMO	ANTA3	SN 17/13 ZNTA45	N/A	N/A
MultiMeter	Keithley	MultiMeter 2000	4024022	2021/06/04	2022/06/03
Signal Generator	R&S	SMB100A	182396	2020/12/21	2021/12/20
Power Meter	R&S	NRVD-B2	7250BJ-0112/2011	2020/09/25	2021/09/24
Power Sensor	R&S	NRV-Z4	100381	2020/09/25	2021/09/24
Power Sensor	R&S	NRV-Z2	100211	2020/09/25	2021/09/24
Wireless Communication Test Set	Anritsu	MT8820C	6201524635	2021/03/16	2022/03/15
Wireless Communication Test Set	R&S	CMW 500	104946	2021/06/02	2022/06/01
Directional coupler	AA-MCS	AAMCS-UDC	000272	N/A	N/A

## 12 REFERENCES

- 1 FCC 47 CFR Part 20.19 "Hearing aid-compatible mobile handsets."
- 2 ANSI C 63.19:2011 "American National Standard Methods of Measurement of Compatibility between Wireless Communications Devices and Hearing Aids", 27 May 2011
- 3 KDB 285076 D01 HAC Guidance v04, "provides equipment authorization guidance for mobile handsets subject to the requirements of Section 20.19 for hearing aid compatibility
- 4 KDB 285076 D02, T-Coil testing for CMRS IP v01r01 provides guidance for T-Coil tests for voice-over-IP (e.g. LTE and Wi-Fi) CMRS based Telephone Services.
- 4 SATIMO COMOHAC\_V4
- 5 SATIMO OPENHAC\_V4

## ANNEX A HAC TEST RESULT OF SYSTEM VERIFICATION

### E-Field System Check Data(835MHz)

#### Experimental conditions.

<b>Grid size (mm x mm)</b>	20.0, 150.0
<b>Step (mm)</b>	5
<b>Band</b>	835MHz
<b>Channel</b>	
<b>Signal</b>	CW
<b>Date of measurement</b>	5/28/2021

#### HAC Measurement Results

Frequency (MHz): 835.000000

Maximum value of total field = 227.13 V/m

#### SURFACE E-Field

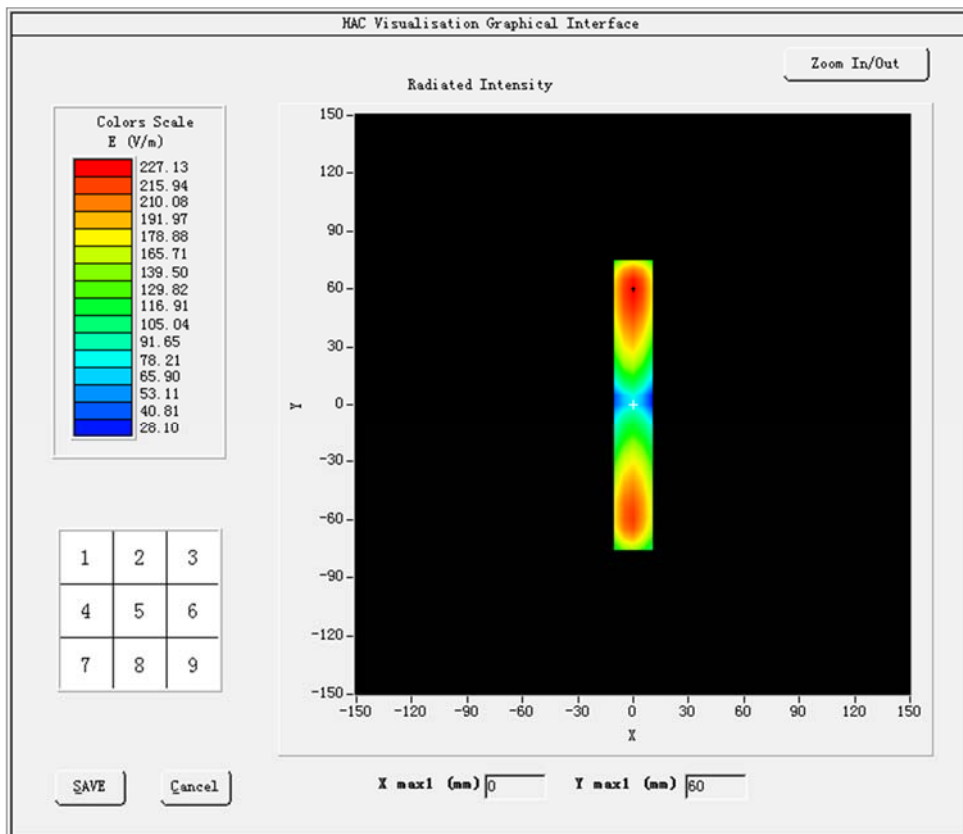

# E-Filed System Check Data (1900MHz)

## Experimental conditions

Grid size (mm x mm)	20.0, 150.0
Step (mm)	5
Band	1900 MHz
Channel	
Signal	CW
Date of measurement	5/31/2021

## HAC Measurement Results

Frequency (MHz): 1900.000000

Maximum value of total field = 155.28 V/m

### SURFACE HAC

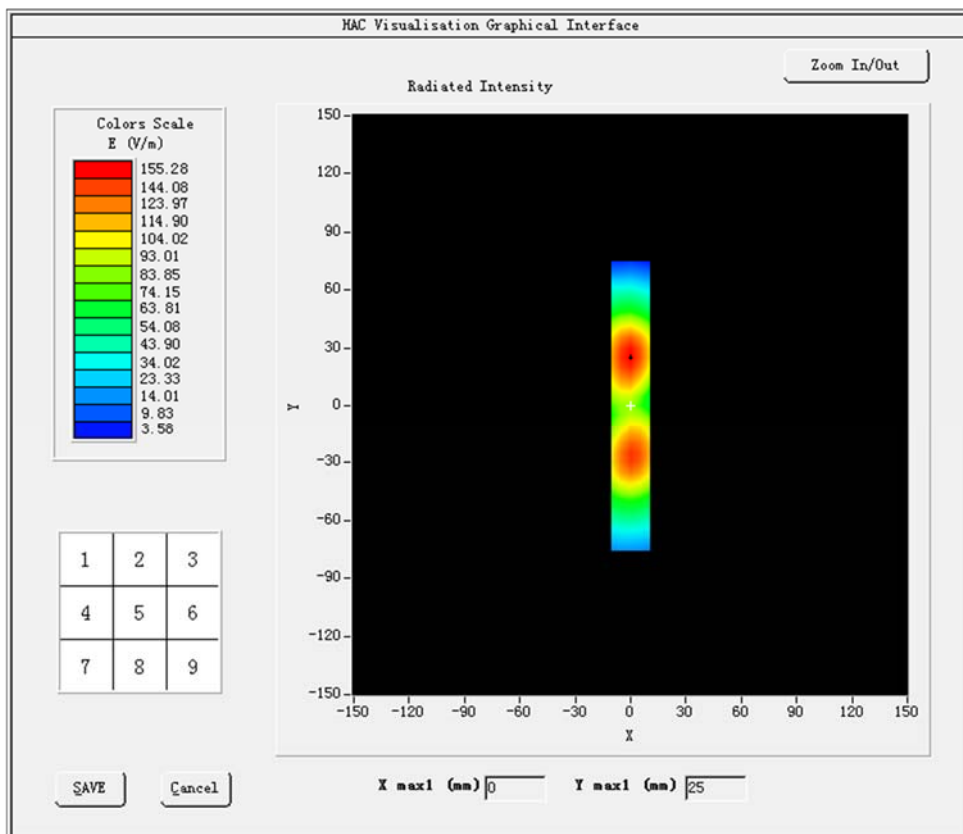

## E-Filed System Check Data (2450MHz)

### Experimental conditions

<b>Grid size (mm x mm)</b>	20.0, 80.0
<b>Step (mm)</b>	5
<b>Band</b>	2450 MHz
<b>Channel</b>	
<b>Signal</b>	CW
<b>Date of measurement</b>	6/1/2021

### HAC Measurement Results

Frequency (MHz): 2450.000000

Maximum value of total field = 130.08 V/m

#### SURFACE HAC

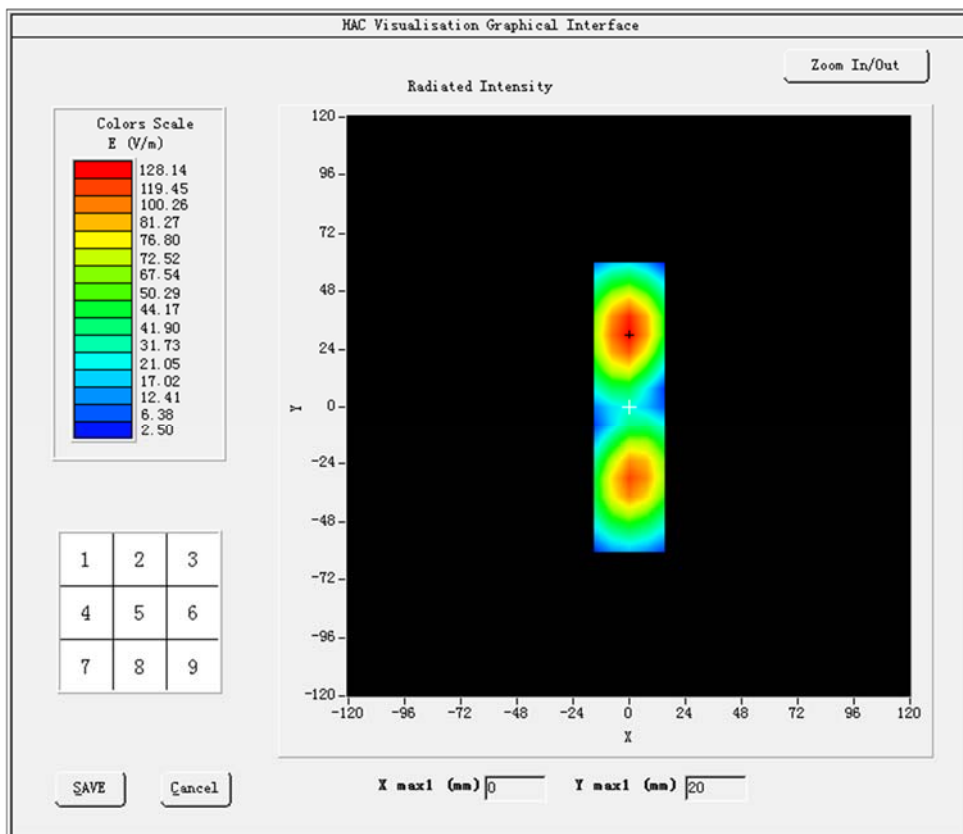

## ANNEX B HAC RF MEASUREMENT RESULT

### MEASUREMENT 1

#### Experimental conditions.

Grid size (mm x mm)	50.0, 50.0
Step (mm)	5
Band	GSM850
Channel	Low
Signal	GSM
Date of measurement	5/28/2021

#### HAC Measurement Results

##### Lower Band (Channel 128):

Frequency (MHz): 824.200000

Maximum value of total field = 36.52 dB (V/m)

Hearing Aid Near-Field Category: M4

#### SURFACE HAC

E in dB (V/m)

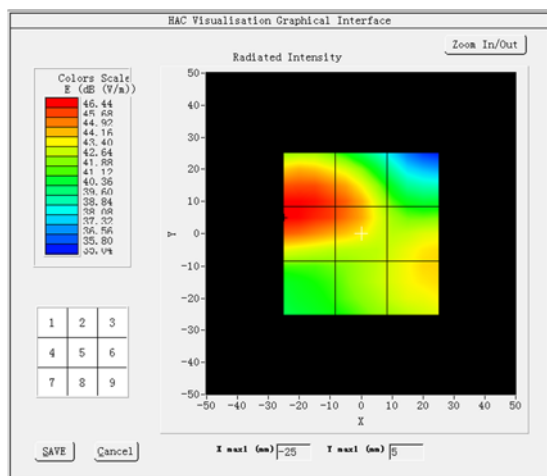

<b>Grid 1: 37.37</b>	<b>Grid 2: 36.46</b>	Grid 3: 32.44
<b>Grid 4: 37.52</b>	<b>Grid 5: 36.52</b>	Grid 6: 34.71
Grid 7: 32.99	Grid 8: 33.83	Grid 9: 34.74

**MEASUREMENT 2**

**Experimental conditions.**

<b>Grid size (mm x mm)</b>	50.0, 50.0
<b>Step (mm)</b>	5
<b>Band</b>	GSM850
<b>Channel</b>	Middle
<b>Signal</b>	GSM
<b>Date of measurement</b>	5/28/2021

**HAC Measurement Results**

Middle Band (Channel 190):

Frequency (MHz): 836.600000

Maximum value of total field = 38.07 dB (V/m)

**Hearing Aid Near-Field Category: M4**

**SURFACE HAC**

**E in dB (V/m)**

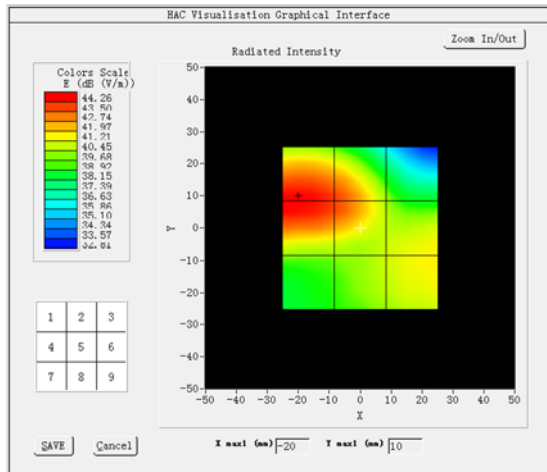

<b>Grid 1: 38.85</b>	<b>Grid 2: 37.99</b>	Grid 3: 33.86
<b>Grid 4: 38.97</b>	<b>Grid 5: 38.07</b>	Grid 6: 35.76
Grid 7: 34.48	Grid 8: 35.15	Grid 9: 35.84



**MEASUREMENT 3**

**Experimental conditions.**

<b>Grid size (mm x mm)</b>	50.0, 50.0
<b>Step (mm)</b>	5
<b>Band</b>	GSM850
<b>Channel</b>	High
<b>Signal</b>	GSM
<b>Date of measurement</b>	5/28/2021

**HAC Measurement Results**

Higher Band (Channel 251):

Frequency (MHz): 848.800000

Maximum value of total field = 38.05 dB (V/m)

**Hearing Aid Near-Field Category: M4**

SURFACE HAC

E in dB (V/m)

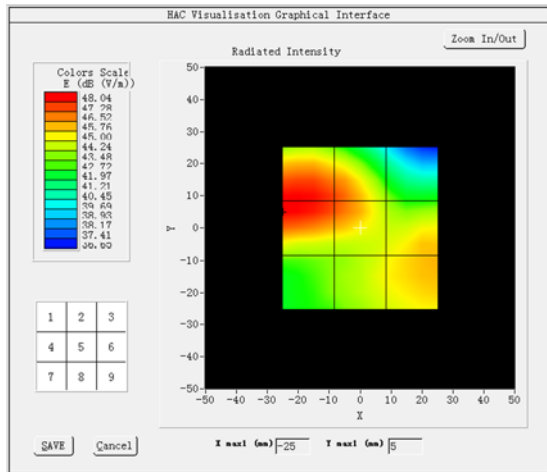

Grid 1: 39.00	Grid 2: 38.02	Grid 3: 34.09
Grid 4: 39.14	Grid 5: 38.05	Grid 6: 36.68
Grid 7: 34.62	Grid 8: 35.94	Grid 9: 36.77

**MEASUREMENT 4**

**Experimental conditions.**

<b>Grid size (mm x mm)</b>	50.0, 50.0
<b>Step (mm)</b>	5
<b>Band</b>	GSM850
<b>Channel</b>	Low
<b>Signal</b>	GSM
<b>Date of measurement</b>	5/28/2021

**HAC Measurement Results**

Lower Band (Channel 128):

Frequency (MHz): 824.200000

Maximum value of total field = 31.57 dB (V/m)

**Hearing Aid Near-Field Category: M4**

SURFACE HAC

E in dB (V/m)

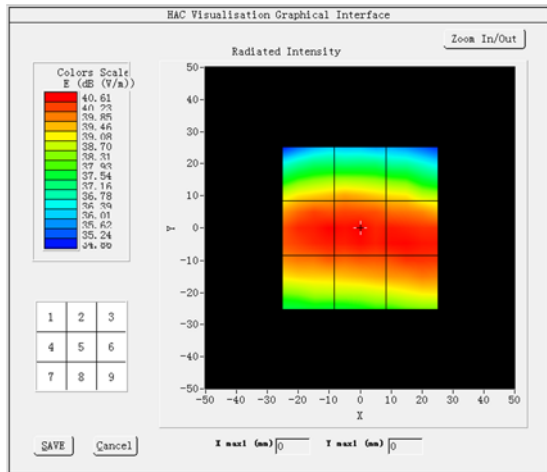

Grid 1: 30.43	Grid 2: 30.53	Grid 3: 30.15
Grid 4: 31.55	<b>Grid 5: 31.57</b>	<b>Grid 6: 31.54</b>
Grid 7: 31.17	<b>Grid 8: 31.25</b>	<b>Grid 9: 31.39</b>

**MEASUREMENT 5**

**Experimental conditions.**

<b>Grid size (mm x mm)</b>	50.0, 50.0
<b>Step (mm)</b>	5
<b>Band</b>	GSM850
<b>Channel</b>	Middle
<b>Signal</b>	GSM
<b>Date of measurement</b>	5/28/2021

**HAC Measurement Results**

Middle Band (Channel 190):

Frequency (MHz): 836.600000

Maximum value of total field = 33.54 dB (V/m)

**Hearing Aid Near-Field Category: M4**

**SURFACE HAC**

**E in dB (V/m)**

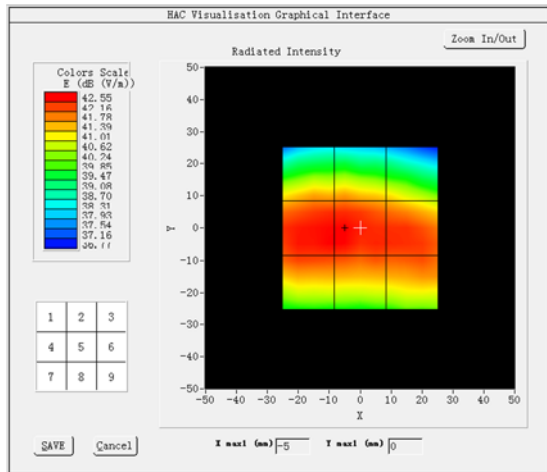

Grid 1: 32.47	Grid 2: 32.52	Grid 3: 32.04
Grid 4: 33.54	Grid 5: 33.54	Grid 6: 33.27
Grid 7: 33.24	Grid 8: 33.23	Grid 9: 33.10

**MEASUREMENT 6**

**Experimental conditions.**

<b>Grid size (mm x mm)</b>	50.0, 50.0
<b>Step (mm)</b>	5
<b>Band</b>	GSM850
<b>Channel</b>	High
<b>Signal</b>	GSM
<b>Date of measurement</b>	5/28/2021

**HAC Measurement Results**

Higher Band (Channel 251):

Frequency (MHz): 848.800000

Maximum value of total field = 34.01 dB (V/m)

**Hearing Aid Near-Field Category: M4**

SURFACE HAC

E in dB (V/m)

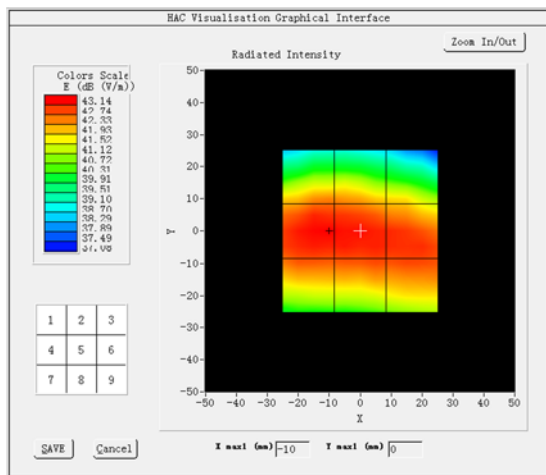

Grid 1: 33.22	Grid 2: 33.13	Grid 3: 32.61
Grid 4: 34.08	<b>Grid 5: 34.01</b>	Grid 6: 33.86
Grid 7: 33.68	Grid 8: 33.73	Grid 9: 33.73

**MEASUREMENT 7**

**Experimental conditions.**

<b>Grid size (mm x mm)</b>	50.0, 50.0
<b>Step (mm)</b>	5
<b>Band</b>	GSM1900
<b>Channel</b>	Low
<b>Signal</b>	GSM
<b>Date of measurement</b>	5/31/2021

**HAC Measurement Results**

Lower Band (Channel 512):

Frequency (MHz): 1850.200000

Maximum value of total field = 27.92 dB (V/m)

**Hearing Aid Near-Field Category: M4**

**SURFACE HAC**

**E in dB (V/m)**

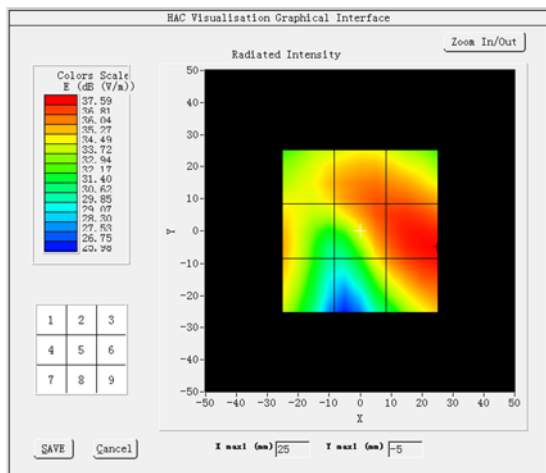

Grid 1: 26.40	Grid 2: 27.58	<b>Grid 3: 27.46</b>
Grid 4: 26.53	<b>Grid 5: 27.92</b>	<b>Grid 6: 28.59</b>
Grid 7: 26.37	Grid 8: 26.87	<b>Grid 9: 28.48</b>

**MEASUREMENT 8**

**Experimental conditions.**

<b>Grid size (mm x mm)</b>	50.0, 50.0
<b>Step (mm)</b>	5
<b>Band</b>	GSM1900
<b>Channel</b>	Middle
<b>Signal</b>	GSM
<b>Date of measurement</b>	5/31/2021

**HAC Measurement Results**

Middle Band (Channel 661):

Frequency (MHz): 1880.000000

Maximum value of total field = 28.30 dB (V/m)

**Hearing Aid Near-Field Category: M4**

**SURFACE HAC**

**E in dB (V/m)**

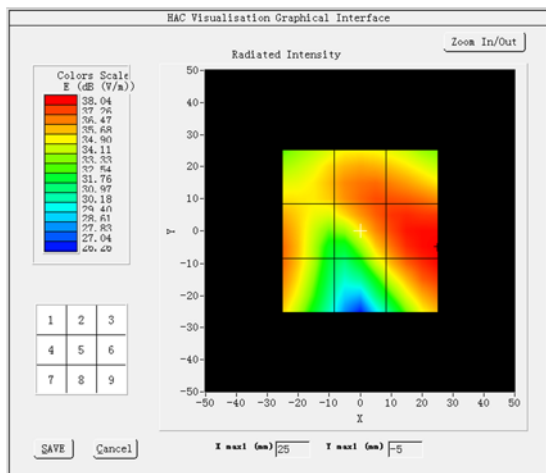

Grid 1: 26.90	Grid 2: 28.11	<b>Grid 3: 28.03</b>
Grid 4: 27.76	<b>Grid 5: 28.30</b>	<b>Grid 6: 29.04</b>
Grid 7: 27.75	Grid 8: 26.84	<b>Grid 9: 29.01</b>

**MEASUREMENT 9**

**Experimental conditions.**

<b>Grid size (mm x mm)</b>	50.0, 50.0
<b>Step (mm)</b>	5
<b>Band</b>	GSM1900
<b>Channel</b>	High
<b>Signal</b>	GSM
<b>Date of measurement</b>	5/31/2021

**HAC Measurement Results**

Higher Band (Channel 810):

Frequency (MHz): 1909.800000

Maximum value of total field = 28.62 dB (V/m)

**Hearing Aid Near-Field Category: M4**

SURFACE HAC

E in dB (V/m)

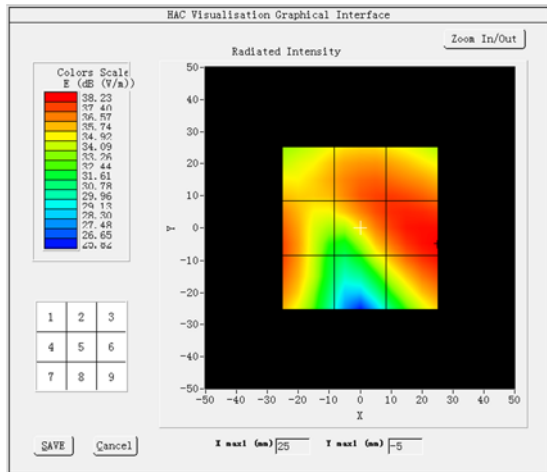

Grid 1: 27.12	Grid 2: 28.47	Grid 3: 28.47
Grid 4: 28.36	Grid 5: 28.62	Grid 6: 29.22
Grid 7: 28.36	Grid 8: 26.81	Grid 9: 29.09

**MEASUREMENT 10**

**Experimental conditions.**

<b>Grid size (mm x mm)</b>	50.0, 50.0
<b>Step (mm)</b>	5
<b>Band</b>	GSM1900
<b>Channel</b>	Low
<b>Signal</b>	GSM
<b>Date of measurement</b>	5/28/2021

**HAC Measurement Results**

Lower Band (Channel 512):

Frequency (MHz): 1850.200000

Maximum value of total field = 21.60 dB (V/m)

**Hearing Aid Near-Field Category: M4**

SURFACE HAC

E in dB (V/m)

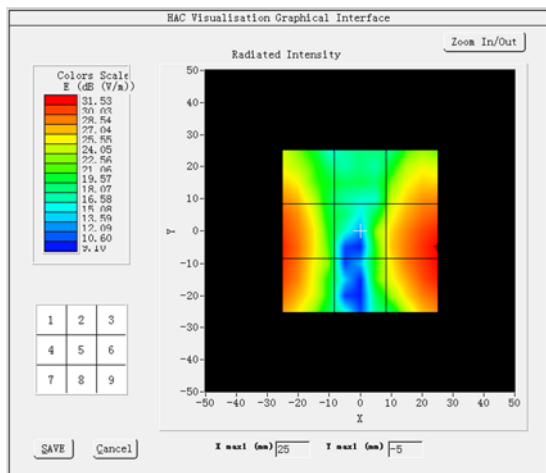

Grid 1: 19.18	Grid 2: 13.91	<b>Grid 3: 19.24</b>
<b>Grid 4: 21.60</b>	Grid 5: 17.01	<b>Grid 6: 22.55</b>
Grid 7: 21.45	Grid 8: 16.39	<b>Grid 9: 22.48</b>



**MEASUREMENT 11**

**Experimental conditions.**

<b>Grid size (mm x mm)</b>	50.0, 50.0
<b>Step (mm)</b>	5
<b>Band</b>	GSM1900
<b>Channel</b>	Middle
<b>Signal</b>	GSM
<b>Date of measurement</b>	5/31/2021

**HAC Measurement Results**

Middle Band (Channel 661):

Frequency (MHz): 1880.000000

Maximum value of total field = 21.89 dB (V/m)

**Hearing Aid Near-Field Category: M4**

SURFACE HAC

E in dB (V/m)

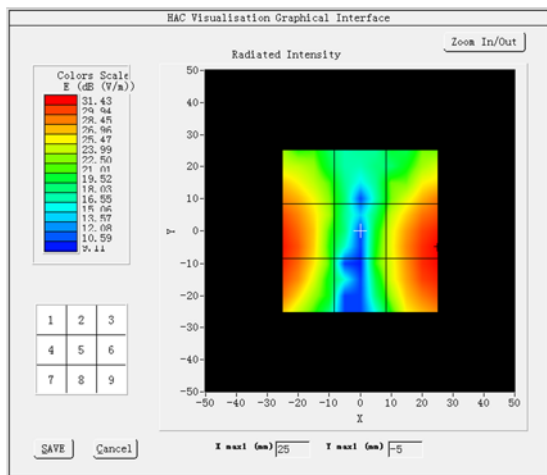

Grid 1: 19.18	Grid 2: 12.71	Grid 3: 19.56
Grid 4: 21.89	Grid 5: 15.38	Grid 6: 22.44
Grid 7: 21.74	Grid 8: 15.32	Grid 9: 22.37

**MEASUREMENT 12**

**Experimental conditions.**

<b>Grid size (mm x mm)</b>	50.0, 50.0
<b>Step (mm)</b>	5
<b>Band</b>	GSM1900
<b>Channel</b>	High
<b>Signal</b>	GSM
<b>Date of measurement</b>	5/31/2021

**HAC Measurement Results**

Higher Band (Channel 810):

Frequency (MHz): 1909.800000

Maximum value of total field = 21.46 dB (V/m)

**Hearing Aid Near-Field Category: M4**

**SURFACE HAC**

**E in dB (V/m)**

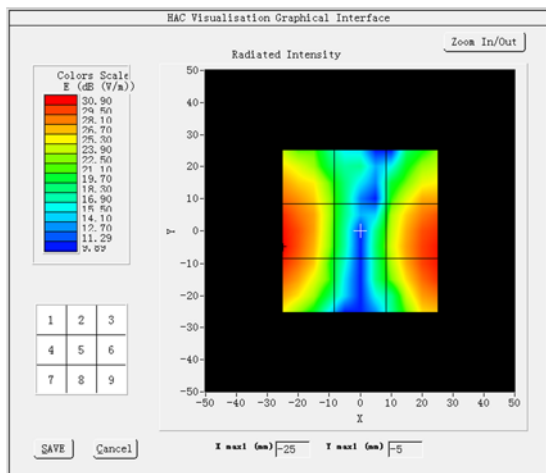

<b>Grid 1: 19.52</b>	Grid 2: 11.26	Grid 3: 18.18
<b>Grid 4: 21.91</b>	Grid 5: 14.38	<b>Grid 6: 21.46</b>
<b>Grid 7: 21.43</b>	Grid 8: 13.91	Grid 9: 21.44

**MEASUREMENT 13**

**Experimental conditions.**

<b>Grid size (mm x mm)</b>	50.0, 50.0
<b>Step (mm)</b>	5
<b>Band</b>	LTE band 38
<b>Channel</b>	Low
<b>Signal</b>	LTE
<b>Date of measurement</b>	6/1/2021

**HAC Measurement Results**

Lower Band (Channel 37850):

Frequency (MHz): 2580.000000

Maximum value of total field = 21.28 dB (V/m)

**Hearing Aid Near-Field Category: M4**

**SURFACE HAC**

**E in dB (V/m)**

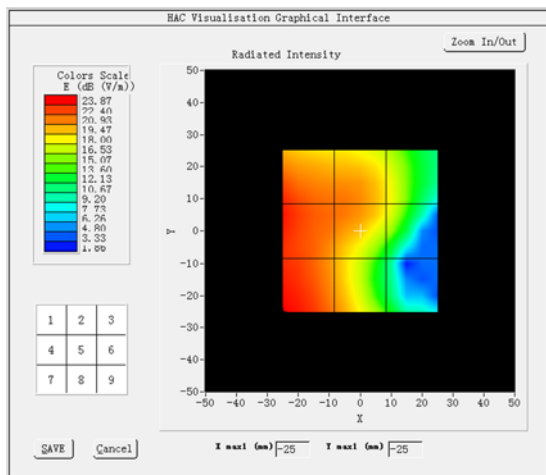

<b>Grid 1: 22.99</b>	Grid 2: 21.19	Grid 3: 17.82
<b>Grid 4: 23.38</b>	<b>Grid 5: 21.28</b>	Grid 6: 17.71
<b>Grid 7: 23.87</b>	Grid 8: 20.46	Grid 9: 13.01

**MEASUREMENT 14**

**Experimental conditions.**

<b>Grid size (mm x mm)</b>	50.0, 50.0
<b>Step (mm)</b>	5
<b>Band</b>	LTE band 38
<b>Channel</b>	Middle
<b>Signal</b>	LTE
<b>Date of measurement</b>	6/1/2021

**HAC Measurement Results**

Middle Band (Channel 38000):

Frequency (MHz): 2595.000000

Maximum value of total field = 21.91 dB (V/m)

**Hearing Aid Near-Field Category: M4**

SURFACE HAC

E in dB (V/m)

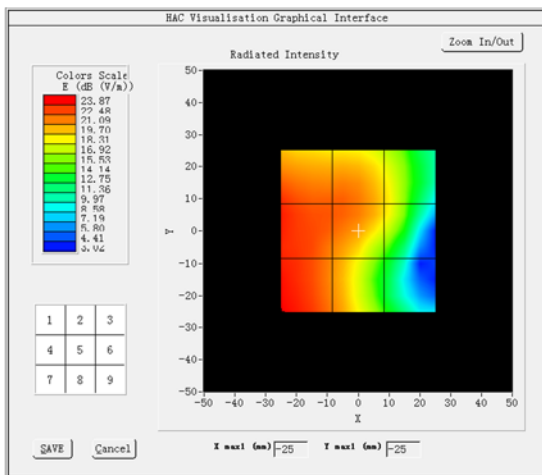

<b>Grid 1: 22.81</b>	Grid 2: 21.78	Grid 3: 18.48
<b>Grid 4: 23.26</b>	<b>Grid 5: 21.91</b>	Grid 6: 18.49
<b>Grid 7: 23.87</b>	Grid 8: 20.78	Grid 9: 13.72

**MEASUREMENT 15**

**Experimental conditions.**

<b>Grid size (mm x mm)</b>	50.0, 50.0
<b>Step (mm)</b>	5
<b>Band</b>	LTE band 38
<b>Channel</b>	High
<b>Signal</b>	LTE
<b>Date of measurement</b>	6/1/2021

**HAC Measurement Results**

Higher Band (Channel 38150):

Frequency (MHz): 2610.000000

Maximum value of total field = 21.43 dB (V/m)

**Hearing Aid Near-Field Category: M4**

SURFACE HAC

E in dB (V/m)

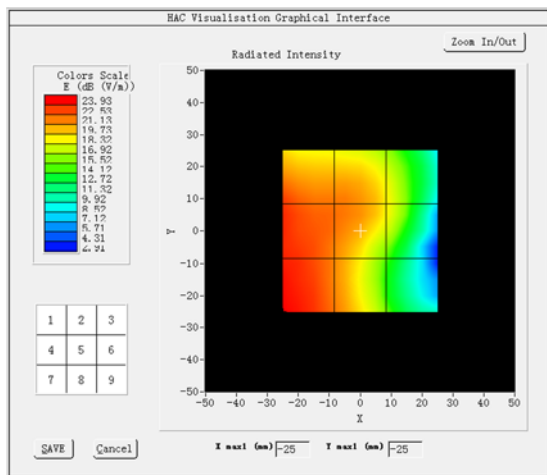

Grid 1: 22.58	Grid 2: 21.22	Grid 3: 17.79
Grid 4: 23.13	Grid 5: 21.43	Grid 6: 17.83
Grid 7: 23.93	Grid 8: 21.00	Grid 9: 14.46

**MEASUREMENT 16**

**Experimental conditions.**

<b>Grid size (mm x mm)</b>	50.0, 50.0
<b>Step (mm)</b>	5
<b>Band</b>	LTE band 38
<b>Channel</b>	Low
<b>Signal</b>	LTE
<b>Date of measurement</b>	6/1/2021

**HAC Measurement Results**

Lower Band (Channel 37850):

Frequency (MHz): 2580.000000

Maximum value of total field = 14.90 dB (V/m)

**Hearing Aid Near-Field Category: M4**

SURFACE HAC

E in dB (V/m)

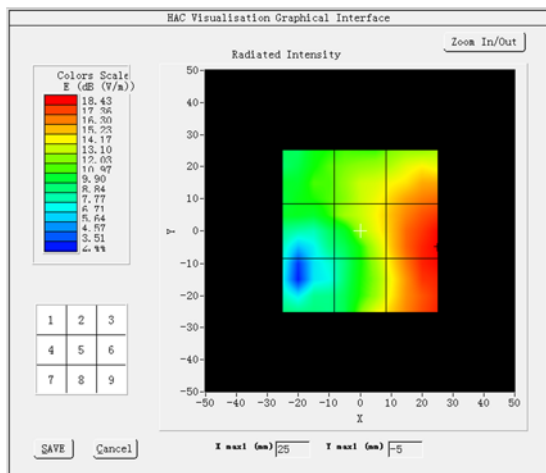

Grid 1: 11.72	Grid 2: 14.57	Grid 3: 16.61
Grid 4: 11.88	Grid 5: 14.90	Grid 6: 18.43
Grid 7: 8.73	Grid 8: 14.65	Grid 9: 18.37

**MEASUREMENT 17**

**Experimental conditions.**

<b>Grid size (mm x mm)</b>	50.0, 50.0
<b>Step (mm)</b>	5
<b>Band</b>	LTE band 38
<b>Channel</b>	Middle
<b>Signal</b>	LTE
<b>Date of measurement</b>	6/1/2021

**HAC Measurement Results**

Middle Band (Channel 38000):

Frequency (MHz): 2595.000000

Maximum value of total field = 16.05 dB (V/m)

**Hearing Aid Near-Field Category: M4**

SURFACE HAC

E in dB (V/m)

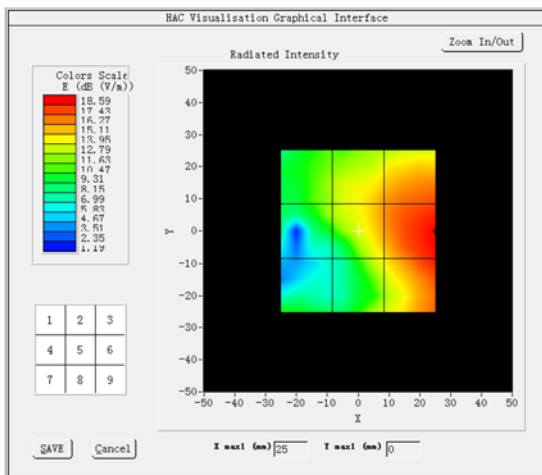

Grid 1: 12.43	Grid 2: 15.66	Grid 3: 17.08
Grid 4: 12.47	Grid 5: 16.05	Grid 6: 18.61
Grid 7: 10.14	Grid 8: 14.52	Grid 9: 18.25

**MEASUREMENT 18**

**Experimental conditions.**

<b>Grid size (mm x mm)</b>	50.0, 50.0
<b>Step (mm)</b>	5
<b>Band</b>	LTE band 38
<b>Channel</b>	High
<b>Signal</b>	LTE
<b>Date of measurement</b>	6/1/2021

**HAC Measurement Results**

Higher Band (Channel 38150):

Frequency (MHz): 2610.000000

Maximum value of total field = 16.32 dB (V/m)

**Hearing Aid Near-Field Category: M4**

SURFACE HAC

E in dB (V/m)

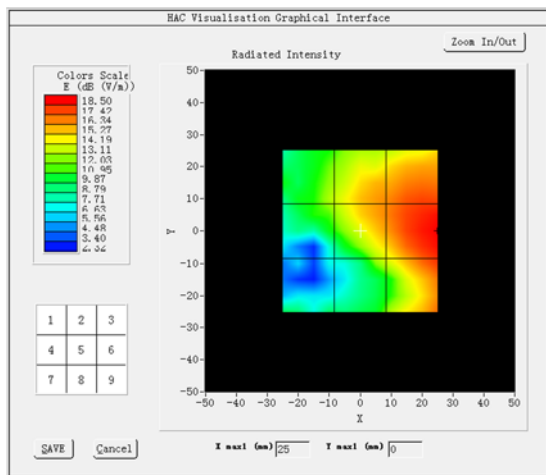

Grid 1: 13.18	Grid 2: 16.15	Grid 3: 17.31
Grid 4: 13.08	Grid 5: 16.32	Grid 6: 18.50
Grid 7: 9.17	Grid 8: 14.03	Grid 9: 17.86



**MEASUREMENT 19**

**Experimental conditions.**

<b>Grid size (mm x mm)</b>	50.0, 50.0
<b>Step (mm)</b>	5
<b>Band</b>	LTE band 41
<b>Channel</b>	Low
<b>Signal</b>	LTE
<b>Date of measurement</b>	6/1/2021

**HAC Measurement Results**

Lower Band (Channel 39750):

Frequency (MHz): 2506.000000

Maximum value of total field = 20.55 dB (V/m)

**Hearing Aid Near-Field Category: M4**

**SURFACE HAC**

**E in dB (V/m)**

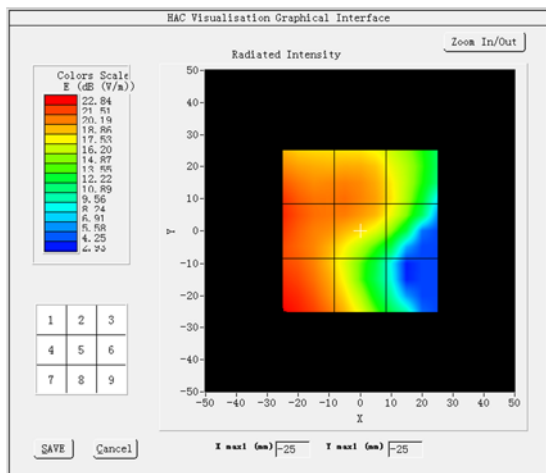

<b>Grid 1: 21.75</b>	<b>Grid 2: 20.55</b>	Grid 3: 17.89
<b>Grid 4: 22.00</b>	Grid 5: 20.54	Grid 6: 17.83
<b>Grid 7: 22.84</b>	Grid 8: 19.57	Grid 9: 11.66

**MEASUREMENT 20**

**Experimental conditions.**

<b>Grid size (mm x mm)</b>	50.0, 50.0
<b>Step (mm)</b>	5
<b>Band</b>	LTE band 41
<b>Channel</b>	Middle
<b>Signal</b>	LTE
<b>Date of measurement</b>	6/1/2021

**HAC Measurement Results**

Middle Band (Channel 40185):

Frequency (MHz): 2549.500000

Maximum value of total field = 21.53 dB (V/m)

**Hearing Aid Near-Field Category: M4**

SURFACE HAC

E in dB (V/m)

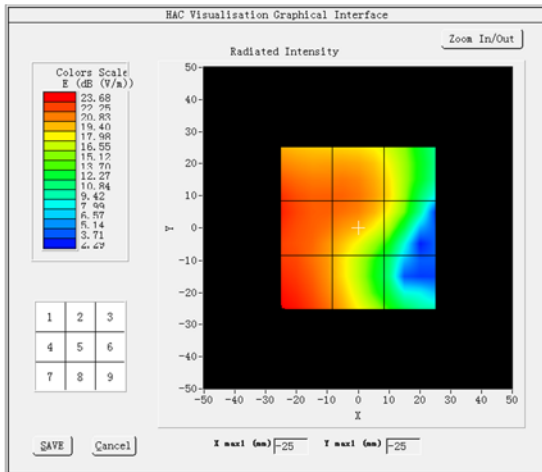

<b>Grid 1: 22.57</b>	Grid 2: 21.51	Grid 3: 18.61
<b>Grid 4: 22.95</b>	<b>Grid 5: 21.53</b>	Grid 6: 18.54
<b>Grid 7: 23.68</b>	Grid 8: 20.42	Grid 9: 13.80

**MEASUREMENT 21**

**Experimental conditions.**

<b>Grid size (mm x mm)</b>	50.0, 50.0
<b>Step (mm)</b>	5
<b>Band</b>	LTE band 41
<b>Channel</b>	Middle
<b>Signal</b>	LTE
<b>Date of measurement</b>	6/1/2021

**HAC Measurement Results**

Middle Band (Channel 40620):

Frequency (MHz): 2593.000000

Maximum value of total field = 22.03 dB (V/m)

**Hearing Aid Near-Field Category: M4**

SURFACE HAC

E in dB (V/m)

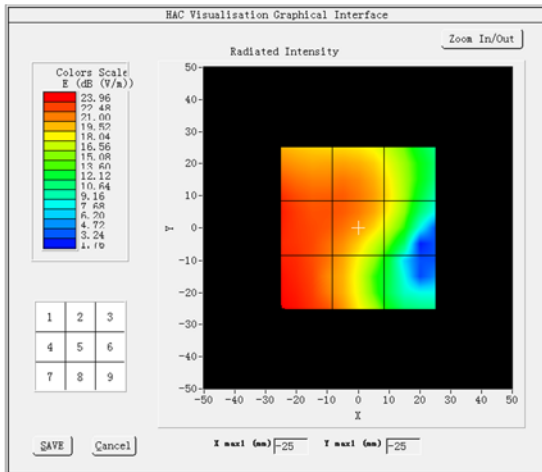

<b>Grid 1: 22.07</b>	Grid 2: 21.86	Grid 3: 18.44
<b>Grid 4: 23.29</b>	<b>Grid 5: 22.03</b>	Grid 6: 18.42
<b>Grid 7: 23.96</b>	Grid 8: 21.21	Grid 9: 12.96

**MEASUREMENT 22**

**Experimental conditions.**

<b>Grid size (mm x mm)</b>	50.0, 50.0
<b>Step (mm)</b>	5
<b>Band</b>	LTE band 41
<b>Channel</b>	Middle
<b>Signal</b>	LTE
<b>Date of measurement</b>	6/1/2021

**HAC Measurement Results**

Middle Band (Channel 41055):

Frequency (MHz): 2636.500000

Maximum value of total field = 20.53 dB (V/m)

**Hearing Aid Near-Field Category: M4**

SURFACE HAC

E in dB (V/m)

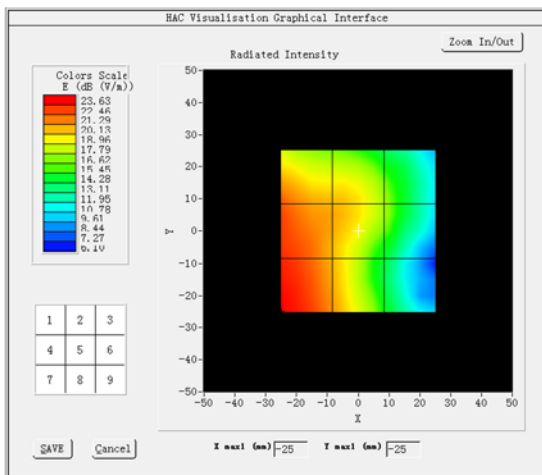

<b>Grid 1: 21.82</b>	Grid 2: 19.97	Grid 3: 16.54
<b>Grid 4: 22.79</b>	Grid 5: 20.36	Grid 6: 16.65
<b>Grid 7: 23.63</b>	<b>Grid 8: 20.53</b>	Grid 9: 14.51

**MEASUREMENT 23**

**Experimental conditions.**

<b>Grid size (mm x mm)</b>	50.0, 50.0
<b>Step (mm)</b>	5
<b>Band</b>	LTE band 41
<b>Channel</b>	High
<b>Signal</b>	LTE
<b>Date of measurement</b>	6/1/2021

**HAC Measurement Results**

Higher Band (Channel 41490):

Frequency (MHz): 2680.000000

Maximum value of total field = 21.24 dB (V/m)

**Hearing Aid Near-Field Category: M4**

**SURFACE HAC**

**E in dB (V/m)**

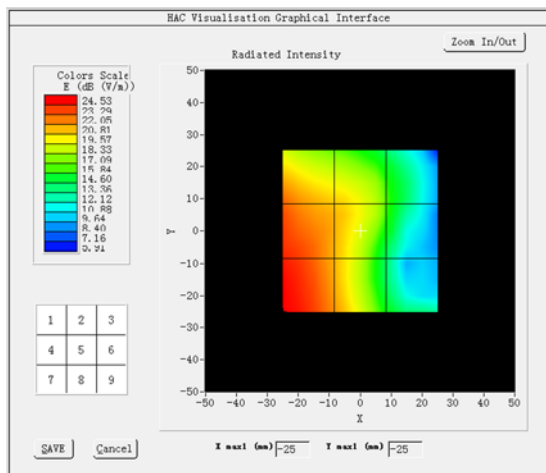

<b>Grid 1: 22.44</b>	Grid 2: 20.19	Grid 3: 15.80
<b>Grid 4: 23.77</b>	Grid 5: 20.77	Grid 6: 15.76
<b>Grid 7: 24.54</b>	<b>Grid 8: 21.24</b>	Grid 9: 14.82

**MEASUREMENT 24**

**Experimental conditions.**

<b>Grid size (mm x mm)</b>	50.0, 50.0
<b>Step (mm)</b>	5
<b>Band</b>	LTE band 41
<b>Channel</b>	Low
<b>Signal</b>	LTE
<b>Date of measurement</b>	6/1/2021

**HAC Measurement Results**

Lower Band (Channel 39750):

Frequency (MHz): 2506.000000

Maximum value of total field = 15.70 dB (V/m)

**Hearing Aid Near-Field Category: M4**

SURFACE HAC

E in dB (V/m)

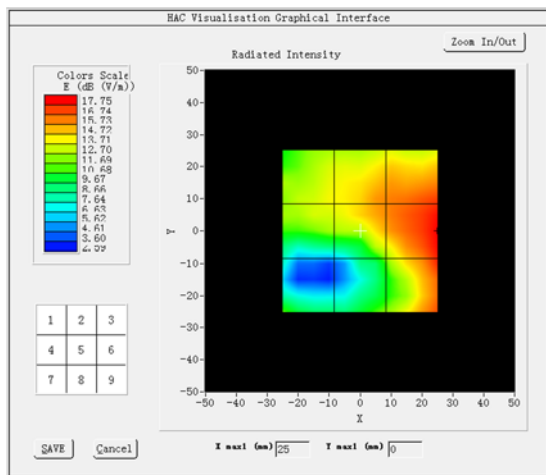

Grid 1: 13.67	Grid 2: 15.66	<b>Grid 3: 16.74</b>
Grid 4: 13.59	<b>Grid 5: 15.70</b>	<b>Grid 6: 17.75</b>
Grid 7: 11.26	Grid 8: 12.29	<b>Grid 9: 17.34</b>

**MEASUREMENT 25**

**Experimental conditions.**

<b>Grid size (mm x mm)</b>	50.0, 50.0
<b>Step (mm)</b>	5
<b>Band</b>	LTE band 41
<b>Channel</b>	Middle
<b>Signal</b>	LTE
<b>Date of measurement</b>	6/1/2021

**HAC Measurement Results**

Middle Band (Channel 40185):

Frequency (MHz): 2549.500000

Maximum value of total field = 15.69 dB (V/m)

**Hearing Aid Near-Field Category: M4**

SURFACE HAC

E in dB (V/m)

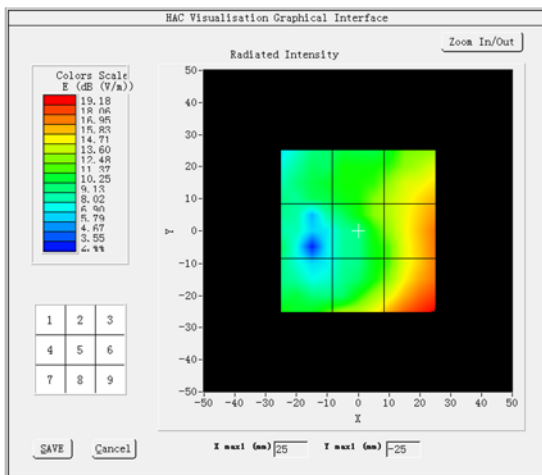

<b>Grid 1: 10.76</b>	Grid 2: 13.20	Grid 3: 15.85
<b>Grid 4: 10.01</b>	Grid 5: 13.24	Grid 6: 17.16
<b>Grid 7: 12.41</b>	<b>Grid 8: 15.69</b>	Grid 9: 19.18

**MEASUREMENT 26**

**Experimental conditions.**

<b>Grid size (mm x mm)</b>	50.0, 50.0
<b>Step (mm)</b>	5
<b>Band</b>	LTE band 41
<b>Channel</b>	Middle
<b>Signal</b>	LTE
<b>Date of measurement</b>	6/1/2021

**HAC Measurement Results**

Middle Band (Channel 40620):

Frequency (MHz): 2593.000000

Maximum value of total field = 16.91 dB (V/m)

**Hearing Aid Near-Field Category: M4**

SURFACE HAC

E in dB (V/m)

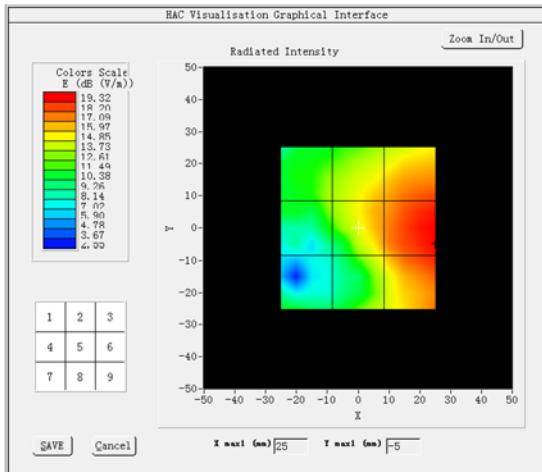

Grid 1: 13.30	Grid 2: 16.20	Grid 3: 18.07
Grid 4: 13.27	Grid 5: 16.91	Grid 6: 19.37
Grid 7: 10.68	Grid 8: 15.97	Grid 9: 18.94



**MEASUREMENT 27**

**Experimental conditions.**

<b>Grid size (mm x mm)</b>	50.0, 50.0
<b>Step (mm)</b>	5
<b>Band</b>	LTE band 41
<b>Channel</b>	Middle
<b>Signal</b>	LTE
<b>Date of measurement</b>	6/1/2021

**HAC Measurement Results**

Middle Band (Channel 41055):

Frequency (MHz): 2636.500000

Maximum value of total field = 17.10 dB (V/m)

**Hearing Aid Near-Field Category: M4**

SURFACE HAC

E in dB (V/m)

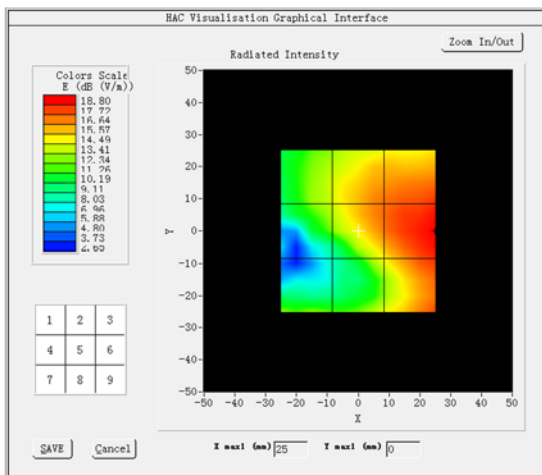

Grid 1: 13.89	Grid 2: 16.82	<b>Grid 3: 17.78</b>
Grid 4: 13.69	<b>Grid 5: 17.10</b>	<b>Grid 6: 18.80</b>
Grid 7: 12.44	Grid 8: 14.89	<b>Grid 9: 18.14</b>

**MEASUREMENT 28**

**Experimental conditions.**

<b>Grid size (mm x mm)</b>	50.0, 50.0
<b>Step (mm)</b>	5
<b>Band</b>	LTE band 41
<b>Channel</b>	High
<b>Signal</b>	LTE
<b>Date of measurement</b>	6/1/2021

**HAC Measurement Results**

Higher Band (Channel 41490):

Frequency (MHz): 2680.000000

Maximum value of total field = 17.47 dB (V/m)

**Hearing Aid Near-Field Category: M4**

SURFACE HAC

E in dB (V/m)

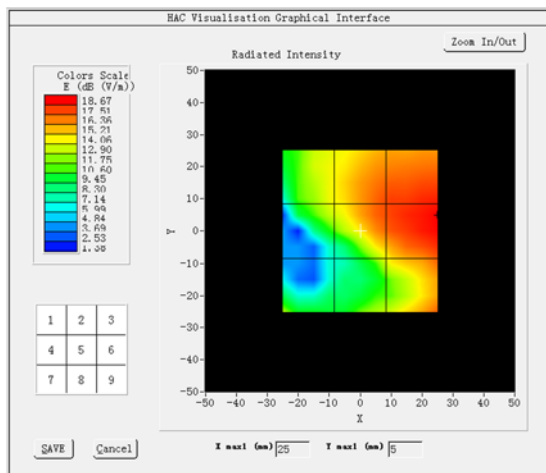

Grid 1: 14.16	<b>Grid 2: 17.44</b>	<b>Grid 3: 18.04</b>
Grid 4: 13.96	<b>Grid 5: 17.47</b>	<b>Grid 6: 18.70</b>
Grid 7: 12.28	Grid 8: 14.35	Grid 9: 17.14

## **ANNEX C TEST SETUP PHOTO**

Please refer the document "BL-SZ2150617-AS-2.pdf".

## **ANNEX D EUT EXTERNAL PHOTO**

Please refer the document "BL-SZ2150617-AW.pdf".

## **ANNEX E CALIBRATION REPORT**

Please refer the document "CALIBRATION REPORT\_HAC.pdf".

--END OF REPORT--