

1

2

3

4

NOTES:

*** ARTWORK IS THE MASTER FOR COLOUR, FONT, SIZE & LOGO'S***

- 1. TEST FOR MARKINGS: REFER TO CQCS
- 2. LOCATION OF MARKING: POSITION AS SHOWN
- 3. FONT: ARIAL ROUNDED
- 4. TEXT HEIGHT: AS INDICATED
- 5. SQUARE D LOGO SIZE: 2.73MM(H)*13.79MM(L)  (Pantone Cool grey 6C)
- 6. MINIMUM SIZE:

7. MINIMUM SIZE:

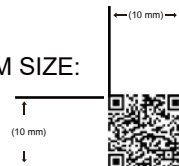

FONT SIZE: XXXXX (> 5 pt)

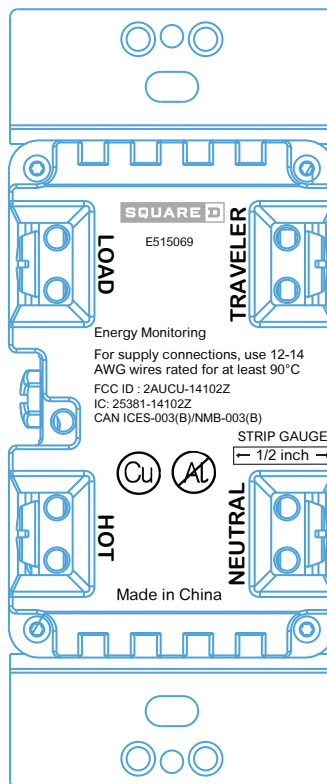
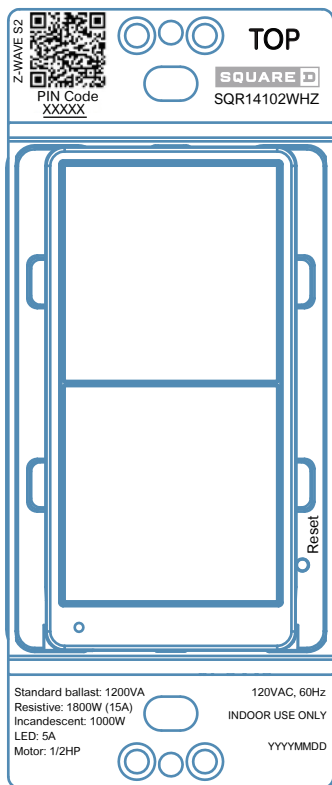
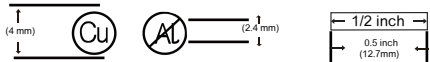

All Laser Marking

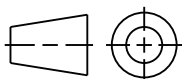

Scale: 1.000

Technical Specification:

Units of measure : mm



MARKING DETAIL Z-WAVE PLUS SWITCH

Document Number:

Doc. Rev. 00

Sheet: 1/1

The information is highly confidential and is the exclusive property of Schneider Electric copyright reserved. This drawing must not be used for any purpose other than that expressly permitted in writing by the owners and must not be disclosed or reproduced in any way without permission from the owners in writing. This drawing must be returned to the owners when the purpose has ceased.

State:

Provisional

1

2

3

4

NOTES:

*** ARTWORK IS THE MASTER FOR COLOUR, FONT, SIZE & LOGO'S***

- 1. TEST FOR MARKINGS: REFER TO CQCS
- 2. LOCATION OF MARKING: POSITION AS SHOWN
- 3. FONT: ARIAL ROUNDED
- 4. TEXT HEIGHT: AS INDICATED
- 5. MINIMUM SIZE:



(Z-WAVE Logo Color: Black)

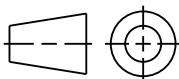
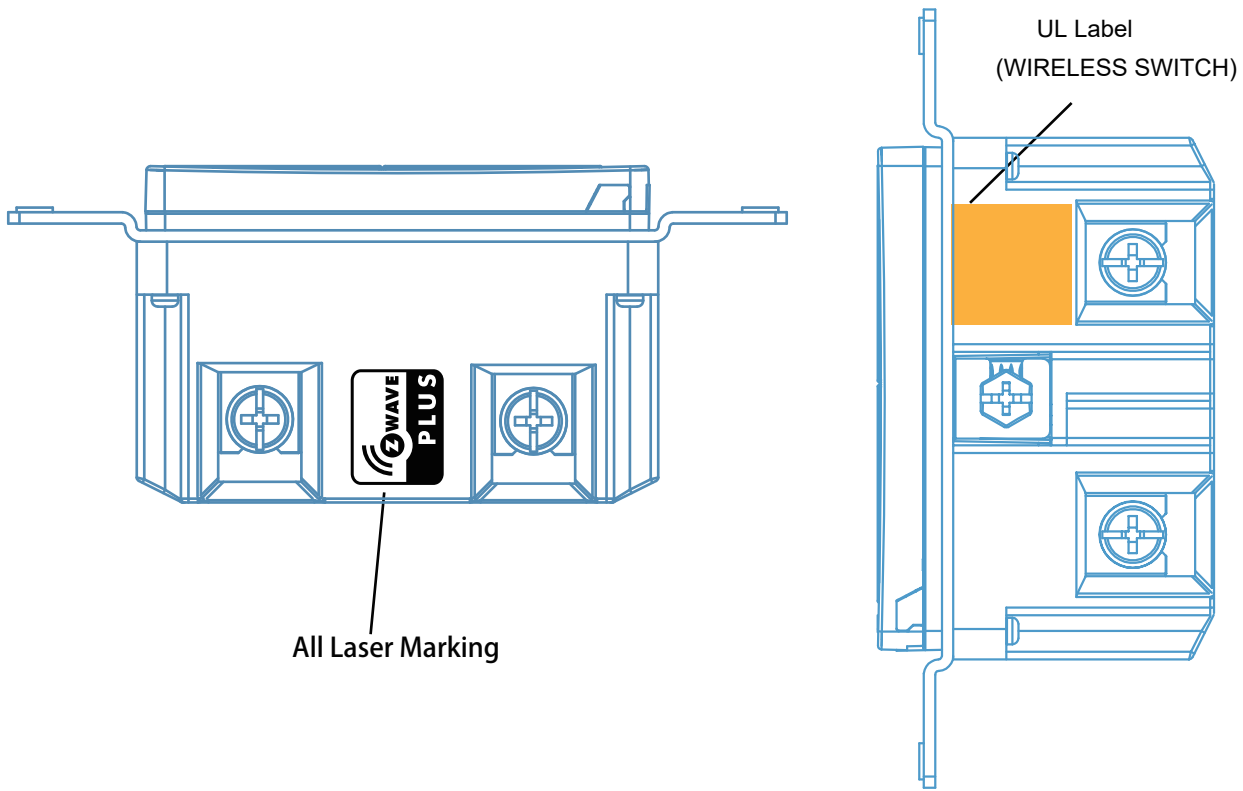

Scale: 1.000

Technical Specification:

Units of measure : mm



MARKING DETAIL Z-WAVE PLUS SWITCH

Document Number:

Doc. Rev. 00

Sheet: 1/1

State:

Provisional