



**CFR 47 FCC PART 15 SUBPART C
ISED RSS-247 ISSUE 2**

TEST REPORT

For

WI-FI SWITCH, SINGLE POLE, REQUIRES NEUTRAL

MODEL NUMBER: SQR14101WHW

**FCC ID: 2AUCU-14101W
IC: 25381-14101W**

REPORT NUMBER: 4789139419.4-1

ISSUE DATE: September 18, 2019

Prepared for

**Schneider Electric (China) Co., Ltd., Shenzhen Branch
Room 201, Building A, No. 1 Qianwanyi Road, Shengang Cooperation Zone,
Qianhai, Shenzhen, China**

Prepared by

**UL Verification Services (Guangzhou) Co., Ltd, Song Shan Lake Branch
Building 10, Innovation Technology Park, No. 1, Li Bin Road, Song Shan Lake
Hi-Tech Development Zone Dongguan, People's Republic of China**

Tel: +86 769 22038881

Fax: +86 769 33244054

Website: www.ul.com



Revision History

<u>Rev.</u>	<u>Issue Date</u>	<u>Revisions</u>	<u>Revised By</u>
V0	9/18/2019	Initial Issue	



Summary of Test Results			
Clause	Test Items	FCC/ISED Rules	Test Results
1	6dB Bandwidth and 99% Occupied Bandwidth	FCC Part 15.247 (a) (2) RSS-247 Clause 5.2 (a) ISED RSS-Gen Clause 6.7	Pass
2	Peak Conducted Output Power	FCC Part 15.247 (b) (3) RSS-247 Clause 5.4 (d)	Pass
3	Power Spectral Density	FCC Part 15.247 (e) RSS-247 Clause 5.2 (b)	Pass
4	Conducted Bandedge and Spurious Emission	FCC Part 15.247 (d) RSS-247 Clause 5.5	Pass
5	Radiated Bandedge and Spurious Emission	FCC Part 15.247 (d) FCC Part 15.209 FCC Part 15.205 RSS-247 Clause 5.5 RSS-GEN Clause 8.9	Pass
6	Conducted Emission Test For AC Power Port	FCC Part 15.207 RSS-GEN Clause 8.8	Pass
7	Antenna Requirement	FCC Part 15.203 RSS-GEN Clause 6.8	Pass
Note: This test report is only published to and used by the applicant, and it is not for evidence purpose in China.			



TABLE OF CONTENTS

1. ATTESTATION OF TEST RESULTS	6
2. TEST METHODOLOGY	7
3. FACILITIES AND ACCREDITATION	7
4. CALIBRATION AND UNCERTAINTY	8
4.1. <i>MEASURING INSTRUMENT CALIBRATION</i>	<i>8</i>
4.2. <i>MEASUREMENT UNCERTAINTY.....</i>	<i>8</i>
5. EQUIPMENT UNDER TEST	9
5.1. <i>DESCRIPTION OF EUT</i>	<i>9</i>
5.2. <i>MAXIMUM OUTPUT POWER.....</i>	<i>9</i>
5.3. <i>CHANNEL LIST.....</i>	<i>9</i>
5.4. <i>TEST CHANNEL CONFIGURATION.....</i>	<i>9</i>
5.5. <i>THE WORSE CASE POWER SETTING PARAMETER.....</i>	<i>10</i>
5.6. <i>THE WORSE CASE CONFIGURATIONS</i>	<i>10</i>
5.7. <i>DESCRIPTION OF AVAILABLE ANTENNAS</i>	<i>10</i>
5.8. <i>DESCRIPTION OF TEST SETUP.....</i>	<i>11</i>
6. MEASURING INSTRUMENT AND SOFTWARE USED	12
7. MEASUREMENT METHODS	13
8. ANTENNA PORT TEST RESULTS	14
8.1. <i>ON TIME AND DUTY CYCLE.....</i>	<i>14</i>
8.2. <i>6 dB DTS BANDWIDTH AND 99% OCCUPIED BANDWIDTH</i>	<i>17</i>
8.2.1. <i>802.11b MODE</i>	<i>18</i>
8.2.2. <i>802.11g MODE</i>	<i>22</i>
8.2.3. <i>802.11n HT20 MODE</i>	<i>26</i>
8.3. <i>PEAK CONDUCTED OUTPUT POWER.....</i>	<i>30</i>
8.3.1. <i>802.11b MODE</i>	<i>31</i>
8.3.2. <i>802.11g MODE</i>	<i>31</i>
8.3.3. <i>802.11n HT20 MODE</i>	<i>31</i>
8.4. <i>POWER SPECTRAL DENSITY</i>	<i>32</i>
8.4.1. <i>802.11b MODE</i>	<i>33</i>
8.4.2. <i>802.11g MODE</i>	<i>35</i>
8.4.3. <i>802.11n HT20 MODE</i>	<i>37</i>
8.5. <i>CONDUCTED BANDEDGE AND SPURIOUS EMISSIONS.....</i>	<i>39</i>
8.5.1. <i>802.11b MODE</i>	<i>41</i>
8.5.1. <i>802.11g MODE</i>	<i>44</i>
8.5.1. <i>802.11n HT20 MODE</i>	<i>47</i>



9. RADIATED TEST RESULTS.....	50
9.1. <i>RESTRICTED BANDEDGE</i>	56
9.1.1. 802.11b MODE	56
9.1.2. 802.11g MODE	63
9.1.3. 802.11n HT20 MODE	71
9.2. <i>SPURIOUS EMISSIONS (3~18GHz)</i>	79
9.2.1. 802.11b MODE	79
9.2.2. 802.11g MODE	85
9.2.3. 802.11n HT20 MODE	91
9.3. <i>SPURIOUS EMISSIONS (1~3GHz)</i>	97
9.3.1. 802.11b MODE	97
9.3.2. 802.11g MODE	103
9.3.3. 802.11n HT20 MODE	109
9.4. <i>SPURIOUS EMISSIONS (18~26GHz)</i>	115
9.4.1. 802.11g MODE	115
9.5. <i>SPURIOUS EMISSIONS (0.03 ~ 1 GHz)</i>	117
9.5.1. 802.11g MODE	117
9.6. <i>SPURIOUS EMISSIONS BELOW 30M</i>	119
9.6.1. 802.11g MODE	119
10. AC POWER LINE CONDUCTED EMISSIONS	122
10.1. 802.11g MODE.....	123
11. ANTENNA REQUIREMENTS	125



1. ATTESTATION OF TEST RESULTS

Applicant Information

Company Name: Schneider Electric (China) Co., Ltd., Shenzhen Branch
Address: Room 201, Building A, No. 1 Qianwanyi Road, Shengang Cooperation Zone, Qianhai, Shenzhen, China

Manufacturer Information

Company Name: Schneider Electric (China) Co., Ltd., Shenzhen Branch
Address: Room 201, Building A, No. 1 Qianwanyi Road, Shengang Cooperation Zone, Qianhai, Shenzhen, China

EUT Description

EUT Name: WI-FI SWITCH, SINGLE POLE, REQUIRES NEUTRAL
Model: SQR14101WHW
Series Model: SQR14101LAW, SQR14101BKW
Model difference: All the same expect have different colors.
Sample Status: Normal
Sample ID: 2530541
Sample Received Date: September 03, 2019
Date of Tested: September 04~18, 2019

APPLICABLE STANDARDS	
STANDARD	TEST RESULTS
CFR 47 FCC PART 15 SUBPART C	PASS
ISED RSS-247 Issue 2	PASS
ISED RSS-GEN Issue 5	PASS

Prepared By:

Checked By:

Kebo Zhang
Engineer Project Associate

Shawn Wen
Laboratory Leader

Approved By:

Stephen Guo
Laboratory Manager



2. TEST METHODOLOGY

The tests documented in this report were performed in accordance with KDB 558074 D01 15.247 Meas Guidance v05r02, KDB 414788 D01 Radiated Test Site v01r01, CFR 47 FCC Part 2, CFR 47 FCC Part 15, ANSI C63.10-2013, ISED RSS-247 Issue 2 and ISED RSS-GEN Issue 5.

3. FACILITIES AND ACCREDITATION

Accreditation Certificate	<p>A2LA (Certificate No.: 4102.01) UL Verification Services (Guangzhou) Co., Ltd. Song Shan Lake Branch. has been assessed and proved to be in compliance with A2LA.</p> <p>FCC (FCC Designation No.: CN1187) UL Verification Services (Guangzhou) Co., Ltd. Song Shan Lake Branch. Has been recognized to perform compliance testing on equipment subject to the Commission's Declaration of Conformity (DoC) and Certification rules</p> <p>ISED(Company No.: 21320) UL Verification Services (Guangzhou) Co., Ltd. Song Shan Lake Branch. has been registered and fully described in a report filed with ISED. The Company Number is 21320.</p> <p>VCCI (Registration No.: G-20019, R-20004, C-20012 and T-20011) UL Verification Services (Guangzhou) Co., Ltd. Song Shan Lake Branch. has been assessed and proved to be in compliance with VCCI, the Membership No. is 3793. Facility Name: Chamber D, the VCCI registration No. is G-20019 and R-20004 Shielding Room B , the VCCI registration No. is C-20012 and T-20011</p>
---------------------------	---

Note 1: All tests measurement facilities use to collect the measurement data are located at Building 10, Innovation Technology Park, Song Shan Lake Hi tech Development Zone, Dongguan, 523808, China

Note 2: The test anechoic chamber in UL Verification Services (Guangzhou) Co., Ltd. Song Shan Lake Branch had been calibrated and compared to the open field sites and the test anechoic chamber is shown to be equivalent to or worst case from the open field site.

Note 3: For below 30MHz, lab had performed measurements at test anechoic chamber and comparing to measurements obtained on an open field site. And these measurements below 30MHz had been correlated to measurements performed on an OFS.



4. CALIBRATION AND UNCERTAINTY

4.1. MEASURING INSTRUMENT CALIBRATION

The measuring equipment utilized to perform the tests documented in this report has been calibrated in accordance with the manufacturer's recommendations, and is traceable to recognize national standards.

4.2. MEASUREMENT UNCERTAINTY

Where relevant, the following measurement uncertainty levels have been estimated for tests performed on the apparatus:

Test Item	Uncertainty
Conduction emission	3.62dB
Radiation Emission test(include Fundamental emission) (9kHz-30MHz)	2.2dB
Radiation Emission test(include Fundamental emission) (30MHz-1GHz)	4.00dB
Radiation Emission test (1GHz to 26GHz)(include Fundamental emission)	5.78dB (1GHz-18Gz)
	5.23dB (18GHz-26Gz)
Note: This uncertainty represents an expanded uncertainty expressed at approximately the 95% confidence level using a coverage factor of k=2.	



5. EQUIPMENT UNDER TEST

5.1. DESCRIPTION OF EUT

EUT Name	WI-FI SWITCH, SINGLE POLE, REQUIRES NEUTRAL
Model	SQR14101WHW
Series Model	SQR14101LAW, SQR14101BKW
Model difference	All the same expect have different colors.
Radio Technology	IEEE802.11b/g/n HT20
Operation frequency	IEEE 802.11b: 2412MHz—2462MHz IEEE 802.11g: 2412MHz—2462MHz IEEE 802.11n HT20: 2412MHz—2462MHz
Modulation	IEEE 802.11b: DSSS(CCK) IEEE 802.11g: OFDM(64QAM, 16QAM, QPSK, BPSK) IEEE 802.11n HT20: OFDM (64QAM, 16QAM, QPSK,BPSK)
Rated Input	AC 120V, 60Hz

5.2. MAXIMUM OUTPUT POWER

Number of Transmit Chains (NTX)	IEE Std. 802.11	Frequency (MHz)	Channel Number	Max AVG Conducted Power (dBm)
1	IEEE 802.11b	2412-2462	1-11[11]	14.02
1	IEEE 802.11g	2412-2462	1-11[11]	14.68
1	IEEE 802.11n HT20	2412-2462	1-11[11]	13.65

5.3. CHANNEL LIST

Channel List for 802.11b/g/n (20 MHz)							
Channel	Frequency (MHz)	Channel	Frequency (MHz)	Channel	Frequency (MHz)	Channel	Frequency (MHz)
1	2412	4	2427	7	2442	10	2457
2	2417	5	2432	8	2447	11	2462
3	2422	6	2437	9	2452	/	/

5.4. TEST CHANNEL CONFIGURATION

Test Mode	Test Channel	Frequency
WiFi TX(802.11b)	Low, Middle, High	2412MHz, 2437MHz, 2462MHz
WiFi TX(802.11g)	Low, Middle, High	2412MHz, 2437MHz, 2462MHz
WiFi TX(802.11n HT20)	Low, Middle, High	2412MHz, 2437MHz, 2462MHz



5.5. THE WORSE CASE POWER SETTING PARAMETER

The Worst Case Power Setting Parameter under 2400 ~ 2483.5MHz Band				
Test Software		SecureCRT		
Modulation Mode	Transmit Antenna Number	Test Channel		
		NCB: 20MHz		
		CH 1	CH 6	CH 11
802.11b	1	18	24	24
802.11g	1	11	18	18
802.11n HT20	1	15	22	22

5.6. THE WORSE CASE CONFIGURATIONS

Worst-case data rates as provided by the client were:

- 802.11b mode: 1 Mbps
- 802.11g mode: 6 Mbps
- 802.11n HT20 mode: MCS0

5.7. DESCRIPTION OF AVAILABLE ANTENNAS

Antenna	Frequency (MHz)	Antenna Type	MAX Antenna Gain (dBi)
1	2412-2462	PIFA	2.7

Test Mode	Transmit and Receive Mode	Description
IEEE 802.11b	<input checked="" type="checkbox"/> 1TX, 1RX	ANT 1 can be used as transmitting/receiving antenna.
IEEE 802.11g	<input checked="" type="checkbox"/> 1TX, 1RX	ANT 1 can be used as transmitting/receiving antenna.
IEEE 802.11n HT20	<input checked="" type="checkbox"/> 1TX, 1RX	ANT 1 can be used as transmitting/receiving antenna.

5.8. DESCRIPTION OF TEST SETUP

SUPPORT EQUIPMENT

Item	Equipment	Brand Name	Model Name	P/N
1	PC	Dell	Vostro 3902	8KNDDDB2
2	USB TO UART	/	/	/

I/O CABLES

Cable No	Port	Connector Type	Cable Type	Cable Length(m)	Remarks
1	USB	/	/	1.0	/

ACCESSORIES

Item	Accessory	Brand Name	Model Name	Description
1	/		/	/

TEST SETUP

The EUT can work in engineering mode with a software through a Laptop.

SETUP DIAGRAM FOR TESTS

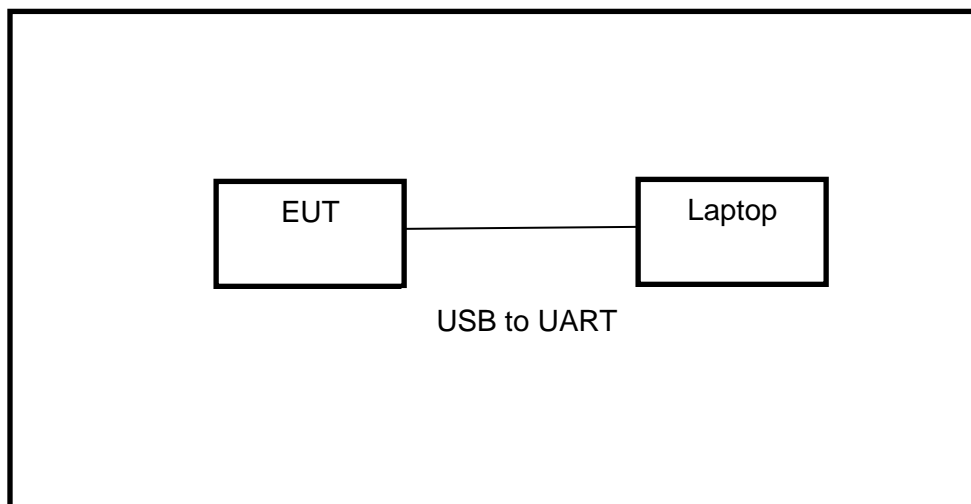



6. MEASURING INSTRUMENT AND SOFTWARE USED

Conducted Emissions						
Instrument						
Used	Equipment	Manufacturer	Model No.	Serial No.	Last Cal.	Next Cal.
<input checked="" type="checkbox"/>	EMI Test Receiver	R&S	ESR3	101961	Dec.10,2018	Dec.10,2019
<input checked="" type="checkbox"/>	Two-Line V-Network	R&S	ENV216	101983	Dec.10,2018	Dec.10,2019
<input checked="" type="checkbox"/>	Artificial Mains Networks	Schwarzbeck	NSLK 8126	8126465	Dec.10,2018	Dec.10,2019
Software						
Used	Description	Manufacturer	Name	Version		
<input checked="" type="checkbox"/>	Test Software for Conducted disturbance	Farad	EZ-EMC	Ver. UL-3A1		
Radiated Emissions						
Instrument						
Used	Equipment	Manufacturer	Model No.	Serial No.	Last Cal.	Next Cal.
<input checked="" type="checkbox"/>	MXE EMI Receiver	KESIGHT	N9038A	MY56400036	Dec.10,2018	Dec.10,2019
<input checked="" type="checkbox"/>	Hybrid Log Periodic Antenna	TDK	HLP-3003C	130960	Sep.17, 2018	Sep.17, 2021
<input checked="" type="checkbox"/>	Preamplifier	HP	8447D	2944A09099	Dec.10,2018	Dec.10,2019
<input checked="" type="checkbox"/>	EMI Measurement Receiver	R&S	ESR26	101377	Dec.10,2018	Dec.10,2019
<input checked="" type="checkbox"/>	Horn Antenna	TDK	HRN-0118	130939	Sep.17, 2018	Sep.17, 2021
<input checked="" type="checkbox"/>	High Gain Horn Antenna	Schwarzbeck	BBHA-9170	691	Aug.11, 2018	Aug.11, 2021
<input checked="" type="checkbox"/>	Preamplifier	TDK	PA-02-0118	TRS-305-00066	Dec.10,2018	Dec.10,2019
<input checked="" type="checkbox"/>	Preamplifier	TDK	PA-02-2	TRS-307-00003	Dec.10,2018	Dec.10,2019
<input checked="" type="checkbox"/>	Loop antenna	Schwarzbeck	1519B	00008	Jan.07,2019	Jan.07, 2022
<input checked="" type="checkbox"/>	Band Reject Filter	Wainwright	WRCJV8-2350-2400-2483.5-2533.5-40SS	4	Dec.10,2018	Dec.10,2019
<input checked="" type="checkbox"/>	High Pass Filter	Wi	WHKX10-2700-3000-18000-40SS	23	Dec.10,2018	Dec.10,2019
Software						
Used	Description	Manufacturer	Name	Version		
<input checked="" type="checkbox"/>	Test Software for Radiated disturbance	Farad	EZ-EMC	Ver. UL-3A1		



Other instruments						
Used	Equipment	Manufacturer	Model No.	Serial No.	Last Cal.	Next Cal.
<input checked="" type="checkbox"/>	Spectrum Analyzer	Keysight	N9030A	MY55410512	Dec.10,2018	Dec.10,2019
<input checked="" type="checkbox"/>	Power Meter	Keysight	N1911A	MY55416024	Dec.10,2018	Dec.10,2019
<input checked="" type="checkbox"/>	Power Sensor	Keysight	U2021XA	MY5100022	Dec.10,2018	Dec.10,2019

7. MEASUREMENT METHODS

No.	Test Item	KDB Name	Section
1	6dB Bandwidth	KDB 558074 D01 15.247 Meas Guidance v05r02	8.2
2	Peak Output Power	KDB 558074 D01 15.247 Meas Guidance v05r02	8.3.1.3/8.3.2.3
3	Power Spectral Density	KDB 558074 D01 15.247 Meas Guidance v05r02	8.4
4	Out-of-band emissions in non-restricted bands	KDB 558074 D01 15.247 Meas Guidance v05r02	8.5
5	Out-of-band emissions in restricted bands	KDB 558074 D01 15.247 Meas Guidance v05r02	8.6
6	Band-edge	KDB 558074 D01 15.247 Meas Guidance v05r02	8.7
7	Conducted Emission Test For AC Power Port	ANSI C63.10-2013	6.2
8	99% Bandwidth	ANSI C63.10-2013	6.9.3



8. ANTENNA PORT TEST RESULTS

8.1. ON TIME AND DUTY CYCLE

LIMITS

None; for reporting purposes only

PROCEDURE

KDB 558074 Zero-Span Spectrum Analyzer Method

TEST SETUP

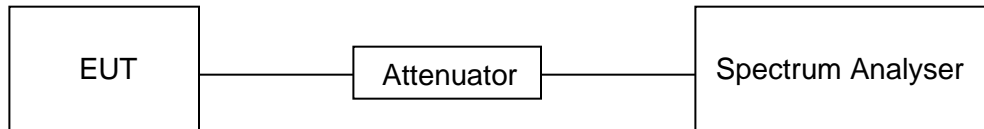

TEST ENVIRONMENT

Temperature	24.4°C	Relative Humidity	55%
Atmosphere Pressure	101kPa	Test Voltage	AC 120V,60Hz

RESULTS

Mode	On Time (msec)	Period (msec)	Duty Cycle x (Linear)	Duty Cycle (%)	Duty Cycle Correction Factor (dB)	1/T Minimum VBW (KHz)	Final setting For VBW (KHz)
11b	4.200	4.700	0.894	89.4	0.487	0.24	0.5
11g	0.700	0.795	0.881	88.1	0.550	1.43	1.5
11n20	0.660	0.760	0.868	86.8	0.615	1.56	2.0

Note:

Duty Cycle Correction Factor=10log (1/x).

Where: x is Duty Cycle (Linear)

Where: T is On Time

If that calculated VBW is not available on the analyzer then the next higher value should be used.

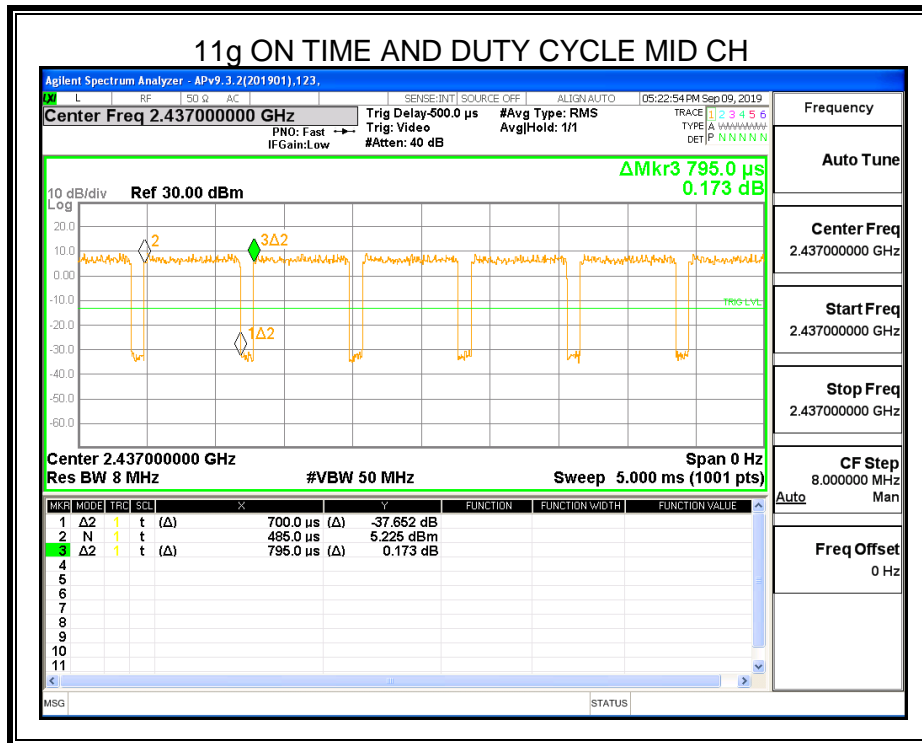
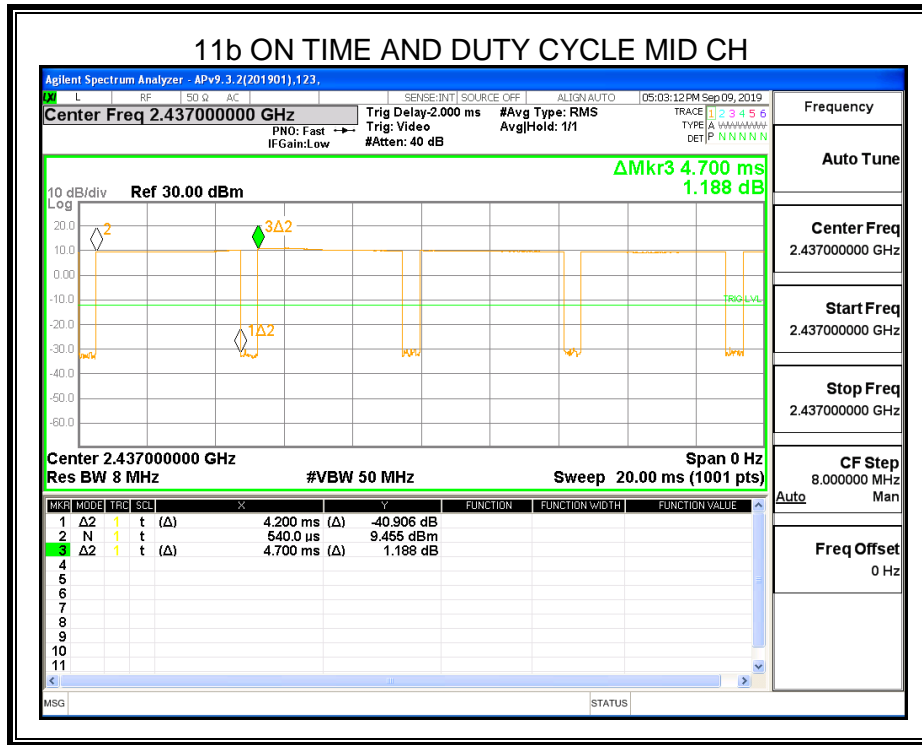

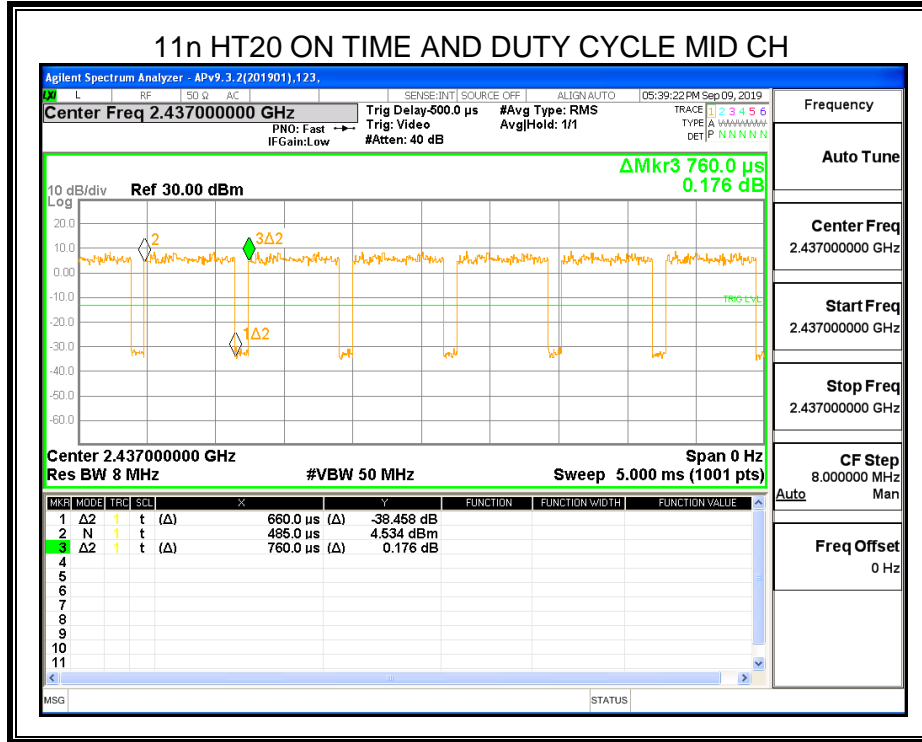

8.2. 6 dB DTS BANDWIDTH AND 99% OCCUPIED BANDWIDTH

LIMITS

CFR 47 FCC Part15 (15.247) Subpart C ISED RSS-247 ISSUE 2			
Section	Test Item	Limit	Frequency Range (MHz)
CFR 47 FCC 15.247(a)(2) ISED RSS-247 5.2 (a)	6 dB Bandwidth	≥ 500KHz	2400-2483.5
ISED RSS-Gen Clause 6.7	99% Occupied Bandwidth	For reporting purposes only.	2400-2483.5

TEST PROCEDURE

Connect the UUT to the spectrum analyser and use the following settings:

Center Frequency	The centre frequency of the channel under test
Detector	Peak
RBW	For 6dB Bandwidth :100K For 99% Occupied Bandwidth :1% to 5% of the occupied bandwidth
VBW	For 6dB Bandwidth : ≥3 × RBW For 99% Occupied Bandwidth : approximately 3×RBW
Trace	Max hold
Sweep	Auto couple

Allow the trace to stabilize and measure the maximum width of the emission that is constrained by the frequencies associated with the two outermost amplitude points (upper and lower frequencies) that are attenuated by 6 dB and 99% relative to the maximum level measured in the fundamental emission.

TEST SETUP

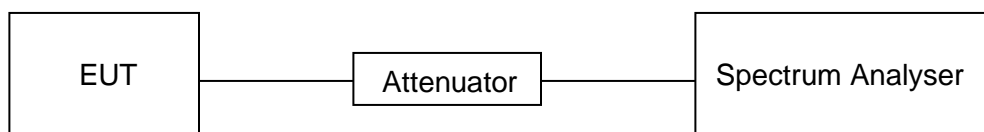



TEST ENVIRONMENT

Temperature	24.4°C	Relative Humidity	55%
Atmosphere Pressure	101kPa	Test Voltage	AC 120V,60Hz

RESULTS

8.2.1. 802.11b MODE

Channel	6dB bandwidth (MHz)	99% bandwidth (MHz)	Limit (kHz)	Result
Low	7.68	10.490	≥500	Pass
Middle	8.12	10.566	≥500	Pass
High	8.16	10.678	≥500	Pass

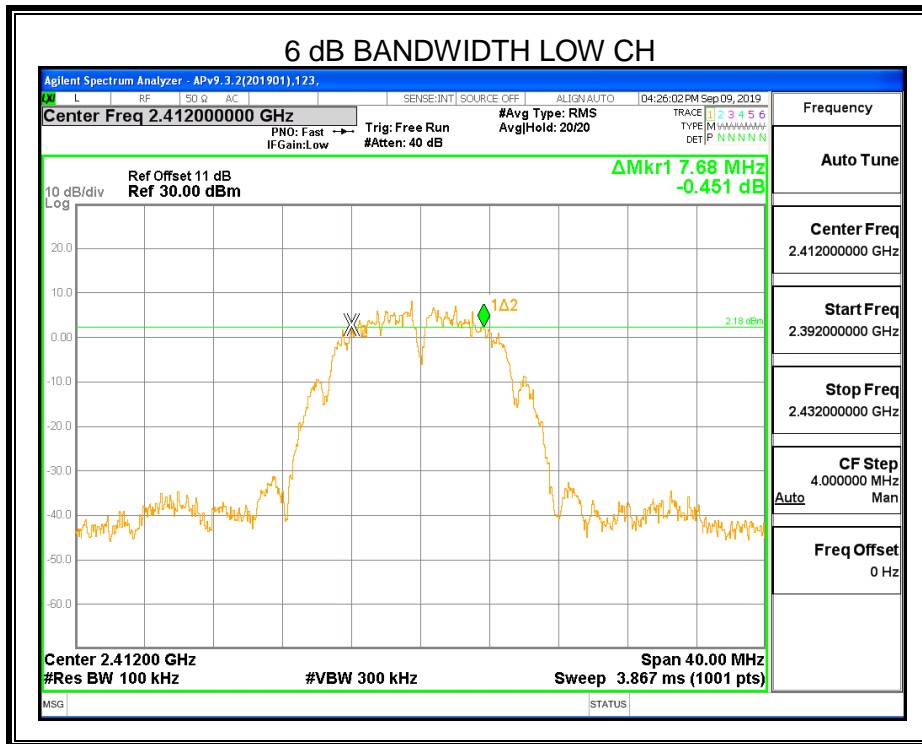

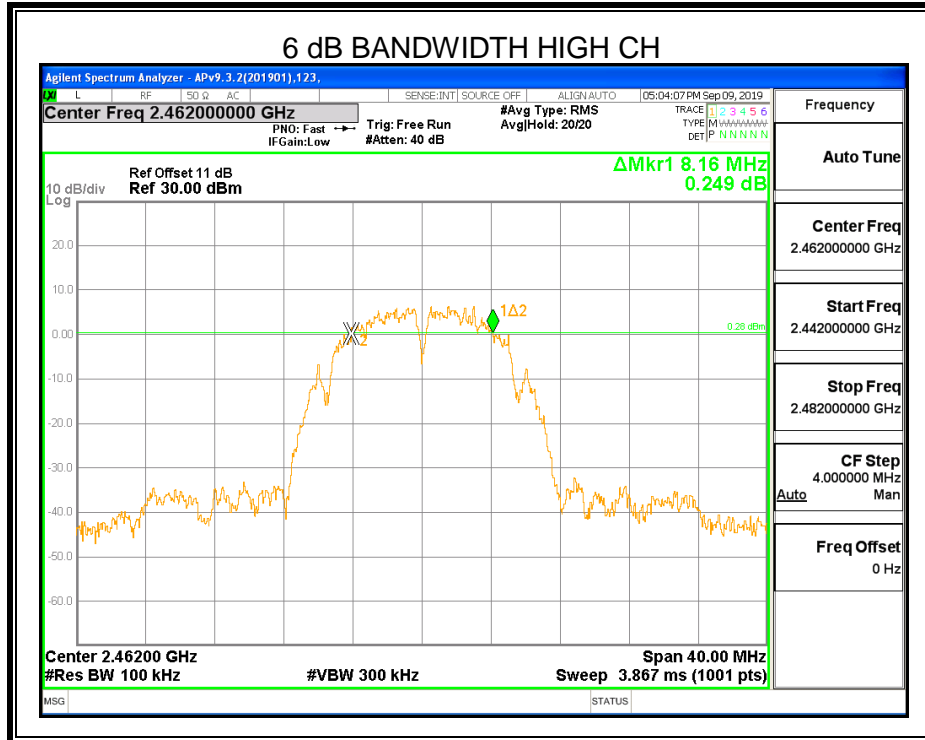
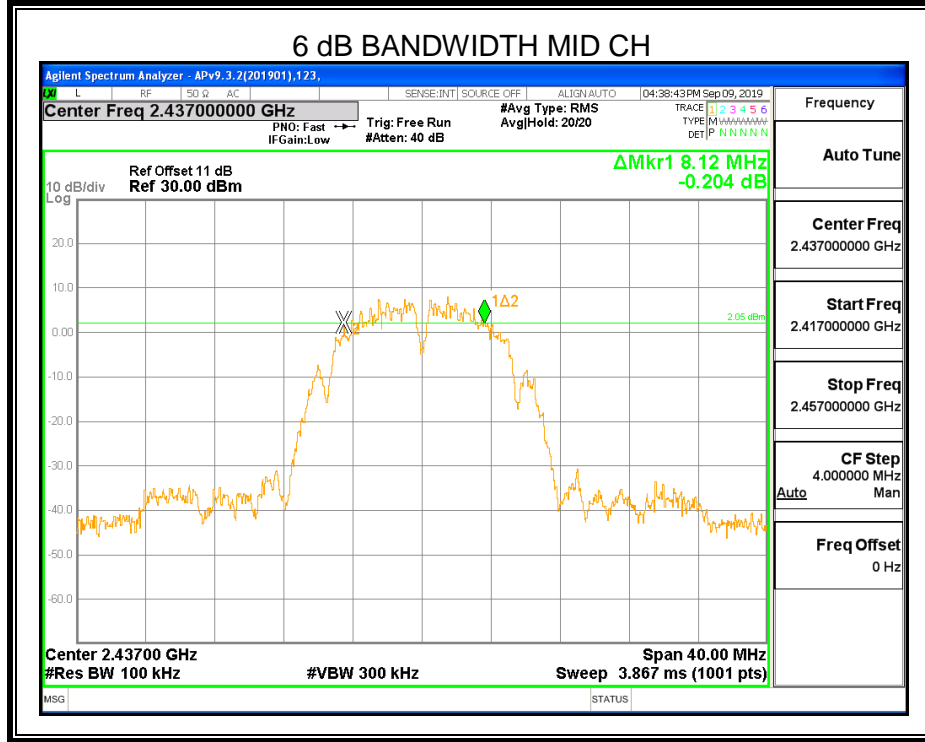

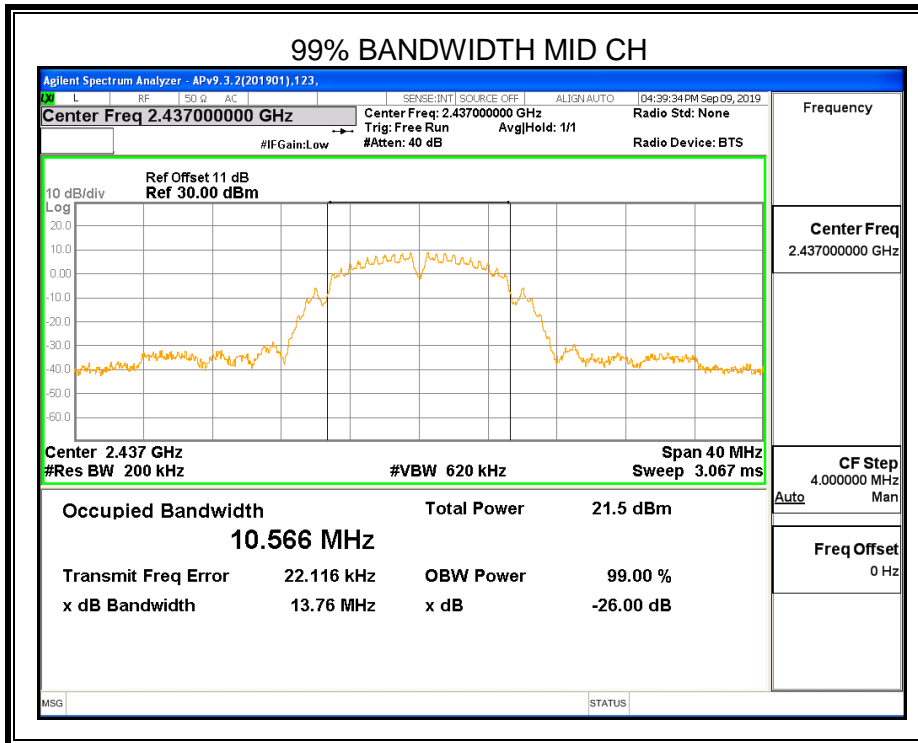
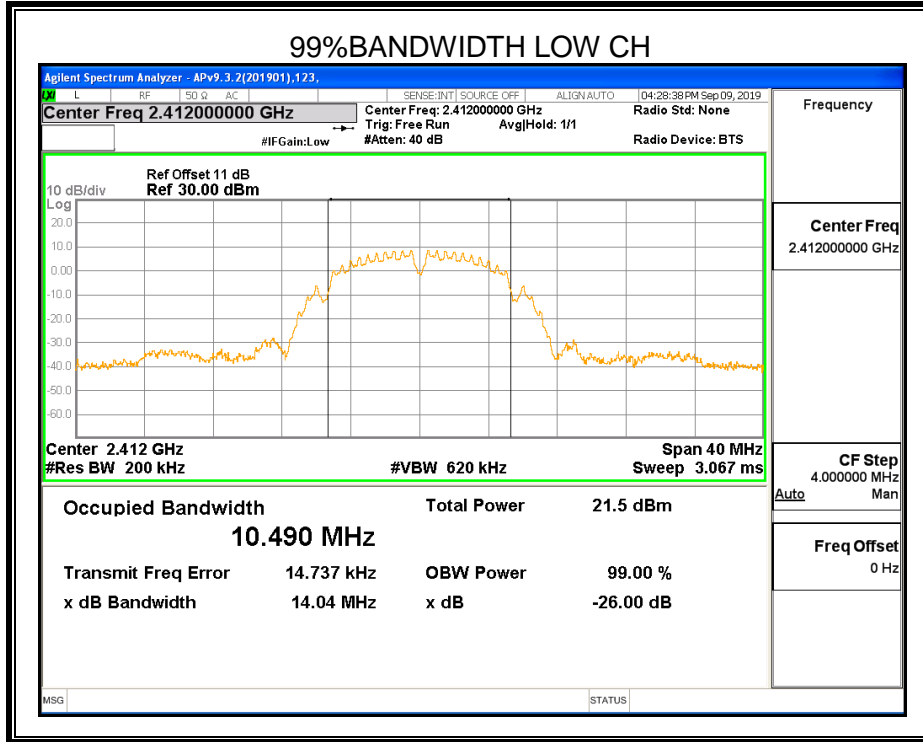

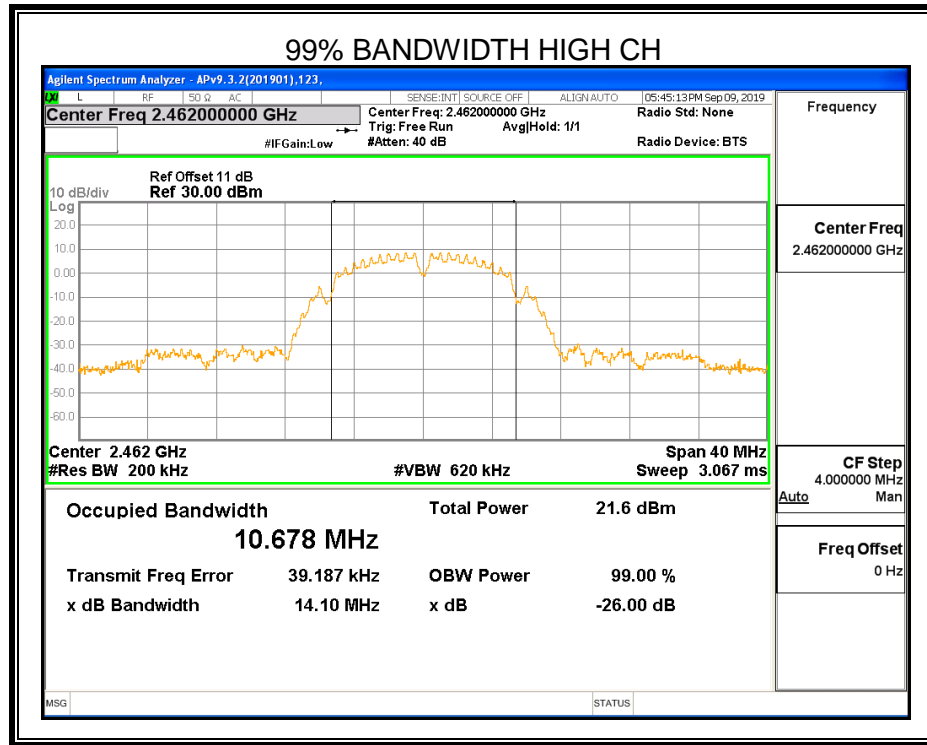



8.2.2. 802.11g MODE

Channel	6dB bandwidth (MHz)	99% bandwidth (MHz)	Limit (kHz)	Result
Low	16.04	16.625	≥500	Pass
Middle	16.36	16.614	≥500	Pass
High	16.36	16.615	≥500	Pass

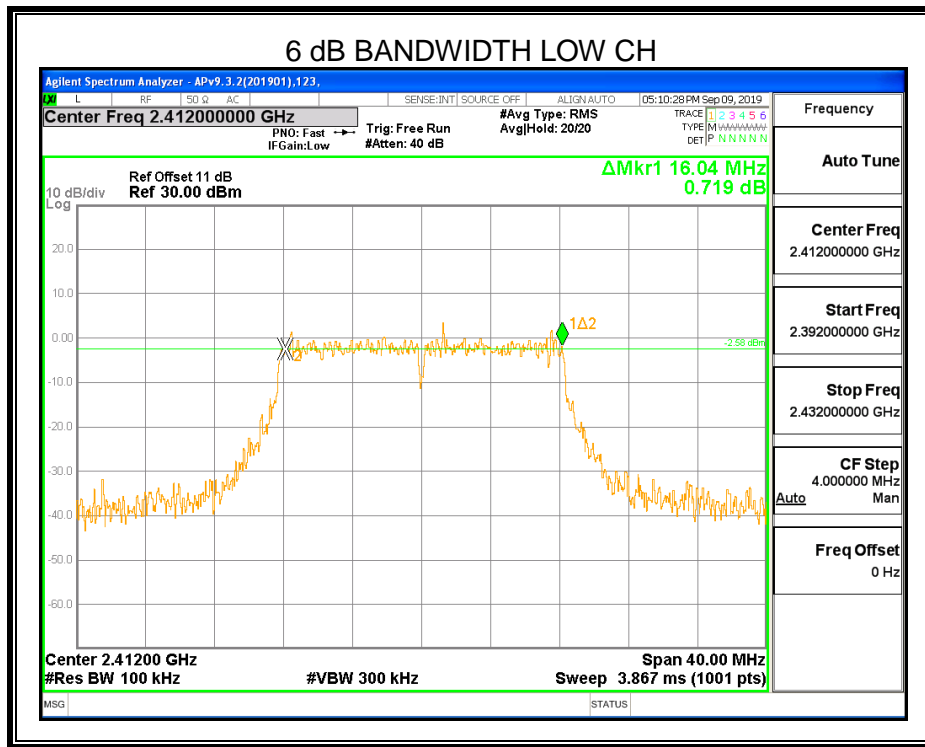

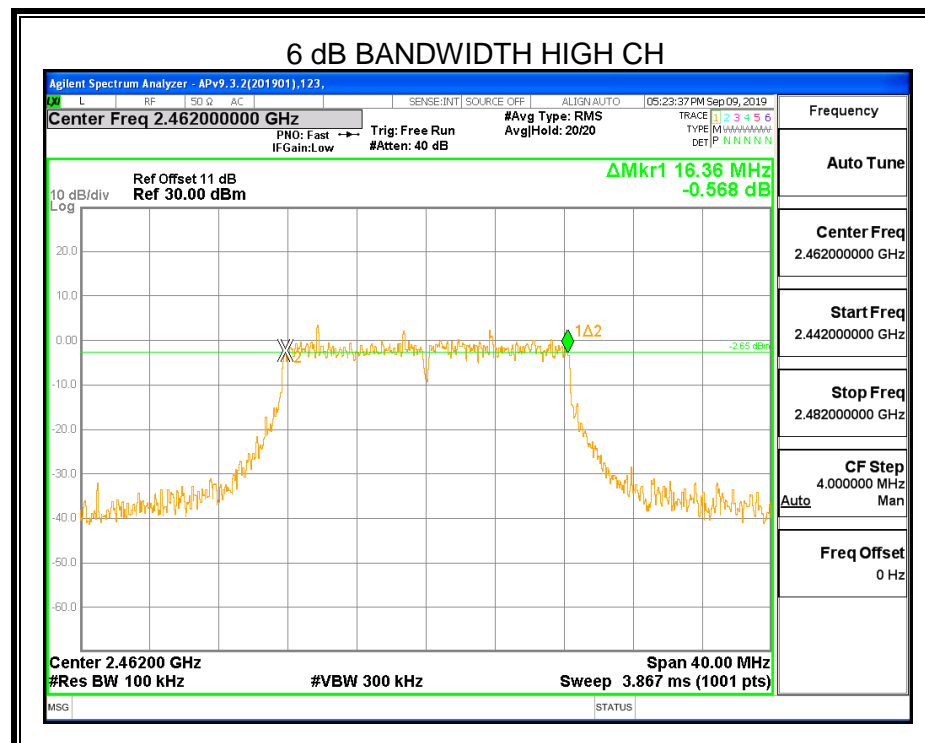
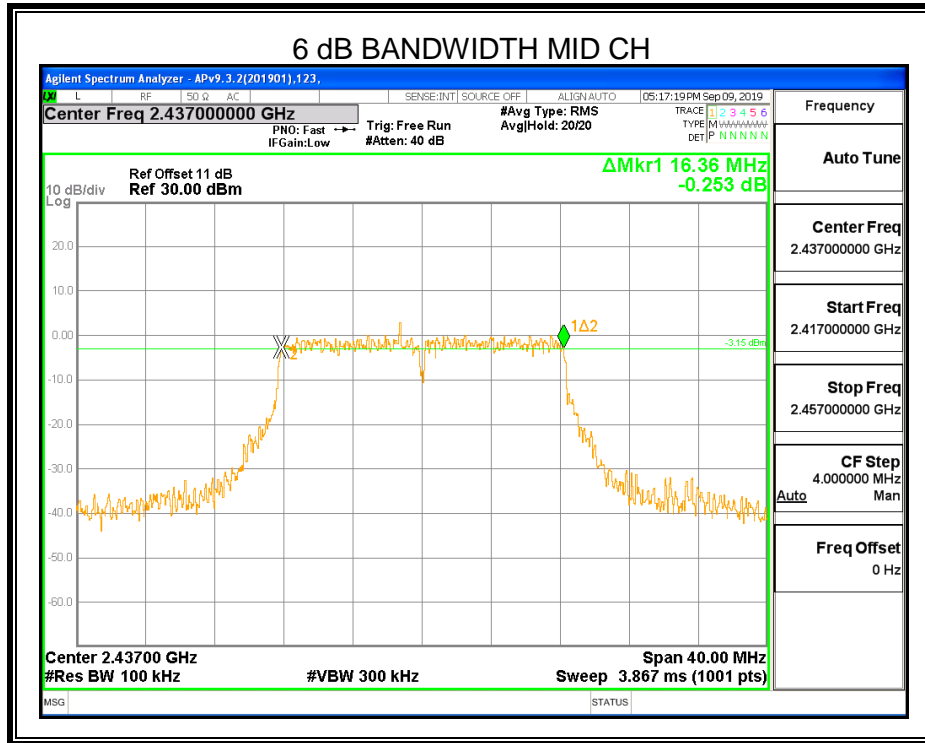

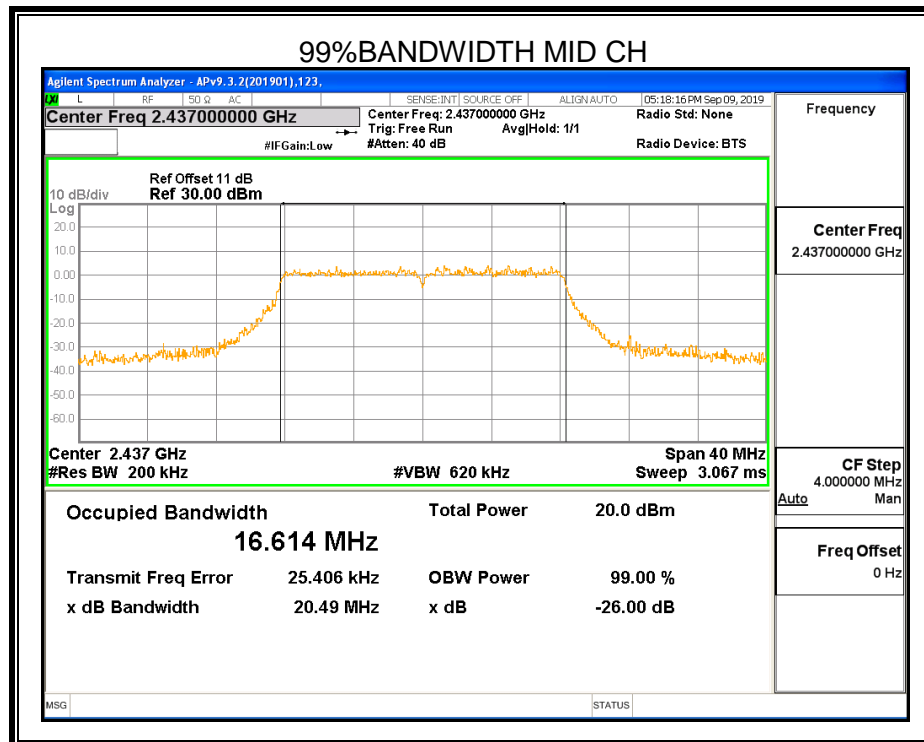
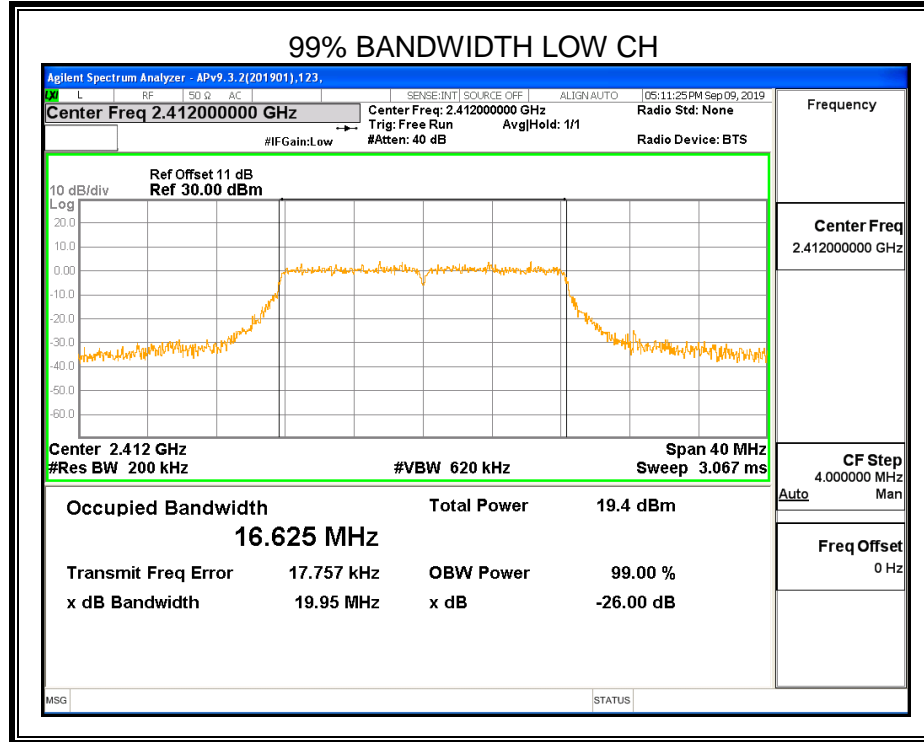

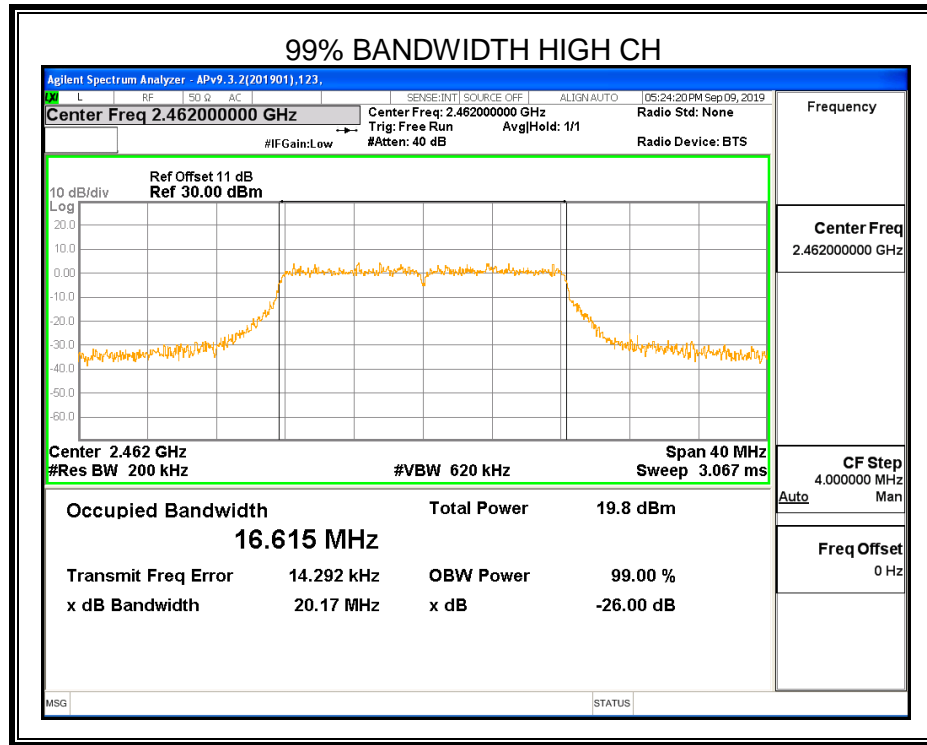



8.2.3. 802.11n HT20 MODE

Channel	6dB bandwidth (MHz)	99% bandwidth (MHz)	Limit (kHz)	Result
Low	17.32	17.691	≥500	Pass
Middle	17.56	17.669	≥500	Pass
High	17.32	17.713	≥500	Pass

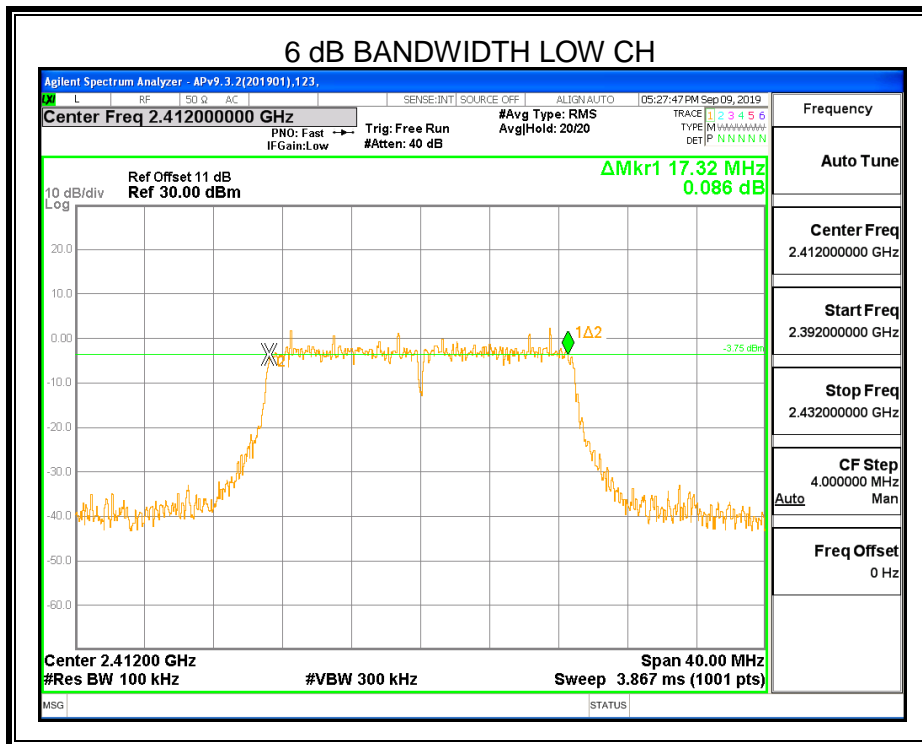

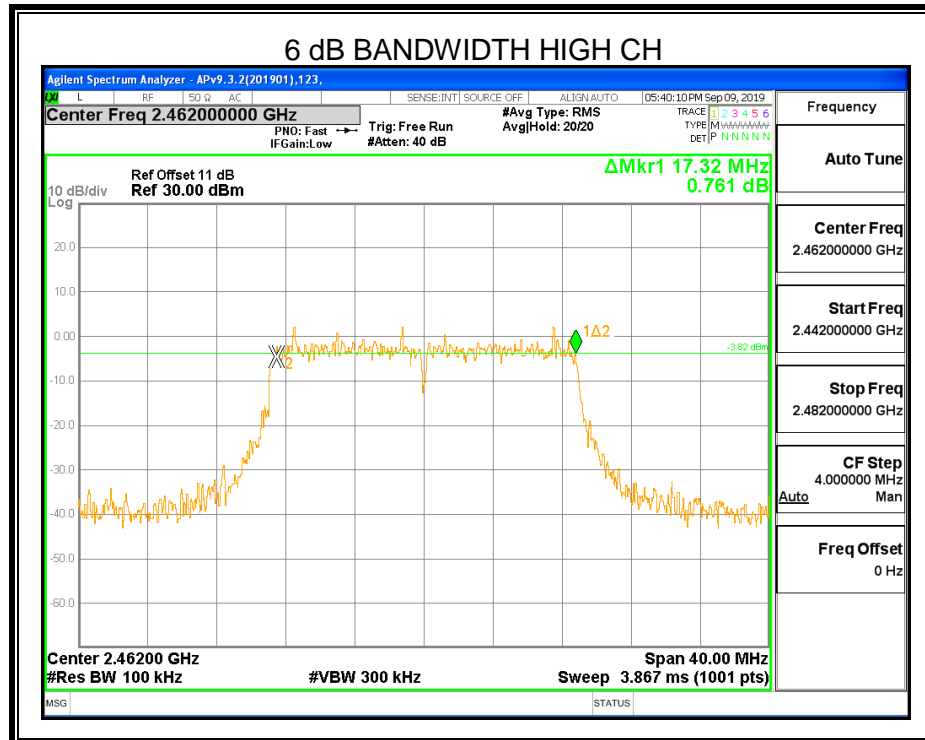
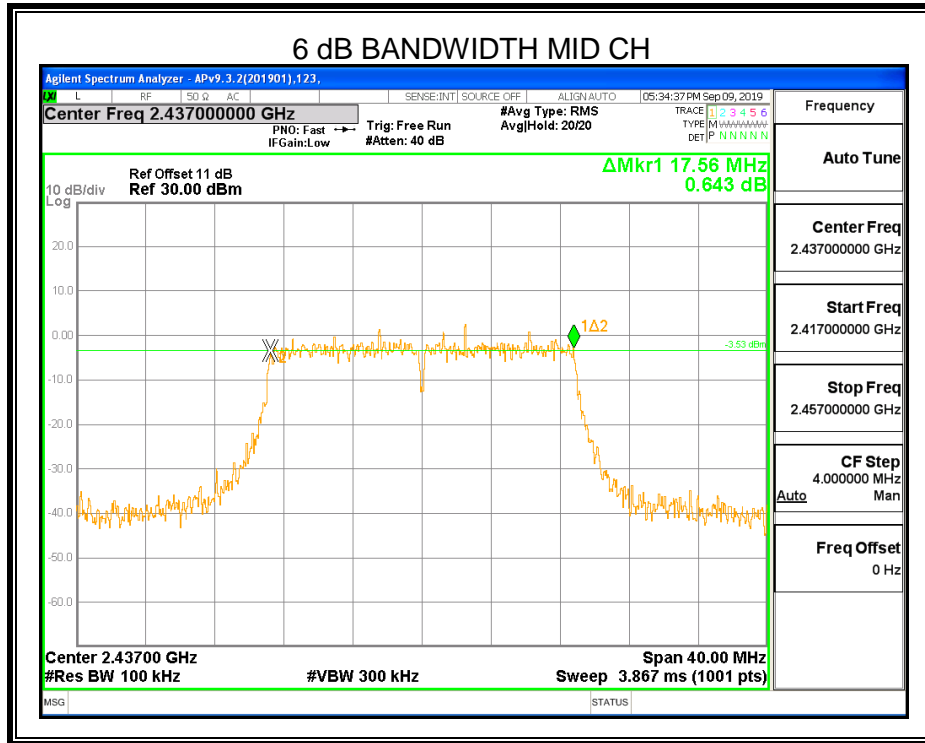

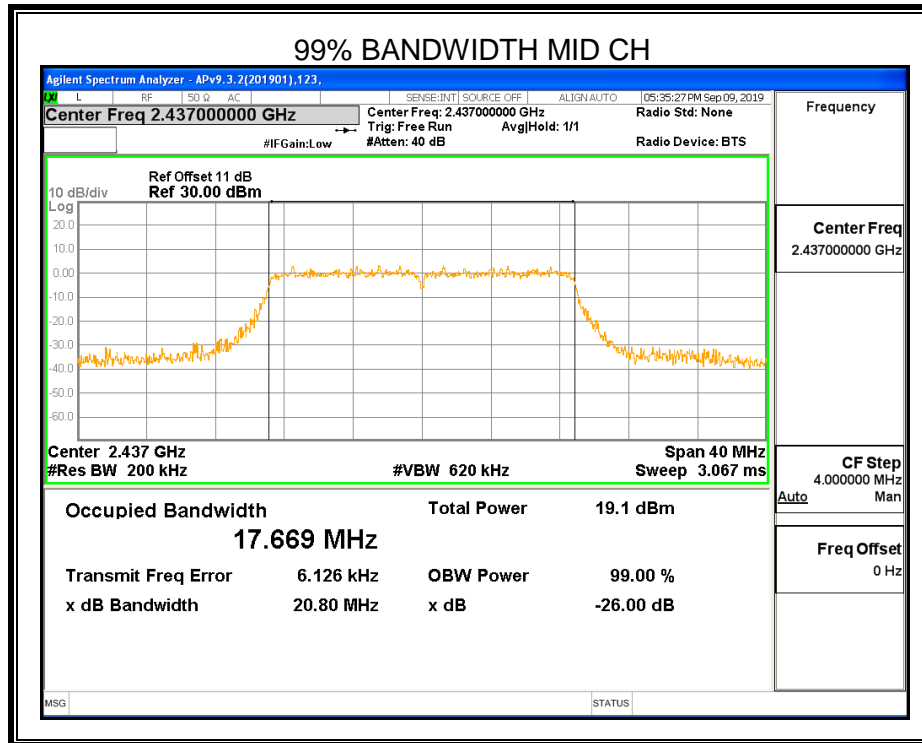
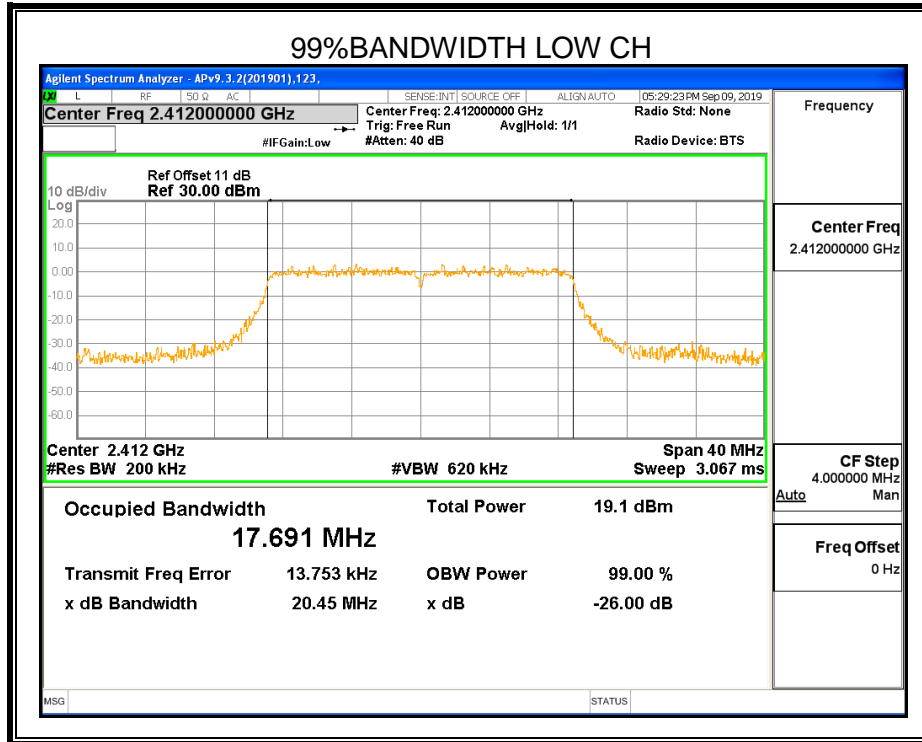

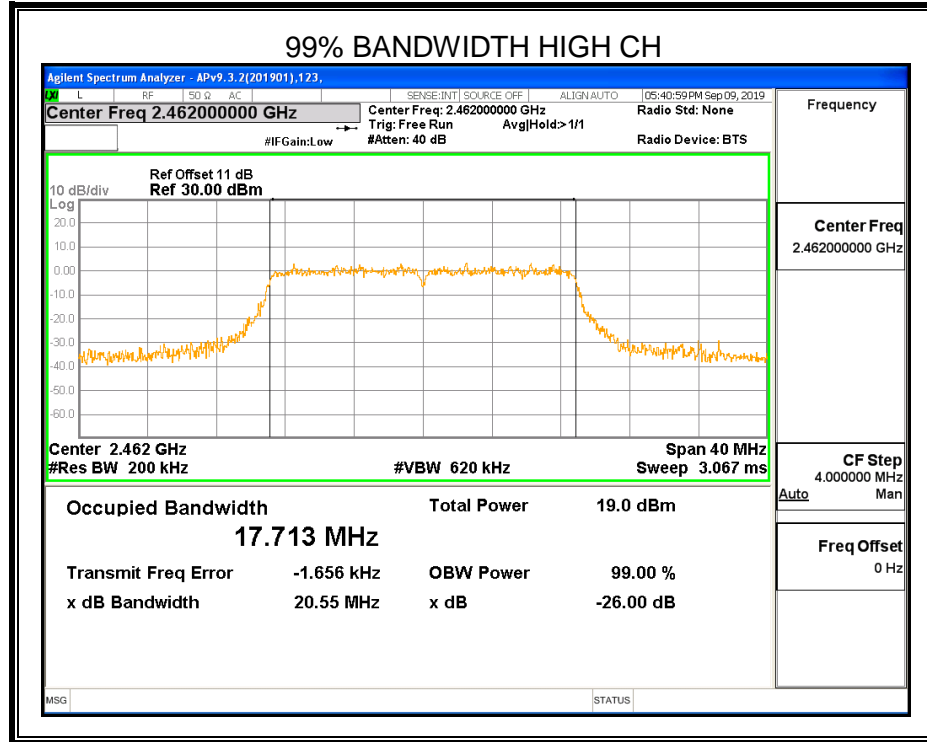



8.3. PEAK CONDUCTED OUTPUT POWER

LIMITS

CFR 47 FCC Part15 (15.247) Subpart C ISED RSS-247 ISSUE 2			
Section	Test Item	Limit	Frequency Range (MHz)
CFR 47 FCC 15.247(b)(3) ISED RSS-247 5.4 (d)	Peak Output Power	1 watt or 30dBm	2400-2483.5

TEST PROCEDURE

Place the EUT on the table and set it in the transmitting mode.
Remove the antenna from the EUT and then connect a low loss RF cable from the antenna port to the Power sensor.
Measure the power of each channel.
Peak Detector use for Peak result.
AVG Detector use for AVG result.

TEST SETUP

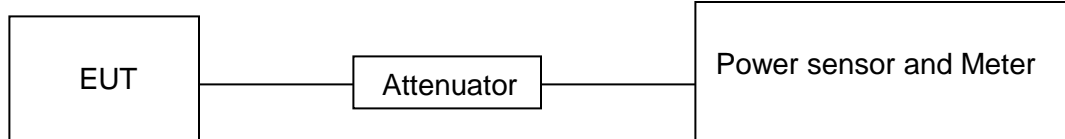

TEST ENVIRONMENT

Temperature	24.4°C	Relative Humidity	55%
Atmosphere Pressure	101kPa	Test Voltage	AC 120V,60Hz



RESULTS

8.3.1. 802.11b MODE

Test Channel	Maximum Conducted Output Power(PK)	Maximum Conducted Output Power(AV)	LIMIT
	(dBm)	(dBm)	dBm
Low	17.150	13.91	30
Middle	17.210	14.02	30
High	17.130	13.95	30

8.3.2. 802.11g MODE

Test Channel	Maximum Conducted Output Power(PK)	Maximum Conducted Output Power(AV)	LIMIT
	(dBm)	(dBm)	dBm
Low	23.485	14.54	30
Middle	23.527	14.54	30
High	23.549	14.68	30

8.3.3. 802.11n HT20 MODE

Test Channel	Maximum Conducted Output Power(PK)	Maximum Conducted Output Power(AV)	LIMIT
	(dBm)	(dBm)	dBm
Low	23.535	13.59	30
Middle	23.445	13.52	30
High	23.493	13.65	30



8.4. POWER SPECTRAL DENSITY

LIMITS

CFR 47 FCC Part15 (15.247) Subpart C ISED RSS-247 ISSUE 2			
Section	Test Item	Limit	Frequency Range (MHz)
CFR 47 FCC §15.247 (e) ISED RSS-247 5.2 (b)	Power Spectral Density	8 dBm/3 kHz	2400-2483.5

TEST PROCEDURE

Connect the UUT to the spectrum analyser and use the following settings:

Center Frequency	The centre frequency of the channel under test
Detector	Peak
RBW	$3 \text{ kHz} \leq \text{RBW} \leq 100 \text{ kHz}$
VBW	$\geq 3 \times \text{RBW}$
Span	1.5 x DTS bandwidth
Trace	Max hold
Sweep time	Auto couple.

Allow trace to fully stabilize and use the peak marker function to determine the maximum amplitude level within the RBW.

If measured value exceeds limit, reduce RBW (no less than 3 kHz) and repeat.

TEST SETUP

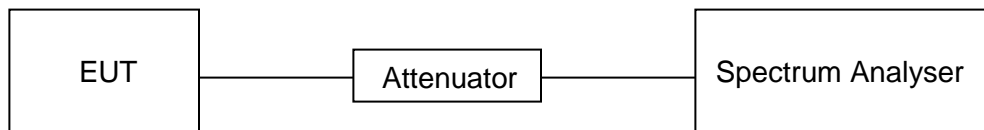

TEST ENVIRONMENT

Temperature	24.4°C	Relative Humidity	55%
Atmosphere Pressure	101kPa	Test Voltage	AC 120V,60Hz



RESULTS

8.4.1. 802.11b MODE

Test Channel	Power Spectral Density (dBm/3kHz)	Limit (dBm/3kHz)	Result
Low	-6.807	8	PASS
Middle	-7.209	8	PASS
High	-5.345	8	PASS

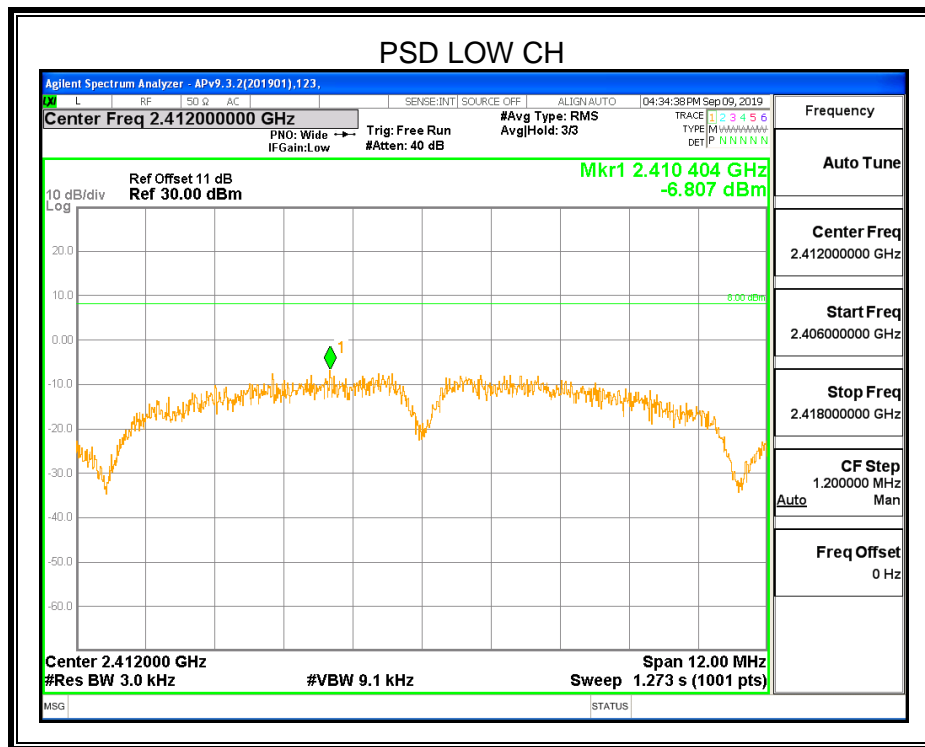

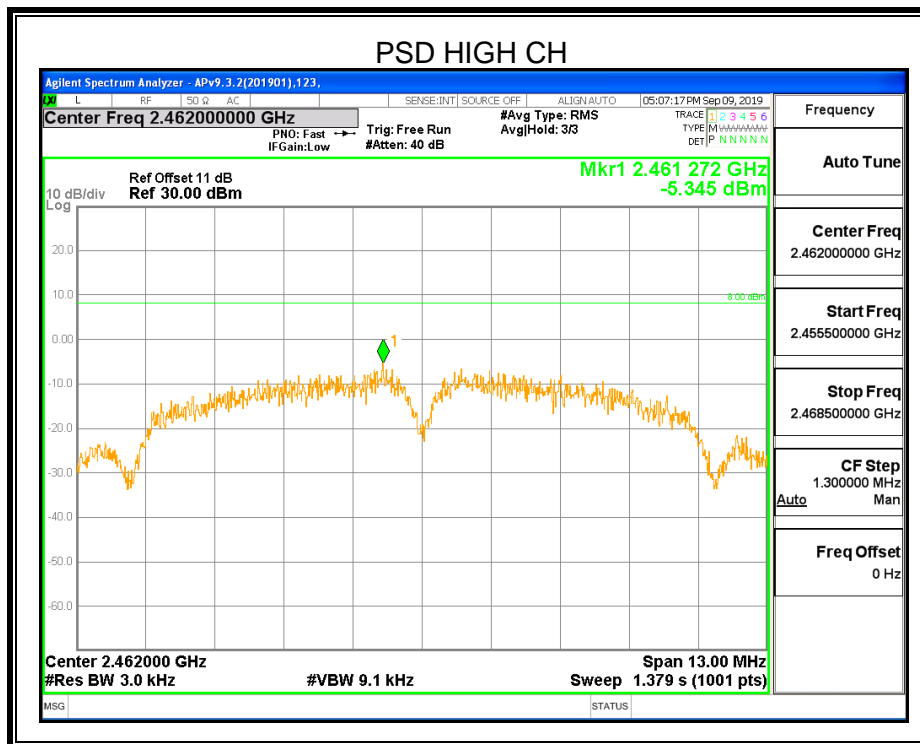
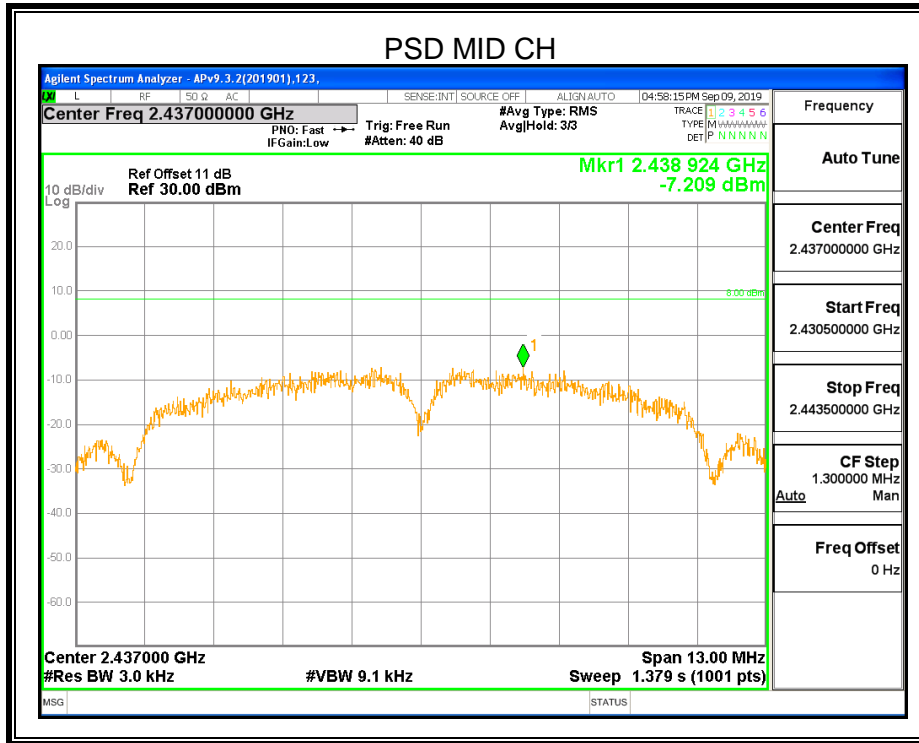



8.4.2. 802.11g MODE

Test Channel	Power Spectral Density (dBm/3kHz)	Limit (dBm/3kHz)	Result
Low	-10.630	8	PASS
Middle	-10.302	8	PASS
High	-11.314	8	PASS

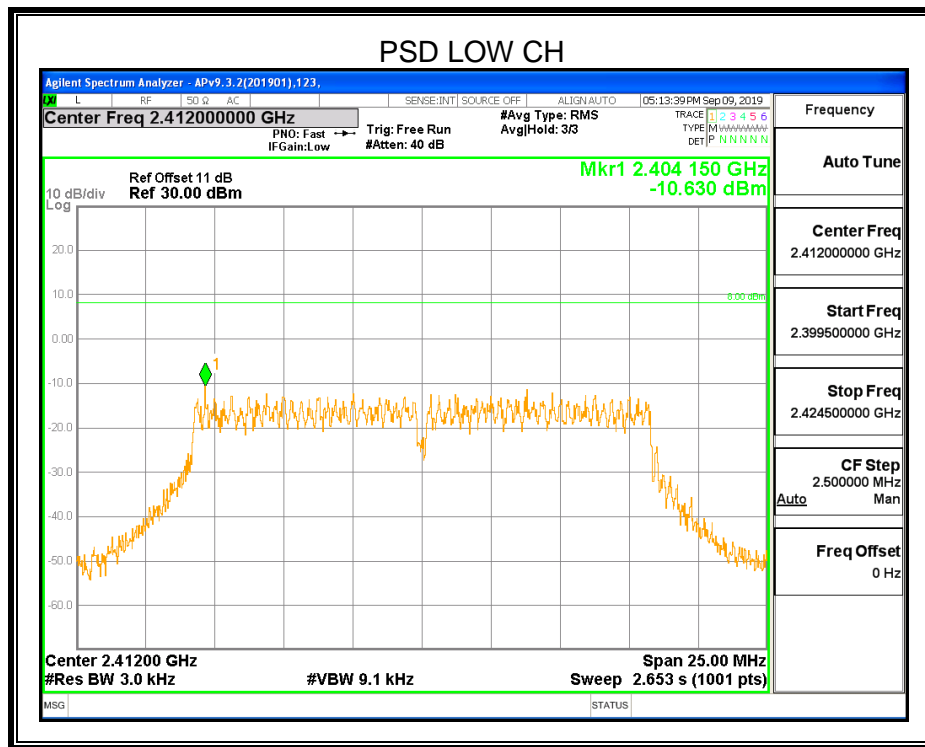

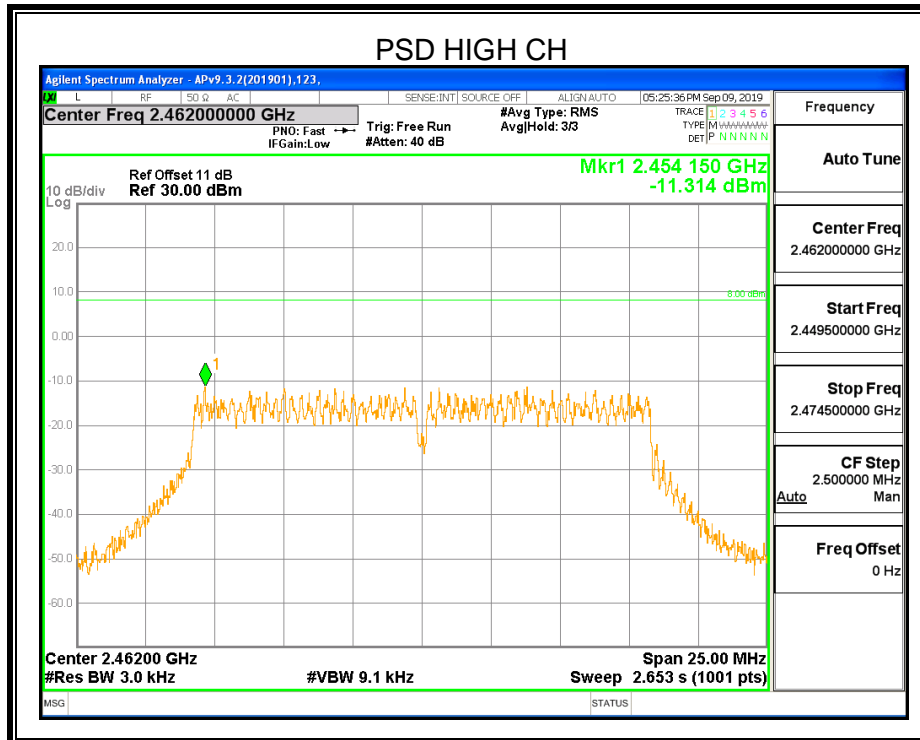
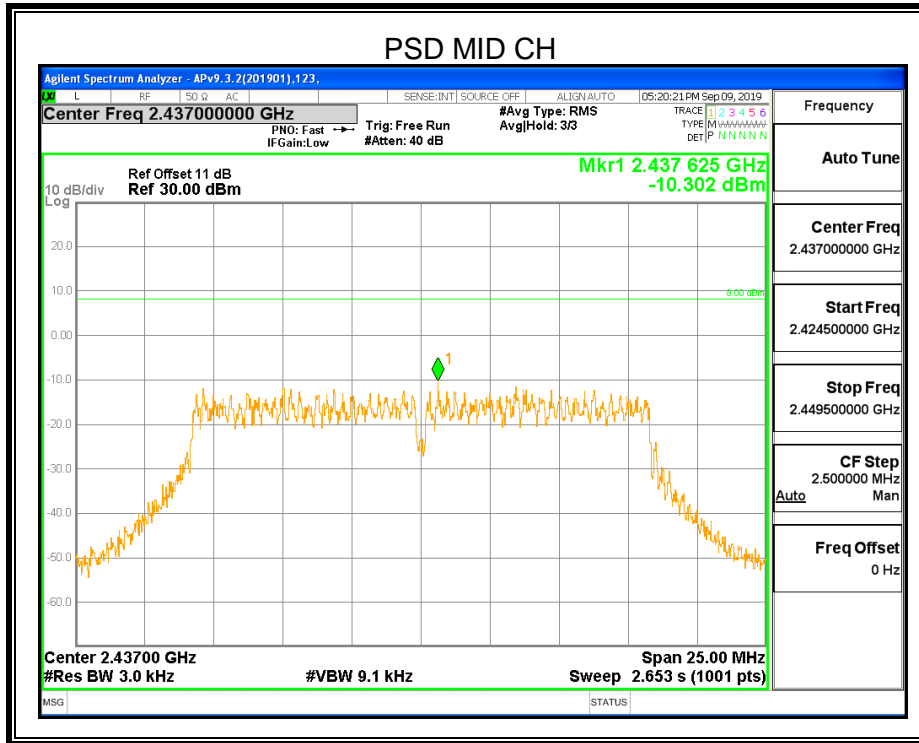



8.4.3. 802.11n HT20 MODE

Test Channel	Power Spectral Density (dBm/3kHz)	Limit (dBm/3kHz)	Result
Low	-12.172	8	PASS
Middle	-12.254	8	PASS
High	-11.203	8	PASS

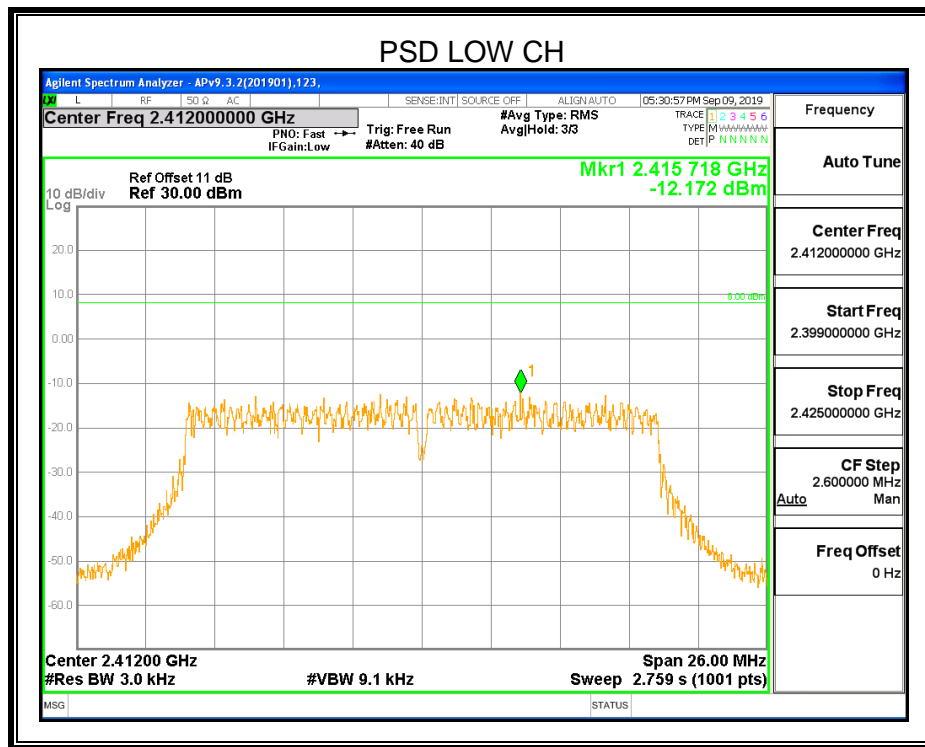



8.5. CONDUCTED BANDEGE AND SPURIOUS EMISSIONS

LIMITS

CFR 47 FCC Part15 (15.247) Subpart C ISED RSS-247 ISSUE 2		
Section	Test Item	Limit
CFR 47 FCC §15.247 (d) ISED RSS-247 5.5	Conducted Bandedge and Spurious Emissions	at least 20 dB below that in the 100 kHz bandwidth within the band that contains the highest level of the desired power

TEST PROCEDURE

Connect the UUT to the spectrum analyser and use the following settings:

Center Frequency	The centre frequency of the channel under test
Detector	Peak
RBW	100K
VBW	$\geq 3 \times \text{RBW}$
Span	1.5 x DTS bandwidth
Trace	Max hold
Sweep time	Auto couple.

Use the peak marker function to determine the maximum PSD level.

Span	Set the center frequency and span to encompass frequency range to be measured
Detector	Peak
RBW	100K
VBW	$\geq 3 \times \text{RBW}$
measurement points	$\geq \text{span}/\text{RBW}$
Trace	Max hold
Sweep time	Auto couple.

Use the peak marker function to determine the maximum amplitude level.



TEST SETUP

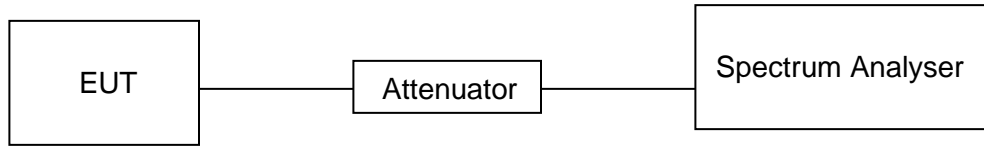

TEST ENVIRONMENT

Temperature	24.4°C	Relative Humidity	55%
Atmosphere Pressure	101kPa	Test Voltage	AC 120V,60Hz

RESULTS



8.5.1. 802.11b MODE

LOW CH BANDEDGE

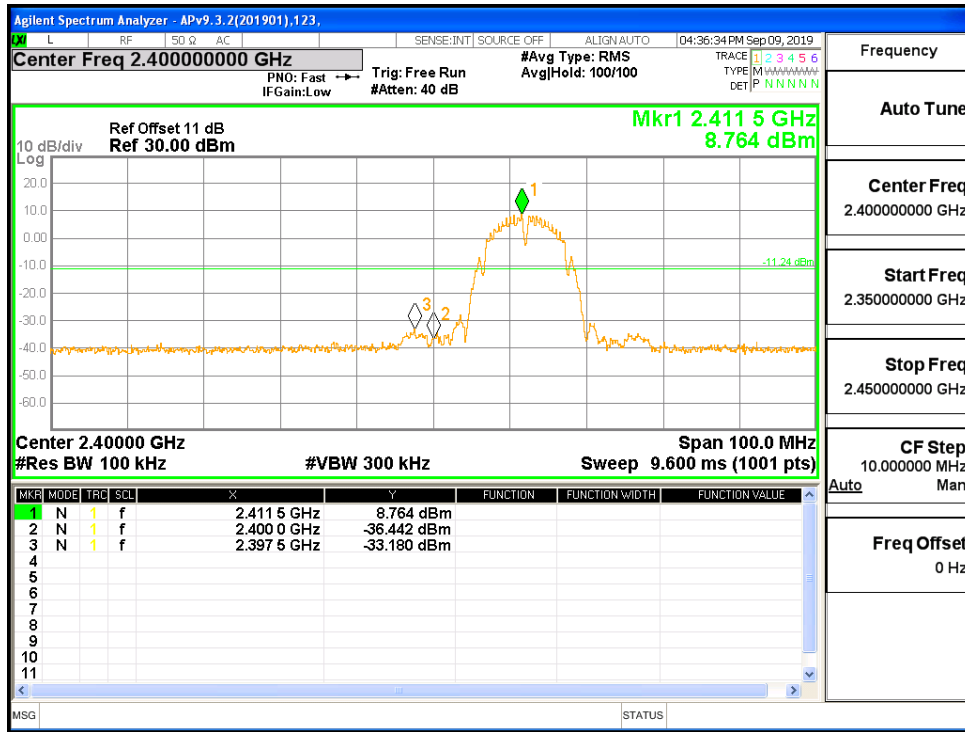

LOW CH SPURIOUS EMISSIONS 30M-26G

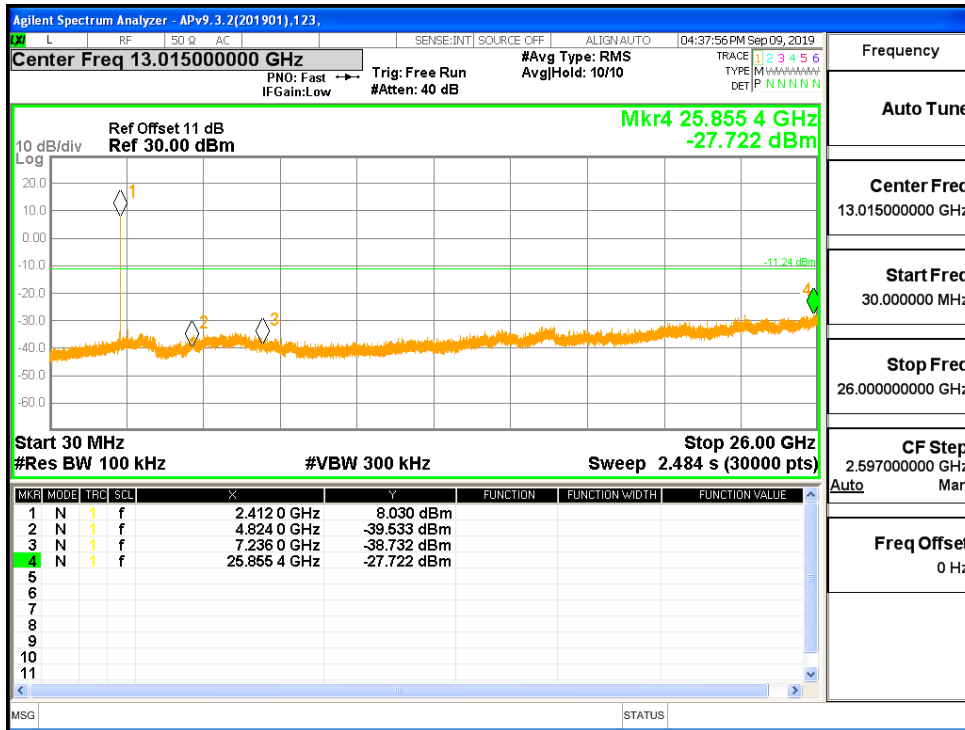



MID CH SPURIOUS EMISSIONS REFERENCE

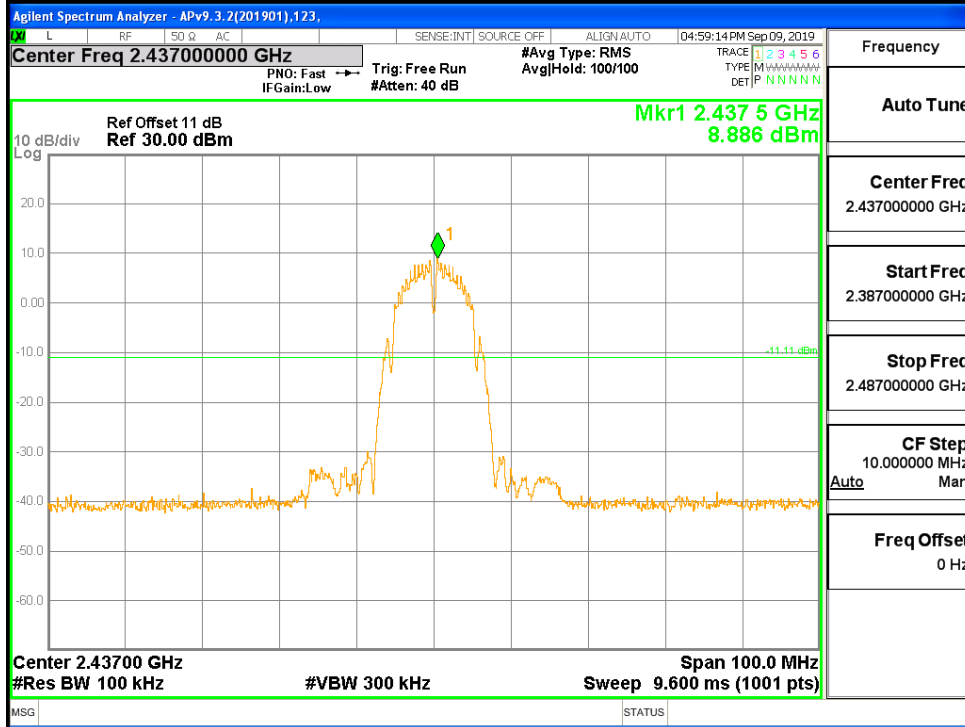

MID CH SPURIOUS EMISSIONS 30M-26G

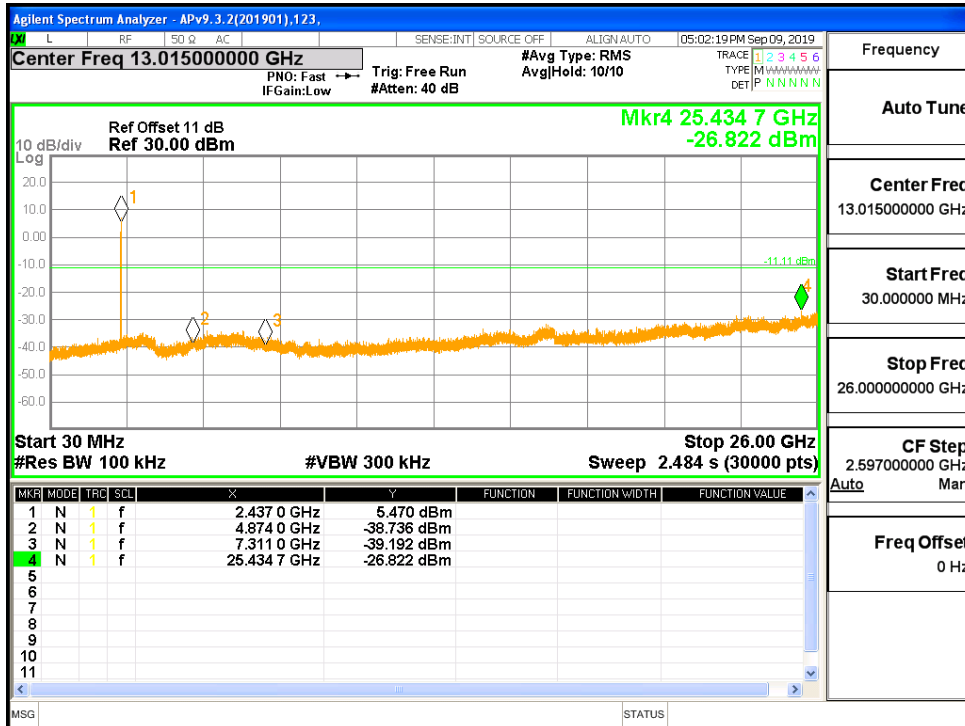



HIGH CH BANDEDGE

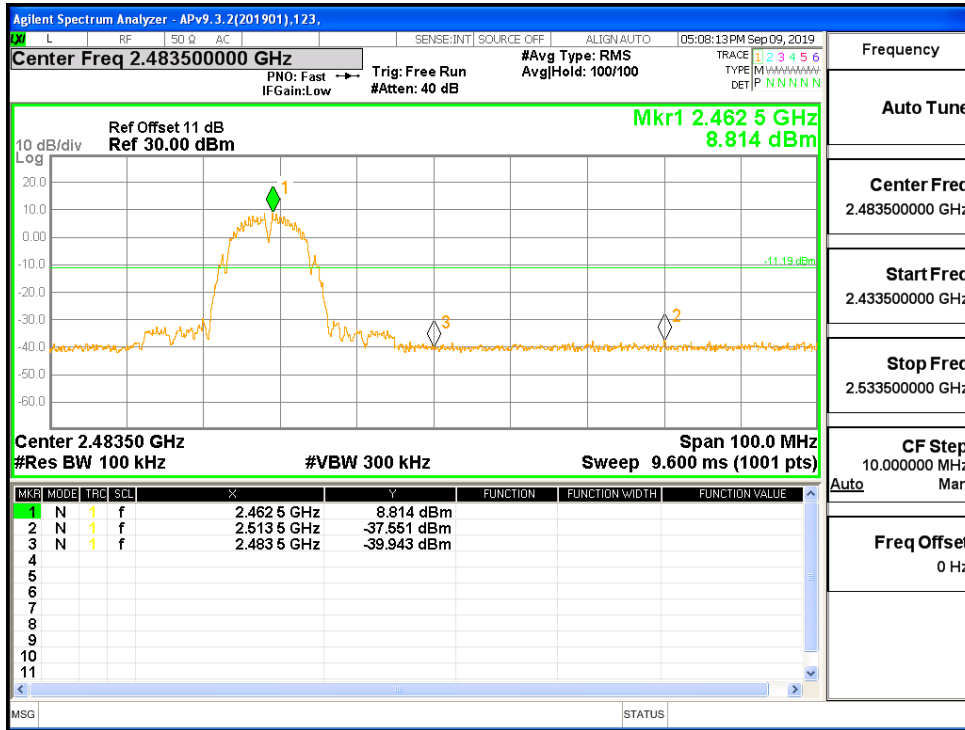

HIGH CH SPURIOUS EMISSIONS 30M-26G

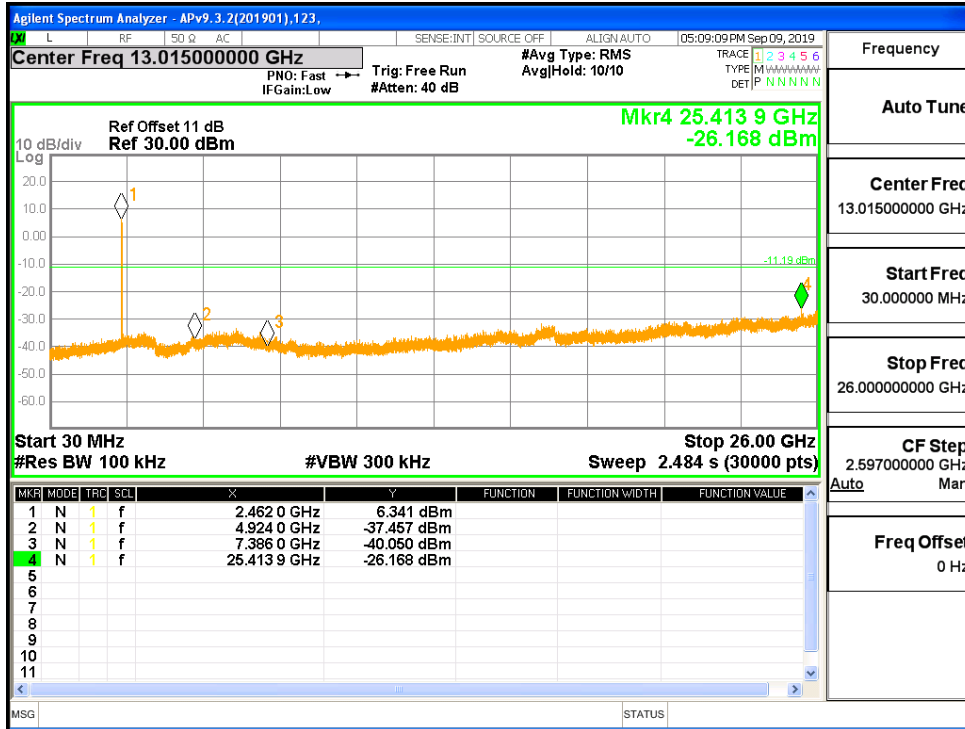



8.5.1. 802.11g MODE

LOW CH BANDEDGE

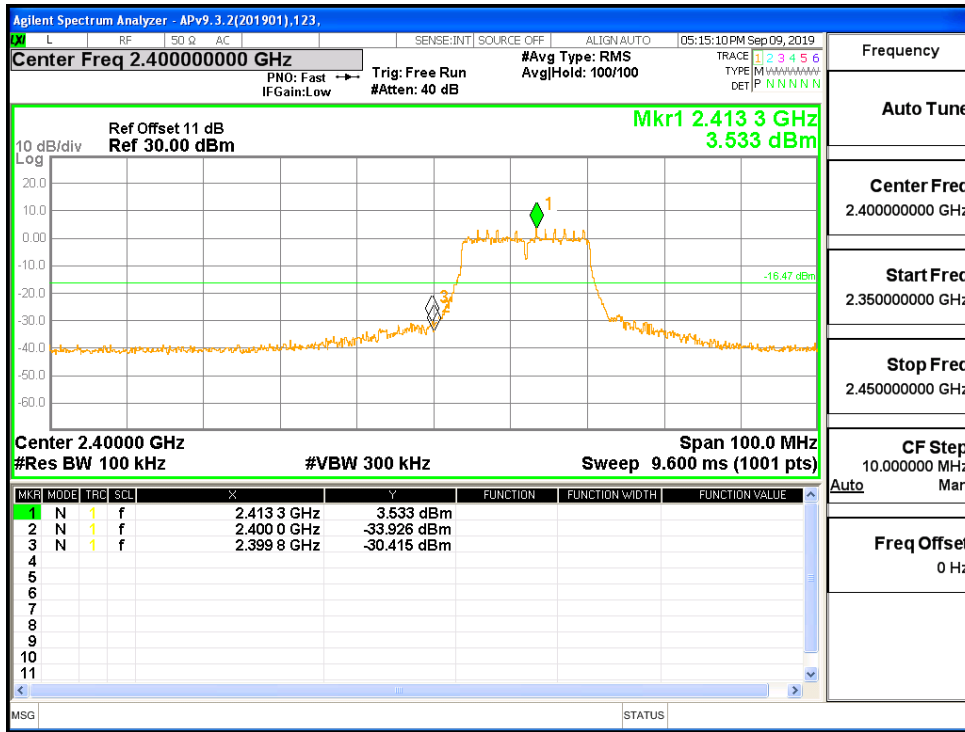

LOW CH SPURIOUS EMISSIONS 30M-26G

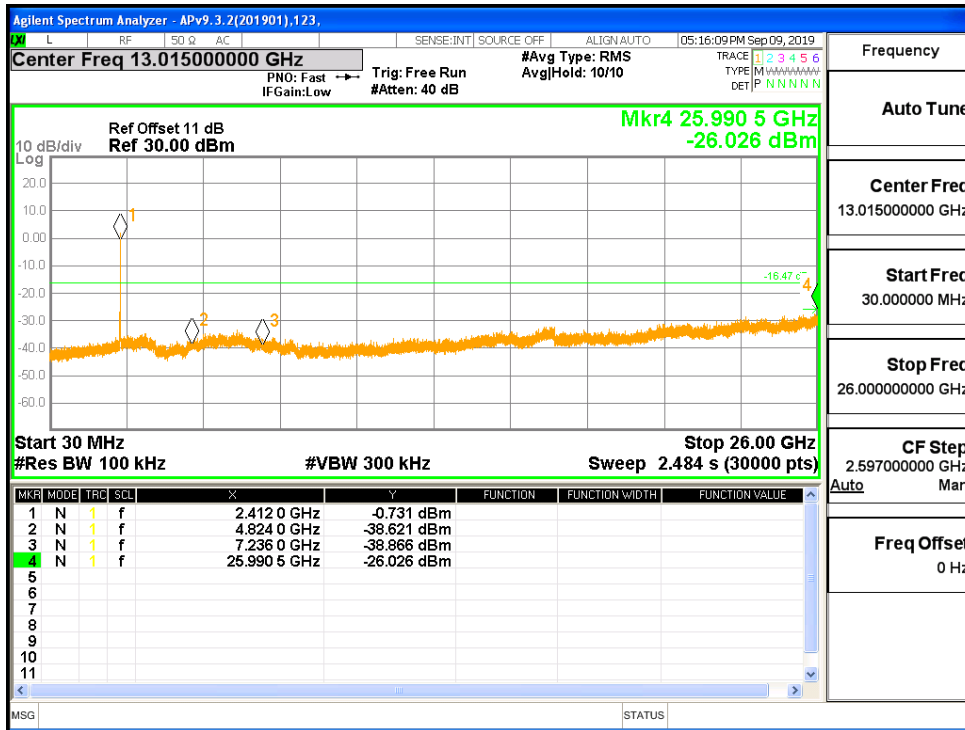



MID CH SPURIOUS EMISSIONS REFERENCE

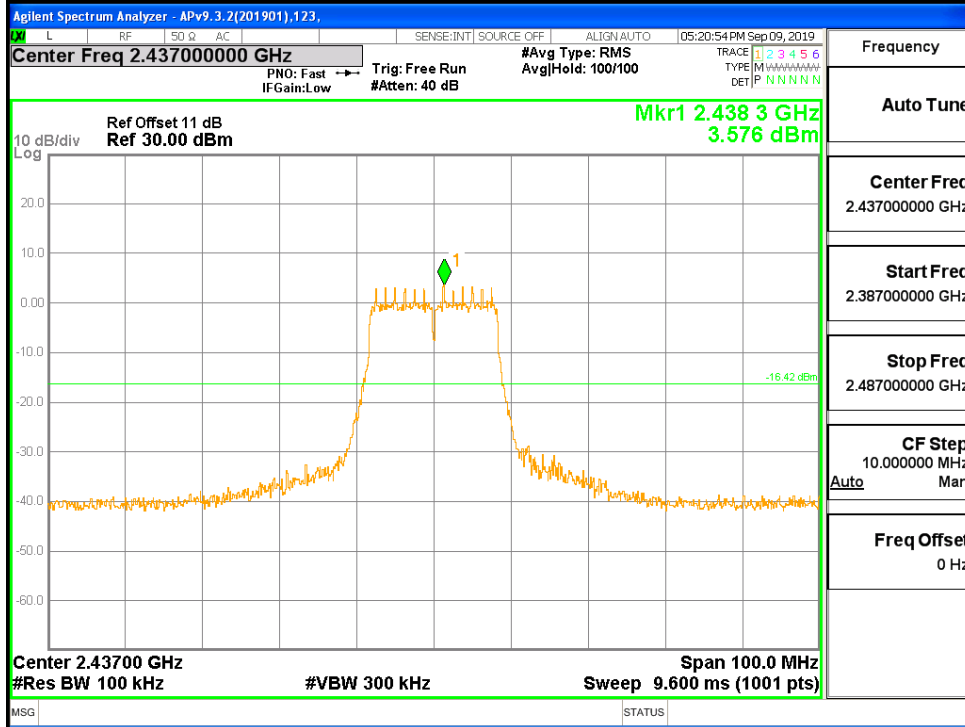

MID CH SPURIOUS EMISSIONS 30M-26G

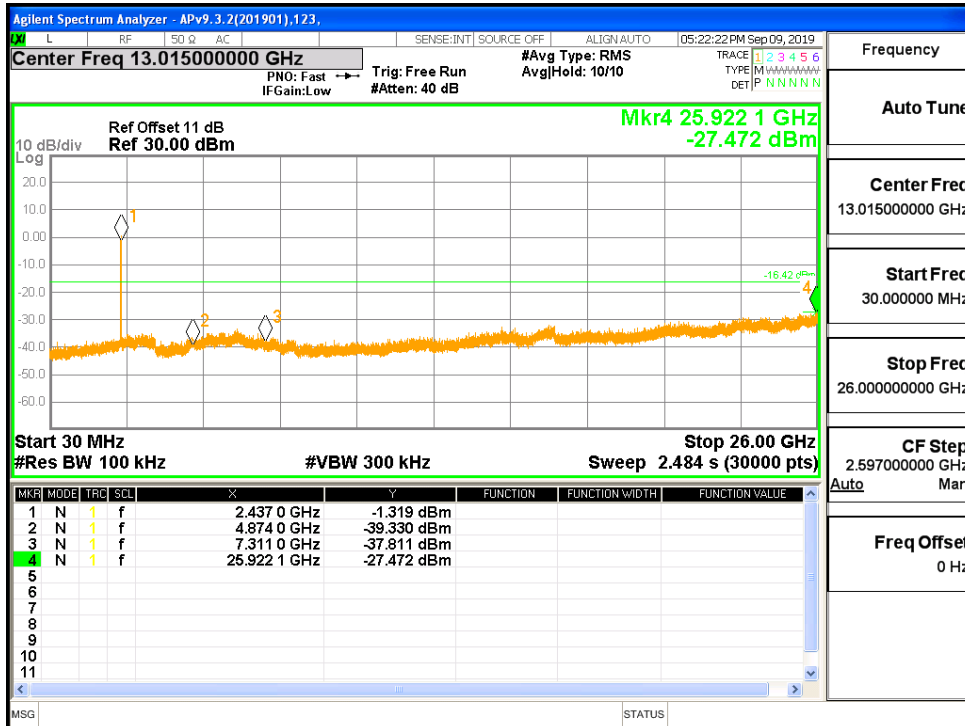



HIGH CH BANDEDGE

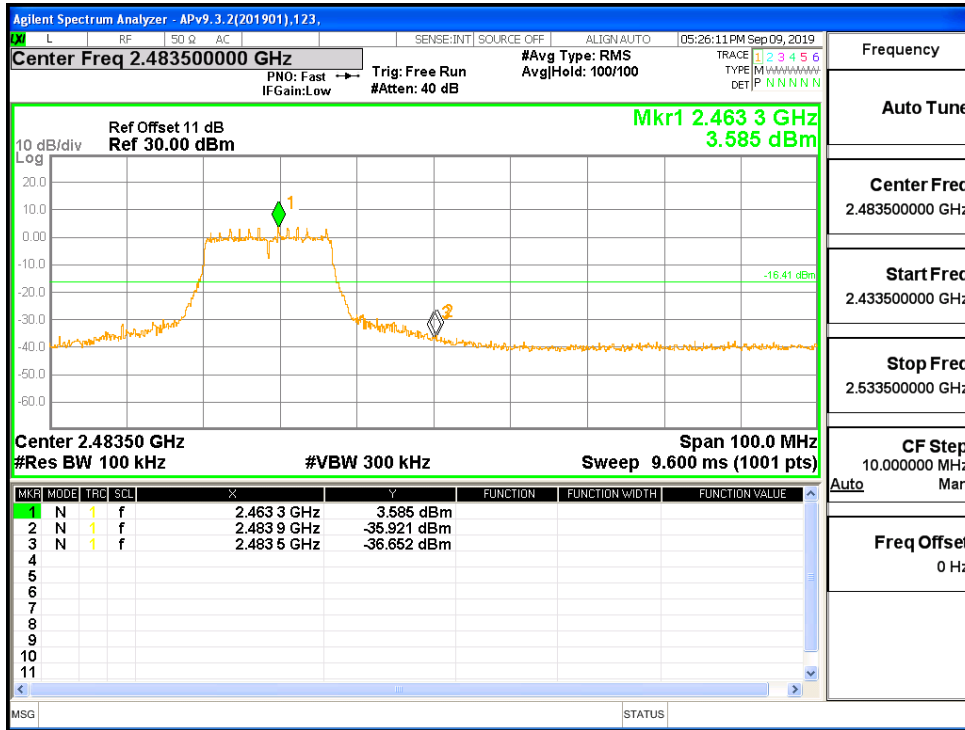

HIGH CH SPURIOUS EMISSIONS 30M-26G

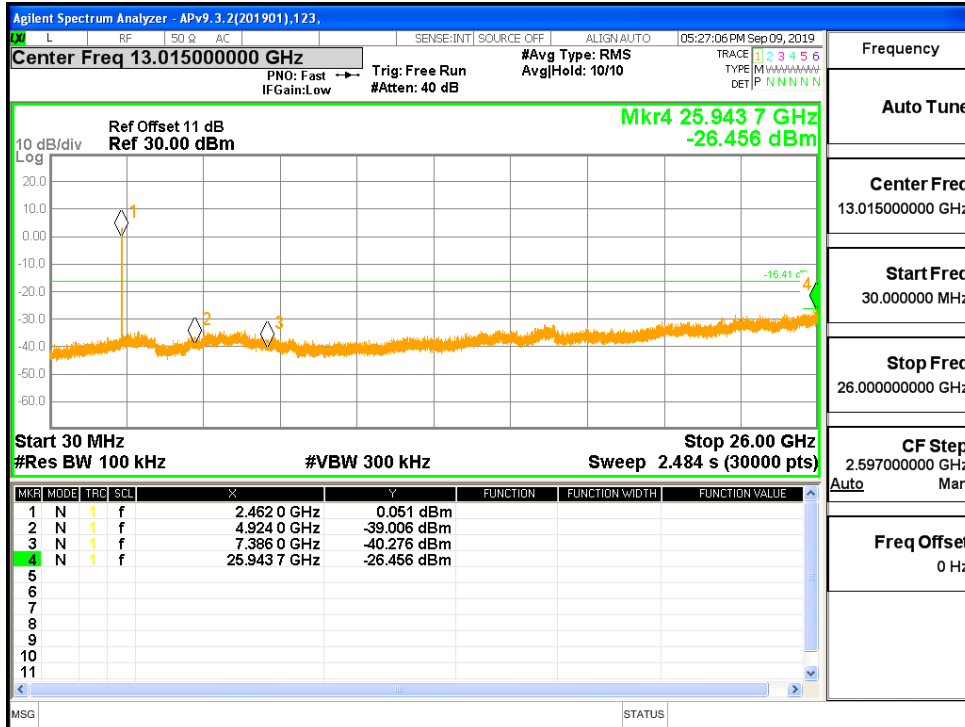



8.5.1. 802.11n HT20 MODE

LOW CH BANDEDGE

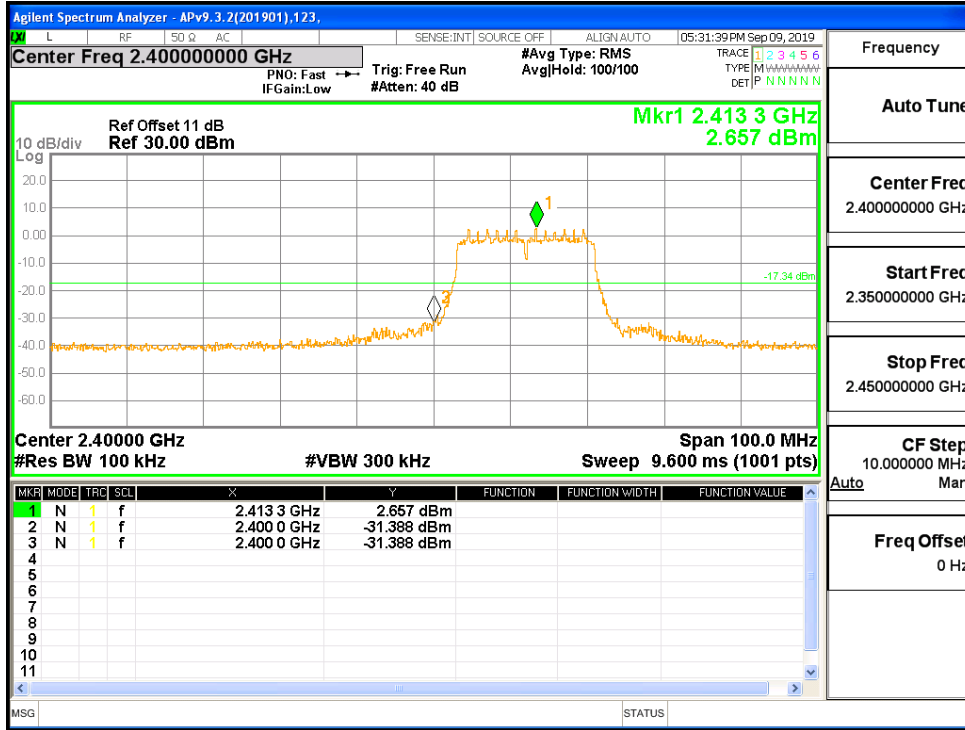

LOW CH SPURIOUS EMISSIONS 30M-26G

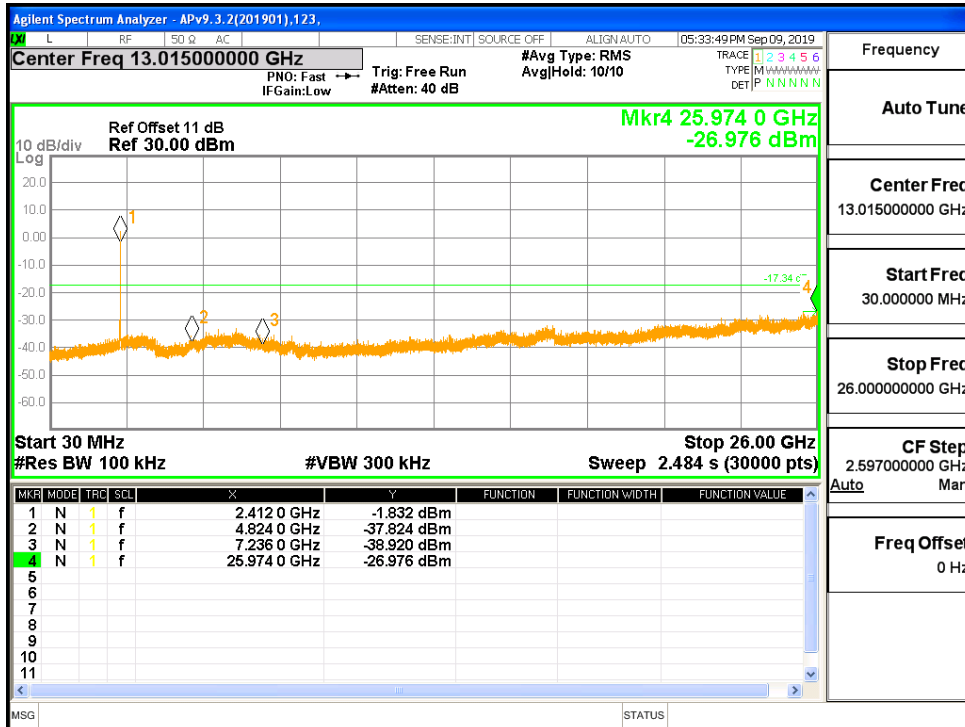



MID CH SPURIOUS EMISSIONS REFERENCE

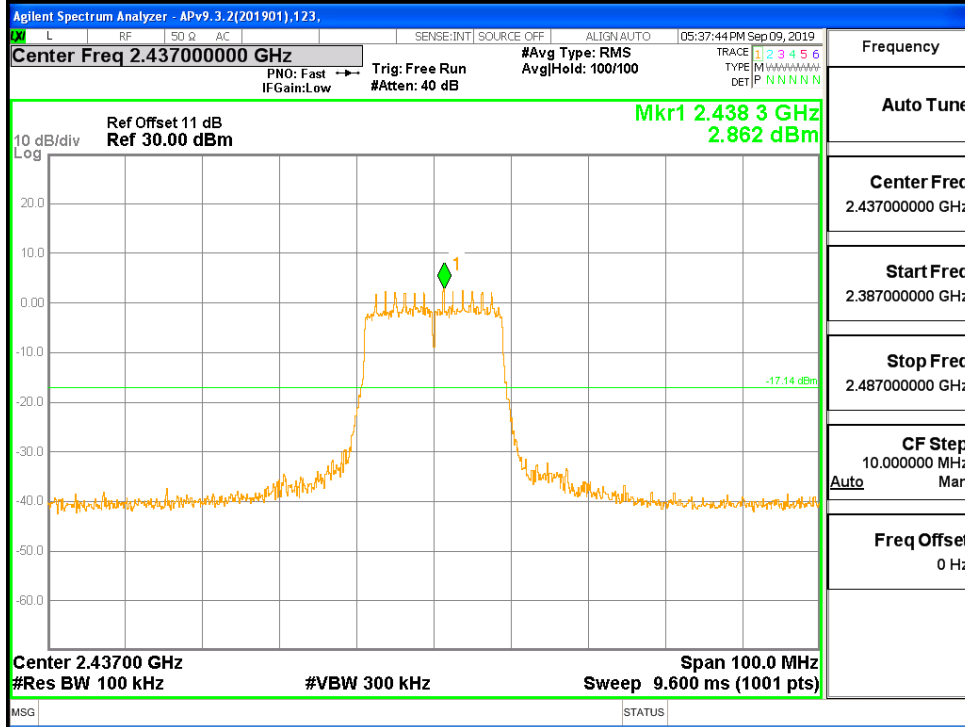

MID CH SPURIOUS EMISSIONS 30M-26G

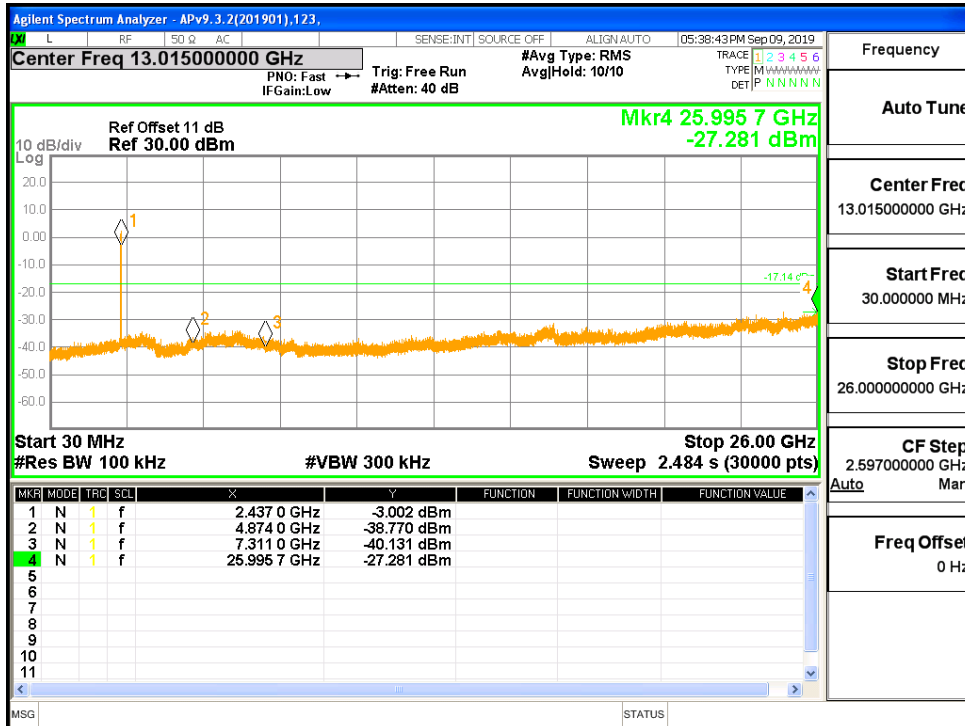



HIGH CH BANDEDGE

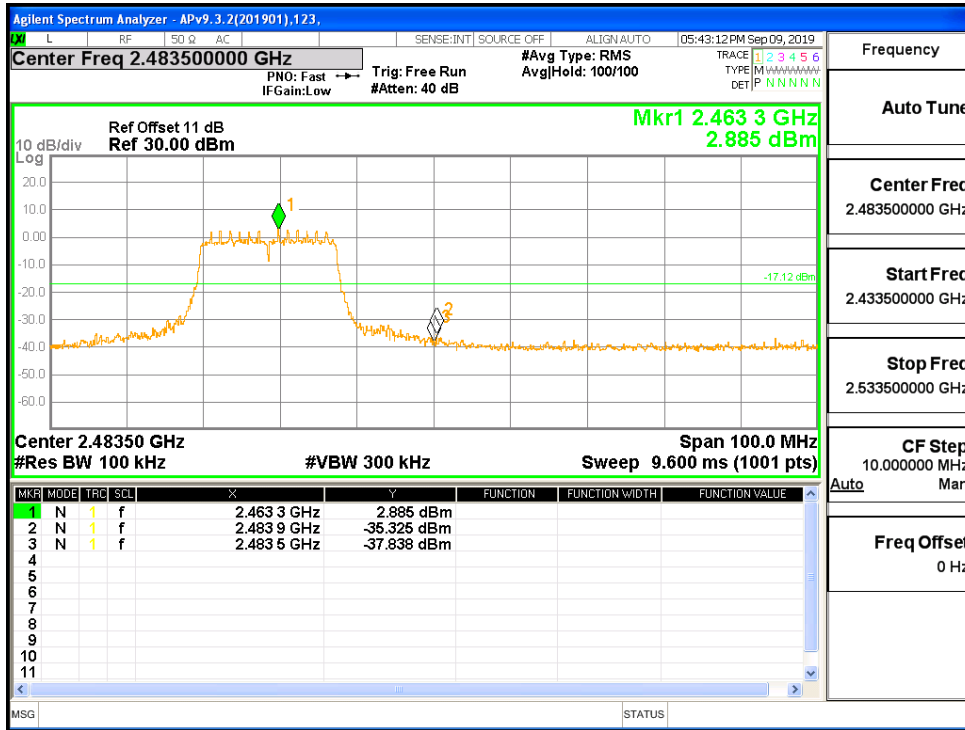

HIGH CH SPURIOUS EMISSIONS 30M-26G

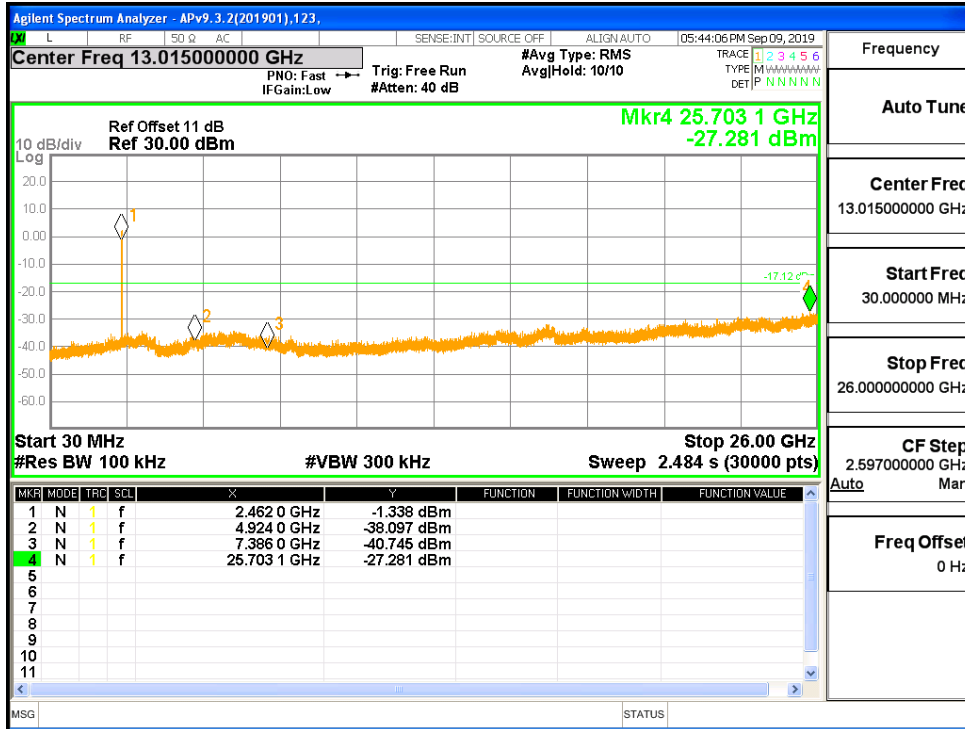



9. RADIATED TEST RESULTS

LIMITS

Please refer to CFR 47 FCC §15.205 and §15.209

Please refer to ISED RSS-GEN Clause 8.9 (Transmitter)

Radiation Disturbance Test Limit for FCC (Class B)(9KHz-1GHz)

Frequency (MHz)	Field Strength (microvolts/meter)	Measurement Distance (meters)
0.009~0.490	2400/F(KHz)	300
0.490~1.705	24000/F(KHz)	30
1.705~30.0	30	30
30~88	100	3
88~216	150	3
216~960	200	3
960~1000	500	3

Note: 1) At frequencies at or above 30 MHz, measurements may be performed at a distance other than what is specified provided: measurements are not made in the near field except where it can be shown that near field measurements are appropriate due to the characteristics of the device; and it can be demonstrated that the signal levels needed to be measured at the distance employed can be detected by the measurement equipment. Measurements shall not be performed at a distance greater than 30 meters unless it can be further demonstrated that measurements at a distance of 30 meters or less are impractical. When performing measurements at a distance other than that specified, the results shall be extrapolated to the specified distance using an extrapolation factor of 20 dB/decade (inverse linear-distance for field strength measurements; inverse-linear-distance-squared for power density measurements).

(2) At frequencies below 30 MHz, measurements may be performed at a distance closer than that specified in the regulations; however, an attempt should be made to avoid making measurements in the near field. Pending the development of an appropriate measurement procedure for measurements performed below 30 MHz, when performing measurements at a closer distance than specified, the results shall be extrapolated to the specified distance by either making measurements at a minimum of two distances on at least one radial to determine the proper extrapolation factor or by using the square of an inverse linear distance extrapolation factor (40 dB/decade). This paragraph (f) shall not apply to Access BPL devices operating below 30 MHz.



Radiation Disturbance Test Limit for FCC (Above 1G)

Frequency (MHz)	dB(uV/m) (at 3 meters)	
	Peak	Average
Above 1000	74	54

IC Restricted bands please refer to ISED RSS-GEN Clause 8.10

FCC Restricted bands of operation:

MHz	MHz	MHz	GHz
0.090-0.110	16.42-16.423	399.9-410	4.5-5.15
¹ 0.495-0.505	16.69475-16.69525	608-614	5.35-5.46
2.1735-2.1905	16.80425-16.80475	960-1240	7.25-7.75
4.125-4.128	25.5-25.67	1300-1427	8.025-8.5
4.17725-4.17775	37.5-38.25	1435-1626.5	9.0-9.2
4.20725-4.20775	73-74.6	1645.5-1646.5	9.3-9.5
6.215-6.218	74.8-75.2	1660-1710	10.6-12.7
6.26775-6.26825	108-121.94	1718.8-1722.2	13.25-13.4
6.31175-6.31225	123-138	2200-2300	14.47-14.5
8.291-8.294	149.9-150.05	2310-2390	15.35-16.2
8.362-8.366	156.52475-156.52525	2483.5-2500	17.7-21.4
8.37625-8.38675	156.7-156.9	2690-2900	22.01-23.12
8.41425-8.41475	162.0125-167.17	3260-3267	23.6-24.0
12.29-12.293	167.72-173.2	3332-3339	31.2-31.8
12.51975-12.52025	240-285	3345.8-3358	36.43-36.5
12.57675-12.57725	322-335.4	3600-4400	(²)
13.36-13.41			

Note: ¹Until February 1, 1999, this restricted band shall be 0.490-0.510 MHz.

²Above 38.6c

TEST SETUP AND PROCEDURE

Below 30MHz

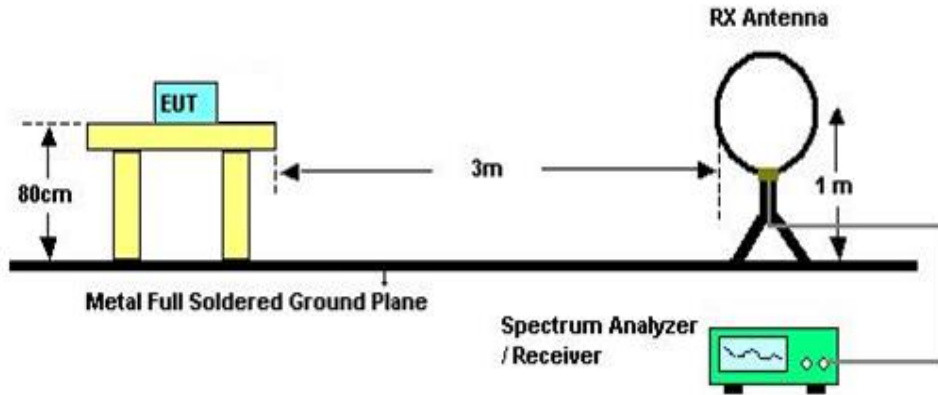

The setting of the spectrum analyser

RBW	200Hz (From 9kHz to 0.15MHz)/ 9KHz (From 0.15MHz to 30MHz)
VBW	200Hz (From 9kHz to 0.15MHz)/ 9KHz (From 0.15MHz to 30MHz)
Sweep	Auto
Detector	Peak/QP/ Average
Trace	Max hold

1. The testing follows the guidelines in ANSI C63.10-2013
2. The EUT was arranged to its worst case and then turntable (from 0 degree to 360 degrees) to find the maximum reading. A pre-amp and a high pass filter are used for the test in order to get better signal level. 3 polarizations(Horizontal, Face-on and Face-off) of the loop antenna are set to make the measurement.
3. The EUT was placed on a turntable with 0.8 meter above ground.
4. The EUT was set 3 meters from the interference receiving antenna, which was mounted on the top of a variable height antenna tower.
5. For measurement below 1GHz, the initial step in collecting conducted emission data is a spectrum analyzer peak detector mode pre-scanning the measurement frequency range. Significant peaks are then marked and then Quasi Peak detector mode re-measured. If the emission level of the EUT measured by the peak detector is 3 dB lower than the applicable limit, the peak emission level will be reported. Otherwise, the emission measurement will be repeated using the quasi-peak detector and reported.
6. For the actual test configuration, please refer to the related item in this test report (Photographs of the Test Configuration)
7. Although these tests were performed other than open field site, adequate comparison measurements were confirmed against 30m open field site. Therefore sufficient tests were made to demonstrate that the alternative site produces results that correlate with the ones of tests made in an open field site based on KDB 414788.

Below 1G

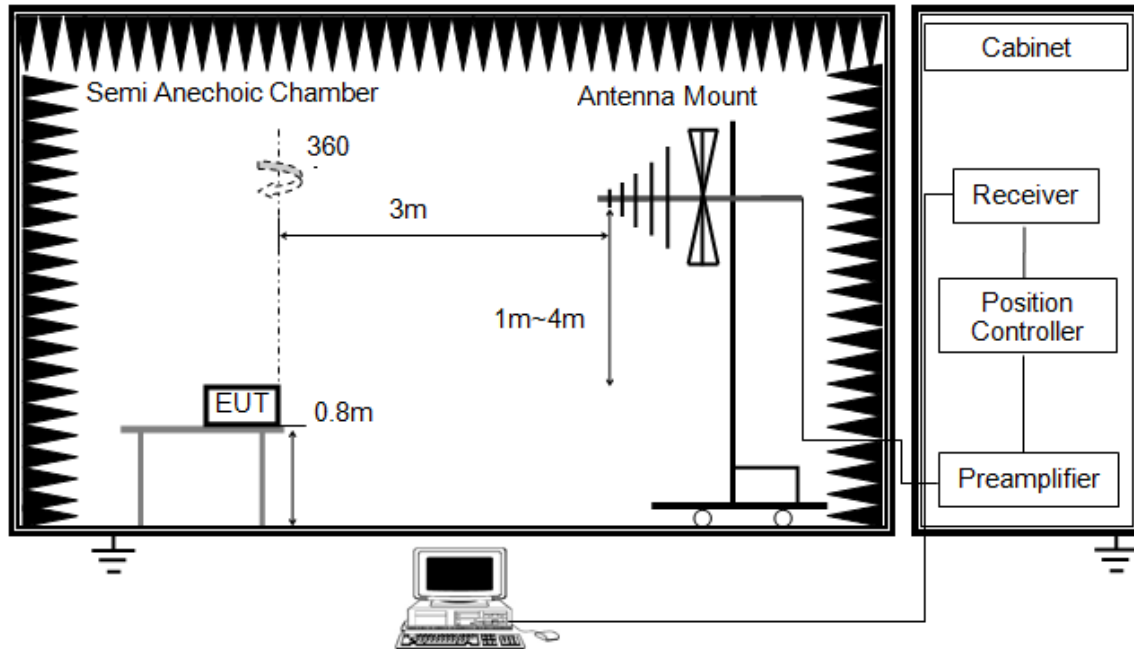

The setting of the spectrum analyser

RBW	120K
VBW	300K
Sweep	Auto
Detector	Peak/QP
Trace	Max hold

1. The testing follows the guidelines in ANSI C63.10-2013.
2. The EUT was arranged to its worst case and then tune the antenna tower (from 1 m to 4 m) and turntable (from 0 degree to 360 degrees) to find the maximum reading. A pre-amp and a high pass filter are used for the test in order to get better signal level. Both horizontal and vertical polarizations of the antenna are set to make the measurement.
3. The EUT was placed on a turntable with 0.8 meter above ground.
4. The EUT was set 3 meters from the interference receiving antenna, which was mounted on the top of a variable height antenna tower.
5. For measurement below 1GHz, the initial step in collecting conducted emission data is a spectrum analyzer peak detector mode pre-scanning the measurement frequency range. Significant peaks are then marked and then Quasi Peak detector mode re-measured. If the emission level of the EUT measured by the peak detector is 3 dB lower than the applicable limit, the peak emission level will be reported. Otherwise, the emission measurement will be repeated using the quasi-peak detector and reported.

ABOVE 1G

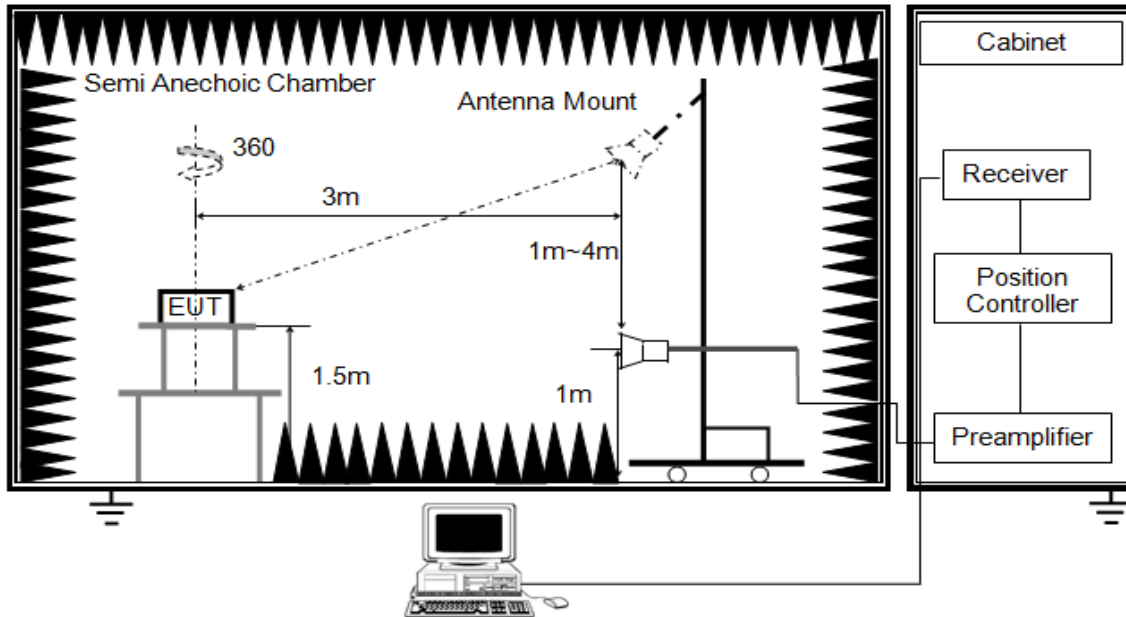

The setting of the spectrum analyser

RBW	1M
VBW	PEAK: 3M AVG: see note 6
Sweep	Auto
Detector	Peak
Trace	Max hold

1. The testing follows the guidelines in ANSI C63.10-2013.
2. The EUT was arranged to its worst case and then tune the antenna tower (from 1 m to 4 m) and turntable (from 0 degree to 360 degrees) to find the maximum reading. A pre-amp and a high pass filter are used for the test in order to get better signal level. Both horizontal and vertical polarizations of the antenna are set to make the measurement.
3. The EUT was placed on a turntable with 1.5m above ground.
4. The EUT was set 3 meters from the interference receiving antenna, which was mounted on the top of a variable height antenna tower.
5. For measurement above 1GHz, the emission measurement will be measured by the peak detector. This peak level, once corrected, must comply with the limit specified in Section 15.209.
6. For measurements above 1 GHz the resolution bandwidth is set to 1 MHz, then the video bandwidth is set to 3 MHz for peak measurements and 1 MHz resolution bandwidth with 1/T video bandwidth with peak detector for average measurements. For the Duty Cycle please refer to clause 8.1.ON TIME AND DUTY CYCLE.

X axis, Y axis, Z axis positions:

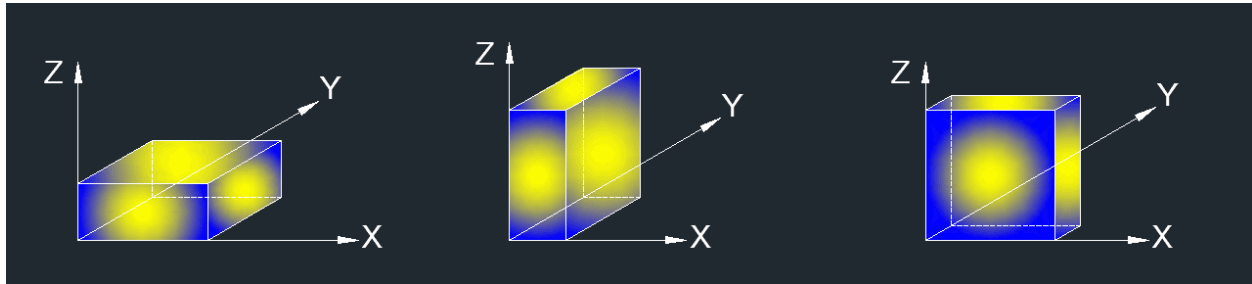

Note 1: For all radiated test, EUT in each of three orthogonal axis emissions had been tested, but only the worst case (X axis) data recorded in the report.

Note 2: The EUT was fully exercised with external accessories during the test. In the case of multiple accessory external ports, an external accessory shall be connected to one of each type of port.

TEST ENVIRONMENT

Temperature	23.2°C	Relative Humidity	52%
Atmosphere Pressure	101kPa	Test Voltage	AC 120V,60Hz



9.1. RESTRICTED BANDEDGE

9.1.1. 802.11b MODE

RESTRICTED BANDEDGE (LOW CHANNEL, HORIZONTAL)

PEAK

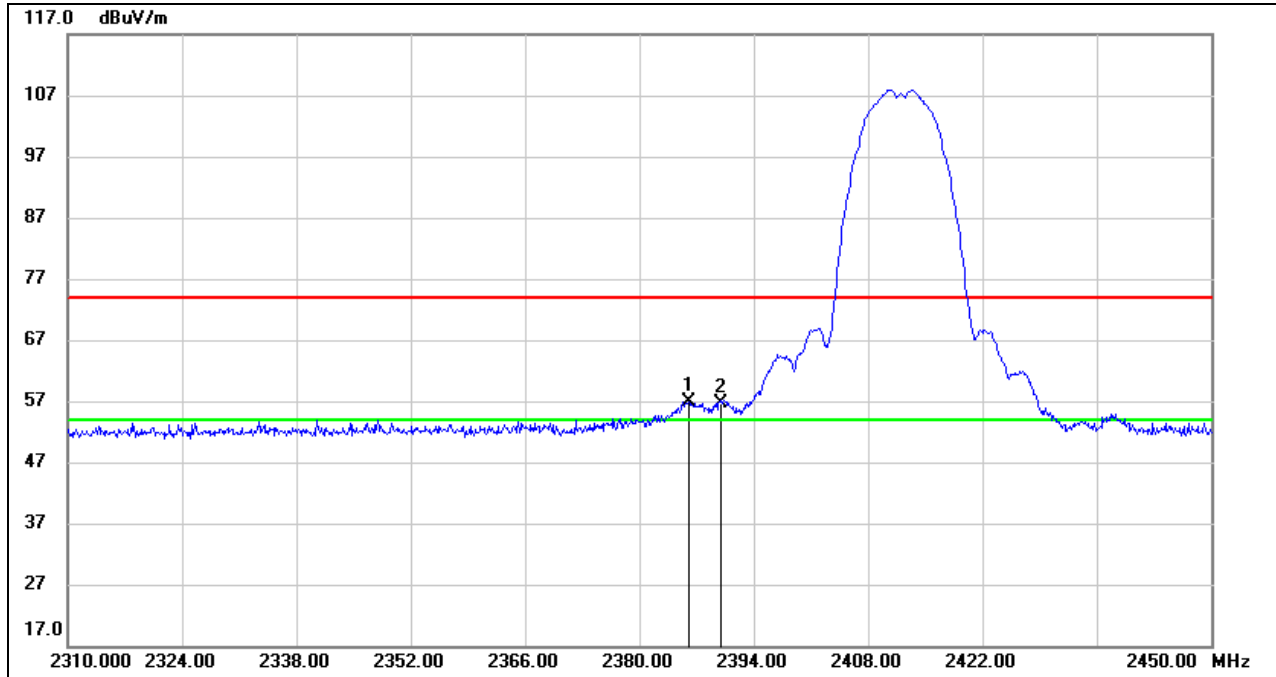

No.	Frequency (MHz)	Reading (dBuV)	Correct (dB/m)	Result (dBuV/m)	Limit (dBuV/m)	Margin (dB)	Remark
1	2386.020	24.05	32.80	56.85	74.00	-17.15	peak
2	2390.000	23.88	32.81	56.69	74.00	-17.31	peak

- Note: 1. Measurement = Reading Level + Correct Factor.
 2. If Peak Result complies with AV limit, AV Result is deemed to comply with AV limit.
 3. Peak: Peak detector.
 4. Only the worst case emission was recorded, if it complies with the limit, the other emissions deemed to comply with the limit.



AVG

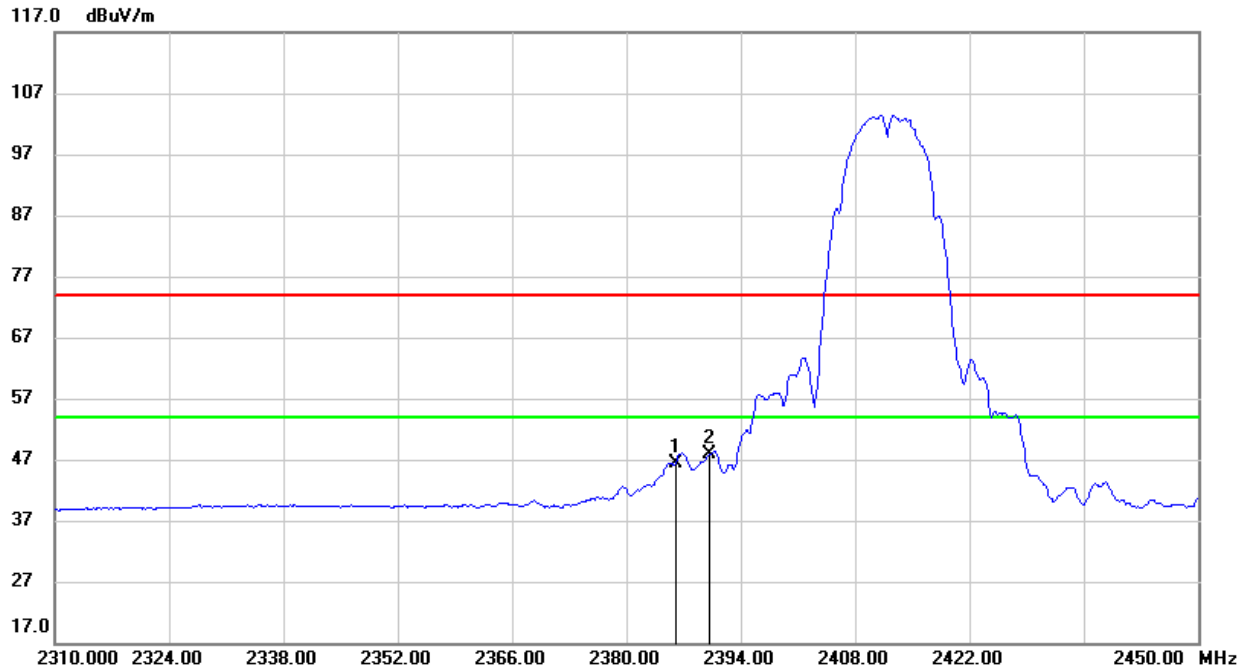

No.	Frequency (MHz)	Reading (dBuV)	Correct (dB/m)	Result (dBuV/m)	Limit (dBuV/m)	Margin (dB)	Remark
1	2386.020	13.60	32.80	46.40	54.00	-7.60	AVG
2	2390.000	15.01	32.81	47.82	54.00	-6.18	AVG

- Note: 1. Measurement = Reading Level + Correct Factor.
 2. If Peak Result complies with AV limit, AV Result is deemed to comply with AV limit.
 3. AVG: $VBW=1/Ton$ where: ton is transmit duration.
 4. For transmit duration, please refer to clause 8.1.
 5. Only the worst case emission was recorded, if it complies with the limit, the other emissions deemed to comply with the limit.



RESTRICTED BANDEDGE (LOW CHANNEL, VERTICAL)

PEAK

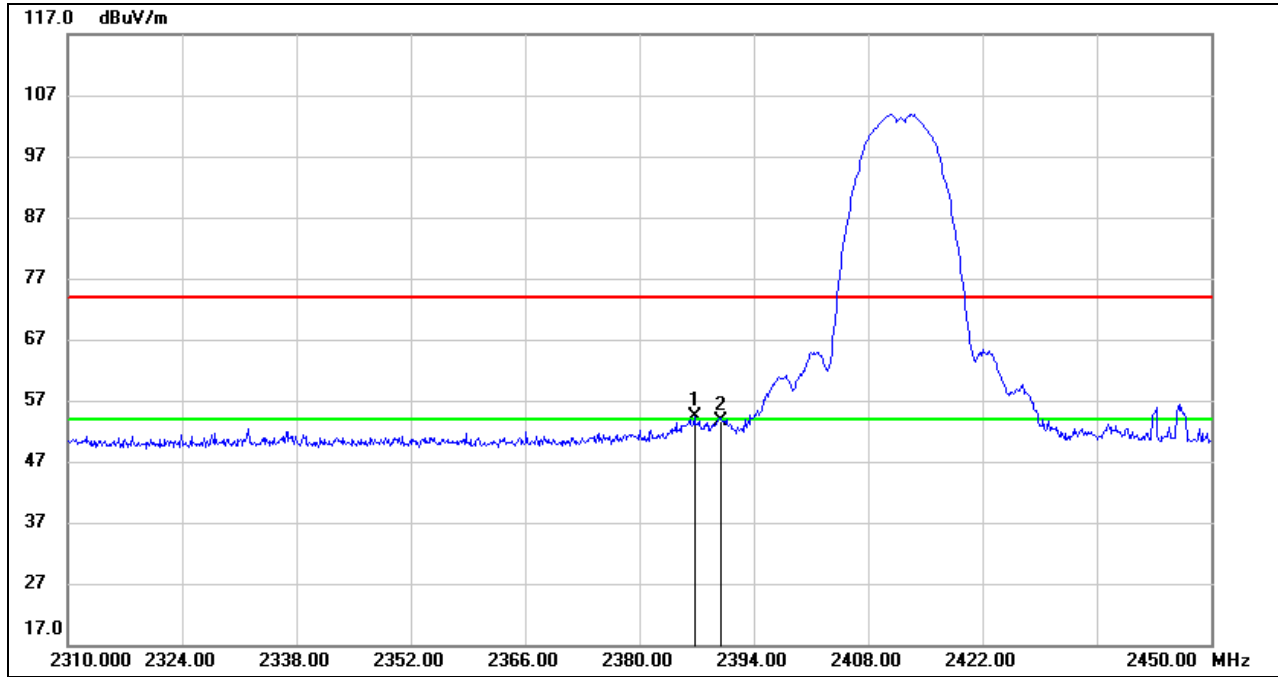

No.	Frequency (MHz)	Reading (dBuV)	Correct (dB/m)	Result (dBuV/m)	Limit (dBuV/m)	Margin (dB)	Remark
1	2386.720	21.49	32.80	54.29	74.00	-19.71	peak
2	2390.000	20.73	32.81	53.54	74.00	-20.46	peak

- Note: 1. Measurement = Reading Level + Correct Factor.
 2. If Peak Result complies with AV limit, AV Result is deemed to comply with AV limit.
 3. Peak: Peak detector.
 4. Only the worst case emission was recorded, if it complies with the limit, the other emissions deemed to comply with the limit.



AVG

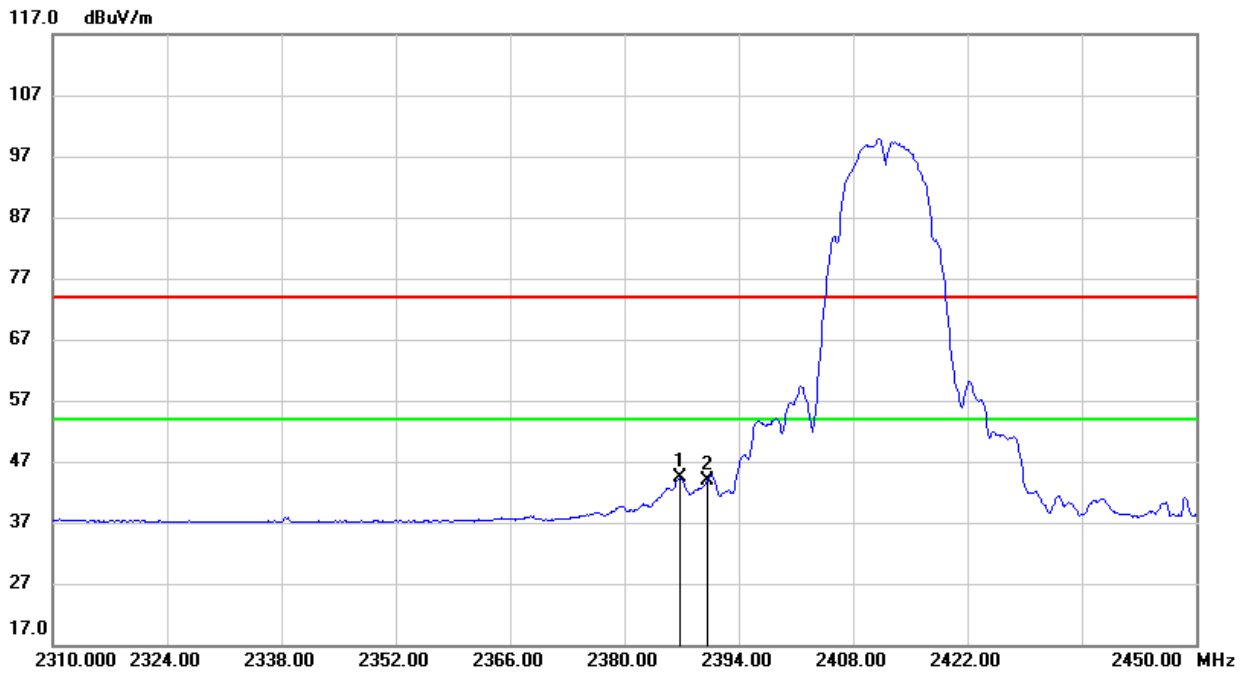

No.	Frequency (MHz)	Reading (dBuV)	Correct (dB/m)	Result (dBuV/m)	Limit (dBuV/m)	Margin (dB)	Remark
1	2386.720	11.49	32.80	44.29	54.00	-9.71	AVG
2	2390.000	10.97	32.81	43.78	54.00	-10.22	AVG

- Note: 1. Measurement = Reading Level + Correct Factor.
 2. If Peak Result complies with AV limit, AV Result is deemed to comply with AV limit.
 3. AVG: $VBW=1/T_{on}$ where: t_{on} is transmit duration.
 4. For transmit duration, please refer to clause 8.1.
 5. Only the worst case emission was recorded, if it complies with the limit, the other emissions deemed to comply with the limit.



RESTRICTED BANDEDGE (HIGH CHANNEL, HORIZONTAL)

PEAK

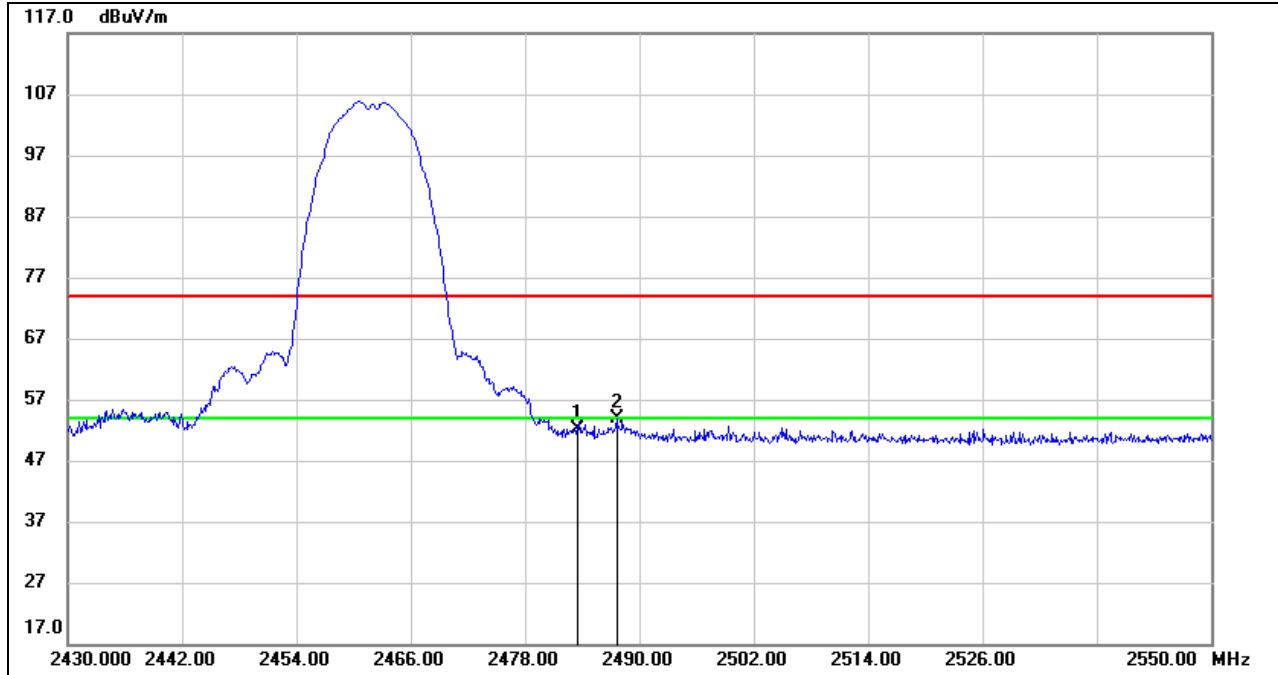

No.	Frequency (MHz)	Reading (dBuV)	Correct (dB/m)	Result (dBuV/m)	Limit (dBuV/m)	Margin (dB)	Remark
1	2483.500	19.03	33.09	52.12	74.00	-21.88	peak
2	2487.600	20.76	33.10	53.86	74.00	-20.14	peak

- Note: 1. Measurement = Reading Level + Correct Factor.
 2. If Peak Result complies with AV limit, AV Result is deemed to comply with AV limit.
 3. Peak: Peak detector.
 4. Only the worst case emission was recorded, if it complies with the limit, the other emissions deemed to comply with the limit.



AVG

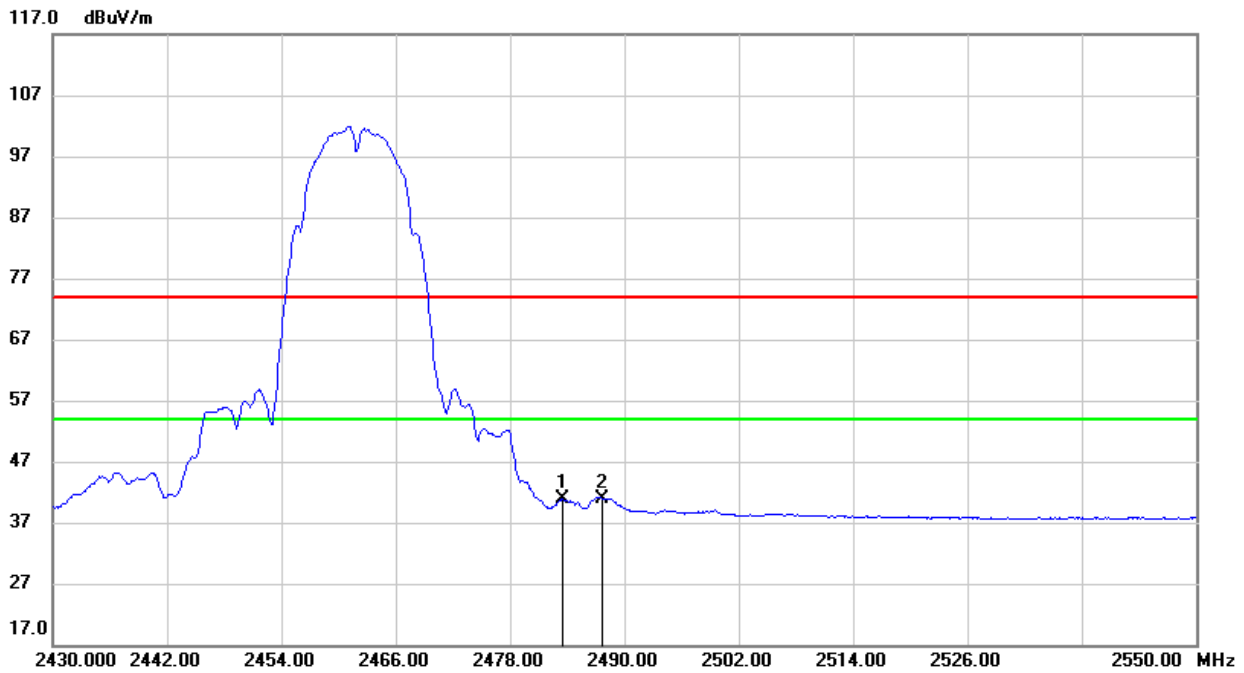

No.	Frequency (MHz)	Reading (dBuV)	Correct (dB/m)	Result (dBuV/m)	Limit (dBuV/m)	Margin (dB)	Remark
1	2483.500	7.76	33.09	40.85	54.00	-13.15	AVG
2	2487.600	7.78	33.10	40.88	54.00	-13.12	AVG

- Note: 1. Measurement = Reading Level + Correct Factor.
 2. If Peak Result complies with AV limit, AV Result is deemed to comply with AV limit.
 3. AVG: $VBW=1/Ton$ where: ton is transmit duration.
 4. For transmit duration, please refer to clause 8.1.
 5. Only the worst case emission was recorded, if it complies with the limit, the other emissions deemed to comply with the limit.



RESTRICTED BANDEDGE (HIGH CHANNEL, VERTICAL)

PEAK

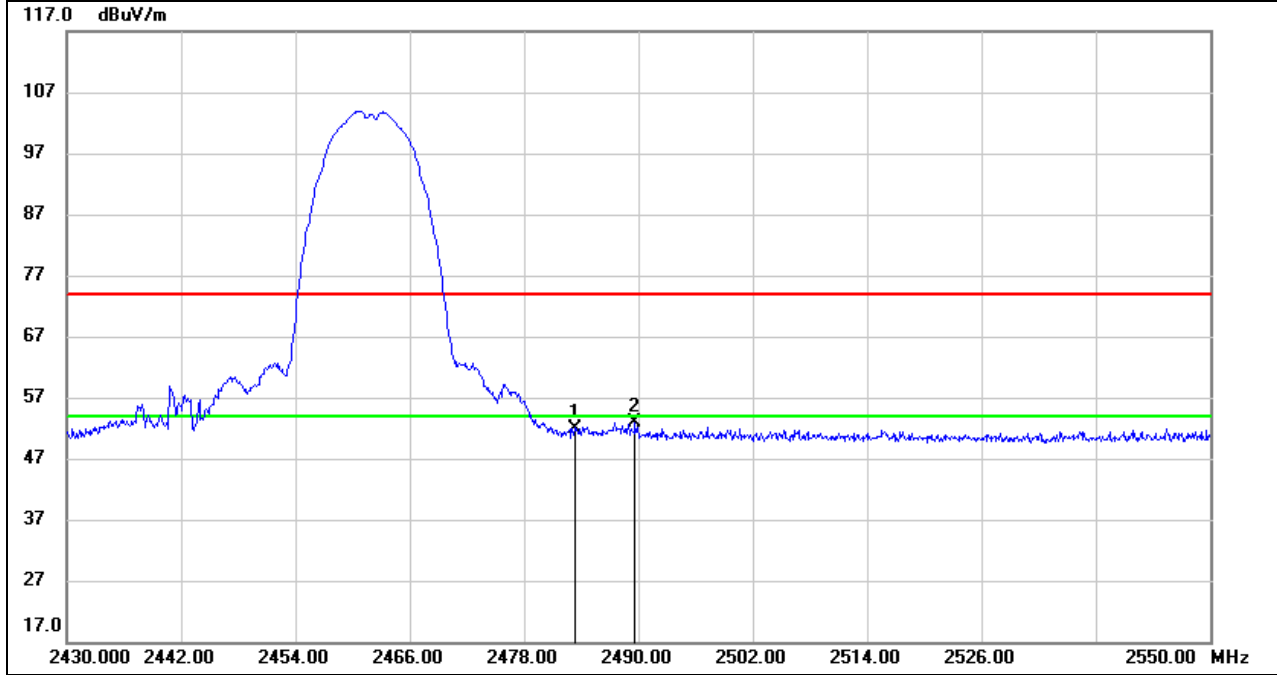

No.	Frequency (MHz)	Reading (dBuV)	Correct (dB/m)	Result (dBuV/m)	Limit (dBuV/m)	Margin (dB)	Remark
1	2483.500	18.77	33.09	51.86	74.00	-22.14	peak
2	2489.640	19.84	33.12	52.96	74.00	-21.04	peak

- Note: 1. Measurement = Reading Level + Correct Factor.
 2. If Peak Result complies with AV limit, AV Result is deemed to comply with AV limit.
 3. Peak: Peak detector.
 4. Only the worst case emission was recorded, if it complies with the limit, the other emissions deemed to comply with the limit.



9.1.2. 802.11g MODE

RESTRICTED BANDEDGE (LOW CHANNEL, HORIZONTAL)

PEAK

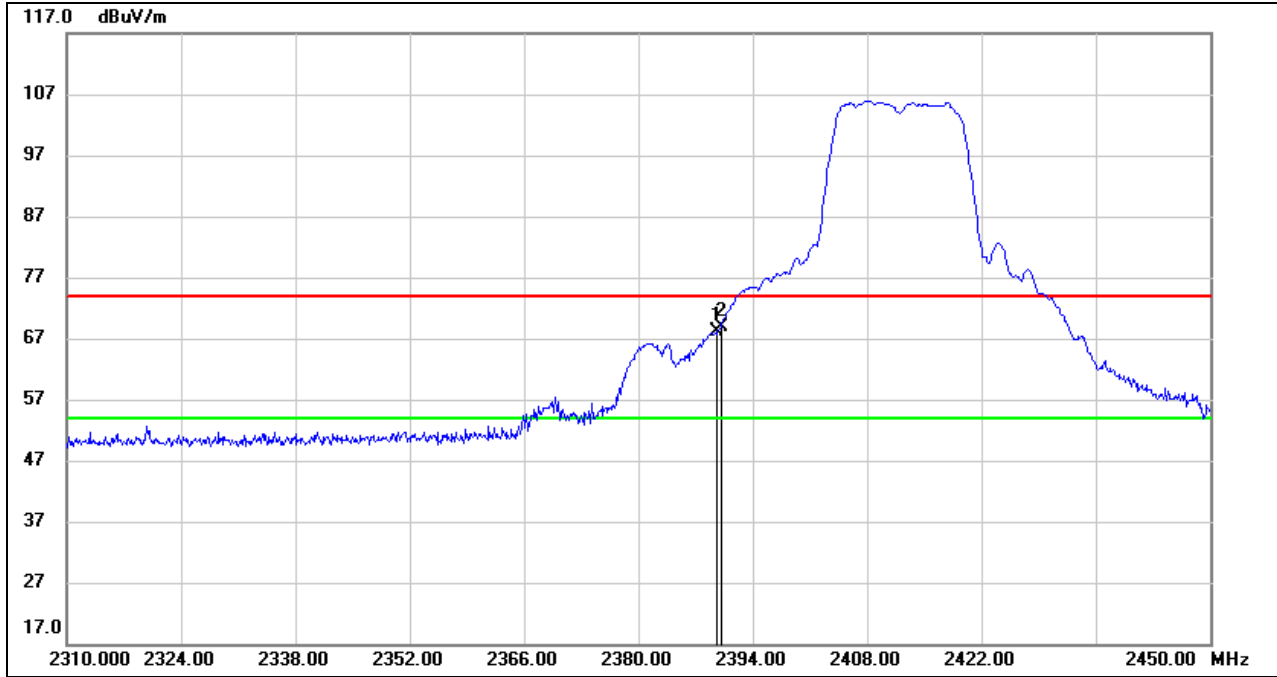

No.	Frequency (MHz)	Reading (dBuV)	Correct (dB/m)	Result (dBuV/m)	Limit (dBuV/m)	Margin (dB)	Remark
1	2389.660	35.43	32.81	68.24	74.00	-5.76	peak
2	2390.000	36.05	32.81	68.86	74.00	-5.14	peak

- Note: 1. Measurement = Reading Level + Correct Factor.
 2. If Peak Result complies with AV limit, AV Result is deemed to comply with AV limit.
 3. Peak: Peak detector.
 4. Only the worst case emission was recorded, if it complies with the limit, the other emissions deemed to comply with the limit.



AVG

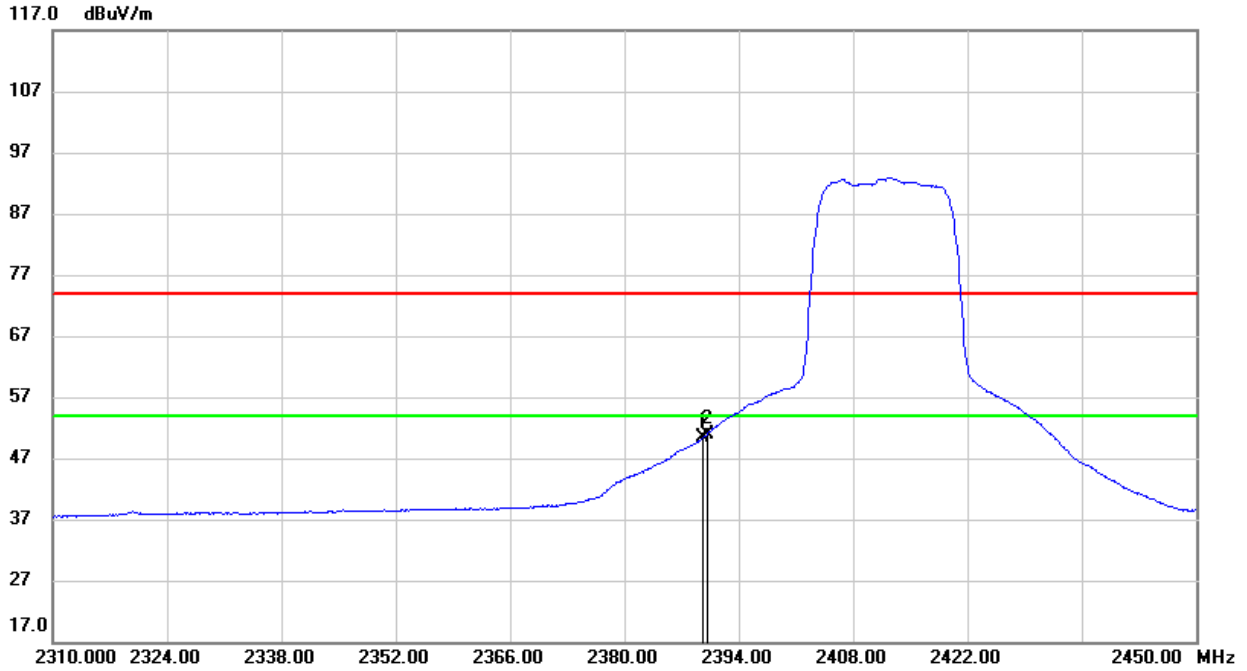

No.	Frequency (MHz)	Reading (dBuV)	Correct (dB/m)	Result (dBuV/m)	Limit (dBuV/m)	Margin (dB)	Remark
1	2389.660	17.60	32.81	50.41	54.00	-3.59	AVG
2	2390.000	18.17	32.81	50.98	54.00	-3.02	AVG

- Note:
1. Measurement = Reading Level + Correct Factor.
 2. If Peak Result complies with AV limit, AV Result is deemed to comply with AV limit.
 3. AVG: $VBW=1/T_{on}$ where: t_{on} is transmit duration.
 4. For transmit duration, please refer to clause 8.1.
 5. Only the worst case emission was recorded, if it complies with the limit, the other emissions deemed to comply with the limit.



RESTRICTED BANDEDGE (LOW CHANNEL, VERTICAL)

PEAK

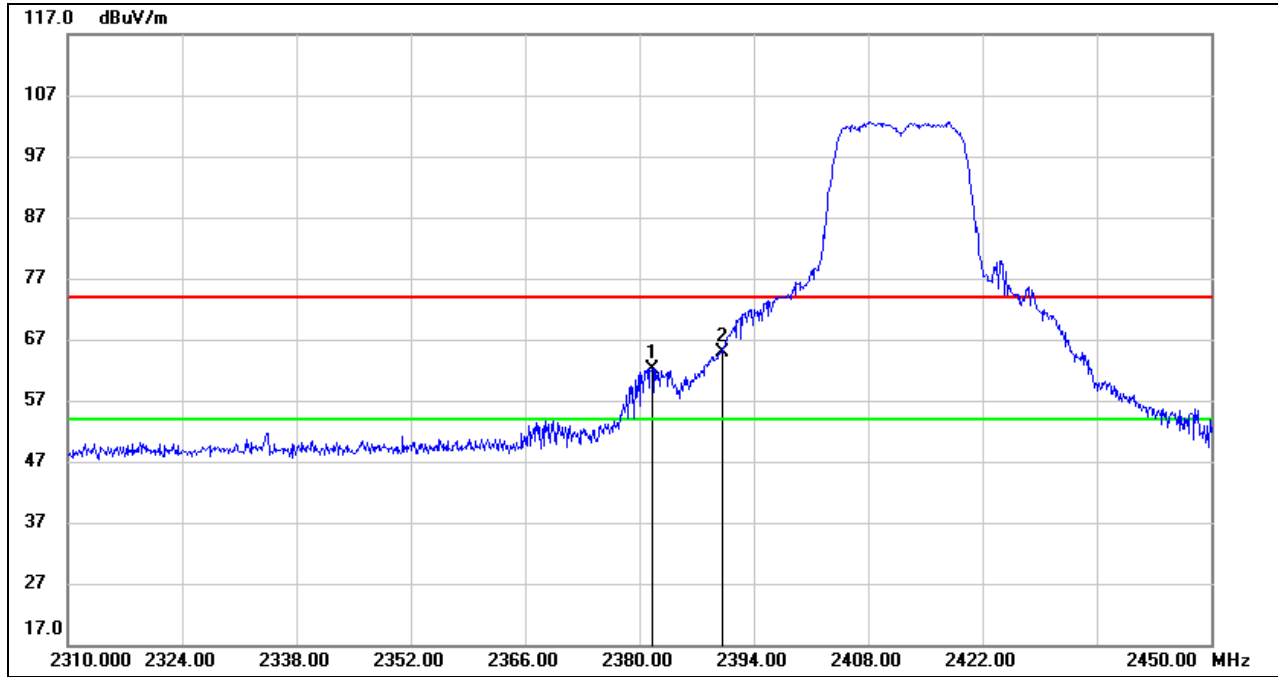

No.	Frequency (MHz)	Reading (dBuV)	Correct (dB/m)	Result (dBuV/m)	Limit (dBuV/m)	Margin (dB)	Remark
1	2381.540	29.43	32.79	62.22	74.00	-11.78	peak
2	2390.000	32.12	32.81	64.93	74.00	-9.07	peak

- Note: 1. Measurement = Reading Level + Correct Factor.
 2. If Peak Result complies with AV limit, AV Result is deemed to comply with AV limit.
 3. Peak: Peak detector.
 4. Only the worst case emission was recorded, if it complies with the limit, the other emissions deemed to comply with the limit.



AVG

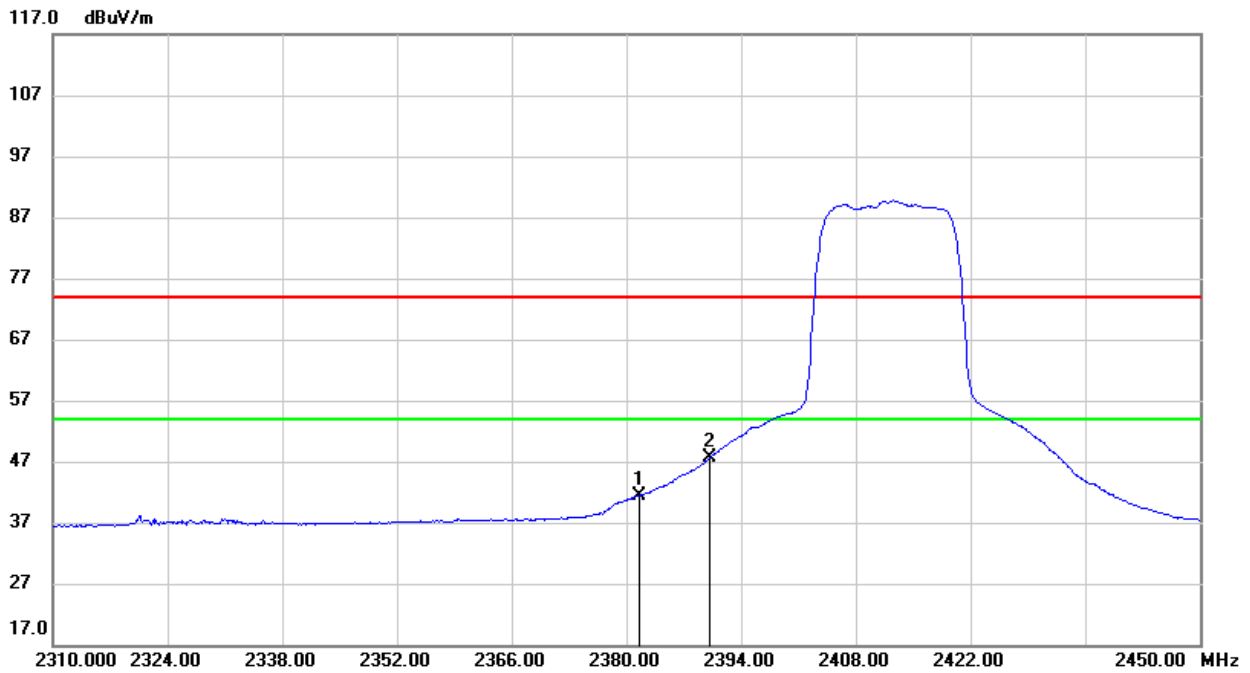

No.	Frequency (MHz)	Reading (dBuV)	Correct (dB/m)	Result (dBuV/m)	Limit (dBuV/m)	Margin (dB)	Remark
1	2381.540	8.67	32.79	41.46	54.00	-12.54	AVG
2	2390.000	14.71	32.81	47.52	54.00	-6.48	AVG

- Note: 1. Measurement = Reading Level + Correct Factor.
 2. If Peak Result complies with AV limit, AV Result is deemed to comply with AV limit.
 3. AVG: $VBW=1/T_{on}$ where: t_{on} is transmit duration.
 4. For transmit duration, please refer to clause 8.1.
 5. Only the worst case emission was recorded, if it complies with the limit, the other emissions deemed to comply with the limit.



RESTRICTED BANDEDGE (HIGH CHANNEL, HORIZONTAL)

PEAK

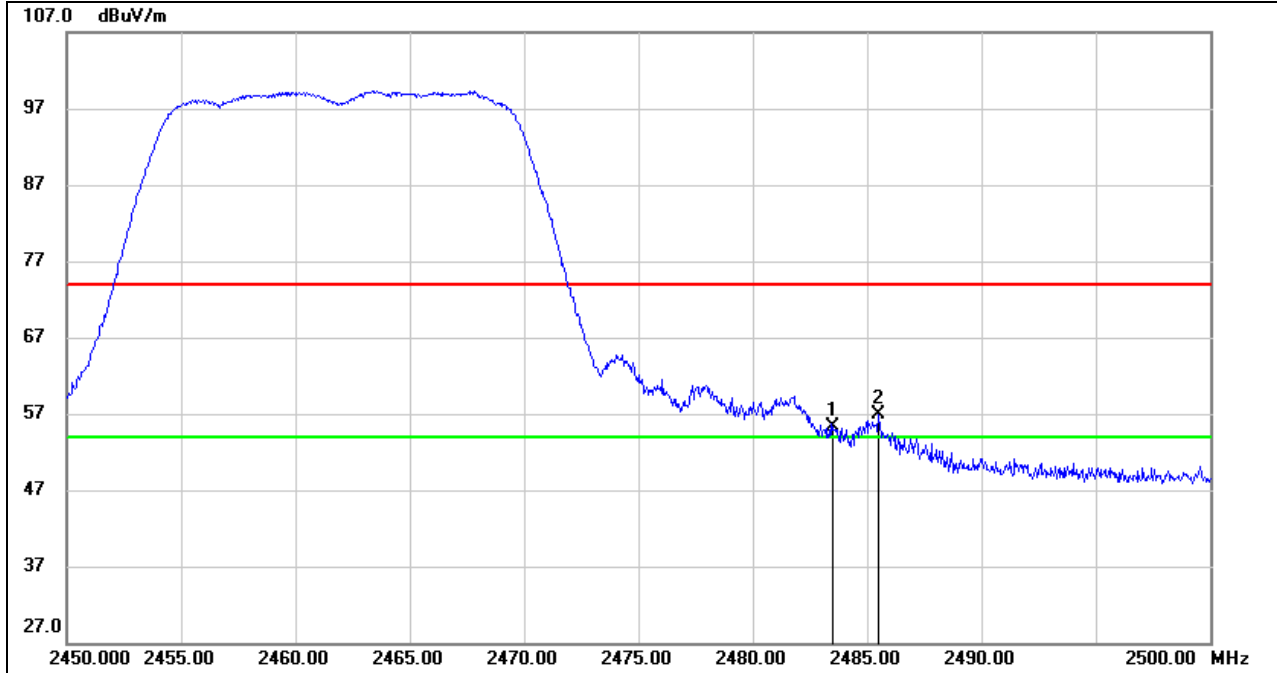

No.	Frequency (MHz)	Reading (dBuV)	Correct (dB/m)	Result (dBuV)	Limit (dBuV)	Margin (dB)	Remark
1	2483.500	21.64	33.58	55.22	74.00	-18.78	peak
2	2485.500	23.27	33.59	56.86	74.00	-17.14	peak

Note: 1. Measurement = Reading Level + Correct Factor.
 2. If Peak Result complies with AV limit, AV Result is deemed to comply with AV limit.
 3. Peak: Peak detector.
 4. Only the worst case emission was recorded, if it complies with the limit, the other emissions deemed to comply with the limit.



AVG

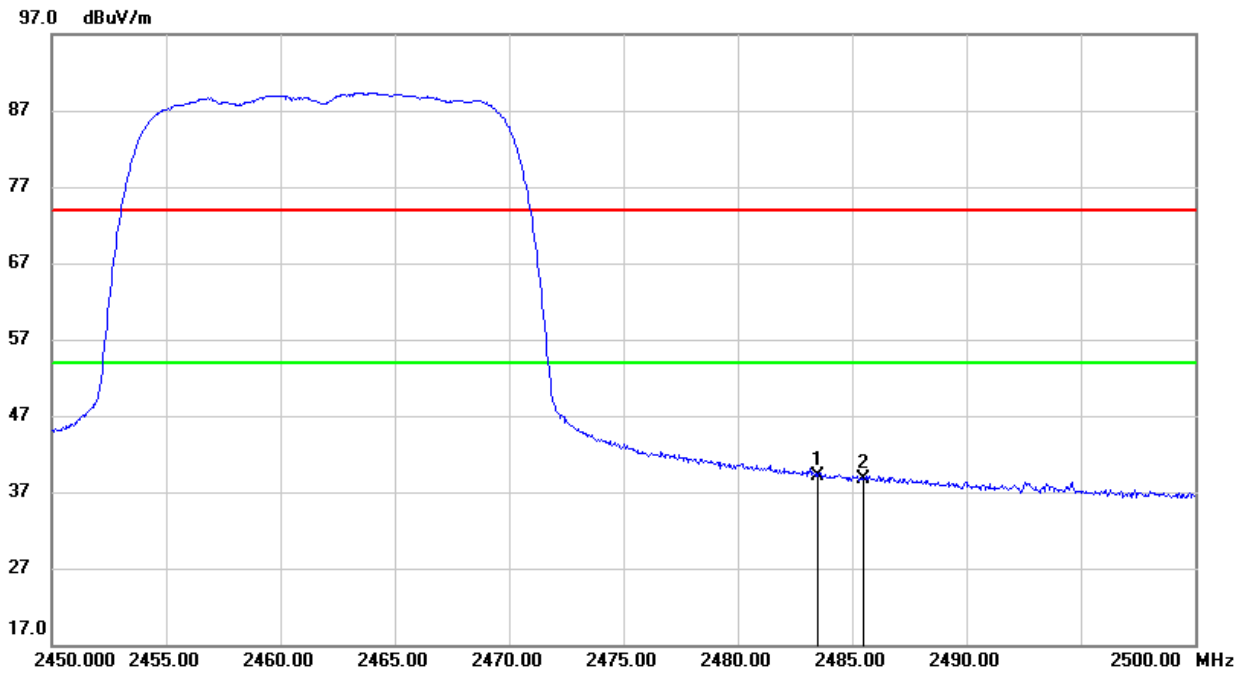

No.	Frequency (MHz)	Reading (dBuV)	Correct (dB/m)	Result (dBuV)	Limit (dBuV)	Margin (dB)	Remark
1	2483.500	5.49	33.58	39.07	54.00	-14.93	AVG
2	2485.500	5.02	33.59	38.61	54.00	-15.39	AVG

- Note: 1. Measurement = Reading Level + Correct Factor.
 2. If Peak Result complies with AV limit, AV Result is deemed to comply with AV limit.
 3. AVG: $VBW=1/T_{on}$ where: t_{on} is transmit duration.
 4. For transmit duration, please refer to clause 8.1.
 5. Only the worst case emission was recorded, if it complies with the limit, the other emissions deemed to comply with the limit.



RESTRICTED BANDEDGE (HIGH CHANNEL, VERTICAL)

PEAK

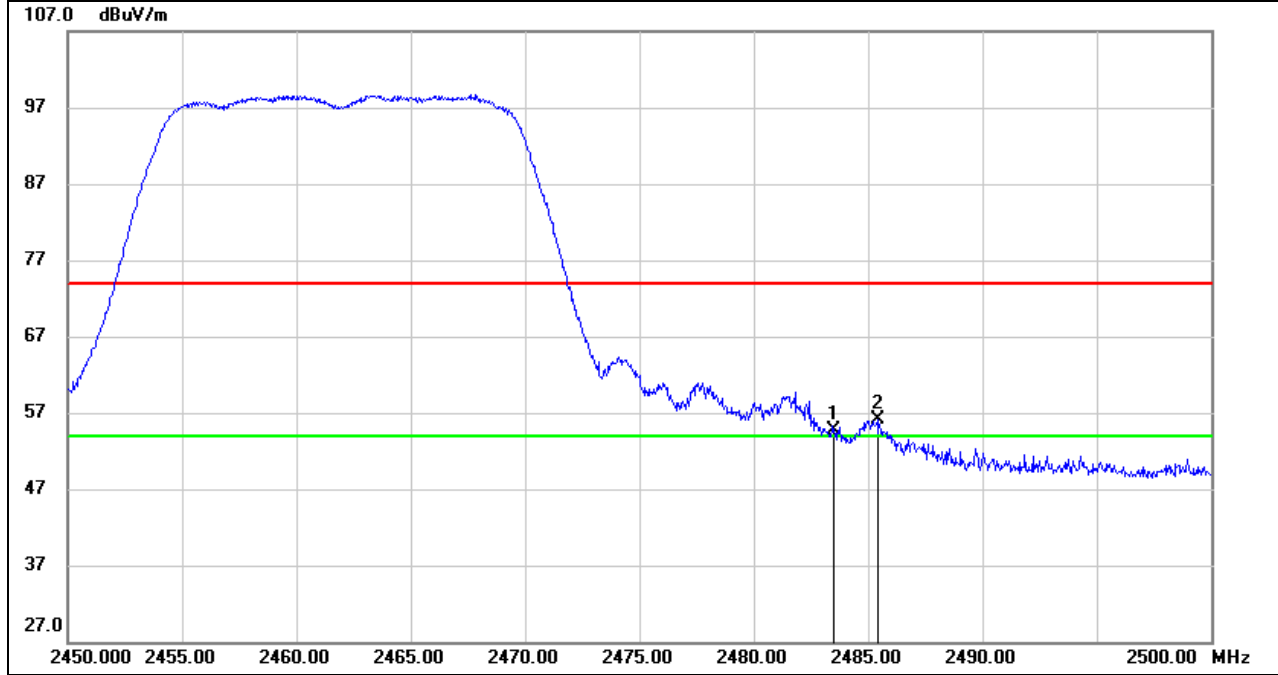

No.	Frequency (MHz)	Reading (dBuV)	Correct (dB/m)	Result (dBuV)	Limit (dBuV)	Margin (dB)	Remark
1	2483.500	21.14	33.58	54.72	74.00	-19.28	peak
2	2485.400	22.54	33.59	56.13	74.00	-17.87	peak

- Note: 1. Measurement = Reading Level + Correct Factor.
 2. If Peak Result complies with AV limit, AV Result is deemed to comply with AV limit.
 3. Peak: Peak detector.
 4. Only the worst case emission was recorded, if it complies with the limit, the other emissions deemed to comply with the limit.



AVG

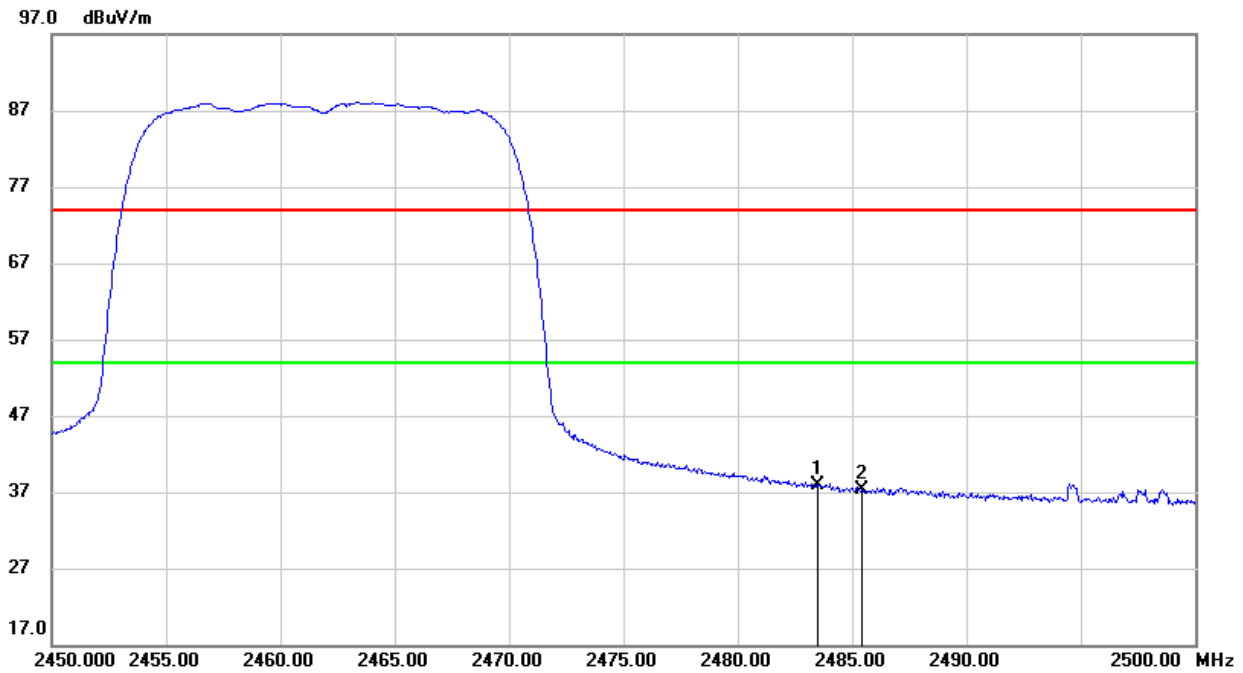

No.	Frequency (MHz)	Reading (dBuV)	Correct (dB/m)	Result (dBuV)	Limit (dBuV)	Margin (dB)	Remark
1	2483.500	4.28	33.58	37.86	54.00	-16.14	AVG
2	2485.400	3.63	33.59	37.22	54.00	-16.78	AVG

- Note: 1. Measurement = Reading Level + Correct Factor.
 2. If Peak Result complies with AV limit, AV Result is deemed to comply with AV limit.
 3. AVG: $VBW=1/T_{on}$ where: t_{on} is transmit duration.
 4. For transmit duration, please refer to clause 8.1.
 5. Only the worst case emission was recorded, if it complies with the limit, the other emissions deemed to comply with the limit.



9.1.3. 802.11n HT20 MODE

RESTRICTED BANDEDGE (LOW CHANNEL, HORIZONTAL)

PEAK

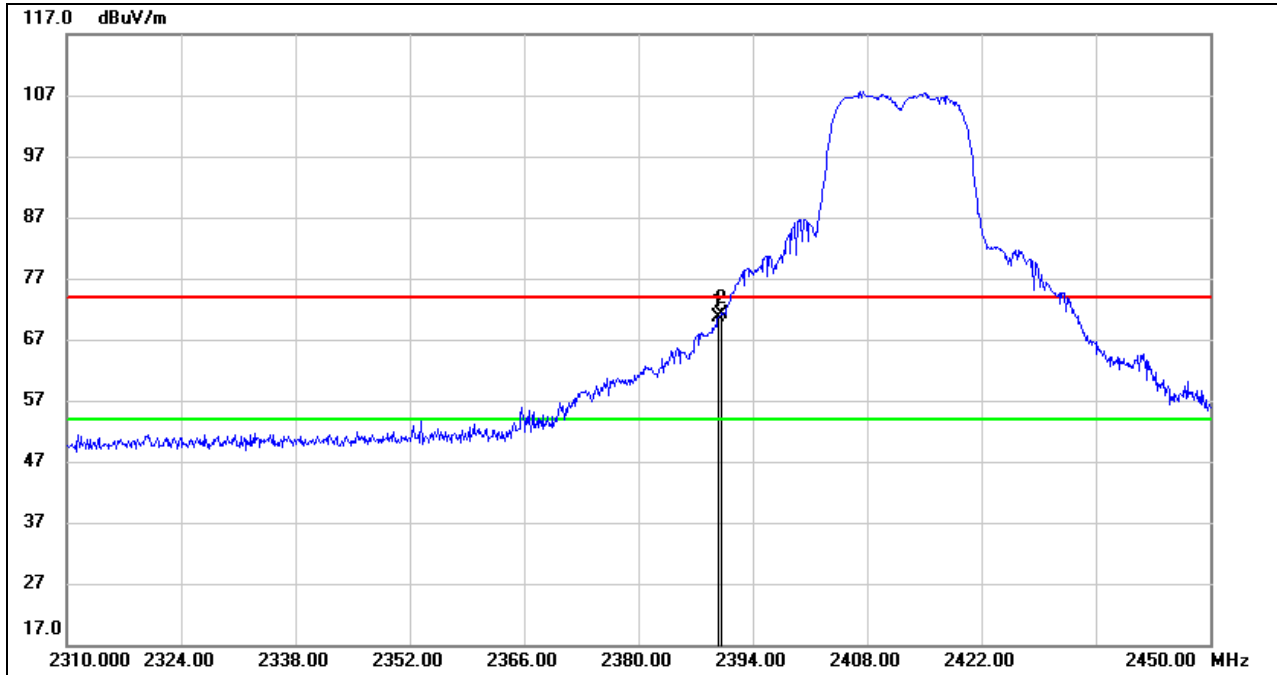

No.	Frequency (MHz)	Reading (dBuV)	Correct (dB/m)	Result (dBuV/m)	Limit (dBuV/m)	Margin (dB)	Remark
1	2389.800	37.75	32.81	70.56	74.00	-3.44	peak
2	2390.000	38.23	32.81	71.04	74.00	-2.96	peak

- Note: 1. Measurement = Reading Level + Correct Factor.
 2. If Peak Result complies with AV limit, AV Result is deemed to comply with AV limit.
 3. Peak: Peak detector.
 4. Only the worst case emission was recorded, if it complies with the limit, the other emissions deemed to comply with the limit.



AVG

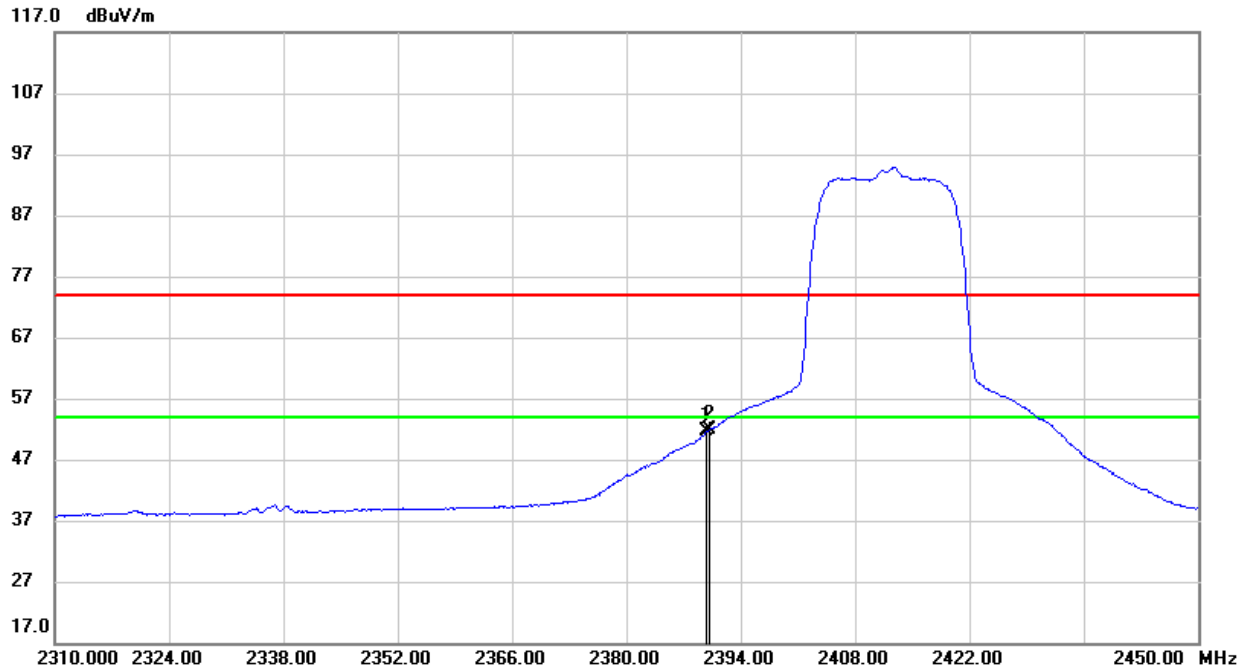

No.	Frequency (MHz)	Reading (dBuV)	Correct (dB/m)	Result (dBuV/m)	Limit (dBuV/m)	Margin (dB)	Remark
1	2389.800	18.72	32.81	51.53	54.00	-2.47	AVG
2	2390.000	19.05	32.81	51.86	54.00	-2.14	AVG

- Note:
1. Measurement = Reading Level + Correct Factor.
 2. If Peak Result complies with AV limit, AV Result is deemed to comply with AV limit.
 3. AVG: $VBW=1/Ton$ where: ton is transmit duration.
 4. For transmit duration, please refer to clause 8.1.
 5. Only the worst case emission was recorded, if it complies with the limit, the other emissions deemed to comply with the limit.



RESTRICTED BANDEDGE (LOW CHANNEL, VERTICAL)

PEAK

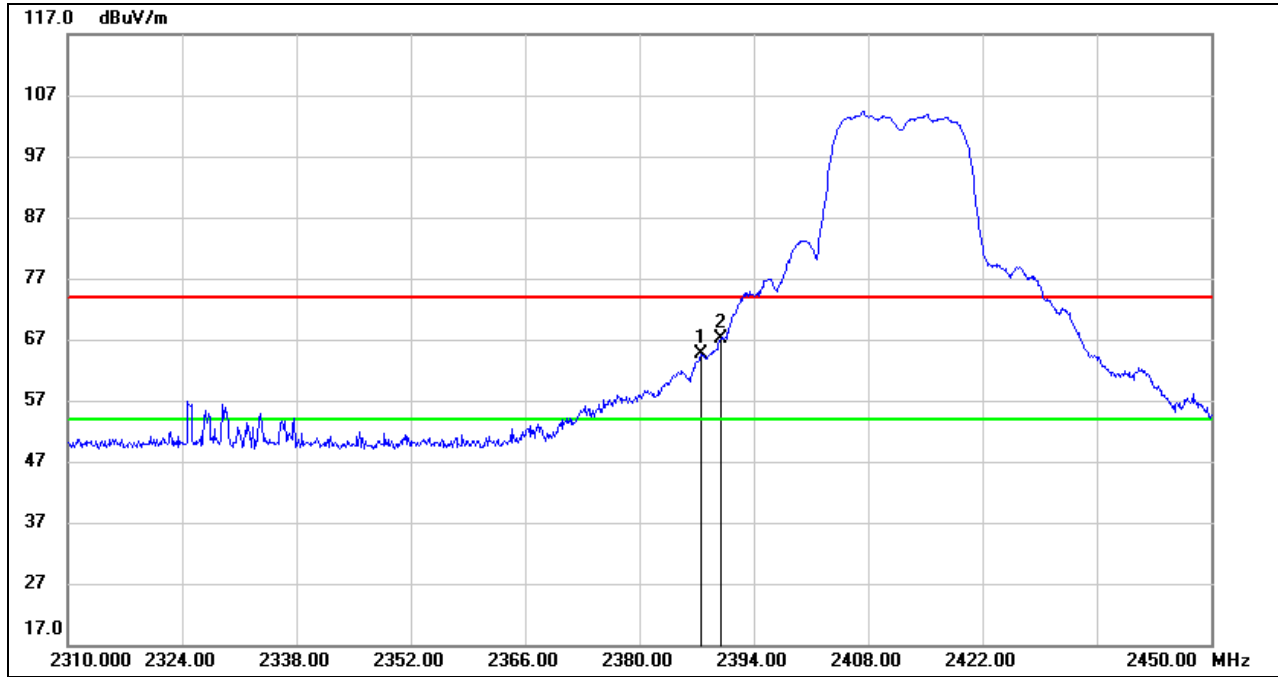

No.	Frequency (MHz)	Reading (dBuV)	Correct (dB/m)	Result (dBuV/m)	Limit (dBuV/m)	Margin (dB)	Remark
1	2387.560	31.80	32.80	64.60	74.00	-9.40	peak
2	2390.000	34.20	32.81	67.01	74.00	-6.99	peak

- Note: 1. Measurement = Reading Level + Correct Factor.
2. If Peak Result complies with AV limit, AV Result is deemed to comply with AV limit.
3. Peak: Peak detector.
4. Only the worst case emission was recorded, if it complies with the limit, the other emissions deemed to comply with the limit.



AVG

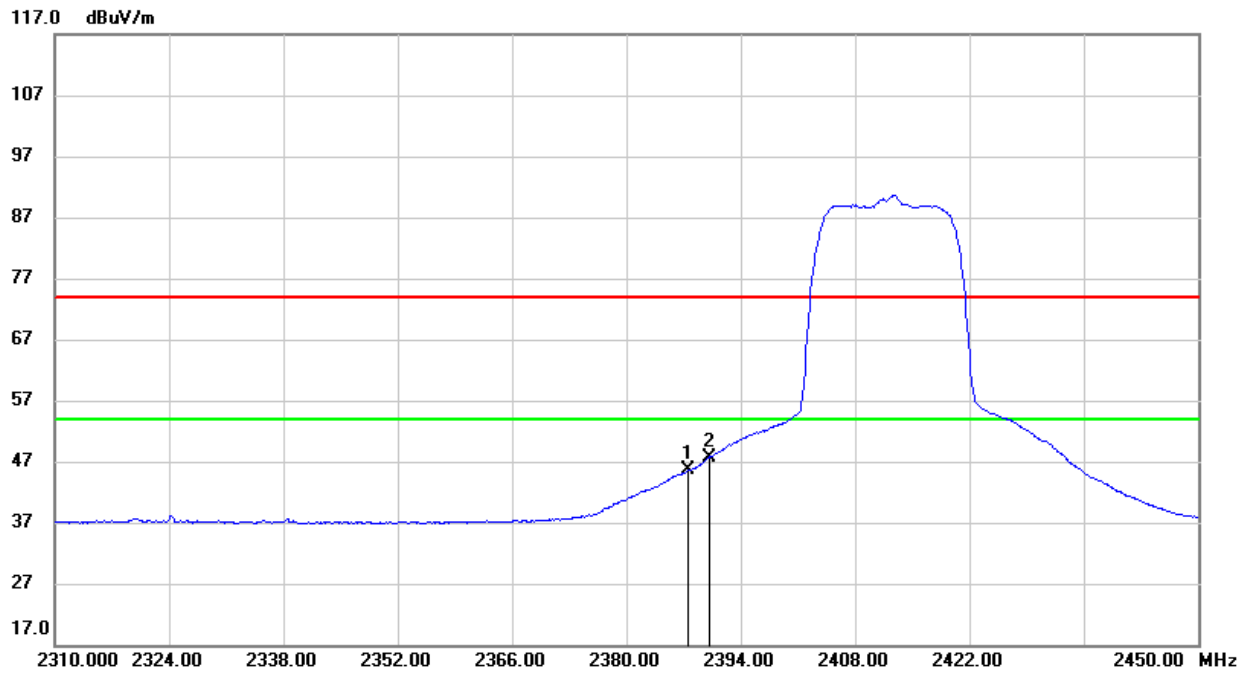

No.	Frequency (MHz)	Reading (dBuV)	Correct (dB/m)	Result (dBuV/m)	Limit (dBuV/m)	Margin (dB)	Remark
1	2387.560	12.75	32.80	45.55	54.00	-8.45	AVG
2	2390.000	14.87	32.81	47.68	54.00	-6.32	AVG

- Note:
1. Measurement = Reading Level + Correct Factor.
 2. If Peak Result complies with AV limit, AV Result is deemed to comply with AV limit.
 3. AVG: $VBW=1/Ton$ where: ton is transmit duration.
 4. For transmit duration, please refer to clause 8.1.
 5. Only the worst case emission was recorded, if it complies with the limit, the other emissions deemed to comply with the limit.



RESTRICTED BANDEDGE (HIGH CHANNEL, HORIZONTAL)

PEAK

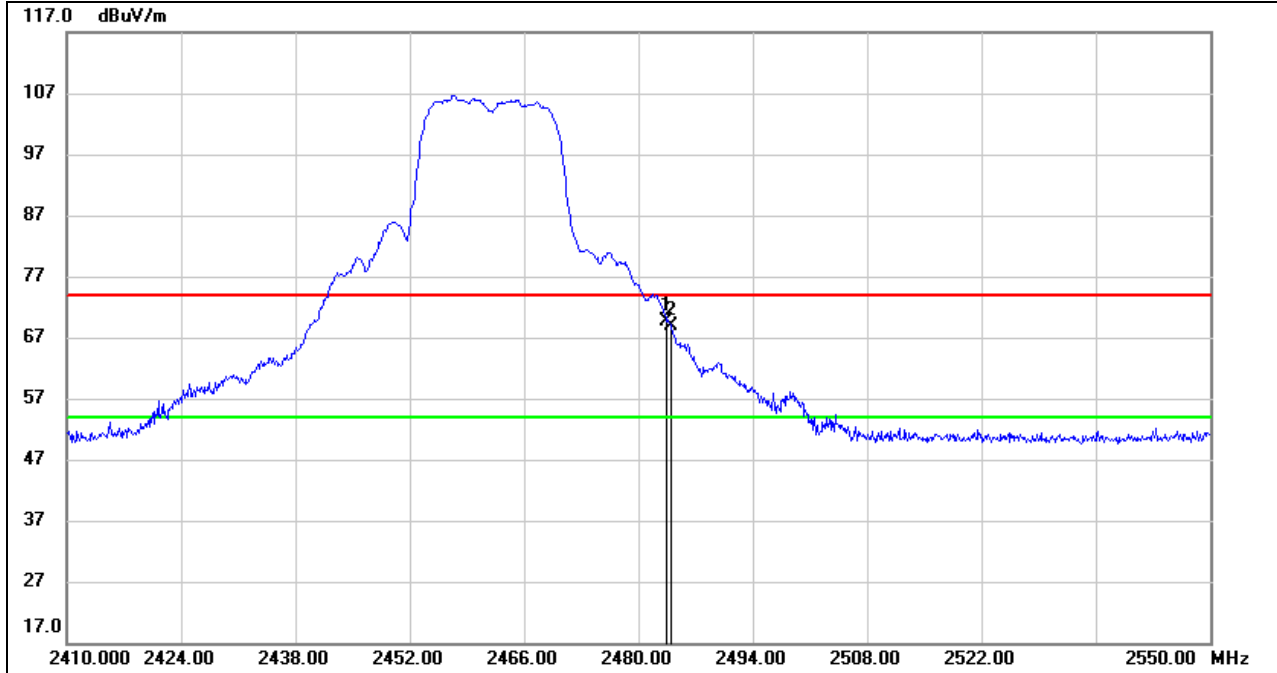

No.	Frequency (MHz)	Reading (dBuV)	Correct (dB/m)	Result (dBuV/m)	Limit (dBuV/m)	Margin (dB)	Remark
1	2483.500	36.52	33.09	69.61	74.00	-4.39	peak
2	2484.060	35.77	33.09	68.86	74.00	-5.14	peak

- Note: 1. Measurement = Reading Level + Correct Factor.
 2. If Peak Result complies with AV limit, AV Result is deemed to comply with AV limit.
 3. Peak: Peak detector.
 4. Only the worst case emission was recorded, if it complies with the limit, the other emissions deemed to comply with the limit.



AVG

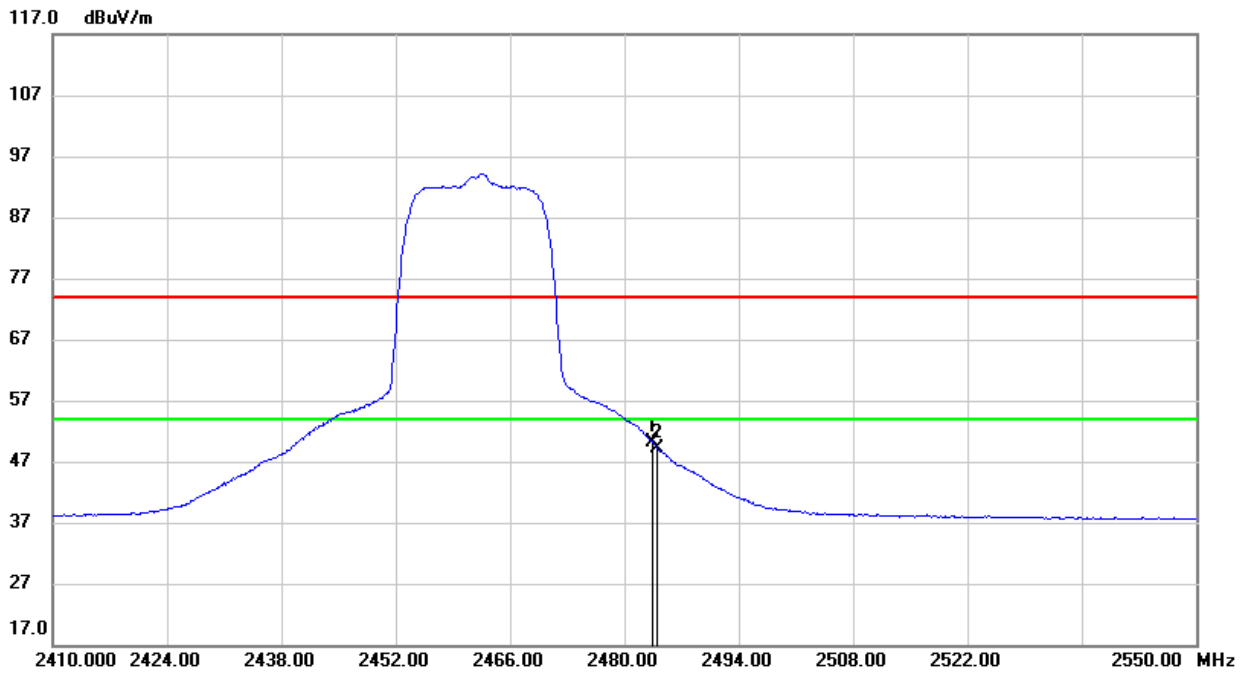

No.	Frequency (MHz)	Reading (dBuV)	Correct (dB/m)	Result (dBuV/m)	Limit (dBuV/m)	Margin (dB)	Remark
1	2483.500	17.01	33.09	50.10	54.00	-3.90	AVG
2	2484.060	16.01	33.09	49.10	54.00	-4.90	AVG

- Note:
1. Measurement = Reading Level + Correct Factor.
 2. If Peak Result complies with AV limit, AV Result is deemed to comply with AV limit.
 3. AVG: $VBW=1/Ton$ where: ton is transmit duration.
 4. For transmit duration, please refer to clause 8.1.
 5. Only the worst case emission was recorded, if it complies with the limit, the other emissions deemed to comply with the limit.



RESTRICTED BANDEDGE (HIGH CHANNEL, VERTICAL)

PEAK

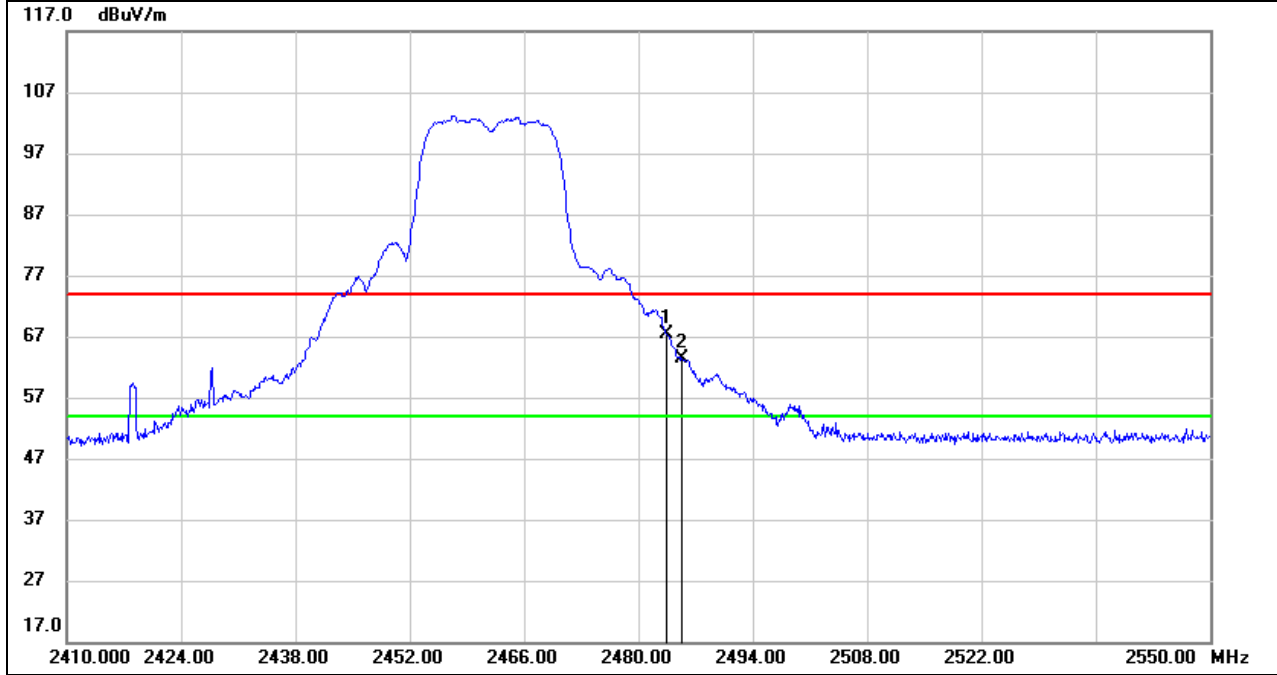

No.	Frequency (MHz)	Reading (dBuV)	Correct (dB/m)	Result (dBuV/m)	Limit (dBuV/m)	Margin (dB)	Remark
1	2483.500	34.24	33.09	67.33	74.00	-6.67	peak
2	2485.320	30.19	33.10	63.29	74.00	-10.71	peak

- Note: 1. Measurement = Reading Level + Correct Factor.
 2. If Peak Result complies with AV limit, AV Result is deemed to comply with AV limit.
 3. Peak: Peak detector.
 4. Only the worst case emission was recorded, if it complies with the limit, the other emissions deemed to comply with the limit.



AVG

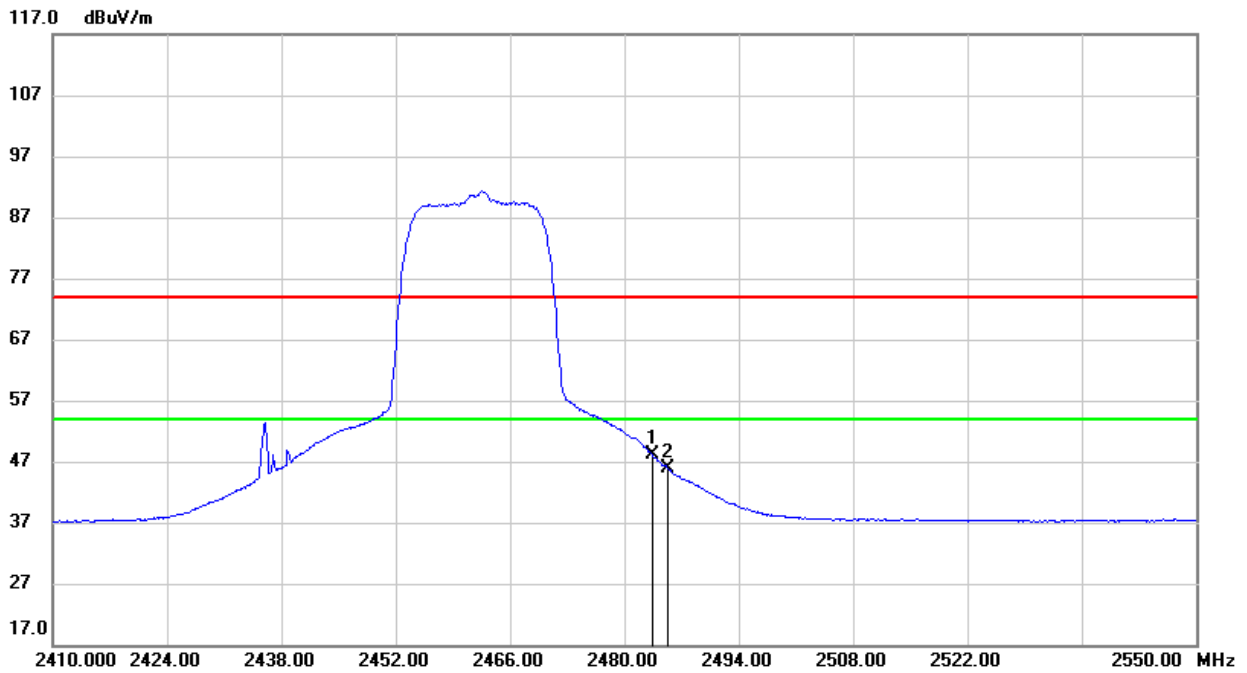

No.	Frequency (MHz)	Reading (dBuV)	Correct (dB/m)	Result (dBuV/m)	Limit (dBuV/m)	Margin (dB)	Remark
1	2483.500	14.95	33.09	48.04	54.00	-5.96	AVG
2	2485.320	12.70	33.10	45.80	54.00	-8.20	AVG

- Note:
1. Measurement = Reading Level + Correct Factor.
 2. If Peak Result complies with AV limit, AV Result is deemed to comply with AV limit.
 3. AVG: $VBW=1/Ton$ where: ton is transmit duration.
 4. For transmit duration, please refer to clause 8.1.
 5. Only the worst case emission was recorded, if it complies with the limit, the other emissions deemed to comply with the limit.



9.2. SPURIOUS EMISSIONS (3~18GHz)

9.2.1. 802.11b MODE

HARMONICS AND SPURIOUS EMISSIONS (LOW CHANNEL, HORIZONTAL)

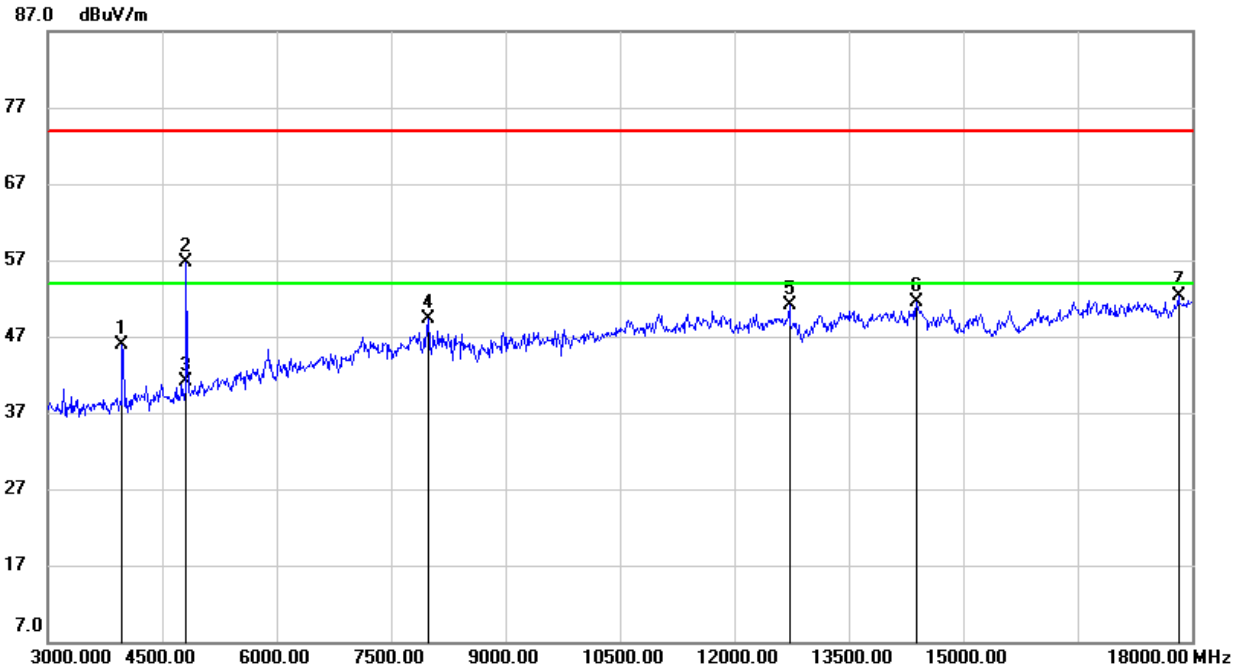

No.	Frequency (MHz)	Reading (dBuV)	Correct (dB/m)	Result (dBuV)	Limit (dBuV)	Margin (dB)	Remark
1	3975.000	48.94	-2.98	45.96	74.00	-28.04	peak
2	4815.000	56.88	-0.23	56.65	74.00	-17.35	peak
3	4815.000	41.28	-0.23	41.05	54.00	-12.95	AVG
4	7995.000	41.15	8.16	49.31	74.00	-24.69	peak
5	12720.000	36.65	14.54	51.19	74.00	-22.81	peak
6	14385.000	35.00	16.41	51.41	74.00	-22.59	peak
7	17820.000	29.03	23.21	52.24	74.00	-21.76	peak

- Note: 1. Peak Result = Reading Level + Correct Factor.
 2. If Peak Result complies with AV limit, AV Result is deemed to comply with AV limit.
 3. Peak: Peak detector.
 4. AVG: $VBW=1/Ton$ where: ton is transmit duration.
 5. For transmit duration, please refer to clause 8.1.
 6. Filter losses were only considered in then spurious frequency bands and the authorized band was not corrected for BRF losses.
 7. Proper operation of the transmitter prior to adding the filter to the measurement chain.



HARMONICS AND SPURIOUS EMISSIONS (LOW CHANNEL, VERTICAL)

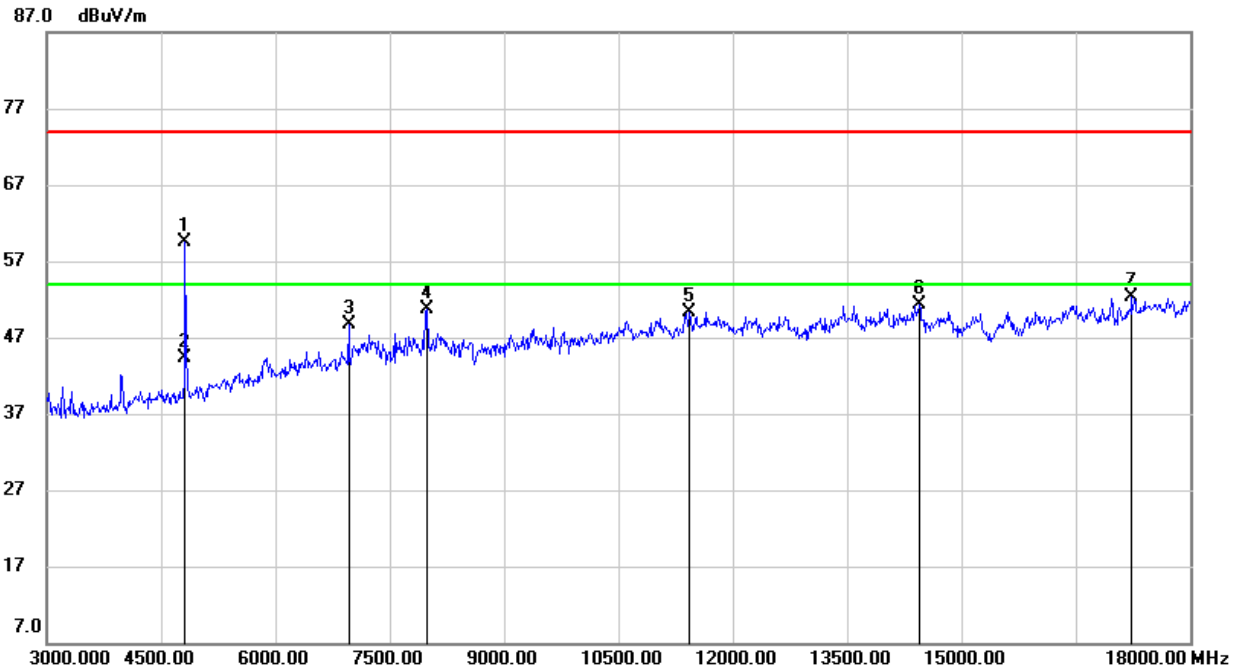

No.	Frequency (MHz)	Reading (dBuV)	Correct (dB/m)	Result (dBuV)	Limit (dBuV)	Margin (dB)	Remark
1	4815.000	59.73	-0.23	59.50	74.00	-14.50	peak
2	4815.000	44.48	-0.23	44.25	54.00	-9.75	AVG
3	6960.000	42.02	6.68	48.70	74.00	-25.30	peak
4	7980.000	42.56	8.20	50.76	74.00	-23.24	peak
5	11430.000	36.70	13.57	50.27	74.00	-23.73	peak
6	14445.000	34.97	16.37	51.34	74.00	-22.66	peak
7	17235.000	30.99	21.32	52.31	74.00	-21.69	peak

- Note: 1. Peak Result = Reading Level + Correct Factor.
 2. If Peak Result complies with AV limit, AV Result is deemed to comply with AV limit.
 3. Peak: Peak detector.
 4. AVG: $VBW=1/T_{on}$ where: t_{on} is transmit duration.
 5. For transmit duration, please refer to clause 8.1.
 6. Filter losses were only considered in then spurious frequency bands and the authorized band was not corrected for BRF losses.
 7. Proper operation of the transmitter prior to adding the filter to the measurement chain.



HARMONICS AND SPURIOUS EMISSIONS (MID CHANNEL, HORIZONTAL)

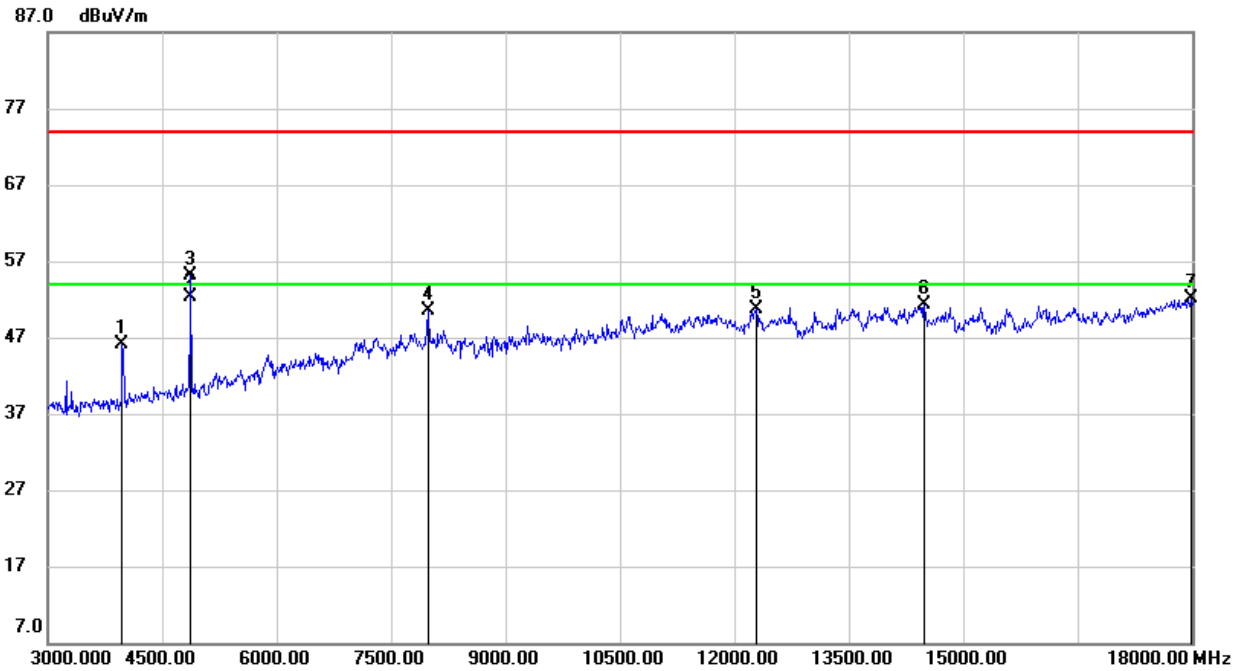

No.	Frequency (MHz)	Reading (dBuV)	Correct (dB/m)	Result (dBuV)	Limit (dBuV)	Margin (dB)	Remark
1	3975.000	49.00	-2.98	46.02	74.00	-27.98	peak
2	4874.021	52.43	-0.13	52.30	54.00	-1.70	AVG
3	4875.000	55.13	-0.12	55.01	74.00	-18.99	peak
4	7980.000	42.22	8.20	50.42	74.00	-23.58	peak
5	12285.000	36.30	14.37	50.67	74.00	-23.33	peak
6	14490.000	35.07	16.32	51.39	74.00	-22.61	peak
7	17985.000	28.83	23.25	52.08	74.00	-21.92	peak

- Note: 1. Peak Result = Reading Level + Correct Factor.
 2. If Peak Result complies with AV limit, AV Result is deemed to comply with AV limit.
 3. Peak: Peak detector.
 4. AVG: $VBW=1/Ton$ where: ton is transmit duration.
 5. For transmit duration, please refer to clause 8.1.
 6. Filter losses were only considered in then spurious frequency bands and the authorized band was not corrected for BRF losses.
 7. Proper operation of the transmitter prior to adding the filter to the measurement chain.



HARMONICS AND SPURIOUS EMISSIONS (MID CHANNEL, VERTICAL)

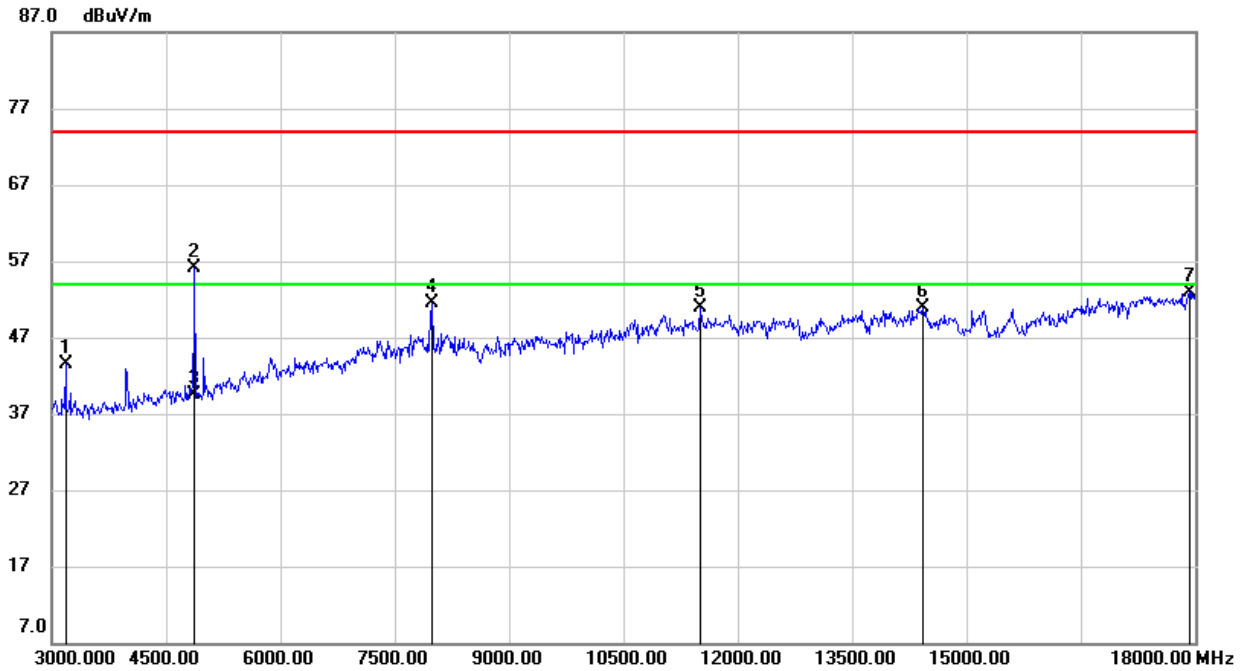

No.	Frequency (MHz)	Reading (dBuV)	Correct (dB/m)	Result (dBuV)	Limit (dBuV)	Margin (dB)	Remark
1	3180.000	48.01	-4.44	43.57	74.00	-30.43	peak
2	4875.000	56.15	-0.12	56.03	74.00	-17.97	peak
3	4875.000	39.71	-0.12	39.59	54.00	-14.41	AVG
4	7995.000	43.31	8.16	51.47	74.00	-22.53	peak
5	11505.000	36.86	14.09	50.95	74.00	-23.05	peak
6	14430.000	34.50	16.39	50.89	74.00	-23.11	peak
7	17925.000	29.76	23.18	52.94	74.00	-21.06	peak

- Note: 1. Peak Result = Reading Level + Correct Factor.
 2. If Peak Result complies with AV limit, AV Result is deemed to comply with AV limit.
 3. Peak: Peak detector.
 4. AVG: $VBW=1/Ton$ where: ton is transmit duration.
 5. For transmit duration, please refer to clause 8.1.
 6. Filter losses were only considered in then spurious frequency bands and the authorized band was not corrected for BRF losses.
 7. Proper operation of the transmitter prior to adding the filter to the measurement chain.



HARMONICS AND SPURIOUS EMISSIONS (HIGH CHANNEL, HORIZONTAL)

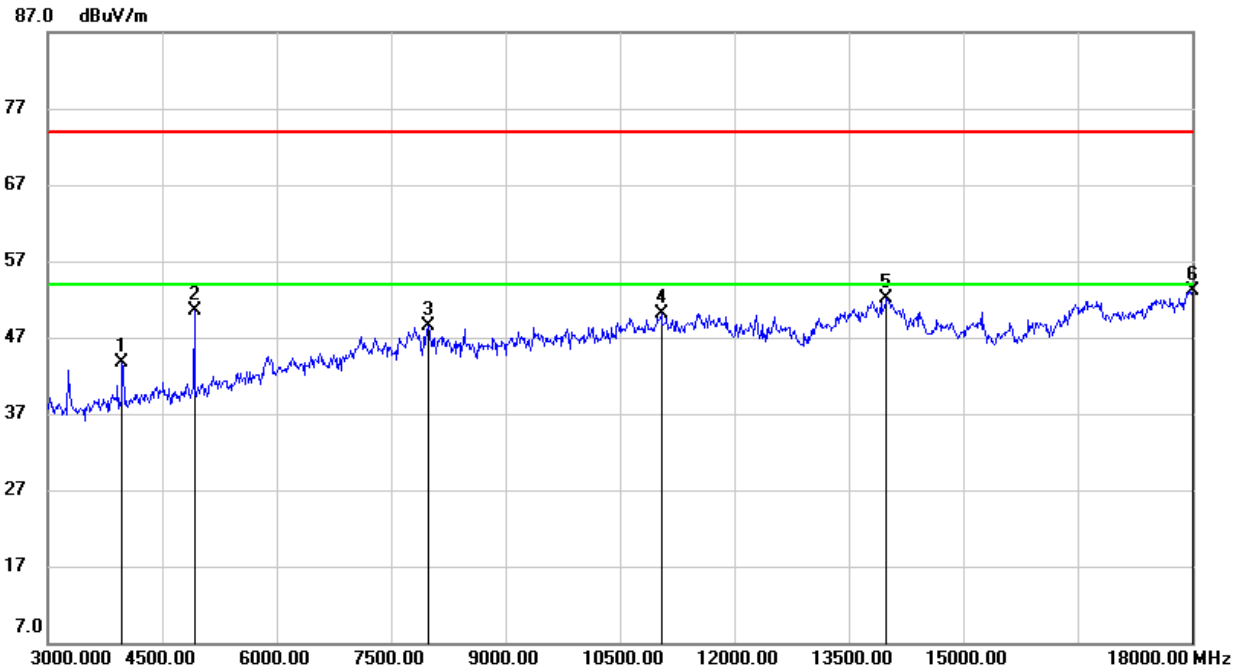

No.	Frequency (MHz)	Reading (dBuV)	Correct (dB/m)	Result (dBuV)	Limit (dBuV)	Margin (dB)	Remark
1	3975.000	46.20	-2.57	43.63	74.00	-30.37	peak
2	4920.000	50.11	0.34	50.45	74.00	-23.55	peak
3	7995.000	39.70	8.72	48.42	74.00	-25.58	peak
4	11040.000	36.51	13.58	50.09	74.00	-23.91	peak
5	13995.000	33.92	18.14	52.06	74.00	-21.94	peak
6	18000.000	28.63	24.44	53.07	74.00	-20.93	peak

- Note: 1. Peak Result = Reading Level + Correct Factor.
 2. If Peak Result complies with AV limit, AV Result is deemed to comply with AV limit.
 3. Peak: Peak detector.
 4. Filter losses were only considered in then spurious frequency bands and the authorized band was not corrected for BRF losses.
 5. Proper operation of the transmitter prior to adding the filter to the measurement chain.



HARMONICS AND SPURIOUS EMISSIONS (HIGH CHANNEL, VERTICAL)

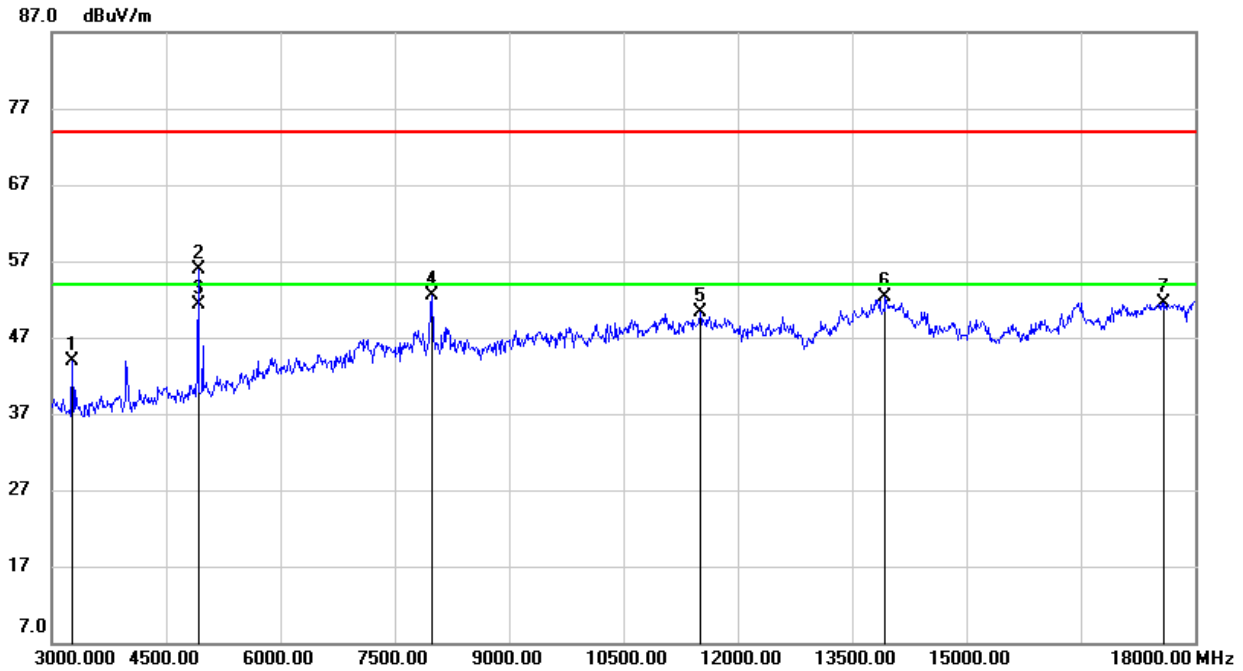

No.	Frequency (MHz)	Reading (dBuV)	Correct (dB/m)	Result (dBuV)	Limit (dBuV)	Margin (dB)	Remark
1	3270.000	47.89	-3.91	43.98	74.00	-30.02	peak
2	4920.000	55.57	0.34	55.91	74.00	-18.09	peak
3	4920.000	51.01	0.34	51.35	54.00	-2.65	AVG
4	7995.000	43.83	8.72	52.55	74.00	-21.45	peak
5	11505.000	36.03	14.36	50.39	74.00	-23.61	peak
6	13935.000	34.55	17.68	52.23	74.00	-21.77	peak
7	17595.000	28.14	23.45	51.59	74.00	-22.41	peak

- Note: 1. Peak Result = Reading Level + Correct Factor.
 2. If Peak Result complies with AV limit, AV Result is deemed to comply with AV limit.
 3. Peak: Peak detector.
 4. AVG: $VBW=1/Ton$ where: ton is transmit duration.
 5. For transmit duration, please refer to clause 8.1.
 6. Filter losses were only considered in then spurious frequency bands and the authorized band was not corrected for BRF losses.
 7. Proper operation of the transmitter prior to adding the filter to the measurement chain.



9.2.2. 802.11g MODE

HARMONICS AND SPURIOUS EMISSIONS (LOW CHANNEL, HORIZONTAL)

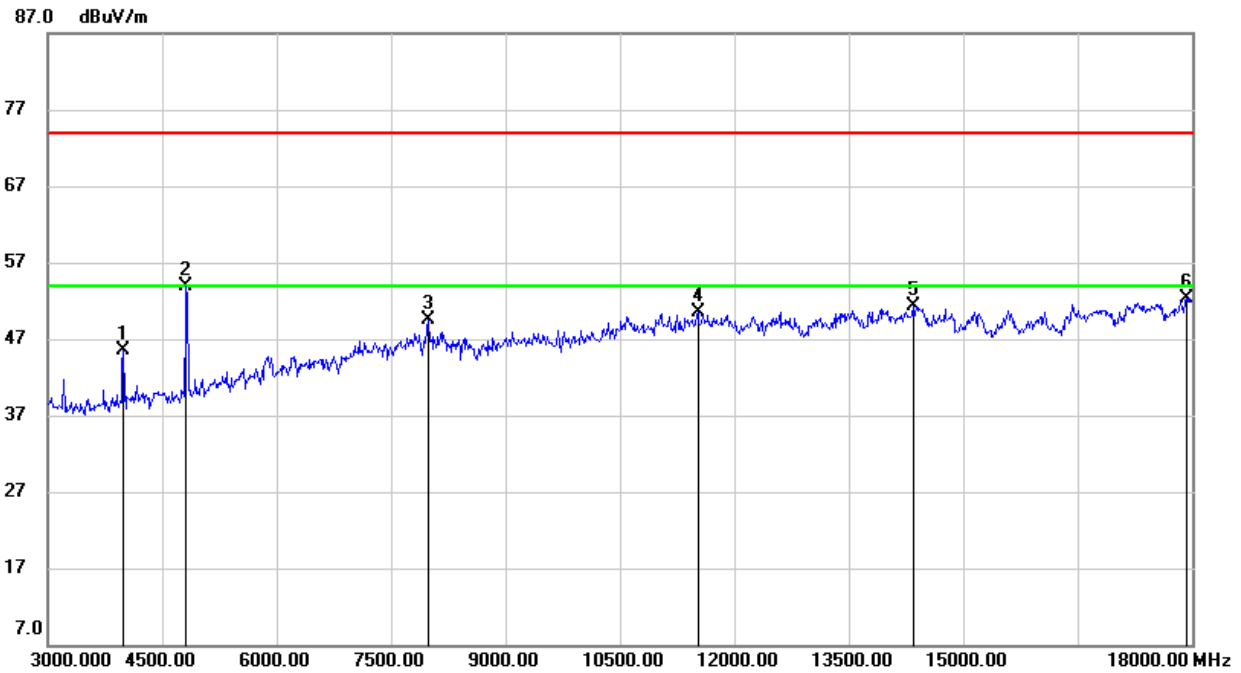

No.	Frequency (MHz)	Reading (dBuV)	Correct (dB/m)	Result (dBuV)	Limit (dBuV)	Margin (dB)	Remark
1	3990.000	48.50	-2.95	45.55	74.00	-28.45	peak
2	4815.000	54.19	-0.23	53.96	74.00	-20.04	peak
3	7980.000	41.29	8.20	49.49	74.00	-24.51	peak
4	11520.000	36.38	14.10	50.48	74.00	-23.52	peak
5	14340.000	35.00	16.36	51.36	74.00	-22.64	peak
6	17925.000	29.09	23.18	52.27	74.00	-21.73	peak

- Note: 1. Measurement = Reading Level + Correct Factor.
 2. If Peak Result complies with AV limit, AV Result is deemed to comply with AV limit.
 3. Peak: Peak detector.
 4. Filter losses were only considered in then spurious frequency bands and the authorized band was not corrected for BRF losses.
 5. Proper operation of the transmitter prior to adding the filter to the measurement chain.



HARMONICS AND SPURIOUS EMISSIONS (LOW CHANNEL, VERTICAL)

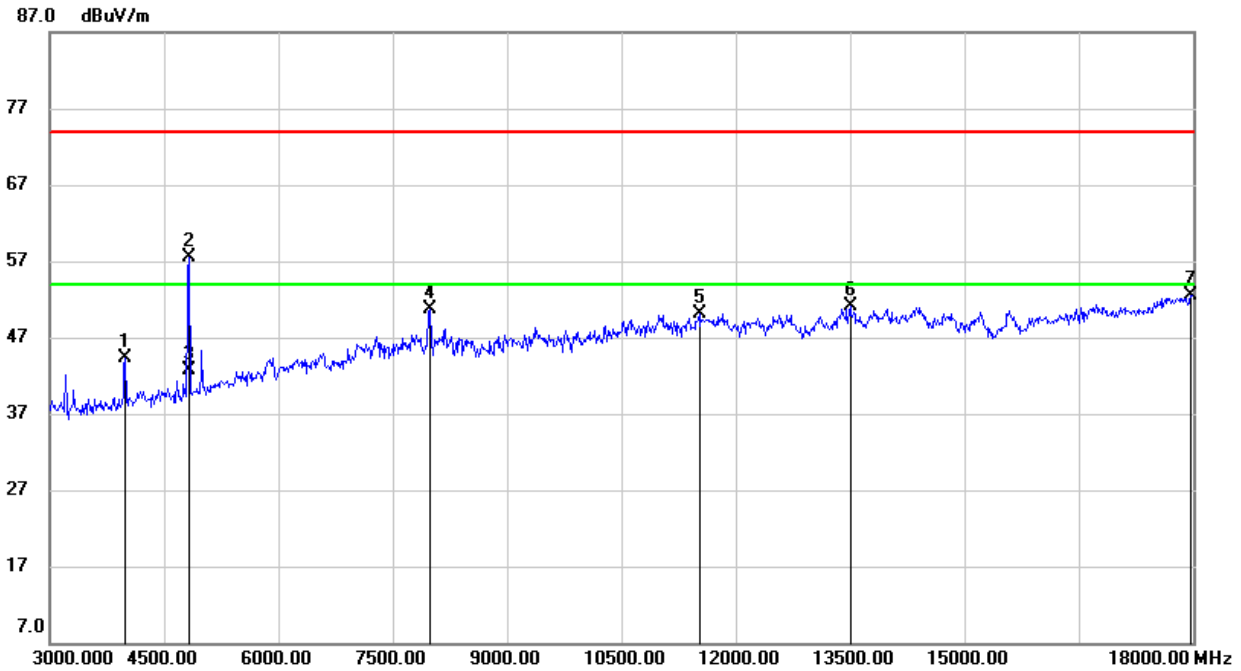

No.	Frequency (MHz)	Reading (dBuV)	Correct (dB/m)	Result (dBuV)	Limit (dBuV)	Margin (dB)	Remark
1	3990.000	47.29	-2.95	44.34	74.00	-29.66	peak
2	4830.000	57.72	-0.20	57.52	74.00	-16.48	peak
3	4830.000	42.93	-0.20	42.73	54.00	-11.27	AVG
4	7995.000	42.53	8.16	50.69	74.00	-23.31	peak
5	11520.000	36.08	14.10	50.18	74.00	-23.82	peak
6	13500.000	35.40	15.66	51.06	74.00	-22.94	peak
7	17970.000	29.28	23.24	52.52	74.00	-21.48	peak

- Note: 1. Peak Result = Reading Level + Correct Factor.
 2. If Peak Result complies with AV limit, AV Result is deemed to comply with AV limit.
 3. Peak: Peak detector.
 4. AVG: $VBW=1/T_{on}$ where: t_{on} is transmit duration.
 5. For transmit duration, please refer to clause 8.1.
 6. Filter losses were only considered in then spurious frequency bands and the authorized band was not corrected for BRF losses.
 7. Proper operation of the transmitter prior to adding the filter to the measurement chain.



HARMONICS AND SPURIOUS EMISSIONS (MID CHANNEL, HORIZONTAL)

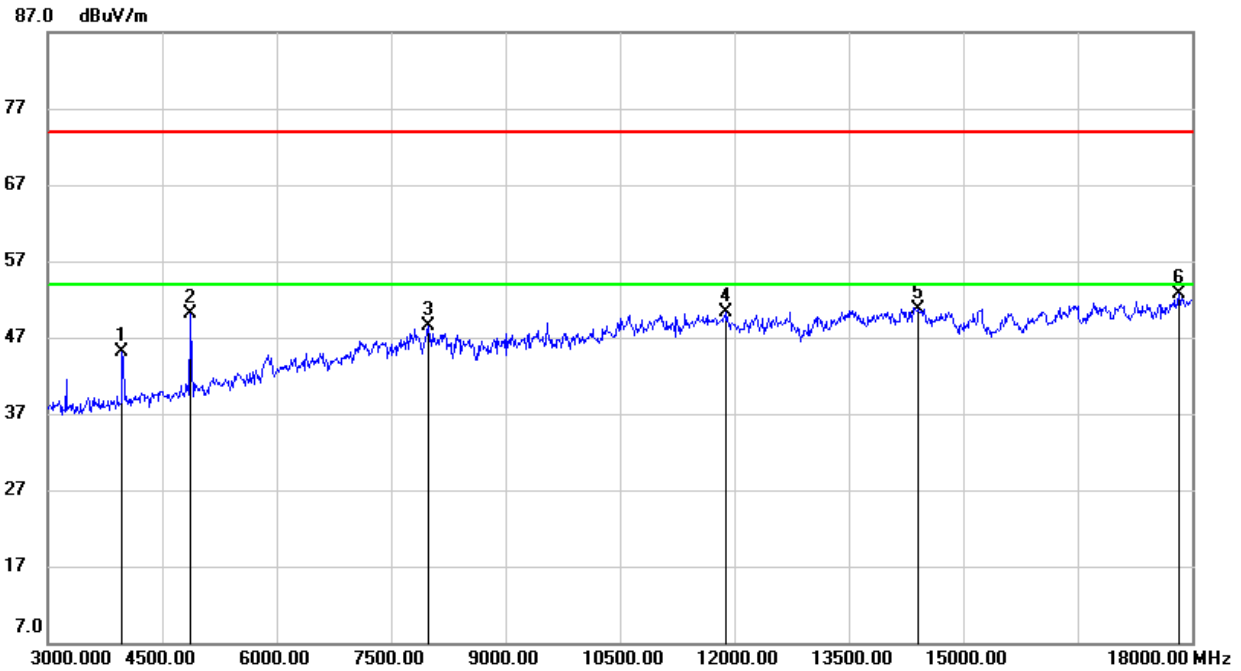

No.	Frequency (MHz)	Reading (dBuV)	Correct (dB/m)	Result (dBuV)	Limit (dBuV)	Margin (dB)	Remark
1	3975.000	48.10	-2.98	45.12	74.00	-28.88	peak
2	4875.000	50.25	-0.12	50.13	74.00	-23.87	peak
3	7995.000	40.44	8.16	48.60	74.00	-25.40	peak
4	11895.000	36.25	14.05	50.30	74.00	-23.70	peak
5	14400.000	34.34	16.43	50.77	74.00	-23.23	peak
6	17820.000	29.53	23.21	52.74	74.00	-21.26	peak

- Note: 1. Measurement = Reading Level + Correct Factor.
 2. If Peak Result complies with AV limit, AV Result is deemed to comply with AV limit.
 3. Peak: Peak detector.
 4. Filter losses were only considered in then spurious frequency bands and the authorized band was not corrected for BRF losses.
 5. Proper operation of the transmitter prior to adding the filter to the measurement chain.



HARMONICS AND SPURIOUS EMISSIONS (MID CHANNEL, VERTICAL)

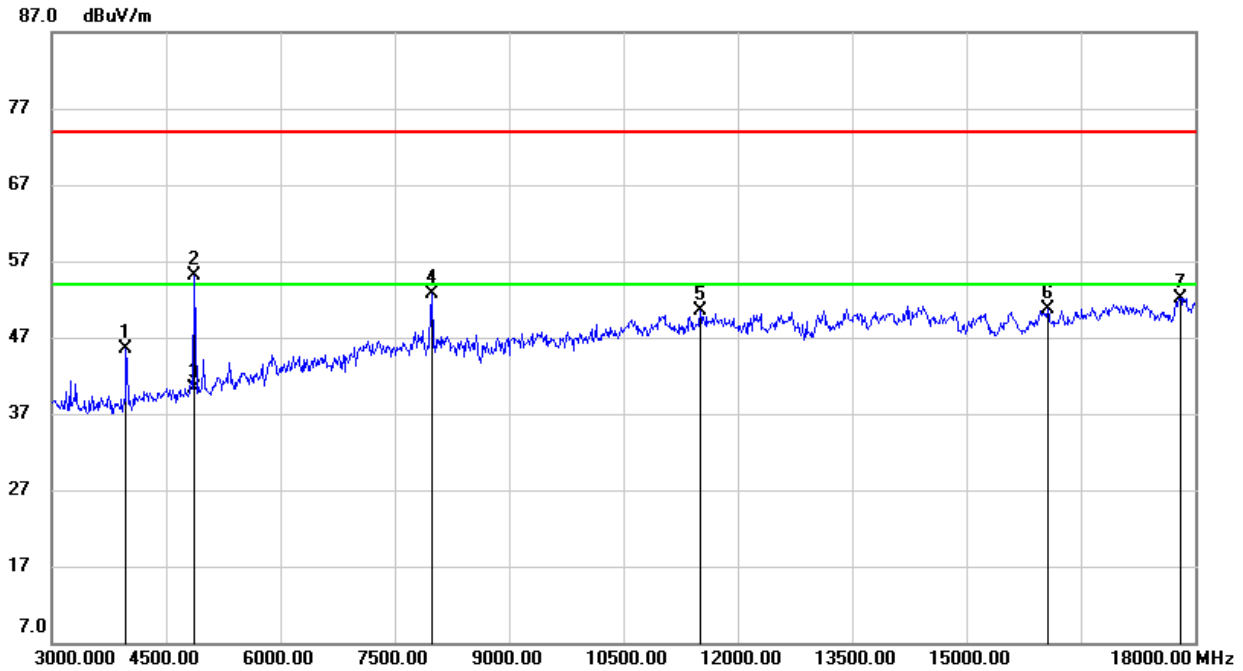

No.	Frequency (MHz)	Reading (dBuV)	Correct (dB/m)	Result (dBuV)	Limit (dBuV)	Margin (dB)	Remark
1	3975.000	48.47	-2.98	45.49	74.00	-28.51	peak
2	4875.000	55.27	-0.12	55.15	74.00	-18.85	peak
3	4875.000	40.34	-0.12	40.22	54.00	-13.78	AVG
4	7995.000	44.55	8.16	52.71	74.00	-21.29	peak
5	11505.000	36.46	14.09	50.55	74.00	-23.45	peak
6	16065.000	33.27	17.51	50.78	74.00	-23.22	peak
7	17805.000	28.98	23.22	52.20	74.00	-21.80	peak

- Note: 1. Peak Result = Reading Level + Correct Factor.
 2. If Peak Result complies with AV limit, AV Result is deemed to comply with AV limit.
 3. Peak: Peak detector.
 4. AVG: $VBW=1/Ton$ where: ton is transmit duration.
 5. For transmit duration, please refer to clause 8.1.
 6. Filter losses were only considered in then spurious frequency bands and the authorized band was not corrected for BRF losses.
 7. Proper operation of the transmitter prior to adding the filter to the measurement chain.



HARMONICS AND SPURIOUS EMISSIONS (HIGH CHANNEL, HORIZONTAL)

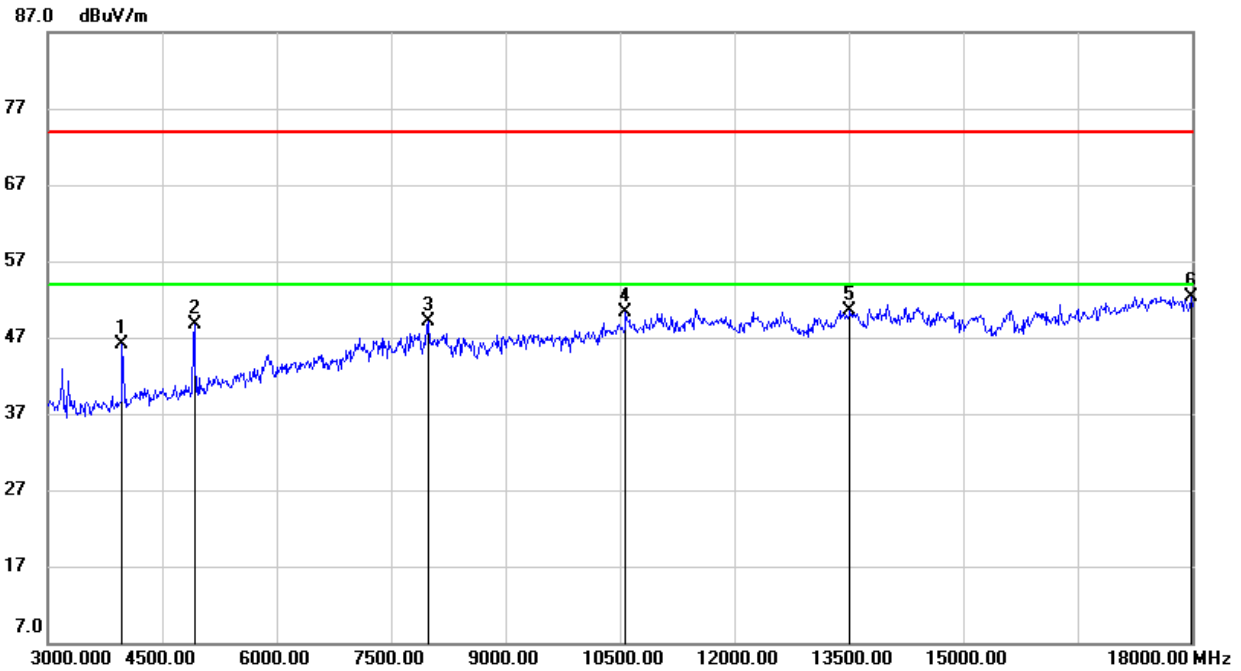

No.	Frequency (MHz)	Reading (dBuV)	Correct (dB/m)	Result (dBuV)	Limit (dBuV)	Margin (dB)	Remark
1	3975.000	49.16	-2.98	46.18	74.00	-27.82	peak
2	4920.000	48.75	0.02	48.77	74.00	-25.23	peak
3	7995.000	40.98	8.16	49.14	74.00	-24.86	peak
4	10575.000	37.83	12.52	50.35	74.00	-23.65	peak
5	13515.000	34.82	15.72	50.54	74.00	-23.46	peak
6	17985.000	29.14	23.25	52.39	74.00	-21.61	peak

- Note: 1. Measurement = Reading Level + Correct Factor.
 2. If Peak Result complies with AV limit, AV Result is deemed to comply with AV limit.
 3. Peak: Peak detector.
 4. Filter losses were only considered in then spurious frequency bands and the authorized band was not corrected for BRF losses.
 5. Proper operation of the transmitter prior to adding the filter to the measurement chain.



HARMONICS AND SPURIOUS EMISSIONS (HIGH CHANNEL, VERTICAL)

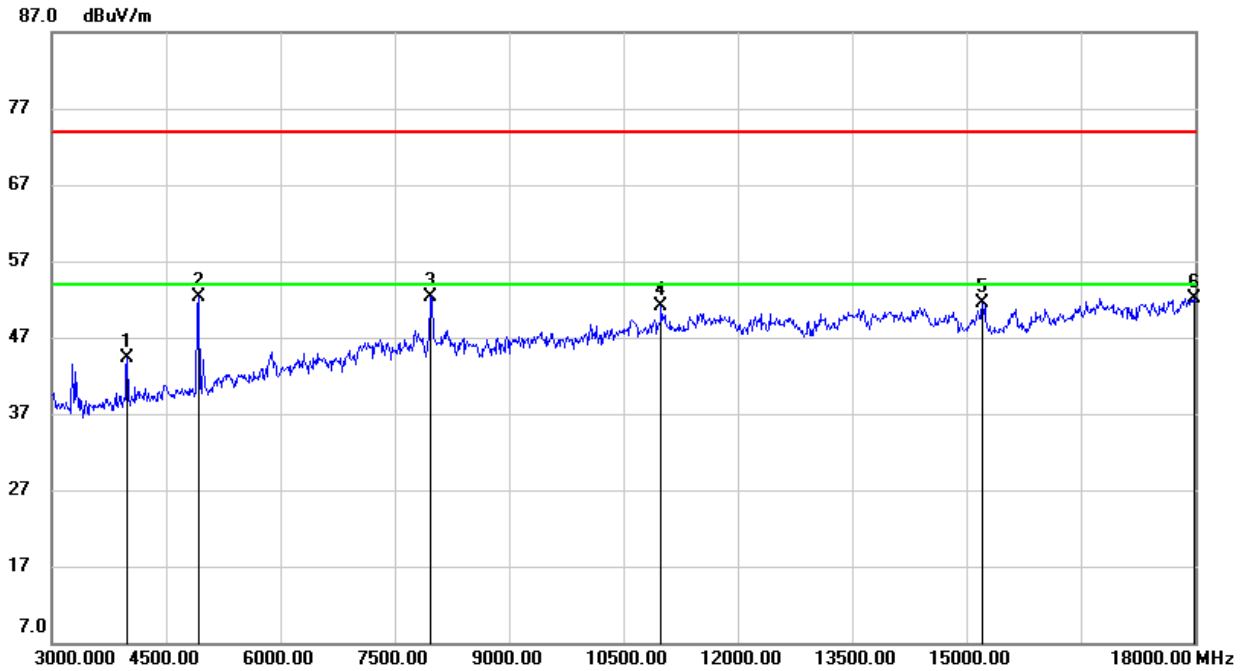

No.	Frequency (MHz)	Reading (dBuV)	Correct (dB/m)	Result (dBuV)	Limit (dBuV)	Margin (dB)	Remark
1	3990.000	47.19	-2.95	44.24	74.00	-29.76	peak
2	4920.000	52.25	0.02	52.27	74.00	-21.73	peak
3	7965.000	44.10	8.26	52.36	74.00	-21.64	peak
4	10995.000	37.86	13.23	51.09	74.00	-22.91	peak
5	15210.000	35.86	15.55	51.41	74.00	-22.59	peak
6	17985.000	28.90	23.25	52.15	74.00	-21.85	peak

- Note: 1. Measurement = Reading Level + Correct Factor.
 2. If Peak Result complies with AV limit, AV Result is deemed to comply with AV limit.
 3. Peak: Peak detector.
 4. Filter losses were only considered in then spurious frequency bands and the authorized band was not corrected for BRF losses.
 5. Proper operation of the transmitter prior to adding the filter to the measurement chain.



9.2.3. 802.11n HT20 MODE

HARMONICS AND SPURIOUS EMISSIONS (LOW CHANNEL, HORIZONTAL)

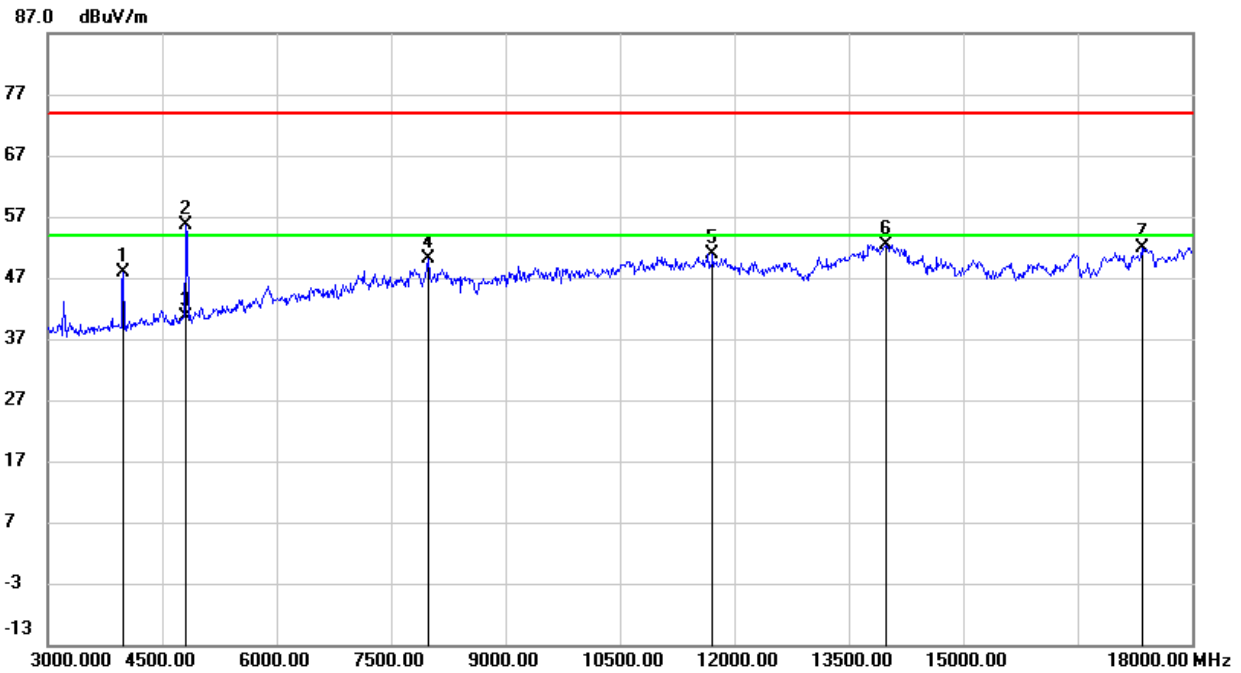

No.	Frequency (MHz)	Reading (dBuV)	Correct (dB/m)	Result (dBuV)	Limit (dBuV)	Margin (dB)	Remark
1	3990.000	50.43	-2.59	47.84	74.00	-26.16	peak
2	4815.000	55.53	0.03	55.56	74.00	-18.44	peak
3	4815.000	40.59	0.03	40.62	54.00	-13.38	AVG
4	7995.000	41.40	8.72	50.12	74.00	-23.88	peak
5	11715.000	37.10	13.72	50.82	74.00	-23.18	peak
6	13995.000	34.35	18.14	52.49	74.00	-21.51	peak
7	17340.000	28.64	23.31	51.95	74.00	-22.05	peak

- Note:
1. Peak Result = Reading Level + Correct Factor.
 2. If Peak Result complies with AV limit, AV Result is deemed to comply with AV limit.
 3. Peak: Peak detector.
 4. AVG: $VBW=1/Ton$ where: ton is transmit duration.
 5. For transmit duration, please refer to clause 8.1.
 6. Filter losses were only considered in then spurious frequency bands and the authorized band was not corrected for BRF losses.
 7. Proper operation of the transmitter prior to adding the filter to the measurement chain.



HARMONICS AND SPURIOUS EMISSIONS (LOW CHANNEL, VERTICAL)

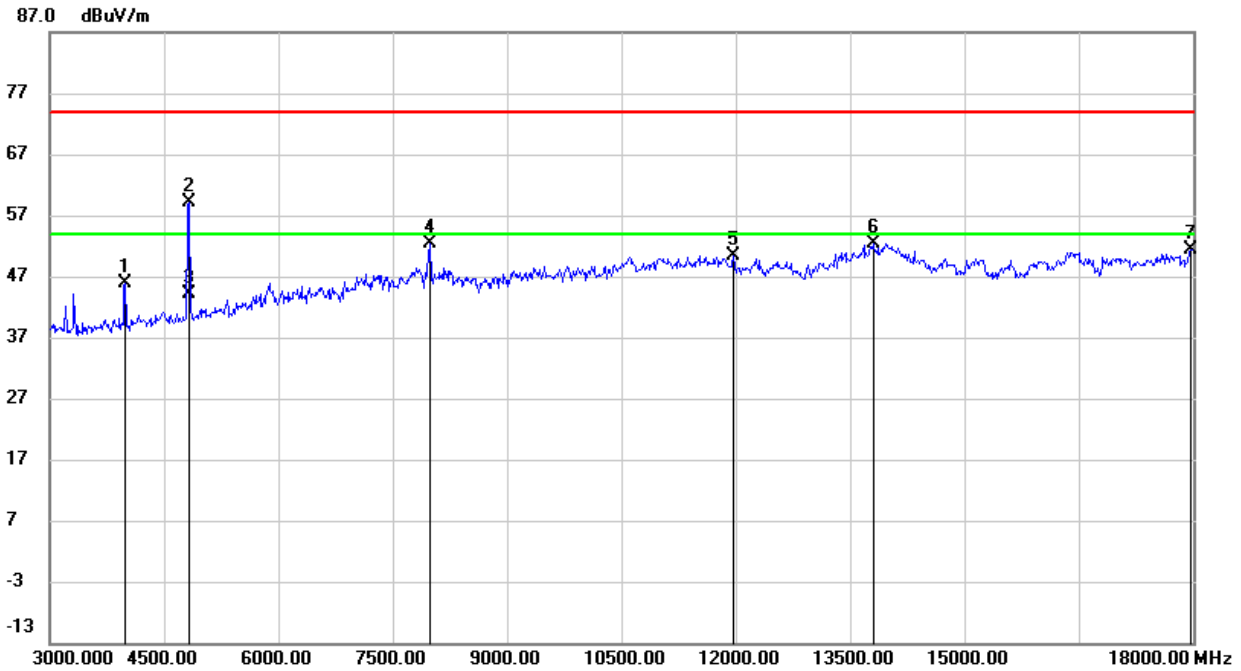

No.	Frequency (MHz)	Reading (dBuV)	Correct (dB/m)	Result (dBuV)	Limit (dBuV)	Margin (dB)	Remark
1	3990.000	48.51	-2.59	45.92	74.00	-28.08	peak
2	4830.000	59.18	0.07	59.25	74.00	-14.75	peak
3	4830.000	43.94	0.07	44.01	54.00	-9.99	AVG
4	7995.000	43.73	8.72	52.45	74.00	-21.55	peak
5	11970.000	36.37	14.09	50.46	74.00	-23.54	peak
6	13800.000	33.31	19.04	52.35	74.00	-21.65	peak
7	17970.000	27.11	24.26	51.37	74.00	-22.63	peak

- Note: 1. Peak Result = Reading Level + Correct Factor.
 2. If Peak Result complies with AV limit, AV Result is deemed to comply with AV limit.
 3. Peak: Peak detector.
 4. AVG: $VBW=1/Ton$ where: ton is transmit duration.
 5. For transmit duration, please refer to clause 8.1.
 6. Filter losses were only considered in then spurious frequency bands and the authorized band was not corrected for BRF losses.
 7. Proper operation of the transmitter prior to adding the filter to the measurement chain.



HARMONICS AND SPURIOUS EMISSIONS (MID CHANNEL, HORIZONTAL)

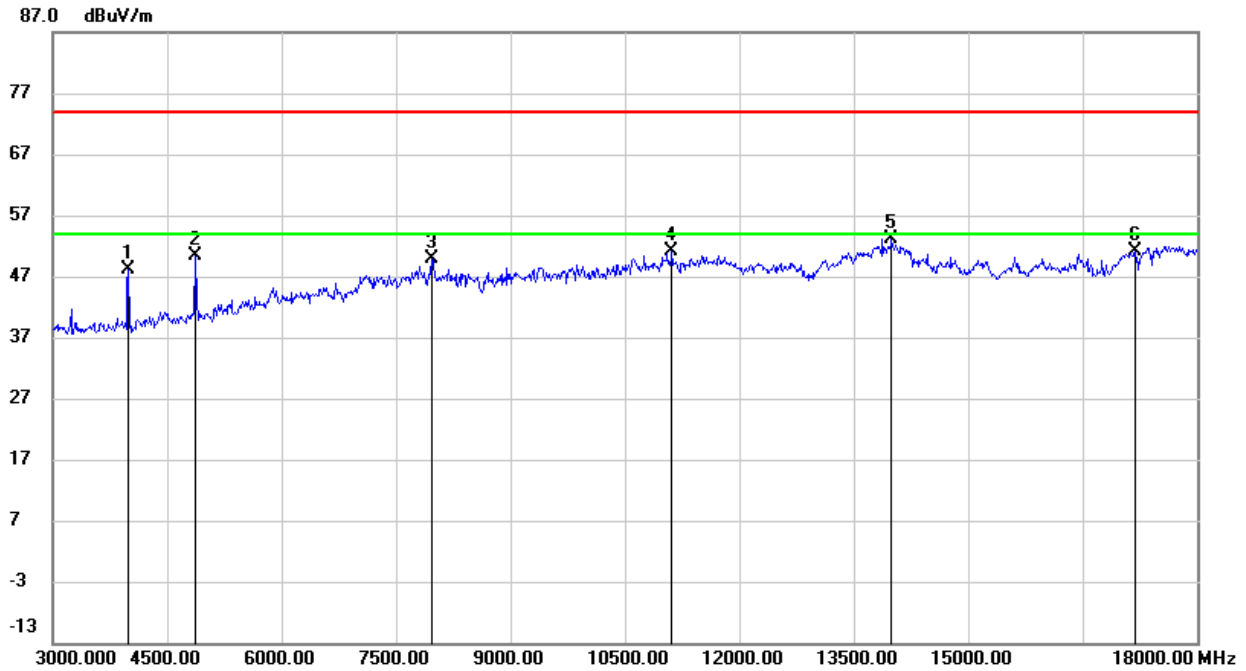

No.	Frequency (MHz)	Reading (dBuV)	Correct (dB/m)	Result (dBuV)	Limit (dBuV)	Margin (dB)	Remark
1	3990.000	50.79	-2.59	48.20	74.00	-25.80	peak
2	4875.000	50.27	0.17	50.44	74.00	-23.56	peak
3	7965.000	41.04	8.84	49.88	74.00	-24.12	peak
4	11115.000	37.57	13.65	51.22	74.00	-22.78	peak
5	13995.000	34.98	18.14	53.12	74.00	-20.88	peak
6	17190.000	27.95	23.09	51.04	74.00	-22.96	peak

- Note: 1. Measurement = Reading Level + Correct Factor.
 2. If Peak Result complies with AV limit, AV Result is deemed to comply with AV limit.
 3. Peak: Peak detector.
 4. Filter losses were only considered in then spurious frequency bands and the authorized band was not corrected for BRF losses.
 5. Proper operation of the transmitter prior to adding the filter to the measurement chain.



HARMONICS AND SPURIOUS EMISSIONS (MID CHANNEL, VERTICAL)

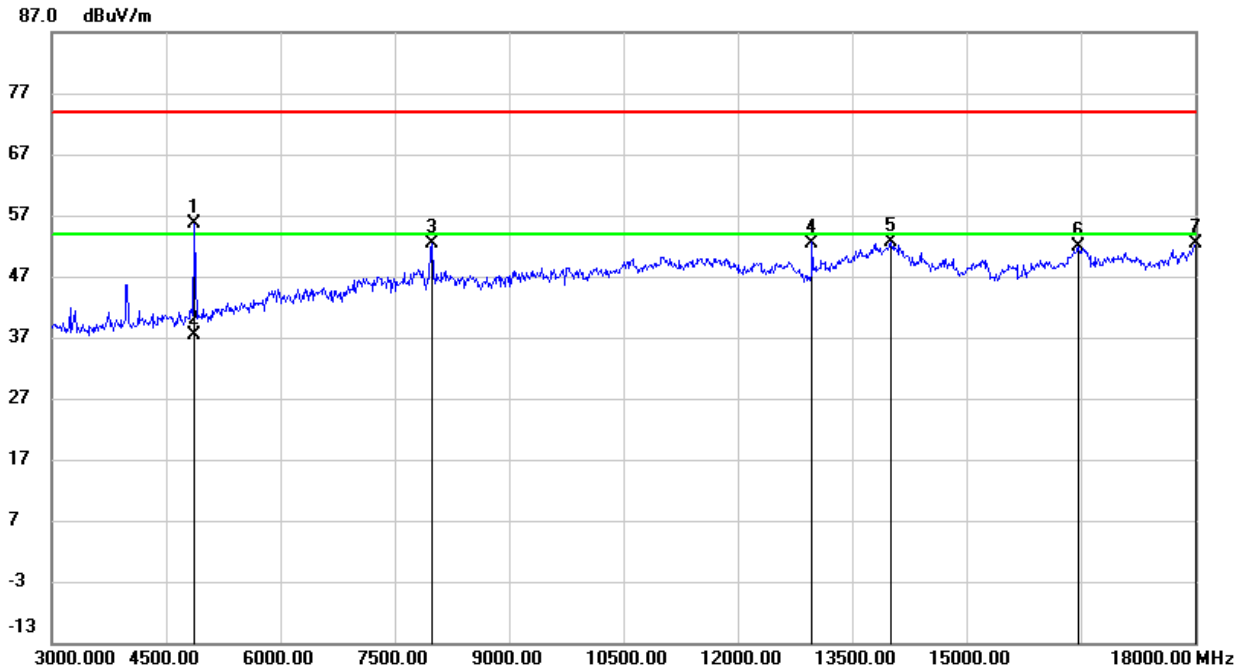

No.	Frequency (MHz)	Reading (dBuV)	Correct (dB/m)	Result (dBuV)	Limit (dBuV)	Margin (dB)	Remark
1	4875.000	55.41	0.17	55.58	74.00	-18.42	peak
2	4875.000	37.24	0.17	37.41	54.00	-16.59	AVG
3	7995.000	43.64	8.72	52.36	74.00	-21.64	peak
4	12975.000	38.40	14.10	52.50	74.00	-21.50	peak
5	14010.000	34.55	18.18	52.73	74.00	-21.27	peak
6	16470.000	32.86	19.06	51.92	74.00	-22.08	peak
7	18000.000	27.97	24.44	52.41	74.00	-21.59	peak

- Note: 1. Peak Result = Reading Level + Correct Factor.
 2. If Peak Result complies with AV limit, AV Result is deemed to comply with AV limit.
 3. Peak: Peak detector.
 4. AVG: $VBW=1/Ton$ where: ton is transmit duration.
 5. For transmit duration, please refer to clause 8.1.
 6. Filter losses were only considered in then spurious frequency bands and the authorized band was not corrected for BRF losses.
 7. Proper operation of the transmitter prior to adding the filter to the measurement chain.



HARMONICS AND SPURIOUS EMISSIONS (HIGH CHANNEL, HORIZONTAL)

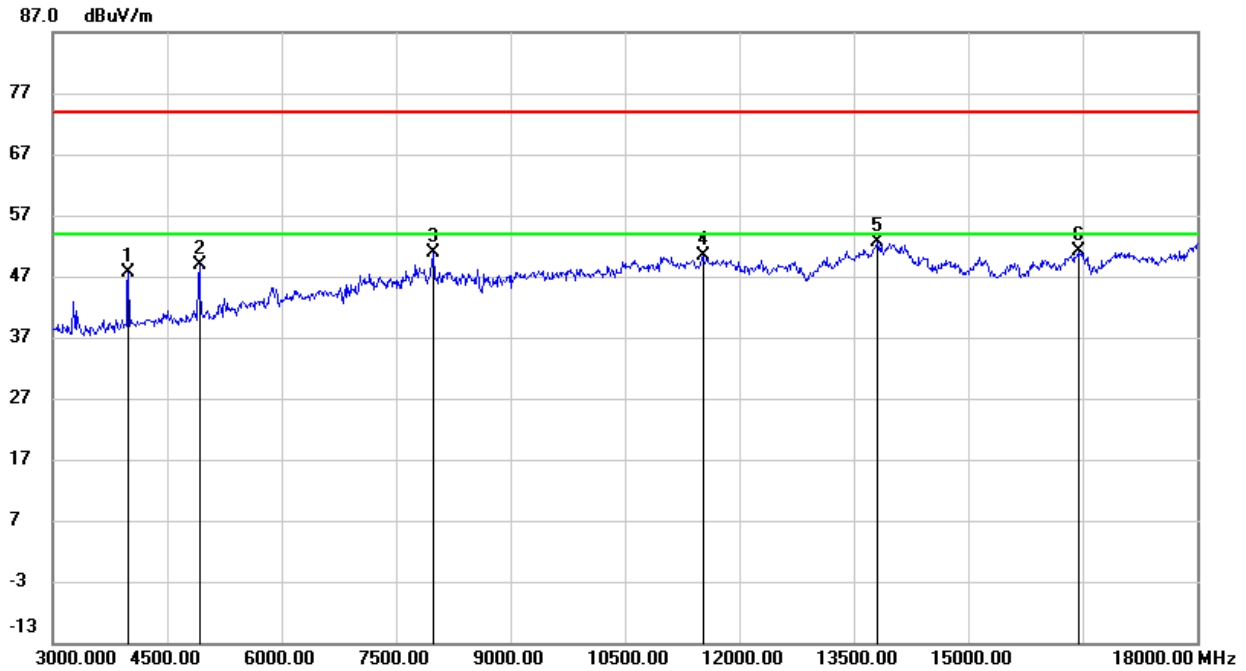

No.	Frequency (MHz)	Reading (dBuV)	Correct (dB/m)	Result (dBuV)	Limit (dBuV)	Margin (dB)	Remark
1	3990.000	50.27	-2.59	47.68	74.00	-26.32	peak
2	4920.000	48.47	0.34	48.81	74.00	-25.19	peak
3	7995.000	42.19	8.72	50.91	74.00	-23.09	peak
4	11520.000	36.00	14.33	50.33	74.00	-23.67	peak
5	13815.000	33.82	18.79	52.61	74.00	-21.39	peak
6	16440.000	32.07	18.95	51.02	74.00	-22.98	peak

- Note: 1. Measurement = Reading Level + Correct Factor.
 2. If Peak Result complies with AV limit, AV Result is deemed to comply with AV limit.
 3. Peak: Peak detector.
 4. Filter losses were only considered in then spurious frequency bands and the authorized band was not corrected for BRF losses.
 5. Proper operation of the transmitter prior to adding the filter to the measurement chain.



HARMONICS AND SPURIOUS EMISSIONS (HIGH CHANNEL, VERTICAL)

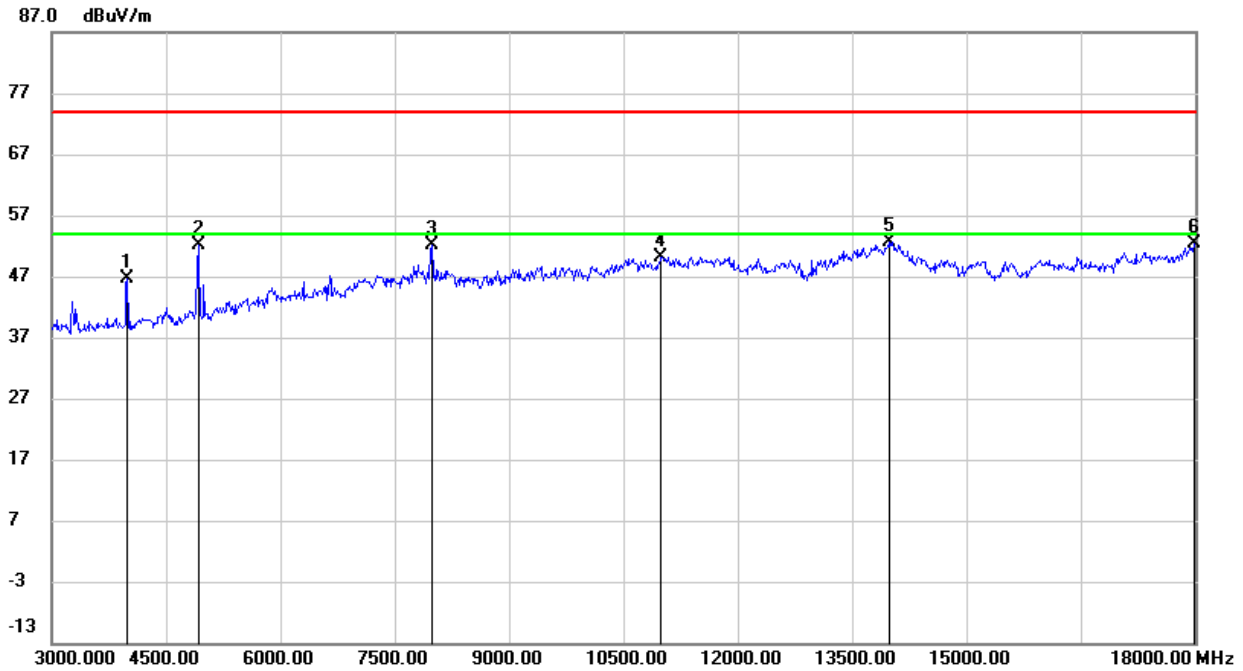

No.	Frequency (MHz)	Reading (dBuV)	Correct (dB/m)	Result (dBuV)	Limit (dBuV)	Margin (dB)	Remark
1	3990.000	49.24	-2.59	46.65	74.00	-27.35	peak
2	4920.000	51.84	0.34	52.18	74.00	-21.82	peak
3	7995.000	43.42	8.72	52.14	74.00	-21.86	peak
4	10995.000	36.71	13.49	50.20	74.00	-23.80	peak
5	13980.000	34.69	18.03	52.72	74.00	-21.28	peak
6	17985.000	27.96	24.35	52.31	74.00	-21.69	peak

- Note: 1. Measurement = Reading Level + Correct Factor.
 2. If Peak Result complies with AV limit, AV Result is deemed to comply with AV limit.
 3. Peak: Peak detector.
 4. Filter losses were only considered in then spurious frequency bands and the authorized band was not corrected for BRF losses.
 5. Proper operation of the transmitter prior to adding the filter to the measurement chain.



9.3. SPURIOUS EMISSIONS (1~3GHz)

9.3.1. 802.11b MODE

HARMONICS AND SPURIOUS EMISSIONS (LOW CHANNEL, HORIZONTAL)

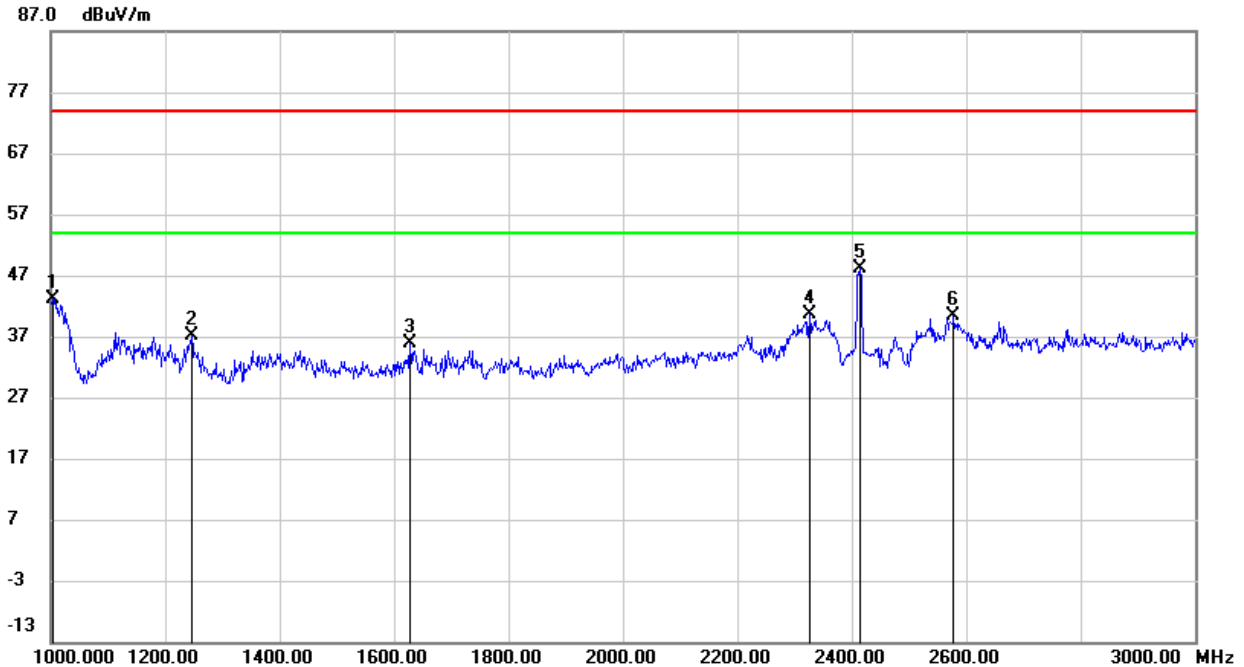

No.	Frequency (MHz)	Reading (dBuV)	Correct (dB/m)	Result (dBuV)	Limit (dBuV)	Margin (dB)	Remark
1	1004.000	56.28	-13.09	43.19	74.00	-30.81	peak
2	1246.000	49.01	-11.87	37.14	74.00	-36.86	peak
3	1628.000	46.51	-10.63	35.88	74.00	-38.12	peak
4	2326.000	47.91	-7.39	40.52	74.00	-33.48	peak
5	2414.000	55.06	-7.01	48.05	74.00	-25.95	peak
6	2578.000	46.96	-6.70	40.26	74.00	-33.74	peak

- Note: 1. Measurement = Reading Level + Correct Factor.
 2. If Peak Result complies with AV limit, AV Result is deemed to comply with AV limit.
 3. Peak: Peak detector.
 4. Filter losses were only considered in then spurious frequency bands and the authorized band was not corrected for BRF losses.
 5. Proper operation of the transmitter prior to adding the filter to the measurement chain.



HARMONICS AND SPURIOUS EMISSIONS (LOW CHANNEL, VERTICAL)

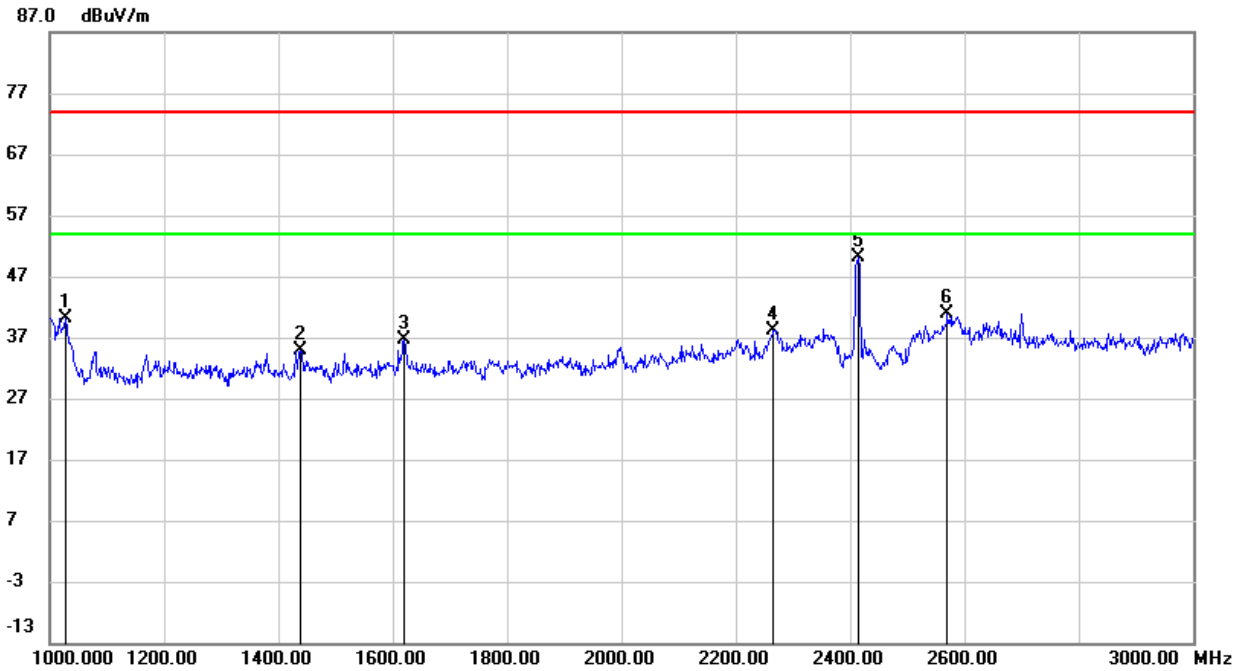

No.	Frequency (MHz)	Reading (dBuV)	Correct (dB/m)	Result (dBuV)	Limit (dBuV)	Margin (dB)	Remark
1	1028.000	53.14	-12.96	40.18	74.00	-33.82	peak
2	1438.000	46.62	-11.79	34.83	74.00	-39.17	peak
3	1620.000	47.33	-10.62	36.71	74.00	-37.29	peak
4	2266.000	46.07	-7.82	38.25	74.00	-35.75	peak
5	2414.000	57.04	-7.00	50.04	74.00	-23.96	peak
6	2570.000	47.61	-6.66	40.95	74.00	-33.05	peak

- Note: 1. Measurement = Reading Level + Correct Factor.
 2. If Peak Result complies with AV limit, AV Result is deemed to comply with AV limit.
 3. Peak: Peak detector.
 4. Filter losses were only considered in then spurious frequency bands and the authorized band was not corrected for BRF losses.
 5. Proper operation of the transmitter prior to adding the filter to the measurement chain.



HARMONICS AND SPURIOUS EMISSIONS (MID CHANNEL, HORIZONTAL)

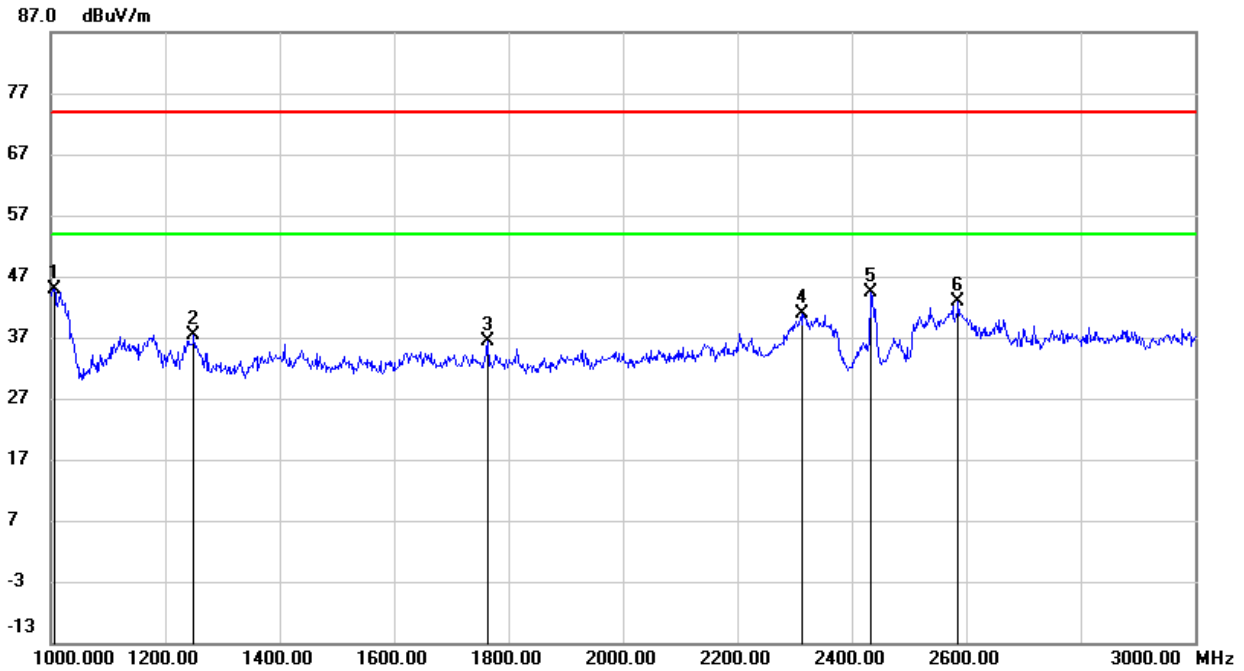

No.	Frequency (MHz)	Reading (dBuV)	Correct (dB/m)	Result (dBuV)	Limit (dBuV)	Margin (dB)	Remark
1	1006.000	57.99	-13.08	44.91	74.00	-29.09	peak
2	1250.000	49.14	-11.82	37.32	74.00	-36.68	peak
3	1764.000	46.30	-9.89	36.41	74.00	-37.59	peak
4	2314.000	48.28	-7.43	40.85	74.00	-33.15	peak
5	2434.000	51.10	-6.84	44.26	74.00	-29.74	peak
6	2586.000	49.62	-6.73	42.89	74.00	-31.11	peak

- Note: 1. Measurement = Reading Level + Correct Factor.
 2. If Peak Result complies with AV limit, AV Result is deemed to comply with AV limit.
 3. Peak: Peak detector.
 4. Filter losses were only considered in then spurious frequency bands and the authorized band was not corrected for BRF losses.
 5. Proper operation of the transmitter prior to adding the filter to the measurement chain.



HARMONICS AND SPURIOUS EMISSIONS (MID CHANNEL, VERTICAL)

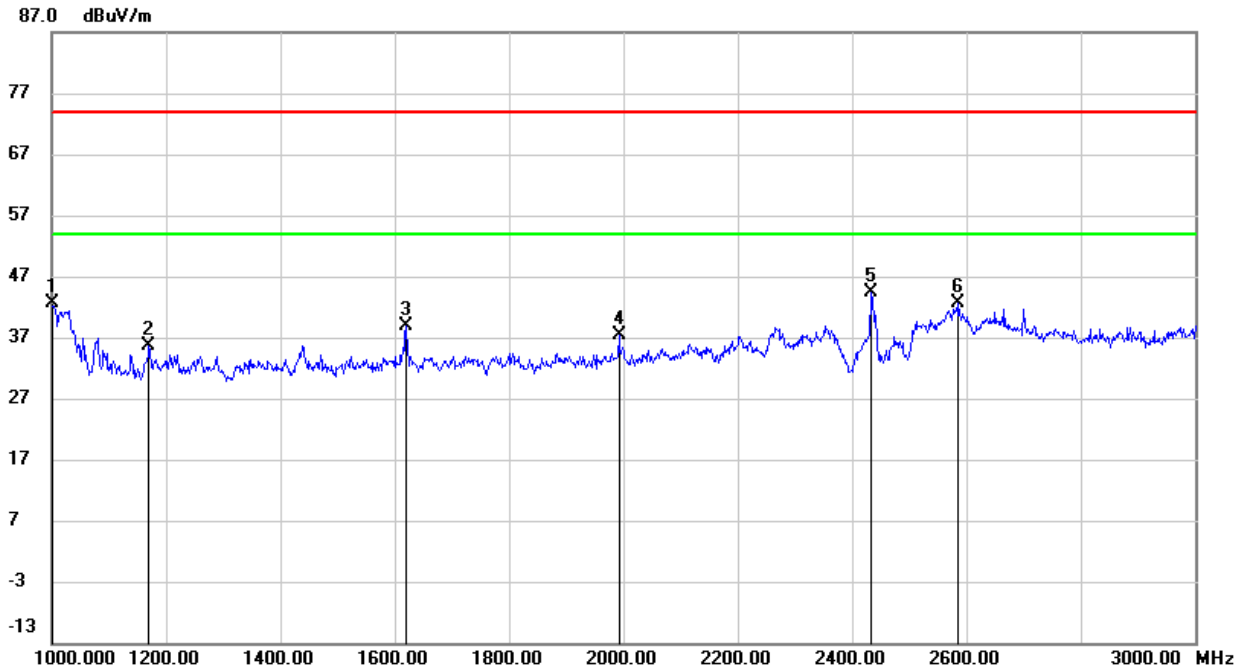

No.	Frequency (MHz)	Reading (dBuV)	Correct (dB/m)	Result (dBuV)	Limit (dBuV)	Margin (dB)	Remark
1	1000.0000	55.77	-13.11	42.66	74.00	-31.34	peak
2	1170.000	48.23	-12.49	35.74	74.00	-38.26	peak
3	1620.000	49.43	-10.62	38.81	74.00	-35.19	peak
4	1992.000	47.14	-9.74	37.40	74.00	-36.60	peak
5	2434.000	51.31	-6.84	44.47	74.00	-29.53	peak
6	2586.000	49.29	-6.73	42.56	74.00	-31.44	peak

- Note: 1. Measurement = Reading Level + Correct Factor.
 2. If Peak Result complies with AV limit, AV Result is deemed to comply with AV limit.
 3. Peak: Peak detector.
 4. Filter losses were only considered in then spurious frequency bands and the authorized band was not corrected for BRF losses.
 5. Proper operation of the transmitter prior to adding the filter to the measurement chain.



HARMONICS AND SPURIOUS EMISSIONS (HIGH CHANNEL, HORIZONTAL)

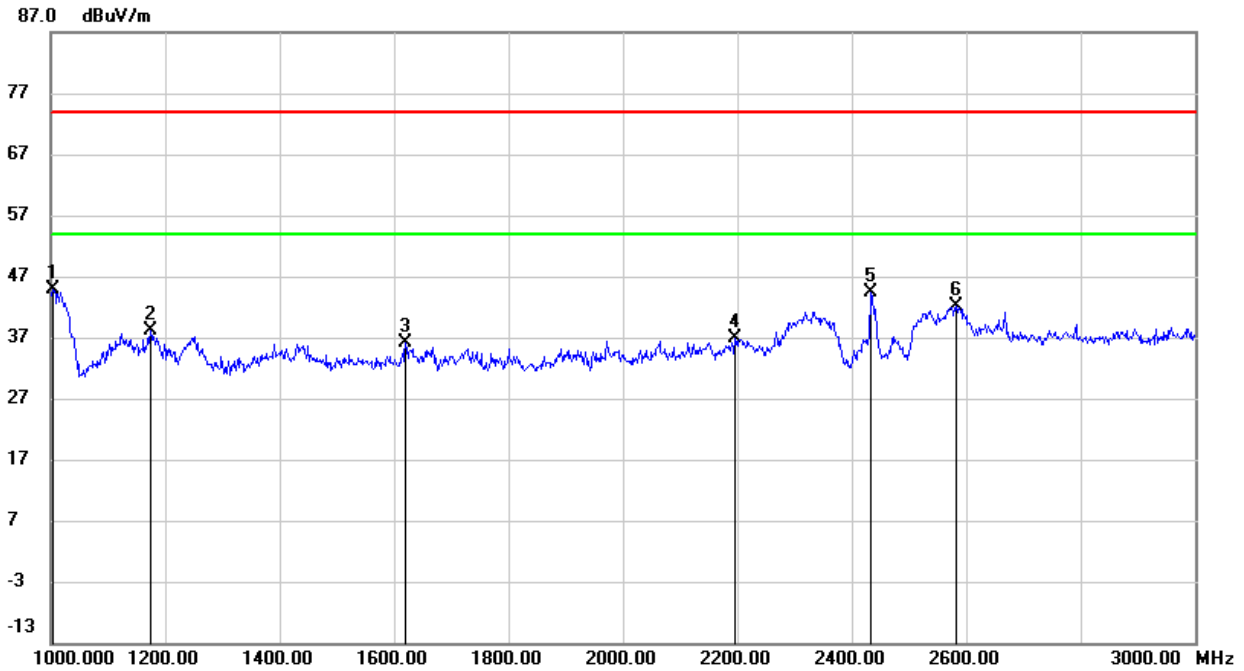

No.	Frequency (MHz)	Reading (dBuV)	Correct (dB/m)	Result (dBuV)	Limit (dBuV)	Margin (dB)	Remark
1	1004.000	58.03	-13.09	44.94	74.00	-29.06	peak
2	1174.000	50.63	-12.49	38.14	74.00	-35.86	peak
3	1620.000	46.83	-10.62	36.21	74.00	-37.79	peak
4	2196.000	45.36	-8.44	36.92	74.00	-37.08	peak
5	2434.000	51.13	-6.84	44.29	74.00	-29.71	peak
6	2582.000	48.74	-6.72	42.02	74.00	-31.98	peak

- Note: 1. Measurement = Reading Level + Correct Factor.
 2. If Peak Result complies with AV limit, AV Result is deemed to comply with AV limit.
 3. Peak: Peak detector.
 4. Filter losses were only considered in then spurious frequency bands and the authorized band was not corrected for BRF losses.
 5. Proper operation of the transmitter prior to adding the filter to the measurement chain.



HARMONICS AND SPURIOUS EMISSIONS (HIGH CHANNEL, VERTICAL)

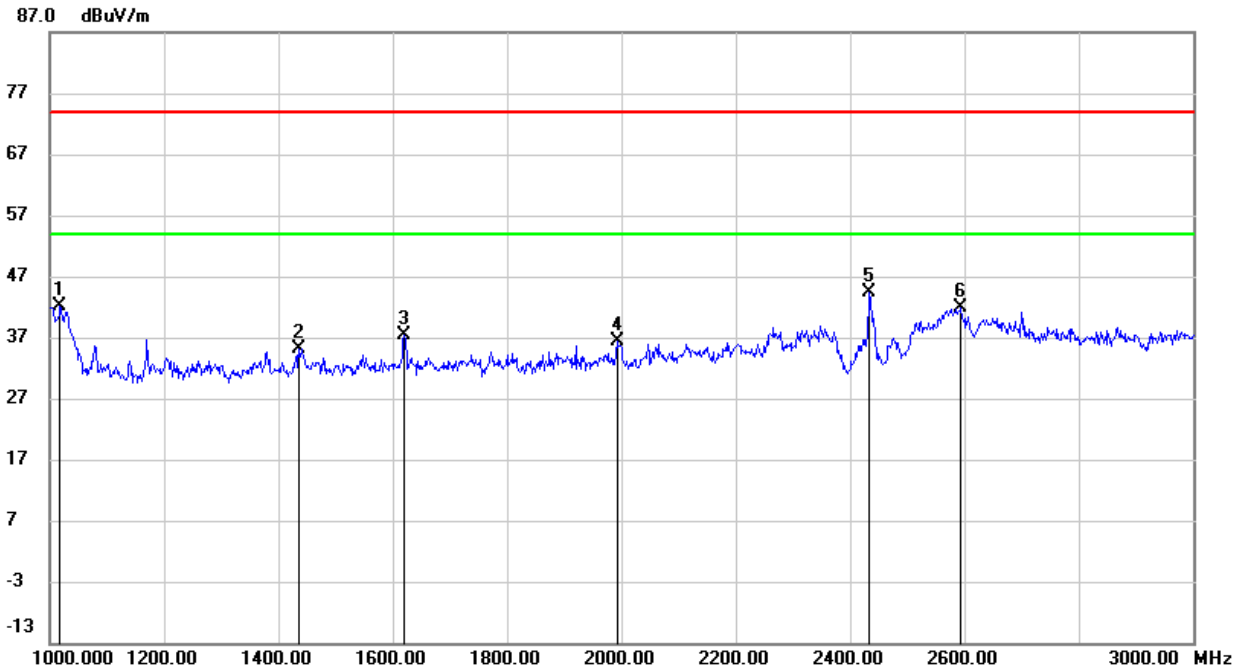

No.	Frequency (MHz)	Reading (dBuV)	Correct (dB/m)	Result (dBuV)	Limit (dBuV)	Margin (dB)	Remark
1	1018.000	55.03	-13.02	42.01	74.00	-31.99	peak
2	1436.000	46.96	-11.81	35.15	74.00	-38.85	peak
3	1620.000	48.05	-10.62	37.43	74.00	-36.57	peak
4	1992.000	46.17	-9.74	36.43	74.00	-37.57	peak
5	2434.000	51.19	-6.84	44.35	74.00	-29.65	peak
6	2594.000	48.70	-6.78	41.92	74.00	-32.08	peak

- Note: 1. Measurement = Reading Level + Correct Factor.
 2. If Peak Result complies with AV limit, AV Result is deemed to comply with AV limit.
 3. Peak: Peak detector.
 4. Filter losses were only considered in then spurious frequency bands and the authorized band was not corrected for BRF losses.
 5. Proper operation of the transmitter prior to adding the filter to the measurement chain.



9.3.2. 802.11g MODE

HARMONICS AND SPURIOUS EMISSIONS (LOW CHANNEL, HORIZONTAL)

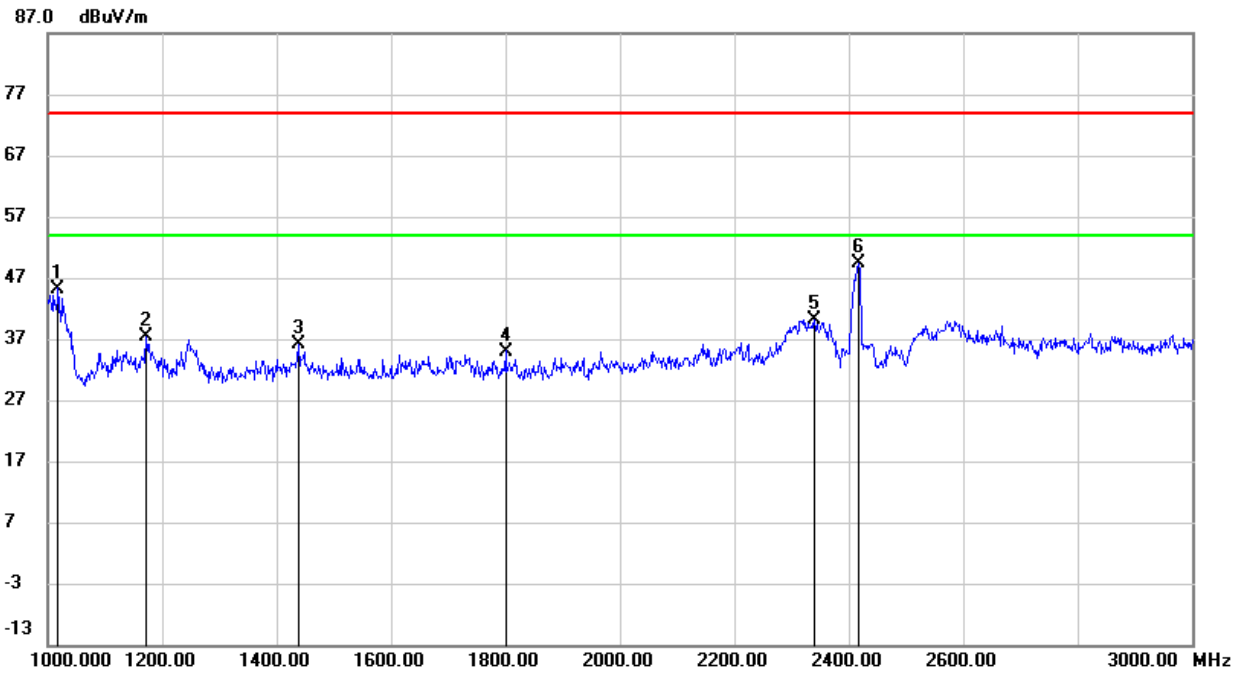

No.	Frequency (MHz)	Reading (dBuV)	Correct (dB/m)	Result (dBuV)	Limit (dBuV)	Margin (dB)	Remark
1	1018.000	58.27	-13.02	45.25	74.00	-28.75	peak
2	1172.000	49.88	-12.49	37.39	74.00	-36.61	peak
3	1438.000	47.84	-11.79	36.05	74.00	-37.95	peak
4	1800.000	44.42	-9.42	35.00	74.00	-39.00	peak
5	2340.000	47.51	-7.34	40.17	74.00	-33.83	peak
6	2418.000	56.32	-6.97	49.35	74.00	-24.65	peak

- Note: 1. Measurement = Reading Level + Correct Factor.
 2. If Peak Result complies with AV limit, AV Result is deemed to comply with AV limit.
 3. Peak: Peak detector.
 4. Filter losses were only considered in then spurious frequency bands and the authorized band was not corrected for BRF losses.
 5. Proper operation of the transmitter prior to adding the filter to the measurement chain.



HARMONICS AND SPURIOUS EMISSIONS (LOW CHANNEL, VERTICAL)

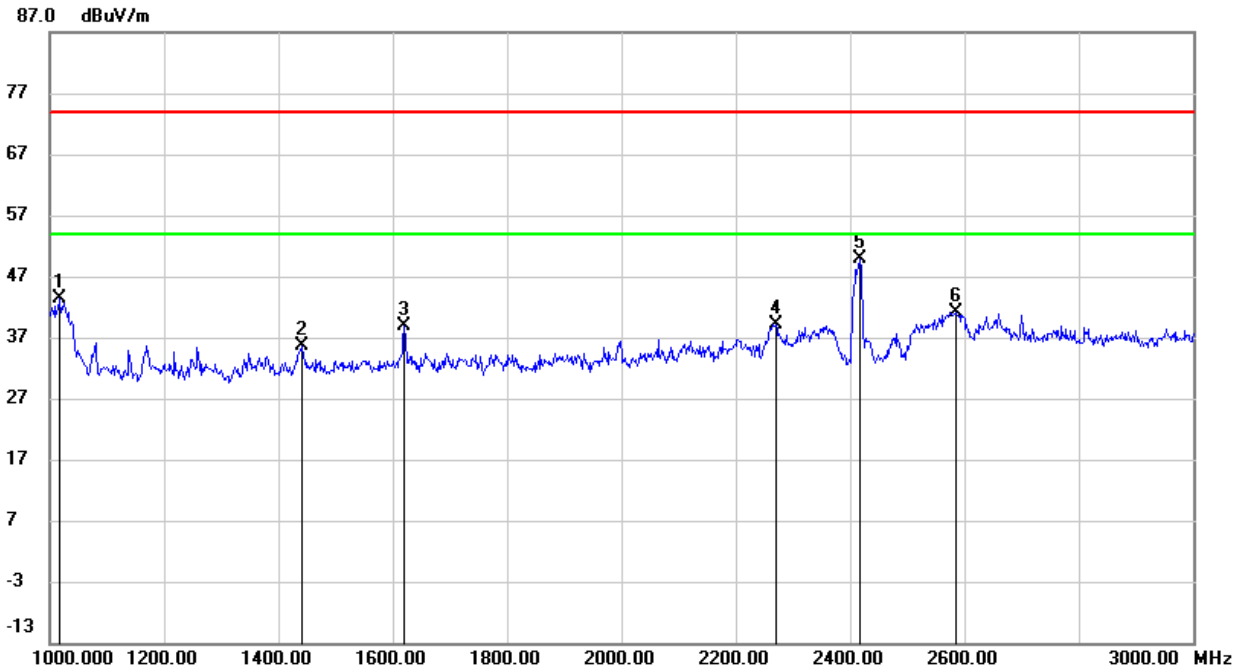

No.	Frequency (MHz)	Reading (dBuV)	Correct (dB/m)	Result (dBuV)	Limit (dBuV)	Margin (dB)	Remark
1	1016.000	56.42	-13.03	43.39	74.00	-30.61	peak
2	1442.000	47.39	-11.78	35.61	74.00	-38.39	peak
3	1620.000	49.47	-10.62	38.85	74.00	-35.15	peak
4	2270.000	46.86	-7.77	39.09	74.00	-34.91	peak
5	2418.000	56.76	-6.97	49.79	74.00	-24.21	peak
6	2584.000	47.90	-6.73	41.17	74.00	-32.83	peak

- Note: 1. Measurement = Reading Level + Correct Factor.
 2. If Peak Result complies with AV limit, AV Result is deemed to comply with AV limit.
 3. Peak: Peak detector.
 4. Filter losses were only considered in then spurious frequency bands and the authorized band was not corrected for BRF losses.
 5. Proper operation of the transmitter prior to adding the filter to the measurement chain.



HARMONICS AND SPURIOUS EMISSIONS (MID CHANNEL, HORIZONTAL)

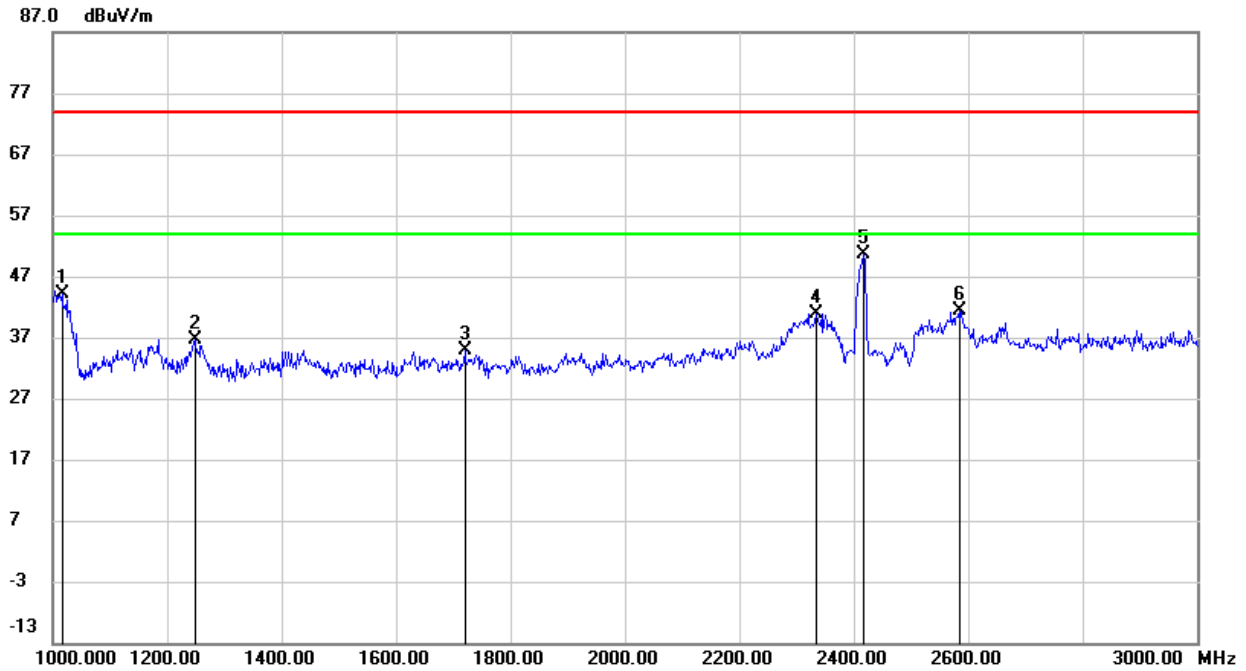

No.	Frequency (MHz)	Reading (dBuV)	Correct (dB/m)	Result (dBuV)	Limit (dBuV)	Margin (dB)	Remark
1	1016.000	57.13	-13.03	44.10	74.00	-29.90	peak
2	1248.000	48.40	-11.84	36.56	74.00	-37.44	peak
3	1720.000	45.22	-10.45	34.77	74.00	-39.23	peak
4	2334.000	48.32	-7.37	40.95	74.00	-33.05	peak
5	2418.000	57.69	-6.97	50.72	74.00	-23.28	peak
6	2584.000	48.04	-6.73	41.31	74.00	-32.69	peak

- Note: 1. Measurement = Reading Level + Correct Factor.
 2. If Peak Result complies with AV limit, AV Result is deemed to comply with AV limit.
 3. Peak: Peak detector.
 4. Filter losses were only considered in then spurious frequency bands and the authorized band was not corrected for BRF losses.
 5. Proper operation of the transmitter prior to adding the filter to the measurement chain.



HARMONICS AND SPURIOUS EMISSIONS (MID CHANNEL, VERTICAL)

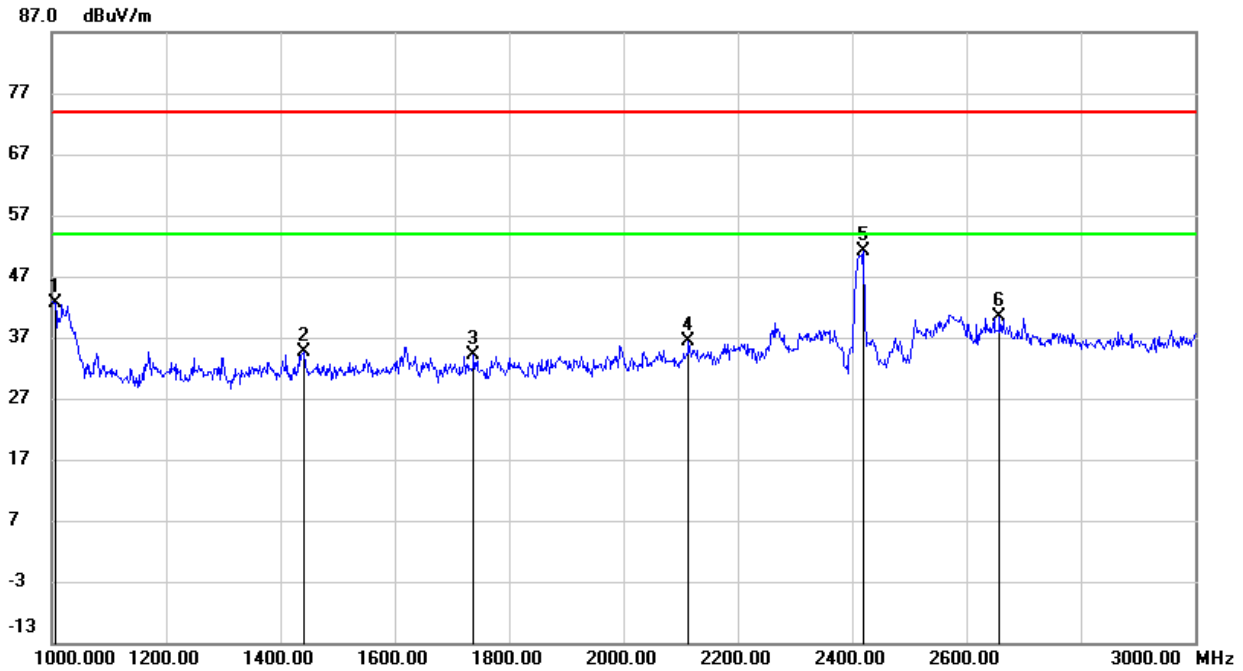

No.	Frequency (MHz)	Reading (dBuV)	Correct (dB/m)	Result (dBuV)	Limit (dBuV)	Margin (dB)	Remark
1	1006.000	55.75	-13.08	42.67	74.00	-31.33	peak
2	1442.000	46.40	-11.78	34.62	74.00	-39.38	peak
3	1738.000	44.29	-10.22	34.07	74.00	-39.93	peak
4	2114.000	44.71	-8.33	36.38	74.00	-37.62	peak
5	2420.000	58.15	-6.95	51.20	74.00	-22.80	peak
6	2658.000	47.54	-7.16	40.38	74.00	-33.62	peak

- Note: 1. Measurement = Reading Level + Correct Factor.
 2. If Peak Result complies with AV limit, AV Result is deemed to comply with AV limit.
 3. Peak: Peak detector.
 4. Filter losses were only considered in then spurious frequency bands and the authorized band was not corrected for BRF losses.
 5. Proper operation of the transmitter prior to adding the filter to the measurement chain.



HARMONICS AND SPURIOUS EMISSIONS (HIGH CHANNEL, HORIZONTAL)

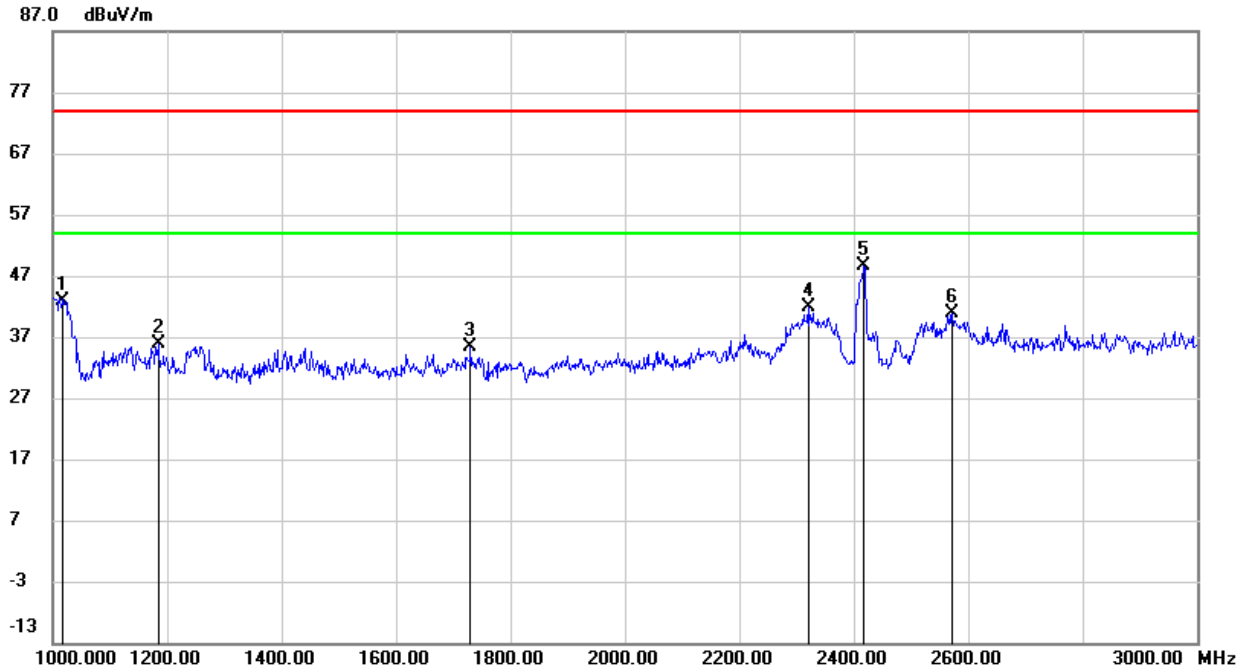

No.	Frequency (MHz)	Reading (dBuV)	Correct (dB/m)	Result (dBuV)	Limit (dBuV)	Margin (dB)	Remark
1	1016.000	56.03	-13.03	43.00	74.00	-31.00	peak
2	1184.000	48.26	-12.47	35.79	74.00	-38.21	peak
3	1730.000	45.75	-10.32	35.43	74.00	-38.57	peak
4	2320.000	49.40	-7.41	41.99	74.00	-32.01	peak
5	2418.000	55.64	-6.97	48.67	74.00	-25.33	peak
6	2572.000	47.62	-6.67	40.95	74.00	-33.05	peak

- Note: 1. Measurement = Reading Level + Correct Factor.
 2. If Peak Result complies with AV limit, AV Result is deemed to comply with AV limit.
 3. Peak: Peak detector.
 4. Filter losses were only considered in then spurious frequency bands and the authorized band was not corrected for BRF losses.
 5. Proper operation of the transmitter prior to adding the filter to the measurement chain.



HARMONICS AND SPURIOUS EMISSIONS (HIGH CHANNEL, VERTICAL)

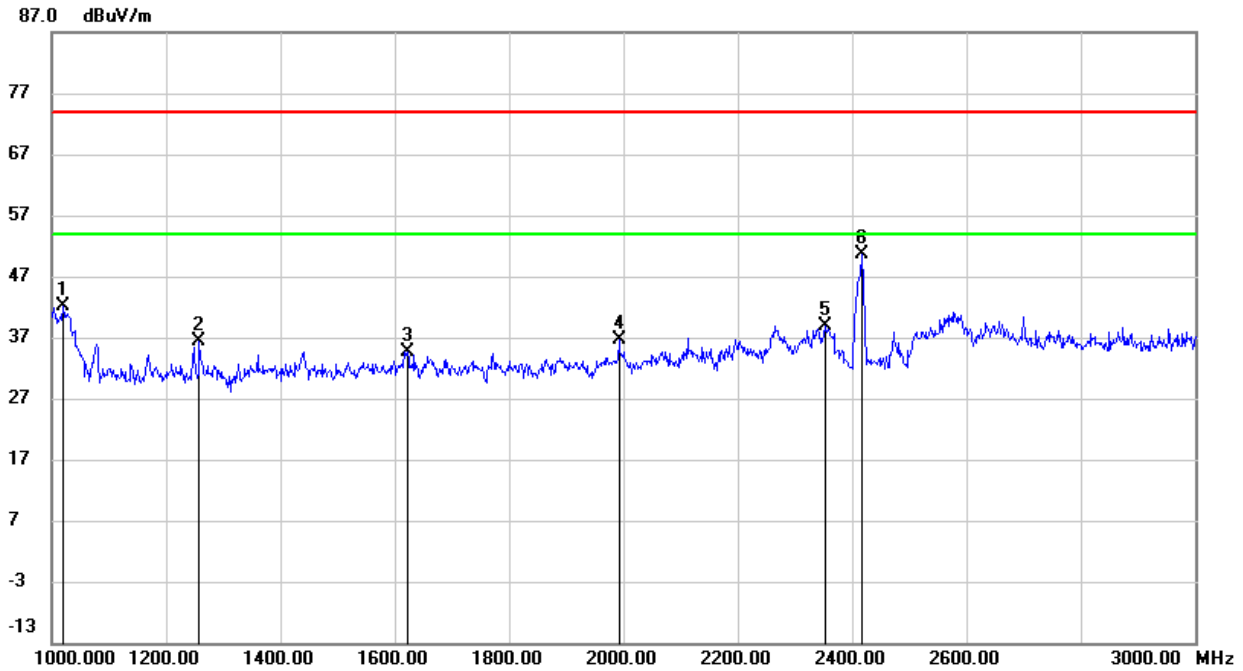

No.	Frequency (MHz)	Reading (dBuV)	Correct (dB/m)	Result (dBuV)	Limit (dBuV)	Margin (dB)	Remark
1	1020.000	55.07	-13.00	42.07	74.00	-31.93	peak
2	1258.000	48.22	-11.74	36.48	74.00	-37.52	peak
3	1622.000	45.26	-10.63	34.63	74.00	-39.37	peak
4	1992.000	46.36	-9.74	36.62	74.00	-37.38	peak
5	2352.000	46.25	-7.29	38.96	74.00	-35.04	peak
6	2418.000	57.59	-6.97	50.62	74.00	-23.38	peak

- Note: 1. Measurement = Reading Level + Correct Factor.
 2. If Peak Result complies with AV limit, AV Result is deemed to comply with AV limit.
 3. Peak: Peak detector.
 4. Filter losses were only considered in then spurious frequency bands and the authorized band was not corrected for BRF losses.
 5. Proper operation of the transmitter prior to adding the filter to the measurement chain.



9.3.3. 802.11n HT20 MODE

HARMONICS AND SPURIOUS EMISSIONS (LOW CHANNEL, HORIZONTAL)

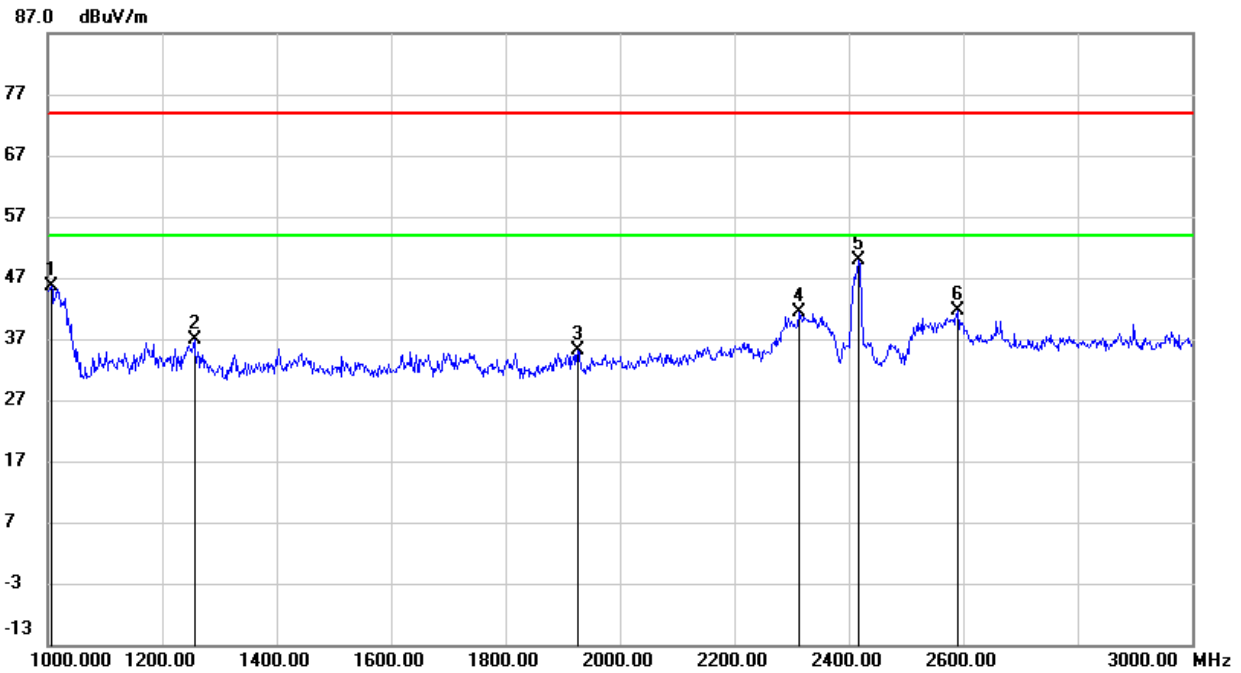

No.	Frequency (MHz)	Reading (dBuV)	Correct (dB/m)	Result (dBuV)	Limit (dBuV)	Margin (dB)	Remark
1	1006.000	58.59	-13.08	45.51	74.00	-28.49	peak
2	1256.000	48.67	-11.76	36.91	74.00	-37.09	peak
3	1926.000	44.60	-9.42	35.18	74.00	-38.82	peak
4	2312.000	48.78	-7.44	41.34	74.00	-32.66	peak
5	2418.000	56.75	-6.97	49.78	74.00	-24.22	peak
6	2590.000	48.41	-6.76	41.65	74.00	-32.35	peak

- Note: 1. Measurement = Reading Level + Correct Factor.
 2. If Peak Result complies with AV limit, AV Result is deemed to comply with AV limit.
 3. Peak: Peak detector.
 4. Filter losses were only considered in then spurious frequency bands and the authorized band was not corrected for BRF losses.
 5. Proper operation of the transmitter prior to adding the filter to the measurement chain.



HARMONICS AND SPURIOUS EMISSIONS (LOW CHANNEL, VERTICAL)

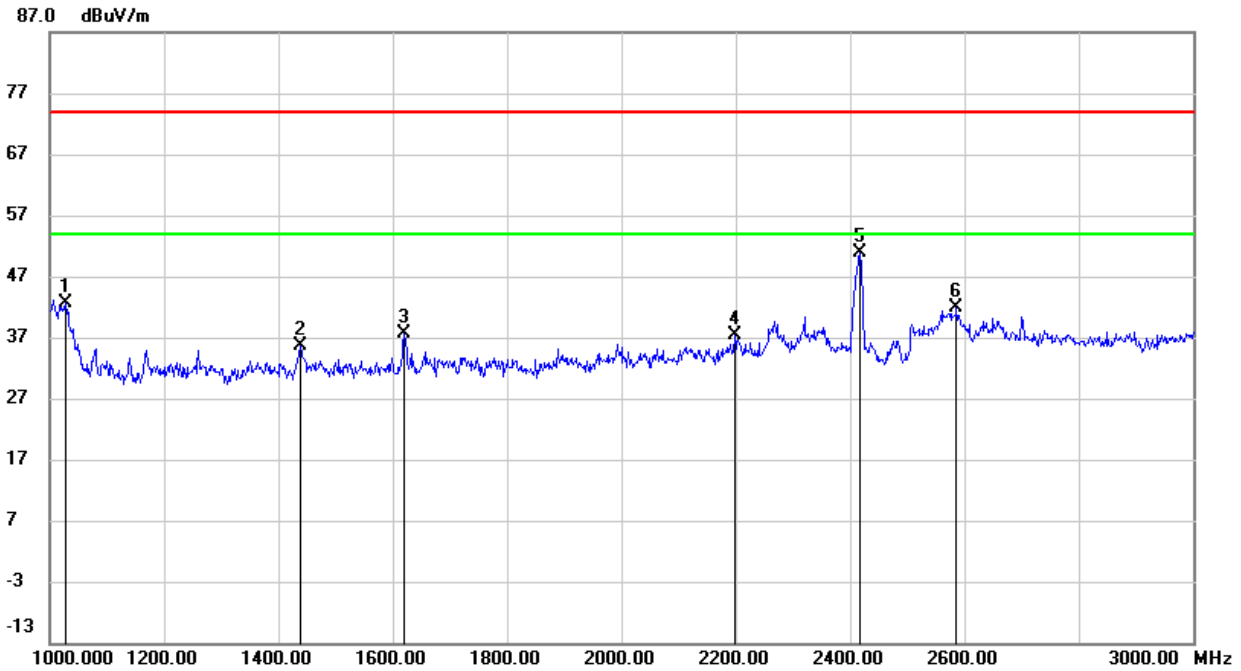

No.	Frequency (MHz)	Reading (dBuV)	Correct (dB/m)	Result (dBuV)	Limit (dBuV)	Margin (dB)	Remark
1	1028.000	55.56	-12.96	42.60	74.00	-31.40	peak
2	1438.000	47.32	-11.79	35.53	74.00	-38.47	peak
3	1620.000	48.23	-10.62	37.61	74.00	-36.39	peak
4	2198.000	45.75	-8.44	37.31	74.00	-36.69	peak
5	2416.000	57.87	-6.99	50.88	74.00	-23.12	peak
6	2586.000	48.52	-6.73	41.79	74.00	-32.21	peak

- Note: 1. Measurement = Reading Level + Correct Factor.
 2. If Peak Result complies with AV limit, AV Result is deemed to comply with AV limit.
 3. Peak: Peak detector.
 4. Filter losses were only considered in then spurious frequency bands and the authorized band was not corrected for BRF losses.
 5. Proper operation of the transmitter prior to adding the filter to the measurement chain.



HARMONICS AND SPURIOUS EMISSIONS (MID CHANNEL, HORIZONTAL)

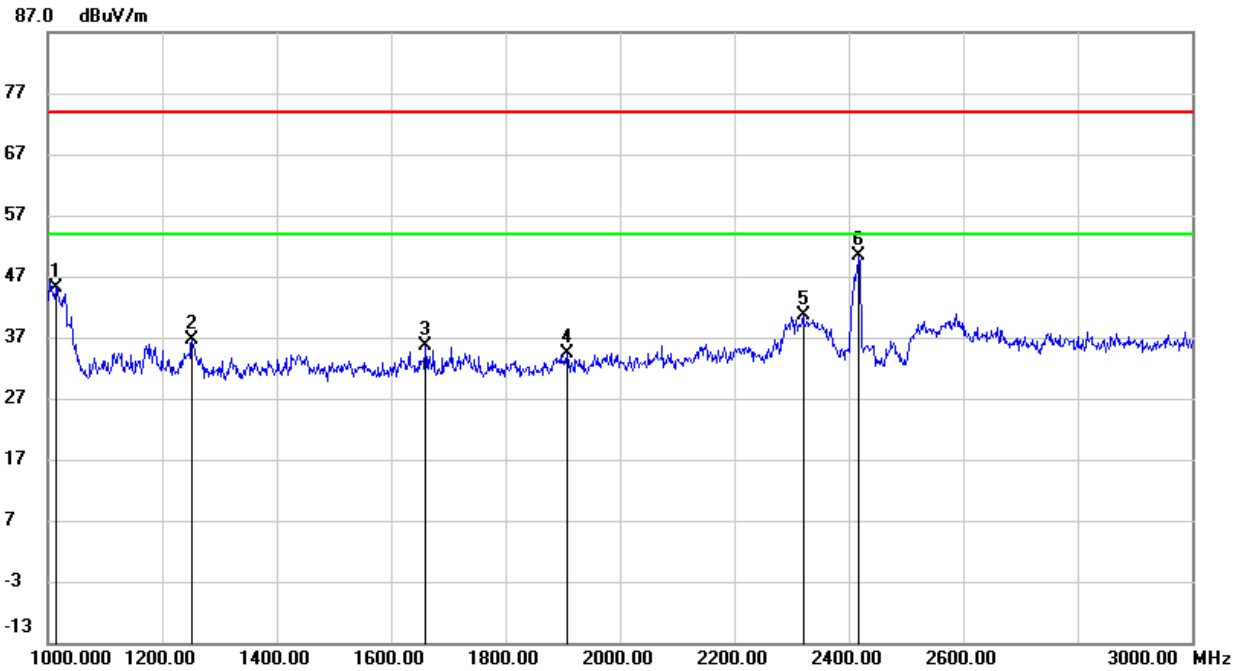

No.	Frequency (MHz)	Reading (dBuV)	Correct (dB/m)	Result (dBuV)	Limit (dBuV)	Margin (dB)	Remark
1	1014.000	58.17	-13.03	45.14	74.00	-28.86	peak
2	1252.000	48.45	-11.81	36.64	74.00	-37.36	peak
3	1660.000	46.21	-10.67	35.54	74.00	-38.46	peak
4	1908.000	43.81	-9.34	34.47	74.00	-39.53	peak
5	2320.000	47.98	-7.41	40.57	74.00	-33.43	peak
6	2418.000	57.32	-6.97	50.35	74.00	-23.65	peak

- Note: 1. Measurement = Reading Level + Correct Factor.
 2. If Peak Result complies with AV limit, AV Result is deemed to comply with AV limit.
 3. Peak: Peak detector.
 4. Filter losses were only considered in then spurious frequency bands and the authorized band was not corrected for BRF losses.
 5. Proper operation of the transmitter prior to adding the filter to the measurement chain.



HARMONICS AND SPURIOUS EMISSIONS (MID CHANNEL, VERTICAL)

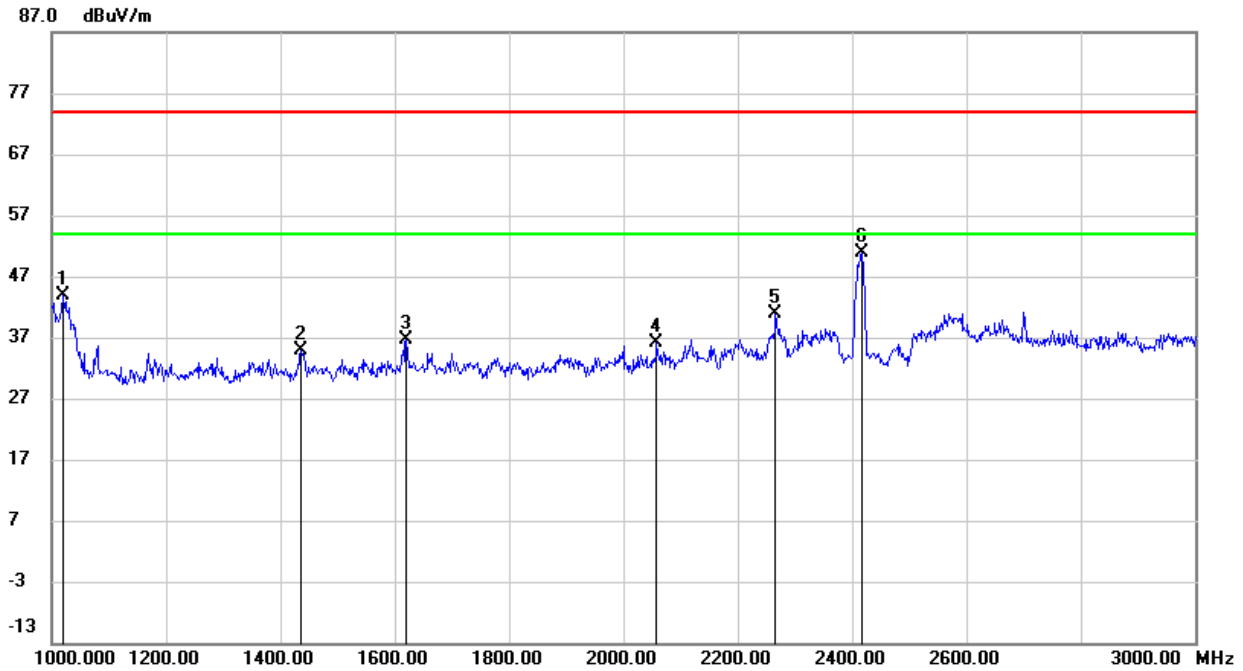

No.	Frequency (MHz)	Reading (dBuV)	Correct (dB/m)	Result (dBuV)	Limit (dBuV)	Margin (dB)	Remark
1	1020.000	56.76	-13.00	43.76	74.00	-30.24	peak
2	1436.000	46.71	-11.81	34.90	74.00	-39.10	peak
3	1620.000	47.26	-10.62	36.64	74.00	-37.36	peak
4	2058.000	45.12	-8.94	36.18	74.00	-37.82	peak
5	2266.000	48.59	-7.82	40.77	74.00	-33.23	peak
6	2416.000	57.88	-6.99	50.89	74.00	-23.11	peak

- Note: 1. Measurement = Reading Level + Correct Factor.
 2. If Peak Result complies with AV limit, AV Result is deemed to comply with AV limit.
 3. Peak: Peak detector.
 4. Filter losses were only considered in then spurious frequency bands and the authorized band was not corrected for BRF losses.
 5. Proper operation of the transmitter prior to adding the filter to the measurement chain.



HARMONICS AND SPURIOUS EMISSIONS (HIGH CHANNEL, HORIZONTAL)

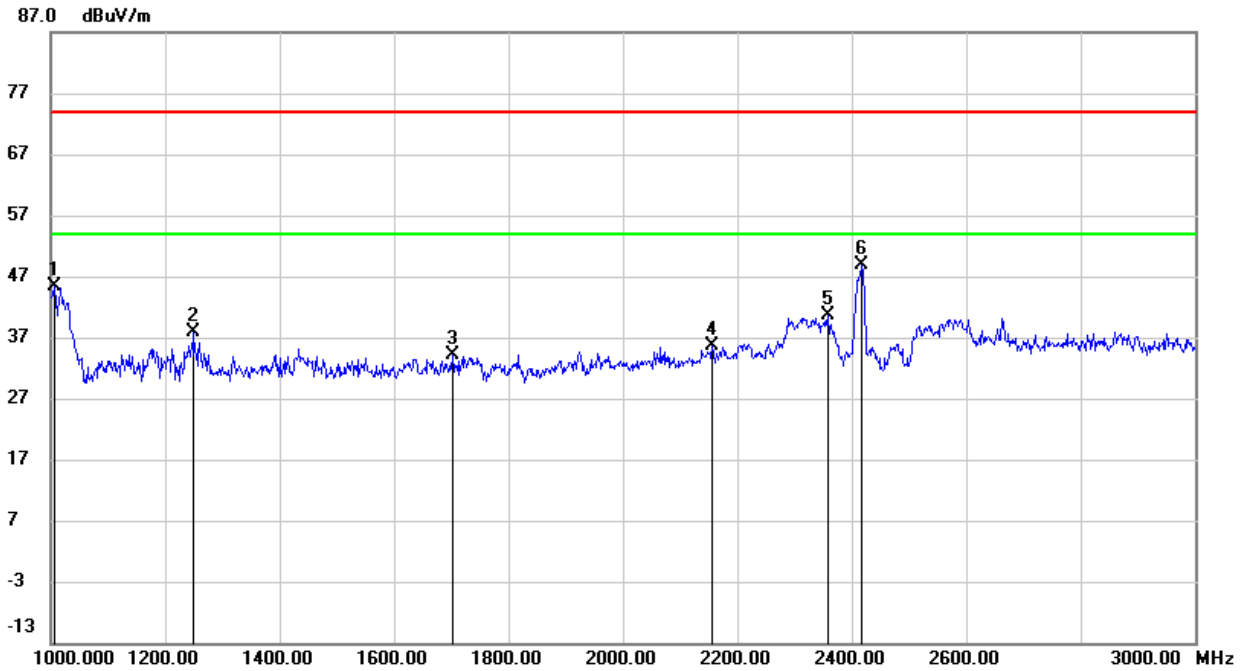

No.	Frequency (MHz)	Reading (dBuV)	Correct (dB/m)	Result (dBuV)	Limit (dBuV)	Margin (dB)	Remark
1	1006.000	58.41	-13.08	45.33	74.00	-28.67	peak
2	1250.000	49.73	-11.82	37.91	74.00	-36.09	peak
3	1702.000	44.71	-10.68	34.03	74.00	-39.97	peak
4	2156.000	44.13	-8.39	35.74	74.00	-38.26	peak
5	2358.000	47.80	-7.27	40.53	74.00	-33.47	peak
6	2418.000	55.79	-6.97	48.82	74.00	-25.18	peak

- Note: 1. Measurement = Reading Level + Correct Factor.
 2. If Peak Result complies with AV limit, AV Result is deemed to comply with AV limit.
 3. Peak: Peak detector.
 4. Filter losses were only considered in then spurious frequency bands and the authorized band was not corrected for BRF losses.
 5. Proper operation of the transmitter prior to adding the filter to the measurement chain.



HARMONICS AND SPURIOUS EMISSIONS (HIGH CHANNEL, VERTICAL)

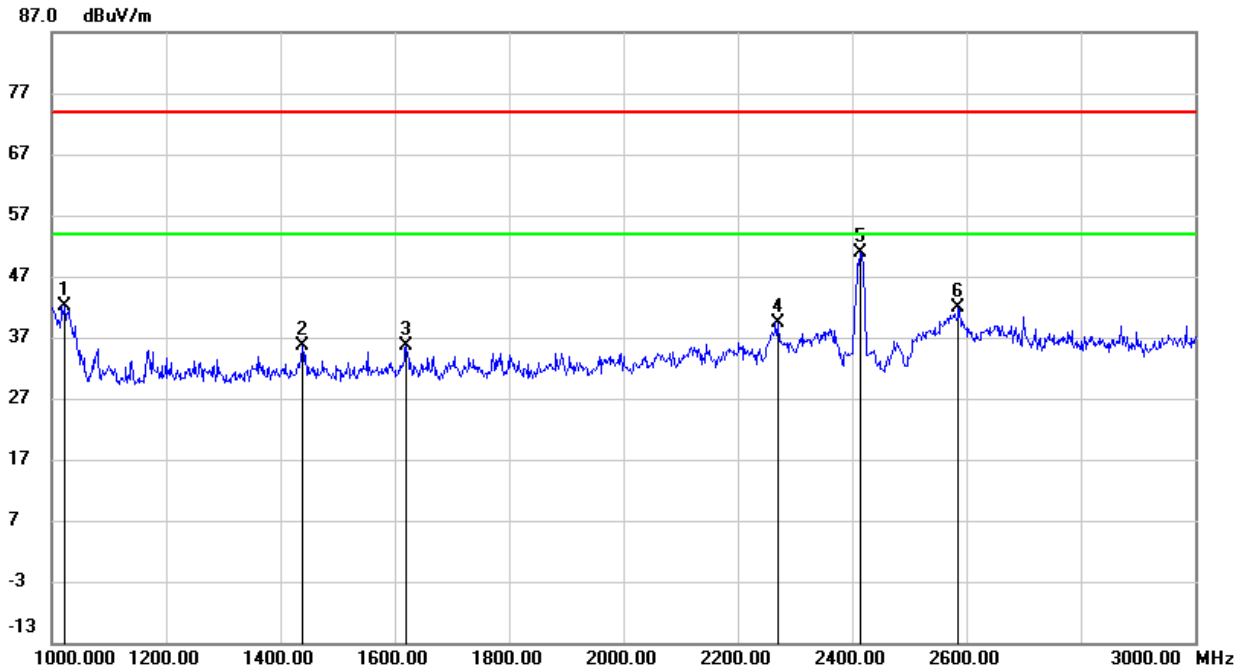

No.	Frequency (MHz)	Reading (dBuV)	Correct (dB/m)	Result (dBuV)	Limit (dBuV)	Margin (dB)	Remark
1	1022.000	55.08	-13.00	42.08	74.00	-31.92	peak
2	1438.000	47.42	-11.79	35.63	74.00	-38.37	peak
3	1620.000	46.22	-10.62	35.60	74.00	-38.40	peak
4	2270.000	47.17	-7.77	39.40	74.00	-34.60	peak
5	2414.000	57.91	-7.00	50.91	74.00	-23.09	peak
6	2586.000	48.63	-6.73	41.90	74.00	-32.10	peak

- Note: 1. Measurement = Reading Level + Correct Factor.
 2. If Peak Result complies with AV limit, AV Result is deemed to comply with AV limit.
 3. Peak: Peak detector.
 4. Filter losses were only considered in then spurious frequency bands and the authorized band was not corrected for BRF losses.
 5. Proper operation of the transmitter prior to adding the filter to the measurement chain.



9.4. SPURIOUS EMISSIONS (18~26GHz)

9.4.1. 802.11g MODE

SPURIOUS EMISSIONS (HIGH CHANNEL, WORST-CASE CONFIGURATION, HORIZONTAL)

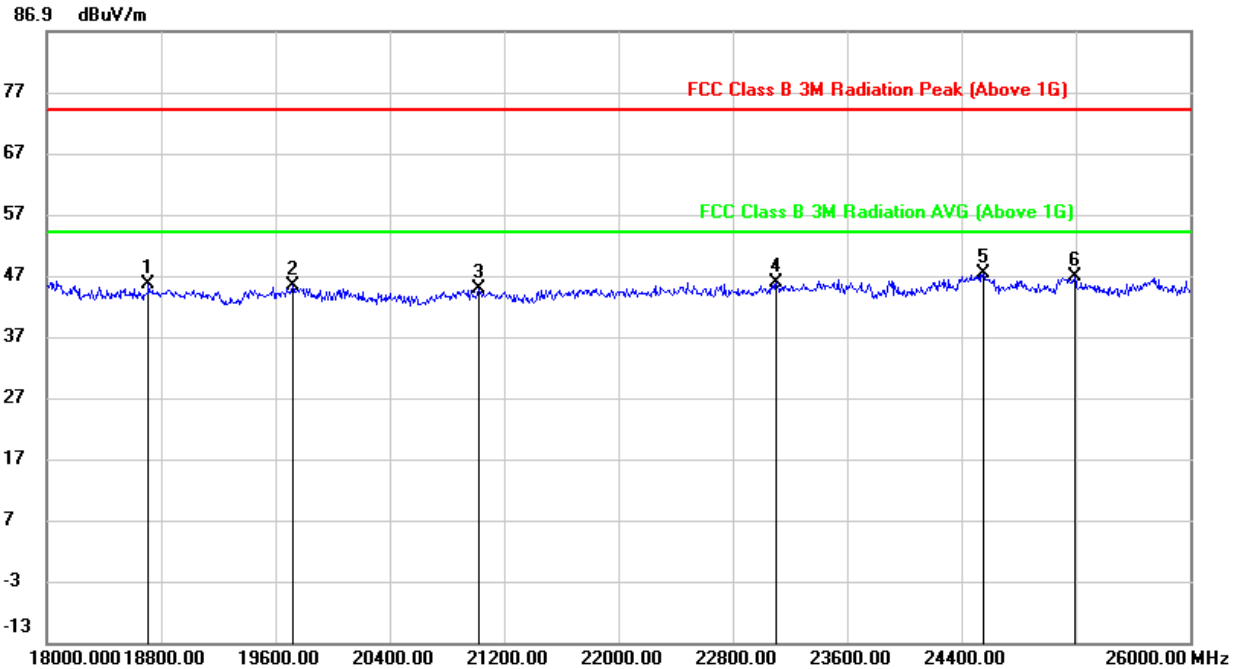

No.	Frequency (MHz)	Reading (dBuV)	Correct (dB/m)	Result (dBuV)	Limit (dBuV)	Margin (dB)	Remark
1	18712.000	50.23	-4.76	45.47	74.00	-28.53	peak
2	19720.000	49.58	-4.39	45.19	74.00	-28.81	peak
3	21024.000	50.12	-5.30	44.82	74.00	-29.18	peak
4	23104.000	51.35	-5.47	45.88	74.00	-28.12	peak
5	24552.000	49.64	-2.46	47.18	74.00	-26.82	peak
6	25192.000	47.99	-1.16	46.83	74.00	-27.17	peak

- Note: 1. Measurement = Reading Level + Correct Factor.
 2. If Peak Result complies with AV limit, AV Result is deemed to comply with AV limit.
 3. Peak: Peak detector.
 4. Proper operation of the transmitter prior to adding the filter to the measurement chain.



SPURIOUS EMISSIONS (HIGH CHANNEL, WORST-CASE CONFIGURATION, VERTICAL)

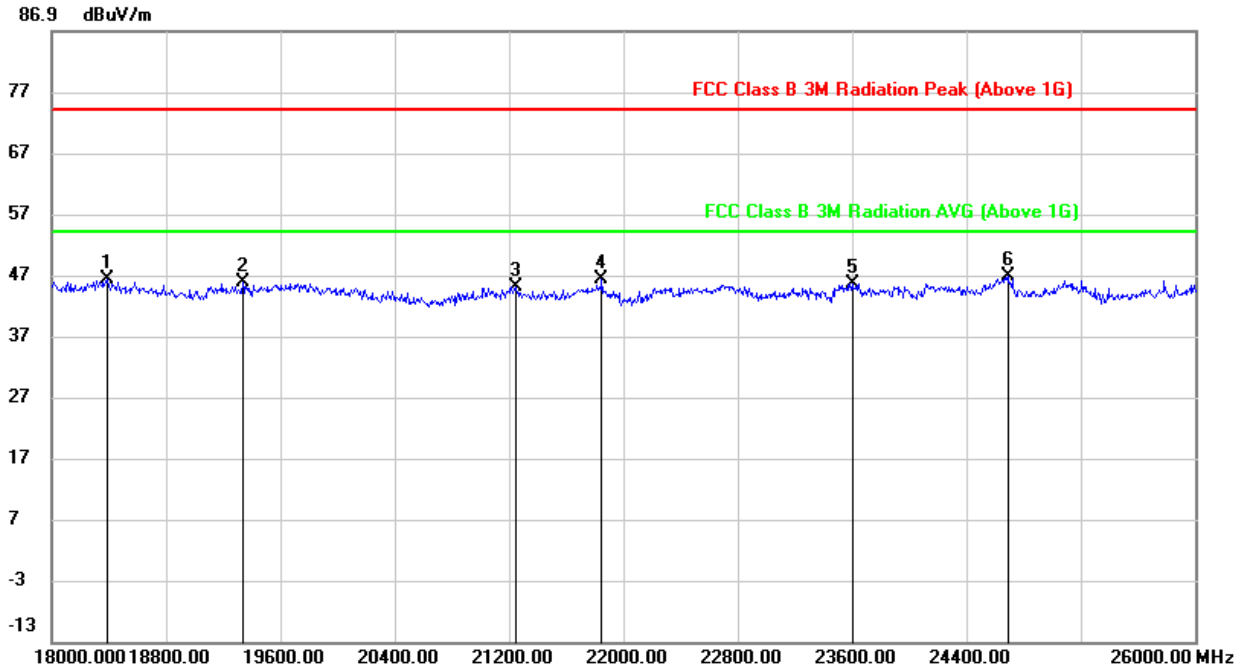

No.	Frequency (MHz)	Reading (dBuV)	Correct (dB/m)	Result (dBuV)	Limit (dBuV)	Margin (dB)	Remark
1	18384.000	50.57	-4.37	46.20	74.00	-27.80	peak
2	19336.000	50.70	-4.97	45.73	74.00	-28.27	peak
3	21248.000	50.48	-5.51	44.97	74.00	-29.03	peak
4	21848.000	52.26	-5.95	46.31	74.00	-27.69	peak
5	23600.000	50.22	-4.70	45.52	74.00	-28.48	peak
6	24688.000	48.89	-2.11	46.78	74.00	-27.22	peak

- Note: 1. Measurement = Reading Level + Correct Factor.
 2. If Peak Result complies with AV limit, AV Result is deemed to comply with AV limit.
 3. Peak: Peak detector.
 4. Proper operation of the transmitter prior to adding the filter to the measurement chain.

Note: All the test modes have been tested, only the worst data record in the report.



9.5. SPURIOUS EMISSIONS (0.03 ~ 1 GHz)

9.5.1. 802.11g MODE

SPURIOUS EMISSIONS (HIGH CHANNEL, WORST-CASE CONFIGURATION, HORIZONTAL)

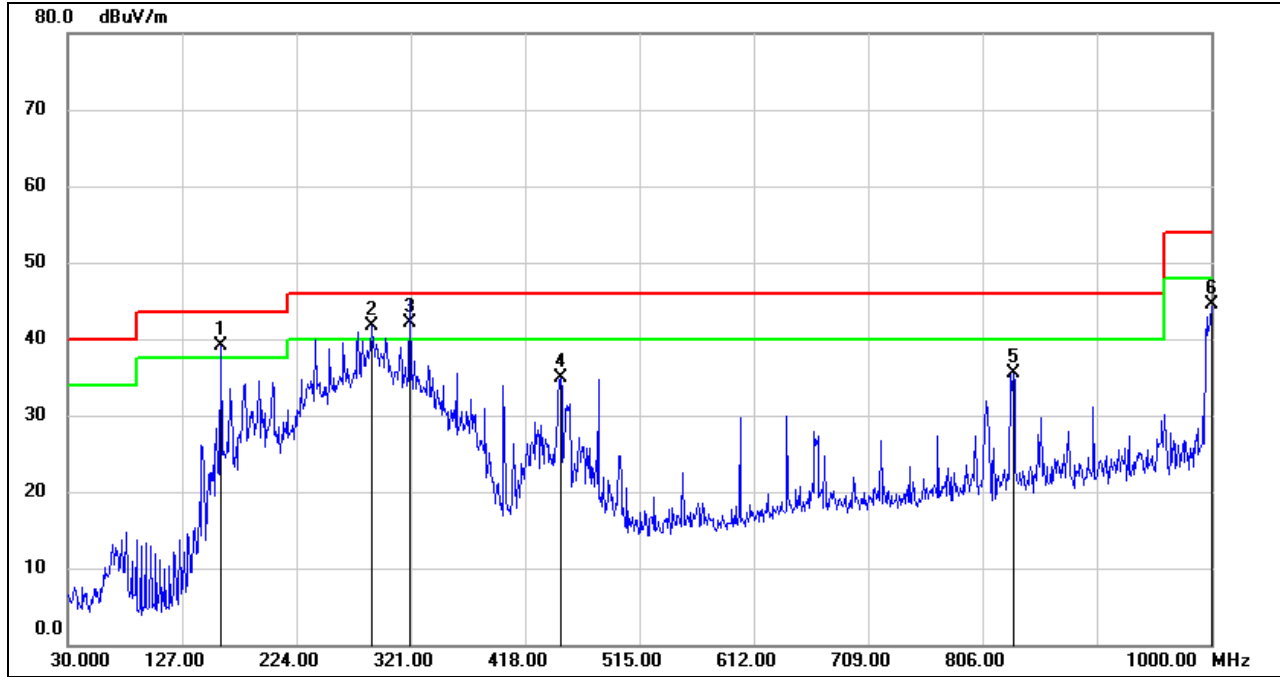

No.	Frequency (MHz)	Reading (dBuV)	Correct (dB/m)	Result (dBuV/m)	Limit (dBuV/m)	Margin (dB)	Remark
1	159.9800	56.60	-17.41	39.19	43.50	-4.31	QP
2	288.0200	55.91	-14.14	41.77	46.00	-4.23	QP
3	320.0300	55.37	-13.27	42.10	46.00	-3.90	QP
4	448.0700	46.08	-11.09	34.99	46.00	-11.01	QP
5	832.1900	39.91	-4.47	35.44	46.00	-10.56	QP
6	1000.0000	47.35	-2.88	44.47	54.00	-9.53	QP

- Note: 1. Result Level = Read Level + Correct Factor.
 2. If Peak Result complies with QP limit, QP Result is deemed to comply with QP limit.
 3. Test setup: RBW: 120 kHz, VBW: 300 kHz, Sweep time: auto.



SPURIOUS EMISSIONS (HIGH CHANNEL, WORST-CASE CONFIGURATION, VERTICAL)

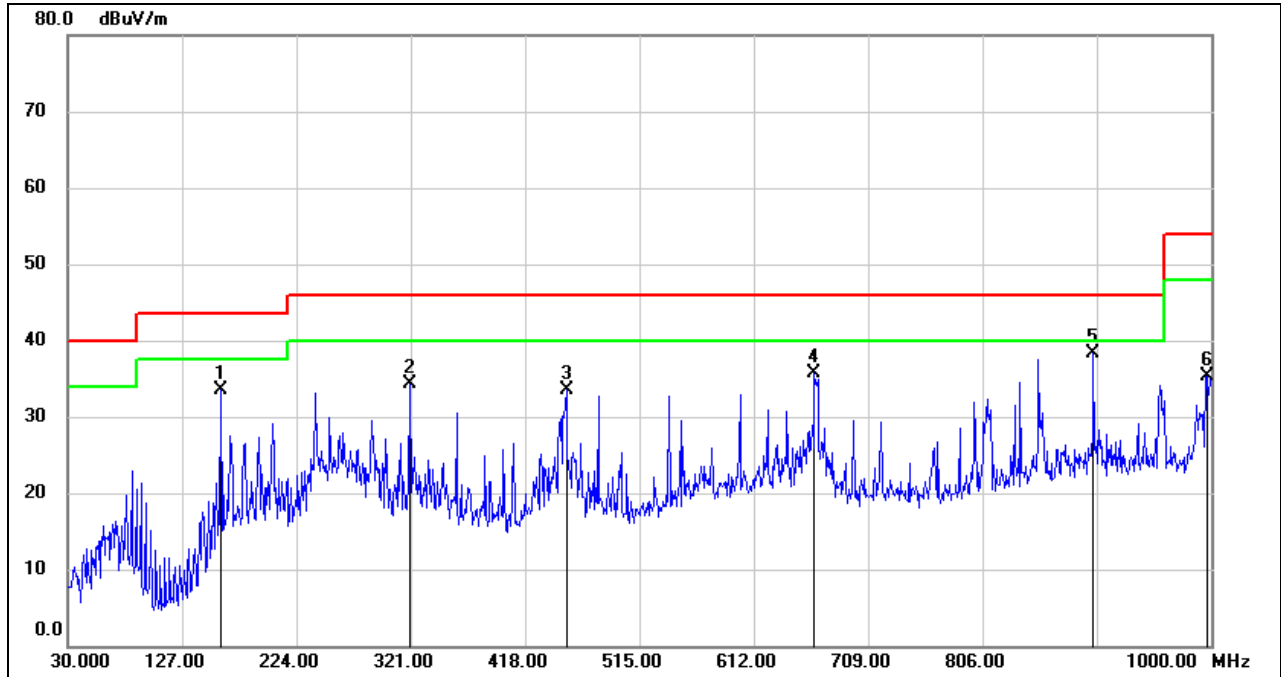

No.	Frequency (MHz)	Reading (dBuV)	Correct (dB/m)	Result (dBuV/m)	Limit (dBuV/m)	Margin (dB)	Remark
1	159.9800	50.97	-17.41	33.56	43.50	-9.94	QP
2	320.0300	47.61	-13.27	34.34	46.00	-11.66	QP
3	452.9200	44.63	-11.05	33.58	46.00	-12.42	QP
4	663.4099	42.61	-6.91	35.70	46.00	-10.30	QP
5	900.0900	41.97	-3.75	38.22	46.00	-7.78	QP
6	996.1200	38.27	-2.93	35.34	54.00	-18.66	QP

- Note: 1. Result Level = Read Level + Correct Factor.
 2. If Peak Result complies with QP limit, QP Result is deemed to comply with QP limit.
 3. Test setup: RBW: 120 kHz, VBW: 300 kHz, Sweep time: auto

Note: All the test modes have been tested, only the worst data record in the report.



9.6. SPURIOUS EMISSIONS BELOW 30M

9.6.1. 802.11g MODE

SPURIOUS EMISSIONS (HIGH CHANNEL, LOOP ANTENNA FACE ON TO THE EUT, WORST-CASE CONFIGURATION)

0.09kHz~ 150kHz

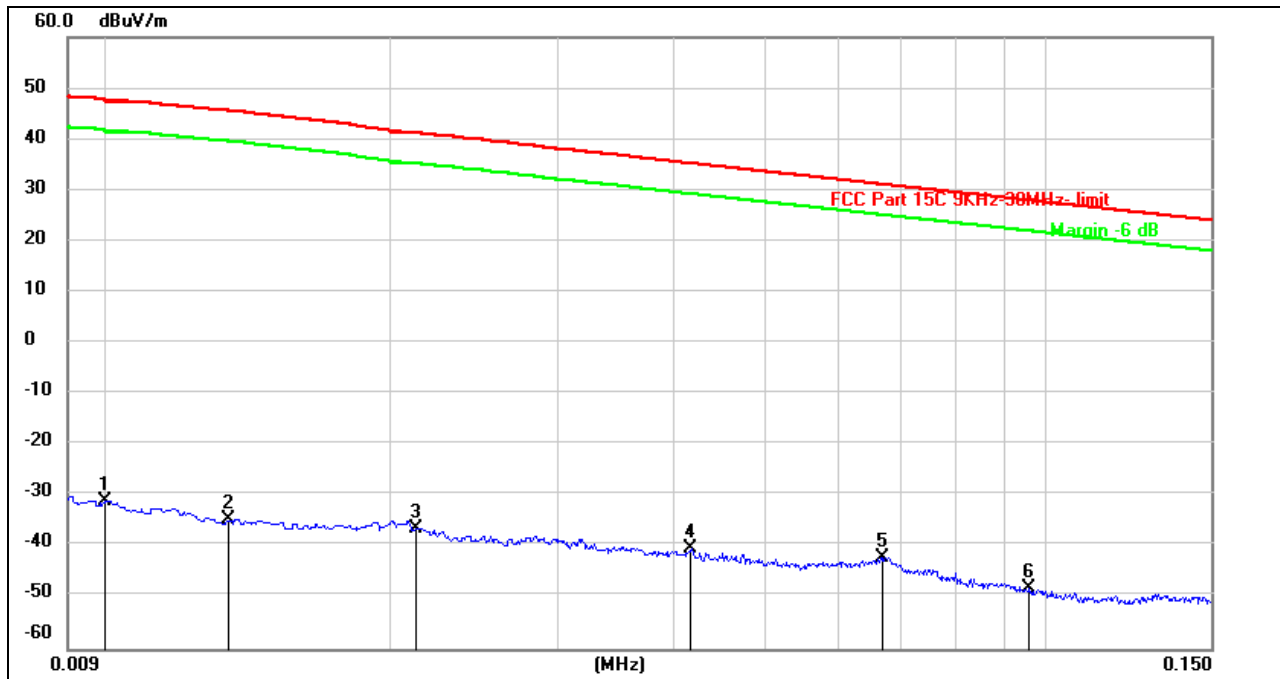

No.	Frequency (MHz)	Reading (dBuV)	Correct (dB/m)	Result (dBuV)	Limit (dBuV)	Margin (dB)	Remark
1	0.0100	70.22	-101.40	-31.18	47.60	-78.78	peak
2	0.0134	66.73	-101.39	-34.66	45.55	-80.21	peak
3	0.0212	65.04	-101.35	-36.31	41.16	-77.47	peak
4	0.0417	61.08	-101.44	-40.36	35.23	-75.59	peak
5	0.0666	59.43	-101.55	-42.12	31.16	-73.28	peak
6	0.0956	53.63	-101.76	-48.13	28.00	-76.13	peak

Note: 1. Measurement = Reading Level + Correct Factor.

2. If Peak Result complies with AV and QP limit, AV and QP Result are deemed to comply with AV limit.

3. All 3 polarizations(Horizontal, Face-on and Face-off) of the loop antenna had been tested, but only the worst data recorded in the report.



150kHz ~ 490kHz

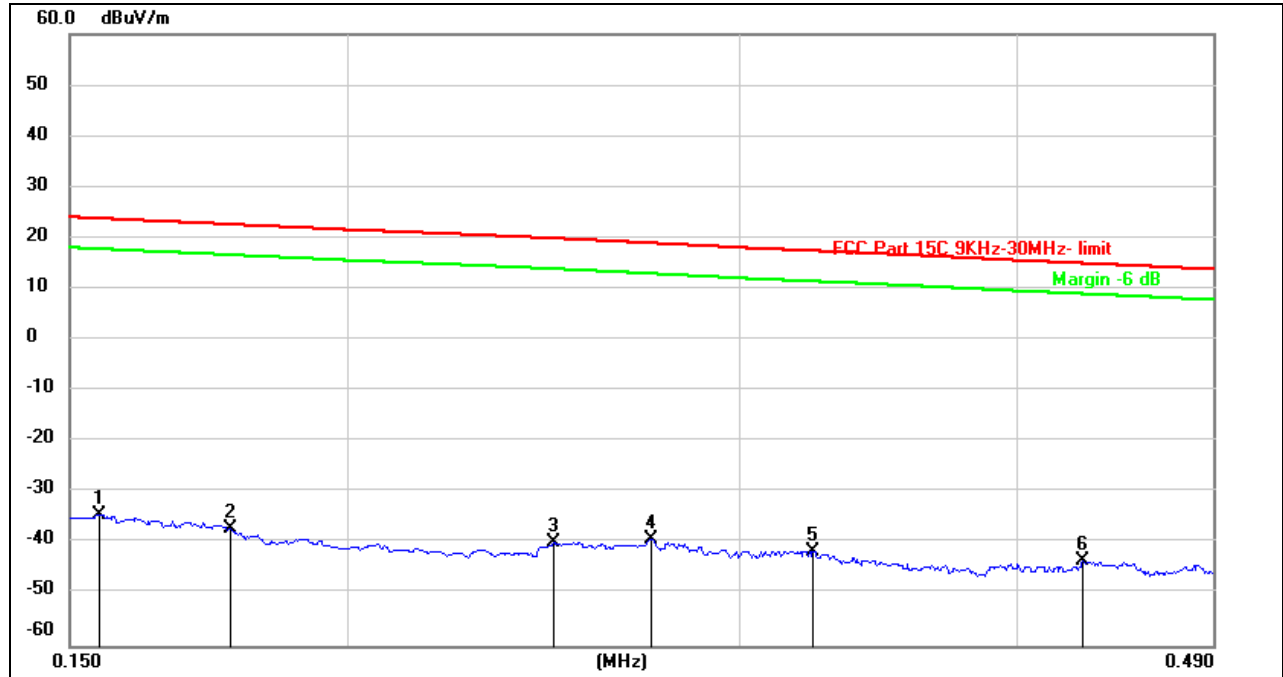

No.	Frequency (MHz)	Reading (dBuV)	Correct (dB/m)	Result (dBuV)	Limit (dBuV)	Margin (dB)	Remark
1	0.1547	67.31	-101.65	-34.34	23.82	-58.16	peak
2	0.1771	64.49	-101.68	-37.19	22.64	-59.83	peak
3	0.2474	61.94	-101.80	-39.86	19.91	-59.77	peak
4	0.2736	62.58	-101.83	-39.25	18.99	-58.24	peak
5	0.3243	60.30	-101.88	-41.58	17.45	-59.03	peak
6	0.4284	58.58	-101.99	-43.41	15.00	-58.41	peak

Note: 1. Measurement = Reading Level + Correct Factor.

2. If Peak Result complies with AV and QP limit, AV and QP Result are deemed to comply with AV limit.

3. All 3 polarizations(Horizontal, Face-on and Face-off) of the loop antenna had been tested, but only the worst data recorded in the report.



490kHz ~ 30MHz

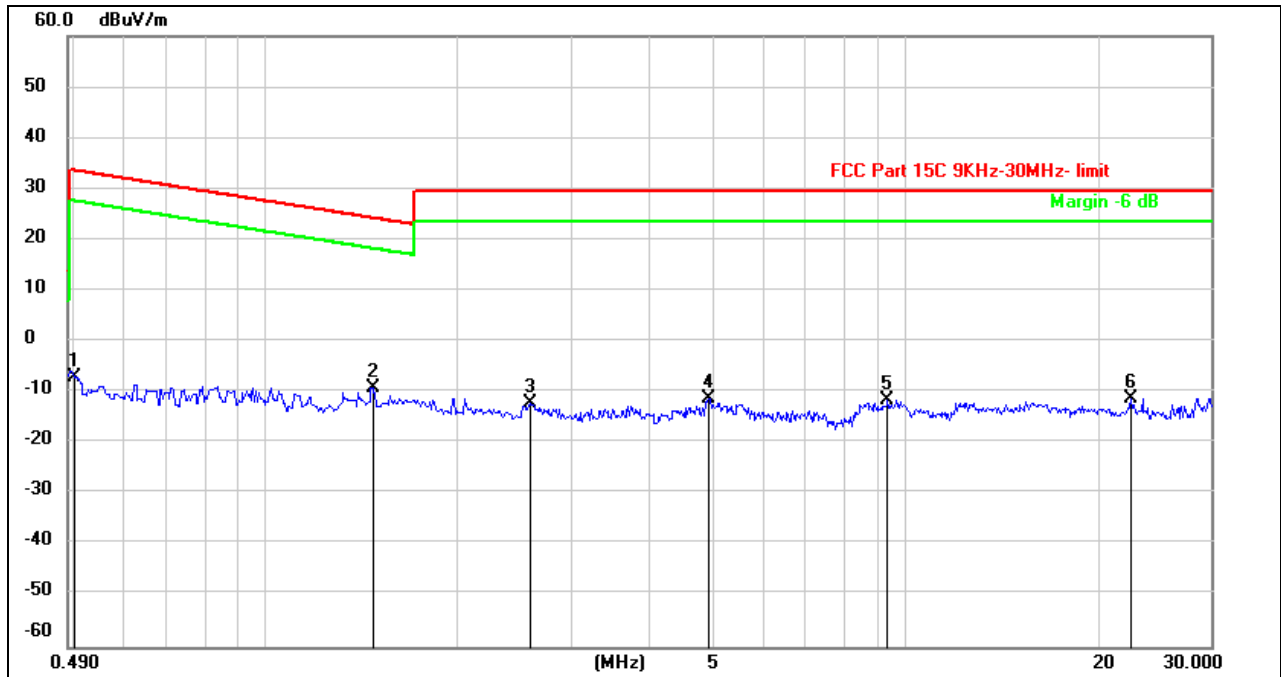

No.	Frequency (MHz)	Reading (dBuV)	Correct (dB/m)	Result (dBuV)	Limit (dBuV)	Margin (dB)	Remark
1	0.5039	54.94	-62.07	-7.13	33.58	-40.71	peak
2	1.4700	52.89	-62.05	-9.16	24.26	-33.42	peak
3	2.5935	49.61	-61.68	-12.07	29.54	-41.61	peak
4	4.9165	50.38	-61.48	-11.10	29.54	-40.64	peak
5	9.3725	49.38	-60.89	-11.51	29.54	-41.05	peak
6	22.5045	49.38	-60.64	-11.26	29.54	-40.80	peak

Note: 1. Measurement = Reading Level + Correct Factor.

2. If Peak Result complies with AV and QP limit, AV and QP Result are deemed to comply with AV limit.

3. All 3 polarizations(Horizontal, Face-on and Face-off) of the loop antenna had been tested, but only the worst data recorded in the report.

Note: All the test modes have been tested, only the worst data record in the report.

10. AC POWER LINE CONDUCTED EMISSIONS

LIMITS

Please refer to CFR 47 FCC §15.207 (a) and ISED RSS-Gen Clause 8.8

FREQUENCY (MHz)	Quasi-peak	Average
0.15 -0.5	66 - 56 *	56 - 46 *
0.50 -5.0	56.00	46.00
5.0 -30.0	60.00	50.00

TEST SETUP AND PROCEDURE

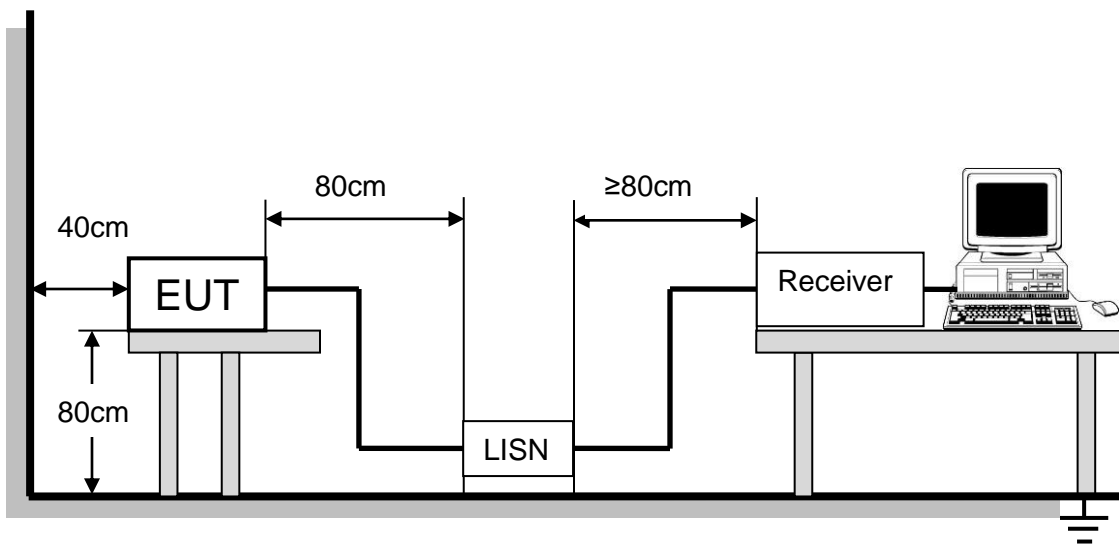

The EUT is put on a table of non-conducting material that is 80cm high. The vertical conducting wall of shielding is located 40cm to the rear of the EUT. The power line of the EUT is connected to the AC mains through an Artificial Mains Network (A.M.N.). A EMI Measurement Receiver (R&S Test Receiver ESR3) is used to test the emissions from both sides of AC line. According to the requirements in Section 6.2 of ANSI C63.10-2013. Conducted emissions from the EUT measured in the frequency range between 0.15 MHz and 30MHz using CISPR Quasi-Peak and average detector mode. The bandwidth of EMI test receiver is set at 9kHz.

The arrangement of the equipment is installed to meet the standards and operating in a manner, which tends to maximize its emission characteristics in a normal application.

TEST ENVIRONMENT

Temperature	23.0°C	Relative Humidity	60%
Atmosphere Pressure	101kPa	Test Voltage	AC 120V,60Hz



TEST RESULTS

10.1. 802.11g MODE

LINE N RESULTS (HIGH CHANNEL, WORST-CASE CONFIGURATION)

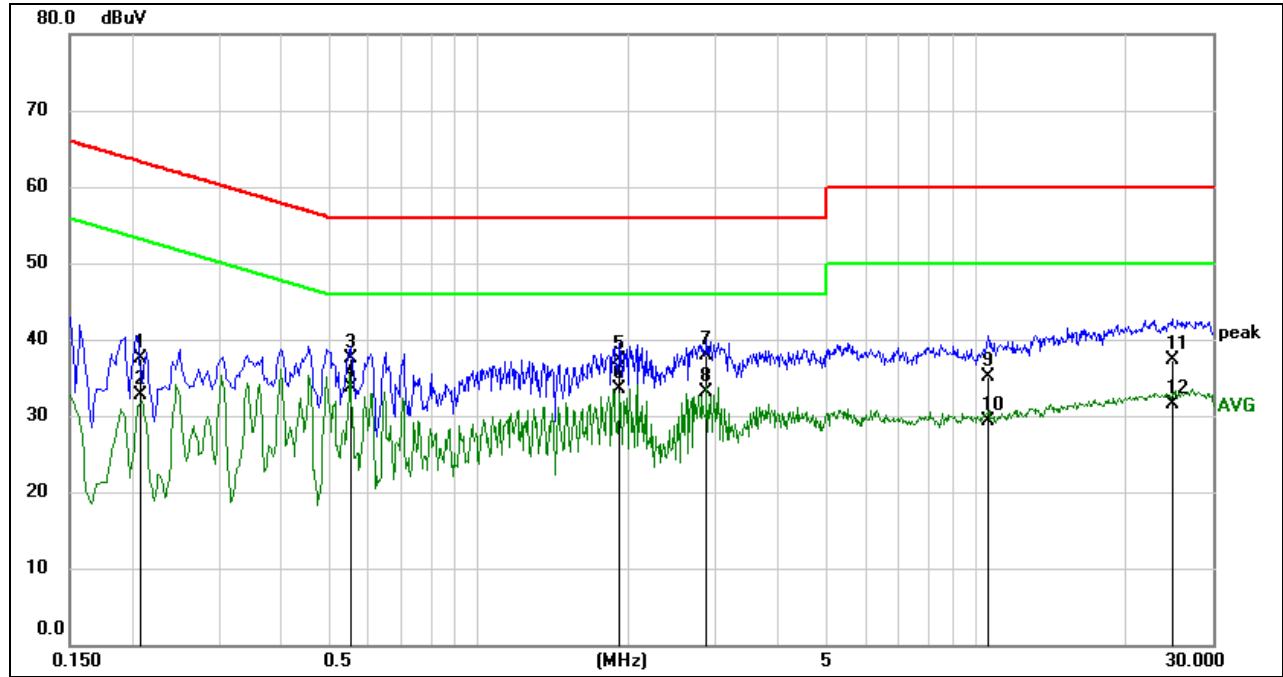

No.	Frequency (MHz)	Reading (dBuV)	Correct (dB)	Result (dBuV)	Limit (dBuV)	Margin (dB)	Remark
1	0.2084	27.94	9.60	37.54	63.27	-25.73	QP
2	0.2084	23.04	9.60	32.64	53.27	-20.63	AVG
3	0.5533	27.94	9.60	37.54	56.00	-18.46	QP
4	0.5533	24.03	9.60	33.63	46.00	-12.37	AVG
5	1.9201	27.75	9.63	37.38	56.00	-18.62	QP
6	1.9201	23.97	9.63	33.60	46.00	-12.40	AVG
7	2.8676	28.26	9.65	37.91	56.00	-18.09	QP
8	2.8676	23.39	9.65	33.04	46.00	-12.96	AVG
9	10.6125	25.31	9.77	35.08	60.00	-24.92	QP
10	10.6125	19.48	9.77	29.25	50.00	-20.75	AVG
11	24.7594	27.27	10.07	37.34	60.00	-22.66	QP
12	24.7594	21.52	10.07	31.59	50.00	-18.41	AVG

- Note: 1. Result = Reading +Correct Factor.
 2. If QP Result complies with AV limit, AV Result is deemed to comply with AV limit.
 3. Test setup: RBW: 200 Hz (9 kHz—150 kHz), 9 kHz (150 kHz—30 MHz).
 4. Step size: 80Hz (0.009MHz-0.15MHz), 4 kHz (0.15MHz-30MHz), Scan time: auto.



LINE L RESULTS (HIGH CHANNEL, WORST-CASE CONFIGURATION)

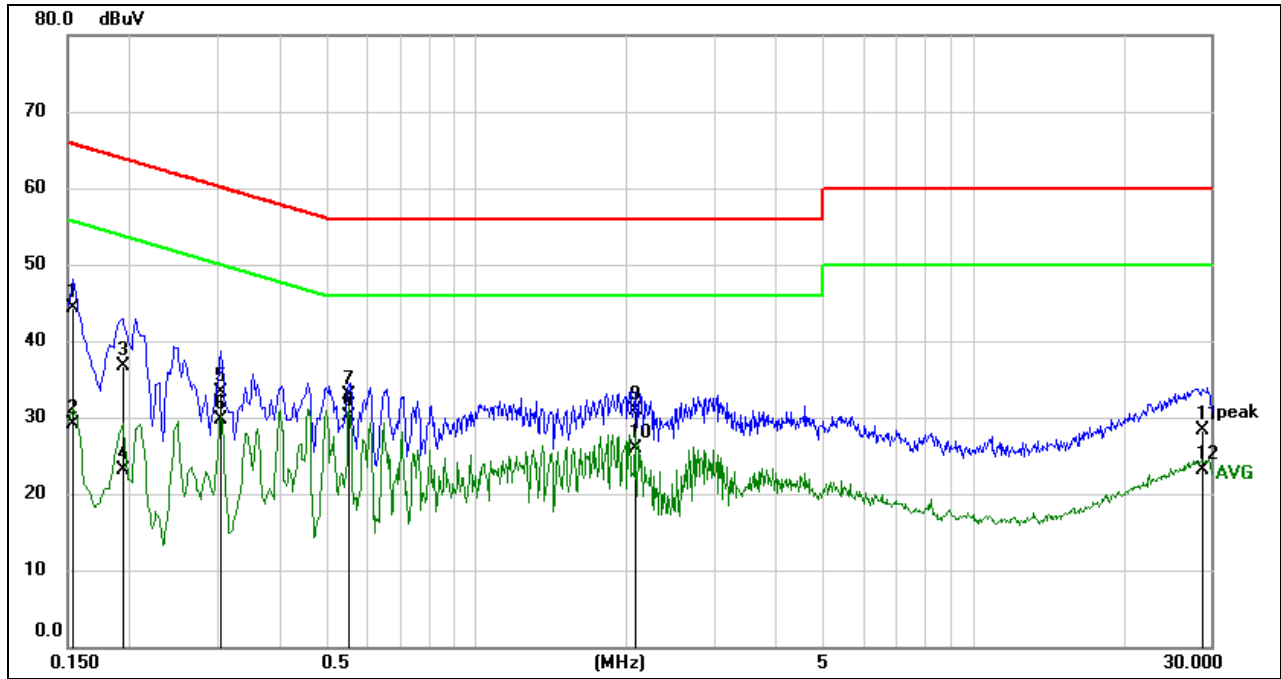

No.	Frequency (MHz)	Reading (dBuV)	Correct (dB)	Result (dBuV)	Limit (dBuV)	Margin (dB)	Remark
1	0.1527	34.69	9.61	44.30	65.85	-21.55	QP
2	0.1527	19.47	9.61	29.08	55.85	-26.77	AVG
3	0.1947	27.16	9.60	36.76	63.83	-27.07	QP
4	0.1947	13.51	9.60	23.11	53.83	-30.72	AVG
5	0.3042	23.77	9.60	33.37	60.13	-26.76	QP
6	0.3042	20.01	9.60	29.61	50.13	-20.52	AVG
7	0.5534	23.30	9.60	32.90	56.00	-23.10	QP
8	0.5534	20.48	9.60	30.08	46.00	-15.92	AVG
9	2.0779	21.35	9.62	30.97	56.00	-25.03	QP
10	2.0779	16.24	9.62	25.86	46.00	-20.14	AVG
11	28.8394	18.55	9.83	28.38	60.00	-31.62	QP
12	28.8394	13.19	9.83	23.02	50.00	-26.98	AVG

- Note: 1. Result = Reading +Correct Factor.
 2. If QP Result complies with AV limit, AV Result is deemed to comply with AV limit.
 3. Test setup: RBW: 200 Hz (9 kHz—150 kHz), 9 kHz (150 kHz—30 MHz).
 4. Step size: 80Hz (0.009MHz-0.15MHz), 4 kHz (0.15MHz-30MHz), Scan time: auto.

Note: All test modes have been tested, only the worst data record in the report.



11. ANTENNA REQUIREMENTS

APPLICABLE REQUIREMENTS

Please refer to FCC §15.203

An intentional radiator shall be designed to ensure that no antenna other than that furnished by the responsible party shall be used with the device. The use of a permanently attached antenna or of an antenna that uses a unique coupling to the intentional radiator shall be considered sufficient to comply with the provisions of this section. The manufacturer may design the unit so that a broken antenna can be replaced by the user, but the use of a standard antenna jack or electrical connector is prohibited.

Please refer to FCC §15.247(b)(4)

The conducted output power limit specified in paragraph (b) of this section is based on the use of antennas with directional gains that do not exceed 6 dBi. Except as shown in paragraph (c) of this section, if transmitting antennas of directional gain greater than 6 dBi are used, the conducted output power from the intentional radiator shall be reduced below the stated values in paragraphs (b)(1), (b)(2), and (b)(3) of this section, as appropriate, by the amount in dB that the directional gain of the antenna exceeds 6 dBi.

RESULTS

Complies

END OF REPORT