

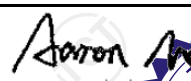

TEST REPORT

FCC ID. :	2AUCL-LD1001	
Test Report No..... :	TCT220222E909	
Date of issue..... :	Mar. 04, 2022	
Testing laboratory :	SHENZHEN TONGCE TESTING LAB	
Testing location/ address:	TCT Testing Industrial Park Fuqiao 5th Industrial Zone, Fuhai Street, Bao'an District Shenzhen, Guangdong, 518103, People's Republic of China	
Applicant's name..... :	FX Technology Limited	
Address..... :	2 Stone Buildings, Lincoln's Inn, London WC2A 3TH, United Kingdom	
Manufacturer's name ... :	Shenzhen Eternity Technology Co., Ltd	
Address..... :	Building A2, YingZhan Industrial Park, LongTian Street, PingShan, ShenZhen, China	
Standard(s) :	FCC CFR Title 47 Part 15 Subpart C Section 15.247 FCC KDB 558074 D01 15.247 Meas Guidance v05r02 ANSI C63.10:2013	
Test item description :	Linxdot Hotspot	
Trade Mark :	Linxdot	
Model/Type reference..... :	LD-1001	
Rating(s)..... :	Adapter Information: Model: TPQ-228F120200UW01 Input: AC 100-240V, 50/60Hz, 0.8A Output: DC 12.0V, 2.0A	
Date of receipt of test item :	Feb. 22, 2022	
Date (s) of performance of test..... :	Feb. 07, 2022 - Mar. 04, 2022	
Tested by (+signature) ... :	Aaron MO	
Check by (+signature).... :	Beryl ZHAO	
Approved by (+signature):	Tomsin	
Remark :	This test report was based on TCT220207E907; Only change internal photographs of EUT.	

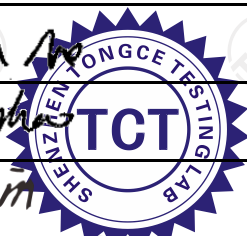

General disclaimer:

This report shall not be reproduced except in full, without the written approval of SHENZHEN TONGCE TESTING LAB. This document may be altered or revised by SHENZHEN TONGCE TESTING LAB personnel only, and shall be noted in the revision section of the document. The test results in the report only apply to the tested sample.

Table of Contents

1. General Product Information	3
1.1. EUT description	3
1.2. Model(s) list.....	3
1.3. Operation Frequency	3
2. Test Result Summary	4
3. General Information.....	5
3.1. Test environment and mode.....	5
3.2. Description of Support Units.....	5
4. Facilities and Accreditations	6
4.1. Facilities	6
4.2. Location	6
4.3. Measurement Uncertainty.....	6
5. Test Results and Measurement Data	7
5.1. Antenna requirement	7
5.2. Conducted Emission.....	8
5.3. Conducted Output Power	12
5.4. Emission Bandwidth	15
5.5. Power Spectral Density.....	18
5.6. Conducted Band Edge and Spurious Emission Measurement	21
5.7. Radiated Spurious Emission Measurement.....	24
Appendix A: Photographs of Test Setup	
Appendix B: Photographs of EUT	

1. General Product Information

1.1. EUT description

Test item description	Linxdot Hotspot
Model/Type reference.....	LD-1001
Sample Number.....	TCT220222E901-0101
Operation Frequency	500KHz: 923.3MHz~927.5MHz
Number of Channel	8 for DTS
Modulation Type	LoRa
Modulation Technology	Hybrid system
Antenna Type.....	External Antenna
Antenna Gain.....	2dBi
Rating(s).....	Adapter Information: Model: TPQ-228F120200UW01 Input: AC 100-240V, 50/60Hz, 0.8A Output: DC 12.0V, 2.0A

Note: The antenna gain listed in this report is provided by applicant, and the test laboratory is not responsible for this parameter.

1.2. Model(s) list

None.

1.3. Operation Frequency

500KHz for DTS

Channel	Frequency	Channel	Frequency	Channel	Frequency	Channel	Frequency
0	923.3MHz	2	924.5MHz	4	925.7MHz	6	926.9MHz
1	923.9MHz	3	925.1MHz	5	926.3MHz	7	927.5MHz

Remark: Channel 0&7 have been tested

2. Test Result Summary

Requirement	CFR 47 Section	Result
Antenna requirement	§15.203/§15.247 (c)	PASS
AC Power Line Conducted Emission	§15.207	PASS
Conducted Peak Output Power	§15.247 (b)(3)	PASS
6dB Emission Bandwidth	§15.247 (a)(2)	PASS
Power Spectral Density	§15.247 (e)	PASS
Band Edge	§15.247(d)	PASS
Spurious Emission	§15.205/§15.209	PASS

Note:

1. PASS: Test item meets the requirement.
2. Fail: Test item does not meet the requirement.
3. N/A: Test case does not apply to the test object.
4. The test result judgment is decided by the limit of test standard.
5. After pre-testing the two earphones, the two earphones are left and right ears respectively; we found that the left earphone is the worst case, so the results are recorded in this report.

3. General Information

3.1. Test environment and mode

Operating Environment:		
Condition	Conducted Emission	Radiated Emission
Temperature:	24.6 °C	23.2 °C
Humidity:	49 % RH	46 % RH
Atmospheric Pressure:	1010 mbar	1010 mbar
Test Mode:		
Engineering mode:	Keep the EUT in continuous transmitting by select channel and modulations	

The sample was placed 0.8m & 1.5m for the measurement below & above 1GHz above the ground plane of 3m chamber. Measurements in both horizontal and vertical polarities were performed. During the test, each emission was maximized by: having the EUT continuously working, investigated all operating modes, rotated about all 3 axis (X, Y & Z) and considered typical configuration to obtain worst position, manipulating interconnecting cables, rotating the turntable, varying antenna height from 1m to 4m in both horizontal and vertical polarizations. The emissions worst-case (Z axis) are shown in Test Results of the following pages.

3.2. Description of Support Units

The EUT has been tested as an independent unit together with other necessary accessories or support units. The following support units or accessories were used to form a representative test configuration during the tests.

Equipment	Model No.	Serial No.	FCC ID	Trade Name
/	/	/	/	/

Note:

1. All the equipment/cables were placed in the worst-case configuration to maximize the emission during the test.
2. Grounding was established in accordance with the manufacturer's requirements and conditions for the intended use.
3. For conducted measurements (Output Power, 6dB Emission Bandwidth, Power Spectral Density, Spurious Emissions), the antenna of EUT is connected to the test equipment via temporary antenna connector, the antenna connector is soldered on the antenna port of EUT, and the temporary antenna connector is listed in the Test Instruments.

4. Facilities and Accreditations

4.1. Facilities

The test facility is recognized, certified, or accredited by the following organizations:

- FCC - Registration No.: 645098
SHENZHEN TONGCE TESTING LAB
Designation Number: CN1205

The testing lab has been registered and fully described in a report with the (FCC) Federal Communications Commission. The acceptance letter from the FCC is maintained in our files.

- IC - Registration No.: 10668A-1
SHENZHEN TONGCE TESTING LAB
CAB identifier: CN0031

The testing lab has been registered by Certification and Engineering Bureau of Industry Canada for radio equipment testing.

4.2. Location

SHENZHEN TONGCE TESTING LAB

Address: TCT Testing Industrial Park, Fuqiao 5th Industrial Zone, Fuhai Street, Bao'an District, Shenzhen, Guangdong, 518103, People's Republic of China

TEL: +86-755-27673339

4.3. Measurement Uncertainty

The reported uncertainty of measurement $y \pm U$, where expanded uncertainty U is based on a standard uncertainty multiplied by a coverage factor of $k=2$, providing a level of confidence of approximately 95 %.

No.	Item	MU
1	Conducted Emission	± 3.10 dB
2	RF power, conducted	± 0.12 dB
3	Spurious emissions, conducted	± 0.11 dB
4	All emissions, radiated(<1 GHz)	± 4.56 dB
5	All emissions, radiated(1 GHz - 18 GHz)	± 4.22 dB
6	All emissions, radiated(18 GHz- 40 GHz)	± 4.36 dB

5. Test Results and Measurement Data

5.1. Antenna requirement

Standard requirement:	FCC Part15 C Section 15.203 /247(c)
<p>15.203 requirement: An intentional radiator shall be designed to ensure that no antenna other than that furnished by the responsible party shall be used with the device. The use of a permanently attached antenna or of an antenna that uses a unique coupling to the intentional radiator, the manufacturer may design the unit so that a broken antenna can be replaced by the user, but the use of a standard antenna jack or electrical connector is prohibited.</p> <p>15.247(c) (1)(i) requirement: (i) Systems operating in the 2400-2483.5 MHz band that is used exclusively for fixed. Point-to-point operations may employ transmitting antennas with directional gain greater than 6dBi provided the maximum conducted output power of the intentional radiator is reduced by 1 dB for every 3 dB that the directional gain of the antenna exceeds 6dBi.</p>	
E.U.T Antenna:	
<p>The antenna is external antenna which permanently attached, and the best case gain of the antenna is 2dBi.</p>	

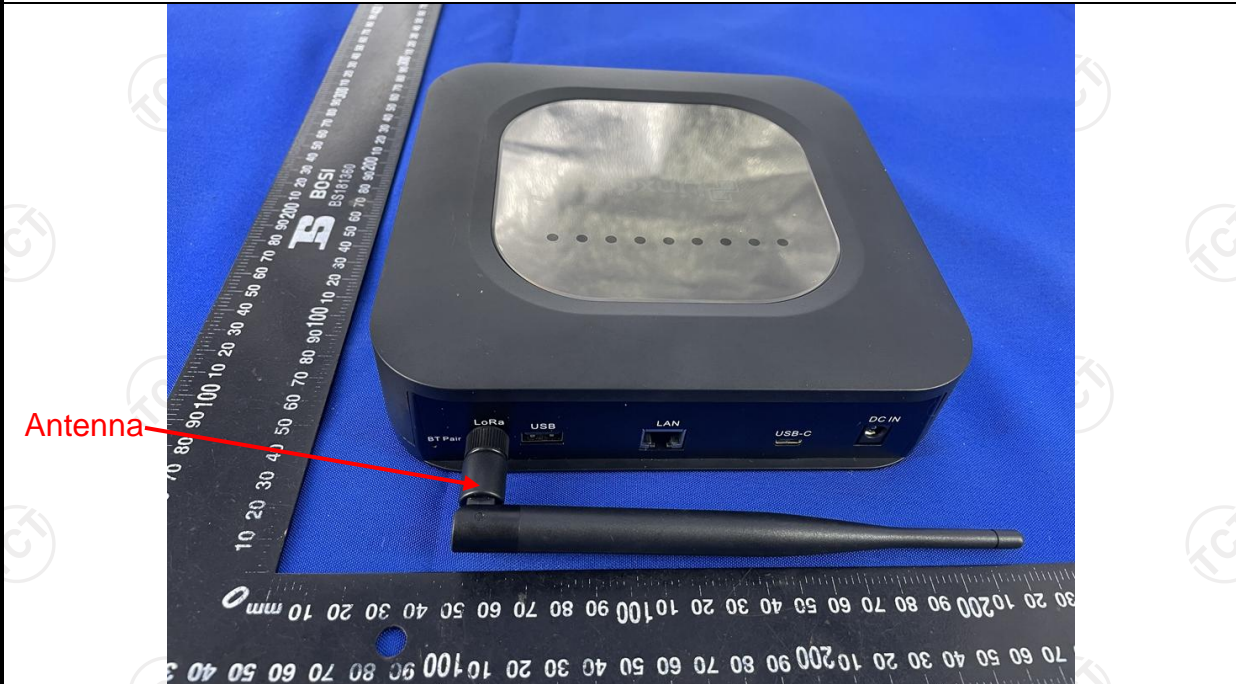

5.2. Conducted Emission

5.2.1. Test Specification

Test Requirement:	FCC Part15 C Section 15.207														
Test Method:	ANSI C63.10:2013														
Frequency Range:	150 kHz to 30 MHz														
Receiver setup:	RBW=9 kHz, VBW=30 kHz, Sweep time=auto														
Limits:	<table border="1"> <thead> <tr> <th rowspan="2">Frequency range (MHz)</th> <th colspan="2">Limit (dBuV)</th> </tr> <tr> <th>Quasi-peak</th> <th>Average</th> </tr> </thead> <tbody> <tr> <td>0.15-0.5</td> <td>66 to 56*</td> <td>56 to 46*</td> </tr> <tr> <td>0.5-5</td> <td>56</td> <td>46</td> </tr> <tr> <td>5-30</td> <td>60</td> <td>50</td> </tr> </tbody> </table>	Frequency range (MHz)	Limit (dBuV)		Quasi-peak	Average	0.15-0.5	66 to 56*	56 to 46*	0.5-5	56	46	5-30	60	50
Frequency range (MHz)	Limit (dBuV)														
	Quasi-peak	Average													
0.15-0.5	66 to 56*	56 to 46*													
0.5-5	56	46													
5-30	60	50													
Test Setup:	<p>Remark: E.U.T: Equipment Under Test LISN: Line Impedance Stabilization Network Test table height=0.8m</p>														
Test Mode:	Transmitting Mode														
Test Procedure:	<ol style="list-style-type: none"> 1. The E.U.T is connected to an adapter through a line impedance stabilization network (L.I.S.N.). This provides a 50ohm/50uH coupling impedance for the measuring equipment. 2. The peripheral devices are also connected to the main power through a LISN that provides a 50ohm/50uH coupling impedance with 50ohm termination. (Please refer to the block diagram of the test setup and photographs). 3. Both sides of A.C. line are checked for maximum conducted interference. In order to find the maximum emission, the relative positions of equipment and all of the interface cables must be changed according to ANSI C63.10: 2013 on conducted measurement. 														
Test Result:	PASS														

5.2.2. Test Instruments

Conducted Emission Shielding Room Test Site (843)				
Equipment	Manufacturer	Model	Serial Number	Calibration Due
EMI Test Receiver	R&S	ESCI3	100898	Jul. 07, 2022
Line Impedance Stabilisation Newtork(LISN)	Schwarzbeck	NSLK 8126	8126453	Mar. 11, 2022
Line-5	TCT	CE-05	N/A	Jul. 07, 2022
EMI Test Software	Shurple Technology	EZ-EMC	N/A	N/A

5.2.3. Test data

Please refer to following diagram for individual

Conducted Emission on Line Terminal of the power line (150 kHz to 30MHz)

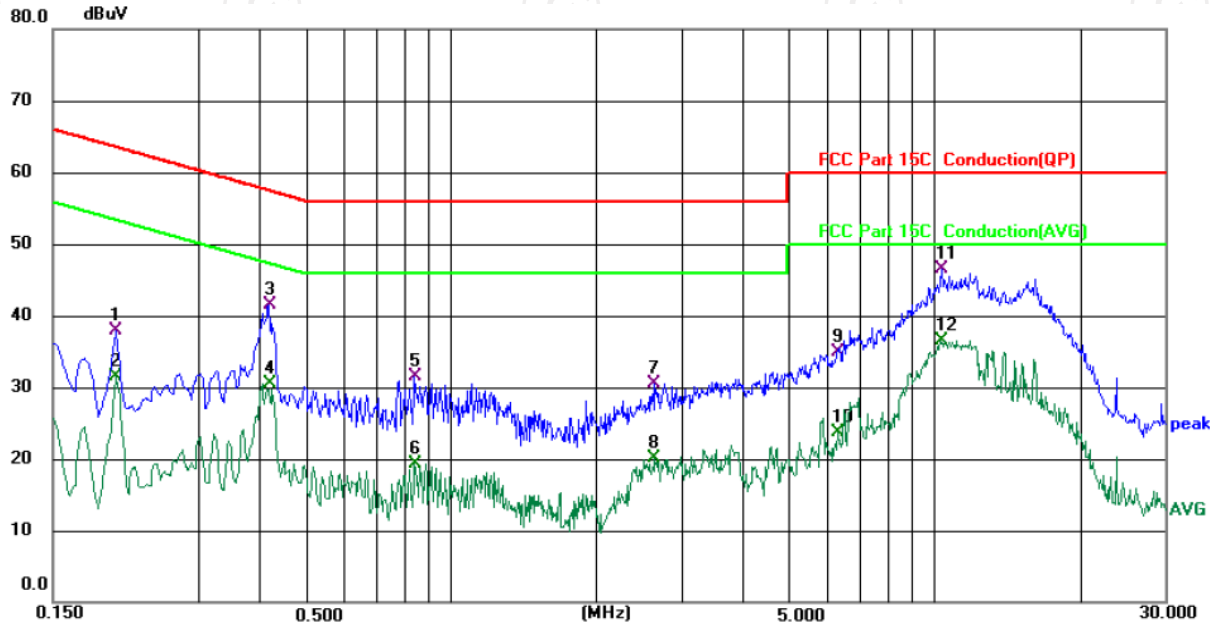

Site 844 Shielding Room

Phase: L1

Temperature: 24.6 (°C)

Humidity: 49 %

Limit: FCC Part 15C Conduction(QP)

Power: AC 120 V/60 Hz

No.	Mk.	Freq. MHz	Reading Level dBuV	Correct Factor dB	Measure- ment dBuV	Limit dBuV	Over dB	Detector	Comment
1		0.2020	28.26	9.58	37.84	63.53	-25.69	QP	
2		0.2020	21.98	9.58	31.56	53.53	-21.97	AVG	
3		0.4179	32.38	9.22	41.60	57.49	-15.89	QP	
4		0.4179	21.32	9.22	30.54	47.49	-16.95	AVG	
5		0.8419	22.23	9.25	31.48	56.00	-24.52	QP	
6		0.8419	10.07	9.25	19.32	46.00	-26.68	AVG	
7		2.6419	20.99	9.49	30.48	56.00	-25.52	QP	
8		2.6419	10.57	9.49	20.06	46.00	-25.94	AVG	
9		6.2859	25.30	9.56	34.86	60.00	-25.14	QP	
10		6.2859	14.07	9.56	23.63	50.00	-26.37	AVG	
11	*	10.3580	36.86	9.61	46.47	60.00	-13.53	QP	
12		10.3580	26.86	9.61	36.47	50.00	-13.53	AVG	

Note:

Freq. = Emission frequency in MHz

Reading level (dBuV) = Receiver reading

Corr. Factor (dB) = LISN factor + Cable loss

Measurement (dBuV) = Reading level (dBuV) + Corr. Factor (dB)

Limit (dBuV) = Limit stated in standard

Margin (dB) = Measurement (dBuV) – Limits (dBuV)

Q.P. =Quasi-Peak

AVG =average

* is meaning the worst frequency has been tested in the frequency range 150 kHz to 30MHz

Conducted Emission on Neutral Terminal of the power line (150 kHz to 30MHz)

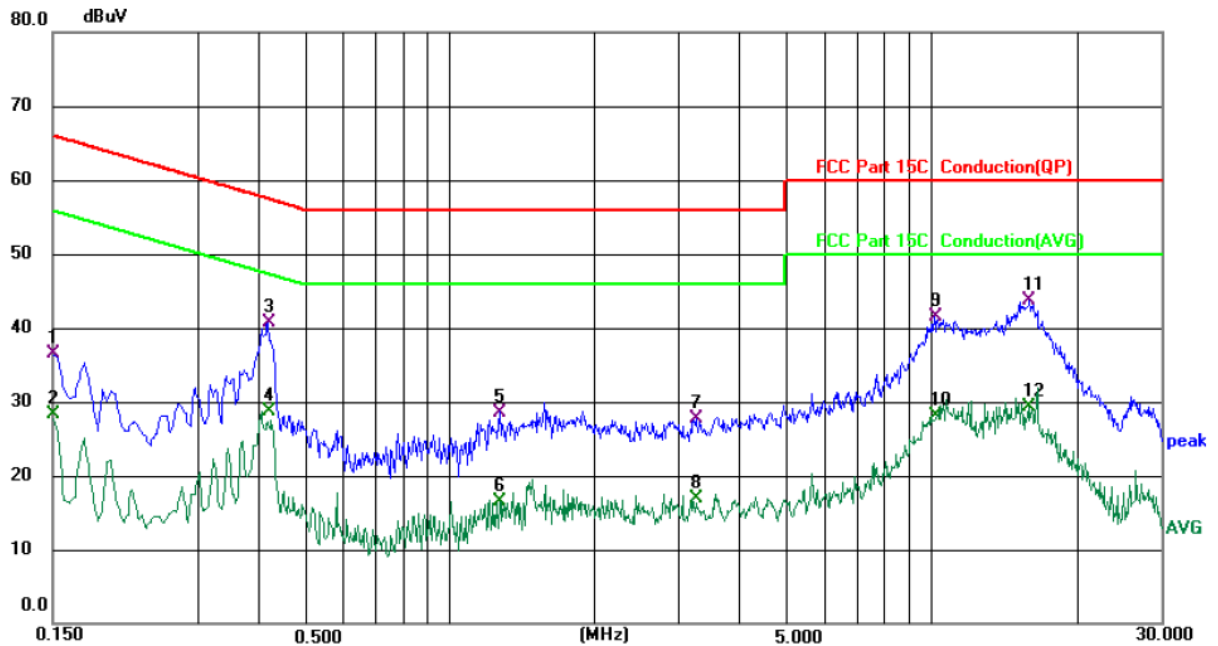

Site 844 Shielding Room Phase: **N** Temperature: 24.6 (°C) Humidity: 49 %

Limit: FCC Part 15C Conduction(QP)

Power: AC 120 V/60 Hz

No.	Mk.	Freq. MHz	Reading Level dBuV	Correct Factor dB	Measure- ment dBuV	Limit dBuV	Over dB	Detector	Comment
1		0.1500	26.92	9.61	36.53	66.00	-29.47	QP	
2		0.1500	18.72	9.61	28.33	56.00	-27.67	AVG	
3		0.4180	31.39	9.24	40.63	57.49	-16.86	QP	
4		0.4180	19.40	9.24	28.64	47.49	-18.85	AVG	
5		1.2740	19.27	9.33	28.60	56.00	-27.40	QP	
6		1.2740	7.17	9.33	16.50	46.00	-29.50	AVG	
7		3.2420	18.29	9.42	27.71	56.00	-28.29	QP	
8		3.2420	7.56	9.42	16.98	46.00	-29.02	AVG	
9		10.1580	31.85	9.62	41.47	60.00	-18.53	QP	
10		10.1580	18.54	9.62	28.16	50.00	-21.84	AVG	
11	*	16.0419	33.97	9.68	43.65	60.00	-16.35	QP	
12		16.0419	19.64	9.68	29.32	50.00	-20.68	AVG	

Note1:

Freq. = Emission frequency in MHz

Reading level (dBuV) = Receiver reading

Corr. Factor (dB) = LISN factor + Cable loss

Measurement (dBuV) = Reading level (dBuV) + Corr. Factor (dB)

Limit (dBuV) = Limit stated in standard

Margin (dB) = Measurement (dBuV) – Limits (dBuV)

Q.P. =Quasi-Peak AVG =average

* is meaning the worst frequency has been tested in the frequency range 150 kHz to 30MHz.

Note2:

Measurements were conducted in all two channels (high, low) and the worst case Mode (Lowest channel) was submitted only.

5.3. Conducted Output Power

5.3.1. Test Specification

Test Requirement:	FCC Part15 C Section 15.247 (b)(3)
Test Method:	KDB 558074 D01 v05r02
Limit:	For systems using digital modulation in the 902-928 MHz, 2400-2483.5 MHz, and 5725-5850 MHz bands: 1 Watt.
Test Setup:	 <p style="text-align: center;">Spectrum Analyzer EUT</p>
Test Mode:	Refer to item 3.1
Test Procedure:	<p>Set spectrum analyzer as following:</p> <ol style="list-style-type: none"> a) Set the RBW \geq DTS bandwidth. b) Set VBW $\geq 3 \times$ RBW. c) Set span $\geq 3 \times$ RBW d) Sweep time = auto couple. e) Detector = peak. f) Trace mode = max hold. g) Allow trace to fully stabilize. h) Use peak marker function to determine the peak amplitude level.
Test Result:	PASS

5.3.2. Test Instruments

Equipment	Manufacturer	Model	Serial Number	Calibration Due
Spectrum Analyzer	Agilent	N9020A	MY49100619	Jul. 18, 2022
RF cable (9kHz-26.5GHz)	TCT	RE-06	N/A	Jul. 18, 2022
Antenna Connector	TCT	RFC-01	N/A	Jul. 18, 2022

5.3.3. Test Data

For DTS

500KHz			
Test channel	Maximum Conducted Output Power (dBm)	Limit (dBm)	Result
Lowest	27.46	30.00	PASS
Highest	27.01	30.00	PASS

Test plots as follows:



500KHz

Lowest channel

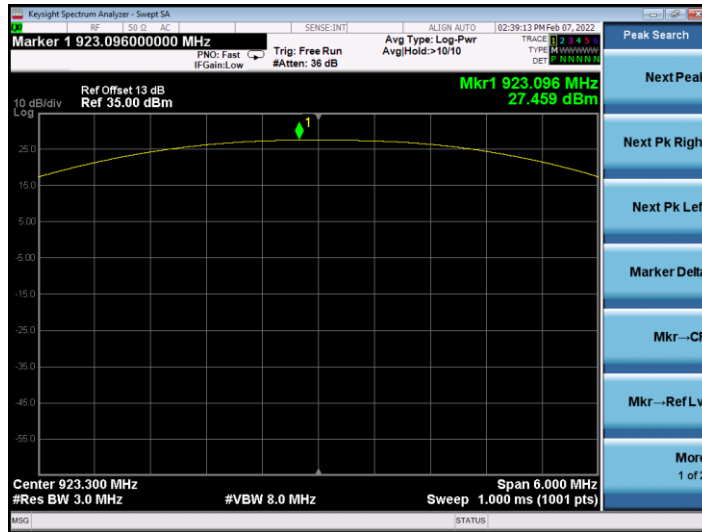

Highest channel

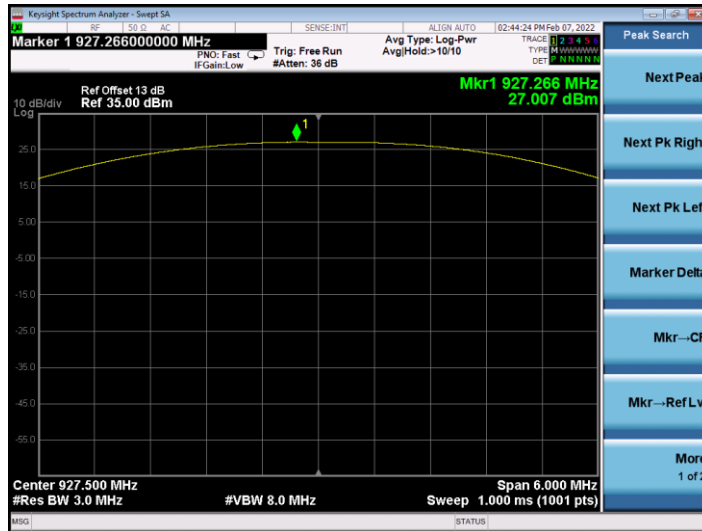

5.4. Emission Bandwidth

5.4.1. Test Specification

Test Requirement:	FCC Part15 C Section 15.247 (a)(2)
Test Method:	KDB 558074 D01 v05r02
Limit:	For digital modulation techniques may operate in the 902-928 MHz: The minimum 6 dB bandwidth shall be at least 500 kHz.
Test Setup:	 <p style="text-align: center;">Spectrum Analyzer EUT</p>
Test Mode:	Refer to item 3.1
Test Procedure:	<ol style="list-style-type: none"> 1. Set to the maximum power setting and enable the EUT transmit continuously. 2. Make the measurement with the spectrum analyzer's resolution bandwidth (RBW) = 100 kHz. Set the Video bandwidth (VBW) = 300 kHz. In order to make an accurate measurement. The 6dB bandwidth must be greater than 500 kHz. 3. Measure and record the results in the test report.
Test Result:	PASS

5.4.2. Test Instruments

RF Test Room				
Equipment	Manufacturer	Model	Serial Number	Calibration Due
Spectrum Analyzer	Agilent	N9020A	MY49100619	Jul. 18, 2022
RF cable (9kHz-26.5GHz)	TCT	RE-06	N/A	Jul. 18, 2022
Antenna Connector	TCT	RFC-01	N/A	Jul. 18, 2022

5.4.3. Test data

For DTS:

Test channel	6dB Emission Bandwidth (kHz)		
	500KHz	Limit	Result
Lowest	641.6	>500k	PASS
Highest	638.5	>500k	

Test plots as follows:



500KHz

Lowest channel

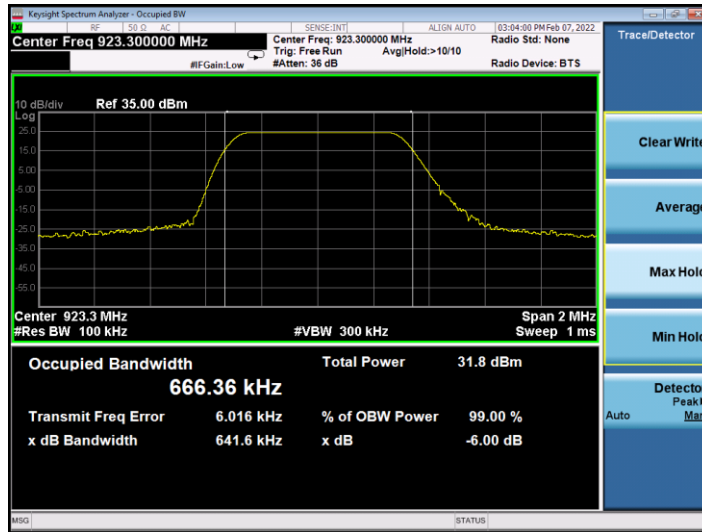

Highest channel



5.5.3. Test data

For DTS:

Test channel	Power Spectral Density (dBm/3kHz)		
	500KHz	Limit	Result
Lowest	7.43	8 dBm/3kHz	PASS
Highest	7.86	8 dBm/3kHz	

Test plots as follows:



500KHz

Lowest channel

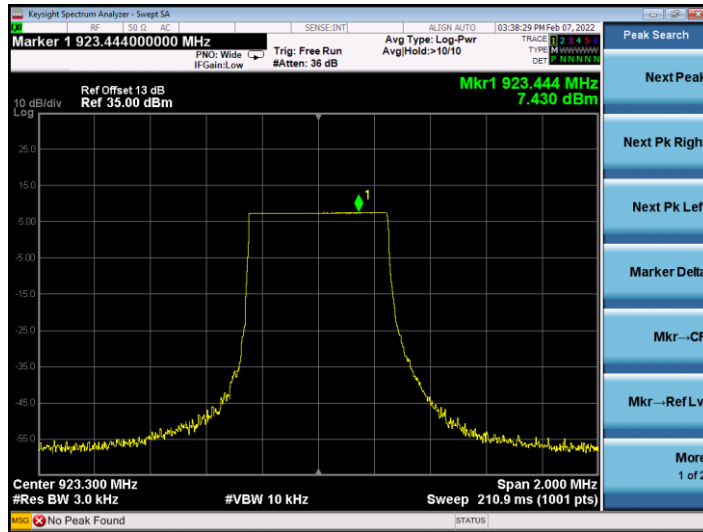

Highest channel

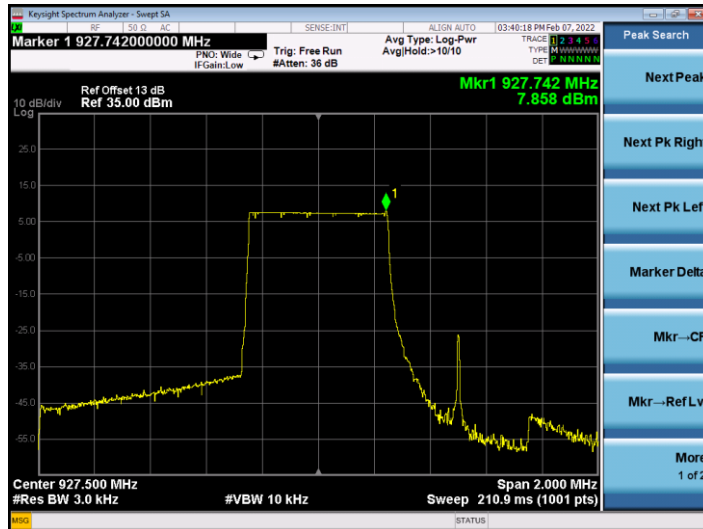

5.6. Conducted Band Edge and Spurious Emission Measurement

5.6.1. Test Specification

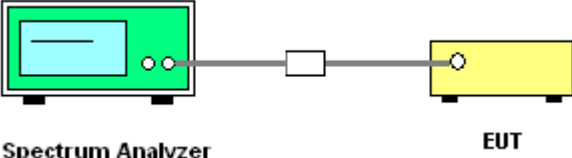
Test Requirement:	FCC Part15 C Section 15.247 (d)
Test Method:	KDB 558074 D01 v05r02
Limit:	In any 100 kHz bandwidth outside of the authorized frequency band, the emissions which fall in the non-restricted bands shall be attenuated at least 20 dB / 30dB relative to the maximum PSD level in 100 kHz by RF conducted measurement and radiated emissions which fall in the restricted bands, as defined in Section 15.205(a), must also comply with the radiated emission limits specified in Section 15.209(a).
Test Setup:	 <p style="text-align: center;">Spectrum Analyzer EUT</p>
Test Mode:	Refer to item 3.1
Test Procedure:	<ol style="list-style-type: none"> 1. The RF output of EUT was connected to the spectrum analyzer by RF cable and attenuator. The path loss was compensated to the results for each measurement. 2. Set to the maximum power setting and enable the EUT transmit continuously. 3. Set RBW = 100 kHz, VBW=300 kHz, Peak Detector. Unwanted Emissions measured in any 100 kHz bandwidth outside of the authorized frequency band shall be attenuated by at least 20 dB relative to the maximum in-band peak PSD level in 100 kHz when maximum peak conducted output power procedure is used. If the transmitter complies with the conducted power limits based on the use of RMS averaging over a time interval, the attenuation required under this paragraph shall be 30 dB instead of 20 dB per 15.247(d). 4. Measure and record the results in the test report. 5. The RF fundamental frequency should be excluded against the limit line in the operating frequency band.
Test Result:	PASS

5.6.2. Test Instruments

RF Test Room				
Equipment	Manufacturer	Model	Serial Number	Calibration Due
Spectrum Analyzer	Agilent	N9020A	MY49100619	Jul. 18, 2022
RF cable (9kHz-26.5GHz)	TCT	RE-06	N/A	Jul. 18, 2022
Antenna Connector	TCT	RFC-01	N/A	Jul. 18, 2022

5.6.3. Test Data

500KHz

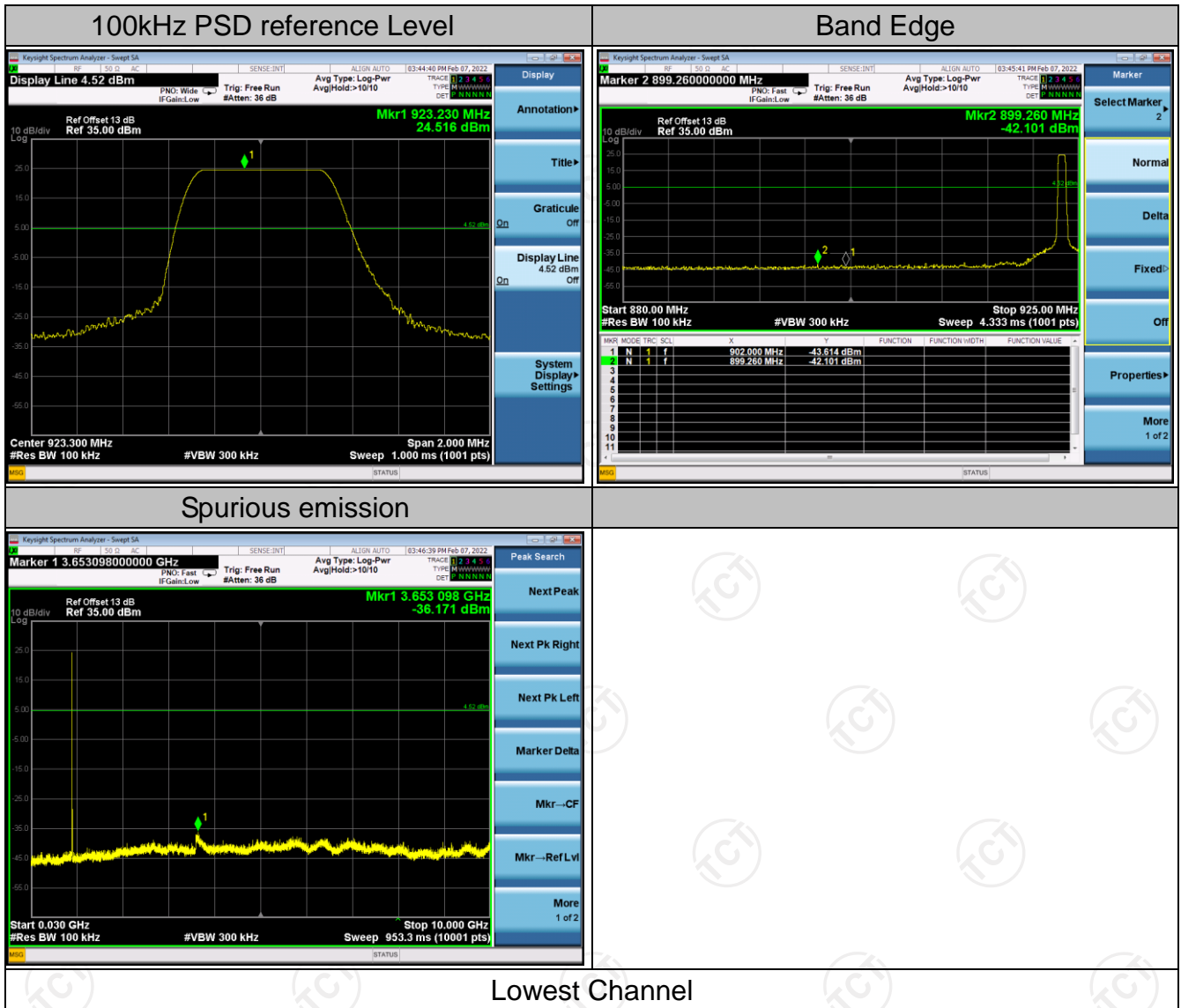

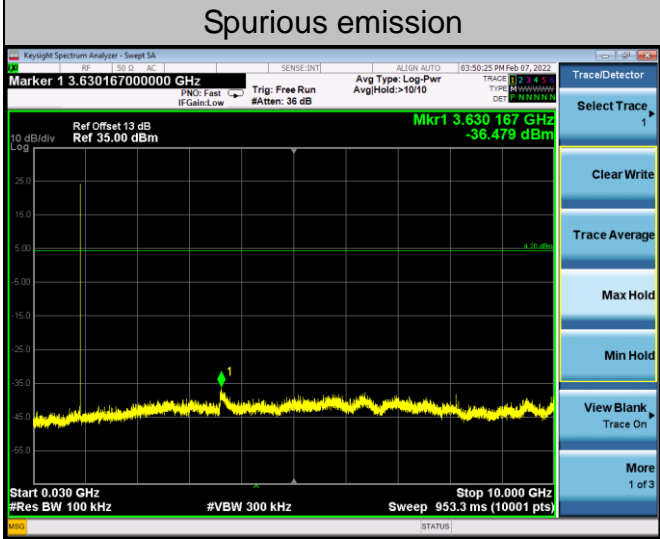
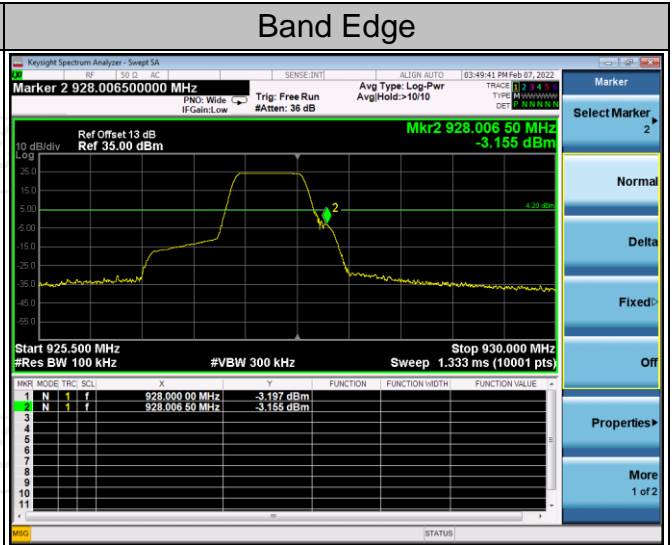
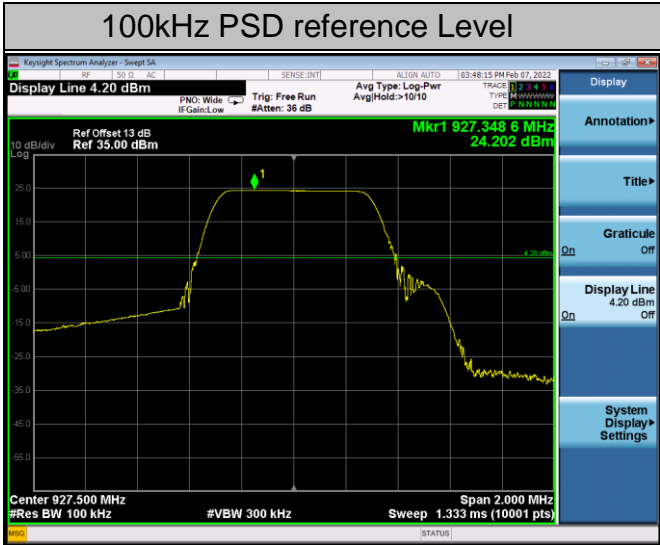

Highest Channel

5.7. Radiated Spurious Emission Measurement

5.7.1. Test Specification

Test Requirement:	FCC Part15 C Section 15.209					
Test Method:	ANSI C63.10: 2013					
Frequency Range:	9 kHz to 25 GHz					
Measurement Distance:	3 m					
Antenna Polarization:	Horizontal & Vertical					
Operation mode:	Refer to item 3.1					
Receiver Setup:	Frequency	Detector	RBW	VBW	Remark	
	9kHz- 150kHz	Quasi-peak	200Hz	1kHz	Quasi-peak Value	
	150kHz- 30MHz	Quasi-peak	9kHz	30kHz	Quasi-peak Value	
	30MHz-1GHz	Quasi-peak	120KHz	300KHz	Quasi-peak Value	
	Above 1GHz	Peak	1MHz	3MHz	Peak Value	
		Peak	1MHz	10Hz	Average Value	
Limit:	Frequency	Field Strength (microvolts/meter)	Measurement Distance (meters)			
	0.009-0.490	2400/F(KHz)	300			
	0.490-1.705	24000/F(KHz)	30			
	1.705-30	30	30			
	30-88	100	3			
	88-216	150	3			
	216-960	200	3			
	Above 960	500	3			
	Frequency	Field Strength (microvolts/meter)	Measurement Distance (meters)	Detector		
	Above 1GHz	500	3	Average		
	5000	3	Peak			
Test setup:	For radiated emissions below 30MHz					
	<p>30MHz to 1GHz</p>					

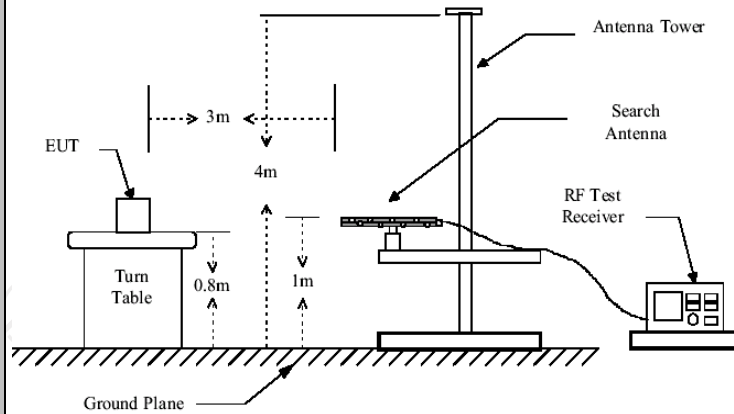

Above 1GHz

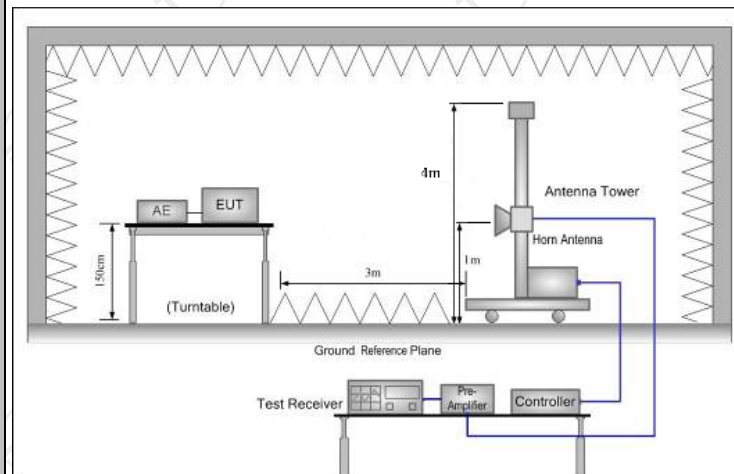

Test Procedure:

1. For the radiated emission test below 1GHz:
The EUT was placed on a turntable with 0.8 meter above ground. The EUT was set 3 meters from the interference receiving antenna, which was mounted on the top of a variable height antenna tower. The EUT was arranged to its worst case and then tune the antenna tower (from 1 m to 4 m) and turntable (from 0 degree to 360 degrees) to find the maximum reading. A pre-amp and a high PASS filter are used for the test in order to get better signal level.
- For the radiated emission test above 1GHz:
Place the measurement antenna on a turntable with 1.5 meter above ground, which is away from each area of the EUT determined to be a source of emissions at the specified measurement distance, while keeping the measurement antenna aimed at the source of emissions at each frequency of significant emissions, with polarization oriented for maximum response. The measurement antenna may have to be higher or lower than the EUT, depending on the radiation pattern of the emission and staying aimed at the emission source for receiving the maximum signal. The final

	<p>measurement antenna elevation shall be that which maximizes the emissions. The measurement antenna elevation for maximum emissions shall be restricted to a range of heights of from 1 m to 4 m above the ground or reference ground plane.</p> <p>2. Corrected Reading: Antenna Factor + Cable Loss + Read Level - Preamp Factor = Level</p> <p>3. For measurement below 1GHz, If the emission level of the EUT measured by the peak detector is 3 dB lower than the applicable limit, the peak emission level will be reported. Otherwise, the emission measurement will be repeated using the quasi-peak detector and reported.</p> <p>4. Use the following spectrum analyzer settings:</p> <p>(1) Span shall wide enough to fully capture the emission being measured;</p> <p>(2) Set RBW=120 kHz for $f < 1$ GHz; VBW \geq RBW; Sweep = auto; Detector function = peak; Trace = max hold;</p> <p>(3) Set RBW = 1 MHz, VBW= 3MHz for $f > 1$ GHz for peak measurement.</p> <p>For average measurement: VBW = 10 Hz, when duty cycle is no less than 98 percent. VBW $\geq 1/T$, when duty cycle is less than 98 percent where T is the minimum transmission duration over which the transmitter is on and is transmitting at its maximum power control level for the tested mode of operation.</p>
Test mode:	Refer to section 3.1 for details
Test results:	PASS

5.7.2. Test Instruments

Radiated Emission Test Site (966)				
Name of Equipment	Manufacturer	Model	Serial Number	Calibration Due
EMI Test Receiver	R&S	ESIB7	100197	Jul. 07, 2022
Spectrum Analyzer	R&S	FSQ40	200061	Jul. 07, 2022
Pre-amplifier	SKET	LNPA_0118G-45	SK2021012 102	Mar. 11, 2022
Pre-amplifier	SKET	LNPA_1840G-50	SK2021092 03500	Apr. 08, 2022
Pre-amplifier	HP	8447D	2727A05017	Jul. 07, 2022
Loop antenna	ZHINAN	ZN30900A	12024	Sep. 05, 2022
Broadband Antenna	Schwarzbeck	VULB9163	340	Sep. 04, 2022
Horn Antenna	Schwarzbeck	BBHA 9120D	631	Sep. 04, 2022
Horn Antenna	Schwarzbeck	BBHA 9170	00956	Apr. 10, 2023
Antenna Mast	Keleto	RE-AM	N/A	N/A
Coaxial cable	SKET	RC_DC18G-N	N/A	Apr. 08, 2022
Coaxial cable	SKET	RC-DC18G-N	N/A	Apr. 08, 2022
Coaxial cable	SKET	RC-DC40G-N	N/A	Jul. 07, 2022
EMI Test Software	Shurple Technology	EZ-EMC	N/A	N/A

5.7.3. Test Data

Please refer to following diagram for individual

Below 1GHz

Horizontal:

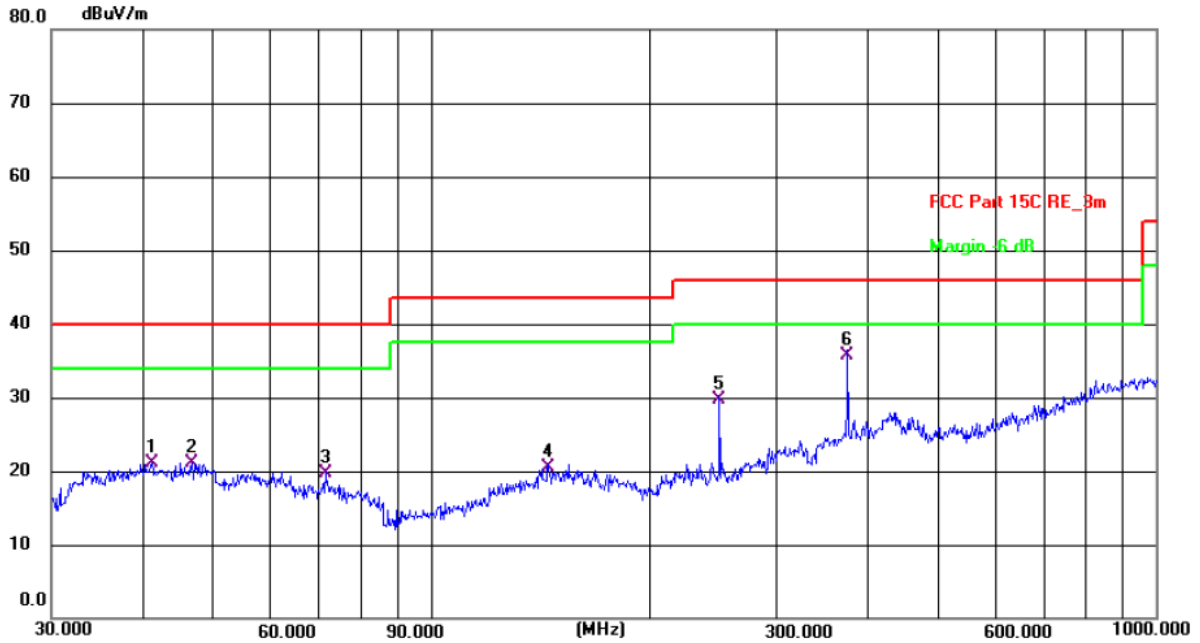

Site #2 3m Anechoic Chamber

Polarization: *Horizontal*

Temperature: 23.2(C)

Humidity: 46 %

Limit: FCC Part 15C RE_3m

Power: AC 120 V/60 Hz

No.	Frequency (MHz)	Reading (dBuV)	Factor (dB/m)	Level (dBuV/m)	Limit (dBuV/m)	Margin (dB)	Detector	P/F	Remark
1	41.2764	7.09	13.98	21.07	40.00	-18.93	QP	P	
2	46.8301	7.30	13.85	21.15	40.00	-18.85	QP	P	
3	71.5805	8.98	10.82	19.80	40.00	-20.20	QP	P	
4	145.3505	7.21	13.29	20.50	43.50	-23.00	QP	P	
5	250.3009	17.04	12.66	29.70	46.00	-16.30	QP	P	
6 *	375.9384	19.38	16.42	35.80	46.00	-10.20	QP	P	

Vertical:

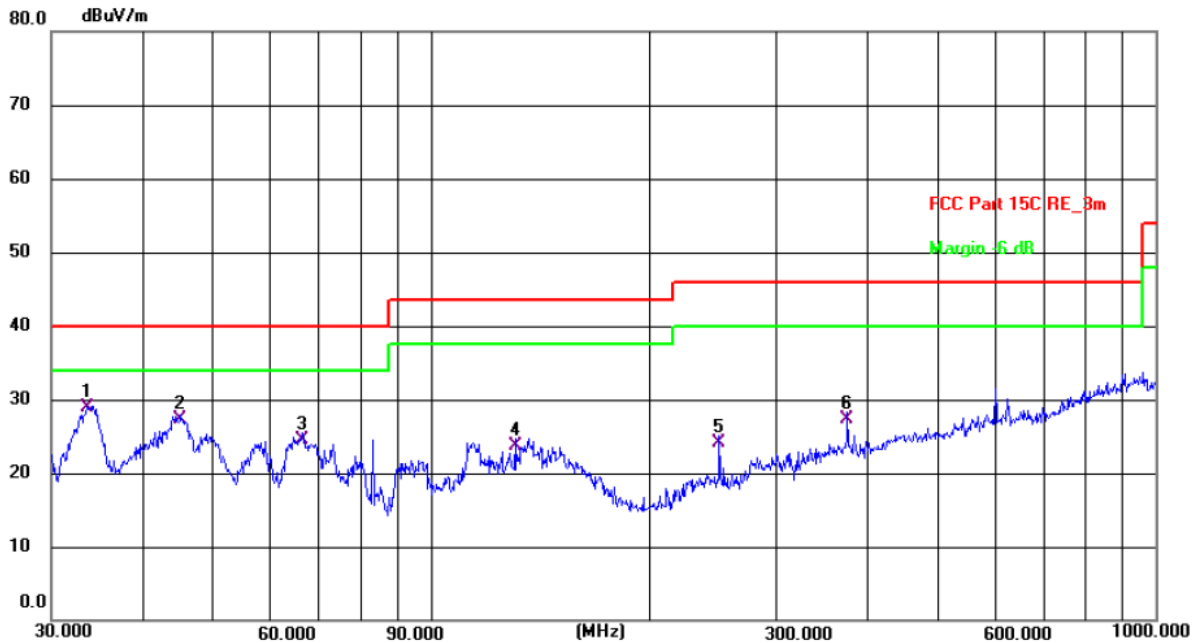

Site #2 3m Anechoic Chamber

Polarization: **Vertical**

Temperature: 23.2(C)

Humidity: 46 %

Limit: FCC Part 15C RE_3m

Power: AC 120 V/60 Hz

No.	Frequency (MHz)	Reading (dBuV)	Factor (dB/m)	Level (dBuV/m)	Limit (dBuV/m)	Margin (dB)	Detector	P/F	Remark
1 *	33.5623	16.08	12.82	28.90	40.00	-11.10	QP	P	
2	45.2165	13.52	13.88	27.40	40.00	-12.60	QP	P	
3	66.4989	12.78	11.82	24.60	40.00	-15.40	QP	P	
4	130.8369	11.15	12.65	23.80	43.50	-19.70	QP	P	
5	250.3009	11.54	12.66	24.20	46.00	-21.80	QP	P	
6	375.9384	10.98	16.42	27.40	46.00	-18.60	QP	P	

Note: 1. The low frequency, which started from 9KHz~30MHz, was pre-scanned and the result which was 20dB lower than the limit line per 15.31(o) was not reported

2. Measurements were conducted in all three channels (high, low), and the worst case Mode (Lowest channel) was submitted only.

3. Freq. = Emission frequency in MHz

Measurement (dBuV/m) = Reading level (dBuV) + Corr. Factor (dB)

Correction Factor = Antenna Factor + Cable loss – Pre-amplifier

Limit (dBuV/m) = Limit stated in standard

Margin (dB) = Measurement (dBuV/m) – Limits (dBuV/m)

* is meaning the worst frequency has been tested in the test frequency range

Test Result of Radiated Spurious at Band edges

Lowest channel 923.3:

Horizontal:

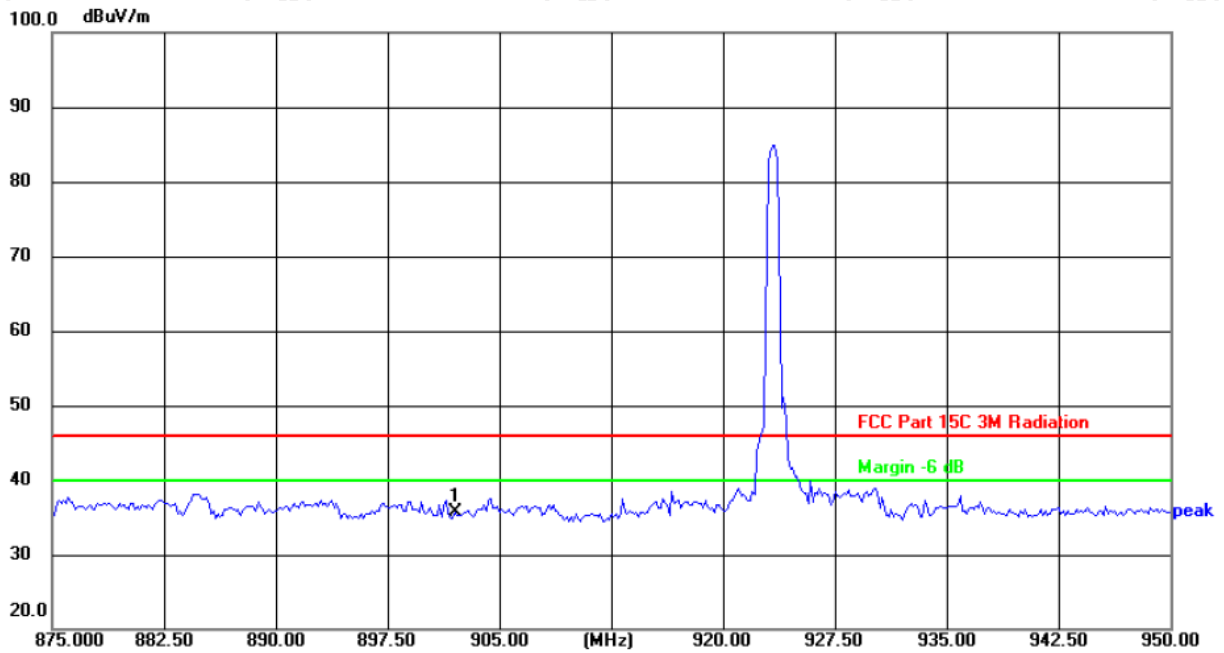

Site: Polarization: *Horizontal* Temperature: 25(°C)
Limit: FCC Part 15C 3M Radiation Power: Humidity: 55 %

No.	Frequency (MHz)	Reading (dBuV)	Factor (dB/m)	Level (dBuV/m)	Limit (dBuV/m)	Margin (dB)	Detector
1 *	902.0000	33.84	1.86	35.70	46.00	-10.30	peak

Vertical:

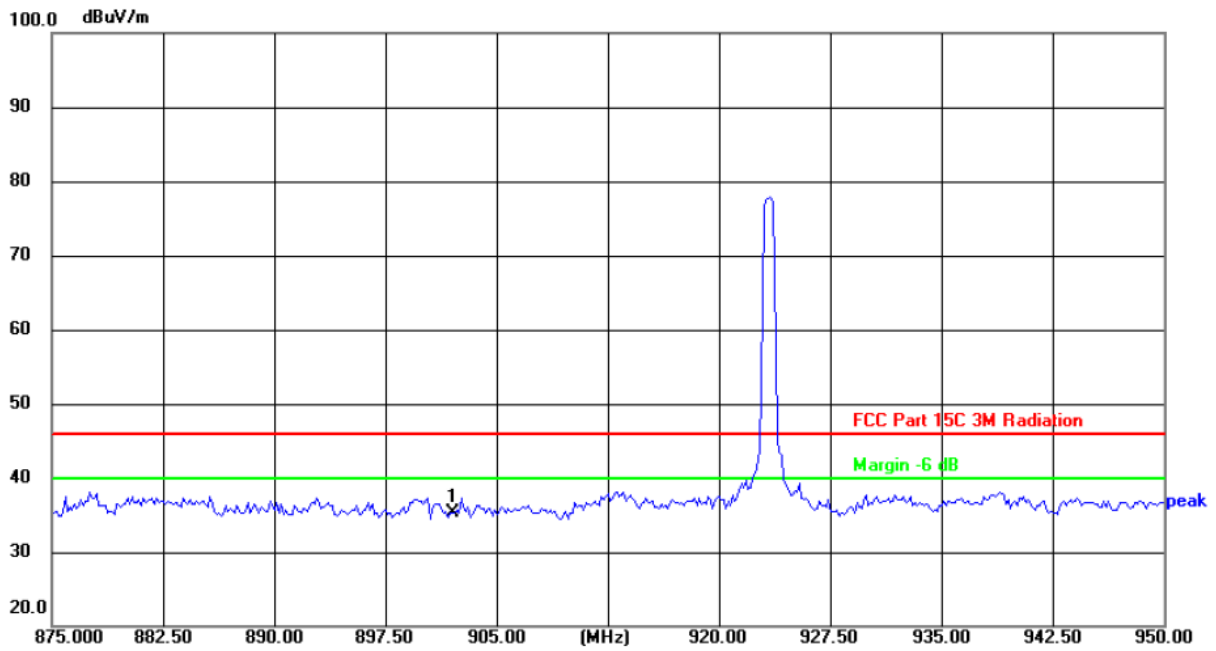

Site: Polarization: **Vertical** Temperature: 25(°C)
 Limit: FCC Part 15C 3M Radiation Power: Humidity: 55 %

No.	Frequency (MHz)	Reading (dBuV)	Factor (dB/m)	Level (dBuV/m)	Limit (dBuV/m)	Margin (dB)	Detector
1 *	902.0000	33.49	1.86	35.35	46.00	-10.65	peak



Highest channel 927.5:

Horizontal:

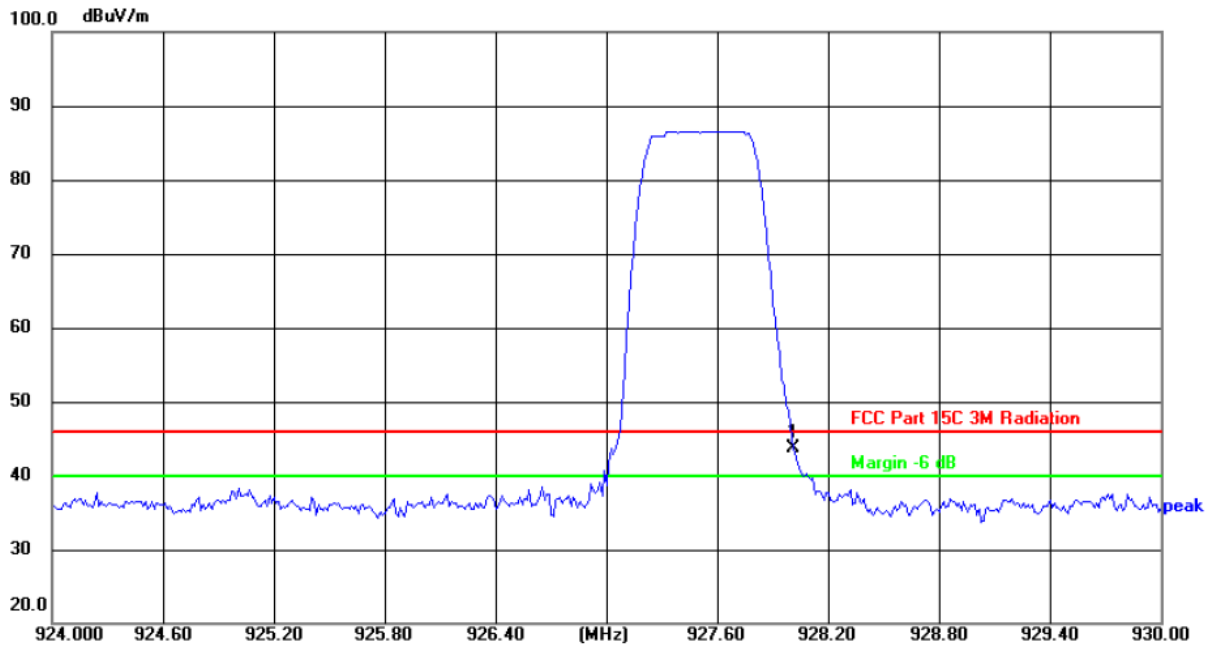

Site: Polarization: *Horizontal* Temperature: 25(°C)
 Limit: FCC Part 15C 3M Radiation Power: Humidity: 55 %

No.	Frequency (MHz)	Reading (dBuV)	Factor (dB/m)	Level (dBuV/m)	Limit (dBuV/m)	Margin (dB)	Detector
1 *	928.0000	41.88	1.88	43.76	46.00	-2.24	peak

Vertical:

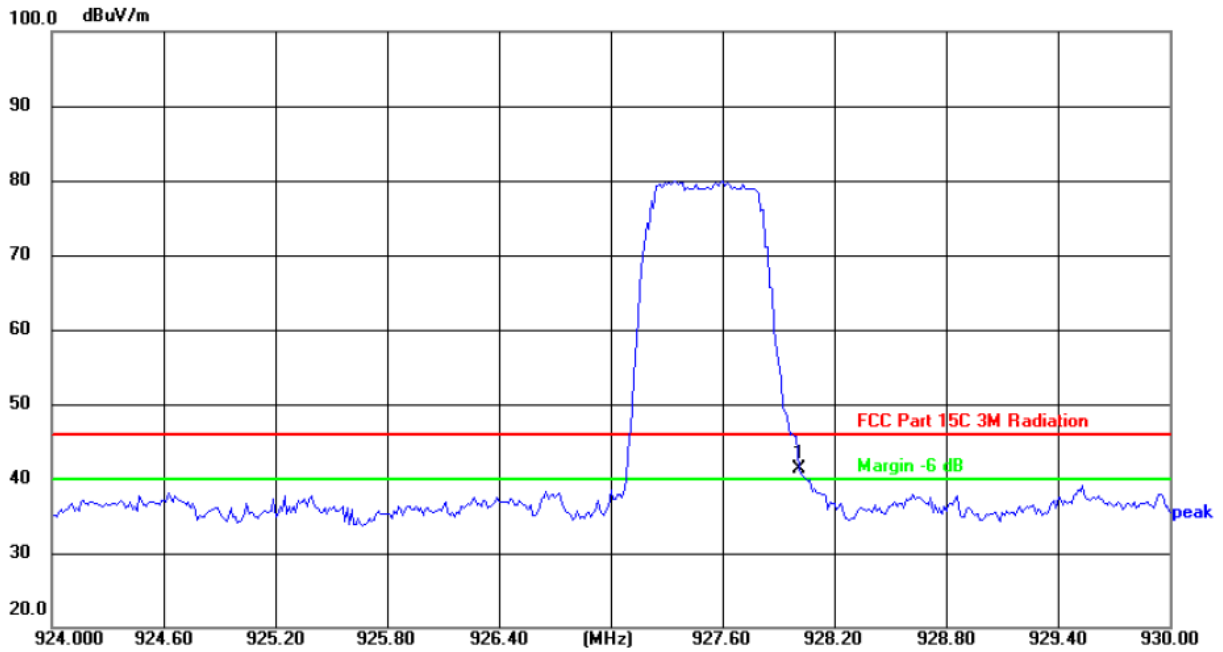

Site: Polarization: **Vertical** Temperature: 25(°C)
 Limit: FCC Part 15C 3M Radiation Power: Humidity: 55 %

No.	Frequency (MHz)	Reading (dBuV)	Factor (dB/m)	Level (dBuV/m)	Limit (dBuV/m)	Margin (dB)	Detector
1 *	928.0000	39.33	1.88	41.21	46.00	-4.79	peak



Above 1GHz

500KHz

Low channel: 923.3 MHz

Frequency (MHz)	Ant. Pol. H/V	Peak reading (dB μ V)	AV reading (dB μ V)	Correction Factor (dB/m)	Emission Level		Peak limit (dB μ V/m)	AV limit (dB μ V/m)	Margin (dB)
					Peak (dB μ V/m)	AV (dB μ V/m)			
1846.6	H	47.02	---	0.66	47.68	---	74	54	-6.32
2769.9	H	37.84	---	9.50	47.34	---	74	54	-6.66
---	H	---	---	---	---	---	---	---	---
1846.6	V	47.30	---	0.66	47.96	---	74	54	-6.04
2769.9	V	36.77	---	9.50	46.27	---	74	54	-7.73
---	V	---	---	---	---	---	---	---	---

High channel: 927.5 MHz

Frequency (MHz)	Ant. Pol. H/V	Peak reading (dB μ V)	AV reading (dB μ V)	Correction Factor (dB/m)	Emission Level		Peak limit (dB μ V/m)	AV limit (dB μ V/m)	Margin (dB)
					Peak (dB μ V/m)	AV (dB μ V/m)			
1855.0	H	47.41	---	1.33	48.74	---	74	54	-5.26
2782.5	H	36.85	---	10.22	47.07	---	74	54	-6.93
---	H	---	---	---	---	---	---	---	---
1855.0	V	45.21	---	1.33	46.54	---	74	54	-7.46
2782.5	V	34.09	---	10.22	44.31	---	74	54	-9.69
---	V	---	---	---	---	---	---	---	---

Note:

1. Emission Level=Peak Reading + Correction Factor; Correction Factor= Antenna Factor + Cable loss – Pre-amplifier
2. Margin (dB) = Emission Level (Peak) (dB μ V/m)-Average limit (dB μ V/m)
3. The emission levels of other frequencies are very lower than the limit and not show in test report.
4. Measurements were conducted from 1 GHz to the 10th harmonic of highest fundamental frequency.
5. Data of measurement shown "—" in the above table mean that the reading of emissions is attenuated more than 20 dB below the limits or the field strength is too small to be measured.
6. All the restriction bands are compliance with the limit of 15.209.

Appendix A: Photographs of Test Setup

Refer to the Appendix

Appendix B: Photographs of EUT

Refer to the Appendix

*******END OF REPORT*******