



# Antenna Test Report



报告日期: 2023年7月6日星期四



天线设计频段:

antenna design  
spectrum

5G

天线类型:

Type of antenna

PIFA

报告版本:

Report version

日期

Date

内容

Content

V1.0

2023.03.25

天线有源测试报告

V2.0

2023.05.06

试产机天线有源测试报告

V3.0

2023.05.22

换屏-天线有源测试报告

V4.0

2023.05.26

换屏-天线测试报告(更新最终匹配)

V5.0

2023.07.06

天线有源测试报告(增加无源)

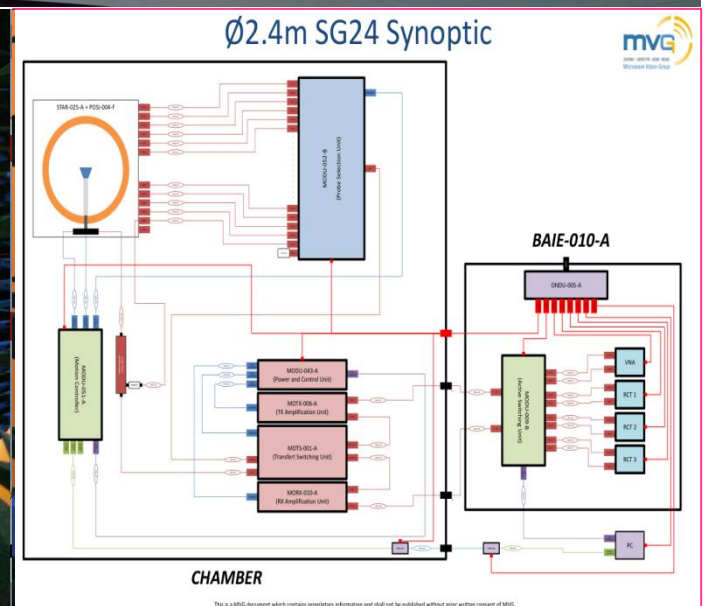
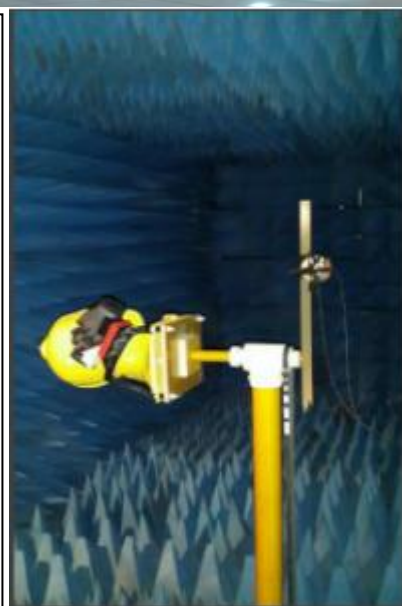
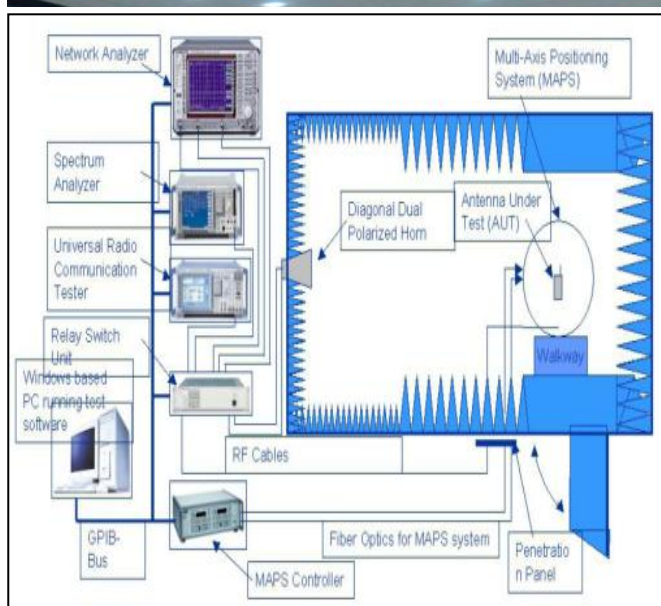

3座远场3D全电波微波暗室实验室系统，1座MVG SG24LT (Satmio) 近场3D微波暗室实验室系统（与国家相关实验室同步）



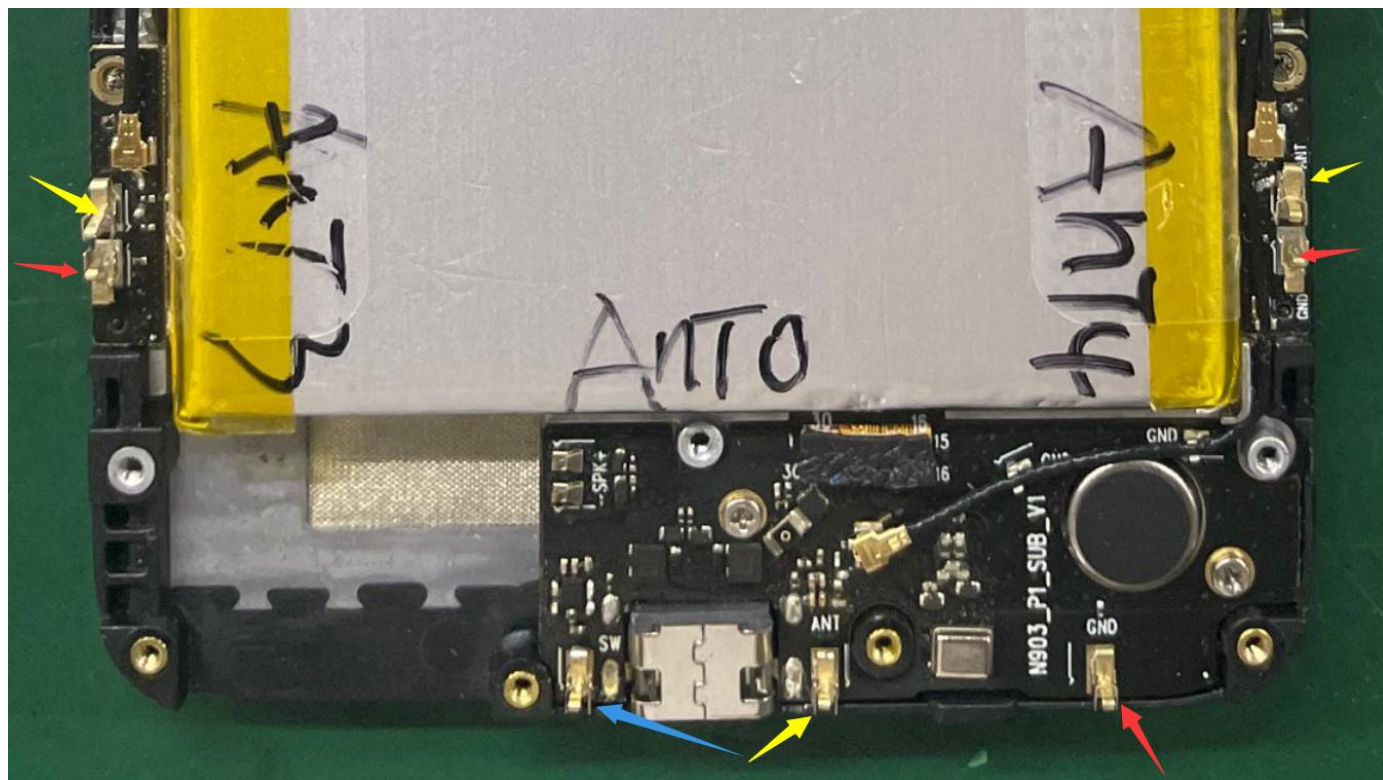
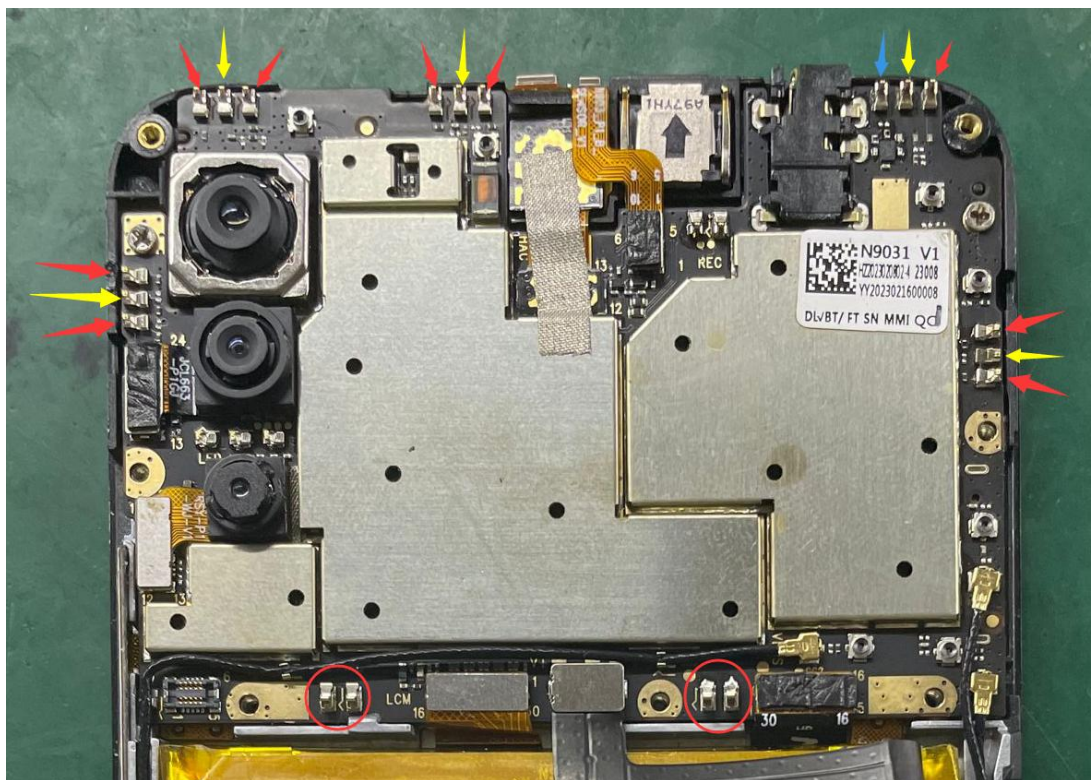



ANT0

位号	匹配值
C114	1.0pF
C113	6.8nH
R111	2.7nH
R110/R112/R121/R127	0Ω
R122	18nH
R124	5.1nH
R123	18nH
R126	NC

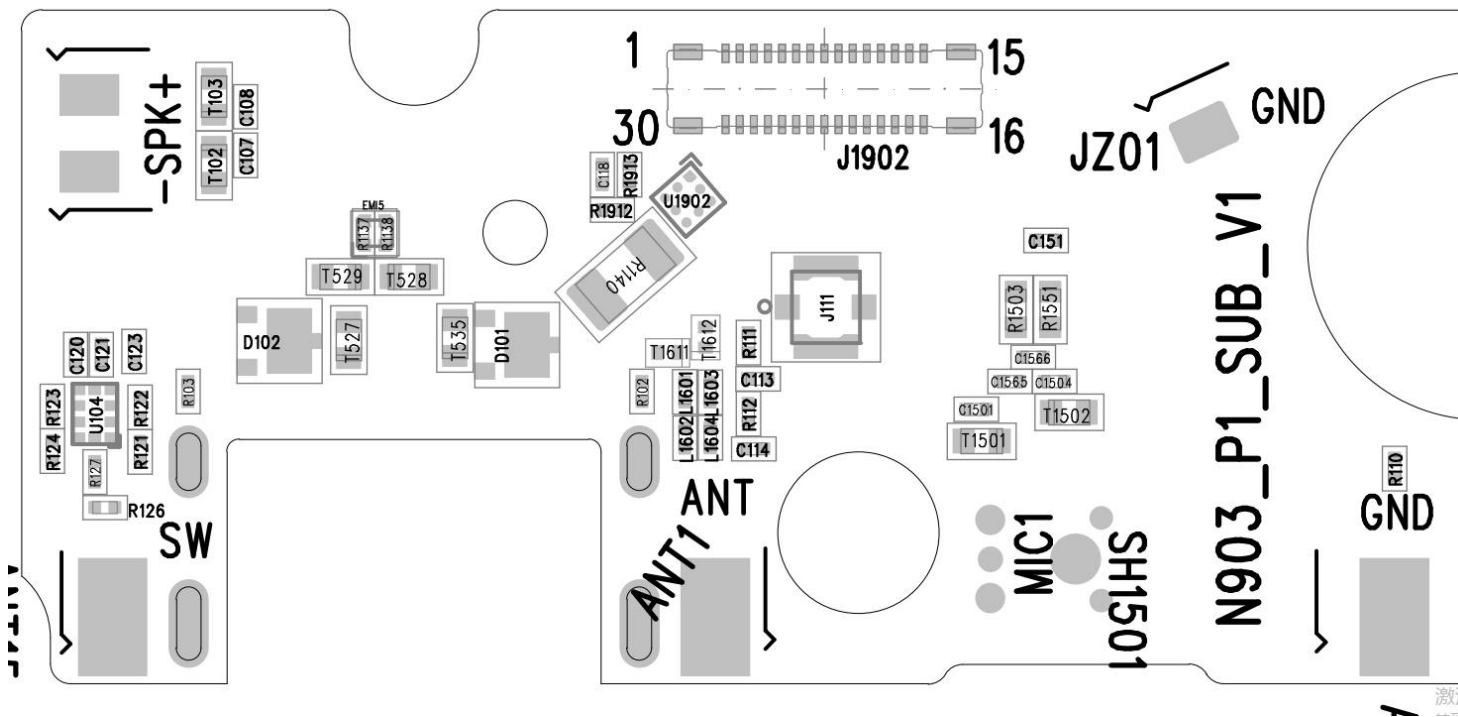



位号	匹配值
C7300	原匹配
L7291/C7150	NC
L7289	9.1nH
R7500/R7501/L7290/C7900	0Ω
R7502	18nH
R7504	5.1nH
R7503	18nH

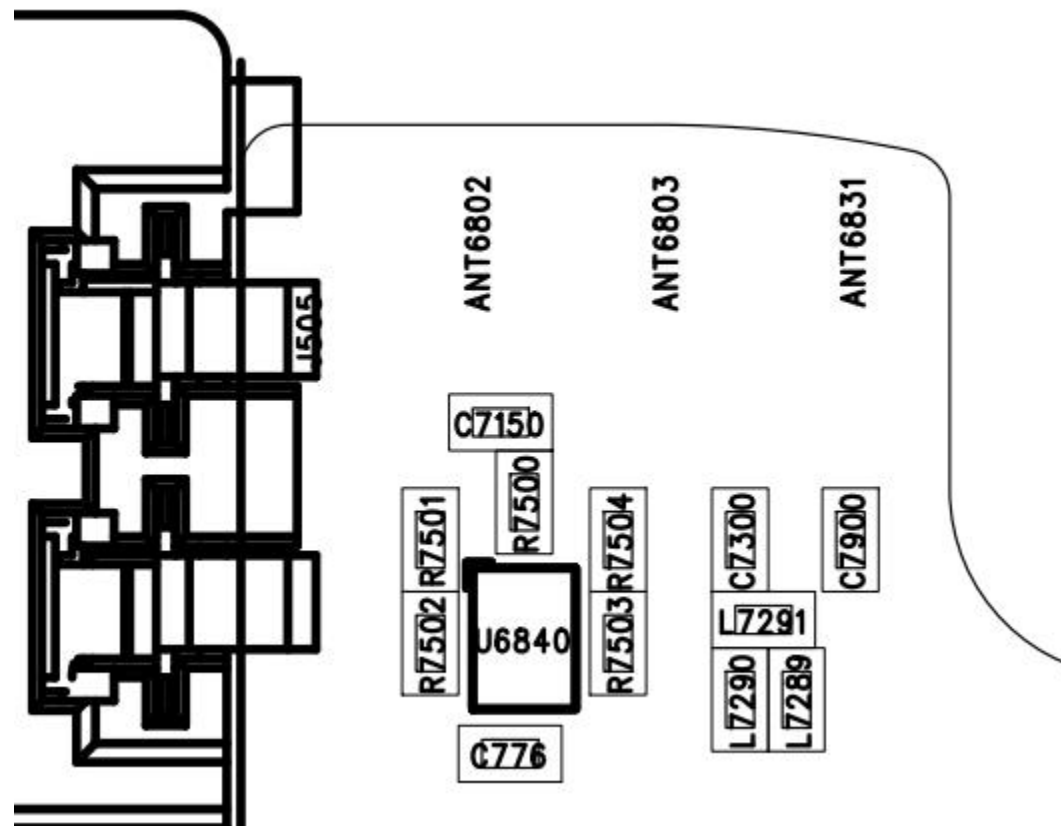

RF开关通路	匹配	控制频段
RF1 (R121)	0欧姆	GSM:900/1800/1900 WCDMA:B2/4 LTE:B2/4/30/66 NR:N41
RF2 (R122)	18nH	LTE:B12/17
RF3 (R124)	5.1nH	GSM:850 BC0 WCDMA:B5 LTE : B5 NR:N5
RF4 (R123)	18nH	LTE:B71 NR: N71

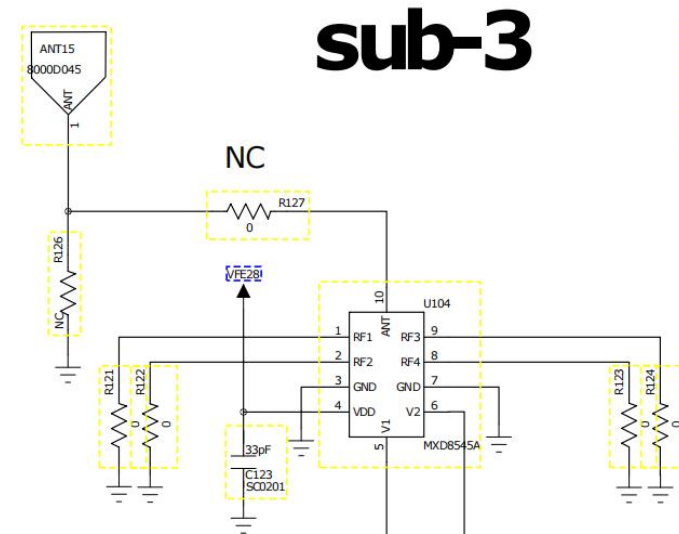
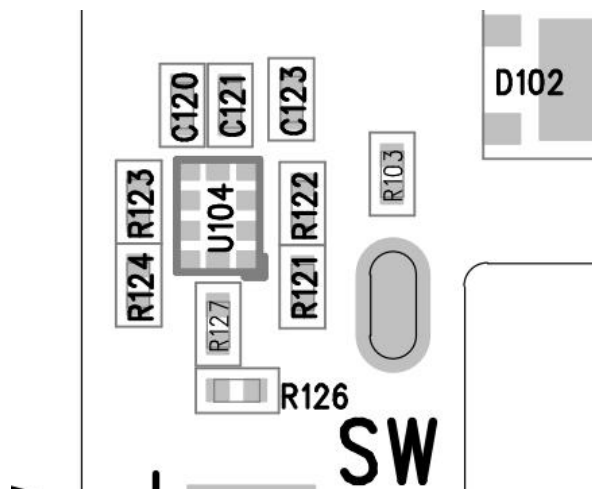

RF开关通路	匹配	控制频段
RF1 (R7501)	0欧姆	GSM:900/1800/1900 WCDMA:B2/4 LTE:B2/4/30/66 NR:N41
RF2 (R7502)	18nH	LTE:B12/17
RF3 (R7504)	5.1nH	GSM:850 BC0 WCDMA:B5 LTE : B5 NR:N5
RF4 (R7503)	18nH	LTE:B71 NR: N71

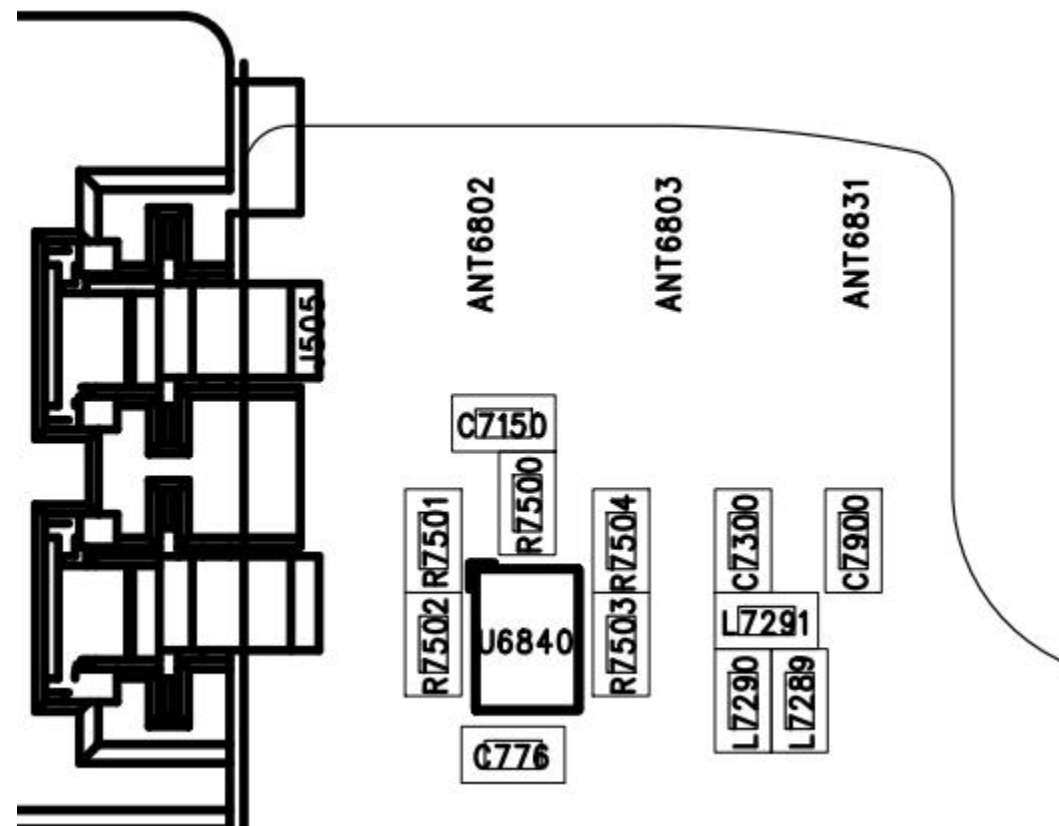



WIFI 2.4G & BT		
Frequency	Efficiency	Gain . dB
2400000000	34.95%	2.043975173
2410000000	35.01%	2.257372696
2420000000	34.84%	2.23302284
2430000000	35.78%	2.102894401
2440000000	35.80%	1.793614268
2450000000	36.09%	1.929650744
2460000000	36.59%	1.700964431
2470000000	36.86%	1.135437588
2480000000	36.39%	0.670971248
2490000000	36.42%	0.552660158
2500000000	37.54%	0.729623465

Azimuth 0°

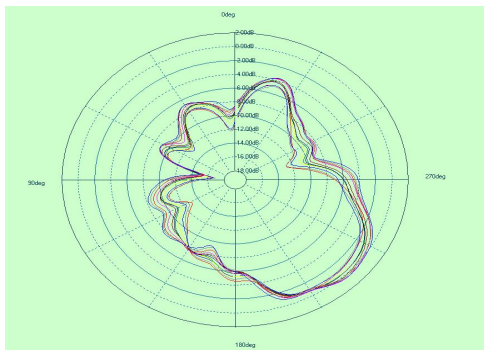

Azimuth 90°

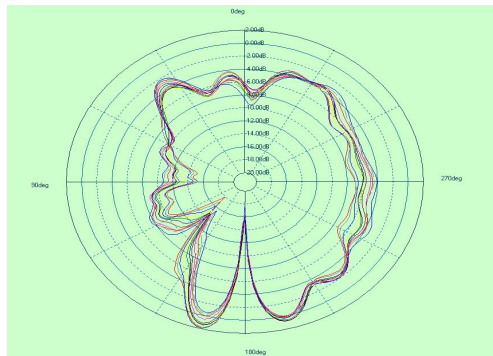

H-Plane (Elevation 90°)

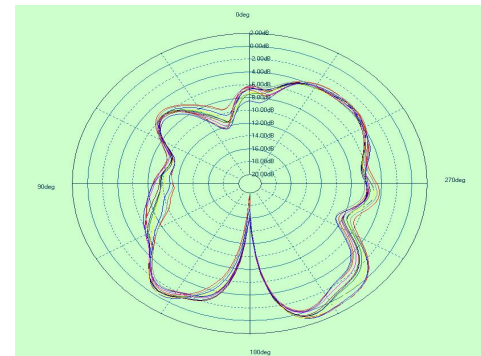

3D view Frequency  
2450MHz

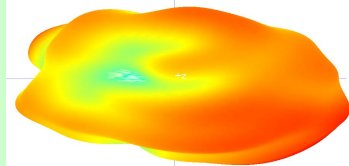

无源报告 测量仪器: Agilent Technologies E5071B 300kHz-8.5GHz ENA Series Network Analyzer 暗室系统: MVG SG24LT (Satmio)

WIFI 5.8G

Frequency	Efficiency	Gain . dB
5200000000	31.75%	3.648863419
5230000000	28.82%	3.638832221
5260000000	29.69%	4.020822769
5290000000	30.41%	3.741754436
5320000000	28.32%	3.152520518
5350000000	26.66%	2.612760759
5380000000	27.57%	2.303713842
5410000000	31.43%	3.078250828
5440000000	36.16%	3.995589818
5470000000	35.15%	4.003581412
5500000000	37.26%	4.143868646
5530000000	39.28%	4.667514407
5560000000	38.10%	4.523487773
5590000000	33.67%	3.94397269
5620000000	31.07%	3.848357347
5650000000	29.57%	3.603095448
5680000000	29.48%	3.151019505
5710000000	28.29%	2.994373767
5740000000	29.45%	3.135990755
5770000000	32.52%	3.232664567
5800000000	31.44%	2.937241718

Azimuth 0°

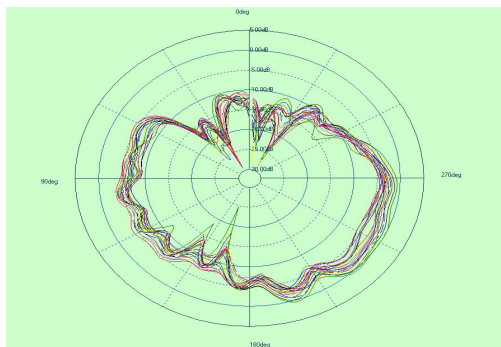

Azimuth 90°

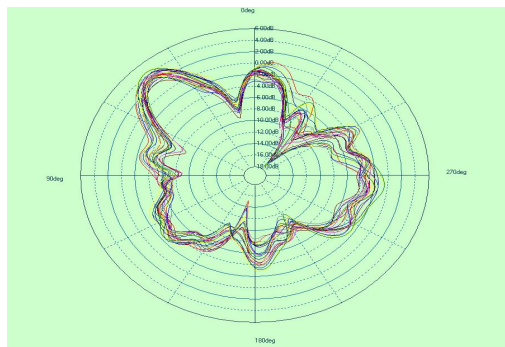

H-Plane (Elevation 90° )

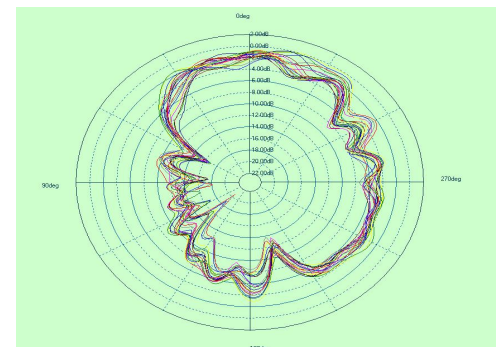

3D view Frequency  
5500MHz

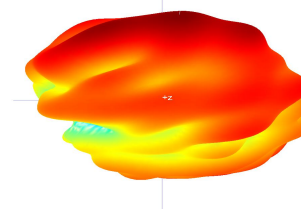

无源报告 测量仪器: Agilent Technologies E5071B 300kHz-8.5GHz ENA Series Network Analyzer 暗室系统: MVG SG24LT (Satmio)

GPS		
Frequency	Efficiency	Gain . dB
1570000000	37%	0.189429322
1571000000	37%	0.180822403
1572000000	37%	0.112399886
1573000000	37%	-0.012709776
1574000000	36%	-0.119282869
1575000000	36%	-0.167184585
1576000000	36%	-0.131928106
1577000000	37%	-0.046984858
1578000000	37%	0.055082552
1579000000	37%	0.084686039
1580000000	37%	0.070163101

Azimuth 0°

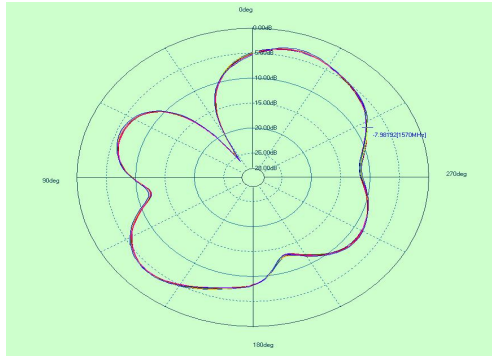

Azimuth 90°

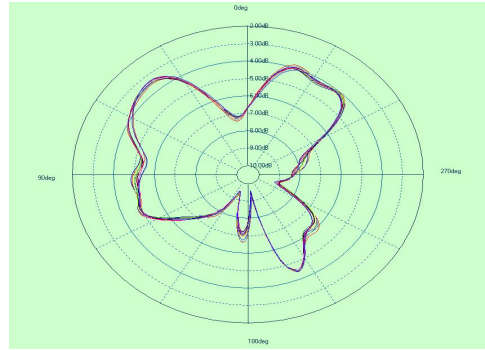

H-Plane (Elevation 90° )

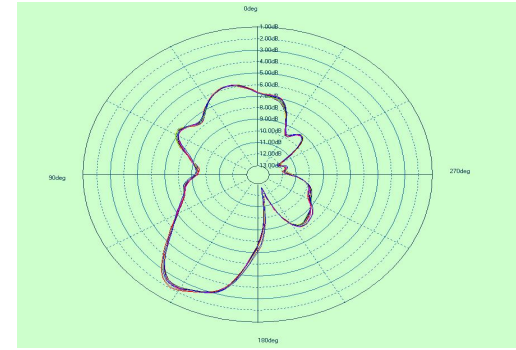

3D view Frequency  
1575MHz

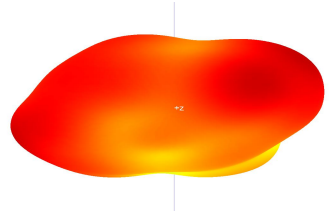

无源报告 测量仪器: Agilent Technologies E5071B 300kHz-8.5GHz ENA Series Network Analyzer 暗室系统: MVG SG24LT (Satmio)

700-960MHz		
Frequency	Efficiency	Gain . dB
700000000	14.68%	-2.506812792
800000000	14.38%	-2.591025496
820000000	15.61%	-1.883060703
880000000	18.53%	-2.409810833
888000000	19.76%	-1.599351153
896000000	20.97%	-0.948340281
904000000	21.43%	-1.724331808
912000000	21.19%	-1.346434496
920000000	21.62%	-0.882695804
928000000	22.30%	-1.033760318
936000000	21.87%	-1.37423822
944000000	20.74%	-1.994837263
952000000	20.20%	-2.092949472
960000000	19.46%	-1.723853447

**Azimuth 0°**

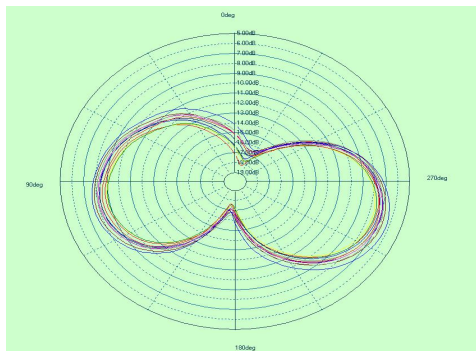

**Azimuth 90°**

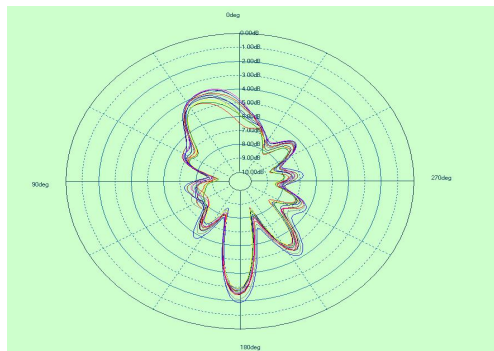

**H-Plane (Elevation 90° )**

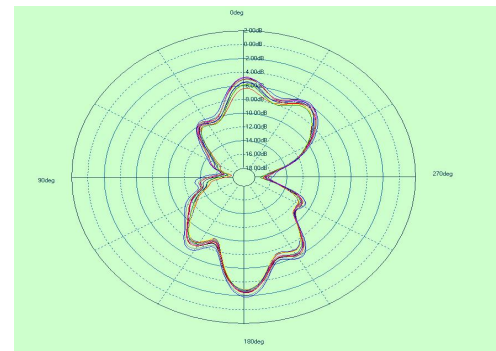

**3D view Frequency  
900MHz**

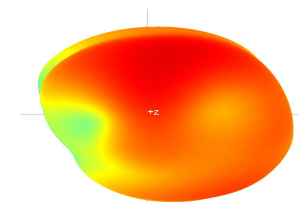

无源报告 测量仪器: Agilent Technologies E5071B 300kHz-8.5GHz ENA Series Network Analyzer 暗室系统: MVG SG24LT (Satmio)





3300-4200MHz		
Frequency	Efficiency	Gain . dB
3300000000	18.89%	-2.048674801
3345000000	24.86%	-0.475895641
3390000000	32.22%	0.8166508
3435000000	35.90%	0.829489895
3480000000	34.46%	-0.590567914
3525000000	29.61%	-0.735782592
3570000000	24.82%	-1.402672164
3615000000	23.99%	-1.444187343
3660000000	29.34%	-0.488278913
3705000000	37.21%	0.805818897
3750000000	39.03%	0.777607078
3795000000	35.70%	0.687180919
3840000000	31.77%	-0.304370274
3885000000	27.19%	0.078795231
3930000000	27.60%	0.764902858
3975000000	32.56%	1.443771676
4020000000	36.07%	1.302405332
4065000000	30.55%	-0.61752775
4110000000	24.04%	-1.503724389
4155000000	20.33%	-1.582146927
4200000000	17.67%	-1.706242368

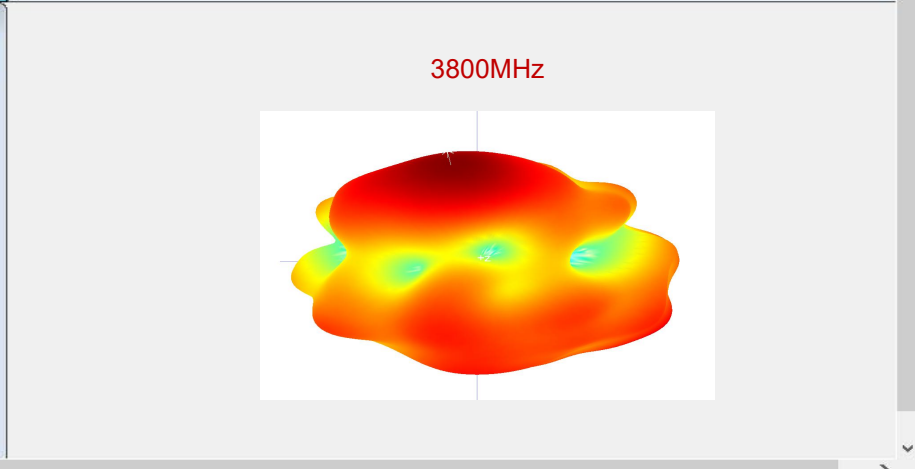
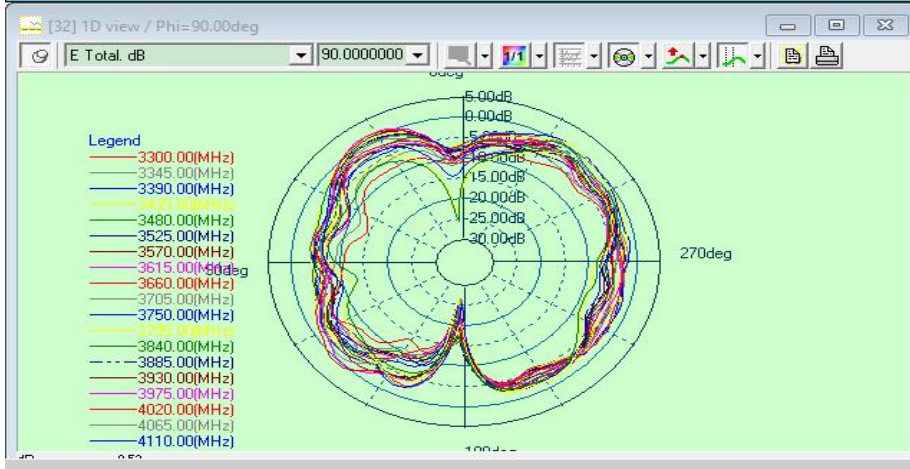
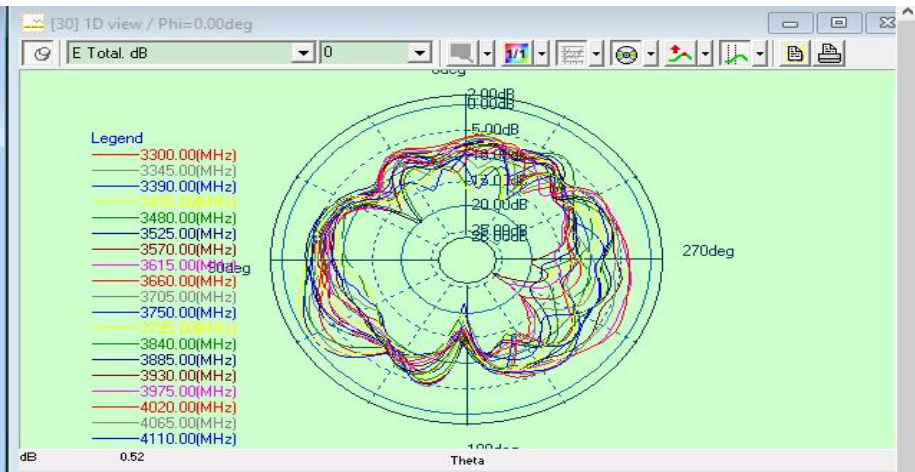
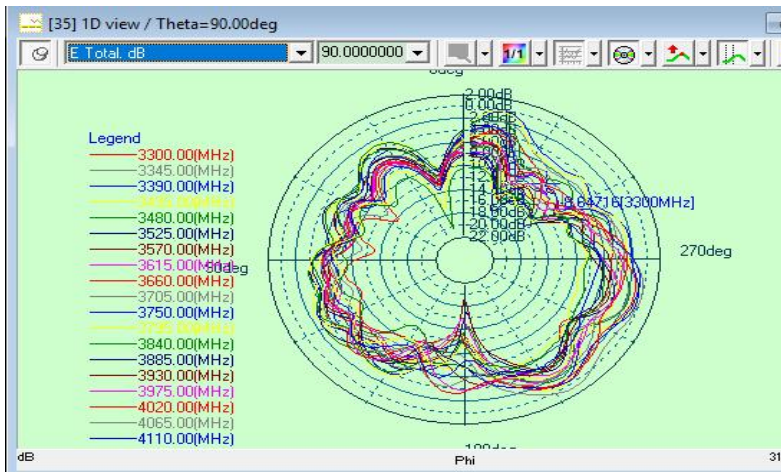

无源报告 测量仪器: Agilent Technologies E5071B 300kHz-8.5GHz ENA Series Network Analyzer 暗室系统: MVG SG24LT (Satmio)

WIFI距路由器12M信号强度

BT实测

正面无障碍距离：8米

隔人体距离5米

通话3分钟无杂音流畅。



## GPS实测:

白天在公司楼下实测两分钟内定位，最大星值44.2。

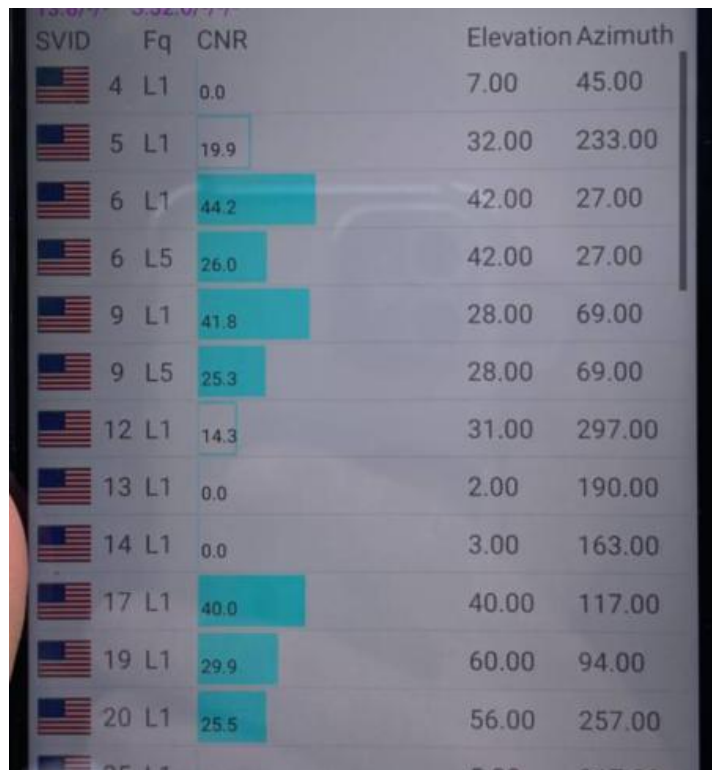
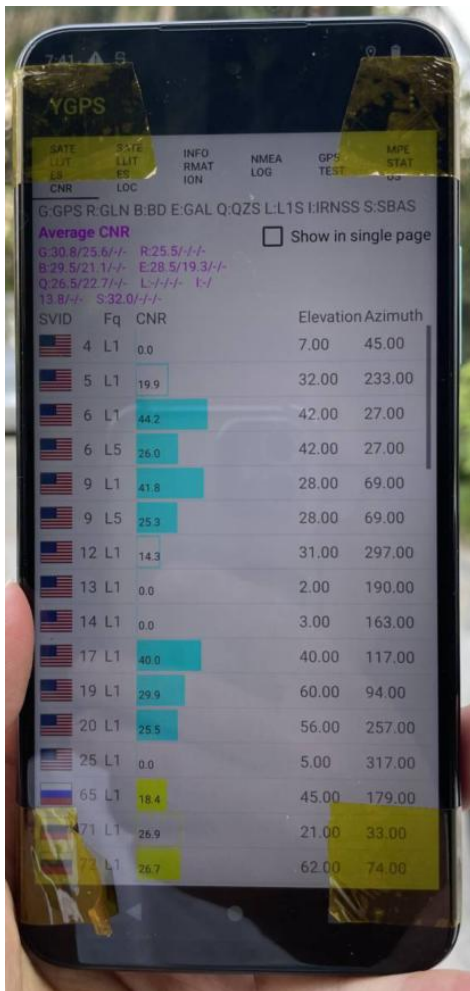



# 本体参数

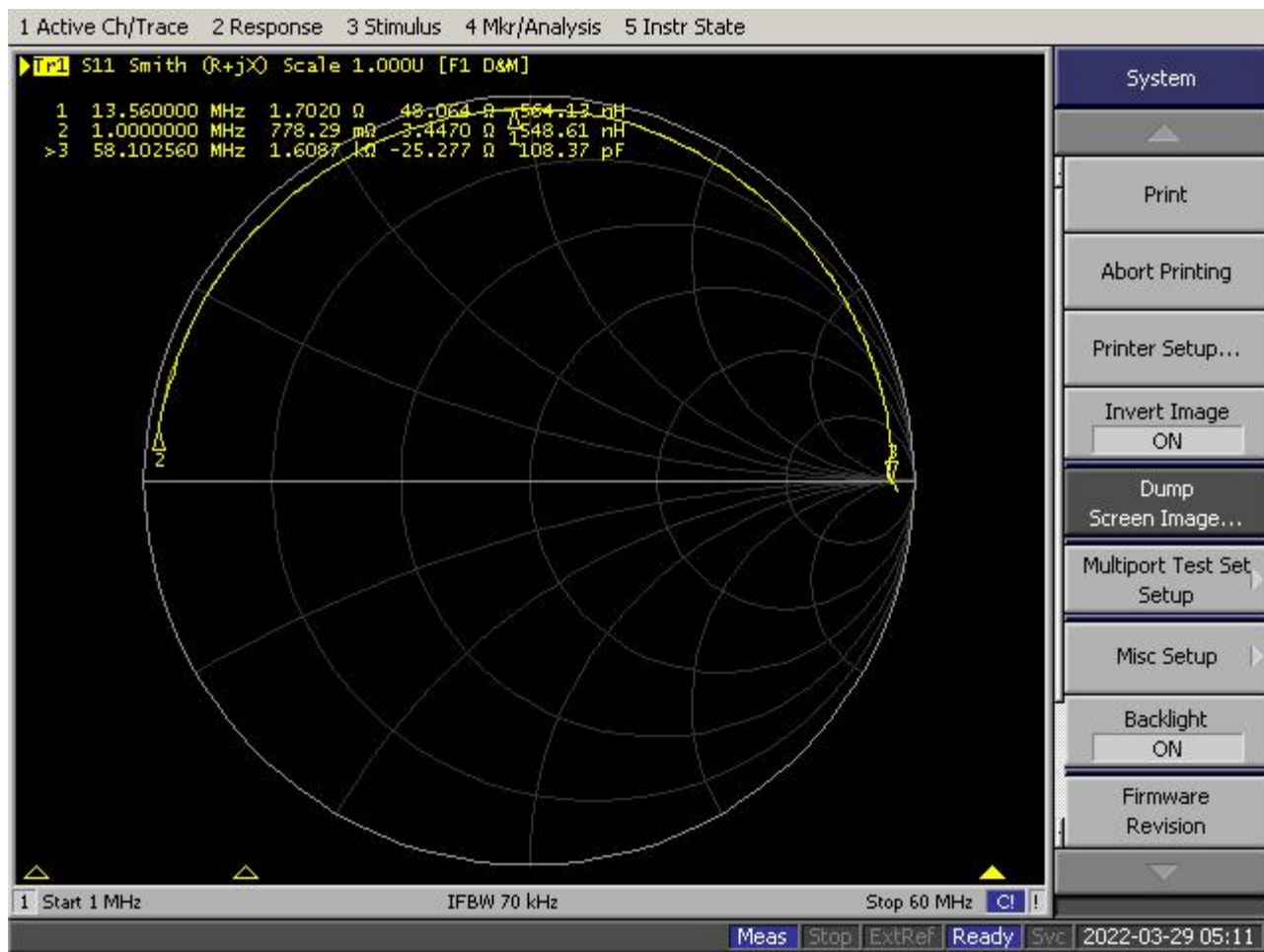

R@13.56MHz (Ω)	1.70
Lant@1MHz (μH)	0.54
Frequency (MHz)	58.1
Q	17

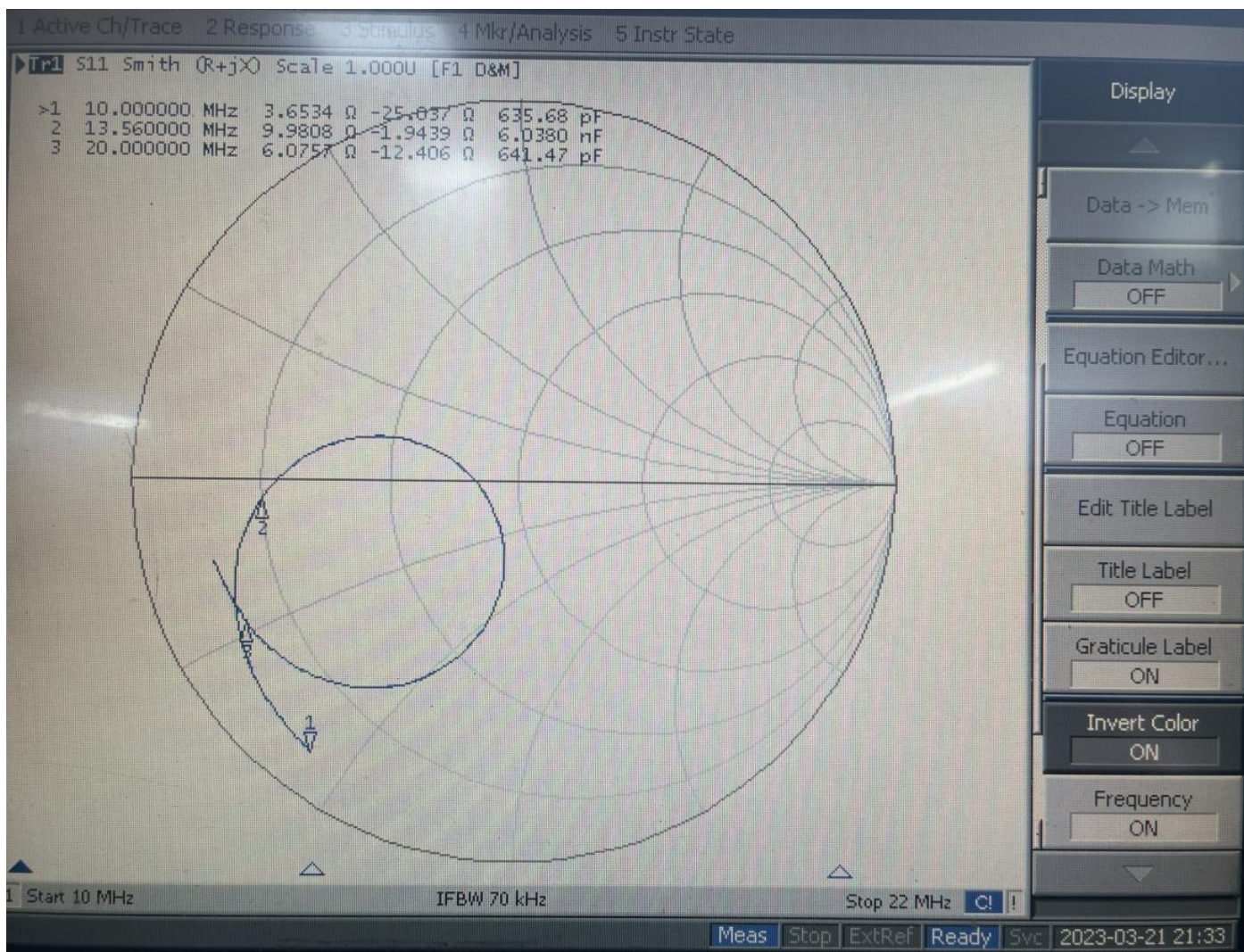



# 本体参数

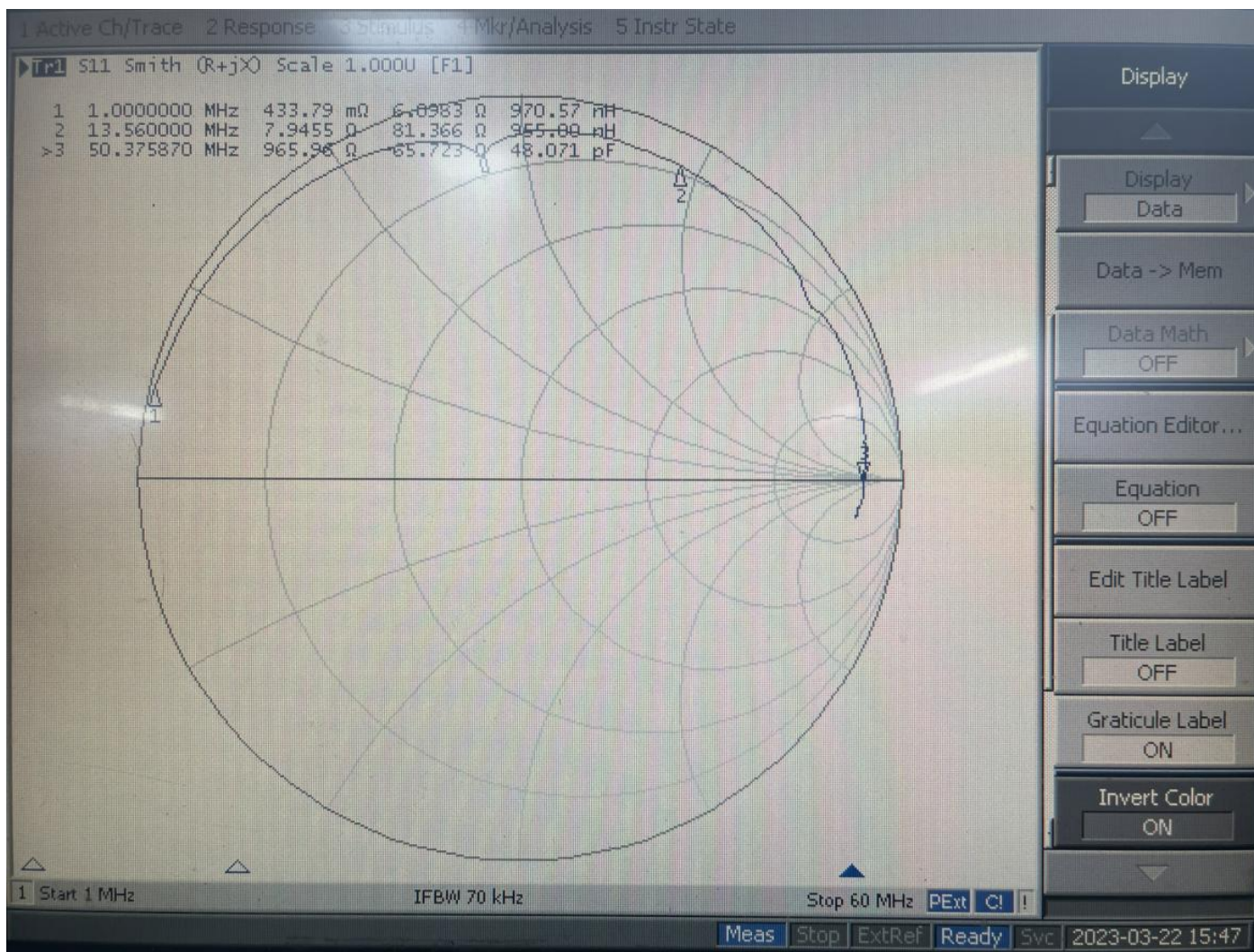

Rs@1MHz (Ω)	0.43
Lant@1MHz (uH)	0.97
Frequency (MHz)	50.37
Rp (KΩ)	0.96



<b>Ls(uH)</b>	8.7
<b>Rs(mΩ)</b>	398
<b>线圈数</b>	13



如图：1.贴导电布、导电海绵使屏与金属框并接地,屏正面不贴导电布。  
2.贴导电海绵使主板接地。

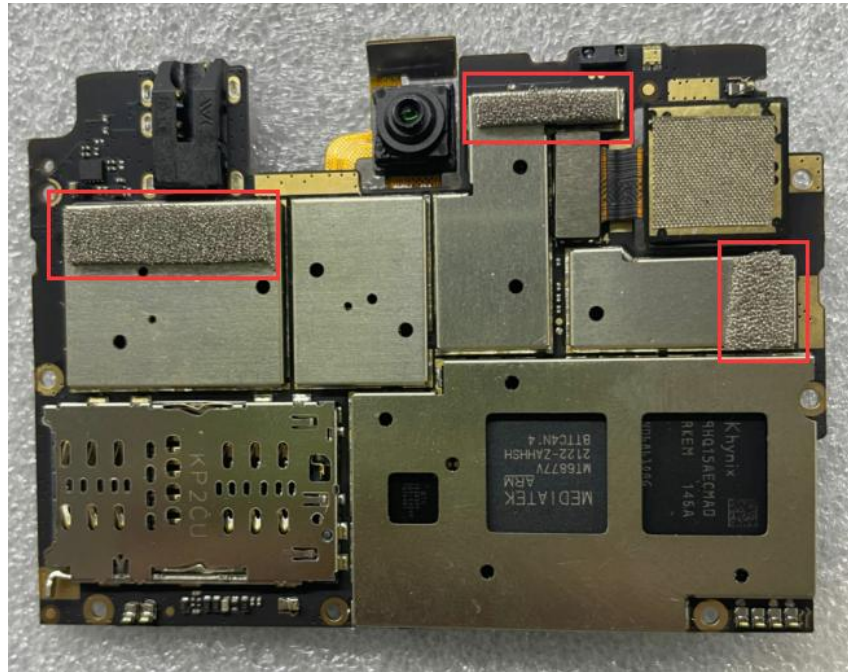

如图：

1. 电池左右两侧小板背面露铜区贴双面导电胶使小板充分接地，导电布不能盖住小板净空区。
2. 喇叭贴导电布接地、马达贴导电双面胶接地。
3. ANT0天线小板背面弹片和两处螺丝位接地。

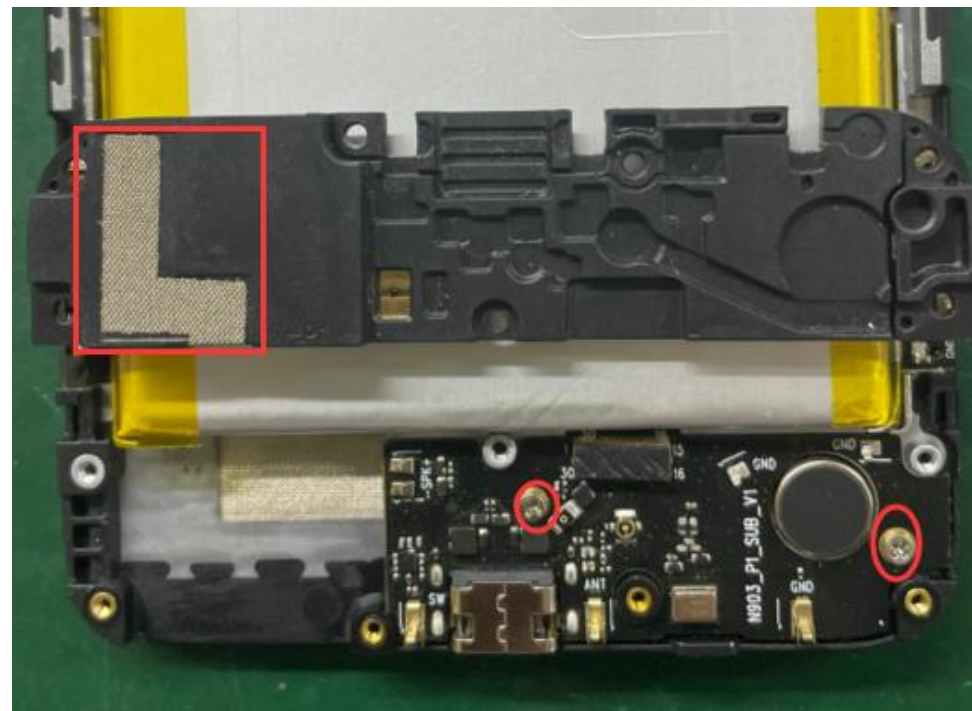
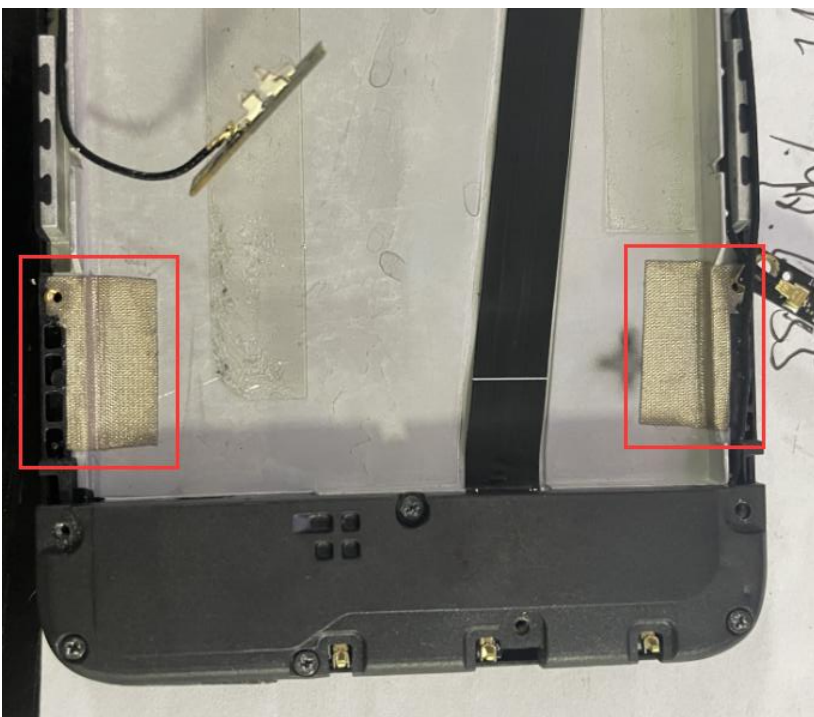

如图：所有摄像头需接地。前摄贴导电布接地，后摄贴双面导电胶接地。

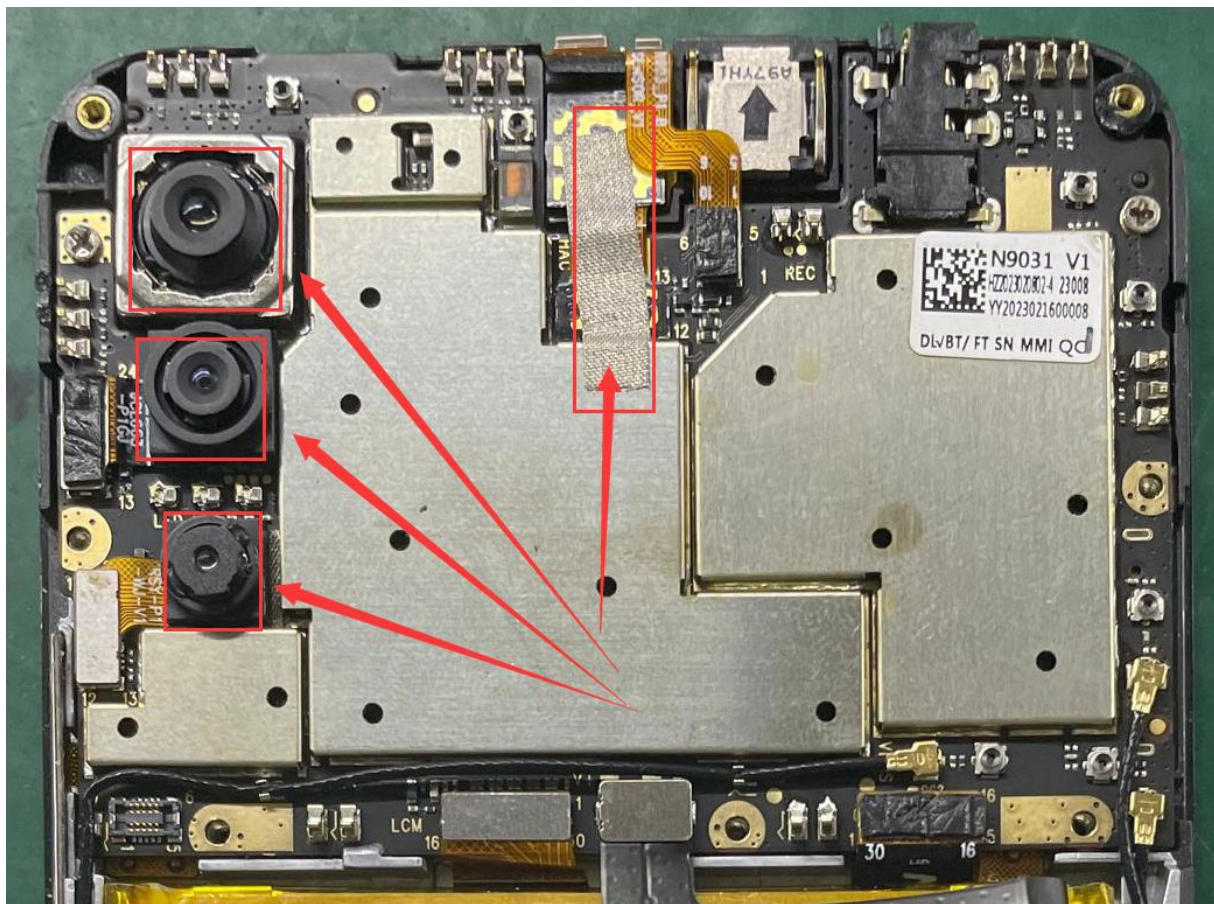





- 1.以上是暗室有源天线3D测试报告。
- 2.如有疑问，请电话联系。





01

报告中天线匹配电路是否改动，天线有关的环境处理是否增加，将直接影响天线性能，请仔细确认查看。

02

贵司如有最新试产或更新产品（如软件，ESD，物料等）请尽快提供我司进行验证，以确认天线性能是否有变化影响。

03

倘若贵司需要送第三方检测机构复测或客户测试，请务必先与我司进行天线相关测试确认，因主板·装配的一致性，以及天线组装的差异等因素，均可能导致天线参数的偏差。

# 谢谢

---

THANK YOU

如有疑问 请联系我们

日常服务时间：周一至周六 9:00-18:00

总机热线：0755-36615535 销售热线：0755-36615535 传真：0755-82916227

 网址：[www.mayaant.com](http://www.mayaant.com)